
Princeton Plasma Physics Laboratory

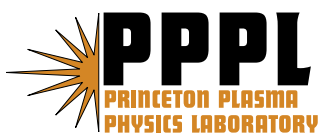
PPPL-4140

PPPL-4140

Negative Halogen Ions for Fusion Applications

L.R. Grisham, J.W. Kwan, S.K. Hahto,
S.T. Hahto, K.N. Leung, and G. Westenskow

January 2006



Prepared for the U.S. Department of Energy under Contract DE-AC02-76CH03073.

Princeton Plasma Physics Laboratory

Report Disclaimers

Full Legal Disclaimer

This report was prepared as an account of work sponsored by an agency of the United States Government. Neither the United States Government nor any agency thereof, nor any of their employees, nor any of their contractors, subcontractors or their employees, makes any warranty, express or implied, or assumes any legal liability or responsibility for the accuracy, completeness, or any third party's use or the results of such use of any information, apparatus, product, or process disclosed, or represents that its use would not infringe privately owned rights. Reference herein to any specific commercial product, process, or service by trade name, trademark, manufacturer, or otherwise, does not necessarily constitute or imply its endorsement, recommendation, or favoring by the United States Government or any agency thereof or its contractors or subcontractors. The views and opinions of authors expressed herein do not necessarily state or reflect those of the United States Government or any agency thereof.

Trademark Disclaimer

Reference herein to any specific commercial product, process, or service by trade name, trademark, manufacturer, or otherwise, does not necessarily constitute or imply its endorsement, recommendation, or favoring by the United States Government or any agency thereof or its contractors or subcontractors.

PPPL Report Availability

Princeton Plasma Physics Laboratory

This report is posted on the U.S. Department of Energy's Princeton Plasma Physics Laboratory Publications and Reports web site in Fiscal Year 2006.

The home page for PPPL Reports and Publications is:

http://www.pppl.gov/pub_report/

Office of Scientific and Technical Information (OSTI):

Available electronically at: <http://www.osti.gov/bridge>.

Available for a processing fee to U.S. Department of Energy and its contractors, in paper from:

U.S. Department of Energy
Office of Scientific and Technical Information
P.O. Box 62
Oak Ridge, TN 37831-0062

Telephone: (865) 576-8401

Fax: (865) 576-5728

E-mail: reports@adonis.osti.gov

Negative Halogen Ions for Fusion Applications

Abstract

L. R. Grisham¹, J. W. Kwan², S. K. Hahto², S. T. Hahto², K. NLeung², G. Westenskow³

1 Princeton Univ. Plasma Phys. Lab, P. O. Box 451, Princeton, N. J. 08543

2 Lawrence Berkeley Nat. Lab., 1 Cyclotron Road, Berkeley, CA 94720

3 Lawrence Livermore Nat. Lab, P. O. Box 808, Livermore, CA 94551

Abstract

Over the past quarter century, advances in hydrogen negative ion sources have extended the usable range of hydrogen isotope neutral beams to energies suitable for large magnetically confined fusion devices. Recently, drawing upon this experience, negative halogen ions have been proposed as an alternative to positive ions for heavy ion fusion drivers in inertial confinement fusion, because electron accumulation would be prevented in negative ion beams, and if desired, the beams could be photodetached to neutrals. This paper reports the results of an experiment comparing the current density and beam emittance of Cl^+ and Cl^- extracted from substantially ion-ion plasmas with that of Ar^+ extracted from an ordinary electron-ion plasma, all using the same source, extractor, and emittance scanner. At similar discharge conditions, the Cl^- current was typically 85 – 90% of the positive chlorine current, with an e^-/Cl^- ratio as low as 7 without grid magnets. The Cl^- was as much as 76% of the Ar^+ current from a discharge with the same RF drive. The minimum normalized beam emittance and inferred ion temperatures of Cl^+ , Cl^- , and Ar^+ were all similar, so the current density and optical quality of Cl^- appear as suitable for heavy ion fusion driver applications as a positive noble gas ion of similar mass. Since F, I, and Br should all behave similarly in an ion source, they should also be suitable as driver beams.

I. Introduction

Energetic beams of atoms of hydrogen isotopes have been used for decades to heat and drive current in magnetically confined plasmas for fusion energy research. For many years these atomic beams were formed by electrostatically accelerating positive ions, and then converting them to neutrals through charge exchange in a gas cell. However, the neutralization efficiency of positive hydrogen isotopes declines rapidly at energies beyond 40 keV/amu, whereas the neutralization efficiency for negative hydrogen is nearly constant out to energies of many MeV. As a result, the two most recently deployed neutral beam systems used negative hydrogen isotope beams. The JT-60U D⁻/H⁻ neutral beam system¹ in Naka, Japan began operation in 1996, and the LHD H⁻ system² in Toki, Japan started operation later the same decade.

The ion sources developed for both these beam systems were cesiated tandem sources, also known as cesiated volume sources^{3,4}. In such sources negative ions are

formed through at least two processes. One process is dissociative attachment of vibrationally excited molecules by low energy electrons⁵. In order to facilitate this process, the ion source is partitioned into two (tandem) regions by a magnetic filter field, which serves to inhibit the flow of high energy primary electrons from the driver plasma (where the cathode filaments are located) into the extractor plane plasma, from which the negative ion beam is extracted. The energetic electrons excite molecules to high vibrational states in the driver plasma. Some of these vibrationally excited molecules drift into the extractor plasma, where low energy electrons dissociatively attach to form negative ions. Because this process does not involve surface contact, it is often called "volume production." Adding cesium vapor to the discharge results in cesium depositing on surfaces, where it lowers the electron work function, making it much easier to form negative ions through reflection or desorption mechanisms, generally called "surface production." In the sources used for magnetic fusion energy applications, the most important surface production occurs at the plasma grid which forms the boundary between the extractor plane plasma and the extractor/accelerator grid series. The fact that the filter field at least partially shields the extractor plane plasma from high energy electrons enhances the survival of the negative ions formed there, since their destruction cross section rises at higher electron energies. In the hydrogen ion sources used for magnetic fusion energy experiments, most (usually 75 -80%) of the extracted negative ions result from the addition of cesium, and thus are thought to arise as a result of surface production. The accelerated current densities of negative hydrogen isotopes which are successfully produced and accelerated in these systems is typically a factor of 10 – 20 lower than the case for positive hydrogen isotope sources used in similar magnetic fusion energy applications. This reflects the relatively low electron affinity of hydrogen (0.75 eV), which makes negative hydrogen harder to form, and easier to destroy in the accelerator, than its positive counterpart.

In addition to magnetic confinement, the other major approach to fusion energy is inertial confinement, in which a brief intense burst of energy is transferred via a driver to a target capsule, compressing it to thermonuclear ignition. A leading potential driver for inertial confinement fusion is an array of heavy ion beams at tens to hundreds of MeV/amu⁶. For the most part, the beams that have been considered as candidate heavy ion drivers were positive ions, because it is easier to form positive ions than negative ions of most elements, a fact which had been made clear by the effort required to develop negative hydrogen beams for magnetic fusion energy.

A few years ago, negative ion beams made from halogens were proposed as potential drivers for heavy ion fusion^{7,8}. Halogens have electron affinities ranging from four to nearly five times that of hydrogen. Thus they form negative ions much more readily, and the ions are more robust against low energy stripping losses in the extractor and pre-accelerator than is the case for hydrogen. The principal advantages of negative ions as driver beams are that they will not collect electrons in the deep potential wells that will accompany the intense compressed bursts needed for drivers, and they could also be readily converted to neutrals by laser photodetachment to reduce the average space charge and expansion of the beam as it traverses the target chamber. Although the beam will be ionized in transit, the average beam self-perveance will be lower if it starts out

neutral, and space charge expansion far from the target, where the lever arm is larger, has a greater effect than space charge near the target⁹. High energy negative halogens are subject to somewhat greater loss due to electron stripping in the main accelerator and compression region than are positive ions of similar atomic number, but since multi-electron loss events are important for both heavy positive and negative ions, the vacuum only needs to be a factor of 2 or so better for the negative ions to have the same loss rate as similar mass positive ions¹⁰.

Questions remained, however, about whether negative halogens could be produced with current densities and normalized emittances similar to those obtainable with similar mass positive ions, so an experimental program was started to produce and characterize negative halogen beams.

Because halogens form negative ions through the same process, dissociative attachment of electrons to vibrationally excited diatomic molecules (and perhaps also ground state molecules in the case of halogens), which is called volume production in the magnetic fusion energy ion sources, it was possible to easily adapt the technology developed for high current negative hydrogen beams to the production of negative halogens. While the high current negative hydrogen sources used to heat tokamaks and stellarators have all used cathode filaments to drive the arc, this could prove difficult with a halogen feedstock, so RF drive was used instead. The other change was that, since it was expected that dissociative attachment would be a prolific source of negative halogens, it would not be necessary to add cesium to promote surface production, which was a major simplification.

Since the halogens under consideration, F, Cl, Br, and I, all have large electron affinities (3.1 – 3.6 eV) and form negative ions through the same dissociative attachment process, proof-of-principle experiments with any one of them should also validate the others. Chlorine was chosen because, unlike Br and I, it is a gas at room temperature, and it is easier to handle than F.

An initial brief experiment was conducted with a small RF-driven tandem volume source (with an internal magnetic filter) which had previously been used to produce H⁻. It was successful in producing a Cl⁻ current density of as much as 45 mA/cm² with only a 0.5% contamination of Cl₂⁻, and found a linear increase of Cl⁻ with RF power. The maximum ratio of Cl⁻ current to positive ion current under the same discharge conditions was 0.79, and, with no electron suppression other than the filter field partitioning the plasma, an e⁻/Cl⁻ ratio as low as 7, indicating the existence of an ion-ion plasma with relatively few electrons in the extractor plane^{10,11}. Ion-ion bromine plasmas were investigated long ago by Bacal et al.¹², but without beam extraction.

II. Experimental arrangement

This paper reports a subsequent set of experiments to further investigate halogen beams, and to compare the relative currents and emittances of beams of Cl⁻ and Cl⁺ extracted from dominantly ion-ion plasmas with Ar⁺ beams extracted from ordinary

electron-ion plasmas, all using one source and one ion extractor geometry, and measured with one emittance scanner in one experimental configuration. This meant that the systematic errors should be the same for all three beams, so comparing the beams should be more meaningful than would be the case with different sources, optics, and measurement systems.

A new RF-driven source was constructed. Like the earlier source, this used magnetic cusp confinement, and included an internal pair of permanent magnets separated by 3.5 cm to partition the extractor plane plasma from the driver plasma with a 320 gauss-cm filter field. The arc chamber was aluminum, and the cusp field on the inside wall was about half what it had been in the earlier copper source. The extractor was a pair of plates with a gap of 1.0 cm and a circular aperture 0.125 cm in radius. A pair of permanent magnets 2.9 cm downstream of the ground plate deflected the co-extracted electrons with a 275 gauss-cm field. The beams could either run into a biased (+300 v collector, -300 v suppressor) Faraday cup 12.8 cm downstream for current measurements or into a dual slit emittance scanner (first slit 10.7 cm downstream, second slit 23 cm further downstream). The target chamber was pumped with a turbomolecular pump to maintain a target tank pressure of a few 10^{-5} torr range during experiments. Figure 1 shows a schematic of the source and extractor. The beam pulse length in these experiments was typically 20 – 50 microseconds.

III. Experimental results

A. Langmuir probe measurements

The driver plasma contained a Langmuir probe. Figure 2 shows positively biased probe measurements as a function of chlorine source pressure and RF drive voltage. At all pressures, there is a linear relationship between the RF drive power and the probe signal, as was also found to be the case with the beam current in the earlier experiment. The maximum RF drive which could be applied was limited by the supply. The values given for RF power are the approximate output of the supply, not the amount coupled into the plasma, which would be less by an unknown factor.

B. Faraday cup beam current

Figure 3 displays the Ar^+ current collected in a Faraday cup at various beam extraction voltages as a function of RF drive, and with a source pressure of about 2 mTorr. At each voltage, the beam current rises linearly with increasing RF power, as was the case with the probe signal in fig. 2, until the current rises past the perveance match point, after which the beam divergence increases, resulting in a declining signal from the Faraday cup as more of the beam passes around it. Since argon forms no or very few negative ions, the plasma from which this beam was extracted was a pure ion-electron plasma. The Faraday cup signal is linear with current density, and corresponds to about 15.5 mA/cm^2 of Ar^+ at 30 kV extraction and 15.4 kW RF.

Figure 4 shows the Faraday cup current of positive chlorine extracted from a chlorine discharge under similar conditions, and with nearly the same pressure (difficulties with the gas feed system made it difficult to perfectly match pressures) as the argon data. The overall behavior is similar to that with argon, although the current is somewhat lower for similar conditions. For instance, at 30 kV extraction voltage and an RF drive of 8.8 kW, the positive chlorine current in the Faraday cup was about 0.83 of the Ar^+ current. That they differ somewhat is not surprising. Although argon and chlorine are of quite similar atomic weight (40 amu for argon and a mix of 35 and 37 amu for chlorine), the Ar^+ beam consists entirely of atomic ions. The positive chlorine beam will contain some molecular ions, which will raise the average ion mass, reducing the space-charge-limited flow. In the earlier experiments^{10,11} a momentum analyzer found 82% of the positive chlorine beam to be atomic chlorine ions, with the rest being mostly Cl_2^+ , along with some impurity ions. The present experiments did not have momentum analysis, but it is reasonable to expect that a somewhat similar portion of the positive chlorine beam would be molecular ions. Moreover, since the extractor plane chlorine plasma contains a large component of negative ions, and therefore fewer electrons, the dynamics of beam extraction might be somewhat different than those of extracting positive ions from an ion-electron plasma. Given these considerations, the positive chlorine currents seem quite similar to the Ar^+ currents. The Faraday cup signal corresponds to about 13.9 mA/cm^2 of positive chlorine ions at 30 kV extraction and 15.4 kW RF.

Figure 5 plots the Faraday cup current of the Cl^- beam at various extraction voltages as a function of RF drive at the same pressure as used for the positive chlorine figure. The general behavior is roughly the same as for the positive chlorine beam and Ar^+ . It is apparent that the Cl^- currents are only modestly smaller than the positive chlorine currents for similar extraction and RF drive voltages. For instance, with 30 kV extraction voltage, the Cl^- current is about 80% of the positive ion current at an RF drive of 6.6 kW, and is about 90% over most of the rest of the range, dropping back to about 85% at a drive of 15.4 kW. The near equivalence of the positive and negative ion currents strongly suggests that the extractor plane plasma is an ion-ion plasma with a reduced density of electrons. The ratio of positive to negative ions in the extractor plane plasma would, of course, be somewhat different from the measured beam current ratio, since the average mass of the positive ions, which have a significant molecular ion component, is heavier than that of the nearly purely atomic Cl^- . The attenuation of the beams due to charge exchange or stripping losses will also differ, and the dynamics of extraction across a sheath in an ion-ion reduced electron plasma may well differ from the case of positive ions extracted from an ion-electron plasma. The Faraday cup signal corresponds to 11.8 mA/cm^2 of Cl^- at 30 kV extraction and 15.4 kW RF.

C. Co-extracted electrons

If the extractor plane plasma is an ion-ion reduced-electron plasma, then it is reasonable to expect that the e^-/Cl^- ratio might be less than what would be expected from their relative mobilities, which, for equal temperatures and no magnetic impedance, should be the square root of their mass ratio, or about 240. Figure 6 shows the e^-/Cl^- ratio measured by moving the Faraday cup to the location of the deflected electron beam, with

20 kV extraction voltage and a source pressure of 3.4 mTorr. At low RF drive power, where the Cl^- is lower, the e^-/Cl^- ratio is as high as 15, but drops to about 7 for RF drives of 11 kW and higher. This is roughly the same as the lowest e^-/Cl^- ratio observed in the earlier experiment^{10,11}. That this ratio is so much less than the square root of the mass ratios, 240, is, like the near-equivalence of negative and positive ion currents, strongly suggestive that the extraction is taking place from an ion-ion reduced-electron plasma. However, the electron population in the extractor-plane plasma is probably not as low as would be implied by comparing the measured ratio, 7, to 240. While this source does not have any electron suppression magnets incorporated into the grids, as is common with H^- fusion sources, it does have the filter magnetic field, which declines across the extractor plane plasma from a strength of 179 gauss at the filter to 68 gauss 1.05 cm away at the plasma grid, and this undoubtedly reduces electron mobility much more than it affects the ions.

D. Emittance measurements

Figure 7 shows a typical emittance diagram of Cl^- taken with the double slit emittance scanner. For all three types of beams examined, using a cutoff of 70% (that is stopping the plot when the beam intensity had fallen by 70% from the peak) gave the most well-behaved comparison of emittance values, and is characteristic of the beam core. Extending the plot to the 90 % level resulted in sometimes erratic comparisons due to noise, so the following figures all use the 70% cutoff.

Figure 8 shows the Ar^+ normalized emittance (4 times the rms emittance times v/c) versus beam perveance for several source gas pressures. The normalized emittance does not appear to be pressure-dependent within this range, but does increase with perveance. The increase with perveance is most likely an indication that the optics of the extraction gap are dominating over the ion temperature, at least at the higher perveance values.

Figure 9 gives the Cl^+ normalized emittance versus beam perveance for several gas pressures, and figure 10 does the same for Cl^- . Unlike the argon case, the normalized emittance of both Cl^+ and Cl^- do appear to be modestly sensitive to the gas pressure, with lower pressures mostly corresponding to higher emittances for a given perveance. This may be a reflection of differences in formation mechanisms for the different ions.

It is apparent that the lowest normalized emittance at a given perveance is about the same for all three ions; for instance, at .09 nanopervs, it is 0.0049 for Cl^+ and Cl^- , and .0055 for Ar^+ , which strongly suggests that, although part of the optimum emittance is probably due to optics, the effective beam temperatures of the three ion species are probably similar. Although an ion-ion plasma might be expected to have a lower ion temperature than an ion-electron plasma at similar discharge parameters, due to a reduced ambipolar potential^{13,14}, observing any such effect upon the beam emittance would require ion extraction optics which contribute much less to the emittance than does the ion temperature. This could be accomplished by measuring the emittance parallel to a long slot-extracted beam, if the ion density were uniform along the slot. If one asks what the ion temperature would be in the absence of any optical contribution at the minimum

normalized emittances measured for each species, and extending the emittance diagram to nearly 100% of the beam, then the ion temperatures would be about 0.34 eV for all three ions, with the Cl^+ and Cl^- slightly lower, but effectively the same within the measurement uncertainties, since the actual contribution of the optics to the emittance might be different for the argon and chlorine cases.

IV. Discussion

The absolute current densities in this experiment were lower than those in the earlier one^{10,11} because the plasma confinement was lower in this source (the magnetic cusp field strength at the source wall was about half that of the earlier source), and the RF power density was lower because this source was considerably larger. However, by using one source, beam extractor, and set of diagnostics to measure Ar^+ , Cl^+ , Cl^- , and e^- , the present experiment demonstrated that halogens can be used to produce negative and positive ion beams at current densities quite close to those which can be produced of similar mass noble gases under similar discharge conditions. For instance, with 15.4 kW RF and 30 kV extraction, at 1.5 mtorr the positive chlorine current is 89% and the Cl^- current is 76% of the Ar^+ current at 2 mtorr. The normalized emittance as a function of perveance is similar for Ar^+ , Cl^+ , Cl^- , and the effective beam ion temperature of the minimum normalized perveance beams is essentially the same, about a third of an eV, for all three beams. The relatively low amount of co-extracted electrons ($e^-/\text{Cl}^- = 7$ for the best conditions) without any electron suppression other than the internal filter field, is probably in part the result of an ion-ion reduced-electron plasma in the extraction plane, as is also suggested by the near-equivalence (80 – 95%) of the Cl^- and positive chlorine currents at similar source conditions. In a heavy ion driver beam injector, this level of electrons could either be eliminated after extraction, or eliminated during extraction by techniques developed for H⁻ beams in magnetic confinement fusion. Since the electrons move much faster than the Cl^- , their space charge contributes only a small amount to the extraction perveance (about 3% for the minimum electron ratio measured). Based upon these experiments, it appears that, if negative halogen beams are eventually chosen as heavy ion fusion drivers, then the current density obtainable with a given source and extractor should be nearly as high for the negative ion as for a positive noble ion of similar mass, and the emittance should be similar.

Acknowledgements

It is a pleasure to thank Dr. R. Davidson, Dr. I. Kagonovich, and Dr. B. G. Logan for helpful conversations. Work supported by USDOE contract AC02-CH03073.

References

- ¹M. Kuriyama *et al.*, *Fus. Eng. & Des.* **39-40**, 115(1998).
- ²Y. Takieri *et al.*, *J. Plas. & Fus. Res.* **74**, 1434 (1998).
- ³K. N. Leung, K. Ehlers, M. Bacal, *Rev. Sci. Inst.* **54**, 56 (1983).
- ⁴Y. Okumura *et al.*, *Rev. Sci. Inst.* **67**, 1018 (1996).
- ⁵M. Bacal, D. Skinner, *Com. on Atomic & Molec. Phys.* **23**, 283 (1990).

- ⁶D. Callahan, *Fus. Eng. Des.* **32-33**, 441 (1996).
- ⁷L. R. Grisham, *Nucl. Inst. & Meth in Phys Res. A* **464**, 315 (2001).
- ⁸L. R. Grisham, *Fus. Sci. & Tech* **43**, 191 (2003).
- ⁹W. M. Sharp *et al.*, *Nuc. Fus.* **44**, S221 (2004).
- ¹⁰L. R. Grisham, S. K. Hahto, S. T. Hahto, J. W. Kwan, K. N. Leung, *Nucl. Inst. & Meth. in Phys. Res A* **544**, 216 (2005).
- ¹¹S. K. Hahto, S. T. Hahto, J. W. Kwan, K. N. Leung, L. R. Grisham, *Rev. Sci. Inst.* **74**, 2987 (2003).
- ¹²M. Bacal, H. Doucet, *IEEE Trans. on Plas. Sci.* **PS-1**, 91 (1973).
- ¹³I. Kaganovich, *Phys. Plas.* **8**, 2540 (2001).
- ¹⁴I. Kaganovich, S. Bereznoi, C. Shin, *Phys. Plas.* **8**, 719 (2001).

Figure Captions

- FIG. 1 Schematic of the ion source in this experiment.
- FIG. 2 Response of Langmuir probe located in chlorine driver plasma.
- FIG. 3 Faraday cup signal of Ar^+ beam extracted at various voltages versus RF plasma drive, source pressure 2 mtorr.
- FIG. 4 Faraday cup signal of Cl^+ beam extracted at various voltages versus RF plasma drive, source pressure 1.5 mtorr.
- FIG. 5 Faraday cup signal of Cl^- beam extracted at various voltages versus RF plasma drive, source pressure 1.5 mtorr.
- FIG. 6 Ratio of co-extracted electrons to Cl^- measured by the Faraday cup, source pressure 3.4 mtorr, extraction voltage 20 kV.
- FIG. 7 Typical emittance plot, in this case for Cl^- .
- FIG. 8 Normalized Ar^+ emittance with different source pressures.
- FIG. 9 Normalized Cl^+ emittance with different source pressures.
- FIG. 10 Normalized Cl^- emittance with different source pressures.

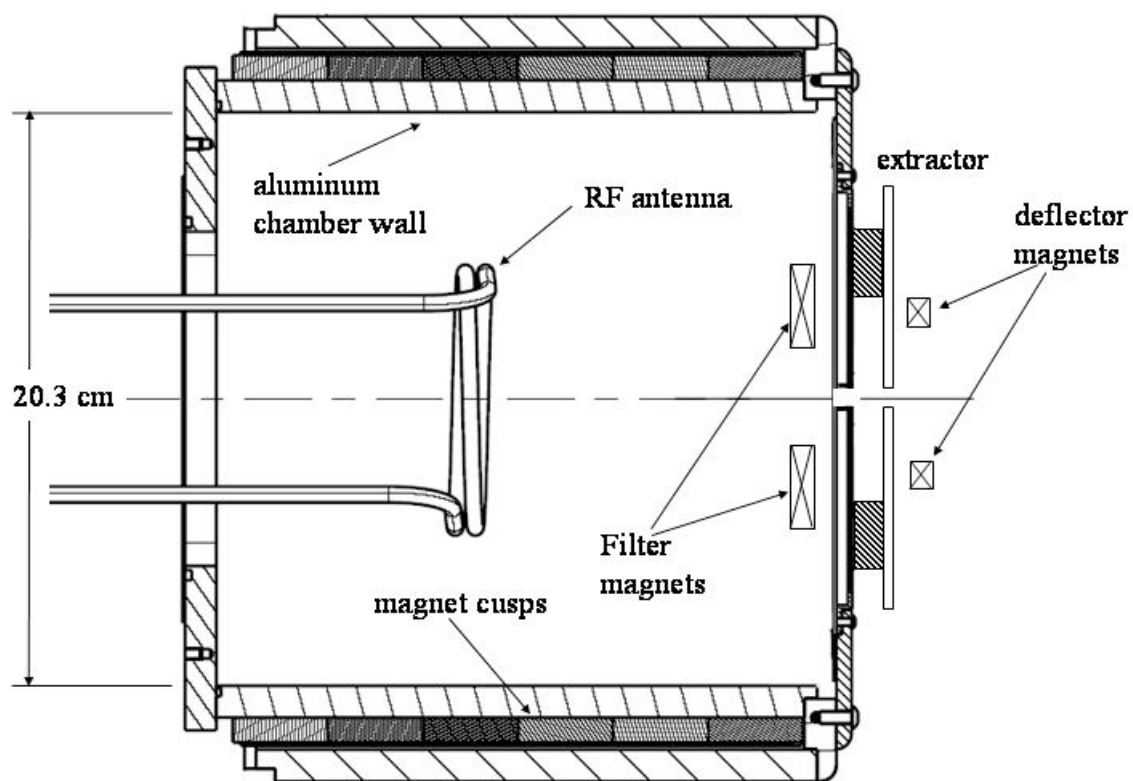


FIG. 1

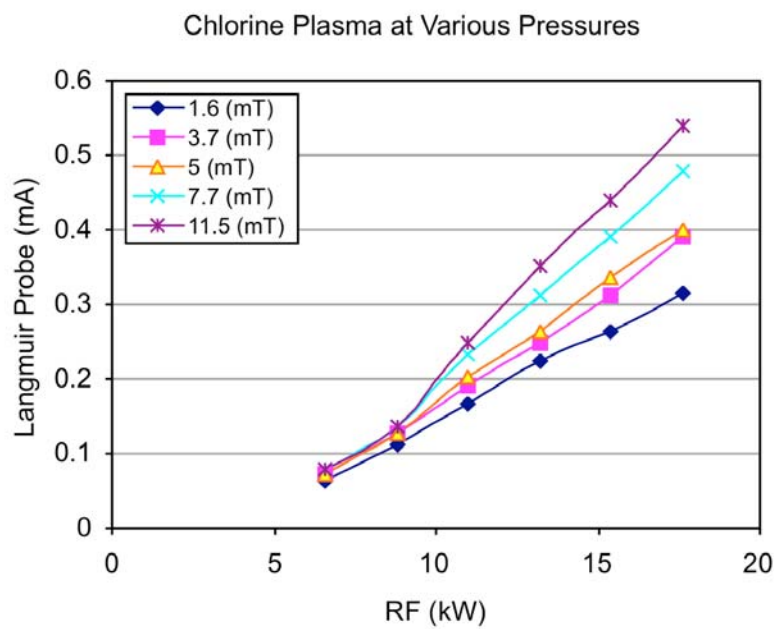


Figure 2

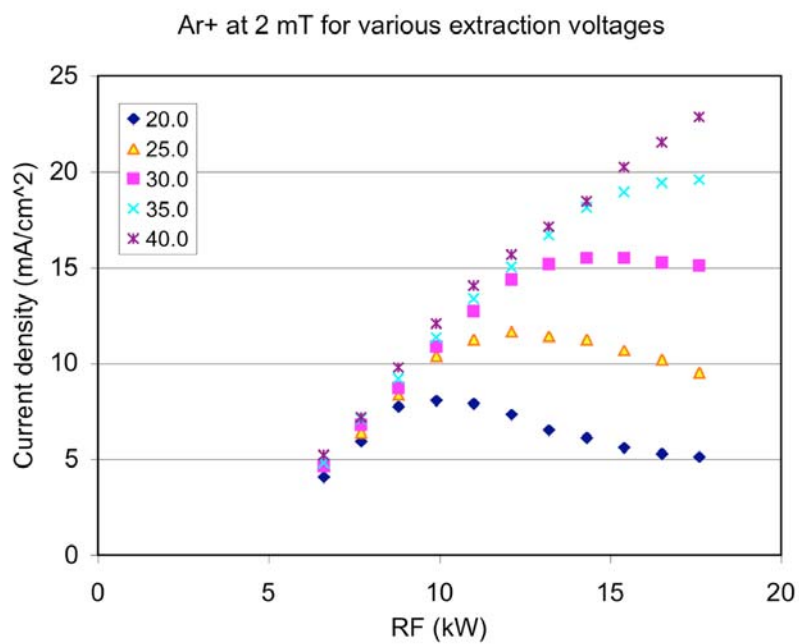


Figure 3

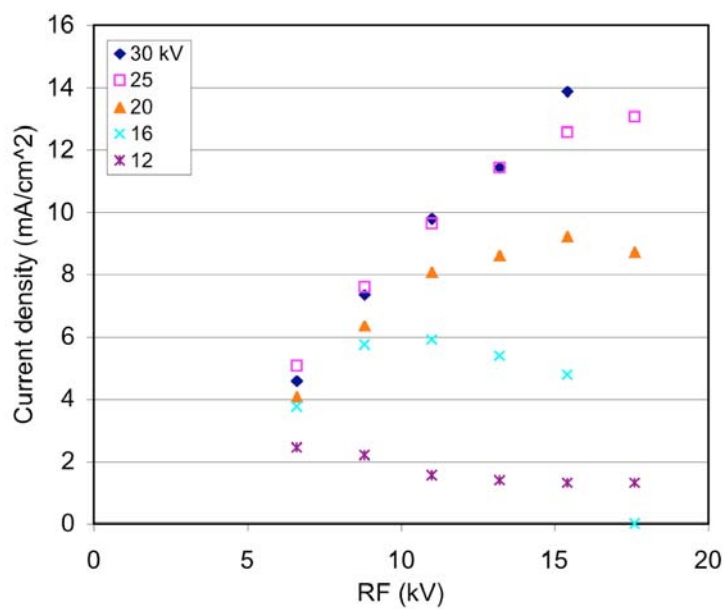
Cl⁺ at 1.5 mT for various extraction voltages

Figure 4

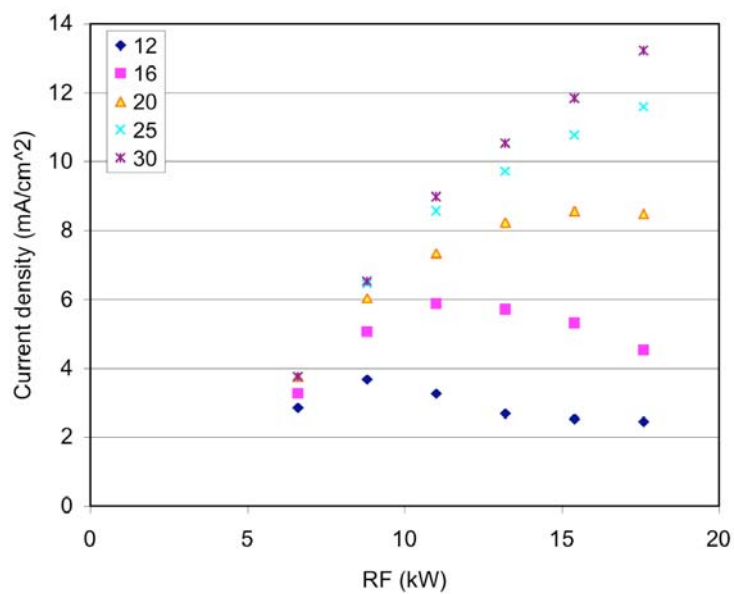
Cl⁻ at 1.5 mT for various extraction voltages

Figure 5

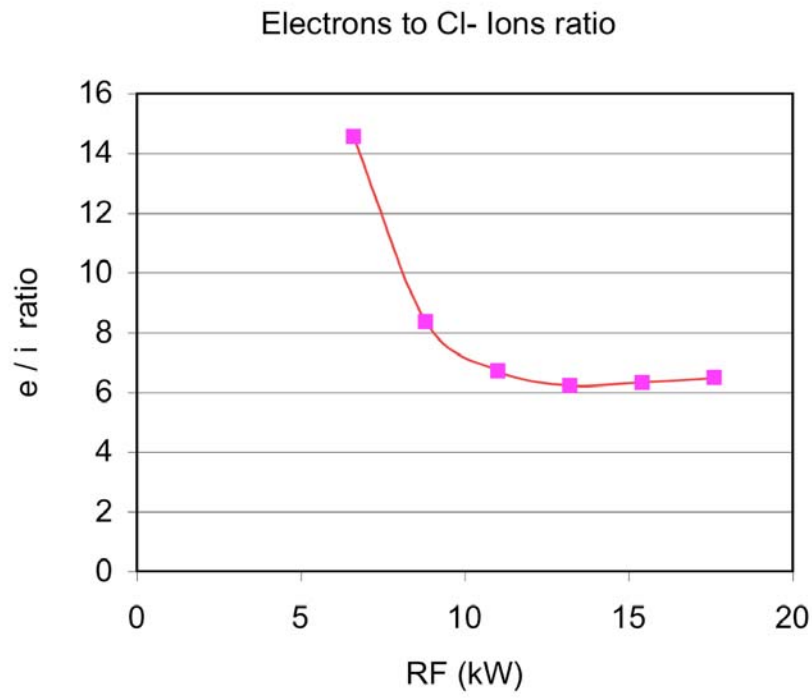


Figure 6

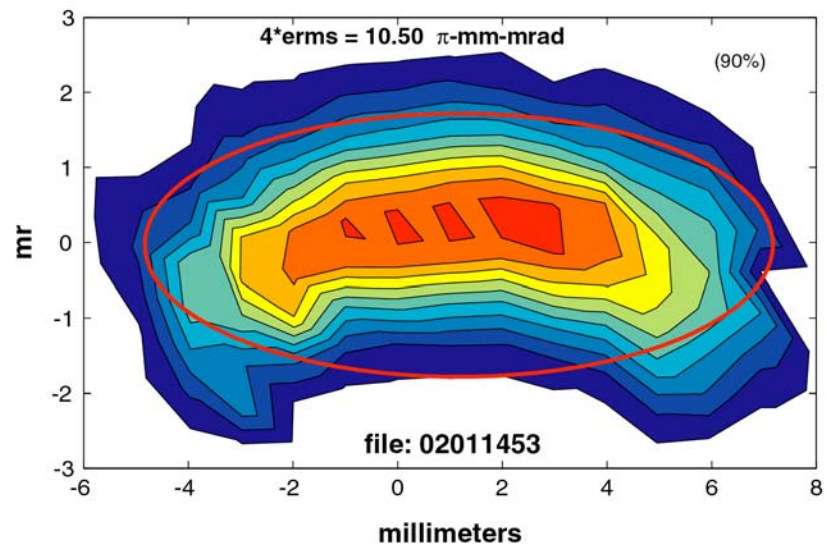


Figure 7

Ar+ Emittance (70%) for various gas pressures

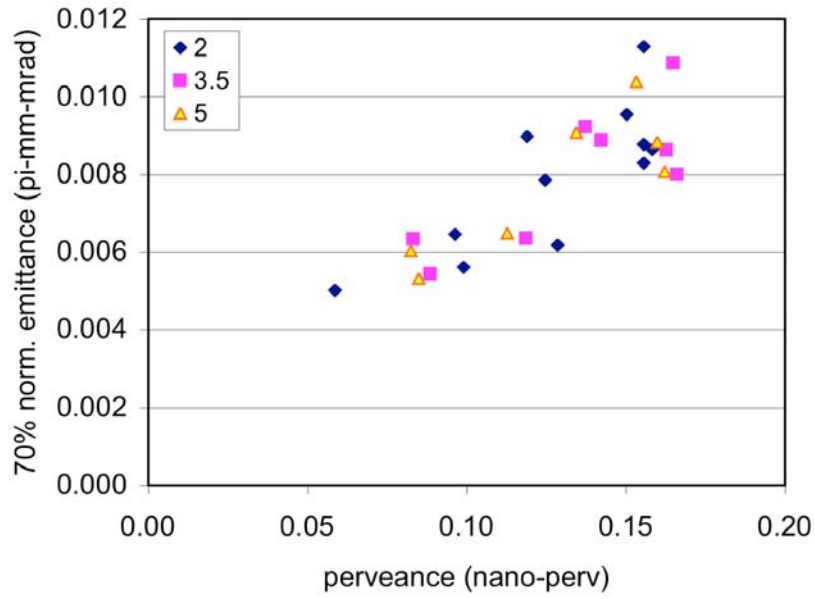


Figure 8

Cl+ Emittance (70%) for various gas pressures

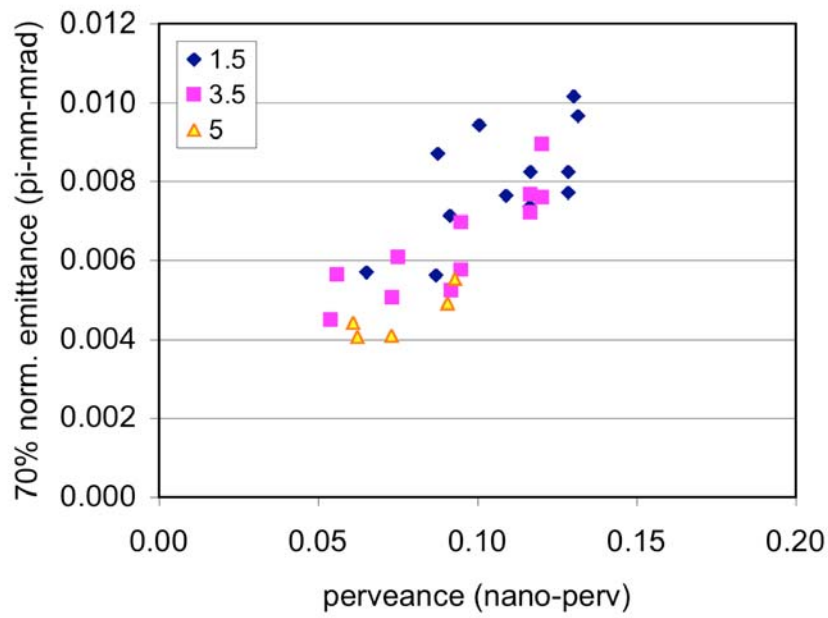


Figure 9

CI- Emittance (70%) for various gas pressures

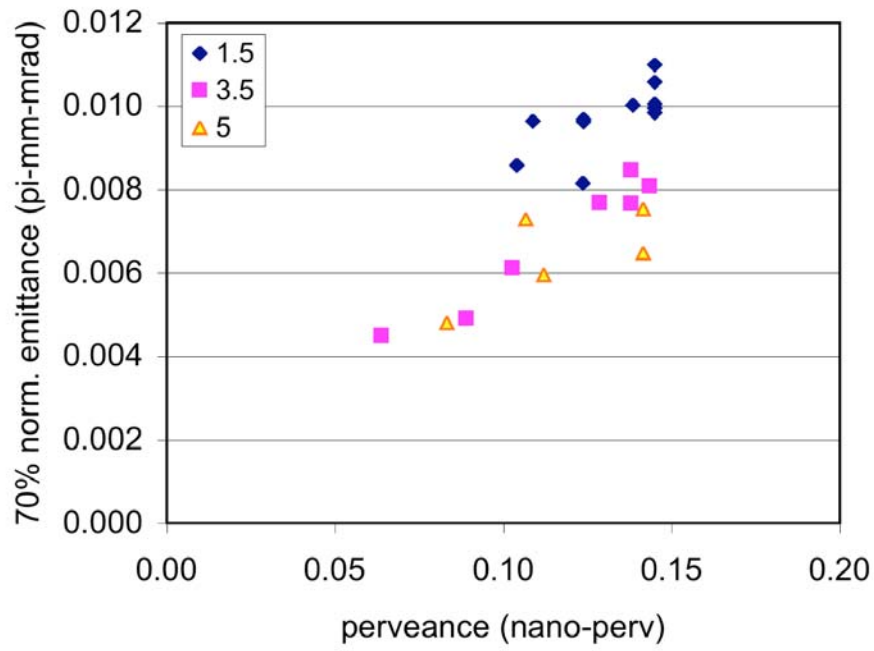


Figure 10

External Distribution

Plasma Research Laboratory, Australian National University, Australia
Professor I.R. Jones, Flinders University, Australia
Professor João Canalle, Instituto de Fisica DEQ/IF - UERJ, Brazil
Mr. Gerson O. Ludwig, Instituto Nacional de Pesquisas, Brazil
Dr. P.H. Sakanaka, Instituto Fisica, Brazil
The Librarian, Culham Science Center, England
Mrs. S.A. Hutchinson, JET Library, England
Professor M.N. Bussac, Ecole Polytechnique, France
Librarian, Max-Planck-Institut für Plasmaphysik, Germany
Jolan Moldvai, Reports Library, Hungarian Academy of Sciences, Central Research
Institute for Physics, Hungary
Dr. P. Kaw, Institute for Plasma Research, India
Ms. P.J. Pathak, Librarian, Institute for Plasma Research, India
Dr. Pandji Triadyaksa, Fakultas MIPA Universitas Diponegoro, Indonesia
Professor Sami Cuperman, Plasma Physics Group, Tel Aviv University, Israel
Ms. Clelia De Palo, Associazione EURATOM-ENEA, Italy
Dr. G. Grosso, Istituto di Fisica del Plasma, Italy
Librarian, Naka Fusion Research Establishment, JAERI, Japan
Library, Laboratory for Complex Energy Processes, Institute for Advanced Study,
Kyoto University, Japan
Research Information Center, National Institute for Fusion Science, Japan
Professor Toshitaka Idehara, Director, Research Center for Development of Far-Infrared Region,
Fukui University, Japan
Dr. O. Mitarai, Kyushu Tokai University, Japan
Mr. Adefila Olumide, Ilorin, Kwara State, Nigeria
Dr. Jiangang Li, Institute of Plasma Physics, Chinese Academy of Sciences, People's Republic of China
Professor Yuping Huo, School of Physical Science and Technology, People's Republic of China
Library, Academia Sinica, Institute of Plasma Physics, People's Republic of China
Librarian, Institute of Physics, Chinese Academy of Sciences, People's Republic of China
Dr. S. Mirnov, TRINITI, Troitsk, Russian Federation, Russia
Dr. V.S. Strelkov, Kurchatov Institute, Russian Federation, Russia
Kazi Firoz, UPJS, Kosice, Slovakia
Professor Peter Lukac, Katedra Fyziky Plazmy MFF UK, Mlynska dolina F-2, Komenskeho Univerzita,
SK-842 15 Bratislava, Slovakia
Dr. G.S. Lee, Korea Basic Science Institute, South Korea
Dr. Rasulkhozha S. Sharafiddinov, Theoretical Physics Division, Institute of Nuclear Physics, Uzbekistan
Institute for Plasma Research, University of Maryland, USA
Librarian, Fusion Energy Division, Oak Ridge National Laboratory, USA
Librarian, Institute of Fusion Studies, University of Texas, USA
Librarian, Magnetic Fusion Program, Lawrence Livermore National Laboratory, USA
Library, General Atomics, USA
Plasma Physics Group, Fusion Energy Research Program, University of California at San Diego, USA
Plasma Physics Library, Columbia University, USA
Alkesh Punjabi, Center for Fusion Research and Training, Hampton University, USA
Dr. W.M. Stacey, Fusion Research Center, Georgia Institute of Technology, USA
Director, Research Division, OFES, Washington, D.C. 20585-1290

The Princeton Plasma Physics Laboratory is operated
by Princeton University under contract
with the U.S. Department of Energy.

Information Services
Princeton Plasma Physics Laboratory
P.O. Box 451
Princeton, NJ 08543

Phone: 609-243-2750
Fax: 609-243-2751
e-mail: pppl_info@pppl.gov
Internet Address: <http://www.pppl.gov>