



**GREENIDGE MULTI-POLLUTANT CONTROL PROJECT
Preliminary Public Design Report**

Principal Author
Daniel P. Connell

May 2007

**U.S. Department of Energy Cooperative Agreement
DE-FC26-06NT41426**

**CONSOL Energy Inc.
Research & Development
4000 Brownsville Road
South Park, PA 15129**

**AES Greenidge LLC
590 Plant Road
Dresden, NY 14441**

**Babcock Power Environmental Inc.
5 Neponset Street
Worcester, MA 01615**

DISCLAIMER

This report was prepared as an account of work sponsored by an agency of the United States Government. Neither the United States Government nor any agency thereof, nor any of their employees, makes any warranty, express or implied, or assumes any legal liability or responsibility for the accuracy, completeness, or usefulness of any information, apparatus, product, or process disclosed, or represents that its use would not infringe privately owned rights. Reference herein to any specific commercial product, process, or service by trade name, trademark, manufacturer, or otherwise does not necessarily constitute or imply its endorsement, recommendation, or favoring by the United States Government or any agency thereof. The views and opinions of authors expressed herein do not necessarily state or reflect those of the United States Government or any agency thereof.

ABSTRACT

The Greenidge Multi-Pollutant Control Project is being conducted as part of the U.S. Department of Energy's Power Plant Improvement Initiative to demonstrate an innovative combination of air pollution control technologies that can cost-effectively reduce emissions of SO₂, NO_x, Hg, acid gases (SO₃, HCl, and HF), and particulate matter from smaller coal-fired electrical generating units (EGUs). The multi-pollutant control system includes a hybrid selective non-catalytic reduction (SNCR) / in-duct selective catalytic reduction (SCR) system to reduce NO_x emissions by ≥60%, followed by a Turbosorp[®] circulating fluidized bed dry scrubber system to reduce emissions of SO₂, SO₃, HCl, and HF by ≥95%. Mercury removal of ≥90% is also targeted via the co-benefits afforded by the in-duct SCR, dry scrubber, and baghouse and by injection of activated carbon upstream of the scrubber, as required. The technology is particularly well suited, because of its relatively low capital and maintenance costs and small space requirements, to meet the needs of coal-fired units with capacities of 50-300 MW_e. There are about 440 such units in the United States that currently are not equipped with SCR, flue gas desulfurization (FGD), or mercury control systems. These smaller units are a valuable part of the nation's energy infrastructure, constituting about 60 GW of installed capacity. However, with the onset of the Clean Air Interstate Rule, Clean Air Mercury Rule, and various state environmental actions requiring deep reductions in emissions of SO₂, NO_x, and mercury, the continued operation of these units increasingly depends upon the ability to identify viable air pollution control retrofit options for them. The large capital costs and sizable space requirements associated with conventional technologies such as SCR and wet FGD make these technologies unattractive for many smaller units. The Greenidge Project aims to confirm the commercial readiness of an emissions control system that is specifically designed to meet the environmental compliance requirements of these smaller coal-fired EGUs.

The multi-pollutant control system is being installed and tested on the AES Greenidge Unit 4 (Boiler 6) by a team including CONSOL Energy Inc. as prime contractor, AES Greenidge LLC as host site owner, and Babcock Power Environmental Inc. as engineering, procurement, and construction contractor. All funding for the project is being provided by the U.S. Department of Energy, through its National Energy Technology Laboratory, and by AES Greenidge. AES Greenidge Unit 4 is a 107 MW_e (net), 1950s vintage, tangentially-fired, reheat unit that is representative of many of the 440 smaller coal-fired units identified above. Following design and construction, the multi-pollutant control system will be demonstrated over an approximately 20-month period while the unit fires 2-4% sulfur eastern U.S. bituminous coal and co-fires up to 10% biomass.

This Preliminary Public Design Report is the first in a series of two reports describing the design of the multi-pollutant control facility that is being demonstrated at AES Greenidge. Its purpose is to consolidate for public use all available nonproprietary design information on the Greenidge Multi-Pollutant Control Project. As such, the report includes a discussion of the process concept, design objectives, design considerations, and uncertainties associated with the multi-pollutant control system and also summarizes the design of major process components and balance of plant considerations for the AES Greenidge Unit 4 installation. The Final Public Design Report, the second report in the series, will update this Preliminary Public Design Report to reflect the final, as-built design of the facility and to incorporate data on capital costs and projected operating costs.

TABLE OF CONTENTS

1. Executive Summary	1
2. Introduction	3
2.1 The Power Plant Improvement Initiative	3
2.2 The Greenidge Multi-Pollutant Control Project	4
2.3 Host Site Information	6
3. Technology Overview	8
3.1 Process Concept	8
3.1.1 NO _x Control	8
3.1.2 SO ₂ , SO ₃ , HCl, HF, and Particulate Matter Control	11
3.1.3 Mercury Control	13
3.2 Design Objectives	14
3.2.1 Deep Emission Reductions	14
3.2.2 Low Capital Costs	14
3.2.3 Small Space Requirements	15
3.2.4 Applicability to High-Sulfur Coals	16
3.2.5 Low Maintenance Requirements	16
3.2.6 Operational Flexibility	17
3.3 Design Considerations	18
3.3.1 Coal and Ash Characteristics	18
3.3.2 Baseline NO Concentration	19
3.3.3 Temperature Profile in the Furnace	19
3.3.4 Flue Gas Residence Time and Flow Profile in the Furnace	20
3.3.5 CO Concentrations in the Furnace	20
3.3.6 Available Space between the Economizer and Air Heater	20
3.3.7 Flue Gas Temperature at the Economizer Outlet	20
3.3.8 Flue Gas Homogeneity at the SCR Inlet	21
3.3.9 Amount of Allowable Ammonia Slip	21
3.3.10 Approach to Adiabatic Saturation in the Absorber Vessel	21
3.3.11 Increased Solids Loading to the Baghouse	21
3.3.12 Pressure Drop Across the System	22
3.4 Project Uniqueness and Uncertainties	22

4. System Design for AES Greenidge Unit 4	25
4.1 Design Basis	25
4.2 Description by Major Process Component	26
4.2.1 Selective Non-Catalytic Reduction System	26
4.2.2 In-Duct Selective Catalytic Reduction Reactor	27
4.2.3 Activated Carbon Injection System	28
4.2.4 Turbosorp® Circulating Fluidized Bed Dry Scrubber	29
4.2.5 Process Water System	31
4.2.6 Lime Storage, Hydration, and Injection System	31
4.2.7 Baghouse	32
4.2.8 Ash Recirculation System	33
4.2.9 Booster Fan	33
4.3 Balance of Plant Considerations	33
4.3.1 Ductwork	33
4.3.2 Civil and Structural	34
4.3.3 Instruments and Controls	36
4.3.4 Electrical	36
4.3.5 Other Utilities	37
4.3.6 Byproducts	37
4.3.7 Out-of-Scope Modifications	39
4.3.7.1 Combustion Modifications	39
4.3.7.2 Air Preheater Basket Modifications	39
5. Conclusions	41
ACRONYMS AND ABBREVIATIONS	42
REFERENCES	44
APPENDIX A – PROCESS FLOW DIAGRAMS	46
APPENDIX B – LIST OF MAJOR EQUIPMENT	49
APPENDIX C – GENERAL ARRANGEMENT DRAWINGS	51

LIST OF FIGURES

Figure 1.	Overall project schedule.	5
Figure 2.	Aerial photograph of the AES Greenidge plant, as viewed from the south.	7
Figure 3.	Schematic of the multi-pollutant control process being demonstrated at AES Greenidge Unit 4.	8
Figure 4.	Conceptual depiction of the effect of temperature on urea utilization and ammonia slip in SNCR, and the implications of this effect for hybrid SNCR/SCR design.	9
Figure 5.	Conceptual illustration of the Delta Wing™ static mixing technology.	11
Figure 6.	Schematic of the Turbosorp® circulating fluidized bed dry scrubber system. Red, blue, and green arrows indicate the paths of solids, liquids, and gases, respectively, through the system.	12
Figure 7.	Operating strategy for the hybrid NO _x control system being demonstrated at AES Greenidge.	17
Figure 8.	Photograph of the physical flow model used to design the in-duct SCR for AES Greenidge Unit 4 (courtesy of Ruscheweyh Consult GmbH).	29
Figure 9.	Process control schematic showing major control loops for the Turbosorp® circulating fluidized bed dry scrubber at AES Greenidge. Lime injection control is shown in green; water injection control is shown in blue, and solid product recycle control is shown in red.	30
Figure 10.	Photograph taken prior to the start of construction of the site for the outdoor portion of the multi-pollutant control system, as viewed from the southwest.	35

LIST OF TABLES

Table 1.	Characteristics of existing Turbosorp® installations and of the Greenidge design.	23
Table 2.	Assumed fuel characteristics (as fired) for the design case.	25
Table 3.	Emission performance targets for the design case.	26
Table 4.	Water requirements for operation of the multi-pollutant control system at AES Greenidge.	37
Table 5.	Projected composition of the fly ash / scrubber byproduct discharged from the baghouse.	38

1. Executive Summary

As part of the Greenidge Multi-Pollutant Control Project, CONSOL Energy Inc. Research & Development, AES Greenidge LLC, and Babcock Power Environmental Inc. (BPEI) are installing and testing an innovative, integrated combination of technologies on one of the nation's smaller existing coal-fired power plants - the 107-MW_e AES Greenidge Unit 4 (Boiler 6). The overall goal of this approximately 2.5-year project is to demonstrate that the multi-pollutant control system being installed, which includes a hybrid selective non-catalytic reduction (SNCR) / selective catalytic reduction (SCR) system and a Turbosorp[®] circulating fluidized bed dry scrubbing system with baghouse ash recycling and activated carbon injection, can cost-effectively reduce emissions of nitrogen oxides (NO_x), sulfur dioxide (SO₂), mercury (Hg), particulate matter (PM), and acid gases, including sulfur trioxide (SO₃), hydrochloric acid (HCl), and hydrofluoric acid (HF), from coal-fired electrical generating units (EGUs) with capacities of 50 MW_e to 600 MW_e. The project is being conducted as part of the U.S. Department of Energy's (DOE's) Power Plant Improvement Initiative (PPII), which is managed by its National Energy Technology Laboratory (NETL).

Although the multi-pollutant control system being demonstrated at AES Greenidge is applicable to units with capacities of 50-600 MW_e, its potential benefits are greatest for units in the lower half of this size range. There are about 440 coal-fired units in the United States with capacities of 50-300 MW_e that currently are not equipped with SCR or flue gas desulfurization systems. These smaller units, which represent about 60 GW of installed generating capacity, are increasingly vulnerable to retirement or fuel switching as a result of progressively more stringent state and federal environmental regulations. The Greenidge Project will demonstrate the commercial readiness of an emissions control system that is particularly suited, because of its low capital and maintenance costs and small space demands, to meet the requirements of this large group of existing electrical generating units.

The Greenidge Multi-Pollutant Control Project is being funded by the DOE and by AES Greenidge. The project will be the first to demonstrate:

- Full-load NO_x emissions of ≤0.10 lb/MMBtu using a hybrid SNCR/SCR system, in combination with low-NO_x combustion technology, on a unit firing >2%-sulfur coal and biomass
- SO₂ and acid gas (SO₃, HCl, HF) removal of ≥95% using a Turbosorp[®] circulating fluidized bed dry scrubber on a unit firing >2%-sulfur U.S. bituminous coal
- Mercury reduction of ≥90% via the co-benefits afforded by the in-duct SCR and Turbosorp[®] (with baghouse) systems and by activated carbon injection, if needed

This Preliminary Public Design Report is the first in a series of two reports that together will consolidate for public use all available nonproprietary design and cost information on the Greenidge Multi-Pollutant Control Project. The design of the multi-pollutant control system was developed in response to the following overall objectives, which are consistent with the needs of smaller coal-fired units in an increasingly stringent regulatory environment:

- Achieve deeper emission reductions than those afforded by conventional low-capital-cost emissions control options (e.g., low-NO_x burners or stand-alone SNCR for NO_x control and combustion of low-sulfur coal or use of sorbent injection for SO₂ control)
- Require less capital investment than the amount needed for conventional technologies (e.g., full-scale SCR systems, wet scrubbers) that are capable of deep air emissions reductions
- Require less space than the amount needed for conventional technologies (e.g., full-scale SCR systems, wet scrubbers) that are capable of deep air emissions reductions
- Provide applicability to a wide range of coal types, including high-sulfur (i.e., >2%-sulfur) coals
- Minimize maintenance requirements
- Provide operational flexibility, including turndown capabilities for units that regularly cycle their loads in response to electricity demand

The design for AES Greenidge Unit 4 is based on the use of a 2.9%-sulfur (range: 2-4%) bituminous coal, with up to 10% biomass co-firing, and a baseline NO_x emission rate of ~0.30 lb/MMBtu. NO_x control is

the first step in the multi-pollutant control process and is accomplished using urea-based, in-furnace SNCR followed by a single-bed SCR reactor that is installed in a modified section of the ductwork between the unit's economizer and air heaters. The SCR process is fed by ammonia slip from the SNCR process; static mixers located just upstream of the SCR are used to homogenize the velocity, temperature, and composition of the flue gas to promote optimal ammonia utilization and NO_x reduction across the relatively small SCR catalyst. The hybrid NO_x control system at AES Greenidge Unit 4 also includes combustion modifications (being installed outside of the scope of the DOE project) to achieve further reductions in NO_x emissions and to improve the performance of the hybrid SNCR/SCR system. Hence, a full-load NO_x emission rate of ≤0.10 lb/MMBtu results from the combination of the combustion modifications, which are designed to produce NO_x emissions of 0.25 lb/MMBtu, the SNCR, which is designed to reduce NO_x by ~42% to 0.144 lb/MMBtu, and the SCR, which is designed to further reduce NO_x by ≥31% to ≤0.10 lb/MMBtu.

Emissions of SO₂ and other acid gases are reduced by ≥95% in the Turbosorp[®] circulating fluidized bed dry scrubber system, which is installed downstream of the air heaters. In the Turbosorp[®] system, water and dry hydrated lime, which is supplied from an on-site hydrator being installed at AES Greenidge, are injected separately into a fluidized bed absorber, where the flue gas is evaporatively cooled and brought into intimate contact with the hydrated lime reagent in a fast fluidized bed. The hydrated lime reacts with the acidic constituents of the flue gas (i.e., SO₂, SO₃, HCl, and HF) to form dry solid products, which are separated from the flue gas in a new pulse-jet baghouse and recycled to the absorber via air slides at a high ratio to the inlet solids in order to maximize pollutant removal and lime utilization.

It is likely that the Greenidge multi-pollutant control process, with its combination of an in-duct SCR, hydrated lime-based scrubber, and baghouse, will result in high mercury removals without any activated carbon injection when applied to bituminous coal-fired units. However, to ensure ≥90% Hg removal efficiency, the AES Greenidge Unit 4 installation also includes an activated carbon injection system. Relative to simple duct injection, very effective utilization of the activated carbon and high mercury capture are expected to result from the high solids recycle ratio, long solids residence time, and low temperature (~170°F) provided by the circulating fluidized bed dry scrubber and baghouse.

A new booster fan is provided to overcome the increased pressure drop created by the addition of the static mixers, SCR catalyst, circulating fluidized bed dry scrubber, and baghouse. The design includes turndown capabilities for the SNCR and Turbosorp[®] scrubber systems, enabling continued emissions reduction at reduced loads. Balance of plant impacts, including requirements for ductwork, civil and structural work, instruments and controls, utilities, and byproduct handling, are also accounted for.

Important considerations affecting the design of the multi-pollutant control system include the following:

- Coal and ash characteristics
- Baseline NO concentration
- Temperature profile in the furnace
- Flue gas residence time and flow profile in the furnace
- CO concentrations in the furnace
- Available space between the economizer and air heater
- Flue gas temperature at the economizer outlet
- Flue gas homogeneity at the SCR inlet
- Amount of allowable ammonia slip
- Approach to adiabatic saturation in the absorber vessel
- Increased solids loading to the baghouse
- Pressure drop across the system

The multi-pollutant control system has a capital cost (delivered and erected) of about \$340/kW (including the combustion modifications) and occupies an approximately 0.4-acre footprint for the AES Greenidge Unit 4 application. Details about the capital and operating costs associated with the system will be provided in the Final Public Design Report for the project.

2. Introduction

The Greenidge Multi-Pollutant Control Project is being conducted under U.S. Department of Energy Cooperative Agreement No. DE-FC26-06NT41426 to demonstrate the full-scale, retrofit application of a multi-pollutant control system that is designed to reduce emissions of NO_x, SO₂, Hg, particulate matter, and acid gases, including SO₃, HCl, and HF, from coal-fired power plants with capacities of 50–600 MW_e. The multi-pollutant control system, which includes the combination of a hybrid urea-based selective non-catalytic reduction / in-duct selective catalytic reduction system and a Turbosorp[®] circulating fluidized bed dry scrubber system with baghouse ash recycling and activated carbon injection, is being installed and tested on the coal-fired, 107 MW_e (net) AES Greenidge Unit 4 (Boiler 6) in Dresden, New York. The project is part of the DOE's Power Plant Improvement Initiative, with an overall objective of demonstrating that the combination of technologies being installed at AES Greenidge provides an affordable means for achieving deep reductions in the emissions of a number of pollutants from smaller coal-fired electrical generating units, allowing these units to continue to produce low-cost electricity in an environment of increasingly stringent air emissions regulations.

This Preliminary Public Design Report is the first in a series of two reports describing the design of the multi-pollutant control facility that is being demonstrated at AES Greenidge. Its purpose is to consolidate for public use all available nonproprietary design information on the Greenidge Multi-Pollutant Control Project. The Final Public Design Report, the second report in the series, will update this Preliminary Public Design Report to reflect the final, as-built design of the facility and to incorporate data on capital costs and projected operating costs. Because these reports are limited to nonproprietary information, they do not provide all of the information required to replicate the design of the multi-pollutant control system being installed at AES Greenidge. Rather, they are intended to serve as references highlighting important design and cost considerations involved in commercial-scale installations of the multi-pollutant control system.

2.1 The Power Plant Improvement Initiative

The Power Plant Improvement Initiative was established on October 11, 2000, under U.S. Public Law 106-291 to foster the commercial demonstration of coal-based technologies capable of improving the efficiency, cost-competitiveness, and environmental performance of new and existing electric generating facilities in the United States. A follow-on to the Clean Coal Technology (CCT) demonstration program that was implemented successfully in the 1980s and 1990s, the PPII is a cost-shared collaboration between government and industry, supported by \$95 million in federal funding transferred from the CCT program, that seeks to help ensure the reliability of the nation's energy supply. The Greenidge Multi-Pollutant Project was one of eight projects selected for negotiation under the PPII solicitation issued in February 2001, and one of five that were awarded cooperative agreements by the DOE. All of these projects focus on technologies that can be quickly commercialized and are applicable to energy systems that utilize at least 75% coal, and all include participant cost shares of 50% or greater as well as repayment provisions that apply to domestic and foreign sales and licensing. The DOE's National Energy Technology Laboratory manages the PPII projects.

2.2 The Greenidge Multi-Pollutant Control Project

The Greenidge Multi-Pollutant Control project responds to the objectives of the PPII by demonstrating a technology that is intended to help ensure the continued availability of reliable, low-cost electricity from the nation's large asset base of smaller existing coal-fired power plants. Although the technology being demonstrated at AES Greenidge is applicable to units with capacities of 50-600 MW_e, its potential benefits are greatest for units in the lower half of this size range. There are currently about 440 coal-fired EGUs in the United States with capacities of 50-300 MW_e that are equipped with neither flue gas desulfurization (FGD) nor selective catalytic reduction technologies, and a majority of these units have not announced plans for air pollution control retrofits. These 440 smaller coal-fired units represent more than 60 GW of installed electric generating capacity; hence, curtailment or loss of their generation would further exacerbate electricity and natural gas supply and distribution problems throughout the United States. However, these EGUs are subject to progressively more rigorous environmental regulations such as the Clean Air Interstate Rule (CAIR), Clean Air Mercury Rule (CAMR), and various state actions. Conventional control technologies being installed on newer, larger EGUs are capable of achieving these rigorous regulations, but entail large capital investments and large space requirements that make them unattractive for this fleet of older, smaller EGUs. Hence, there is a strong need to demonstrate and commercialize technologies specifically designed to meet the environmental compliance requirements of these smaller coal-fired units. The Greenidge Multi-Pollutant Control Project seeks to demonstrate the commercial readiness of an emissions control system that is particularly suited, because of its relatively low capital and maintenance costs and small space requirements, to satisfy these requirements.

As discussed above, the multi-pollutant control system being demonstrated as part of the Greenidge Project comprises an innovative, integrated combination of technologies, including a hybrid NO_x control system consisting of urea-based SNCR and in-duct SCR and a Turbosorp[®] circulating fluidized bed dry scrubber system including a new baghouse, solid product recycling system, and activated carbon injection system. More than 80% of the 440 smaller coal-fired EGUs referenced above are located east of the Mississippi River, where eastern bituminous coal is a likely fuel source, and where it is often economically attractive for scrubbed units to fire mid-to-high sulfur coals. Hence, the multi-pollutant control system will be demonstrated while AES Greenidge Unit 4 fires eastern U.S. bituminous coals containing 2-4% sulfur.

Unit 4 also co-fires biomass at up to 10% heat input, and the demonstration program includes an evaluation of the effect of biomass co-firing on the performance of the multi-pollutant control system. In addition to the potential economic benefits afforded by diversifying a plant's fuel portfolio, biomass co-firing can help to reduce emissions of SO₂ and NO_x as well as net emissions of CO₂ (Fernando, 2002). Although combustion of biomass produces CO₂, it can be considered CO₂-neutral, because the amount of CO₂ emitted to the atmosphere by combusting the biomass approximately equals the amount originally absorbed from the atmosphere by the growth of the biomass.

The specific objectives of Greenidge Multi-Pollutant Project are to:

- Demonstrate that the hybrid SNCR/SCR system, in combination with combustion modifications that are being installed outside of the scope of the DOE cooperative agreement, can reduce high-load NO_x emissions from the 107-MW_e AES Greenidge Unit 4 to ≤0.10 lb/MMBtu (a reduction of ≥60% following the combustion modifications) while the unit is firing >2%-sulfur coal and co-firing up to 10% biomass.

- Demonstrate that the Turbosorp® circulating fluidized bed dry scrubber can remove ≥95% of the SO₂ emissions from AES Greenidge Unit 4 while the unit is firing >2%-sulfur coal and co-firing up to 10% biomass.
- Demonstrate ≥90% mercury removal via the co-benefits achieved by the SNCR/SCR and Turbosorp® circulating fluidized bed dry scrubber (with baghouse) systems and, as required, carbon or other sorbent injection.
- Demonstrate ≥95% removal of acid gases (SO₃, HCl, and HF) by the Turbosorp® circulating fluidized bed dry scrubber.
- Evaluate process economics and performance to demonstrate the commercial readiness of an emission control system that is suitable for meeting the emission reduction requirements of boilers with capacities of 50 MW_e to 600 MW_e.

The overall schedule for the Greenidge Multi-Pollutant Control Project is shown in Figure 1 below. The cooperative agreement between the U.S. Department of Energy and CONSOL Energy Inc. for the project was executed on May 19, 2006. However, in order to keep the project on pace to meet AES Greenidge’s scheduled major outage during the fall of 2006, during which tie-in of the multi-pollutant control system was completed, a substantial amount of work was performed prior to the signing of the cooperative agreement in accordance with pre-award authorizations granted by the DOE. This pre-award work included completion of environmental assessments required by the National Environmental Policy Act (NEPA), which culminated in the issuance of a Finding of No Significant Impact (FONSI) in December 2004, completion of baseline testing at AES Greenidge in November 2004, and commencement of design, procurement, and certain construction activities in 2005. This report focuses on the results of Task 1.2 – Total Process Definition and Design, which was completed in the second half of 2006. As shown in Figure 1, construction, start-up, and commissioning of the multi-pollutant control system are expected to be completed in early 2007; the project then includes a 20-month period of operation during which the technical and economic performance of the multi-pollutant control system will be evaluated.

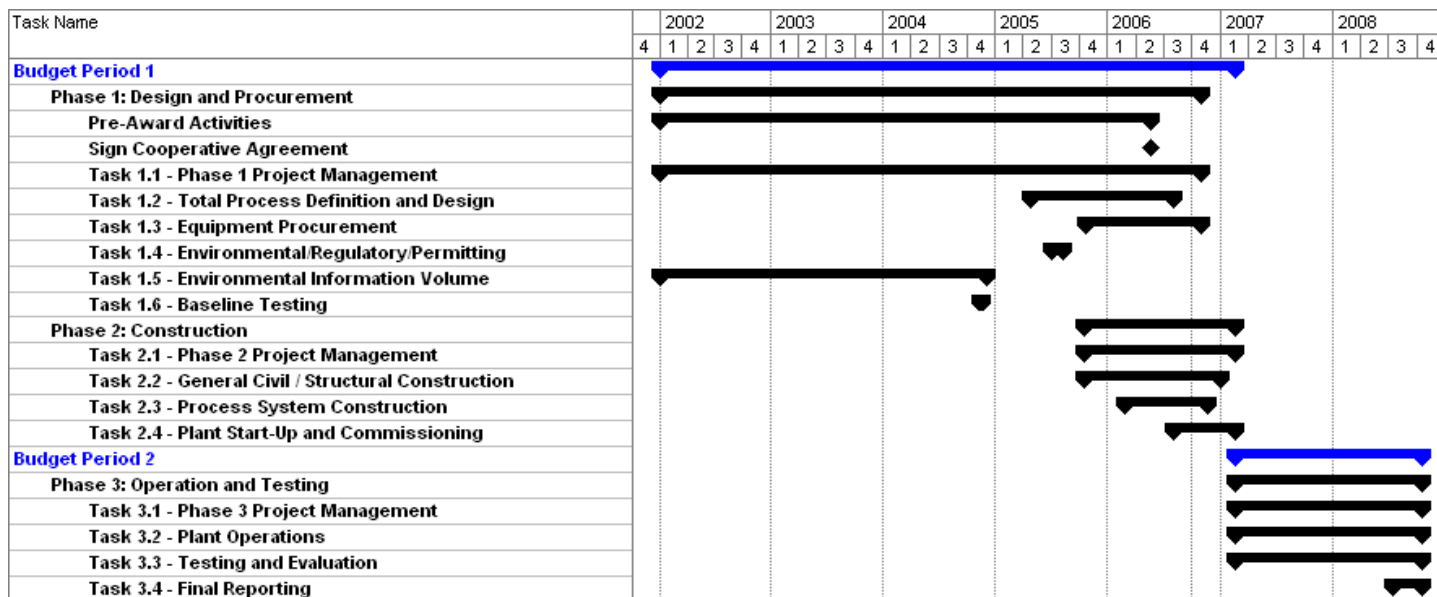

Figure 1. Overall project schedule.

The Greenidge Multi-Pollutant Control Project is being conducted by a team comprising CONSOL Energy Inc. Research & Development, AES Greenidge LLC, and Babcock Power Environmental Inc. CONSOL is the prime contractor under the DOE Cooperative Agreement and is responsible for managing and administering the overall project, testing and evaluating the performance of the multi-pollutant control system, and reporting project results. AES Greenidge, the host site, is a subcontractor to CONSOL and is responsible for site management, environmental permitting, and operation of the demonstration facility. BPEI is a subcontractor to AES Greenidge and is responsible for engineering, procurement, and construction of the multi-pollutant control facility. All funding for the project is being provided by the DOE and by AES Greenidge.

2.3 Host Site Information

AES Greenidge is a 161-MW_e (net) coal-fired electric power plant located in Dresden, Yates County, New York, along the western shore of Seneca Lake. It is a merchant plant that dispatches when its variable cost of producing electricity is less than the market price of electricity. (AES Greenidge sells its power into the New York Independent System Operator's day-ahead and hour-ahead markets). The plant, which is situated on a 153-acre site, currently comprises two electrical generating units: the 54-MW_e (net) Unit 3 and the 107-MW_e (net) Unit 4. Unit 4 is a reheat unit; Unit 3 is not. The Unit 3 steam turbine is served by Boilers 4 and 5, each a pulverized coal-fired boiler having a maximum heat input of 380 MMBtu/h. The Unit 4 steam turbine is served by Boiler 6, a pulverized coal-fired boiler with a maximum heat input of 1,117 MMBtu/h. Coal and other materials are delivered to the plant via train or truck. Fly ash generated by the facility is hauled to the 143-acre Lockwood Landfill, which is located just west-southwest of the plant site.

Figure 2 shows an aerial photograph of the AES Greenidge site, as viewed from the south. The plant's two original units, which were constructed for the New York State Electric & Gas Corporation (NYSEG) in the late 1930s, were retired and removed from the plant in the late 1980s; however, their idle stacks still stand adjacent to the boiler building. AES acquired the plant, including the still-operational Units 3 and 4, from NYSEG in 1999.

The emissions control system to be demonstrated as part of the Greenidge Multi-Pollutant Control Project is being installed on Unit 4 (Boiler 6), which was commissioned in 1953. As shown in Figure 2, the unit and its associated equipment are housed in or adjacent to the western end of the boiler building. Boiler 6 is a Combustion Engineering dry bottom, tangentially-fired, balanced draft, pulverized coal boiler designed for 780,000 lb/h steam flow at 1465 psig. Primary and reheat steam temperatures are 1005 °F. The boiler is served by two single-speed forced draft (FD) fans, two induced draft (ID) fans, and two Ljungstrom air preheaters. The Unit 4 turbine is a General Electric tandem compound reheat steam turbine, which drives a General Electric hydrogen-cooled electrical generator that is rated at 13,800 volts.

Eastern U.S. bituminous coal is the primary fuel for Boiler 6. The furnace is equipped with four levels of pulverized coal burners, with four burners per level (one in each corner of the furnace). Boiler 6 is also permitted to fire clean, unadulterated wood (at up to 100% by weight of the total fuel) or waste wood from a furniture manufacturing process (at up to 30% by weight of the total fuel); this biomass fuel is prepared and fed to the boiler separately from the coal. AES Greenidge routinely uses waste wood to provide up to 10% of the heat input to Boiler 6. In

1996, the boiler was outfitted with a natural gas reburn system that is capable of providing up to about 20% of its heat input; however, the reburn system currently is not in use.

The 1996 combustion modifications to Boiler 6 included the installation of separated overfire air (SOFA) ports, which served as the boiler's primary means for NO_x control. The system was capable of achieving full-load NO_x emissions of about 0.3 lb/MMBtu. Prior to the installation of the multi-pollutant control system, an electrostatic precipitator (ESP) was used to control particulate matter emissions from Boiler 6, and the unit did not have any existing equipment for controlling SO₂ emissions; fuel sulfur content was restricted (via the use of medium-sulfur coal and biomass co-firing) in order to meet its permitted limit of 3.8 lb SO₂ / MMBtu.

In addition to installing the multi-pollutant control system that is the topic of this report, AES Greenidge is undertaking several other projects to help ensure a 20-30 year life extension for Unit 4. These include a major turbine overhaul, replacement of the unit's high-temperature superheater elements, miscellaneous boiler maintenance, and upgrades to the unit's distributed control system (DCS), air preheaters, and ash handling system. As mentioned above, modifications are also being made to the combustion system for Boiler 6, including both its firing system and its SOFA system. Although these combustion modifications are not included in the scope of the DOE cooperative agreement, they are discussed in this report insofar as they help to optimize the performance of the multi-pollutant control system that is being demonstrated thereunder.

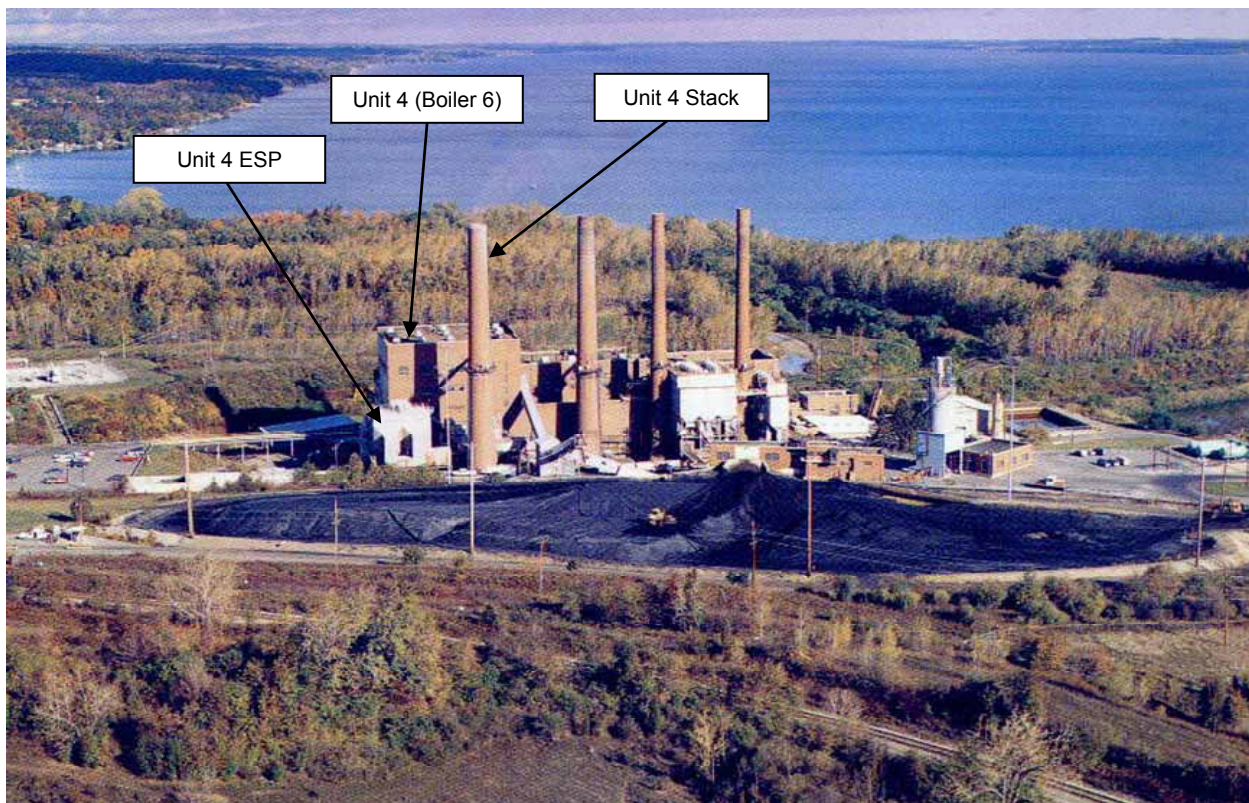

Figure 2. Aerial photograph of the AES Greenidge plant, as viewed from the south.

3. Technology Overview

3.1 Process Concept

Figure 3 presents a schematic of the multi-pollutant control process that is being demonstrated as part of the Greenidge Multi-Pollutant Control Project. The process integrates three major components: NO_x control via a hybrid SNCR / SCR system; SO₂, SO₃, HCl, HF, and particulate matter control via a Turbosorp® circulating fluidized bed dry scrubber system with a baghouse and solid product recycling; and mercury control via activated carbon injection and the co-benefits afforded by the NO_x control and Turbosorp® systems. General process chemistry and engineering concepts for each of these components are described below.

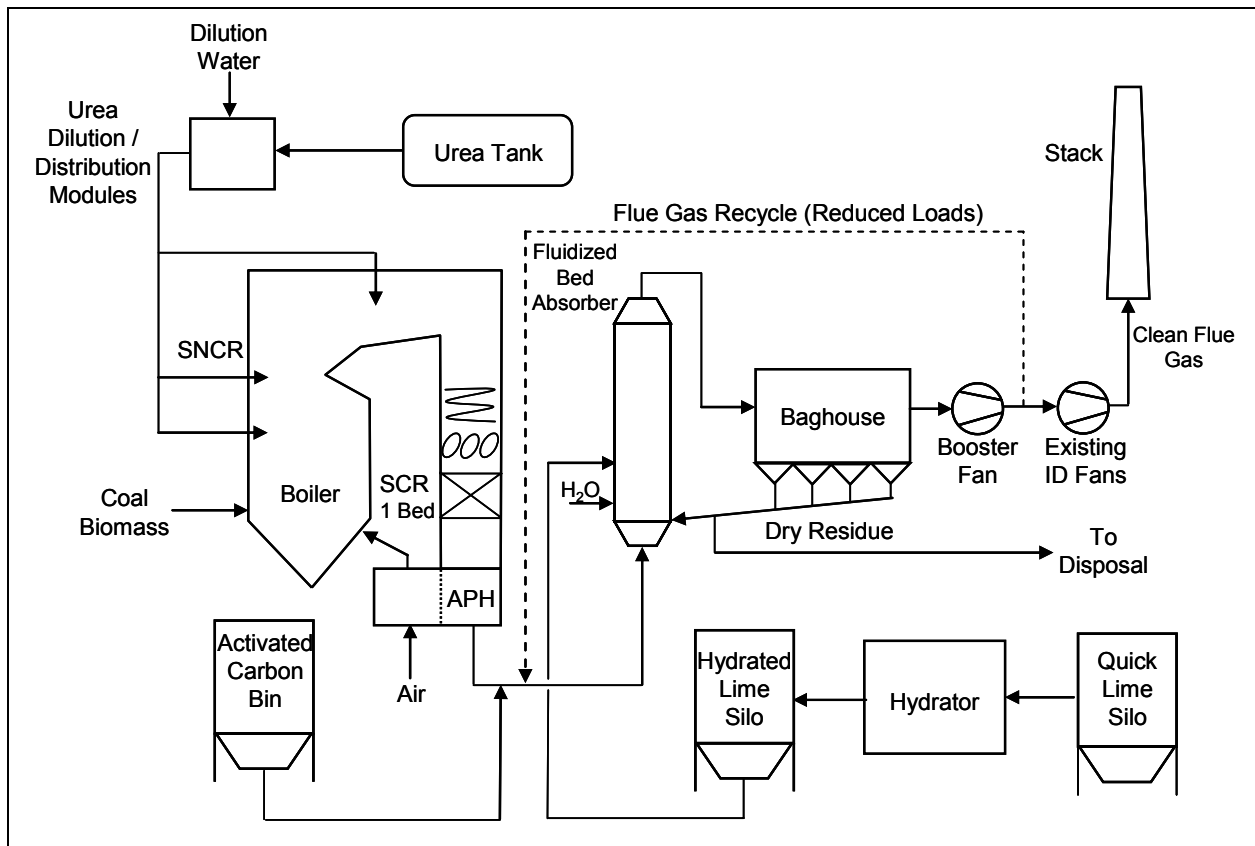
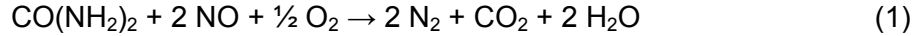

Figure 3. Schematic of the multi-pollutant control process being demonstrated at AES Greenidge Unit 4.

3.1.1 NO_x Control

NO_x control is the first step in the multi-pollutant control process and is accomplished using urea-based, in-furnace selective non-catalytic reduction followed by a single-bed, in-duct selective catalytic reduction reactor that is fed by ammonia (NH₃) slip from the SNCR process. Although not an essential component of the multi-pollutant control process, for certain applications, such as that on AES Greenidge Unit 4, it may be advantageous to complement the hybrid SNCR/SCR system with combustion modifications designed to achieve further reductions in NO_x emissions and to improve the performance of the hybrid SNCR/SCR system.

In the SNCR process, aqueous urea ($\text{CO}(\text{NH}_2)_2$) is atomized and injected into the furnace above the combustion zone. The relatively high temperatures in the furnace promote dissociation of the urea into reactive radicals (e.g., NH_2 , NCO), which react with nitrogen oxide and oxygen to form molecular nitrogen, carbon dioxide, and water, according to the following overall reaction:



The performance of a urea-based SNCR system can be quantified by computing its urea utilization, which is defined as:

$$\text{Urea Utilization (\%)} = [\text{NO}_x \text{ Reduction (\%)}] \div [2 \cdot (\text{moles urea}) / (\text{moles inlet NO}_x)] \quad (2)$$

Hence, if the system achieves a NO_x reduction that is stoichiometrically equivalent to the amount of urea injected, then the urea utilization is 100%. If the NO_x removal is less than stoichiometrically equivalent to the amount of urea injected, then the urea utilization is correspondingly less than 100%.

In practice, urea utilization by SNCR systems is typically much less than 100% (e.g., 30 – 60 %, Albanese et al., 2005), in part because of restrictions on the amount of allowable ammonia slip from these systems. NO_x reduction according to reaction (1) occurs over a temperature range of approximately 1400°F to 2200°F; however, the reaction is temperature-sensitive within this range, as illustrated in Figure 4. Ammonia is a byproduct of urea-based SNCR; the amount of ammonia produced by the process decreases as temperature increases. Because the amount of allowable NH_3 slip is generally limited to 2-10 ppmv or less for coal-fired EGU applications, conventional stand-alone SNCR installations are typically designed to operate at relatively high temperatures that produce low amounts of ammonia slip. At these high temperatures, though, SNCR performance is adversely affected by competing reactions that consume urea or generate additional NO_x , resulting in less-than-optimal urea utilization.

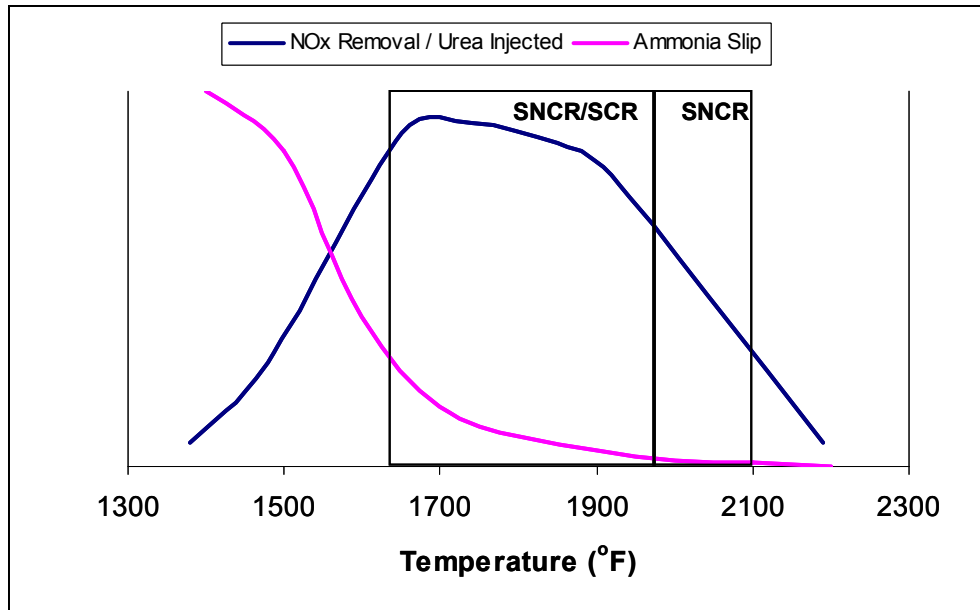
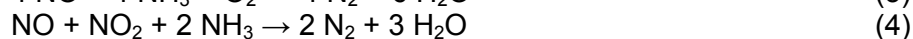
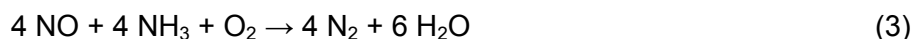

Figure 4. Conceptual depiction of the effect of temperature on urea utilization and ammonia slip in SNCR, and the implications of this effect for hybrid SNCR/SCR design.

In a hybrid SNCR/SCR system, greater levels of ammonia slip from the SNCR process are actually desirable, as the ammonia produced via SNCR serves as the reagent to effectuate additional NO_x removal in the downstream SCR reactor. As a result, the SNCR system in a hybrid process can be designed to operate at lower temperatures (e.g., 1650-1900°F) than a stand-alone SNCR system would, resulting in improved urea utilization and greater NO_x removal by the SNCR system, as well as sufficient NH₃ slip to permit additional NO_x reduction via SCR. Lower-temperature urea injection is accomplished in the hybrid SNCR/SCR system by including some injectors in upper sections of the furnace and in the convective pass.

The flue gas exiting the furnace, which contains unreacted NO_x (primarily NO) and NH₃ produced by the SNCR process, next flows through a compact SCR reactor containing a single catalyst layer that is installed in a modified section of the ductwork between the unit's economizer and air heater. The single-bed, in-duct SCR operates with the same process chemistry as a standard full-size SCR. Nitrogen oxides in the flue gas are reduced by ammonia (or by isocyanic acid, HNCO, which is also formed as part of the SNCR process) in the presence of a catalyst to form molecular nitrogen and water according to the following reactions:



Because the SCR is fed by NH₃ slip resulting from SNCR, it does not require the NH₃ storage and handling system and NH₃ injection grid that are typically needed for stand-alone SCR installations. Otherwise, the in-duct SCR utilizes the same technology as a standard full-size SCR, except that it is installed in a modified section of the ductwork between the unit's existing economizer and air heater(s), where flue gas temperatures (approximately 650°F for the AES Greenidge Unit 4 application at full load) are in the optimum range for the SCR reactions to occur. Because of its small size, the amount of NO_x reduction achievable by the in-duct SCR is less than the amount achievable by a stand-alone SCR. However, unlike a stand-alone SCR, the purpose of the in-duct SCR in the hybrid system is to permit enhanced NO_x reduction by the upstream SNCR by consuming ammonia slip, while also affording incremental NO_x reduction.

To maximize performance of the relatively small, in-duct SCR system, BPEI's Delta Wing™ static mixing technology is installed in the ductwork just upstream of the SCR reactor. As illustrated conceptually in Figure 5, the Delta Wing™ technology utilizes stationary obstructions oriented at a slant to the direction of flow to create a zone of large, violent vortices that homogenize the velocity, temperature, and composition of the flue gas across the cross-sectional area of the duct. For the in-duct SCR reactor, homogeneity in the distribution of NO_x and NH₃ throughout the flue gas is desired to maximize the utilization of the available catalyst surface, thereby maximizing NO_x reduction and minimizing NH₃ slip. The static mixers also help to maintain ash entrainment and distribution across the cross-sectional area of the reactor, minimizing catalyst deactivation and pressure drop via fly ash plugging.

Major process components for the hybrid SNCR/SCR system include urea storage equipment, urea delivery, metering, and distribution equipment, urea injection equipment, static mixers, SCR catalyst, duct modifications and catalyst support, and miscellaneous process control equipment. In addition, sonic horns are used to prevent ash buildup on top of the SCR catalyst. For the AES Greenidge Unit 4 installation, flue gas bypasses are not required around the economizer or the SCR catalyst, simplifying the design and operation of the system.

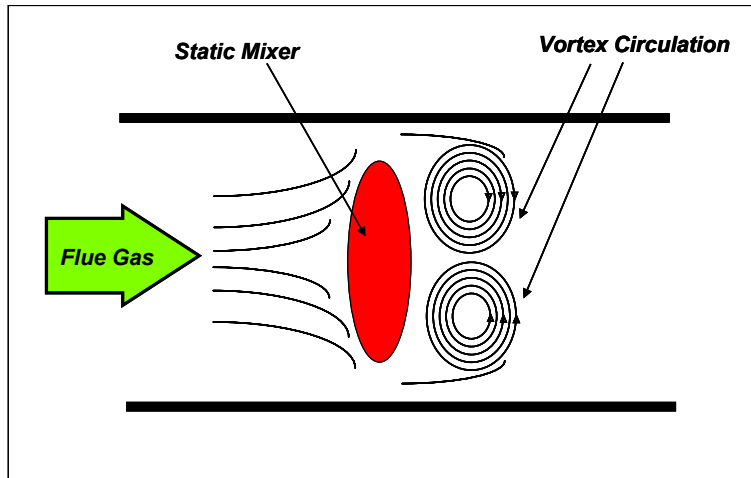

Figure 5. Conceptual illustration of the Delta Wing™ static mixing technology.

3.1.2 SO₂, SO₃, HCl, HF, and Particulate Matter Control

After exiting the SCR reactor and passing through the plant's existing air heater(s), the flue gas is sent to the Turbosorp® circulating fluidized bed dry scrubbing system for removal of SO₂, SO₃, HCl, HF, and particulate matter. In the Turbosorp® system, the flue gas first enters the Turbosorp® absorber vessel through a venturi nozzle. Water and hydrated lime (Ca(OH)₂) are separately injected into the absorber.

In the absorber vessel, the pollutant-laden flue gas is cooled in a fast fluidized bed of moistened particles, which include the injected hydrated lime as well as fly ash and reaction products. As the flue gas passes through the bed of particles, intimate contact is provided between the alkaline particles of hydrated lime and the acid gases contained in the flue gas. The surface moisture of these lime particles provides for liquid phase diffusion of the acid gases and contact with the lime in solution. This is a quick absorption mechanism and the one mainly responsible for neutralization of the acid gases. The large surface area of the particles in the bed also provides for rapid heat transfer. Thus, the particles are quickly dried as the flue gas passes through the bed, and the flue gas is evaporatively cooled to within about 45°F of its adiabatic saturation temperature.

The acid gas constituents of the flue gas (SO₂, SO₃, HCl, HF, and to a lesser extent, CO₂) are removed by reaction with hydrated lime. Each of these acid gas constituents produces a calcium-based salt and excess water when contacted with the alkaline Ca(OH)₂ reagent. Sulfur dioxide and trioxide form calcium sulfite and sulfate hydrates. The halides, HF and HCl, form calcium fluoride and chloride, respectively. Some CO₂ reacts to form calcium carbonate. These reactions are summarized below:

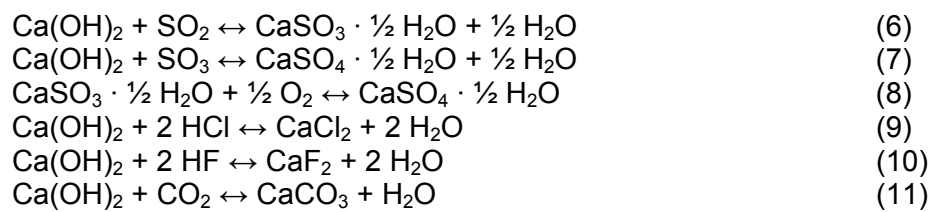

After exiting the absorber vessel, the solid products (i.e., fly ash, unreacted hydrated lime, CaSO_3 , CaSO_4 , CaCO_3 , CaCl_2 , and CaF_2) are separated from the flue gas in a baghouse, which is an integral part of the Turbosorp[®] system. To maximize acid gas removal and reagent utilization, most (e.g., $\geq 95\%$) of these solids are recycled via gravity to the absorber vessel using airslides. Upon reentering the absorber, the sulfite-coated surfaces of partially reacted $\text{Ca}(\text{OH})_2$ particles are moistened, causing the calcium sulfite to form needle-like crystals. This crystallization exposes fresh $\text{Ca}(\text{OH})_2$ surface, permitting additional reaction with acid gases and hence greater reagent utilization. Recycle of the baghouse solids provides ample residence time for sorbent reactivation and reaction with $\text{Ca}(\text{OH})_2$ according to this mechanism.

In addition to removing the acid gas constituents of the flue gas, the circulating fluidized bed dry scrubber system enhances removal of particulate matter. For plants such as AES Greenidge Unit 4 that are currently equipped with an ESP, installation of a baghouse is expected to improve fine particulate matter ($\text{PM}_{2.5}$) capture efficiency. Moreover, the fluidized particle bed in the absorber vessel promotes particle agglomeration via collisions among particles, resulting in larger particles that can be captured more easily in the baghouse. Agglomeration is further enhanced by the water that is injected for flue gas humidification, which tends to increase the cohesion of the particles.

Major components of the Turbosorp[®] system include the absorber vessel, hydrated lime storage, preparation, and injection system, water storage and injection system, baghouse, solid product recycle and injection system, and miscellaneous process control equipment. As shown in Figure 3, a flue gas recycle system is also included to provide sufficient flue gas flow to maintain a fluidized bed in the absorber at low load operation. Figure 6 presents a schematic of the Turbosorp[®] system highlighting the flow of solids, liquids, and gases through the system.

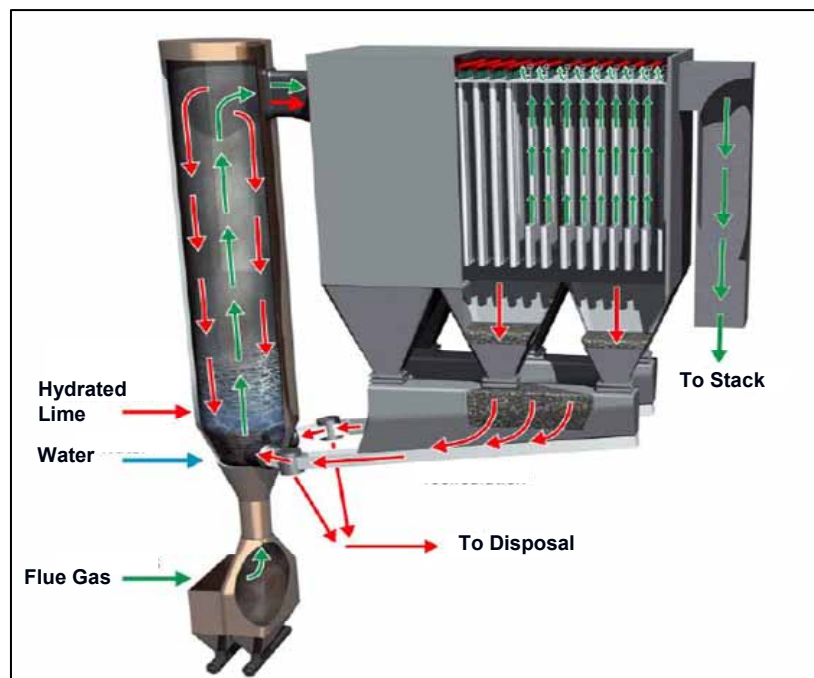

Figure 6. Schematic of the Turbosorp[®] circulating fluidized bed dry scrubber system. Red, blue, and green arrows indicate the paths of solids, liquids, and gases, respectively, through the system.

The process is totally "dry", meaning that it introduces the reagent as a dry, free-flowing powder and produces a dry, free-flowing disposal product. The absorber operates not only as a chemical reactor but also as an evaporative cooler. Surface humidity of particles within the fluidized bed is held nearly constant by introducing the water independently from the recirculated solids and fresh hydrated lime. This minimizes the potential for scaling that exists in wet and semi-dry processes. Water injection, reagent injection, and bed recirculation are independent unit operations. Thus, the process allows reagent injection rates that are a function of pollutant loading and emission targets.

3.1.3 Mercury Control

Mercury control in the multi-pollutant control system being demonstrated at AES Greenidge is accomplished via the co-benefits afforded by the in-duct SCR and circulating fluidized bed dry scrubber with baghouse, as well as by the injection of activated carbon just upstream of the scrubber as required.

From a mercury control perspective, the Greenidge multi-pollutant control process is very similar to a conventional air pollution control configuration comprising an SCR, spray dryer, and baghouse. Measurements have demonstrated that this configuration, when applied to plants firing bituminous coals, achieves a high level of mercury removal (i.e., 89-99%) without the need for any mercury-specific control technology (Withum, 2006; Miller et al., 2006). This high level of removal likely results from a combination of factors, including the conversion of elemental mercury (Hg^0) to oxidized mercury (Hg^{2+}) across the SCR catalyst (Presto and Granite, 2006), the removal of Hg^{2+} (a Lewis acid) via chemisorption by moistened, basic $\text{Ca}(\text{OH})_2$ particles in the scrubber (Lancia et al., 1993; Ghorishi and Gullett, 1998), and the removal of Hg^{2+} and possibly some Hg^0 via adsorption onto carbon-containing fly ash and $\text{Ca}(\text{OH})_2$ at low temperatures in the baghouse (CEA, 2005), which facilitates contact between gaseous mercury and carbon or other sorbent contained in the "dust cake" that accumulates on its numerous filter bags. The Greenidge multi-pollutant control process includes all of these components, and hence, it is likely that its combination of an in-duct SCR, $\text{Ca}(\text{OH})_2$ -based scrubber, and baghouse will result in high mercury removals without any activated carbon injection when applied to bituminous coal-fired units. It is uncertain, however, whether Hg^0 will be oxidized effectively across the SCR catalyst at the abnormally high space velocities resulting from the single-bed, in-duct design. Determining the extent of Hg oxidation and its effect on overall Hg removal is one of the objectives of the demonstration program.

To ensure high mercury removal efficiencies, the multi-pollutant control system also includes an activated carbon injection system. Activated carbon, which adsorbs both Hg^0 and Hg^{2+} (CEA, 2005), is injected into the flue gas just upstream of the Turbosorp[®] absorber vessel. Very effective utilization of the activated carbon and high mercury capture are expected to result from the long solids residence time provided by the circulating fluidized bed scrubbing system's high solids recycle ratio. The relatively low temperatures (~170°F) in the Turbosorp[®] system and the thorough contact facilitated by caking of the carbon sorbent on the baghouse filter bags are also expected to result in a high capacity for mercury capture by the activated carbon, as compared to simple duct injection. The activated carbon injection system includes a carbon storage silo, carbon feed and injection system, and miscellaneous process control instrumentation. The baghouse is used to remove spent carbon from the flue gas.

3.2 Design Objectives

As discussed in the Introduction, the multi-pollutant control system being demonstrated at AES Greenidge was designed with the overall goal of providing an integrated process that is well suited for reducing emissions of a number of pollutants from smaller (i.e., 50-300 MW_e) coal-fired EGUs. Therefore, the design responded to a number of objectives that are consistent with the needs of these smaller units. These objectives, which are synonymous with the advantages of the multi-pollutant control system over technologies that have conventionally been applied to smaller coal-fired units, are identified and discussed in the subsections below.

3.2.1 Deep Emission Reductions

Conventional low-capital-cost air pollution control options for smaller coal-fired units, such as low-NO_x burners or stand-alone SNCR to reduce NO_x emissions and combustion of low-sulfur coal or use of sorbent injection in the furnace or ductwork to limit SO₂ emissions, in most cases do not produce emission rates consistent with the low levels established in environmental regulations that recently have been promulgated or proposed. Hence, units employing these options are increasingly vulnerable to highly volatile allowance costs or even retirement as new regulations are enacted. Thus, it was essential that the Greenidge multi-pollutant control process be designed to achieve deeper emissions reductions than these conventional low-capital-cost options and to meet or exceed applicable state and federal regulatory requirements for air emissions.

The process being demonstrated at AES Greenidge is well suited for achieving NO_x emission reductions of about 50-75%, compared with the 20-35% reduction typically achievable by SNCR (Pfaff and Abrams, 2006). It also is designed to achieve greater than 95% removal of SO₂, comparable to the 95-98% removals characteristic of today's best available wet scrubbing technologies for larger coal-fired units (DePriest and Gaikkwad, 2003). Both NO_x and SO₂ are regulated under CAIR. Furthermore, the multi-pollutant control system is designed to achieve greater than 90% capture of mercury, which is regulated under CAMR and is a topic of many state environmental actions, and to reduce emissions of SO₃, HCl, and HF by at least 95%. SO₃, HCl, and HF contribute to the formation of acid aerosols, and emissions of these compounds must be reported to the U.S. Environmental Protection Agency (EPA) as part of the national Toxics Release Inventory (TRI) program. Elevated concentrations of SO₃ in flue gas can also result in the formation of visible emissions (i.e., "blue plumes"), which are often particularly problematic for coal-fired power plants with SCR systems because SO₃ can be generated by oxidation of SO₂ across the SCR catalyst. Although the Greenidge multi-pollutant control process includes an SCR reactor, the downstream circulating fluidized bed dry scrubber is designed for deep SO₃ removal, eliminating the potential for plume visibility problems due to SO₃. Finally, as discussed above, for plants currently using an ESP to control particulate matter emissions, installation of the circulating fluidized bed dry scrubber and baghouse is expected to afford a substantial improvement in PM control, especially for fine particles.

3.2.2 Low Capital Costs

There are commercially-available conventional technologies, such as full-scale SCR systems and limestone forced oxidation wet scrubbers, that are capable of achieving or exceeding the deep emissions reductions targeted for the Greenidge multi-pollutant control process. However, operators of smaller coal-fired EGUs, which are penalized by economies of scale, often cannot afford the large capital costs associated with these technologies. Hence, the multi-pollutant

control process being demonstrated at AES Greenidge was designed to achieve deep emission reductions while offering substantially reduced capital costs compared to these conventional state-of-the-art technologies.

By using a compact, single-bed SCR reactor that is installed in a modified section of ductwork between the unit's economizer and air heater, the hybrid SNCR/SCR system avoids many of the capital costs associated with the multi-bed reactor, structural support steel, foundations, and new ductwork runs required for a conventional stand-alone SCR system. Also, unlike wet FGD systems, the Turbosorp[®] system does not produce saturated flue gas, and therefore is constructed from carbon steel rather than from the expensive corrosion-resistant materials required for wet scrubbers. For the same reason, use of the Turbosorp[®] system also does not entail the installation of a new corrosion-resistant stack, which is commonly required for wet scrubber retrofits. Because of these factors, as well as the mechanical simplicity of the Turbosorp[®] system relative to wet scrubbers, the capital cost of the multi-pollutant control process being demonstrated at AES Greenidge is projected to be about 40% less than the capital cost of a conventional system comprising a stand-alone SCR and wet limestone forced oxidation scrubber (with new corrosion-resistant stack) for a 110 MW_e unit.

In exchange for its substantially reduced capital costs, the Greenidge multi-pollutant control system has higher variable operating costs (because of its lower reagent utilization and its use of more expensive urea and lime reagents rather than the ammonia and limestone reagents commonly used in stand-alone SCR and wet scrubber systems, respectively) and lower NO_x removal efficiency (SCRs are capable of achieving 80-90% or greater NO_x reduction) relative to a conventional stand-alone SCR / wet FGD system. Whereas this tradeoff may be unattractive for large coal-fired EGUs, it is consistent with the needs of smaller units, which in many cases cannot justify or afford the large capital costs (per unit of electrical output) needed to retrofit with conventional technologies for deep emissions reductions.

3.2.3 Small Space Requirements

The relatively large amount of space required to install conventional SCR and wet FGD systems further prevents these technologies from being widely applied to smaller coal-fired EGUs. Many smaller coal-fired units do not have sufficient physical space to easily accommodate both an SCR and wet scrubber; this increases the difficulty, and hence the capital cost, of retrofitting these technologies. Therefore, an objective in designing the Greenidge multi-pollutant control system was to minimize its required footprint.

The SNCR portion of the multi-pollutant control process requires only a small amount of space for a urea storage tank, small shed containing a urea circulation module, and several small urea distribution skids located around the boiler. Unlike a conventional stand-alone SCR reactor, the single bed SCR reactor requires essentially no new land area, as it is installed in a modified ductwork section between the economizer and air heater and needs only a few new support beams. The arrangement of the circulating fluidized bed dry scrubber, baghouse, and associated equipment is also compact. The various pieces of equipment are vertically tiered to permit gravity-assisted transport of solids where possible, and as a result, require less than 0.5 acre of land for a 110 MW_e installation. The layout of the multi-pollutant control system for the Greenidge Unit 4 installation is discussed in greater detail in Section 4.3.2 of this report.

3.2.4 Applicability to High-Sulfur Coals

As discussed in the Introduction, greater than 80% of the coal-fired units that are candidates for the multi-pollutant control process being demonstrated at AES Greenidge are located east of the Mississippi River, where high-sulfur eastern U.S. bituminous coal is a candidate fuel source. The dispatch economics of these units improve significantly with the installation of low-cost SO₂ removal systems that allow the use of higher-Btu, higher-sulfur, less-expensive coals with a net reduction in SO₂ emissions and a corresponding reduction in the need for high-cost allowances. Hence, an important design objective for the Greenidge multi-pollutant control system was that it be able to achieve deep SO₂ emission reductions when applied to units firing high-sulfur (i.e., >2%-sulfur) coals.

Lime spray dryers provide a relatively low-capital-cost means for achieving deep reductions in SO₂ emissions, as does the Turbosorp[®] circulating fluidized bed dry scrubber being installed as part of the multi-pollutant control process at AES Greenidge. However, spray dryers are only capable of achieving these deep reductions (i.e., >90%) when applied to units that fire coals with sulfur contents of about 2% or less. In spray dryer systems, lime and water are injected into the absorber vessel together as a slurry, rather than separately as in the Turbosorp[®] system. As a result, flue gases with high SO₂ concentrations require slurry injection rates so great that the water in the slurry cannot be completely evaporated. This causes plugging and binding of the bags used in the downstream fabric filter, as well as plugging of discharge feeders and conveyers. As discussed in Section 3.1.2 above, in the Turbosorp[®] system, water injection and hydrated lime injection are carried out separately, such that the Ca(OH)₂ injection rate is controlled solely by the pollutant loading and desired emission reduction, without being limited by the temperature or moisture content of the flue gas. As a result, the Turbosorp[®] can be operated to achieve deep emission reductions for a wide range of fuels, including high-sulfur coals.

3.2.5 Low Maintenance Requirements

Insofar as the PPII seeks to improve the reliability of the nation's energy supply, minimization of maintenance requirements was an objective in the design of the Greenidge multi-pollutant control system, such that system maintenance will not adversely affect unit availability. A drawback of both wet scrubbers and lime spray dryers is their use of slurries to introduce the limestone or lime into the system, resulting in high maintenance requirements and potential for operational problems. Problems arising from the use of slurries can include pipe plugging, nozzle plugging, solids build-up, and erosion and abrasion of pumps, pipes, and vessels. Wet scrubbers in particular are relatively complex, as they produce a slurry product and require pumps for slurry recirculation as well as maintenance-intensive dewatering equipment.

The Turbosorp[®] circulating fluidized bed dry scrubber being installed as part of the Greenidge multi-pollutant control system is expected to afford substantially reduced maintenance requirements compared to these more conventional FGD technologies. In the Turbosorp[®] process, lime is injected into the absorber as a dry hydrate rather than as a slurry. A blower is used to pneumatically convey the dry hydrated lime to the absorber for injection. The solids collected in the baghouse are also completely dry and are recycled to the absorber using airslides. Gravity provides the motive force for injection via the differential height between the bottom of the baghouse and the injection point on the absorber tower. Apart from the lime hydration system, the system's only pump is used to inject liquid water into the absorber vessel. Hence, the process avoids the problems with plugging, erosion, abrasion, and scaling that can result from pumping and handling slurries in other types of scrubbing systems. The Turbosorp[®]

system also includes comparatively few moving parts, and as implied in Section 3.2.4, is less likely to cause plugging and binding of fabric filter bags than a spray dryer is.

3.2.6 Operational Flexibility

Unlike larger baseload units, many smaller coal-fired EGUs routinely cycle their loads in response to electricity demand. Hence, a multi-pollutant control system designed for these smaller units should feature turndown capabilities to permit continued emissions reductions at reduced operating loads. The design of the multi-pollutant control system being demonstrated at AES Greenidge includes these capabilities.

For conventional SCR systems, low-load operation is constrained by reduced flue gas temperatures, which can cause incomplete ammonia consumption across the SCR catalyst, resulting in high ammonia slip and ammonium bisulfate fouling in the air heater (see Section 3.3.1). At sufficiently low temperatures, catalyst plugging and deactivation can also occur via the formation of salts in the SCR reactor. These constraints are particularly stringent for units that fire high-sulfur coals. Stand-alone SCR installations typically employ an economizer gas bypass and/or water flow circuit modifications to raise the flue gas temperature at the SCR inlet during low-load operation. However, because of the hybrid NO_x control strategy included as part of the Greenidge multi-pollutant control process, NO_x removal capabilities are available to some extent at lower operating loads without the need for any such modifications. The operating strategy for the hybrid system is shown conceptually in Figure 7.

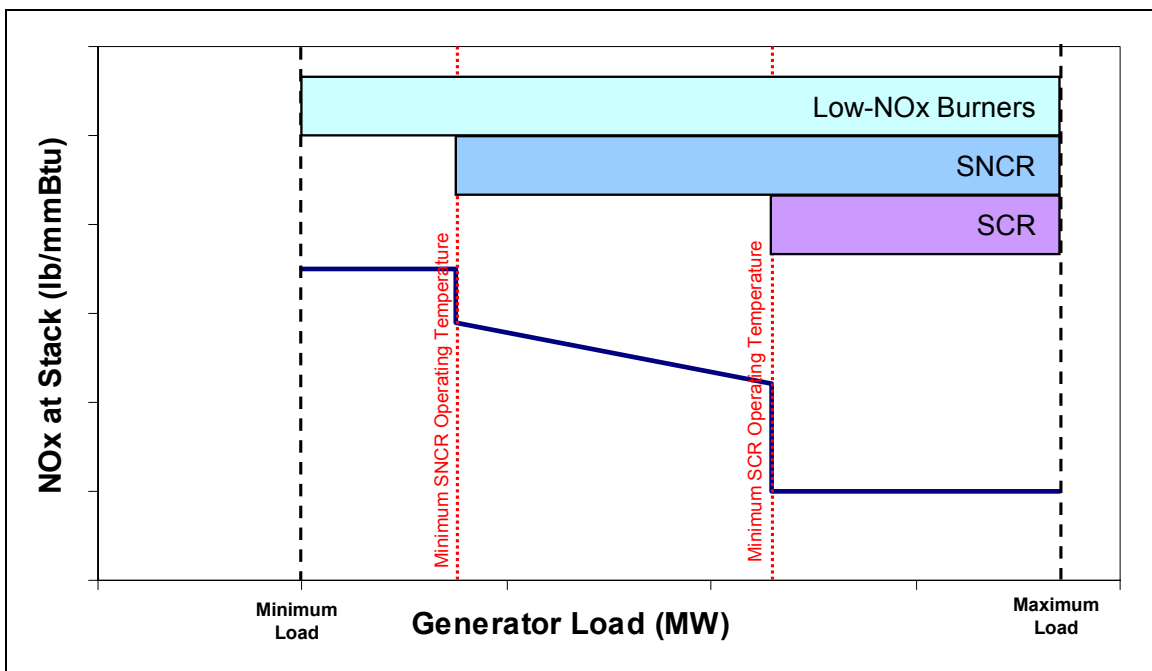

Figure 7. Operating strategy for the hybrid NO_x control system being demonstrated at AES Greenidge.

As illustrated in the figure, operation of the system varies with generator load, resulting in three distinct operating ranges: a high-load range in which NO_x reduction is accomplished via SCR, SNCR, and low-NO_x burners (if applicable); an intermediate-load range in which NO_x reduction is accomplished via SNCR and low-NO_x burners (but not SCR), and a low-load range in which NO_x reduction is accomplished via low-NO_x burners (but not SCR or SNCR). At generator loads

that produce economizer outlet temperatures below the minimum operating temperature for the SCR reactor, urea injection into the upper region of the furnace, which is used to generate ammonia slip for the SCR, is discontinued. However, the lower zones of urea injection continue to operate until the minimum SNCR operating temperature is reached, resulting in continued NO_x removal via SNCR. Below the minimum SNCR operating temperature, which is the minimum economizer outlet temperature at which it is safe to introduce very small amounts of ammonia into the SCR catalyst, urea injection into the furnace is discontinued. However, NO_x emissions may continue to be controlled via the unit's low-NO_x combustion system, if applicable. Hence, for smaller units that regularly cycle loads based upon peak and off-peak demands, the load following capabilities of the hybrid SNCR/SCR process can help to contribute to lower NO_x emission averages.

The circulating fluidized bed dry scrubber is also capable of operating at reduced loads when installed with a flue gas recycle system. As discussed in Section 3.1.2, flue gas recycle is required at low loads to provide sufficient flow to the absorber so that a fluidized bed can be maintained.

3.3 Design Considerations

In addition to the larger design objectives discussed above and the obvious objectives established by the particular emission reduction needs of a candidate unit, a number of site- and application-specific factors affect the design of the multi-pollutant control process that is being demonstrated on AES Greenidge Unit 4. Important design considerations for the process are discussed in the following subsections.

3.3.1 Coal and Ash Characteristics

Characteristics of a candidate unit's coal (and other secondary fuels if applicable) and the fly ash produced by its combustion impact the design of many aspects of the multi-pollutant control system.

Certain elemental chemical components of the coal, including arsenic and alkali metals, can poison the SCR catalyst by reacting with its active sites, causing deactivation (Wu, 2002). For an in-duct SCR reactor, which includes a limited catalyst volume, catalyst deactivation can have a major, rapid impact on NO_x removal performance.

Coal sulfur content can also affect the operation of the hybrid NO_x control system. As mentioned in Section 3.2.1, the SCR catalyst promotes oxidation of a small percentage of SO₂ in the flue gas to SO₃, according to the following reaction:



This SO₃ can then react with Ca to form CaSO₄, which deactivates the catalyst by plugging its pores, or it can react with NH₃ at sufficiently low temperatures to form NH₄HSO₄ or (NH₄)₂SO₄ according to the reactions below, causing catalyst plugging or air heater fouling.



Hence, for mid- and high-sulfur coals, the SO₂-to-SO₃ conversion rate is an important consideration in the selection of an SCR catalyst.

The fly ash content of the flue gas must also be considered as part of the SCR system design, because greater ash loadings augment the potential for fly ash plugging, which causes catalyst deactivation and increased pressure drop. Thus, specification of a sonic horn system or other catalyst cleaning system is important to prevent deteriorations in SCR performance resulting from accumulation of fly ash in the catalyst.

For the circulating fluidized bed dry scrubber system, the coal sulfur content affects the amount of hydrated lime reagent required per mole of inlet SO₂ (i.e., the required Ca/S molar ratio) to achieve a given level of SO₂ removal. Although the Turbosorp[®] circulating fluidized bed dry scrubber is capable of achieving deep SO₂ emissions reductions across a wide range of coal sulfur contents, higher sulfur coals generally require greater Ca/S molar ratios than do lower sulfur coals for a given percentage of SO₂ removal.

Finally, the composition of the coal and fly ash can affect the mercury removal performance of the system. For example, as coal chlorine content increases, the percentage of mercury in the flue gas that is present as Hg²⁺ (e.g., HgCl₂) as opposed to Hg⁰ increases (CEA, 2005). Greater Hg²⁺ concentrations improve the potential for mercury removal as a co-benefit of the circulating fluidized bed dry scrubber and baghouse. This potential also increases as the amount of unburned carbon in the fly ash increases, because unburned carbon can adsorb gaseous mercury, especially at the low temperatures (Fenger and Winschel, 2006) afforded by the circulating fluidized bed dry scrubber, and can also serve as a mercury oxidation catalyst in the presence of sufficiently high chlorine concentrations (Niksa and Fujiwara, 2005; Presto and Granite, 2006). Hence, activated carbon injection requirements are dependent on coal and ash characteristics.

3.3.2 Baseline NO Concentration

The kinetics for NO_x reduction via SNCR are a function of the initial concentration of NO, one of the reactants in the process and one of the products of the high-temperature reactions involving oxidation of reagent to form NO. Hence, the amount of NO_x removal achievable in the SNCR process depends on the concentration of NO leaving the combustion system. Baseline NO concentrations vary considerably from unit-to-unit, as they are a function of factors such as fuel nitrogen content, fuel volatile matter content, flame temperature, and combustion zone stoichiometry and residence time.

3.3.3 Temperature Profile in the Furnace

As discussed in Section 3.1.1, the performance of SNCR depends strongly on the temperature at which the process operates. Hence, the temperature profile in the furnace, which is specific to each application, strongly influences the design of the urea injection strategy. Computational fluid dynamics (CFD) are used to model the furnace temperature profile at various loads, and chemical kinetic modeling (CKM) is used to simulate the effect of temperature on the SNCR reactions. Modeling results inform the design of the number, type, and placement of the urea injectors, as well as the urea injection strategy as a function of operating load.

3.3.4 Flue Gas Residence Time and Flow Profile in the Furnace

In order to optimize SNCR performance, a urea injection strategy must be developed that provides for thorough mixing of the reagent with the flue gas and sufficient residence time of urea and flue gas in the temperature regions of the furnace where the desired reactions between urea and NO occur. Reagent distribution and residence time are affected by the flue gas flow profile in the furnace. As with temperature, CFD and CKM are used to model the flow profile in the furnace and its effect on the SNCR reactions, and the results are used to inform the design of the urea injection strategy.

3.3.5 CO Concentrations in the Furnace

Carbon monoxide significantly impacts SNCR chemistry, with net effects of reducing ammonia slip, promoting the oxidation of reagent to form additional NO, and lowering the optimal temperature for NO reduction (Brouwer et al., 1996). Hence, local CO concentrations must be considered when modeling and designing the urea injection system.

3.3.6 Available Space Between the Economizer and Air Heater

The amount of incremental NO_x removal and ammonia slip control achievable by the SCR reactor is limited by the residence time of the flue gas in the catalyst. Residence time is the inverse of space velocity (flue gas volumetric flow rate ÷ catalyst volume), and for a given flue gas flow rate, it increases with increasing catalyst volume. For the in-duct SCR reactor that is part of the Greenidge multi-pollutant control system, the volume of catalyst that can be installed, and hence the level of NO_x removal that can be achieved via SCR, is restricted by the amount of available space between the candidate unit's economizer and air heater. For a given catalyst, oxidation of Hg, which is a desired co-benefit of SCR, and conversion of SO₂ to SO₃, which is undesired, are also expected to decrease with decreasing catalyst volume. The geometry between the economizer and air heater also affects the catalyst face velocities (flue gas volumetric flow rate ÷ catalyst cross-sectional area) that can be achieved. High and low face velocities can each present problems; high face velocities contribute to increased catalyst erosion, whereas low face velocities can lead to ash deposition within the catalyst. For the retrofit application of an in-duct SCR reactor, the reactor cross-sectional area is typically limited by unit geometry, resulting in face velocities that are greater than normal. The effects of these elevated face velocities must be considered as part of the catalyst and reactor designs.

3.3.7 Flue Gas Temperature at the Economizer Outlet

Catalyst activity is a function of temperature, and within the acceptable temperature window for SCR operation, the rate of NO_x removal increases as temperature increases. Hence, the catalyst specification and the amount of NO_x removal achievable in the single-bed in-duct SCR reactor both depend on a unit's economizer outlet temperature. Variations in this temperature with unit load are a primary factor in establishing the turndown ranges for the SCR and SNCR systems, as illustrated in Figure 7. Per the discussion in Section 3.2.6, an economizer bypass can be installed to increase the temperature of the flue gas entering the SCR at reduced operating loads, increasing its turndown capability; however, the potential benefits afforded by this option must be weighed against its resultant effects on cost and operating complexity, and it was not selected for this project.

3.3.8 Flue Gas Homogeneity at the SCR Inlet

As discussed in Section 3.1.1, in order to maximize performance of the relatively small in-duct SCR reactor, it is essential that the temperature, composition, and velocity of the flue gas are homogeneous across the cross-sectional area of the catalyst. Localized deviations in composition (i.e., NH_3/NO_x mole ratio) or temperature from target values can result in decreased NO_x removal efficiency and increased ammonia slip, and localized deviations in velocity from target values can result in catalyst erosion or ash deposition. Hence, static mixers are used to homogenize the flue gas upstream of the in-duct SCR reactor. Because flue gas flows are unique to each candidate unit, physical flow modeling must be performed on a case-by-case basis to optimize the design of the static mixing system.

3.3.9 Amount of Allowable Ammonia Slip

In spite of its use of an in-duct SCR reactor to consume ammonia slip from the SNCR process, the design of the hybrid SNCR/SCR system is nevertheless constrained to some extent by ammonia slip. Obviously, the design level of ammonia slip from the SNCR process can be no greater than the sum of the amount of ammonia consumed in the SCR reactor and the amount of allowable ammonia slip from the overall hybrid system. As the SCR catalyst deactivates, its capacity to consume ammonia decreases; hence, limits on ammonia slip constrain the useful operating life of the catalyst. Moreover, at operating loads below the minimum SCR operating load, limits on ammonia slip restrict SNCR operation, resulting in less-than-optimal urea utilization and NO_x removal. Constraints on ammonia slip typically become more stringent as coal sulfur content increases, because the resultant greater concentrations of SO_3 in the flue gas provide a greater driving force for the formation of ammonium bisulfate (NH_4HSO_4) from any ammonia that is present. For units firing lower-sulfur coals, constraints may be also imposed by regulatory limits on NH_3 emissions or concerns about NH_3 contamination of the baghouse solids, which makes disposal or use of these solids more difficult.

3.3.10 Approach to Adiabatic Saturation in the Absorber Vessel

In addition to its dependence on the concentration of SO_2 in the flue gas, the Ca/S molar ratio required to achieve a given level of SO_2 removal in the circulating fluidized bed dry scrubber depends on the proximity of the temperature in the absorber vessel to the adiabatic saturation temperature of the flue gas. In general, for a given $\text{Ca}(\text{OH})_2$ injection rate, SO_2 removal efficiencies improve as the operating temperature approaches the adiabatic saturation temperature. However, the approach to adiabatic saturation is limited by concerns about condensation, which can cause corrosion, deposition of solids in the absorber, binding and plugging of baghouse bags, and problems with the solids recirculation system. Hence, the absorber operating temperature must be carefully selected to maximize SO_2 removal efficiency while avoiding any potential for condensation. Also, because the circulating fluidized bed dry scrubber system operates at temperatures near the adiabatic saturation temperature of the flue gas, thorough insulation of the system is important, especially in colder climates, in order to minimize the potential for condensation.

3.3.11 Increased Solids Loading to the Baghouse

Because a large portion of the solids that are removed from the flue gas in the baghouse are recycled back to the Turbosorp[®] absorber vessel, the particle loading in the flue gas that is sent to the baghouse from the absorber vessel is substantially greater than it would have been with no circulating fluidized bed dry scrubber installed. As a result, the baghouse must be designed

to accommodate this increased particle loading. Design modifications may include reducing the air-to-cloth ratio (i.e., ft^3/min flue gas \div ft^2 bag surface area), increasing the bag spacing, and increasing the baghouse inlet volume and depth of the drop-out zone beneath the bags.

The substantially increased particle loading resulting from solids recirculation is one reason why a unit's existing particulate control device typically cannot be used for PM removal in a circulating fluidized bed dry scrubber installation. Conceptually, a new ESP could be used instead of a new baghouse; however, baghouses are preferred because the coating of sorbent material (and fly ash) that accumulates on their filter bags promotes additional removal of SO_2 , acid gases, and mercury downstream of the absorber vessel, improving reagent utilization and overall pollutant removal efficiency.

3.3.12 Pressure Drop Across the System

Addition of the static mixing devices, in-duct SCR catalyst, fluidized bed absorber, and baghouse causes increased flue gas pressure drop. Hence, most applications of systems like the Greenidge multi-pollutant control system will require installation of a booster fan and/or modifications to the unit's existing ID fans to overcome this pressure drop. The amount of pressure drop and required modifications depend upon flue gas flow rate, equipment sizing and design, and existing ID fan capacity, and must be assessed on a case-by-case basis. The effect of increased pressure drop on the operating costs of the system must be considered as part of the design.

3.4 Project Uniqueness and Uncertainties

All of the technologies to be demonstrated as part of the Greenidge Multi-Pollutant Control Project have been developed and tested individually at a sufficient scale to provide an adequate level of confidence concerning their mechanical operability as proposed in the project. However, the Greenidge Project is unique in that it represents the first application in which a hybrid SNCR/SCR system and a circulating fluidized bed dry scrubber system have been combined to form an integrated multi-pollutant control system, as well as the first application of either of these technologies to a unit firing $>2\%$ -sulfur eastern U.S. bituminous coal.

The Turbosorp[®] circulating fluidized bed dry scrubber has been applied to four European coal-fired power plants but has not been demonstrated on a coal-fired EGU in the United States. Table 1 shows design targets for these European installations, as well as design capabilities for the Greenidge installation. As these data indicate, the Turbosorp[®] unit at AES Greenidge is being designed for a greater flue gas SO_2 concentration and greater level of SO_2 removal than any existing installation. Circulating fluidized bed dry scrubbers similar to the Turbosorp[®] have been installed on two smaller coal-fired EGUs in the United States; however, both of these units fire less than 2% -sulfur coal and are less than 100 MW_e in size.

The hybrid SNCR/SCR system has been tested on the equivalent of 80 MW_e of flue gas from the PSE&G Mercer Unit 2, which fired coal with a sulfur content of less than 1% . The SCR configuration involved horizontal flow through two 5-foot-thick banks of plate catalyst. Relative to operation using only SNCR, the hybrid SNCR/SCR system improved overall NO_x reduction from 37% to 71% and overall urea utilization from 31% to 62% (for a constant urea feed rate) at full load, with less than 10 ppm of ammonia slip (Albanese et al., 1995). Hybrid SNCR/SCR was also demonstrated at commercial-scale on the former 147 MW_e GPU Generation Seward Unit 5, which fired bituminous coal containing about 1.5% sulfur. The system was designed to

achieve 55% NO_x reduction from a baseline of about 0.78 lb/MMBtu, with the in-duct SCR contributing about 6% reduction at full load. The demonstration confirmed the feasibility of the hybrid SNCR/SCR concept, but its performance was limited by temperature stratification in the SCR and arsenic poisoning of the catalyst (Urbas, 1999). Hence, the Greenidge demonstration marks the greatest targeted NO_x removal efficiency for a commercial-scale hybrid SNCR/SCR system on a coal-fired boiler in the United States, as well as the first application of the hybrid system to a unit firing >2%-sulfur eastern U.S. bituminous coal.

Table 1. Characteristics of existing Turbosorp[®] installations and of the Greenidge design.

Plant	Country	Coal Type	Flue gas flow rate [m ³ /h] ^a	Approx. SO ₂ concentr. [mg/m ³] ^b	SO ₂ removal efficiency [%]	Approx. HCl concentr. [mg/m ³] ^b	HCl removal efficiency [%]	Date of start-up
Kraftwerk Zeltweg	Austria	lignite / bituminous	600,000	2,300	91	100	> 90	1994
Kraftwerk St. Andrä	Austria	lignite / bituminous	450,000	2,500	92	100	> 90	1994
Heiz-KW Strakonice	Czech Republic	lignite	261,000	4,200	85	30	> 75	1999
REA Siekierki	Poland	bituminous	250,000	3,300	85	250	> 95	2002
AES Greenidge	USA	bituminous	450,000	5,000	95	100	> 95	2007

^aAt standard temperature and pressure, wet; ^bAt standard temperature and pressure, dry

Thus, the principal uncertainties, and the motivation for the Greenidge Multi-Pollutant Control Project, include the performance of the hybrid SNCR/SCR and Turbosorp[®] systems when combined in an integrated multi-pollutant control process, as well as the technical and economic performance of these systems when applied with ambitious performance targets to a unit firing eastern U.S. bituminous coals containing greater than 2% sulfur. Specific uncertainties include:

- Control and performance of the combined combustion modifications, SNCR, and in-duct SCR, especially during load swings/cycling
- Catalyst activity, life, and replacement cost for an in-duct single catalyst bed installed on a unit firing greater than 2%-sulfur eastern U.S. bituminous coal
- Effect of biomass co-firing on catalyst life and performance
- Effect of ammonia slip from the hybrid SNCR/SCR on unit operability for a unit firing greater than 2%-sulfur coal
- Extent of Hg oxidation at high space velocities across the single catalyst bed and its effect on Hg removal performance
- SO₂ capture and required Ca/S ratio in the Turbosorp[®] for a high-sulfur U.S. bituminous coal
- Amount of Hg removal achievable in the Turbosorp[®] system and required carbon/mercury ratio
- SO₃, HCl, and HF removal as a function of SO₂ control conditions
- Effect of biomass co-firing on Hg and acid gas removal
- Effects of ammonia slip and carbon injection on solid waste management
- Economics of the combined system for a relatively small (~110 MW_e) unit firing greater than 2%-sulfur eastern U.S. bituminous coal

The goal of the Greenidge Project's testing program is to resolve these uncertainties so that the technical and economic viability of the integrated multi-pollutant control process for smaller coal-fired units can be proven.

4. System Design for AES Greenidge Unit 4

Having discussed the general concepts, objectives, design considerations, and uncertainties associated with the multi-pollutant control process in the preceding section, this section focuses specifically on the system design for the AES Greenidge Unit 4 application.

Process flow diagrams including mass and energy balance data for major process streams at design load (drawing No. 100276-SK081706-05) and at low load (drawing No. 100276-SK101206-03) are included in Appendix A. Appendix B presents a list of the major equipment items required for the system. General arrangement drawings are provided in Appendix C. The design is described in the subsections below.

4.1 Design Basis

As discussed in Section 2.2, the multi-pollutant control system at AES Greenidge Unit 4 is designed to operate effectively while the unit fires eastern U.S. bituminous coals containing 2-4% sulfur and co-fires waste wood at 0-10% of the heat input to the furnace. The design case is based on the use of a 2.9%-sulfur coal with 10% biomass co-firing at the unit's maximum continuous rating (MCR). Design fuel characteristics are summarized in Table 2.

Table 2. Assumed fuel characteristics (as fired) for the design case.

	Coal	Wood
Higher Heating Value (Btu/lb)	13,097	8,592
Carbon (% w/w)	72.17	45.13
Hydrogen (% w/w)	4.79	5.78
Nitrogen (% w/w)	1.36	2.8
Chlorine (% w/w)	0.1	0.22
Sulfur (% w/w)	2.9	0.2
Oxygen (% w/w)	5.04	38.72
Moisture (% w/w)	5.8	6.3
Ash (% w/w)	7.85	0.82

The assumed chemical compositions of the quicklime and activated carbon reagents to be used by the process are summarized in the stream tables provided with the process flow diagrams in Appendix A. The NO_xOUT[®] reagent used by the SNCR process is an aqueous solution containing approximately 50% (w/w) urea, as well as additives to prevent scaling and corrosion.

Table 3 lists the emission performance targets for the design case. The targeted NO_x emission rate of ≤0.10 lb/MMBtu at full load represents a NO_x removal efficiency by the combined combustion modifications, SNCR, and in-duct SCR of ≥67% relative to a pre-installation baseline NO_x emission rate of approximately 0.30 lb/MMBtu at full load, or a removal efficiency by the hybrid SNCR/SCR system of ≥60% relative to the targeted rate of 0.25 lb/MMBtu leaving the new combustion system.

Table 3. Emission performance targets for the design case.

Parameter	Design Target
NO _x	≤ 0.10 lb/MMBtu (full load)
NH ₃	≤ 2 ppmvd @ 3% O ₂ (air heater inlet)
SO ₂	≥ 95% removal
SO ₃	≥ 95% removal
HCl	≥ 95% removal
HF	≥ 95% removal
Hg	≥ 90% removal
Opacity	≤ 20%

4.2 Description by Major Process Component

Major components of the multi-pollutant control process being demonstrated at AES Greenidge include a selective non-catalytic reduction system, in-duct selective catalytic reduction reactor, activated carbon injection system, Turbosorp[®] scrubber, process water system, lime hydration and injection system, baghouse, ash recirculation system, and booster fan.

4.2.1 Selective Non-Catalytic Reduction System

The urea-based SNCR system, which is being supplied by Fuel-Tech, will operate synergistically with the in-duct SCR reactor to reduce NO_x emissions from AES Greenidge Unit 4. At full load operation, the SNCR system is designed to reduce NO_x by about 42%, from 0.25 lb/MMBtu (190 ppmvd, corrected to 3% O₂) leaving the combustion zone to 0.144 lb/MMBtu (110 ppmvd, corrected to 3% O₂) at the economizer outlet, and to supply a controlled amount of ammonia slip (~47 ppmvd, corrected to 3% O₂) as a feed to the downstream in-duct SCR reactor to permit additional NO_x reduction there. Per the discussion in Section 3.2.6, for gross generator loads below about 86 MW_e, which produce economizer outlet temperatures below the minimum SCR operating temperature of 600°F, the SNCR is designed to reduce NO_x emissions by 20-25% while producing less than 2 ppmvd of ammonia slip. Because of concerns about formation of ammonium salts in the SCR catalyst, SNCR operation will be discontinued when the economizer outlet temperature is less than 528°F, which occurs when the gross generator load falls below about 54 MW_e.

The SNCR system design includes three separate zones of urea injection into the boiler. In Zones 1 and 2, diluted urea reagent is injected via air-cooled wall injectors installed through penetrations in the waterwall. The Zone 1 injectors, which are located closest to the combustion zone, are mounted on retract mechanisms that allow them to be withdrawn from the furnace when not in use, preventing damage that could otherwise result from high furnace temperatures. In Zone 3, diluted urea reagent is injected through two 14-15 ft, retractable multiple nozzle lances (MNLs) into the superheater section. The MNLs are cooled using plant condensate water. Because SNCR performance depends strongly on temperature and reagent distribution, as discussed in Sections 3.3.3 and 3.3.4, the optimal placement and spray patterns for injectors and lances were determined based on CFD and CKM results. The use of multiple urea injection zones is necessary to ensure thorough coverage of the reagent throughout the flue gas and to allow injection of urea into different temperature regions of the furnace, which is critical to the load-following capabilities of the hybrid SNCR/SCR system. At high load, when greater levels of ammonia slip are desired to feed the in-duct SCR reactor, urea can be injected into lower

temperature regions of the furnace (i.e., by using the Zone 2 injectors and Zone 3 MNLs) that promote greater NO_x removal via SNCR and greater ammonia slip. At reduced loads, however, when ammonia slip from the SNCR is limited to <2 ppmvd, urea injection is restricted to higher temperature regions of the furnace (i.e., by using only the Zone 1 injectors).

The liquid, urea-based NOxOUT[®] reagent used by the SNCR process is delivered to site via tank truck and stored in a 15,000-gallon, fiberglass reinforced plastic tank. The capacity is sufficient to store enough urea solution for 8-9 days of SNCR operation at full load. The tank is heated and insulated to maintain its temperature above 80°F in order to prevent the urea from crystallizing and precipitating out of the solution, and it is installed on a curbed concrete foundation for spill containment.

A high flow delivery (HFD) module is used to supply filtered urea-based reagent from the storage tank to the process. The HFD module includes two 100% capacity, 5-hp centrifugal pumps (Pump 1A and Pump 1B in drawing No. 100276-SK081706-05) to circulate the urea solution and provide it to the injector zone metering (IZM) module, the next step in the urea injection process. The HFD module is contained in a heated enclosure located next to the urea storage tank; all piping interconnecting the SNCR system components is heat traced and insulated to prevent urea crystallization.

Upon entering the IZM module, which is skid-mounted and installed inside the boiler building, the urea solution is diluted with water and distributed to the SNCR system's three injection zones. Dilution water is pressurized and provided to the IZM module by a dilution water pressure control module consisting of a pair of 5-hp, skid-mounted stainless steel pumps. The IZM module consists of pressure and flow control valves that independently meter the flow and concentration of urea solution sent to each injection zone. Four distribution modules, including two for Zone 1, one for Zone 2, and one for Zone 3 (the MNLs), are then used to meter the flow of diluted urea reagent and atomizing air to the individual injectors in response to the demands of the system.

Urea injection by the SNCR system is controlled automatically based on the boiler load, furnace temperature, and NO_x emission rate at the stack. The primary control loop utilizes a feedforward boiler steam flowrate signal, which is fine-tuned as needed using the furnace temperature (measured using an optical gas temperature monitor supplied with the SNCR system). A feedback control loop is used to trim the SNCR system operation to achieve the desired NO_x emission rate, which is measured by the stack continuous emission monitor (CEM).

4.2.2 In-Duct Selective Catalytic Reduction Reactor

Following the SNCR process, the flue gas flows to the in-duct SCR reactor, which is designed to further reduce NO_x emissions from AES Greenidge Unit 4 to ≤0.10 lb/MMBtu (≤76 ppmvd, corrected to 3% O₂), with ≤2 ppmvd (corrected to 3% O₂) of ammonia slip, when the unit is operating at high load. All ammonia reagent required for NO_x reduction across the SCR catalyst is generated by the upstream SNCR process; hence, ammonia storage and injection systems are not required. As discussed in Section 4.2.1, the minimum operating temperature for the SCR catalyst is 600°F. Because the SCR design for AES Greenidge does not include an SCR bypass, flue gas continues to flow through the catalyst even when temperatures are below this value. However, the amount of ammonia fed to the SCR reactor by the upstream SNCR process is restricted to ≤2 ppmvd for economizer outlet temperatures between 528°F and 600°F, and it is restricted to zero (i.e., SNCR operation is discontinued) for economizer outlet

temperatures below 528°F, to prevent problems that could otherwise result from ammonia slip and ammonium bisulfate formation.

Per the discussion in Section 3.3.6, the size of the in-duct SCR reactor, and hence the amount of catalyst that can be installed to effect NO_x removal, is constrained by the available space in the plant between the economizer outlet and the air heater inlet. As shown in drawings 100276-GA200-00, 100276-GA100-00, and 100276-GA101-00 in Appendix C, the SCR system for AES Greenidge Unit 4 is designed to fit within the existing boiler building in a space with horizontal dimensions of 52' x 27' 2" and a vertical height of 23' 1/2". The design must account for an 8' 4-1/16" offset between the center of the economizer outlet and the center of the air heater inlet. This geometry allows for the installation of a single layer of catalyst in a reactor with a horizontal cross section measuring 45' x 14'. The flue gas flows vertically downward through the reactor, which is designed to accommodate a volumetric flow rate of about 490,000 acfm at full load.

The catalyst bed is 1330 mm (4.36 ft) deep and consists of 26 modules of honeycomb catalyst (Cormetech) in a 13 x 2 arrangement. The catalyst specified for AES Greenidge Unit 4 is a titanium/tungsten-based material that is formulated to provide ≥31% NO_x removal efficiency, ≤2 ppmvd NH₃ slip, and <1.0% SO₂-to-SO₃ conversion over a 3-year operating life.

In addition to the SCR catalyst and new reactor ductwork, the SCR system includes Delta Wing™ static mixers, a sonic horn system, and a catalyst loading facility. Delta Wing™ static mixers are used by Riley Power Inc., a Babcock Power Inc. company, in domestic SCR installations under an exclusive license from Balcke-Durr, GmbH. The previous demonstration of in-duct SCR at GPU Generation Seward Unit 5 highlighted the importance of achieving uniform distributions of temperature, velocity, composition, and fly ash loading across the reactor cross section (Urbas, 1999) in order to maximize NO_x reduction, minimize NH₃ slip and ammonium bisulfate formation, and prevent fly ash plugging. Given these results, the in-duct SCR design for AES Greenidge Unit 4 includes a carefully designed system of Delta Wing™ static mixers to homogenize the flue gas before it enters the SCR reactor, promoting such uniform distributions. The number, size, and orientation of the static mixers were determined on the basis of physical flow modeling, which was conducted by Ruscheweyh Consult GmbH using the physical model shown in Figure 8. The four sonic horns are used to prevent ash buildup on top of the SCR catalyst. The catalyst loading facility is used for manual replacement of deactivated catalyst modules with new modules at the end of the catalyst's useful operating life. It includes a 2-ton electric hoist for raising and lowering catalyst modules to the loading platform, as well as a manual hoist, trolley, and catalyst loading cart for moving modules between the loading platform and the reactor.

4.2.3 Activated Carbon Injection System

Powdered activated carbon (PAC) is injected into the flue gas downstream of the air heaters, before the Turbosorp® absorber vessel, to adsorb mercury. As discussed in Section 3.1.3, activated carbon injection is part of an overall mercury control strategy that also includes co-benefits afforded by the in-duct SCR, circulating fluidized bed dry scrubber, and baghouse. Very effective utilization of the activated carbon and high mercury capture are expected to result from the large solids recycle ratio, long residence time, and low temperatures provided by the circulating fluidized bed and baghouse. The activated carbon injection system is designed to inject 89.3 lb/h of PAC at full load, which corresponds to an injection rate of 3.5 lb PAC / MMacf flue gas; however, the required PAC injection rate for 90% Hg capture (coal-to-stack) is expected to be lower than this and will be determined by parametric testing once the system is operational.



Figure 8. Photograph of the physical flow model used to design the in-duct SCR for AES Greenidge Unit 4 (courtesy of Ruscheweyh Consult GmbH).

The activated carbon injection system includes a PAC storage silo and a PAC feed system. The 750-ft³ storage silo discharges to a feed hopper, from which PAC is metered to an eductor. An 80 scfm blower is used to convey the PAC to the duct for injection through a single port. The PAC injection rate is controlled based on the flue gas flow rate measured at the stack.

4.2.4 Turbosorp® Circulating Fluidized Bed Dry Scrubber

The flue gas next flows to the Turbosorp® circulating fluidized bed dry scrubber system, which is designed to remove ≥95% of the SO₂, SO₃, HCl, and HF contained in the flue gas when the unit is firing the design fuel.

The Turbosorp® scrubber at AES Greenidge Unit 4 includes a single absorber vessel that is constructed from carbon steel. The vessel, which is 105' 9-1/2" tall, consists of a multiple venturi inlet section and a cylindrical reaction chamber with a diameter of 23' 9-1/2". The reactor is designed to treat 277,807 scfm (423,700 acfm) of incoming flue gas at ~300°F. At the inlet of the absorber vessel, the flue gas passes through a horizontal duct and a 90° turn in the gas path (a hopper collects any ash that falls out of the gas at this bend). Once flowing in the vertical direction, the flue gas passes through a group of venturi nozzles, which accelerate the gas just prior to the injection of water, hydrated lime, and recycled solids, thereby supporting the fluidized bed in the reaction chamber above. The entire vessel is thoroughly insulated to prevent condensation, per the discussion in Section 3.3.10.

The lime hydration and injection system, process water system, baghouse, and ash recirculation system, which are described in subsequent sections, are integral parts of the circulating fluidized bed dry scrubber system. Dry hydrated lime reagent (containing ~95% w/w $\text{Ca}(\text{OH})_2$) is injected into the absorber at a rate of $\leq 8,623$ lb/h at full load to react with the SO_2 , SO_3 , HCl , and HF in the flue gas. (The Ca/S molar ratio for the design fuel is expected to be ~1.6, based on the number of moles of SO_2 entering the absorber). Water is separately injected to evaporatively cool the flue gas to ~162°F and to moisten the surfaces of the particles in the absorber, enhancing the capture of SO_2 , SO_3 , HCl , and HF . Finally, >95% of the solids captured in the baghouse are recycled to the absorber vessel via the ash recirculation system. These recycled solids enable a fast fluidized bed to be established in the absorber; the high recycle rate increases the hydrated lime utilization, helping to enable high SO_2 and acid gas removal efficiencies.

Major control loops for the Turbosorp® process are shown in Figure 9. The control strategy includes separate control loops for each of the three major process operations: hydrated lime injection, water injection, and solid product recycle. The hydrated lime injection rate is controlled on the basis of SO_2 concentrations measured at the Turbosorp® system inlet and at the stack. Inlet SO_2 concentrations are measured using a dilution extractive-type SO_2 analyzer installed between the air heater outlet and the Turbosorp® absorber inlet; stack SO_2 concentrations are measured using the plant's CEM. As inlet SO_2 concentrations increase, more hydrated lime is added to the Turbosorp® absorber. The hydrated lime injection rate is fine-tuned by a feedback control loop based on the stack SO_2 measurement. The temperature in the Turbosorp® absorber and the flue gas flow rate at the stack control the amount of cooling water injected into the absorber. The fluid bed density within the absorber (measured as the pressure drop across the absorber vessel) controls the amount of ash and scrubber reaction products that are recycled to the absorber vessel (and hence, the amount that are discharged from the system).

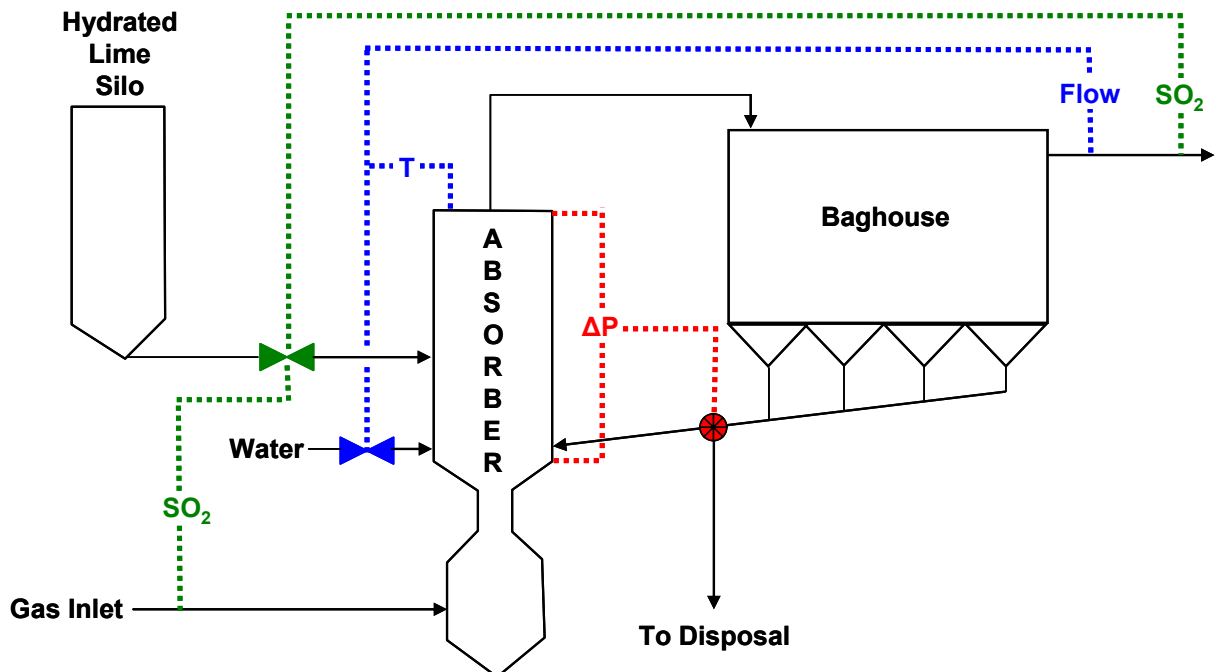

Figure 9. Process control schematic showing major control loops for the Turbosorp® circulating fluidized bed dry scrubber at AES Greenidge. Lime injection control is shown in green; water injection control is shown in blue, and solid product recycle control is shown in red.

The Turbosorp[®] system at AES Greenidge also includes a flue gas recycle stream to enable turndown for continued operation at low generator loads. The system is designed to achieve $\geq 95\%$ removal of SO₂, SO₃, HCl, and HF when the unit is operating at any point between its minimum load (42 MW_g) and full load. As shown in drawing No. 100276-SK101206-03 in Appendix A, at minimum load, 43,766 scfm of flue gas is recycled from the booster fan outlet to the absorber inlet, increasing the gas flow to the absorber vessel from 136,808 scfm to 180,574 scfm (250,239 acfm). This flue gas flow rate, which is 65% of the full-load flow rate of 277,807 scfm, is required to maintain a fluidized bed in the absorber vessel.

4.2.5 Process Water System

The process water system is designed to inject about 85 gpm into the Turbosorp[®] absorber vessel at full load operation. Process water from the plant is supplied to a 6,300-gallon heated storage tank. This water is then fed to the absorber vessel by a 150-gpm capacity, high-pressure centrifugal pump, and injected through a single lance. The pump and injection lance are provided in duplicate to ensure reliability.

4.2.6 Lime Storage, Hydration, and Injection System

Because of the high cost of directly purchasing hydrated lime for use in the Turbosorp[®] system, the multi-pollutant control system at AES Greenidge includes a dedicated outdoor lime hydration system to produce hydrated lime from quicklime (CaO). For AES Greenidge, the delivered cost of hydrated lime is more than 50% greater per mole of Ca than the delivered cost of quicklime. The lime hydration and injection system consists of a quicklime storage silo, commercially available lime hydration system, and hydrated lime storage silo and injection system.

Quicklime will be delivered to the AES Greenidge site by truck and pneumatically unloaded into a 7,500-ft³ storage silo. A weigh feeder is used to supply quicklime (~6,600 lb/h at design conditions) from the silo to the hydrator, where it is mixed with water (~8 gpm at design conditions) and agitated. The quicklime reacts exothermically with the water to form raw, dry hydrated lime. The original design included a wet scrubber to treat the hydrator exhaust (which includes air, steam, and lime dust) and a milk of lime circuit that was partially fed by the wet scrubber and was used to supply water to the hydrator. However, these components have since been removed from the process; the hydrator exhaust will be sent to the Turbosorp[®] scrubber rather than to a separate wet scrubber for cleaning, thereby simplifying the process and eliminating the potential need to treat and dispose of alkaline milk of lime overflow.

A bucket elevator is used to deliver the raw hydrated lime from the hydrator to an air classifier, which separates out coarse hydrated lime particles and sends them to a ball mill for grinding. About 3 gpm of water is required to cool the ball mill bearings. The ground hydrated lime leaving the ball mill is returned to the classifier. The hydrator, classifier, and ball mill are sized for a capacity of 10 short ton/h of solids. Operation of the lime hydration system is controlled using a programmable logic controller (PLC) with local operator interface units.

The powdered hydrated lime leaving the classifier is captured using a cyclone and sent to a 2,200-ft³ hydrated lime silo, where it is stored before being sent for injection into the Turbosorp[®] absorber vessel. A 630-acfm blower is used to pneumatically convey the powdered hydrated lime from the silo to the absorber. The design also includes the capability to accept hydrated lime directly from a delivery truck, enabling continued operation of the Turbosorp[®] system in the event of a problem with the hydrator.

4.2.7 Baghouse

The multi-pollutant control system includes a new pulsejet fabric filter (baghouse) to remove particulate matter from the flue gas after it exits the Turbosorp[®] absorber vessel. A new particulate control device is required for AES Greenidge Unit 4 because the unit's existing ESP is not capable of handling the increased particle loading in the flue gas that results from the solids recycling that is part of the circulating fluidized bed dry scrubbing process. The existing ESP will be retired in place. A baghouse was selected for particulate control because it is expected to promote better removal efficiencies for SO₂, acid gases, mercury, and fine particulate matter than an ESP would, as discussed in Section 3.3.11. Key design parameters are summarized below.

Inlet Flue Gas Flow Rate – 371,440 acfm (full load, normal operation)
Inlet Flue Gas Particle Loading – 244 gr/dscf (full load, normal operation)
Flue Gas Temperature – 162°F (full load, normal operation)
Flue Gas Temperature Range – 150°F to 350°F
Number of Compartments – 8
Number of Bags – 3168
Bag Material – Ryton[®]
Nominal Air-to-Cloth Ratio – 3 (ft³/min)/ft²

Dust laden flue gas from the Turbosorp[®] absorber enters the top of the baghouse and flows through the inlet plenum, vertically upward through the filter bags, and through the outlet plenum. Particulate matter is collected on the outside of the filter bags. The filter bags are cleaned on-line using pulsejets, which use high-pressure air to cause ash accumulated on the bags to fall into the hoppers at the bottom of the baghouse. Baghouse cleaning is controlled by a local PLC, which is capable of providing data to the plant's DCS. The baghouse design includes inlet baffling and extra space below the bags to improve flow distribution, as well as greater-than-normal bag spacing to reduce can velocity (the upward velocity component of the dust-laden flue gas as it passes between the filter bags). The reduced can velocity promotes settling of dust particles during bag cleaning. Although the temperature of the flue gas entering the baghouse is projected to be about 162°F when the multi-pollutant control system is operating normally, temperatures as great as 350°F may be encountered if the Turbosorp[®] is not in service. Ryton[®] bags were specified because of their ability to withstand flue gas temperatures of up to 400°F and their resistance to abrasion and acid attack. The entire baghouse is thoroughly insulated and the baghouse hoppers are heated to prevent condensation, which could otherwise cause plugging and corrosion.

The baghouse is designed for continued operation with only seven of its eight compartments in service. Each compartment is equipped with inlet and outlet dampers that can be closed to isolate the compartment for on-line bag maintenance. Filter bags are accessed from the top of the baghouse. The baghouse structure includes a penthouse to accommodate the bag access area, valve actuators and cleaning air manifolds, and PLC.

In spite of the increased particle loading arising from the multi-pollutant control system, the baghouse is expected to achieve particulate emission rates of about 0.01 gr/dscf across all generator operating loads. This is about 67% less than the emission rate of 0.03 gr/dscf measured from the existing ESP during baseline testing at AES Greenidge.

4.2.8 Ash Recirculation System

The solids that are collected in the eight baghouse hoppers are fed into two air slide conveyers (one per set of four hoppers) that are collectively designed to process 517,658 lb/h of material at full load operation. Each air slide conveyer consists of a sloped piece of ductwork with a thick fabric material dividing the upper portion of the duct from the lower portion. A blower provides air along the bottom portion of each airslide, thereby fluidizing the solids on top of the fabric and allowing them to flow by gravity back toward the Turbosorp[®] absorber vessel. The design includes three 891 icfm blowers, each sized to provide 100% of the fluidizing air flow required for a single slide. (Hence, at any given time, two of the blowers will be operating, with the third in standby). The air slides are heated and insulated to prevent moisture from condensing on the solids.

As discussed above, greater than 95% of the solids are recycled back into the absorber. Rotary metering valves are used to control the solids recycle rate, based on the pressure drop across the Turbosorp[®] reactor. Excess solids are fed to a pair of ash disposal silos (one per air slide), each having a capacity of 720 ft³, which are tied into the plant's existing pneumatic vacuum ash disposal system.

4.2.9 Booster Fan

The multi-pollutant control system at AES Greenidge includes a new flue gas booster fan and motor to overcome the increased pressure drop created by the addition of the static mixers, SCR catalyst, circulating fluidized bed dry scrubber, and baghouse. The plant's existing ID fans do not afford sufficient capacity to overcome this pressure drop. The booster fan also provides the motive force for flue gas recirculation to the Turbosorp[®] inlet at low load operation, as required to maintain adequate fluidizing velocity. The 2068-bhp booster fan is installed downstream of the baghouse; its discharge is connected to the suction of the existing ID fans. The design includes a booster fan bypass system, consisting of a bypass duct with shut-off dampers and actuators, to aid in the plant start-up practice normally adopted by the existing ID fans.

4.3 Balance of Plant Considerations

4.3.1 Ductwork

To provide for interconnection among various components of the multi-pollutant control system and tie-in of the system to the existing plant, several existing sections of ductwork must be demolished and several new sections must be installed. Specifically, the design requires demolition of the section of existing ductwork connecting the economizer to the air heaters in order to accommodate the new in-duct SCR reactor, as well as demolition of the sections of existing ductwork connecting the air heaters to the ESP and the ESP to the ID fans to allow for tie-in of the Turbosorp[®] system and associated equipment to the existing plant. (As discussed in Section 4.2.7, the existing ESP is being retired in place). Asbestos insulation must be properly removed and disposed of prior to demolition; this is being conducted outside of the scope of the DOE project. The general arrangement drawings included in Appendix C illustrate the ductwork layout for the AES Greenidge installation. New ductwork sections, which are fabricated from ¼" carbon steel plate and are insulated and lagged in accordance with design standards, are as follows:

- Economizer outlet to air heater inlet, including SCR reactor ductwork
- Air heater outlet to Turbosorp[®] absorber inlet
- Turbosorp[®] absorber outlet to baghouse inlet
- Baghouse outlet to booster fan inlet
- Booster fan bypass (from baghouse outlet duct to booster fan outlet duct)
- Booster fan outlet to ID fan inlet
- Flue gas recirculation duct (from booster fan outlet duct to absorber inlet duct)

All new ductwork is designed to limit loads imposed on new and existing equipment. Supports and expansion joints are included to limit stresses and movement to those specified by equipment suppliers and by good engineering practice.

4.3.2 Civil and Structural

The general arrangement drawings provided in Appendix C illustrate the layout and structural requirements for the multi-pollutant control system installation at AES Greenidge. Per the discussion in Section 3.2.3, a strength of the multi-pollutant control system is the relatively small amount of space required for its installation. As shown in drawing No. 100276-GA200-00 in Appendix C, for the AES Greenidge Unit 4 installation, most of the components of the multi-pollutant control system are located outdoors in an approximately 125' x 150' plot just west of the boiler building. Figure 10 shows a photograph of this area taken prior to the start of construction. The area is constrained by the boiler building to the east, by a railroad bridge to the north, and by embankments to the south and west. The plant's existing pyrites silo and hydrogen dock are also visible in the photo. The system components being installed in this area include the urea storage tank, urea HFD module, activated carbon injection system, Turbosorp[®] scrubber, process water system, lime storage, hydration, and injection system, baghouse, ash recirculation system, and booster fan. Hence, only about 0.43 acre of land area is required outside of the boiler building to accommodate the multi-pollutant control system for the 107-MW_e AES Greenidge Unit 4 installation.

The relatively small acreage required for the Greenidge multi-pollutant control system results from a combination of its use of a single-bed, in-duct SCR reactor rather than a full-size, stand-alone SCR reactor, and its use of a vertically-tiered arrangement for the Turbosorp[®] system, baghouse, and lime storage and hydration system to promote gravity-assisted transport of solids (e.g., for recycling baghouse solids to the Turbosorp[®] vessel, transporting solids from the recycle loop to the ash disposal silos, and transporting solids within the lime hydration process). This is evident in drawings 100276-GA100-00, 100276-GA101-00, 100-276-ISO100-00, and 100276-ISO101-00 in Appendix C. As discussed in Section 4.2.2, the SCR system for AES Greenidge Unit 4 is designed to fit within the existing boiler building in a space with horizontal dimensions of 52' x 27' 2" and a vertical height of 23' 1/2". The only other space required in the boiler building is for six SNCR dilution and distribution modules and for electrical equipment, which can be flexibly located, as well as for the catalyst loading facility and the retract mechanisms for the MNLs. The baghouse is elevated to allow for solids recirculation via the airslides; for the AES Greenidge Unit 4 installation, the bottoms of the baghouse hoppers are about 75' above ground level and the top of the baghouse penthouse is about 150' above ground level.

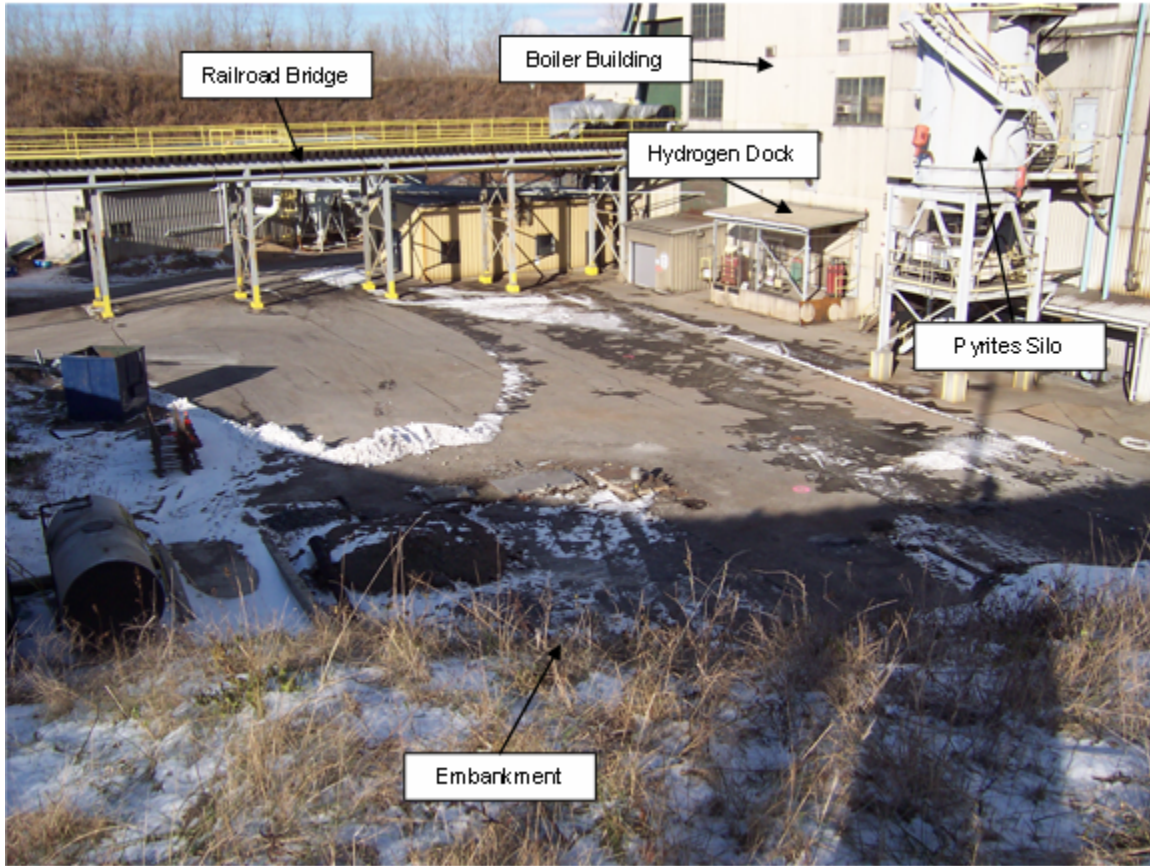

Figure 10. Photograph taken prior to the start of construction of the site for the outdoor portion of the multi-pollutant control system, as viewed from the southwest.

Equipment arrangement requirements dictate, to a great extent, the structural design for the multi-pollutant control system. Outside of the plant, shallow foundations and structural steel are required for each of three primary support structures:

- Lime storage and hydration system support structure
- Turbosorp[®] reactor support structure
- Baghouse support structure

These support structures are designed in accordance with all applicable codes and incorporate all necessary handrails, access stairs, ladders, floors, and platforms. The Turbosorp[®] reactor and baghouse support structures must be located adjacent to one another to facilitate solid product recycle via the air slides. Process constraints on the location of the lime storage and hydration system structure are less stringent; however, for the AES Greenidge retrofit, the lime structure is able to be situated immediately beside the Turbosorp[®] structure, an ideal location for simplifying transport of the hydrated lime to the Turbosorp[®] vessel for injection.

Inside the plant, several new horizontal steel beams are required to construct a frame for supporting the SCR reactor. The frame is tied into the plant's existing support columns, which are reinforced as needed to accommodate the added load. A new access platform is also provided to facilitate catalyst loading and unloading. No new foundations are required for the SCR installation.

A detailed discussion of the civil engineering design for the multi-pollutant control system installation at AES Greenidge is beyond the scope of this report. However, included in the design are the following:

- Site survey
- Geotechnical study
- Civil engineering demolition design, including plans for the removal and relocation of existing equipment and utilities
- Civil engineering site design, including site clearing, grubbing, grading, and drainage plans
- Erosion and sedimentation control design
- Underground utilities design
- Landscaping design
- Foundation engineering, including shallow foundations, slabs, or pads for equipment and components (e.g., water tank, water pumps, urea tank, HFD module, activated carbon silo, duct supports, piping, cable tray, stairway footings, etc.)
- Protective coatings for exposed structures

A new paved unloading facility is provided south of the baghouse to accommodate receipt of urea and quicklime deliveries.

4.3.3 Instruments and Controls

Process control philosophies for major components of the multi-pollutant control process were discussed in Section 4.2. The multi-pollutant control system design includes all field instrumentation required for operation and control of the system. (A detailed discussion of this instrumentation is beyond the scope of this report). In addition to standard temperature, pressure, level, and flow sensors and various control valves, this instrumentation includes the optical furnace temperature monitor required for control of the SNCR system (Section 4.2.1) and the dilution extractive-type SO₂ analyzer that is used to measure absorber inlet SO₂ concentrations for control of the Turbosorp[®] system (Section 4.2.4).

The SNCR system, lime hydration system, activated carbon injection system, and baghouse are each controlled locally by programmable logic controllers with local operator interface units. Input/output will be hardwired to local junction boxes for interface with the plant's distributed control system. As discussed in Section 2.3, AES Greenidge upgraded its Unit 4 DCS simultaneously to, but outside of the scope of, the multi-pollutant control project. The DCS is an Emerson Ovation[®] system. All other components of the multi-pollutant control system (i.e., sonic horns, Turbosorp[®] system, ash recirculation system, booster fan) are controlled through the DCS.

4.3.4 Electrical

The electrical design provides for tie-in of the new equipment to the plant's existing 2400V electrical system and includes a new 2400V motor control center (MCC), 2400V/480V transformer, and 480V MCC. 2400 VAC power is required for the booster fan motor, and 480 VAC power is required for the SNCR system pumps, catalyst hoist, activated carbon blower, water booster pumps, hydrator, bucket elevator, air classifier, ball mill, hydrated lime blower, baghouse bridge crane, baghouse hopper heater panel, airslide blowers, etc. 120 VAC

electrical connections are also required for instruments and controls, lighting, pipe heat tracing, etc.

Power will be fed to the new 2400V MCC and to the new 2400V/480V transformer and 480V MCC from two existing 1200A breakers currently used for two of the plant's coal pulverizers. The new 2400V MCC will include starters for these pulverizers as well as for the booster fan motor. The new 480V MCC will include starters for all other motors associated with the multi-pollutant control system.

The total estimated parasitic power requirement for full-load operation of the multi-pollutant control system at AES Greenidge Unit 4 is about 1650 kW (about 1.5% of the unit's net electrical output). The majority of this auxiliary load arises from the approximately 1400 kW net increase in fan power brought about by installation of the booster fan to supplement the unit's existing ID fans in overcoming the pressure drop created by installation of the multi-pollutant control system.

4.3.5 Other Utilities

The multi-pollutant control system requires water for the SNCR system, hydrator, and Turbosorp® water injection system, as well as for cooling various pieces of equipment. Table 4 summarizes the water requirements for operation of the system. With the exception of the condensate used for MNL cooling, plant service water (i.e., filtered water obtained from Seneca Lake) is the source of all water consumed by the system. The plant's existing service water system has sufficient capacity to meet the demands of the multi-pollutant control system.

Table 4. Water requirements for operation of the multi-pollutant control system at AES Greenidge.

Operation	Source of Water	Required Flow Rate (gpm) ^a
Urea Dilution	Plant Service Water	32
MNL Cooling	Condensate	60
Turbosorp® Water Injection	Plant Service Water	85
Lime Hydration	Plant Service Water	8
Ball Mill Cooling	Plant Service Water	3
Booster Fan Cooling	Plant Service Water	16

^aAt full-load operation.

Compressed air is also required throughout the multi-pollutant control system for actuators, as well as for various process operations, including:

- Urea atomization
- Sonic horns
- Baghouse pulsejet cleaning

AES Greenidge's existing compressed air system has sufficient excess capacity to satisfy the compressed air demands of the multi-pollutant control system (including the baghouse cleaning demand). As such, no new air compressors are required for the installation. The system's compressed air demands will be quantified in the Final Public Design Report.

4.3.6 Byproducts

The major byproduct generated by the multi-pollutant control system is the solid product resulting from the Turbosorp® process. As shown in drawing No. 100276-SK081706-05 in

Appendix A, the solid reaction products and unreacted reagent resulting from the Turbosorp® system increase the amount of solids sent from the plant's particulate control device for disposal by a factor of about 3.8, adding about 13,174 lb/h to the approximately 4,676 lb/h of fly ash produced when firing the design fuel at full load. (The mass added by activated carbon injection is very small, accounting for ≤ 89 lb/h, or $\leq 0.7\%$, of the 13,174 lb/h of new solid byproduct). AES Greenidge is modifying its pneumatic ash handling system outside of the scope of the DOE-funded project to provide sufficient capacity (including a reasonable margin) for accommodating the extra solids produced by the multi-pollutant control process. The projected composition of the combined solid product is summarized in Table 5.

Table 5. Projected composition of the fly ash / scrubber byproduct discharged from the baghouse.

Component	Weight Percent
CaSO ₃ · ½ H ₂ O	34.1
Fly Ash	26.2
CaCO ₃	13.3
CaSO ₄ · ½ H ₂ O	12.8
Ca(OH) ₂	9.5
CaCl ₂	1.0
H ₂ O	1.0
CaO	0.3
CaF ₂	0.2
Other Solids	1.6

AES Greenidge plans to landfill this byproduct in its Lockwood Landfill, located near the plant. However, the composition of the material, which resembles spray dryer byproduct in that it is dry, has a moderate fly ash content, and contains unreacted lime (Ca(OH)₂), makes it a candidate for use as a structural or flowable fill, as a neutralizing agent, or as a feedstock for manufactured aggregate production. This may help to improve process economics in certain installations of the multi-pollutant control technology (i.e., if the plant is situated geographically near an application that can utilize the byproduct). Options for use of the Turbosorp® scrubber byproduct will be evaluated as part of the Operation and Testing Phase of the Greenidge Project. Particular consideration will be given to the effects of mercury capture and ammonia slip on opportunities for byproduct utilization.

Gaseous and liquid waste streams from the multi-pollutant process are minimal. The only continuous sources of wastewater are the cooling water stream discharges from the ball mill and booster fan, which produce a combined 19 gpm (maximum) of wastewater that will be sent to drain. As shown in Table 3, the multi-pollutant control process is designed to reduce air emissions of a number of pollutants from AES Greenidge Unit 4. The hybrid SNCR/SCR process produces ammonia; however, the design limits emissions to ≤ 2 ppmvd at all operating loads. Any SO₃ formed from oxidation of SO₂ across the SCR catalyst is expected to be removed from the flue gas in the Turbosorp® system. Also, although the Turbosorp® process and activated carbon injection increase the solids loading of the flue gas, the baghouse is expected to reduce the unit's overall particulate matter emission rate. The lime hydration system generates a new gaseous exhaust stream containing dust, steam, and lime; however, as discussed in Section 4.2.6, this stream will be sent to the Turbosorp® scrubber and baghouse for cleaning, and it is not expected to have a measurable impact on air emissions.

4.3.7 Out-of-Scope Modifications

As discussed in Section 2.3, AES Greenidge is undertaking a number of projects outside of the scope of the DOE-funded multi-pollutant control project to help ensure a 20-30 year life extension for Unit 4. Several of these projects, although not included in the scope of the project covered by this report, nevertheless warrant coverage here because they are necessary to allow for installation of the multi-pollutant control system or to enable it to perform more optimally. These projects include the asbestos insulation removal discussed in Section 4.3.1, the DCS upgrade discussed in Section 4.3.3, and the ash handling system modifications discussed in Section 4.3.6, as well as combustion modifications and air preheater basket modifications, which are described in more detail below.

4.3.7.1 Combustion Modifications

The combustion modifications being performed at AES Greenidge are designed to complement and enhance the performance of the hybrid SNCR/SCR system. Per the discussion in Section 4.1, the combustion modifications play an integral role in achieving the targeted NO_x emission rate of ≤0.10 lb/MMBtu, as they are expected to reduce NO_x by ~17% (to ~0.25 lb/MMBtu) from the plant's baseline NO_x emission rate of ~0.30 lb/MMBtu. Moreover, the combustion modifications are designed to enable the SNCR system to operate more optimally by affording more stable NO_x concentrations in the furnace and reducing CO concentrations in the furnace. As discussed in Section 3.3.5, CO concentrations significantly impact SNCR chemistry.

The combustion modifications include modified burner assemblies and modifications to the Boiler 6 SOFA system to improve furnace air staging. The boiler's existing coal nozzles, combustion air nozzles, and overfire air nozzles are being replaced. The modified replacement combustion air nozzle tips provide an arrangement that offers internal main windbox air staging and maintains air penetration into the furnace when the SOFA ports are in use. Internal staging is accomplished by redesign of the air nozzle tips to increase the separation of the air streams around the fuel streams entering the boiler from each burner windbox. In addition, the design includes modified windbox compartment dampers to improve the control of secondary air flow. The SOFA system is being modified to provide improved jet penetration, and it features nozzles with both tilt and yaw adjustment capability, which enable better mixing in the upper furnace and reduced CO concentrations during staged, low-NO_x firing, thereby creating more ideal conditions for SNCR.

4.3.7.2 Air Preheater Basket Modifications

As discussed in Section 4.2.2, the in-duct SCR being installed as part of the Greenidge multi-pollutant control system is designed to limit ammonia slip to <2ppmvd (corrected to 3% O₂) and SO₂-to-SO₃ conversion to <1.0% in order to minimize the potential for ammonium bisulfate fouling in the unit's air preheaters. In spite of these stringent performance targets, there remains some risk of ammonium bisulfate fouling, especially because the unit will fire mid-to-high sulfur coals and because the multi-pollutant control system relies on a relatively shallow, single catalyst layer to consume almost all ammonia slipped from the SNCR. This risk is greatest during initial tuning of the hybrid SNCR/SCR system, when system optimization may result in temporary periods of greater-than-expected ammonia slip, and near the end of the catalyst operating life, when catalyst activity is minimal.

Prior to the multi-pollutant control project, the two Unit 4 air preheaters employed a three-layer basket configuration, consisting of hot end, intermediate, and cold end layers. This

configuration is susceptible to ammonium bisulfate fouling, because there is a possibility that ammonium bisulfate deposits will bridge across the cold end and intermediate layers, rather than being limited to the cold end layer. Bridging of the deposits across layers decreases the effectiveness of on-line cleaning and enhances the rate of ammonium bisulfate accumulation.

As a result, AES Greenidge decided to replace and modify the configuration of the Unit 4 air preheater baskets while the multi-pollutant control system is being installed. The modifications entail replacing the three-layer basket arrangement with a two-layer arrangement. The existing layer of cold end elements is being replaced with a layer of deeper, enamel-coated, closed channel elements, and the existing layers of intermediate and hot end elements are being replaced with a single layer of corrosion-resistant low-alloy steel elements. This reconfiguration will help to ensure that any ammonium bisulfate formed is condensed on the cold-end elements, which can be effectively cleaned via soot blowing. The enamel coating on these elements helps to prevent adhesion of ammonium bisulfate deposits, facilitate removal of these deposits, and resist corrosion. The modifications also include removal of the cold end element support screen to allow for more effective soot blowing.

5. Conclusions

In conclusion, the multi-pollutant control process being demonstrated at AES Greenidge, with its combination of deep emission reduction capabilities, low capital costs, small space requirements, operational flexibility, and mechanical simplicity, is designed to meet the needs of coal-fired EGUs with capacities less than 300 MW_e. The process is founded on the integration of a hybrid SNCR/SCR system and a Turbosorp[®] circulating fluidized bed dry scrubber with activated carbon injection and baghouse ash recycling. The Greenidge Project seeks to demonstrate that this process, when combined with combustion modifications (installed outside of the scope of the DOE project), can reduce emissions of NO_x by ≥67%, SO₂ and acid gases by ≥95%, and Hg by ≥90% when applied to an approximately 110 MW_e unit firing 2.9%-sulfur coal, while having a capital cost of only \$340/kW (including the combustion modifications) and a footprint of <0.5 acre.

This report has provided a summary of the available preliminary, nonproprietary design information concerning the multi-pollutant control process and the installation at AES Greenidge Unit 4. As such, it is intended to serve as a reference highlighting the key objectives, concepts, and uncertainties associated with the multi-pollutant control process and the important factors that must be considered when designing a commercial-scale installation of the process. This Preliminary Public Design Report will be followed by a Final Public Design Report that will expand upon the information presented here to reflect the final, as-built design of the multi-pollutant control facility and to incorporate data on its capital cost and projected operating costs. Future technical reports will communicate the results of the Greenidge Project's testing program, which is designed to confirm the technical and economic performance of the multi-pollutant control system.

ACRONYMS AND ABBREVIATIONS

°F	-	degrees Fahrenheit
A	-	amp
acfm	-	actual cubic feet per minute
bhp	-	brake horsepower
BPEI	-	Babcock Power Environmental Inc.
CAIR	-	Clean Air Interstate Rule
CAMR	-	Clean Air Mercury Rule
CCT	-	Clean Coal Technology
CEM	-	continuous emission monitor
CFD	-	computational fluid dynamics
CKM	-	chemical kinetic modeling
DCS	-	distributed control system
DOE	-	U.S. Department of Energy
dscf	-	dry standard cubic foot
EGU	-	electrical generating unit
EPA	-	U.S. Environmental Protection Agency
ESP	-	electrostatic precipitator
FD	-	forced draft
FGD	-	flue gas desulfurization
FONSI	-	Finding of No Significant Impact
ft	-	foot
gal	-	gallon
gpm	-	gallons per minute
gr	-	grain
GW	-	gigawatt
h	-	hour
HFD	-	high flow delivery
hp	-	horsepower
icfm	-	inlet cubic feet per minute
ID	-	induced draft

IZM	-	injector zone metering
kW	-	kilowatt
lb	-	pound
MCC	-	motor control center
min	-	minute
mm	-	millimeter
MMacf	-	million actual cubic feet
MMBtu	-	million British thermal units
MNL	-	multiple nozzle lance
MWe	-	megawatt of electricity
MWg	-	megawatts gross
NEPA	-	National Environmental Policy Act
NETL	-	National Energy Technology Laboratory
NOx	-	nitrogen oxides
NYSEG	-	New York State Electric & Gas
PAC	-	powdered activated carbon
PLC	-	programmable logic controller
PM	-	particulate matter
PPII	-	Power Plant Improvement Initiative
ppmvd	-	parts per million by volume, dry basis
psig	-	pounds per square inch gauge
scfm	-	standard cubic feet per minute
SCR	-	selective catalytic reduction
SNCR	-	selective non-catalytic reduction
SOFA	-	separated overfire air
STPH	-	short tons per hour
TRI	-	Toxics Release Inventory
V	-	volt
VAC	-	volts alternating current
w/w	-	by weight

REFERENCES

- Albanese, V.; Boyle, J.; Huhmann, A.; Wallace, A. Evaluation of Hybrid SNCR/SCR for NO_x Abatement on a Utility Boiler; Presented at Power-Gen '95, Anaheim, CA, December 1995.
- Albanese, V.; Boyle, J.; Sun, W.; Abrams, R. Hybridization of Urea-SNCR with SCR: A Fit for the Future; Presented at ICAC's Clean Air Technologies & Strategies Conference, Baltimore, MD, March 7-10, 2005.
- Brouwer, J.; Heap, M.P.; Pershing, D.W.; Smith, P.J. A Model for Prediction of Selective Noncatalytic Reduction of Nitrogen Oxides by Ammonia, Urea, and Cyanuric Acid with Mixing Limitations in the Presence of CO; In Proceedings of the Twenty-Sixth Symposium (International) on Combustion; The Combustion Institute: Pittsburgh, PA, 1996.
- Canadian Electricity Association (CEA); Mercury Information Clearinghouse, Quarter 5 – Mercury Fundamentals; January 2005.
- DePriest, W.; Gaikwad, R.P. Economics of Lime and Limestone for Control of Sulfur Dioxide; Presented at the Fourth Mega Symposium on Power Plant Air Pollutant Control, Washington, D.C., May 19-22, 2003.
- Fenger, M.L.; Winschel, R.A. Multi-Pollutant Emissions Control: Pilot Plant Study of Technologies for Reducing Hg, SO₃, NO_x and CO₂ Emissions; Final Report of Work Performed Under U.S. DOE-NETL Cooperative Agreement No. DE-FC26-01NT41181, CONSOL Energy Inc. Research & Development: South Park, PA, 2006.
- Fernando, R. *Experience of Indirect Cofiring of Biomass and Coal*; IEA Clean Coal Centre: London, 2002; Report No. CCC/64.
- Ghorishi, B.; Gullett, B.K. Sorption of Mercury Species by Activated Carbons and Calcium-Based Sorbents: Effect of Temperature, Mercury Concentration and Acid Gases; *Waste Manage. Res.* **1998**, *16*, 582-593.
- Lancia, A.; Musmarra, D.; Pepe, F.; Volpicelli, G. Adsorption of Mercuric Chloride Vapours from Incinerator Flue Gases on Calcium Hydroxide Particles; *Combust. Sci. Technol.* **1993**, *93*, 277-289.
- Miller, C.E.; Feeley, T.J.; Aljoe, W.W.; Lani, B.W.; Schroeder, K.T.; Kairies, C.; McNemar, A.T.; Jones, A.P.; Murphy, J.T. Mercury Capture and Fate Using Wet FGD at Coal-Fired Power Plants; DOE/NETL Mercury and Wet FGD R&D: Pittsburgh, PA, 2006. Available: http://www.netl.doe.gov/technologies/coalpower/ewr/coal_utilization_byproducts/pdf/mercury_%20FGD%20white%20paper%20Final.pdf.
- Niksa, S.; Fujiwara, N. Predicting Extents of Mercury Oxidation in Coal-Derived Flue Gases; *J. Air & Waste Manage. Assoc.* **2005**, *55*, 930-939.
- Pfaff, D.; Abrams, R. Hybrid SNCR/In-Duct SCR System; Presented at the 2006 DOE/NETL Environmental Control Conference, Pittsburgh, PA, May 16-18, 2006.

Presto, A.A.; Granite, E.J. Survey of Catalysts for Oxidation of Mercury in Flue Gas; *Environ. Sci. Technol.* **2006**, *40*, 5601-5609.

Urbas, J.B. Hybrid Selective Non-Catalytic Reduction (SNCR) / Selective Catalytic Reduction (SCR) Demonstration for the Removal of NO_x from Boiler Flue Gases; Final Technical Report of Work Performed Under U.S. DOE Agreement No. DE-FG22-96PC96256, GPU Generation, Inc.: Johnstown, PA, 1999.

Withum, J.A. Evaluation of Mercury Emissions from Coal-Fired Facilities with SCR and FGD Systems; Final Report of Work Performed Under U.S. DOE-NETL Cooperative Agreement No. DE-FC26-02NT41589, CONSOL Energy Inc. Research & Development: South Park, PA, 2006. Available: <http://www.netl.doe.gov/technologies/coalpower/ewr/mercury/control-tech/pubs/DOE%20SCR-FGD%20FINAL%20REPORT.pdf>.

Wu, Z. *NO_x Control for Pulverized Coal Fired Power Stations*; IEA Clean Coal Centre: London, 2002; Report No. CCC/69.

APPENDIX A PROCESS FLOW DIAGRAMS

<u>Drawing</u>	<u>Description</u>
100276-SK081706-05	Process Flow Diagram – Design Load
100276-SK101206-03	Process Flow Diagram – Low Load

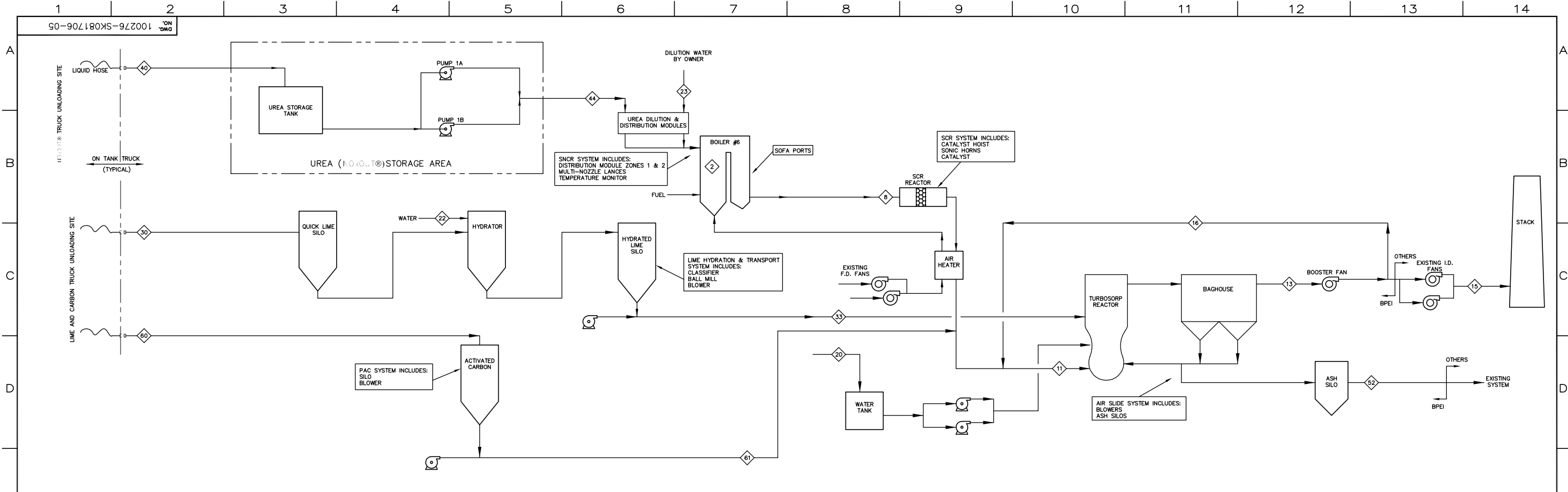

FUEL

DESCRIPTION	COAL	WOOD	BLENDED FUEL
HHV	13,097	8,592	12,426
CARBON, wt%	72.17	45.13	68.14
HYDROGEN, wt%	4.79	5.78	4.94
NITROGEN, wt%	1.36	2.8	1.57
CHLORINE, wt%	0.1	0.22	0.12
SULFUR, wt%	2.9	0.2	2.5
OXYGEN, wt%	5.04	38.72	10.05
MOISTURE, wt%	5.8	6.3	5.87
ASH, wt%	7.85	0.82	6.8
MASS FLOW, LB/HR			85,692

FLUE GAS

DESCRIPTION	UNITS	FURNACE	TO SCR	TO TURBO-REACTOR	FG FROM BAG-HOUSE	TO STACK	FG RECYCLE
STREAM #		2	8	11	13	15	16
TEMP	F		662	304	162	177	
PRESS	W/G		-7.6	-13.5	0.5		
FLOW	ACFM		490,161	423,700	382,389	362,899	0
	SCFM, WET		222,094	277,807	296,603	296,603	0
MASS FLOW	LB/HR		1,025,253	1,278,722	1,326,133	1,326,133	0
SO2	PPMVD @ 3% O2	2114	2,108	2,097	105	105	
SO3	PPMVD @ 3% O2		6	17	0.9	0.9	
NH3	PPMVD @ 3% O2		47			2	
NOXAS NO2	PPMVD @ 3% O2	190	110			76	
HCL	PPMVD @ 3% O2			80	4	4.0	
HF	PPMVD @ 3% O2			29.0	2	1.5	
ASH	GR/SCF, DRY			2.1	0.01	0.01	

SOLID PRODUCTS

DESCRIPTION	TO EXISTING SYSTEM
STREAM #	52
COMP, LB/HR	
CaO	62
Ca(OH)2	1,702
CaCO3	2,373
CaSO3*0.5 H2O	6,088
CaSO4*0.5 H2O	2,282
CaCl2	177
CaF2	35
OTHER SOLIDS	276
FLYASH	4,676
TSS	17,671
H2O	178
TOTAL	17,850
FLOW, FT3/HR	440
TEMP, DEG F	140-170

UREA (NOxOUT®) SOLUTION

DESCRIPTION	TRUCK UNLOADING	TO SNCR
STREAM #	40	44
Temp, F	80	80
Press, psig	15	200
Flow, GPM	N/A	1.12
Flow, lb/hr	N/A	638

ACTIVATED CARBON

DESCRIPTION	TO SILO	TO REACTOR
STREAM #	60	61
COMP, LB/HR		
CARBON	10,080	75
ASH	1,560	11.6
H2O	360	2.7
TOTAL	12,000	89.3
FLOW, FT3/HR	353	2.6
TEMP, DEG F	AMB	AMB

LIME

DESCRIPTION	FROM TRUCK	TO INJECTION
STREAM #	30	33
COMP, LB/HR		
CaO	6,262	62
Ca(OH)2	0	8,192
CaCO3	59	59
OTHER SOLIDS	276	276
TSS	6,597	8,589
H2O	0	35
TOTAL	6,597	8,623
FLOW, FT3/HR	106	345
TEMP, DEG F	AMB	AMB

WATER

DESCRIPTION	WATER TO TANK	WATER HYDRATION	DILUTION WATER
STREAM #	20	22	23
TEMP, DEG F	54	54	54
PRESS, PSIG	2	60	2
FLOW, GPM	89	8.0	32
FLOW, LB/HR	44,385	3,951	15,994

STANDARD CONDITIONS:
SCF: 68°F, 1 ATM AND ACTUAL MOISTURE

BABCOCK POWER ENVIRONMENTAL INC.
 PROCESS FLOW DIAGRAM
 AES
 GREENIDGE - UNIT 4
 DRESDEN, N.Y.
 CLAYTON A. ERICKSON
 08/18/06
 DWG. NO. 100276-SK081706-05

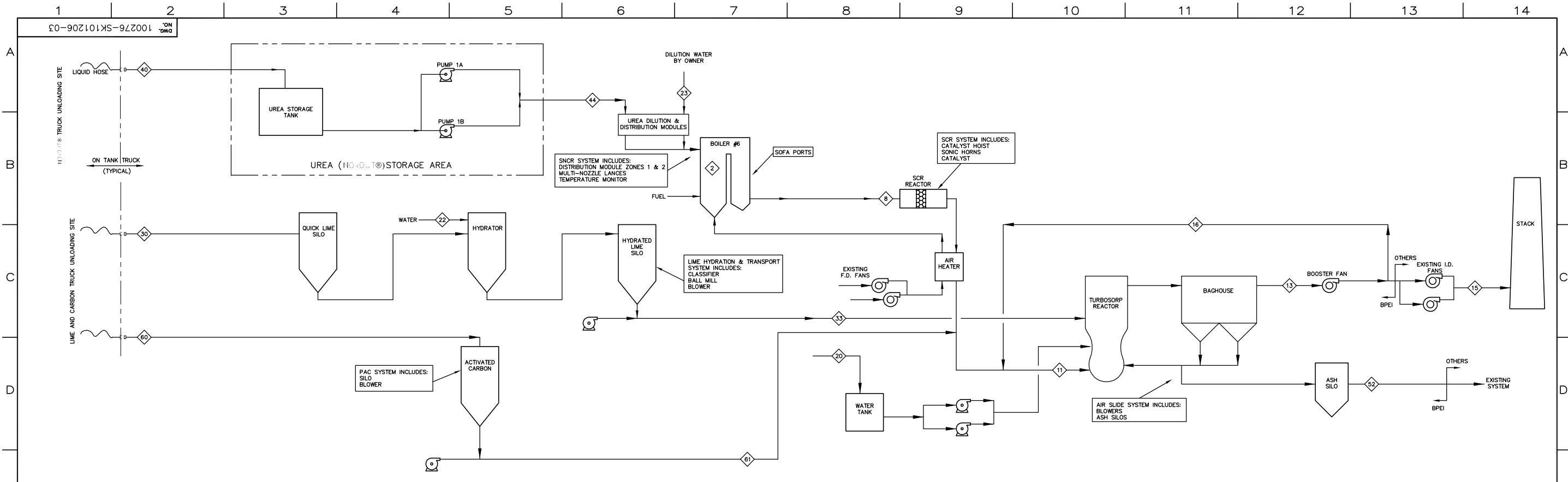

FUEL

DESCRIPTION	COAL	WOOD	BLENDED FUEL
HHV	13,097	8,592	12,426
CARBON, wt%	72.17	45.13	68.14
HYDROGEN, wt%	4.79	5.78	4.94
NITROGEN, wt%	1.36	2.8	1.57
CHLORINE, wt%	0.1	0.22	0.12
SULFUR, wt%	2.9	0.2	2.5
OXYGEN, wt%	5.04	38.72	10.05
MOISTURE, wt%	5.8	6.3	5.87
ASH, wt%	7.85	0.82	6.8
MASS FLOW, LB/HR			33,571

FLUE GAS

DESCRIPTION	UNITS	FURNACE	TO SCR	TO TURBO-REACTOR	FG FROM BAG-HOUSE	TO STACK	FG RECYCLE
STREAM #		2	8	11	13	15	16
TEMP, F		508	251	162	168	168	168
PRESS, ING		-2.2	-4		1		
FLOW, ACFM		212,413	250,239	231,961	172,518	52,558	
SCFM, WET		115,236	180,574	189,169	145,403	43,766	
MASS FLOW, LB/HR		522,203	823,334	849,403	655,689	193,714	
SO2, PPMVD @ 3% O2		2114	2108	1615	105	105	105
SO3, PPMVD @ 3% O2			6	13	0.4	0.4	0.4
NH3, PPMVD @ 3% O2			2		2		
NOX AS NO2, PPMVD @ 3% O2		190	190			190	
HCL, PPMVD @ 3% O2				60	3	3	3
HF, PPMVD @ 3% O2				22	1	1	1
ASH, GR/SCF DRY				1.5	0.01	0.01	0.01

SOLID PRODUCTS

DESCRIPTION	TO EXISTING SYSTEM
STREAM #	52
COMP, LB/HR	
CaO	25
Ca(OH)2	681
CaCO3	949
CaSO3*0.5 H2O	2,435
CaSO4*0.5 H2O	913
CaCl2	71
CaF2	14
OTHER SOLIDS	110
FLYASH	1,870
TSS	7,088
H2O	71
TOTAL	7,140
FLOW, FT3/HR	176
TEMP, DEG F	140-170

UREA (NOxOUT®) SOLUTION

DESCRIPTION	TRUCK UNLOADING	TO SNCR
STREAM #	40	44
Temp, F	80	80
Press, psig	15	200
Flow, GPM	N/A	0.00
Flow, lb/hr	N/A	0

ACTIVATED CARBON

DESCRIPTION	TO SILO	TO REACTOR
STREAM #	60	61
COMP, LB/HR		
CARBON	10080	45
ASH	1560	7.0
H2O	360	1.6
TOTAL	12000	53.6
FLOW, FT3/HR	353	1.6
TEMP, DEG F	AMB	AMB

LIME

DESCRIPTION	FROM TRUCK	TO INJECTION
STREAM #	30	33
COMP, LB/HR		
CaO	2,482	25
Ca(OH)2	0	3,277
CaCO3	24	24
OTHER SOLIDS	110	110
TSS	2,616	3,436
H2O	0	14
TOTAL	2,616	3,450
FLOW, FT3/HR	42	138
TEMP, DEG F	AMB	AMB

WATER

DESCRIPTION	WATER TO TANK	WATER HYDRATION	DILUTION WATER
STREAM #	20	22	23
TEMP, DEG F	54	54	54
PRESS, PSIG	2	60	2
FLOW, GPM	34	3.2	0
FLOW, LB/HR	16,862	1,580	0

STANDARD CONDITIONS:
SCF: 68°F, 1 ATM AND ACTUAL MOISTURE

**APPENDIX B
LIST OF MAJOR EQUIPMENT**

Item	Quantity	Size	Manufacturer
SNCR System	1	N/A	Fuel Tech
Urea Storage Tank	1	15,000 gal	Fuel Tech
High Flow Delivery Module	1	96" x 48" x 30"(h)	Fuel Tech
Centrifugal Pump	2	5 hp / pump	Fuel Tech
Dilution Water Pressure Control Module	1	96" x 48" x 78"(h)	Fuel Tech
Centrifugal Pump	2	5 hp / pump	Fuel Tech
Injector Zone Metering Module	1	144" x 48" x 78"(h)	Fuel Tech
Distribution Module	2	67" x 24" x 72"(h)	Fuel Tech
Distribution Module	1	80" x 24" x 72"(h)	Fuel Tech
MNL Distribution Module	1	84" x 41" x 84"(h)	Fuel Tech
Wall Injector	6	3 ft	Fuel Tech
Auto Retract Injector	10	3 ft	Fuel Tech
Multiple Nozzle Lance	2	14-15 ft	Fuel Tech
SCR Reactor System	1	490,161 acfm	BPEI
SCR Reactor	1	27'-2" x 45'-5/8"	BPEI
Electric Catalyst Hoist	1	2 ton	American Crane
Catalyst Layer	1	1330 mm thick	Cormetech
Sonic Horn	4	N/A	BHA
Powdered Activated Carbon System	1	89.3 lb/h	Chemco
PAC Storage Silo	1	750 ft ³	Chemco
PAC Blower	1	80 scfm	Chemco
Lime Hydration and Injection System	1	8623 lb/h	ZMI Portec
Lime Storage Silo	1	7500 ft ³	ZMI Portec

Item	Quantity	Size	Manufacturer
Lime Hydrator	1	10 STPH	ZMI Portec
Bucket Elevator	1	20 STPH	ZMI Portec
Hydrated Lime Classifier	1	10 STPH	ZMI Portec
Hydrated Lime Fines Cyclone	1	10 STPH	ZMI Portec
Hydrated Lime Ball Mill	1	10 STPH	ZMI Portec
Hydrate Product Silo	1	2200 ft ³	ZMI Portec
Hydrated Lime Blower	1	630 acfm	FL Smidth
Process Water System	1	N/A	BPEI
Process Water Tank	1	6300 gal	Goodheart Sons
Process Water Booster Pump	2 x 100%	150 gpm / pump	Lechler
Water Injection Lance	2 x 100%	85 gpm / lance	Lechler
Turbosorp [®] System	1	423,700 acfm	BPEI
Turbosorp [®] Reactor	1	23'-9 1/2" dia. x 105'-9 1/2" height	BPEI
Baghouse	1	371,440 acfm	Dustex
Booster Fan	1	2,068 bhp	TLT Co-Vent
Air Slides	2	517,658 lb/h total	FL Smidth
Air Slide Blower	3 x 50%	891 icfm / blower	FL Smidth
Ash Silo	2	720 ft ³ / silo	Goodheart Sons

APPENDIX C GENERAL ARRANGEMENT DRAWINGS

<u>Drawing</u>	<u>Description</u>
100276-GA200-00	Plan View
100276-GA100-00	Elevation View Looking North
100276-GA101-00	Elevation View Looking East
100276-ISO100-00	Isometric View Looking Northwest
100276-ISO101-00	Isometric View Looking Southeast

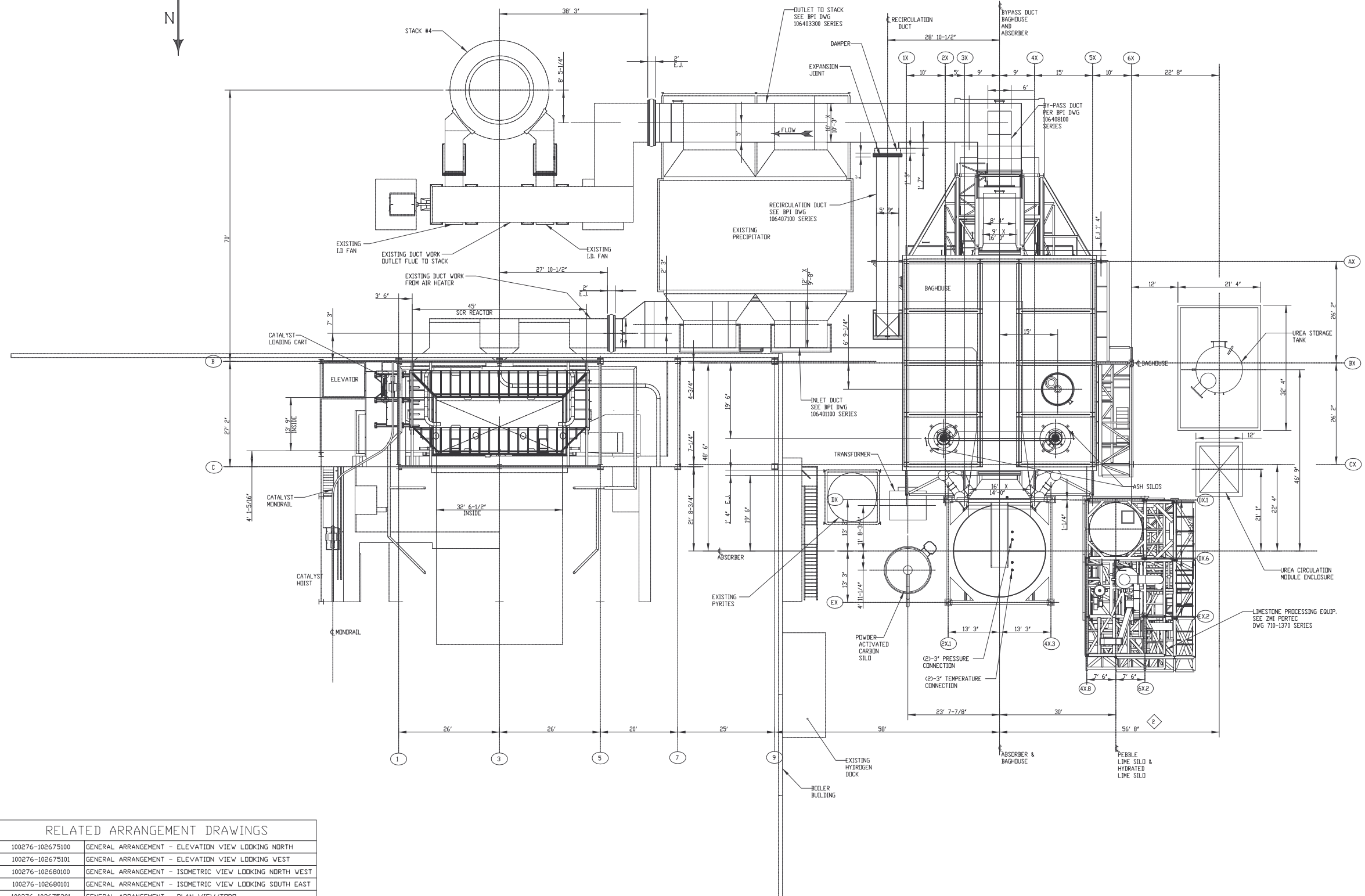

RELATED ARRANGEMENT DRAWINGS	
100276-102675100	GENERAL ARRANGEMENT - ELEVATION VIEW LOOKING NORTH
100276-102675101	GENERAL ARRANGEMENT - ELEVATION VIEW LOOKING WEST
100276-102680100	GENERAL ARRANGEMENT - ISOMETRIC VIEW LOOKING NORTH WEST
100276-102680101	GENERAL ARRANGEMENT - ISOMETRIC VIEW LOOKING SOUTH EAST
100276-102675201	GENERAL ARRANGEMENT - PLAN VIEW/TOPD
100276-102680200	GENERAL ARRANGEMENT - FGD EXPLODED DUCTS
100276-102680201	GENERAL ARRANGEMENT - TURBOSORP EXPLODED DUCTS
100276-92396100	SCR ARRANGEMENT
100276-106496100	FGD ARRANGEMENT
100276-92680100	GENERAL ARRANGEMENT - SCR EXPLODED DUCTS

BABCOCK POWER ENVIRONMENTAL INC.
 GENERAL ARRANGEMENT
 PLAN VIEW
 AES
 GREENIDGE UNIT #4
 DRESDEN, NEW YORK
 DWG. NO. 100276-GA200-00

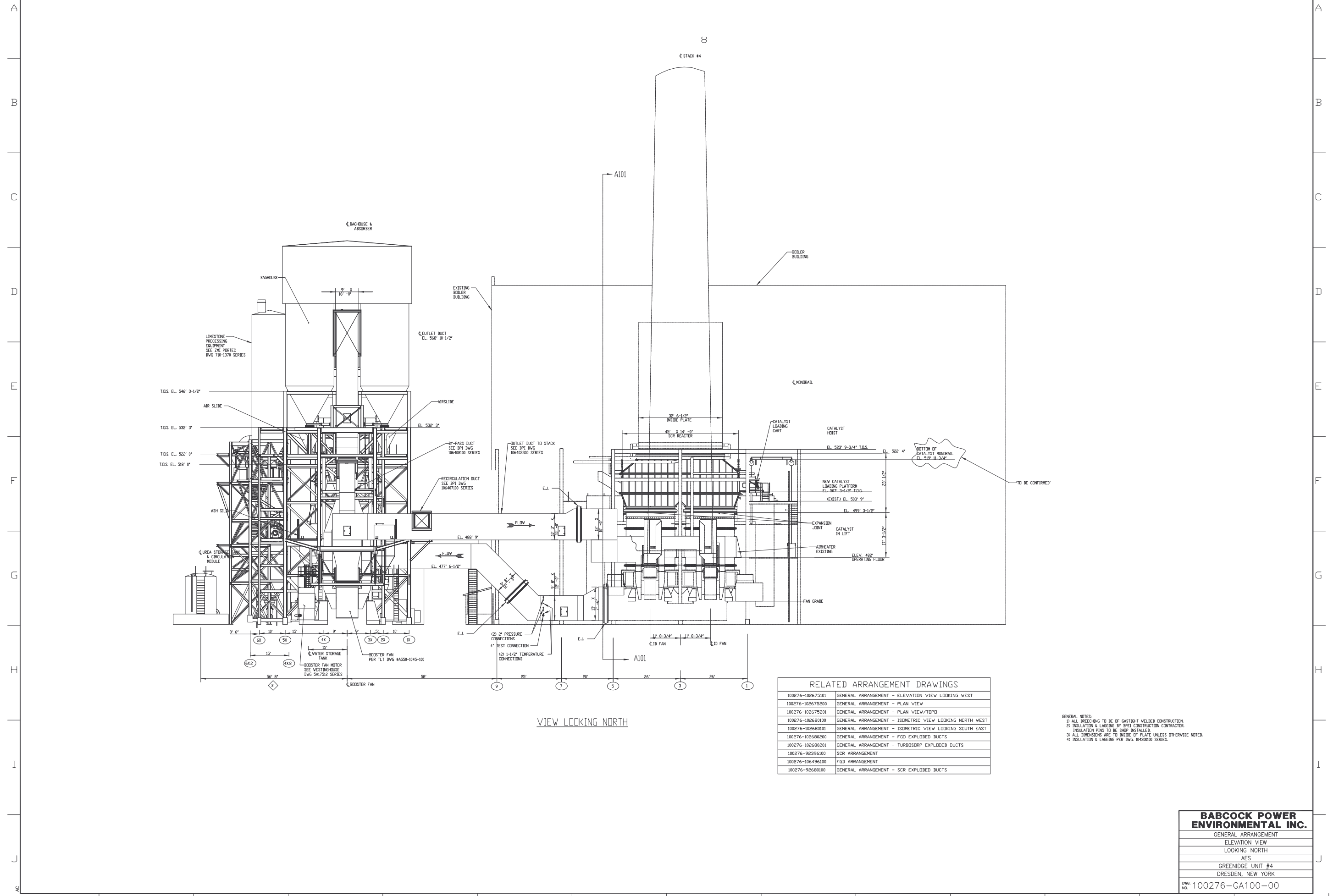

VIEW LOOKING NORTH

RELATED ARRANGEMENT DRAWINGS	
100276-102675101	GENERAL ARRANGEMENT - ELEVATION VIEW LOOKING WEST
100276-102675200	GENERAL ARRANGEMENT - PLAN VIEW
100276-102675201	GENERAL ARRANGEMENT - PLAN VIEW/TOP/D
100276-102680100	GENERAL ARRANGEMENT - ISOMETRIC VIEW LOOKING NORTH WEST
100276-102680101	GENERAL ARRANGEMENT - ISOMETRIC VIEW LOOKING SOUTH EAST
100276-102680200	GENERAL ARRANGEMENT - FGD EXPLODED DUCTS
100276-102680201	GENERAL ARRANGEMENT - TURBOSORP EXPLODED DUCTS
100276-92396100	SCR ARRANGEMENT
100276-106496100	FGD ARRANGEMENT
100276-92680100	GENERAL ARRANGEMENT - SCR EXPLODED DUCTS

GENERAL NOTES
 1) ALL WELDING TO BE OF GASTIGHT WELDED CONSTRUCTION.
 2) INSULATION & LAGGING BY BPEI CONSTRUCTION CONTRACTOR.
 3) INSULATION PINS TO BE SHOP INSTALLED.
 4) ALL DIMENSIONS ARE TO INSIDE OF PLATE UNLESS OTHERWISE NOTED.
 5) INSULATION & LAGGING PER DWG. 104300100 SERIES.

BABCOCK POWER ENVIRONMENTAL INC.
 GENERAL ARRANGEMENT
 ELEVATION VIEW
 LOOKING NORTH
 AES
 GREENIDGE UNIT #4
 DRESDEN, NEW YORK
 DWG. NO. 100276-GA100-00

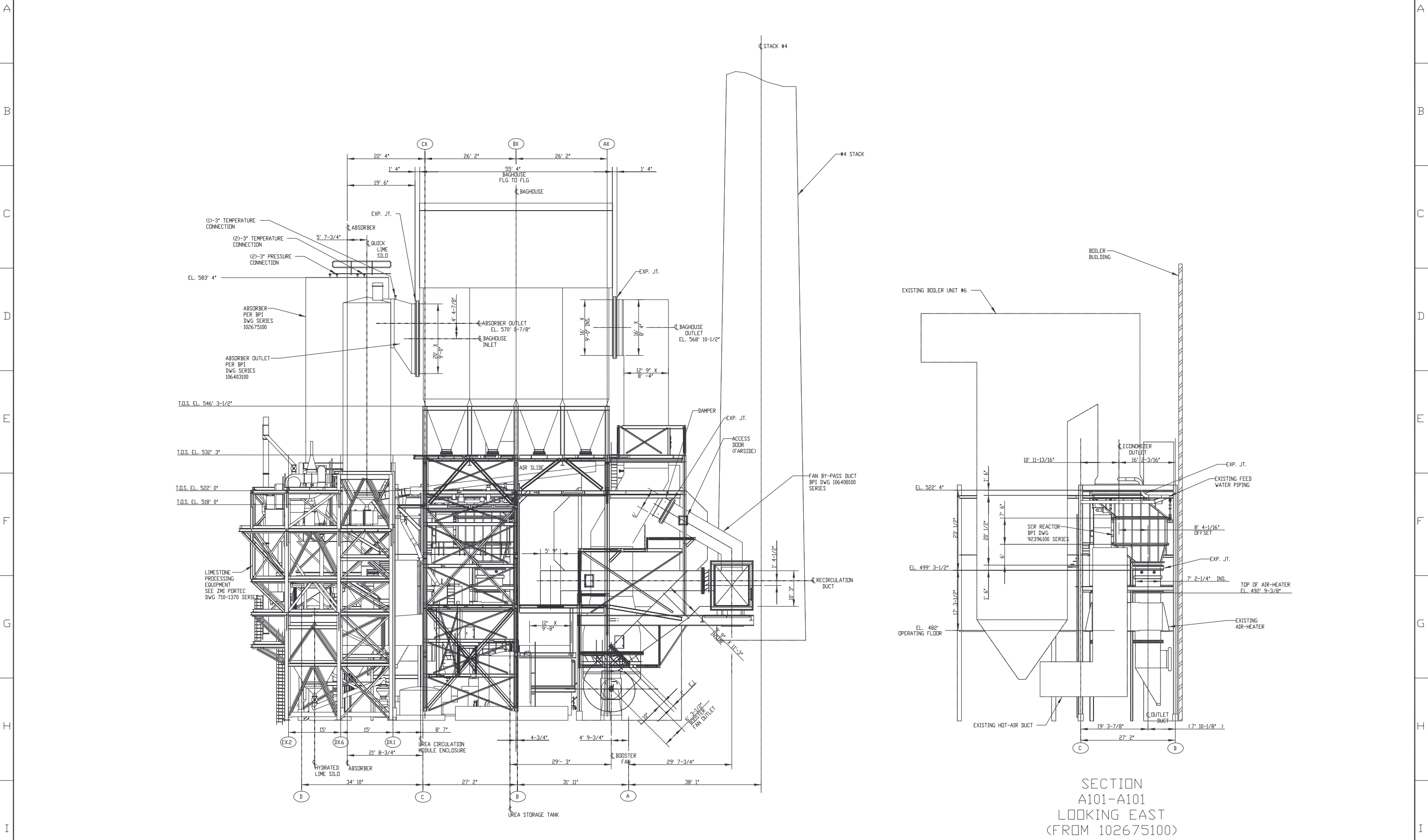

VIEW LOOKING EAST

SECTION A101-A101
LOOKING EAST
(FROM 102675100)

BABCOCK POWER ENVIRONMENTAL INC.
GENERAL ARRANGEMENT
ELEVATION VIEW
LOOKING EAST
AES
GREENIDGE UNIT #4
DRESDEN, NEW YORK
DWG. NO. 100276-GA101-00

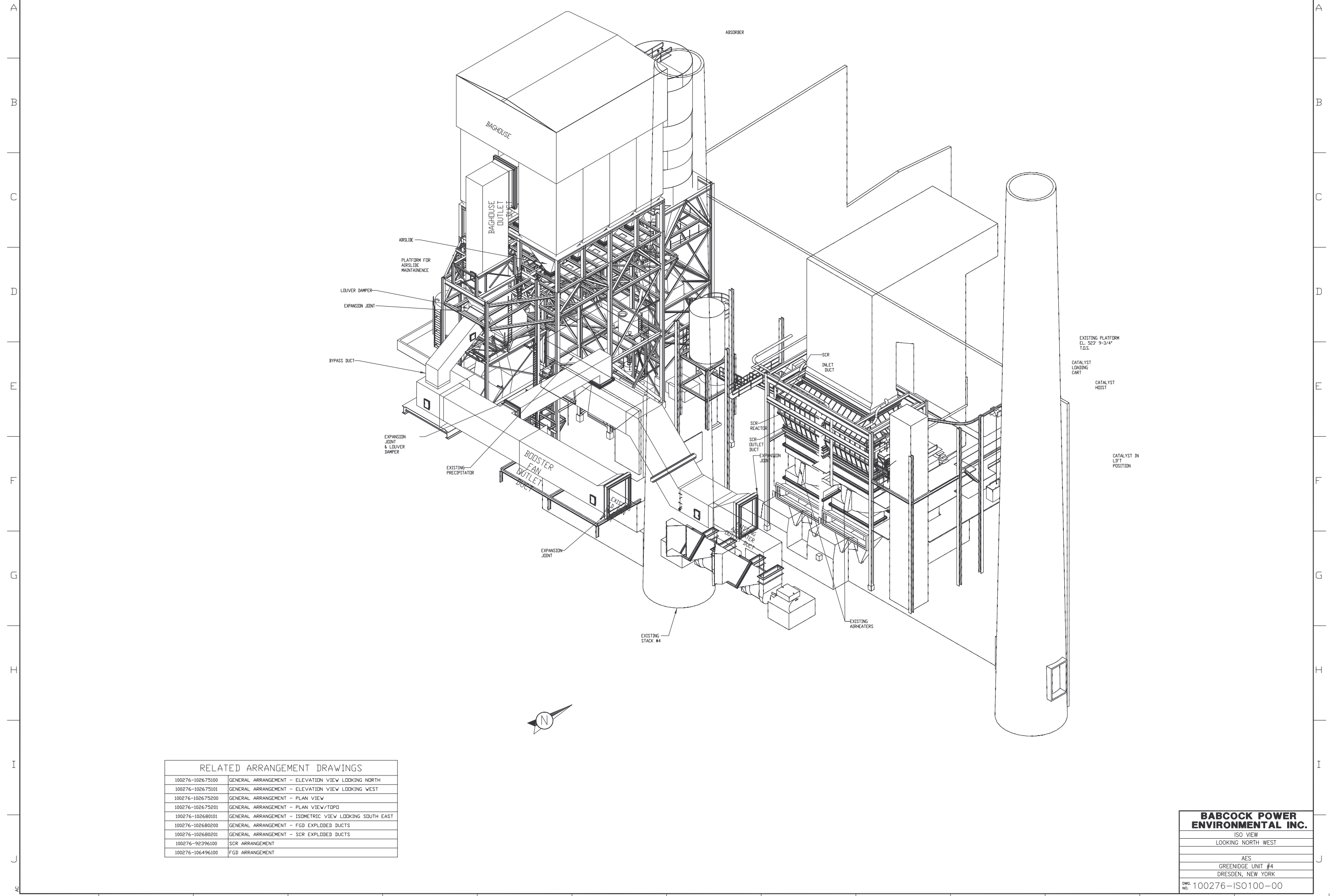

RELATED ARRANGEMENT DRAWINGS	
100276-102675100	GENERAL ARRANGEMENT - ELEVATION VIEW LOOKING NORTH
100276-102675101	GENERAL ARRANGEMENT - ELEVATION VIEW LOOKING WEST
100276-102675200	GENERAL ARRANGEMENT - PLAN VIEW
100276-102675201	GENERAL ARRANGEMENT - PLAN VIEW/TOPD
100276-102680101	GENERAL ARRANGEMENT - ISOMETRIC VIEW LOOKING SOUTH EAST
100276-102680200	GENERAL ARRANGEMENT - FGD EXPLODED DUCTS
100276-102680201	GENERAL ARRANGEMENT - SCR EXPLODED DUCTS
100276-92396100	SCR ARRANGEMENT
100276-106496100	FGD ARRANGEMENT

BABCOCK POWER ENVIRONMENTAL INC.
 ISO VIEW
 LOOKING NORTH WEST
 AES
 GREENIDGE UNIT #4
 DRESDEN, NEW YORK
 DWG. NO. 100276-ISO100-00

1 2 3 4 5 6 7 8 9 10 11 12 13 14

1010SI-ISO101

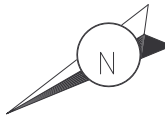
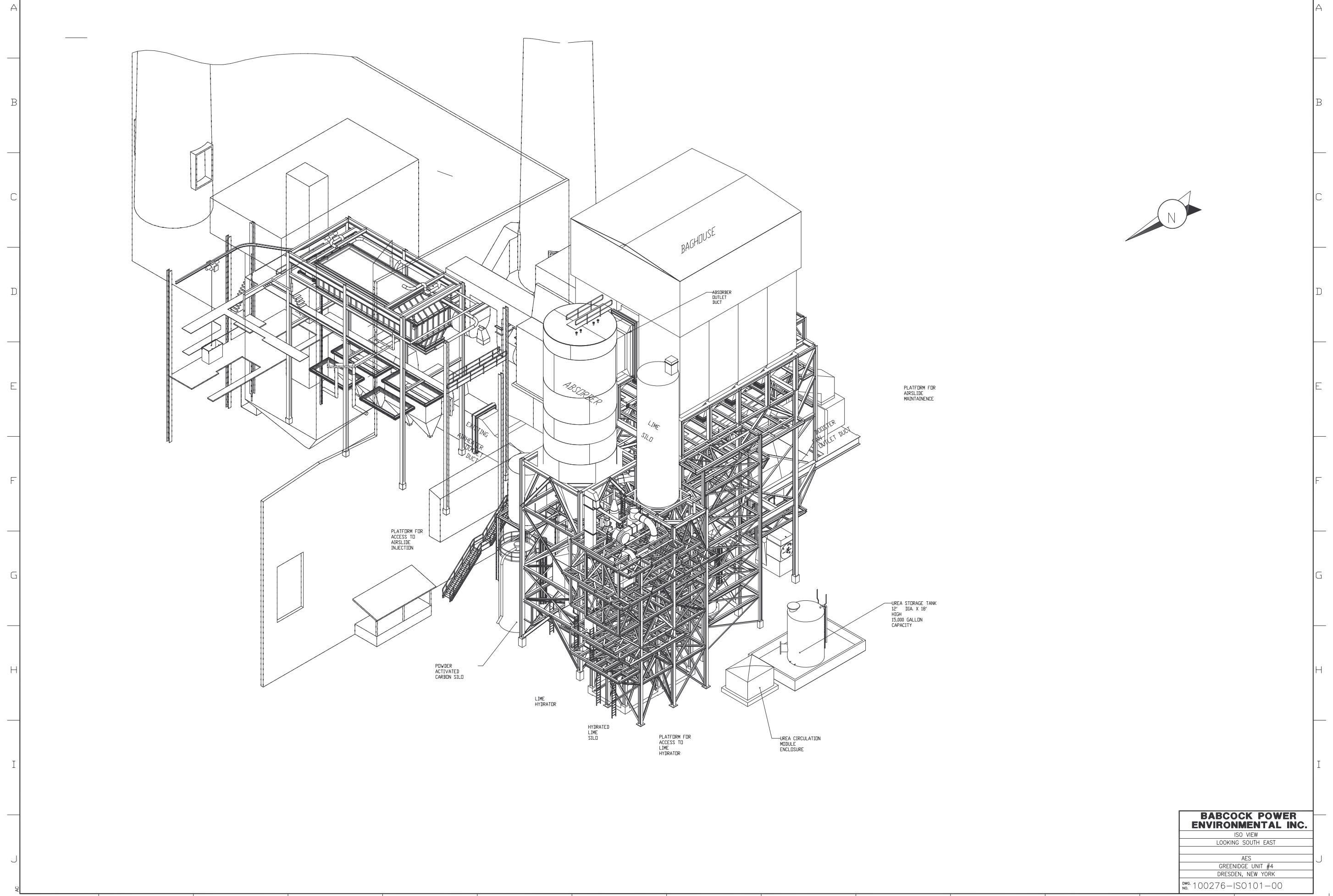

BABCOCK POWER ENVIRONMENTAL INC.	
ISO VIEW	
LOOKING SOUTH EAST	
AES	
GREENIDGE UNIT #4	
DRESDEN, NEW YORK	
DWG. NO. 100276-ISO101-00	

1 2 3 4 5 6 7 8 9 10 11 12 13 14