

ABSTRACT

In order to increase the protons energy up to 8 GeV in a driver Linac, the particles must be accelerated through various stages and three different power levels (25kW, 100kW and 210kW) are required for the 325 MHz Fermilab Proton Driver couplers. The problem identified by the project is that no High RF power coupler for these cavities has ever been designed and produced using US industrial capabilities. AMAC proposed a novel resolution by development of innovative modular, multiple power levels, 325 MHz spoke cavities power couplers, which to meet three type cavities with one coupler design. The simulation and concept design are presented. The results of HFSS, MAFIA, ANSYS, and Multipacting are also discussed.

INTRODUCTION

Various applications of superconducting Radio-frequency (RF) Accelerators in many fields around the world have been rapidly increased. High power RF windows are critically important to the reliability of storage rings and linear accelerators. If a window breaks, an entire accelerator section will go from high vacuum up to air, causing the loss of a great deal of time and money in maintenance costs

The Fermi National Accelerator Laboratory (FNAL) Proton Linac using 325MHz spoke cavities requires power couplers providing optimal power transmission from warm part into cold resonator. The couplers are grouped in multiple power levels include 25kW, 102kW, and 210kW. It is of the strong interest from both AMAC and FNAL to develop a universal and reliable power coupler design based on AMAC's long-term experience on coupler R&D.

To power up these low- β cavities, input couplers with high reliability and low cost are strongly demanded. Main Parameters for the Couplers:

Frequency: 325 MHz

Peak Power: 210 kW (50 couplers), 102 kW(30 Couplers), 25 kW (30 Couplers)

Duty Cycle: 1.5 %

Double, and alternatively single window design

Coaxial line impedance: 50 Ohm

Main Technical Goals

VSWR lower than 1.10

Low multipacting levels

Good thermal and vacuum performance

Reduced fabrication complexity

Minimize cryogenic losses

CAVITY, COUPLER & Qext

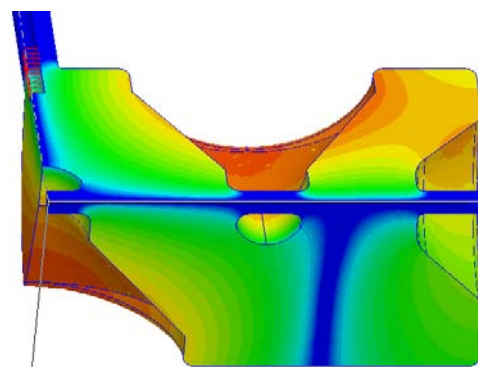
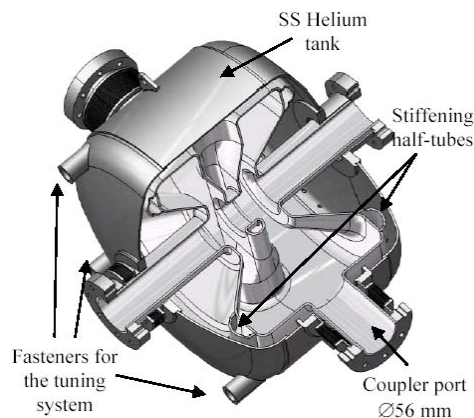

Figure 1: Spoke Cavity and a coupler simulation.

A significant cost driver for high power coaxial window couplers used in accelerators is the low production quantity and the use of non-standard components that are chosen to maximize performance:

- The use of standard parts
- Use as many as possible identical components
- Reduce fixtures required for the fabrication.
- Use of flexible metal members as design elements to eliminate the need for bellows.
- The use of the optimum joining process for the associated assembly operation
- TiN coatings to minimize multipacting.

Three concerns: (1) How to significantly reduce the cost, (2) How to further improve the technical performance and the reliability, (3) How to reduce the

conditioning time. Fig 1. is the cavity and coupler simulation.

Three design versions were studied and analyzed for RF fields and dissipation losses, multipacting activity, and heat losses to the 80K and 4K cryogenic systems.

Option 1: Fig. 2.

RF Coupler with Cold and Warm Windows, Vacuum or Dry Nitrogen between windows.

The windows assembly is installed after the cavity has been inserted into the cryostat. The space between the two windows is pumped to maintain the vacuum, or it can be filled with dry nitrogen.

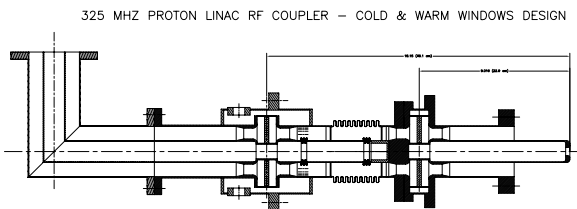

Figure 2: Schematic of Option 1.

Option 2: Fig. 3.

Double Warm Window RF Coupler with Self-kept Vacuum or Dry Nitrogen Fill between Windows

In this option two windows are placed in close proximity of each other in the warm section of the coupler, and the space between them is pumped to maintain the vacuum.

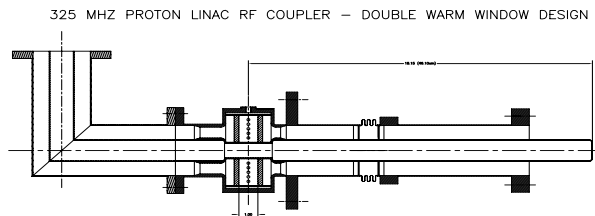

Figure 3: Schematic of Option 2.

Option 3: Fig. 4.

Single Warm window. The single warm window design is the simplest in comparison with option 1 and option 2. At not very high RF power it can also be reliable and cost effective.

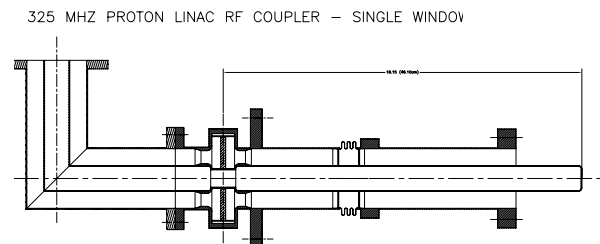

Figure 4: Schematic of Option 3.

Calculations were performed for the coupler to obtain the maximum Q_{ext} with the single, double and triple spoke cavities. Fig. 5 shows Q_{ext} of a triple spoke cavity.

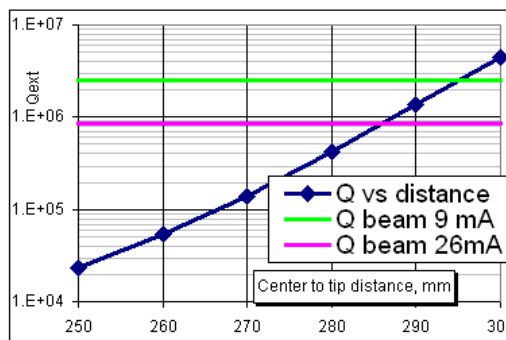

Figure 5: Q_{ext} : Triple Spoke Cavity. $\beta=0.62$, 79mm port.

MULTIPACTING CALCULATIONS

The multipacting properties were calculated using a computing code to track electron trajectories in electromagnetic fields. Secondary electron emission data for copper extending down to 50 eV on the lower energy side was used in the calculations for all copper and copper plated surfaces. The secondary emission values for TiN were used for the ceramic window surface. The results of the multipacting analysis for the three proposed options are shown in the Phase-I final report. The results of the calculations provide a good indication that the specified power level can be reached without special problems during RF conditioning.

Only traveling wave condition is presented here (all completed results in Phase I report). We have found certain MP power levels on both side of window. All of them are high order multiple points multipacting processes. It is less harmful than one point one order MP process. Only a few secondary yield electrons are starting from the surface of window. We should pay much attention to this situation. Some basic parameters we used in our calculation are listed here: frequency=325MHz, $R=0$, $E_{ps}=9.8$, thickness of window=6.35mm. Detailed information of electron trajectories is shown below.

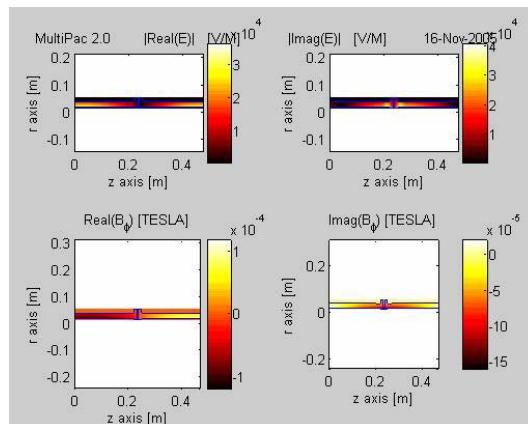

Fig.6. and Fig. 7. show some of the Multipacting simulation results.

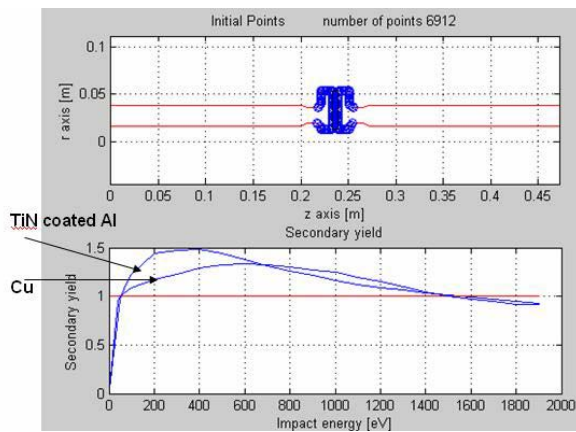

Figure 6: Field map and initial points/secondary yield Coefficients

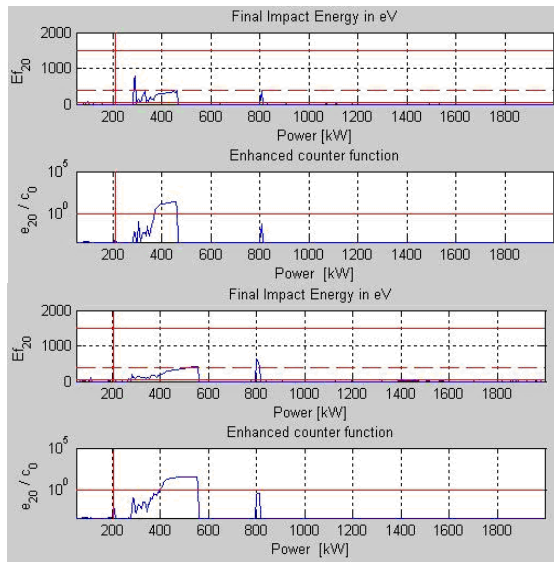

Figure 7: Final impact energy and enhanced counter function of warm and cold sides.

HEAT TRANSFER AND STRESS CALCULATIONS

There are three regular heating sources in the RF power couplers: RF heating in the RF carrying surfaces and the ceramic window, solid conduction from higher temperature regions, and radiation from the higher temperature surfaces. The thermal and stress analysis were performed with the ANSYS using the input values from HFSS. The material properties were defined by algorithms developed at DESY and AMAC to take into account the temperature and the respective thermal conductivity and electrical losses at each mesh point. The Relative Resistivity Ratio values (RRR) corresponding to the copper plating and solid after brazing were used in these algorithms. The thermal conductivity values corresponding to the different temperatures for the aluminum oxide were used for the ceramic windows. The materials, parts dimensions, and material combinations were varied until the optimum thermal performance was obtained. In all radiation losses calculations, the

emissivity for ceramic was taken as 0.8, and for copper it is 0.2.

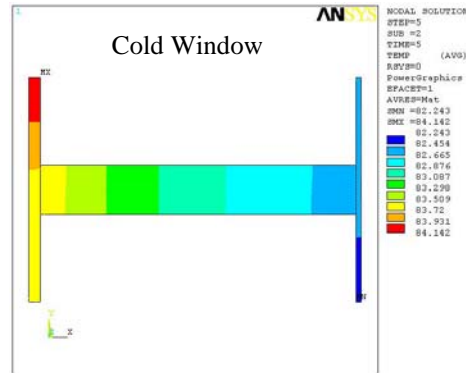
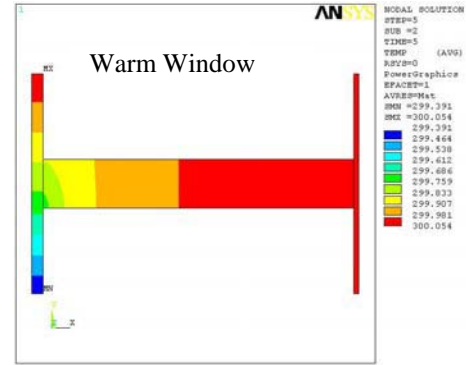

Figure 8: Temperatures in the warm and cold window, Warm and Cold Window Design, with RF

CONCLUSION

All technical design objectives have been achieved. The successful results present the basis for the design, fabrication, and RF testing of prototype 325 MHz high power RF couplers. A coupler prototypes will be fabricated and RF power tested in Phase-II to validate the design of the selection option for application at FNAL.

REFERENCES

- [1] S. Geer, Proton Driver, Super Neutrino Beam & Neutrino Factory, ICFA-HB2004.
- [2] B. Foster, W. Chou, The Fermilab Proton Driver Project, ICFA-HB2004.
- [3] Phase I Scientific and Technical report on 325 MHz High RF Power Coupler for FNAL Spoke Cavities, by AMAC for DOE, 4/15/2006.
- [4] Q. S. Shu et al., "Five Projects of High RF Power Input Couplers & Windows for SRF Accelerators", SRF Workshop, Hamburg, Germany, September 2003.
- [5] Q. S. Shu, et al., "Design and Fabrication of Input RF Coupler Windows for SNS Project", High RF Power Workshop, JeffersonLab, NewportNews, VAUSA 1992.