

# An Approach towards a Long-life, Microwave-assisted H<sup>-</sup> Ion Source for Proton Drivers\*

R. Keller,<sup>a</sup> M. Regis, J. Wallig, S. Hahto, M. Monroy, A. Ratti, and D. Syversrud,  
R. Welton,<sup>b</sup> and D. Anderson<sup>b</sup>

*Lawrence Berkeley National Laboratory, Berkeley, CA, USA*

<sup>a</sup> *present affiliation: Los Alamos National Laboratory, Los Alamos, NM, USA*

<sup>b</sup> *SNS at Oak Ridge National Laboratory, Oak Ridge, TN, USA*

**Abstract.** This paper reports on experiments aimed at developing a new high-intensity H<sup>-</sup> ion source with long lifetime whose concept had recently been introduced. Starting from the motivation for this effort, several steps of the earlier development work are recapitulated, and the performance of the latest design variant is discussed in detail. The basic concept consists in coupling an ECR ion source to a standard SNS multi-cusp H<sup>-</sup> ion source that is driven by pulsed dc, rather than rf, power. As a key result, an electron beam of 1.5 A current has been extracted from the ECR discharge operating at 1.9 kW c. w. power, and a maximum discharge current of 17.5 A was achieved in the H<sup>-</sup> ion source. Production of H<sup>-</sup> ions, however could not yet been demonstrated in the one, preliminary, experiment conducted so far. The paper concludes by outlining further envisaged development steps for the plasma generator and an expansion towards a novel extraction system.

**Keywords:** Negative hydrogen (H<sup>-</sup>) ion source. Proton driver injector.

**PACS:** 29.25.Ni

## INTRODUCTION

Next-generation Proton Drivers that include an accumulator ring will have to rely on H<sup>-</sup> ion sources with key performance parameters in the areas of beam current, duty factor, and time-between-services that exceed the present state-of-the-art by a wide margin. A novel concept for creating intense beams of negative hydrogen ion beams had been presented in this workshop series [1] with a description of the first steps towards its realization. In this ‘HYBRIS’ approach, an Electron Cyclotron Resonance (ECR) ion source [2, 3] operating at 2.45 GHz frequency is utilized as a primary plasma generator and coupled to an SNS-type multi-cusp H<sup>-</sup> ion source [4, 5]. This secondary source utilizes the plasma electrons produced in the first stage and is driven by pulsed d. c., rather than rf, power in a cold-cathode configuration, thus avoiding the use of filaments which are the cause for the short lifetimes of conventional H<sup>-</sup> sources or of an internal rf antenna that is a performance-limiting element in the present version of the SNS ion source. Initial tests were performed to assess two aspects of this approach: 1), to

check the functionality of the available SNS ion source, the so-called startup source that is identical to the delivered SNS production units in all major technical details, driven by rf power as usual; and 2), to measure the maximum intensity of an electron beam that could be extracted from the ECR plasma generator operated in c. w. mode. The geometry of the electron extraction system was based on computer simulations. The rf-driven SNS ion source alone delivered an H<sup>-</sup> beam of about 15 mA without any cesiation of the inner collar, quite close to the peak performance that had been registered under these conditions before. The ECR ion source, on the other hand, produced a d. c. electron beam of up to 1.5 A current when operated at 1.9 kW microwave power. Both these fundamental results looked very encouraging in view of the production of an H<sup>-</sup> beam by the combination of the two components.

## EARLY EXPERIMENTS

In the initial HYBRIS configuration, see Figures 1 and 2, an electron beam was extracted from the ECR

\* This work supported by Office of Basic Energy Sciences, U.S. Department of Energy under Contract No. DE-AC03-76SF00098.

chamber at up to 5 kV extraction voltage and decelerated to about 100 eV energy upon injection into the H<sup>-</sup> discharge chamber. The attempt to strike a discharge in the multi-cusp chamber, however, failed because the gas pressure in this chamber was too low, and when more hydrogen gas was fed directly into this second chamber to raise the pressure there, a discharge was struck instead in the electron extraction gap near the ECR, and the electron beam could not be accelerated at all under these conditions.

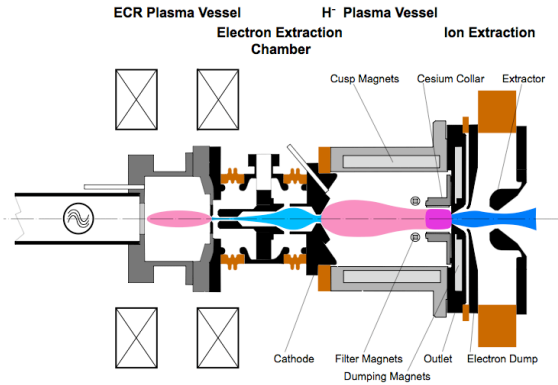

**FIGURE 1.** Schematic of HYBRIS in its first configuration.

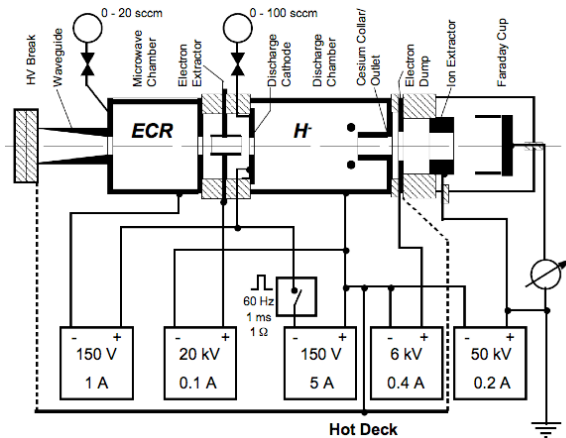

**FIGURE 2.** Electrical circuit of HYBRIS in its first configuration. Voltages and currents given represent the nominal values; operational values may be lower than those.

Therefore, the configuration was changed, eliminating the elaborate electron extraction system entirely and positioning the ECR outlet aperture a few mm upstream of the cold-cathode aperture. After several at-

tempts, a weak discharge could finally be struck in the multi-cusp chamber when the ECR chamber was held on the same potential as the cold cathode.

## PRESENT STATUS

In the most recent configuration, the ECR discharge chamber is directly coupled to the multi-cusp chamber, with the ECR outlet flange being replaced by the cold cathode itself, see Figures 3 and 4. Electrons are now transferred to the multi-cusp chamber by ambipolar diffusion, and ignition of a discharge in the multi-cusp chamber is no longer a problem at all.

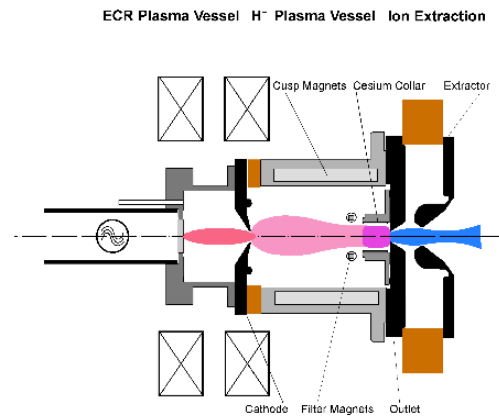

**FIGURE 3.** Schematic of HYBRIS in its most recent configuration.

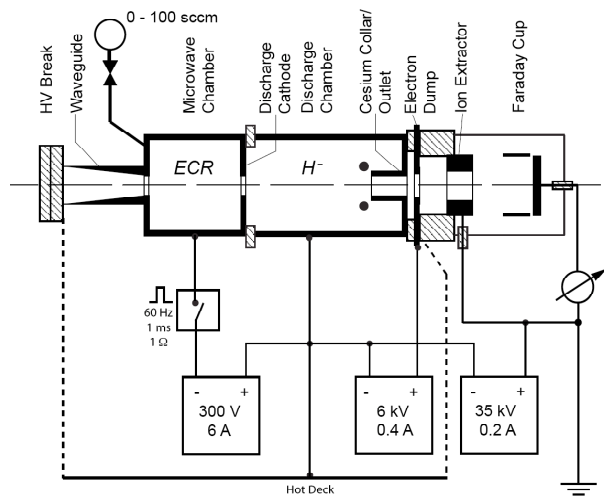

**FIGURE 4.** Electrical circuit of HYBRIS in its most recent configuration. Voltages and currents given represent the nominal values; operational values may be lower than those.

The price for this experimental achievement lies in the reduction of flexibility: With the formerly installed electron beam extraction system the energy of the electrons injected into the multi-cusp chamber could in principle have been adjusted to arbitrary values. If these primary electrons now indeed have too high an energy to be compatible with high survival rates of  $H^-$  ions produced inside the cesium collar then this energy must be damped down by extending the length of the multi-cusp chamber, thus enhancing the collision rates between primary electrons and cold particles.

With the forward microwave power at the maximum amplitude of 1.9 kW, gas flow of 35 sccm, and 150 V effective discharge voltage, a discharge current of 17.5 A could be generated in the multi-cusp chamber. The reflected microwave power amounted to 450 W under these conditions, possibly indicating that the plasma density in the ECR chamber had reached a saturation level where additional forward power is just reflected. An example of a slightly lower discharge current pulse is shown in Fig. 5. The axial magnetic field in the ECR chamber axis marginally exceeded the resonance level of 845 G over the entire length of the chamber with the implication that exact resonance conditions are achieved on the surface of an elongated, ellipsoid-like, volume that intersects the dielectric window upstream on a narrow circle.

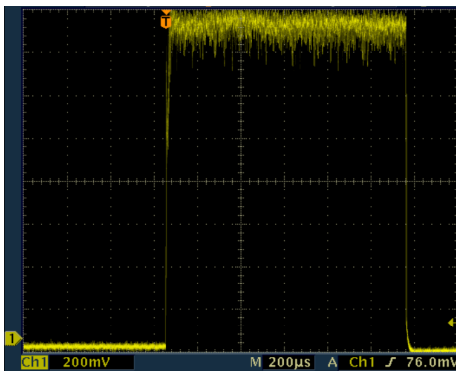
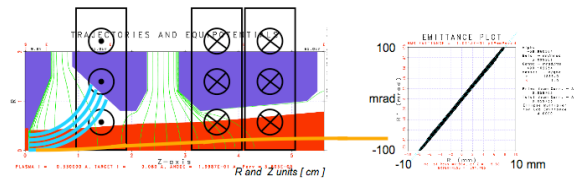

**FIGURE 5.** 15.2-A discharge pulse of 1.1 ms duration, 6.6% d.f. in the multi-cusp chamber of HYBRIS.

So far only one, very brief, attempt has been made to extract negative particles from the multi-cusp chamber in this configuration, but no clear evidence of negative ions was recorded in the second half of the Faraday cup. The collar was not cesiated at all in this test. Judging from the results obtained with a filament driven, cesiated ion source [7], the discharge current might have to be raised by at least a factor of three, to start producing  $H^-$  ions in the 10-mA range.

## EXTRACTION SYSTEM

During the work described here, no attempt was made to remove the electrons from the extracted beam; the former ‘electron dumping’ electrode of the SNS  $H^-$  ion source had been taken out of the extraction gap. A novel concept is instead being pursued in simulations, inspired by earlier work described elsewhere [6]. In this approach, electrons and  $H^-$  ions are extracted by a two-gap extraction system, which carries permanent dipole magnets of anti-parallel, transverse, orientation. The pole field strengths are approximately equal (in reality these strengths can be adjusted by varying the gap widths), but the second magnet pair is twice as thick as the first one, thereby compensating for the deflection that the ions are experiencing by the first magnet field. A half section of a simulation plot with schematic magnet shapes is shown in Fig. 6, and the results of an approximate analytical calculation for this case are shown in Fig. 7.



**FIGURE 6.** Proposed two-gap extraction system: 60-mA beam simulation of a magnet-free system using PBGUNS [8]. The normalized  $r/r'$  emittance is  $0.1 \pi$  mm mrad. Sketches of the electron (blue) and ion (orange) trajectories resulting from the action of the dipole magnets are superimposed. Electrode potentials are, from left to right, 65, 40, and 0 kV, respectively.

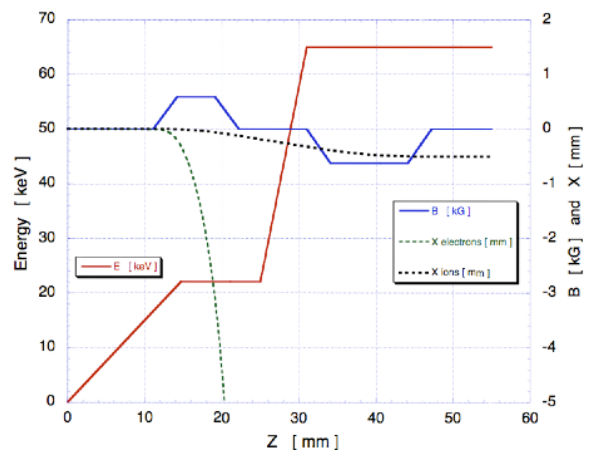

**FIGURE 7.** Plot of analytical calculations illustrating the effect of anti-parallel transverse magnet fields (blue trace) on electron (green dotted line) and ion (black dotted line) trajectories. Particle energies are indicated schematically by the red line (left scale).

## FUTURE WORK

At this time it is still uncertain if the HYBRIS concept as presented here will succeed when using an ECR driven plasma cathode because by far not all accessible parameter ranges have yet been investigated. It might be possible to raise the pulsed discharge current significantly by applying higher microwave power levels to the ECR discharge while keeping the gas flow at much lower values than in the rather hurried tests so far performed. Pulsed operation of the ECR would reduce the average load of extracted electrons experienced now by the high-voltage power supply under c. w. conditions, and pulsed microwave amplifiers are commercially available in the 8 kW range, largely exceeding the power output of the currently used c. w. unit.

If the plasma density achievable in the ECR chamber with 2.45 GHz microwaves indeed restricts the H<sup>+</sup> beam current to unacceptably low levels one could think of employing a different discharge mechanism for the plasma cathode. For this purpose, the Helicon devices widely used in plasma technology applications [9] appear to be very attractive, with plasma densities in the 10<sup>14</sup> cm<sup>-3</sup> range being reported. A slightly different source configuration including a Helicon driven discharge has been recently proposed [10].

## REFERENCES

1. R. Keller, P. Luft, M. Regis, J. Wallig, M. Monroy, A. Ratti, D. Syversrud, R. Welton, and D. Anderson, "A Hybrid Ion-Source Concept for a Proton Driver Front-End," *AIP Conf. Proceedings* **773**, pp. 104 – 106, American Inst. of Physics, Melville, NY (2005).
2. T. Taylor and J. S. C. Wills, "A high-current low-emittance dc ECR proton source," *Nucl. Instr. Methods* **A 309**, 37 (1991).
3. The ECR ion source was kindly loaned to us by Argonne National Laboratory. Assistance by J. Nolen, R. Pardo, and R. Scott is thankfully acknowledged.
4. R. Keller, R. Thomae, M. Stockli, and R. Welton, "Design, Operational Experiences and Beam Results Obtained with the SNS H<sup>+</sup> Ion Source and LEBT at Berkeley Lab," *AIP Conf. Proc.* **639**, New York: American Institute of Physics, 2002, pp. 47-60.
5. R. F. Welton, M. P. Stockli, S. N. Murray, and R. Keller, "The status of the spallation neutron source ion source," *Rev. Scientific Instrum.* Vol. **75** (5), 1793-1795 (2004).
6. M. Tanaka et al., "Investigation of beam deflection reduction and multi-beamlet focus at a large-area negative ion source for a neutral beam injector with 3-D beam trajectory simulation," *Nucl. Instrum. Methods in Phys. Res.* **A449**, 22-35 (2000).
7. H. Oguri, Y. Okumura, K. Hasegawa, Y. Namekawa, and T. Shimooka, "Development of an H<sup>+</sup> Ion Source for the High Intensity Proton Linac," *Rev. Scientific Instrum.* Vol. **73** (2), 1021-1023 (2002).
8. J. E. Boers, *PBGUNS Manual*, available through Thunderbird Simulations, Garland, TX., 75042, USA.
9. Lieberman and Lichtenberg, "*The Principles of Plasma Discharge and Material Processing*", Wiley, New York, 1994.
10. R. F. Welton, M. P. Stockli, and S.N. Murray, "Advances in the Performance and Understanding of the SNS Ion Source," Proc. 11<sup>th</sup> Int. Conf. on Ion Sources, Caen, France, Sept. 12-16, 2005; accepted for publication by *Rev. Scientific Instrum.* (2006).