

ORNL/TM-2005/34

Field Testing of Energy-Efficient Flood-Damage- Resistant Residential Envelope Systems Summary Report

June 2004

Prepared by

H. Aglan, PhD

College of Engineering, Architecture and Physical Sciences

Tuskegee University, Tuskegee, Alabama

and

R. Wendt and S. Livengood

Buildings Technology Center, Residential Buildings Group

Oak Ridge National Laboratory, Oak Ridge, Tennessee

This report was prepared as an account of work sponsored by an agency of the United States Government. Neither the United States government nor any agency thereof, nor any of their employees, makes any warranty, express or implied, or assumes any legal liability or responsibility for the accuracy, completeness, or usefulness of any information, apparatus, product, or process disclosed, or represents that its use would not infringe privately owned rights. Reference herein to any specific commercial product, process, or service by trade name, trademark, manufacturer, or otherwise, does not necessarily constitute or imply its endorsement, recommendation, or favoring by the United States Government or any agency thereof. The views and opinions of authors expressed herein do not necessarily state or reflect those of the United States Government or any agency thereof.

**Field Testing of
Energy-Efficient Flood-Damage-Resistant Residential Envelope Systems
Summary Report**

H. Aglan, R. Wendt, and S. Livengood

June 2004

Prepared by
OAK RIDGE NATIONAL LABORATORY
P.O. Box 2008
Oak Ridge, Tennessee 37831-6285
managed by
UT-Battelle, LLC
for the
U.S. DEPARTMENT OF ENERGY
under contract DE-AC05-00OR22725

CONTENTS

	Page
LIST OF FIGURES	iv
LIST OF TABLES	ix
ACKNOWLEDGEMENTS	x
EXECUTIVE SUMMARY	xi
OVERVIEW	xi
PURPOSE	xi
METHODOLOGY	xii
FINDINGS AND CONCLUSIONS	xiii
Materials and Systems	xiii
Procedures	xvi
1. INTRODUCTION	1
2. PURPOSE	3
3. METHODOLOGY	5
TEST FACILITY DESCRIPTION	5
TEST MODULE DESCRIPTION	6
TESTING PROTOCOLS	7
INSTRUMENTATION	8
DOCUMENTATION	9
4. CONVENTIONAL RESIDENTIAL ENVELOPE SYSTEM: Modules S-1 (Slab on Grade), and C-1 (Crawl Space)	11
PURPOSE	11
DESCRIPTION	11
DOCUMENTATION OF TESTING	13
Chronology of Testing Modules S-1 and C-1	13
Inspection Findings	13
Photographic Documentation	14
Relative Humidity and Temperature Profiles	22
Materials Moisture Content	24
Mold Observations	33
Mechanical Properties Testing	34
DISCUSSIONS AND CONCLUSIONS	36
5. FLOOD DAMAGE RESISTANT RESIDENTIAL ENVELOPE SYSTEMS: Modules S-2 (Slab-on-Grade), C-2 (Crawl Space)	39
PURPOSE	39
DESCRIPTION	39

DOCUMENTATION OF TESTING.....	42
Chronology of Testing Modules S-2 and C-2.....	42
Inspection Findings.....	42
Photographic Documentation	43
Relative Humidity and Temperature Profiles	54
Materials Moisture Content	57
Mold Observations	62
Mechanical Properties Testing	63
DISCUSSIONS AND CONCLUSIONS	67
6. FLOOD DAMAGE RESISTANT RESIDENTIAL ENVELOPE SYSTEMS: Modules S-3 (Slab on Grade), C-3 (Crawl Space), and S-3a (Slab-on-Grade).....	70
PURPOSE	70
DESCRIPTION	70
DOCUMENTATION OF TESTING.....	78
Chronology of Testing Modules S-3 and C-3.....	78
Inspection Findings.....	78
Photographic Documentation	79
Relative Humidity and Temperature Profiles	86
Materials Moisture Content	90
DOCUMENTATION OF TESTING.....	96
Chronology of Testing Module S-3a	96
Observations During Flooding and Draining.....	96
Photographic Documentation	97
DISCUSSIONS AND CONCLUSIONS	105
7. SUMMARY OF CONCLUSIONS	108
MATERIALS AND SYSTEMS	108
Siding.....	108
Sheathing	108
Wood Framing	109
Insulation	109
Interior Wall Board.....	109
Wall Finishes	109
Exterior Doors	110
Interior Doors	110
Windows.....	110
Floor Structure.....	110
Floor Finishes	110
Foundation Vents.....	110
PROCEDURES	111
Punching Holes in Walls	111
Cleaning.....	111
Sanitizing.....	111
Restoring.....	111
Dry Flood Proofing.....	112

8. FOLLOW-ON WORK.....	113
DEVELOPMENT OF REPRESENTATIVE FLOOD WATER.....	113
DEVELOPMENT AND EVALUATION OF LABORATORY TESTING PROTOCOLS AND COMPARISON TO FIELD TEST RESULTS	113
DOCUMENTATION OF FINDINGS FOR USE IN STANDARDS DEVELOPMENT	114
APPENDIX A PROTOCOL 1, FIELD TESTING FLOOD-DAMAGE RESISTIVE RESIDENTIAL ENVELOPE SYSTEMS	115
APPENDIX B PROTOCOL 2, DRYING OUT TEST FACILITIES AFTER FLOOD WATER HAS BEEN DRAINED FROM BASINS	128
APPENDIX C PROTOCOL 3, DRYING OUT, RESTORATION, AND AUTOPSY OF TEST MODULES C2 AND S2.....	132
APPENDIX D EXAMPLES OF VISUAL EVALUATION FORMS	137

LIST OF FIGURES

Figure		Page
3-1	Test basin site plan.....	5
3-2	Section through crawl space basin.....	5
3-3	Crawlspace concrete block stem wall foundation located in test basin.....	6
3-4	Plan and elevation for crawl space module	7
3-5	Location of relative humidity, temperature, and moisture sensors.....	9
3-6	8 ft X 8ft crawl space module before flooding	10
3-7	8 ft X 8ft slab on grade module during flooding	10
4-1	(Left) Module S-1 (Slab-on-Grade Unit) during flooding.....	11
4-2	(Right) Module C-1 (Crawl Space Unit) during flooding.....	11
4-3	Floor Plan for Modules S-1 and C-1.....	14
4-4	Module S-1 (Walls 1&2) Pre-flood	15
4-5	Module S-1 (Wall 1) Post-flood, Day 8 before washing	16
4-6	Module S-1 (Wall 1) Post-flood, Day 15.....	16
4-7	Module S-1 (Wall 1) Post-flood, Day 29.....	17
4-8	Module S-1 (Walls 3&4) Mold growth above the water line on Day 29	17
4-9	Module C-1 (Wall 1) Pre-flood	18
4-10	Module C-1 (Wall 1) Post-flood, Day 8 before washing.....	18
4-11	Module C-1 (Wall 1) Post-flood, Day 15	19
4-12	Module C-1 (Wall 1) Post-flood, Day 29	19
4-13	Module S-1 (Wall 1, North Exterior Wall) Pre-flood.....	20
4-14	Module S-1 (Wall 1, North Exterior Wall) Post-flood, Day 4	20
4-15	Module S-1 (Wall 1, North Exterior Wall) Post-flood, Day 8	21
4-16	Module S-1 (Wall 1, North Exterior Wall) Post-flood, Day 15	21
4-17	Relative humidity versus time at three different locations in Module S-1	23

4-18	Temperature profiles for three different locations in Module S-1 and the Outdoor air temperature.....	23
4-19	The relationship between the moisture content and time of exterior and Interior wall studs in Module S-1 for 37 days	25
4-20	The relationship between the moisture content and time of exterior and interior wall studs for Module C-1 during the 37 days.....	26
4-21	Moisture content versus time for the siding on Module S-1.....	28
4-22	Relationship between the moisture content and time for the plywood sheathing.....	29
4-23	Moisture content versus time for the gypsum board on the interior wall of Module S-1	31
4-24	Moisture content versus time for the gypsum board in Module S-1 on the interior of Wall 3	31
4-25	Moisture content versus time for the gypsum board on the interior wall of Module C-1	32
4-26	Moisture content versus time in the gypsum board on the interior of wall 3 (south wall) in Module C-1	32
4-27	Optical micrograph at 5X, showing the size of typical molds.....	33
4-28	Four point bending samples from the gypsum board of Module C-1.....	35
5-1	(Left) Slab-on-Grade Module S-2 during flooding.....	40
5-2	(Right) Crawlspace Module C-2 during flooding.....	40
5-3	Floor plan for Modules S-2 and C-2.....	44
5-4	Module S-2 (Wall 4) Pre-Flood.....	46
5-5	Module S-2 (Wall 4) Day 8	46
5-6	Module S-2 (Wall 4) Day 10 – After washing with water.....	47
5-7	Module S-2 (Wall 4) Day 15- After sanitizing	47
5-8	Module S-2 (Wall 4) After Restoration	48
5-9	Module C-2 (Wall 2) Pre-flood	48
5-10	Module C-2 (Wall 2) Day 8 at re-entry	49
5-11	Module C-3 (Wall 2) Day 10 after washing with water	49
5-12	Module C-2 (Wall 2) Day 15 after sanitizing	50
5-13	Module C-2 (Wall 2) after restoration	50

5-14	Module C-2 (Wall 1) North wall, Pre-flood	51
5-15	Module C-2 (Wall 1) during flood.....	51
5-16	Module C-2 (Wall 1) Day 8 before washing	52
5-17	Inside of Module S-2 (Wall 4) at autopsy	52
5-18	Module C-2 – Body of module at final autopsy and demolition	53
5-19	Module S-2 – Foundation of module at demolition.....	53
5-20	Relative humidity versus time at three different locations in Modules S-2.....	55
5-21	Relative humidity versus time at three different locations in Modules S-2 for entire test period.....	55
5-22	Temperature profiles for three different locations in Module S-2 and the outdoor air temperature	56
5-23	The relationship between the moisture content and time for exterior and interior wall studs in Module S-2, first 8 days	58
5-24	Relationship between the moisture content and time for exterior and interior wall studs, subflooring and joist in Module C-2.....	58
5-25	Moisture content of the cement siding, Walls 2 and 3 versus time for Module S-2.....	59
5-26	Moisture content vs. time fiber reinforced gypsum panel interior walls in Module S-2	61
5-27	Moisture content vs. time fiber reinforced gypsum panel interior walls in Module C-2.....	61
5-28	Schematic diagram of Module S-2 showing the location of the flexure test specimens	63
5-29	Schematic diagram of Module C-2 showing the location of the flexure test specimens	64
5-30	Specimen geometry and loading configurations.....	64
5-31	Fractured specimens from fiber reinforced gypsum wall panels in Module S-2	66
6-1	Module S-3 Placement of flood proofing dam over window	73
6-2	Module S-3 Wall 1 Dam on window during flooding is staying in place	74
6-3	Module S-3 Exterior door dam	74
6-4	Installing an operable flood vent in Module C-3	75
6-5	Module C-3 Water draining out of open crawlspace flood vents	75
6-6	Floor plan for Modules S-3, S-3a and C-3	80

6-7	Module S-3 (Wall 3) Pre-flood.....	81
6-8	Module S-3 (Wall 3) Day 8 – Before washing.....	81
6-9	Module S-3 (Wall 3) Day 10 – After washing with water.....	82
6-10	Module S-3 (Wall 3) Day 15 – After sanitizing.....	82
6-11	Module C-3 (Wall 2) Pre-flood.....	83
6-12	Module C-3 (Wall 2) Day 8 – Before washing.....	83
6-13	Module C-3 (Wall 2) Day 10 – After washing with water.....	84
6-14	Module C-3 (Wall 2) Day 15.....	84
6-15	Module C-3 Interior Door – Pre-flood.....	85
6-16	Module C-3 Interior Door – Day 8.....	85
6-17	Relative humidity versus time at three locations in Module S-3.....	87
6-18	Relative humidity versus time at three locations in Module C-3.....	87
6-19	Relative humidity versus time at three different locations in Module S-3 for entire test period.....	88
6-20	Relative humidity versus time at three different locations in Module C-3 for entire test period.....	88
6-21	Relative humidity versus time in the crawl space, Module C-3.....	89
6-22	Temperature profiles for three different locations in Module C-3 and outdoor air temperature for test period.....	89
6-23	Crawl space temperature profile.....	90
6-24	The relationship between the moisture content and time for exterior and interior wall studs in Module S-3.....	91
6-25	The relationship between the moisture content and time for exterior and interior wall studs in Module C-3.....	92
6-26	Moisture content versus time for the gypsum board interior walls in Module S-3.....	93
6-27	Moisture content vs. time fiber reinforced gypsum panel interior walls in Module C-3.....	95
6-28	Silicon II caulking was installed on the threshold.....	97
6-29	Module S-3a, south wall with door dam and aluminum/butyl rubber adhesive sealant tape installed.....	98

6-30	Module S-3a, west wall with adhesive sealant tape installed	98
6-31	Module S-3a, north wall with window dam and adhesive sealant tape installed.....	99
6-32	Module S-3a, east wall with adhesive sealant tape installed	99
6-33	Module S-3a, south and west walls being inspected	100
6-34	Module S-3a south wall during flooding	100
6-35	Module S-3a Interior southeast corner of Room S-301 after second dry flood proof test....	101
6-36	Module S-3a Interior south wall after second dry flood proof test.....	101
6-37	Module S-3a Interior southwest corner of Room S-301 after second dry flood proof test...	102
6-38	Module C-3, Wall 1, Exterior	102
6-39	Module C-3, Wall 2, Exterior	103
6-40	Module C-3, Wall 3, Interior	103
6-41	Module C-3, Wall 4, Interior	104
6-42	Module C-3, Wall 5, Interior	104
1-A	Procedures for flood-resistance tests of residential envelope system.....	118

LIST OF TABLES

Table	Page
3-1	Timeline of Testing Protocol..... 8
4-1	Building Materials and Configuration for Test Module S-1 12
4-2	Building Materials and Configuration for Test Module C-1..... 12
4-3	Flexural Strength and Modulus of siding for Module S-1 34
4-4	Flexural Strength and Modulus of siding for Module C-1 34
4-5	Flexural Strength of Gypsum Board for Module S-1 35
5-1	Building Materials and Configuration for Test Module S-2 40
5-2	Building Materials and Configuration for Test Module C-2..... 41
5-3	Mold count data for Module S-2 62
5-4	Mold count data for Module C-2..... 62
5-5	Mechanical properties of fiber cement lap siding and fiber reinforced gypsum interior wall panels for Module S-2 65
5-6	Mechanical properties of fiber cement lap siding, fiber reinforced gypsum interior panel, water-resistant gypsum exterior sheathing, and gypsum floor sheathing for Module S-2 66
6-1	Building Materials and Configuration for Module S-3 (also S-3a)..... 71
6-2	Building Materials and Configuration for Module C-3 72
1-	Example of a building assembly for which observations are to be made..... 123
2-	Evaluations matrix for the test protocol based on visual observations..... 124
3-	Evaluation matrix for the test protocol based on Measured Quantities..... 125

ACKNOWLEDGEMENTS

The authors wish to express their appreciation to the following individuals and organizations who have contributed significantly to this project.

Jonathan Stone and George James, U.S. Department of Energy, for support and funding of the planning stages of this project

Edward Laatsch, U.S. Department of Homeland Security, for support, funding and technical guidance throughout the project

Danna Bres and Richard Engel, U.S. Department of Housing and Urban Development, for support, funding and technical guidance throughout the project

Members of the Project Advisory Team for their support and technical guidance throughout the project including:

John Battles - Southern Building Code,
Richard Enlow, et al - Georgia Pacific,
George Sievert, et al - Society of Plastics Industries,
Fred Sippial - Construction Contractor,
Jim Ullett - USG Corp.,
Dan Wise - National Fenestration Rating Council

EXECUTIVE SUMMARY

OVERVIEW

Flooding results in more damage to buildings throughout the United States than any other single natural cause. Since 1990, property damage in the United States related to flooding alone is estimated to have exceeded \$40 billion, and millions of people have been left homeless. Homeowners are discouraged or prohibited from constructing new homes in flood-prone areas. However, when existing homes in these areas are flooded and must be repaired, the damage from future flooding can be minimized through renovation with flood damage resistant materials and methods.

The Department of Homeland Security, Emergency Preparedness and Response Directorate (formerly part of the Federal Emergency Management Agency - FEMA) defines flood damage resistance as the ability of materials, components, and systems to withstand direct and prolonged contact with flood water without sustaining degradation that requires more than cosmetic repair to restore it to its original condition. ORNL expanded the definition to include: individual materials that are considered flood damage resistant must also not cause degradation of adjacent materials or the systems of which the material is a part. Cosmetic repair is considered to include cleaning, sanitizing, and resurfacing (e.g. sanding, repair of joints, repainting) of the material. The cost of cosmetic repair should also be less than the cost of replacement of affected materials and systems. This expanded definition was applied to the results of the field testing. A complete definition of flood damage resistance should include both physical damage resistance (as described above) and resistance to harboring microbes, organism, or toxic materials with adverse human health consequences.

While flood damage resistance includes both physical and human health factors, the experimental modules were tested only for resistance to physical degradation that results from the wetting and drying cycle associated with flooding. Testing did not address the structural impact on the envelope of externally applied hydrostatic pressures. Flood depth was limited to two feet above floor level, which applies a pressure that is within the strength capabilities of typical wood frame construction. Post flooding mold growth was documented and selected specimens analyzed. Some test modules were also cleaned and sanitized to determine if mold growth could be controlled. Bacteriological and toxic materials testing were not performed during this series of tests.

PURPOSE

The primary purpose of the project was to identify materials and methods that will make the envelope of a house flood damage resistant. Flood damage resistant materials and systems are intended to be used to repair houses subsequent to flooding. This project was also intended to develop methods of restoring the envelopes of houses that have been flooded but are repairable and may be subject to future flooding. Then if the house floods again, damage will not be as extensive as in previous flood events and restoration costs and efforts will be minimized.

The purpose of the first pair of field tests was to establish a baseline for typical current residential construction practice. The first test modules used materials and systems that were commonly found in residential envelopes throughout the U.S. The purpose of the second pair of field tests was to begin evaluating potential residential envelope materials and systems that were

projected to be more flood-damage resistant and restorable than the conventional materials and systems tested in the first pair of tests. The purpose of testing the third slab-on-grade module was to attempt to dry flood proof the module (no floodwater within the structure). If the module could be sealed well enough to prevent water from entering, then this would be an effective method of making the interior materials and systems flood damage resistant. The third crawl space module was tested in the same manner as the previous modules and provided an opportunity to do flood tests of additional residential materials and systems.

Another purpose of the project was to develop the methodology to collect representative, measured, reproducible (i.e. scientific) data on how various residential materials and systems respond to flooding conditions so that future recommendations for repairing flood damaged houses could be based on scientific data. An additional benefit of collecting this data is that it will be used in the development of a standard test procedure which could lead to the certification of building materials and systems as flood damage resistant.

METHODOLOGY

The test facility was located on the experimental farm near an agricultural lake at Tuskegee University, Tuskegee, Alabama. Because reproducing conditions in full-sized residential structures would be extremely expensive and impractical, small, prototypical test structures—8 ft x 8 ft modules placed in outdoor basins were designed. The floor of one basin had a permanent slab-on-grade installed. The floor of the other basin had a permanent concrete footing and stem wall creating a crawl space.

The test modules simulated the materials and structures of actual homes subjected to representative flooding and drying conditions. One slab-on-grade module (S) and one module with a crawlspace (C) were built for each series of tests. Exterior walls were built with commonly used residential materials and according to standard construction practices. Each module had a window and an exterior door. Each module had an asphalt shingle roof. The crawlspace modules had two vents in the concrete block foundation. Each module had two rooms with an interior partition and interior grade door between the two rooms. Walls, floors, and ceilings were constructed and finished according to conventional construction methods. A variety of finish materials were tested.

Three series of tests have been conducted along with a supplementary test of the slab-on-grade module only. Testing protocols were developed in order to provide reproducibility and consistency of procedures among the tests.

In the first tests, two test modules were built with typical home construction materials and methods. The modules were flooded, and detailed information (data and observations through a variety of methods) were collected to determine how typical current residential construction materials and systems were affected during and after flooding. Test results from these materials and systems provided a baseline against which other materials and systems could be compared when they were tested in future modules.

Based on what was learned in these tests, a second set of tests was conducted. The second modules introduced different materials and systems that were expected to be more flood-damage resistant. In the second tests, unlike the first tests, the materials and systems were sanitized and cosmetically restored in order to assess their performance after exposure to a flood. At the end of the drying period, restoration of surfaces was attempted. Then modules were demolished and autopsied, and samples of the various materials made for testing and

observation.

The third slab-on-grade module was used to attempt dry flood proofing where no water would enter the structure. This was followed by a second attempt at dry flood proofing with the same module based on what was learned from the previous test. The third crawl space module was tested in the same manner as the previous modules and investigated additional flood damage resistant materials and systems.

Testing instrumentation included relative humidity transmitters, thermocouples that measured temperature, and moisture sensors installed in wall studs, wall surfaces, floor joists, and floor surfaces. A weather station provided data on ambient conditions during the test. A handheld moisture meter was used to determine material moisture content during the post flood drying period. Extensive documentation of the field tests was collected. Instrument data for relative humidity inside the modules, inside and ambient temperature, and moisture content of the various materials was recorded throughout the testing periods of all of the modules. Mold was sampled from the modules and tested in a laboratory to identify its type. Flexural strength and modulus were determined for various types of siding and wall board.

Detailed protocols were developed for visual observation. While visual observation is subjective, the protocols were developed to systematize these observations and make them as detailed and consistent as possible throughout the series of modules. Extensive photographic records were made as well. In three modules interior video recordings were made of the flooding of the units.

FINDINGS AND CONCLUSIONS

The experimental modules were tested using the expanded FEMA/ORNL definition for resistance to physical degradation which results from the wetting and drying cycle associated with flooding. Human health factors beyond mold growth were not evaluated in this testing. This limited performance criterion forms the basis of the following conclusions.

These conclusions should be viewed as *preliminary* since they are based on the results of the testing accomplished in this project and not on an accepted certifying test procedure as to the flood damage resistance of a particular material or system. A certifying test procedure must be developed and adopted before the identification of materials as “flood damage resistant” will satisfy the requirement for the use of such material by the building code. This project and other related activities are contributing to the development of that certifying test procedure. Testing for the residual health effects of flooding on otherwise flood damage resistant materials and systems has not yet been accomplished and could potentially change the outcomes.

Materials and Systems

The following section summarizes what was learned in testing while the chapters on the testing of Modules 1-3 provide an in-depth discussion of performance of materials and systems.

Siding - When exposed to floods newly installed and painted plywood and hardboard lap siding maintained reasonable dimensional stability and mechanical properties after they were dried. They also possessed good washability but remained discolored. However, older, weathered siding of the same materials and/or repeated wetting and drying over several cycles is projected

to significantly degrade the restorability of these siding materials. Vinyl and fiber cement sidings both withstood flood conditions better than hardboard lap siding and plywood siding. Both vinyl and fiber cement siding could be restored to preflood conditions through washing the portion below flood level.

Sheathing – Water-resistant, fiber reinforced gypsum sheathing (Fiberock manufactured by USG) maintained its integrity and mechanical properties. It dried to preflood levels during the drying period. Plywood sheathing maintained its integrity and mechanical properties. However, it had not dried to preflood levels after 30 days. Because water does not tend to escape quickly from behind plywood siding, the combination of plywood siding and sheathing was not considered a good flood damage resistant system. Lap siding tends to let moisture escape more quickly. If a flood damage resistant lap siding is employed, the use of plywood as sheathing is likely to make an acceptable damage resistant system.

Wood Framing - Moisture levels in wood studs that were above the flood level returned to preflood levels within the drying period. That portion of the studs below the flood level was drying towards the pre-flood moisture content, but had not in most cases achieved that level during the drying period. Wood studs were considered flood damage resistant as long as the wall system will permit them to continue to dry to normal levels.

Insulation - Fiberglass batt insulation appeared to retain moisture in the exterior wall cavities and below the floor. The moisture on the fiberglass fibers appeared to keep adjacent walls and floor materials wetter longer and could potentially contribute to long-term damage to the subflooring, floor and wall framing, and the gypsum board walls. When spray polyurethane foam (SPUF) insulation was used in the wall cavities, the wall board and wood studs in exterior walls dried at the same rate as in the interior walls with empty cavities. SPUF absorbs water very slowly and was undamaged by flooding. SPUF did not retain moisture and as such did not have a potentially negative impact on the flood damage resistance of the materials around it.

Interior Wall Board – When gypsum board was used with fiberglass batt insulation on exterior walls, the gypsum board lost about 50% of its flexural strength and remained wetter than on interior walls (without insulation). Interior gypsum board walls dried out and maintained flexural strength. If gypsum board is able to dry completely within an appropriate time it can be restored to preflood condition with cosmetic restoration. Fiber reinforced gypsum interior wall panels (ASTM C-1278), a non-water resistant product by USG called Fiberock, retained its initial strength and dried out during the drying period. Although it supported mold growth, it was able to be cleaned, sanitized, and restored. Water resistant, fiber reinforced gypsum exterior sheathing was applied to some interior walls. It too, maintained its initial strength and it dried out during the drying period. It did not support mold growth and its surface was easily cleaned and restored.

Wall Finishes - Ceramic tile performed well under flood conditions and showed no long-term deterioration. Both latex flat paint and latex semi-gloss enamel paint peeled, blistered and stained. Mold grew on both types of paint. High and low permeability paints were tested. Both types of paints had to be sanded and new coats of paint applied in order for the walls to be restored subsequent to flooding. Water based flat latex and oil based enamel paints were also compared. The water based latex flaked and blistered. Oil based flat enamel performed better

than any other paint that was tested. It flaked and blistered very little and was much easier to restore than other paints. Of all the paints tested, oil based flat enamel paint was found to be the most flood damage resistant. However, the impact of oil based enamel on the drying of adjacent materials and systems was not completely investigated in this testing. Vinyl wall covering blistered, peeled, and debonded after flooding. It damaged the surface of the gypsum board and it may inhibit drying of the substrate or wall system.

Exterior Doors - Exterior wood paneled, and exterior prehung metal clad, in wooden door frames were stained slightly, but were able to be washed and restored. Foam-filled fiberglass and foam-filled metal were restored to preflood conditions with minimal effort. The fiberglass and metal doors used in the second modules were re-used in the third modules and were once again easily restored.

Interior Doors - All interior doors that were tested were severely stained and some were warped, split, and peeling. Considering the relatively low cost of replacement, none of those tested were considered to be economically feasible to restore.

Windows - All vinyl and aluminum window frames were able to be restored to preflood conditions with minimal effort.

Floor Structure - The sealed concrete floor slab in all slab-on-grade modules remained undamaged during and after flooding. The wood sub-flooring retained very high moisture content throughout the drying period when unfaced fiberglass batt insulation was installed underneath the sub-flooring. When no floor insulation was used, the subflooring returned to preflood moisture levels during the drying period. Wood subflooring and framing insulated with fiberglass batts could experience long term moisture related problems.

Floor Finishes - Ceramic tile and quarry tile performed very well under flooding conditions and required only cleaning to be restored. All carpeting and padding became dirty and smelly after flooding. It also retains large amounts of moisture which can slow the overall drying rate throughout the house. Even if the carpet is able to withstand the flood, it should be removed for cleaning and drying and to promote drying within the home. Simulated wood flooring, a composite wood fiber and plastic material, warped and had open joints when left in place on the floor after the flood. When removed, washed, and stacked to dry after flooding, the simulated wood floor had much less warping and shrinkage, but the process of removal damaged some of the pieces.

Foundation Vents - The operable flood vents were closed prior to flooding and opened by themselves during the filling and draining of the flood water. They operated as designed. These vents were blocked open throughout the drying period. The crawl space humidity reached 100% and remained high during the drying period. This humidity level is unacceptable in the long term since it could contribute to both mold and wood decay. It is believed that the high humidity level in the crawl space was the result of the test module being placed in a basin that was subjected to significant amount of rain throughout the drying period. In order to keep from providing a path for mold to enter the interior of the module, the crawl space area must be effectively sealed from the interior of the house.

Procedures

Punching Holes in Walls for Drainage - Punching holes above the floor molding of the interior walls (a previously recommended practice) does not drain any water nor does it dry the wall any faster, especially if flood water has receded for several hours. In some instances if holes are not punched in the walls, the gypsum board can be easily repaired and restored. Punching holes in gypsum board walls to promote drainage is not an appropriate flood recovery procedure.

Cleaning - The cleaning protocols that were followed used a clear water rinse which did remove some dirt and staining, but not mold. A second washing with soap and water on selected materials (vinyl and fiber cement siding, fiberglass doors and window frames) did restore them to their pre-flood condition. After sanitizing with a bleach, trisodiumphosphate, and water solution most elements that were not physically damaged were able to be restored to their pre-flood condition.

Sanitizing - Severe mold growth occurred in the first tests where no attempt was made to clean or sanitize surfaces. Mold growth also occurred on exposed interior surfaces in most subsequent tests and efforts were made to sanitize surfaces and remove mold. After sanitization, there was no visible mold for the remainder of the testing period. Although no mold reappeared throughout the test period, the long term elimination of mold has not been verified. After demolition and autopsy of these units it was determined that there was very little or no mold growth in the non-exposed (hidden) portions of the structure that were not sanitized. Sanitizing appeared to work on the exposed surfaces of the modules to eliminate mold growth and it is therefore a recommended procedure in the restoration of flood-damaged homes. Sanitizing the non-exposed portions of the structure for mold control does not appear warranted base on what was seen during the autopsy.

Restoring - Restoration efforts ranged from washing of materials (e.g. vinyl siding, ceramic tile floors and sealed concrete slab) to washing and sanitizing (e.g. some interior wall panel and trim) to washing, sanitizing, resurfacing and repainting (e.g. other interior wall panels). Most flooring materials and interior doors tested required replacement, either because they could not physically be restored or they were not cost-effective to restore.

Dry Flood Proofing - Dry flood proofing was not achieved in either of the attempts to achieve it. While the door and window dams were effective in preventing the entry of water through doors and windows, water entered the units through other paths, such as the joint between the interior partition and the exterior walls at floor level. Although the joint between the sill plate and the concrete slab had been caulked, water entered there as well. Additional steps were taken in the second attempt, the external joint between the sill and the slab and other potential leak pathways on the exterior were sealed. Despite these efforts, flood water entered the modules. Dry flood proofing is not considered a viable approach to flood damage resistance.

1. INTRODUCTION

Flooding results in more damage to buildings throughout the United States than any other single natural cause. Since 1990, property damage in the United States related to flooding alone is estimated to have exceeded \$40 billion, and millions of people have been left homeless. Homeowners are discouraged or prohibited from constructing new homes in flood-prone areas. However, when existing homes in these areas are flooded and must be repaired, the damage from future flooding can be minimized through renovation with flood damage resistant materials and methods.

The Department of Homeland Security, Emergency Preparedness and Response Directorate (formerly part of the Federal Emergency Management Agency - FEMA) defines flood damage resistance as the ability of materials, components, and systems to withstand direct and prolonged contact with flood water without sustaining degradation that requires more than cosmetic repair to restore it to its original condition. ORNL expanded the criteria to include: individual materials that are considered flood damage resistant must also not cause degradation of adjacent materials or the systems of which the material is a part. Cosmetic repair is considered to include cleaning, sanitizing, and resurfacing (sanding, repair of joints, repainting) of the material. The cost of cosmetic repair should also be less than the cost of replacement of affected materials and systems. This definition was adopted for these experiments. A complete definition of flood damage resistance should include both physical damage resistance (as described above) and resistance to harboring microbes, organism, or toxic materials with adverse human health consequences.

While flood damage resistance includes both physical and human health factors, the experimental modules were tested only for resistance to physical degradation that results from the wetting and drying cycle associated with flooding. Testing did not address the structural impact on the envelope of externally applied hydrostatic pressures. Flood depth was limited to two feet above floor level, which applies a pressure that is within the strength capabilities of typical wood frame construction. Post flooding mold growth was documented and selected specimens analyzed. Some test modules were also cleaned and sanitized to determine if mold growth could be controlled. Bacteriological testing was not performed on this series of tests.

To identify the materials and methods that make a house flood damage resistant, the Residential Group of Oak Ridge National Laboratory's (ORNL) Buildings Technology Center, along with Tuskegee University's College of Engineering, Architecture, and Physical Science, designed, constructed, and tested a series of small full-scale modules to represent the response of various residential building envelopes to flood conditions.

Robert Wendt, architect, led the work at ORNL and Heshmat Aglan, PhD, mechanical engineer, led the work at Tuskegee University. The project was jointly funded by the U.S. Federal Emergency Management Agency (FEMA) and the U.S. Housing and Urban Development Department (HUD), and the U.S. Department of Energy (DOE). A steering committee of residential building professionals (materials manufacturers, a code official, and a general contractor) and flood experts (university based, consultants, Corps of Engineers) was brought together several times to advise the project team about project design and review plans, protocols, and experimental results.

During 2001, ORNL and Tuskegee developed the basic experimental plan and methodology by which to conduct the field tests. Two test basins were designed and built at Tuskegee University, Tuskegee, Alabama on an experimental farm next to an agricultural lake. The test basins were designed to hold one crawlspace and one slab-on-grade test module structure in each basin. The two 8 ft by 8 ft test module structures were designed.

Methods for measuring moisture in materials, relative humidity, and temperature before,

during, and after flooding were selected, and the equipment with which to take these measurements acquired. In order to guide the testing and provide consistency from one test to the next, the research team developed protocols for flooding, draining, cleaning, and drying the test modules. (Protocols are in Appendices A through C.) Materials to be used in the first test module were selected. (Materials lists are in the sections for each of the three sets of modules.)

During the summer and fall of 2001, the basins were constructed at Tuskegee and the first test modules (crawlspace and slab-on-grade) were built in the basins by a local construction contractor. The first test modules used materials and systems that were commonly found in residential building envelopes throughout the U.S. Future test modules introduced more flood damage resistant materials and systems than those used in current residential building envelopes. The first test modules (S-1 and C-1) would serve as the “baseline” by which future modules could be compared.

On Day 0 (November 12, 2001), the first slab-on-grade (S) and crawlspace (C) modules, Modules S-1 and C-1, were flooded to a depth of two feet above floor level. The basins were drained on Day 3 and the units were entered, inspected and opened on Day 8. The modules were allowed to dry until Day 31. Following the drying period the units were disassembled, autopsied, and analyzed.



Based on what was learned in the first test modules, new materials lists were developed for the second modules. The second modules were the first attempt to design for improved flood damage resistance. The second modules were also tested for restorability. The basins were flooded on Day 0 (April 10, 2002), drained on Day 3, and entered, inspected and opened on Day 8. The units were washed down with water on Day 10 and sanitized on Day 14. Restoration efforts of the units commenced on Day 37 and the drying period was considered ended on Day 40. Autopsy and mechanical testing began on Day 61, and final autopsy and demolition of the units occurred on Day 131.

In the third tests, Module C-3 further tested flood damage resistant materials and systems. Module S-3 was a first attempt at dry-flood proofing (no water within the structure). Prior to selecting materials and constructing the new modules, the project team developed methods and systems for dry-flood proofing the slab-on-grade unit. In the fall of 2002, the third modules were constructed and the project team carried out the dry flood proofing protocol on the slab-on-grade module. On November 7, 2002 the basins were flooded and the testing begun. With the failure of Module S-3 to achieve dry flood proofing, Module S-3a was a second attempt to dry flood proof a slab-on-grade module. The basin was flooded on February 11, 2003 and, because the interior of the unit flooded again, it was drained on the day of flooding. Some data was collected from test S-3a, however it did not follow the complete testing protocol.

2. PURPOSE

The primary purpose of the project was to identify materials and methods that will make the envelope of a house flood damage resistant. Flood damage resistant materials and systems may be used to repair houses subsequent to flooding. This project was also intended to develop methods of restoring the envelopes of houses that have been flooded but are repairable and may be subject to future flooding. Then if the houses flood again, damage will not be as extensive as in previous flood events and restoration costs and efforts will be reduced.

The purpose of tests on Modules S-1 and C-1 was to establish a baseline for typical current residential construction practice. The first test modules used materials and systems that were commonly found in residential envelopes throughout the U.S. The modules were flooded, and detailed information (data and observations through a variety of methods) were collected to determine how typical current residential construction materials and systems were affected during and after flooding. Test results from these materials and systems were intended to provide a baseline against which other materials and systems could be compared when they were tested in future modules. No attempt was made to restore these materials because current flood recovery manuals recommend the removal and replacement of materials exposed to flood water.

The purpose of Modules S-2 and C-2 was to begin evaluating potential residential envelope materials and systems that were projected to be more flood-damage resistant and restorable than the conventional materials and systems that had been tested before. In these modules, unlike the previous ones, the materials and systems were sanitized and cosmetically restored in order to assess their performance after exposure to a flood. At the end of the drying period, restoration of surfaces was attempted. Then modules were demolished and autopsied, and samples of the various materials made for testing and observation. The purpose of adding these procedures, beyond those done in the first tests was to determine not only how flood resistant the materials in these modules were, but also how restorable they were after flooding.

The purpose of testing in Module S-3 was to attempt to dry flood proof the module (no flood water within the structure). If the module could be sealed well enough to prevent water from entering the module, then this would be an effective method of making the interior materials and systems flood damage resistant. The sole purpose of Module S-3a test was to make a second attempt to dry flood proof the slab-on-grade module based on what was learned from test S-3. Module C-3 was tested in the same manner as the previous modules and provided the opportunity to test additional potentially flood damage resistant materials and systems.

An intended outcome of the project was to begin to develop and collect representative, measured, reproducible (i.e. scientific) data on how various residential materials and systems respond to flooding conditions. Although FEMA has developed limited instructions for repairing flood damaged houses, these recommendations were based on consensus opinions from previous flood experiences. Field testing according to defined and reproducible protocols had not been conducted. Project team members maintained that a variety of residential materials and systems should be tested according to representative field conditions with detailed monitoring of the behavior of these materials and systems. Monitoring should occur before, during, and after flooding and drying. Detailed, reproducible evaluation of systems as well as material performance was needed to determine what, in fact, are the most flood-resistant materials and systems. Consistent and reproducible procedures for cleaning and sanitizing structures should be tested for their effectiveness in representative field conditions. In order to optimize the opportunity to make flood-damaged houses more flood damage resistant, future recommendations for repairing flood damaged houses should be based on scientific data.

Another benefit of beginning to collect scientific data is that residential building materials manufacturers may want to develop certified flood damage resistant materials or systems. In

order to do so, consistent, laboratory-reproducible certification testing protocols need to be developed. These testing protocols need to be developed from a baseline of experimental data as well as measurable standards of flood resistance. Furthermore, current flood response recommendations need to be compared against experimental findings to determine if the flood response recommendations provide optimal flood resistance for residential envelopes in future flood events.

In the future, researchers hope to be able, through computer modeling, to develop more specific knowledge about how various building materials and systems that are subjected to flooding respond to various climactic conditions. In order to develop this computer modeling, data must be collected from closely monitored and measured field experiments in order to validate the model's output.

3. METHODOLOGY

TEST FACILITY DESCRIPTION

The test facility was located on the experimental farm near an agricultural lake at Tuskegee University. Two basins for the slab-on-grade and crawlspace test modules were designed and constructed. The floor/foundation of one basin had a permanent slab-on-grade installed. All slab-on-grade modules were built on this slab. The foundation of the other basin had a permanent concrete footing and stem wall. All crawlspace modules were built on this footing and stem wall. Figures 3-1 through 3-3 show the site plan for the basins, a section through one of the basins and a picture of the crawlspace foundation in the basin.

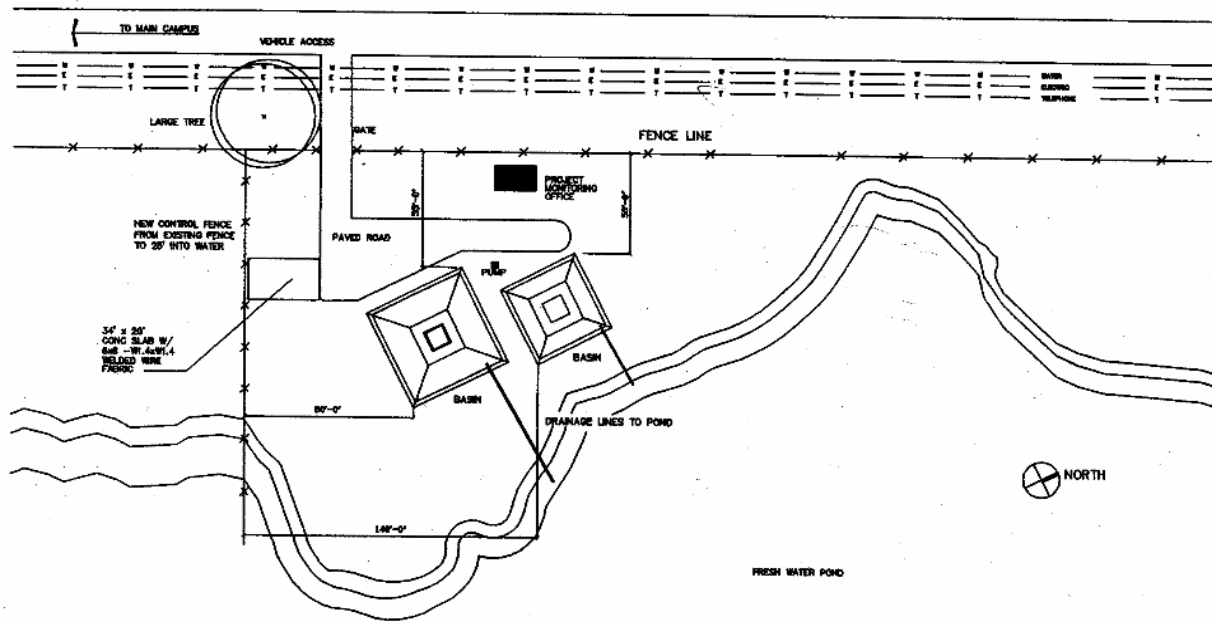

Figure 3-1 Test basin site plan

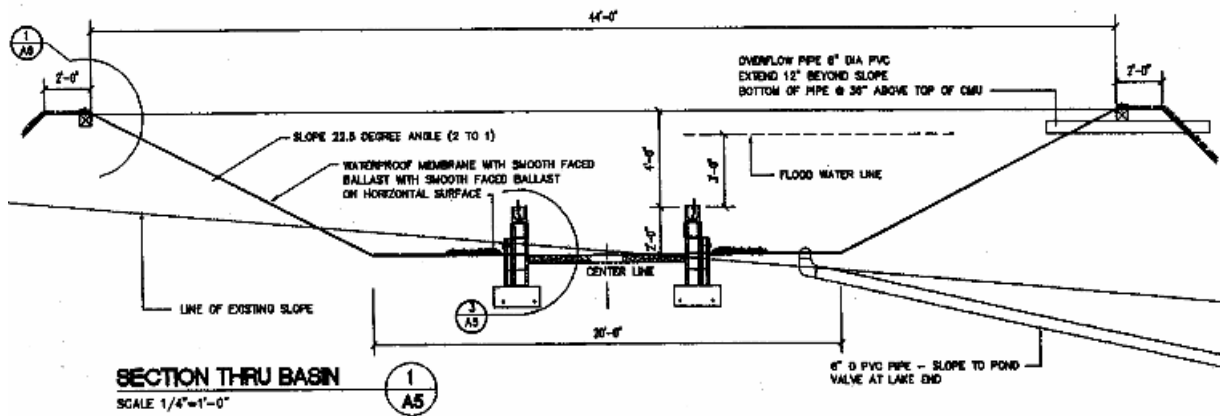

Figure 3-2 Section through crawl space basin



Figure 3-3 Crawlspace concrete block stem wall foundation located in test basin

TEST MODULE DESCRIPTION

The test modules simulated the materials and structures as well as representative flooding and real world drying conditions, while minimizing the cost of materials and construction. Because reproducing conditions in full-sized residential structures would be extremely expensive and impractical, small, prototypical test structures—8 ft x 8 ft modules placed in outdoor basins were designed and built. One slab-on-grade module and one module with a crawlspace were built for each series of tests. A sketch of the floor plan and elevations of one of the modules is shown in Figure 3-4. Exterior walls were built with commonly used residential materials and according to standard construction practices. Each module had a window and an exterior door. Each module had an asphalt shingle roof; the most commonly used residential roofing system. The crawlspace modules had two open vents in the concrete block foundation. The modules had two rooms with an interior partition and interior grade door between the two rooms. Walls, floors, and ceilings were constructed and finished according to conventional construction methods. A variety of finish materials were tested.

Three series of tests have been conducted along with a supplementary test of a slab-on-grade module. In the first tests in November of 2001, two test modules were built with typical home construction materials and methods. The detailed list of building materials and their configuration for the first modules are shown in Tables 4-1 and 4-2 in Section 4 of this document. Based on what was learned in the first test (Modules S-1 and C-1), a second set of tests was conducted in April of 2002. Modules S-2 and C-2 introduced different materials and systems that project participants expected would be more flood-damage resistant. In the third tests, Module S-3 was used to attempt dry flood proofing where no water would enter the structure, and Module S-3a was a second attempt at dry flood proofing. Module C-3 was tested in the same manner as the previous Modules C-1 and C-2.

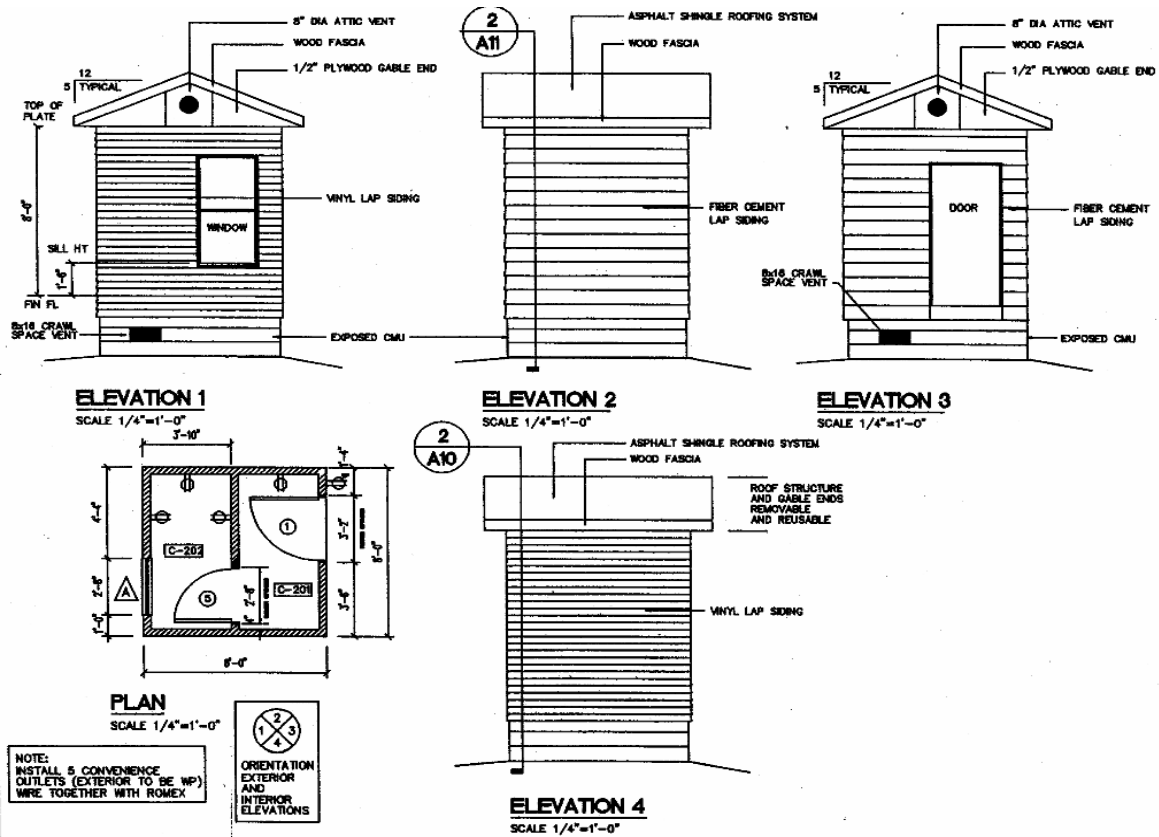

Figure 3-4 Plan and elevation for crawl space module

TESTING PROTOCOLS

A Protocol for Field Testing Flood Damage Resistive Residential Envelope Systems was developed. This protocol established the procedures for flooding and draining the test modules. (Appendix A.) A Protocol for Drying Out Test Facilities After Flood Water Has Been Drained from Basins was developed for the first test module (Appendix B). This protocol provided the steps that were followed in drying out the two test facilities after flood water has been drained from the basins. A Protocol for Drying Out, Restoration, and Autopsy of Test Modules was developed for Modules S-2, C-2, S-3, and C-3 (Appendix C). This protocol provided the steps that should be followed in drying out, sanitizing, and restoring the second and third sets of test modules after flood water was drained from the basins. Each of the test protocols followed the same time line shown in Table 3-1.

Table 3-1 Timeline of Testing Protocol

Timeline of Testing Protocol	
Day -7	Completion of construction and finishing
Day -4	Initiation of monitoring instruments
Day 0	Flooding of basins/modules
Day +3	Draining of flood basins (72 hours)
Day +8	Re-entry and opening doors/windows
Day +8	Remove mud, carpets; rinse surfaces
Day +10	Sanitize surfaces and continue drying
Day +31	End of measurements this module

INSTRUMENTATION

Three relative humidity transmitters were used in each module. These were model EW-03334-05 by Vaisala. The transmitter had an output between 4 and 20 mA with an accuracy of " 2 %. The data were recorded every 20 minutes during floods and every two hours after the modules were opened. The outdoor relative humidity was also recorded from the weather station.

The temperature in three different locations in each of the modules was monitored using thermocouples wired to a data logger located in the instrumentation trailer. A weather station was installed at the instrumentation trailer next to the basins and detailed weather data was recorded throughout the experimental period.

Moisture sensors were installed in wall studs, floor joists, and floor surfaces (See Figure 3-5). The sensors were installed prior to flooding and readings were taken every 20 minutes during the flood and every 3 hours after draining and throughout the drying period. Moisture in the interior wall surfaces and exterior siding was measured using a Delmhorst hand-held moisture sensor. This was done before flooding, upon reentering the modules after draining the basins, and throughout the remainder of the drying period.

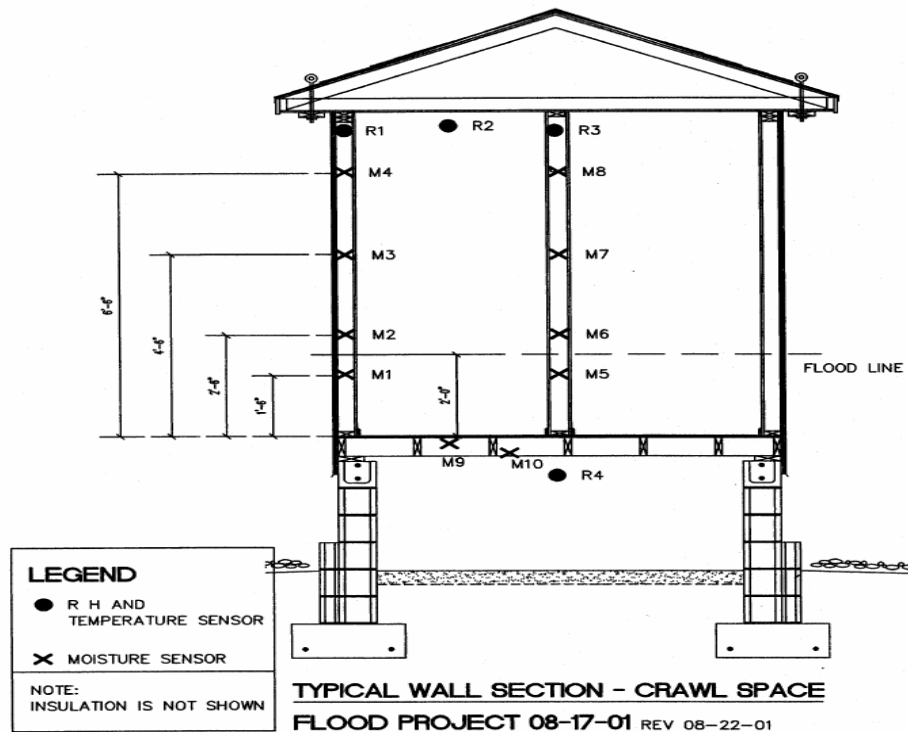

Figure 3-5 Location of relative humidity, temperature, and moisture sensors

DOCUMENTATION

Extensive documentation of the field tests was collected. Instrument data for relative humidity inside the modules, inside and ambient temperature, and moisture content of the various materials was recorded throughout the testing periods of all of the modules. Mold was sampled from the modules and tested in a laboratory to identify its type. Flexural strength and modulus were determined for various types of exterior siding and interior wallboard.

Detailed protocols were developed for visual and smell observation. While these observations are subjective, the protocols were developed to systematize these observations and make them as detailed and consistent as possible throughout the series of modules. Multiple observers followed the protocol and recorded what they saw and smelled in each module. Records of these observations were summarized and are listed in the sections of this document that describe the various modules.

Figures 3-6 and 3-7 reflect the extensive photographic records (digital still photography) that were made as well. Examples of these records are included in each of the sections of the document that report on the individual modules. In modules 3-C, 3-S, and 3-Sa, video recordings were made of the flooding of the units. The 3-C unit had foundation drains that were supposed to close during flooding and open during draining. The video recording of the 3-C unit showed how the foundation drains worked. The video recording of the 3-S and 3-Sa units showed where water entered the units.



Figure 3-6 8 ft x 8 ft crawl space module before flooding



Figure 3-7 8 ft x 8 ft slab on grade module during flooding

4. CONVENTIONAL RESIDENTIAL ENVELOPE SYSTEMS: Modules S-1 (Slab-on-Grade), and C-1 (Crawl Space)

PURPOSE

The main purpose of tests on Modules S-1 and C-1 was to establish a baseline for typical current residential construction practice. The first test modules used residential materials and systems that were commonly found in residential envelopes throughout the U.S. Test results from these materials and systems were compared with other materials and systems tested in subsequent modules.

These test modules also provided an opportunity to evaluate currently published recommendations and procedures for restoring flooded homes in a controlled environment. One current procedure for drying out flooded homes recommends punching one inch holes in gypsum board near the base of the walls to aid draining of the wall cavities. This procedure was followed in order to find out if it is really an effective way to help restore a house after a flood.

DESCRIPTION

To prepare for testing a Protocol for Field Testing Flood-Damage-Resistive Residential Envelope Systems (Appendix A) was prepared that sets procedures for filling and draining the basins. A separate Protocol for Drying Out Test Facilities After Flood Water Has Been Drained from Basins (Appendix B) was developed to provide the steps that are to be followed in drying out the two test modules after flooding.

In the first tests in November of 2001, two test modules were built with typical home construction materials and methods. One module (S-1) was built slab-on-grade and the other (C-1) had a crawlspace (see Figures 4-1 and 4-2). The building materials and their configuration for these modules are shown in Tables 4-1 and 4-2.



Figure 4-1 (Left) Module S-1 (Slab-on-Grade Unit) during flooding. The arrow shows the sensor cables coming from the attic.



Figure 4-2 (Right) Module C-1 (Crawl Space Unit) during flooding.

Component	Location	Material
Siding	North and East exterior walls	½" plywood siding (T1-11) with 1x3 battens at corners
	South and West exterior walls	Hardboard lap siding with 1x3 battens at corners
Sheathing	North and west exterior walls	½" plywood sheathing
	South and east exterior walls	½" plywood sheathing with 15# building felt
Insulation	All exterior walls	R-11 fiberglass batt insulation with Kraft paper facing (inside)
Housewrap	All exterior walls	Not used for test 1-S
Interior wall board	All interior walls	½" gypsum wallboard
Wall finishes	Room with window (S-101)	All walls: 2 coats latex flat white paint
	Room with exterior door (S-102)	North, West, and South walls: 2 coats latex semi-gloss enamel; East wall: ceramic tile
Vapor barriers	All walls	No vapor barrier used for test S-1
Doors	Exterior	1 ¾" thick exterior wood paneled door with glass lites, wood frame, to coats urethane varnish both sides
	Interior	1 3/8" interior pre-hung wood paneled door, wood frame, 2 coats latex enamel both sides
Windows	North wall	Aluminum, single hung (white), single pane
Electrical distribution	Interior walls	Traditional in-wall electrical wiring
Ceiling	Ceiling	3/8" plywood with 2 coats white interior latex paint.
Attic and roofing	Attic and roof	2 x 4 wood roof and ceiling joists @ 24" O.C., ½" plywood roof deck, asphalt shingle roof system, fiberglass R-19 insulation above ceiling
Floor structure	Floors	Concrete slab
Floor finishes	Room with exterior door (S-101)	Carpet with pad
	Room with window (S-102)	Concrete sealer, no floor covering

Component	Location	Material
Siding	North and East exterior walls	½" plywood siding (T1-11) with 1x3 battens at corners
	South and West exterior walls	Hardboard lap siding with 1x3 battens at corners
Sheathing	North and west exterior walls	½" plywood sheathing with 15# building felt
	South and east exterior walls	½" plywood sheathing
Insulation	All exterior walls	R-11 fiberglass batt insulation with Kraft paper facing (inside)
Housewrap	All exterior walls	Not used for test C-1
Interior wall board	All interior walls	½" gypsum wallboard
Wall finishes	Room with exterior door (C-101)	All walls: 2 coats latex flat white paint
	Room with window (C-102)	North and west walls: vinyl wall covering; south and east walls: 2 coats white latex enamel
Vapor barriers	All walls	No vapor barrier used for test C-1
Doors	Exterior	1 ¾" exterior pre-hung metal clad door in a wood frame; 2 coats latex enamel both sides
	Interior	Interior wood bi-fold door – full louver in a wood frame 2 coats latex enamel both sided
Windows	North wall	Single hung window, vinyl frame glazing ½' insulated glass
Electrical distribution	Interior walls	Traditional in-wall electrical wiring
Ceiling	Ceiling	3/8" plywood 2 coats latex enamel
Attic and roofing	Attic and roof	2 x 4 wood roof and ceiling joists @ 24" O.C., ½" plywood roof deck, asphalt shingle roof system, fiberglass R-19 insulation above ceiling
Floor structure	Floors	¾" plywood deck; 2 x 6 wood joists @ 16" OC; R-19 fiberglass batt insulation below
Floor finishes	Room with exterior door (C-101)	Carpet on pad
	Room with window (C-102)	Sheet vinyl

DOCUMENTATION OF TESTING

Chronology of Testing Modules S-1 and C-1

Basin Flooding Start:	November 12, 2001 (Day 0)
Basin Draining Start:	November 15, 2001 (Day 3, 72 hour flood)
Module Reentry (Left Open):	November 20, 2001 (Day 8)
Drying Period End:	December 13, 2001 (Day 31)
End of Monitoring	December 19, 2001 (Day 37)

Inspection Findings

The following are the inspection findings upon opening of modules on Day 8 made in accordance with the protocol found in Appendix A.

Exterior Inspection Findings

1. Stain on all exterior walls below the water level.
2. Some warping of the plywood vertical siding. There is bulging in the vertical direction at the joint of the two sheets of plywood siding on Wall 2.
3. Vertical cracks in the corner trim boards. The cracks are varied in size up to two inches and cover almost all of the width of the boards below the water line.

Interior Inspection Findings

1. Exterior door requires about 10 lb of force (based on personal estimate and the consensus of the observers) to open due to slight swelling in the casing.
2. Strong musty smell. No visible evidence of mold or bacterial growth.
3. Carpet in Room S-101 (entry room) is fully saturated. Light mud and dirt build-up.
4. Interior door requires stronger force to open (about 15 lb force).
5. Water level appears to have been 2 feet above floor level from marks on walls.
6. Interior door in Module S-1 is starting to split at the bottom. There are a few cracks in two spots, about two inches long, on the surface of the door at the bottom. Interior bi-fold door in Module C-1 severely stained below water level.
7. Room S-102's sealed concrete floor has no visible damage. Room C-102 has standing water on vinyl flooring. Vinyl flooring has bubbled in spots.
8. Dry wall tape is coming off at the joints and comers on all walls below the submersion level.
9. Paint blistering on the interior walls in isolated locations below submersion level.
10. Semi-gloss paint is holding better than flat paint. All interior walls are stained, saturated and discolored below the water level.
11. Ceramic tiles in Module S-1 are intact and do not appear loose when touched or pushed.
12. Vinyl wall covering on walls in Module C-1 is badly damaged. On Wall 4 it is blistering. The glue appears to be deteriorating.
13. Discoloration of both doors below water level. Very slight swelling noticed below the water level.
14. Windows have no noticeable resistance to opening. Frames have no visible damage. The vacuum seals appear in tact, i.e. there is no fogging of the glass.

Photographic Documentation

The interior and exterior of Modules S-1 and C-1 were digitally photographed. This was done before flooding and at seven day intervals after flooding. These pictures were taken at the same locations and at the same magnifications to the extent possible. In both modules, Wall 1 is that which has the window and faces north. Both Wall 2 (east wall) and Wall 4 (west wall) have two portions; one in Room 102 and one in Room 101. A sketch of a module showing wall numbers and orientation is shown in Figure 4-3.

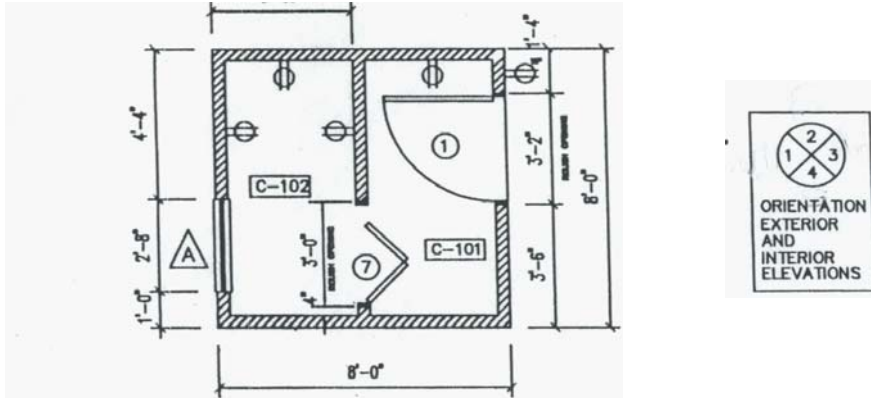

Figure 4-3 Floor plan for Modules S-1 and C-1. Walls were numbered according to the orientation key. Wall 1 is the North wall. Compass orientations are nominal.

Immediately after opening the door and punching holes above the moldings to permit “trapped” water to drain, a set of pictures was taken. These photographs are designated as Day 8. No water drained into the room from the holes, after they were punched. However, when the insulation was felt through these holes it was wet. No standing water was felt in the cavities of either the exterior or interior walls.

In the Module C-1 no mold growth was observed. The vinyl applied to Wall 1 suffered the most damage in the area under the window, where it was almost completely immersed during flooding. Wall 4 also exhibited a considerable amount of damage. The interior plastic door showed stains and paint deterioration on the Day 20 at the two lower corners of the door facing Room C-102. No further changes were observed during the remainder of the drying period.

The interior walls of both modules showed softening due to water absorption. However, mold growth on Module C-1 was much less pronounced. On the Day 20, some stains were found. The washing and drying protocols were followed after draining.

A representative set of photographs (Figures 4-4 to 4-16) is included in this report. Several points should be noted in the photographs:

- The mold growth started to appear ten days after draining the basin.
- The mold growth was concentrated on the exposed face of the gypsum board located between the studs.
- The mold growth appeared only above the water line.
- The mold growth was evident in Rooms S-101 and C-101 which were painted with flat latex paint. Rooms S-102 and C-102, painted with latex enamel (semi-gloss), showed only a very limited amount of mold growth.

- The tiles on Wall 2, Room S-102, had a very slight bulging in the middle of the wall, probably due to the mismatch in the coefficient of swelling between the glue for the tiles and the gypsum board.

The exterior walls all showed staining and discoloration following flooding. After washing, some of the dirt was removed but the paint, especially on Walls 3 and 4 (hardboard lap siding), showed some peeling. No further change was observed on these walls for the remainder of the drying period. The other two walls, Wall 1 (facing north) and Wall 2 (facing east), which were covered with plywood siding also showed yellow staining. The exterior wooden door of the modules showed paint deterioration in the lower part of the door. On Day 22, the color of the paint was found to be yellow to pale-yellow on all walls.

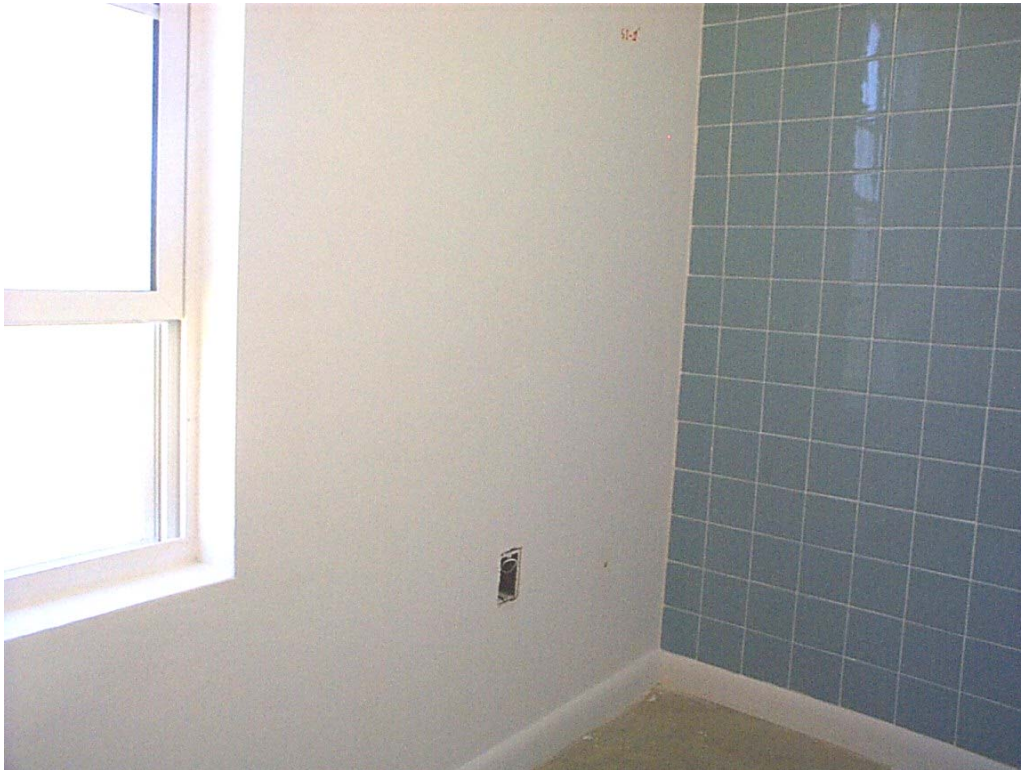

Figure 4-4 Module S-1 (Walls 1 & 2) Pre-flood. Walls, window, floor are in new condition.



Figure 4-5 Module S-1 (Wall 1) Post-flood, Day 8 - Before washing. Hole punched in lower wall to aid cavity draining; walls are stained; paint is sagging and rippling.



Figure 4-6 Module S-1 (Wall 1) Post-flood, Day 15. Walls stained and paint peeling; no mold growth



Figure 4-7 Module S-1 (Wall 1) Post-flood, Day 29. Little change in wall staining and paint peeling has occurred.

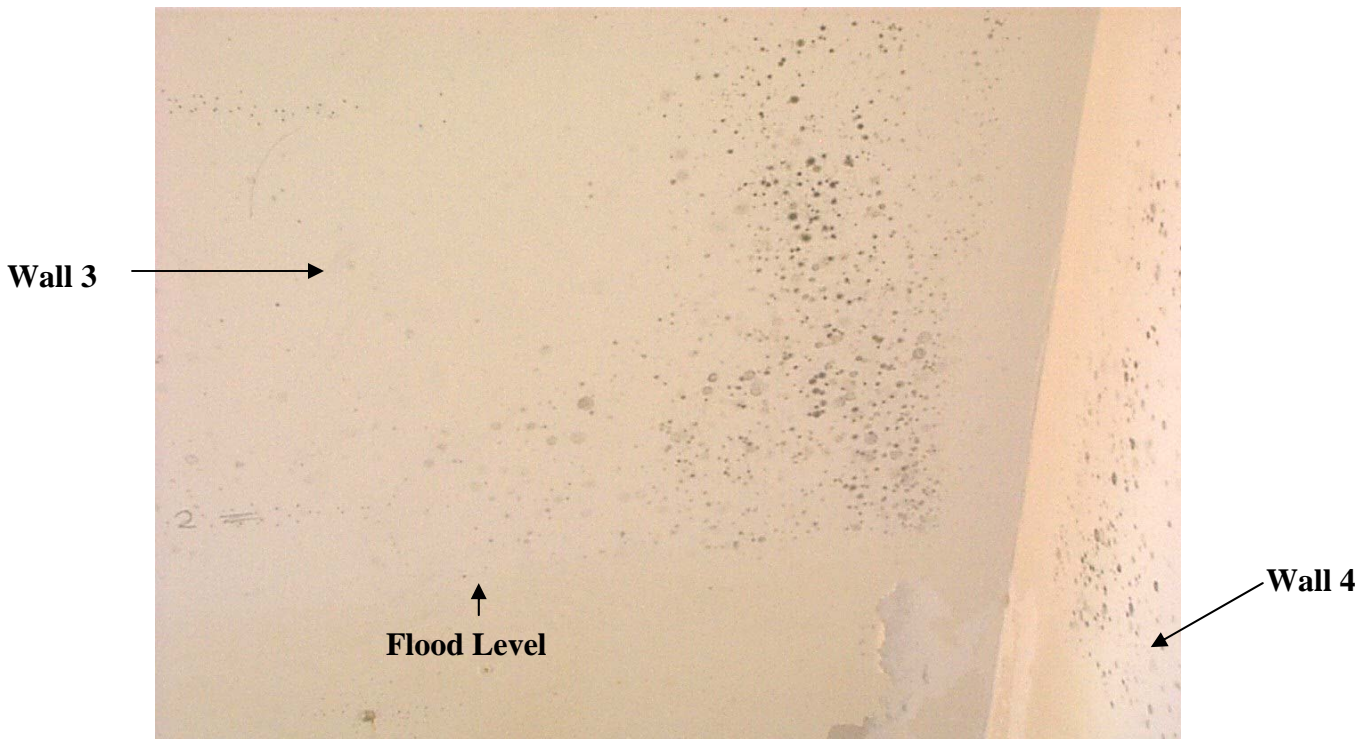

Figure 4-8 Module S-1 (Walls 3 & 4) Mold growth above the water line on Day 29. No mold growth occurred in Module C-1.



Figure 4-9 Module C-1 (Wall 1) Pre-flood. Vinyl wall covering, vinyl floor cover, and window are in new condition.

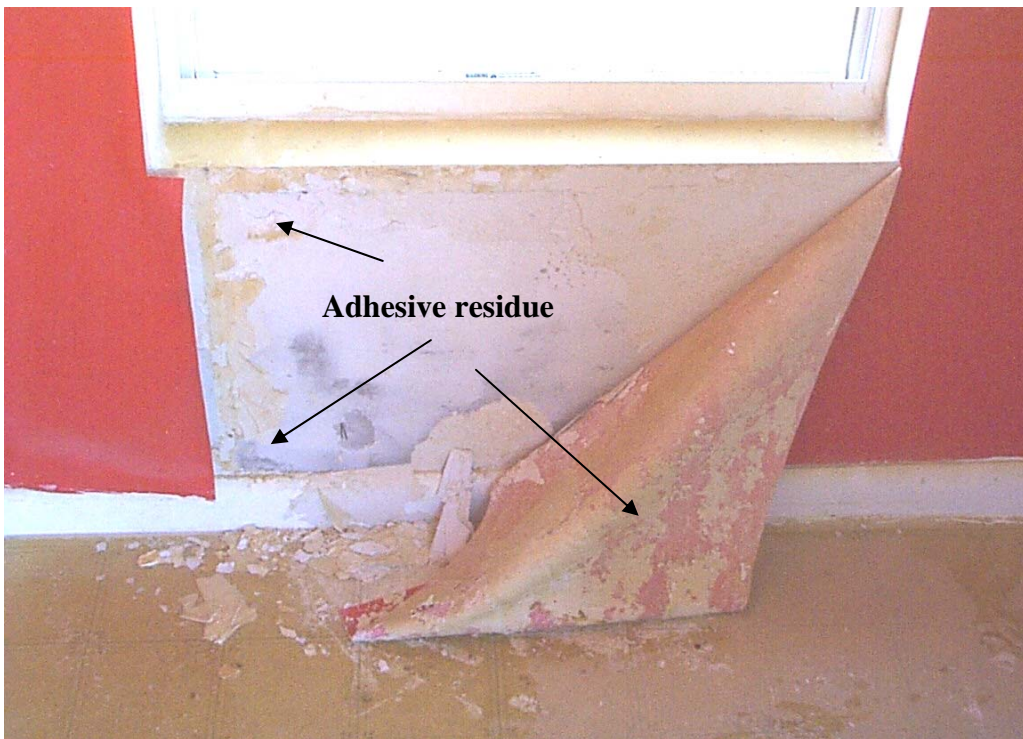

Figure 4-10 Module C-1 (Wall 1) Post-flood, Day 8 (before washing). Vinyl wall covering debonded and gypsum wallboard paper facing delaminated.

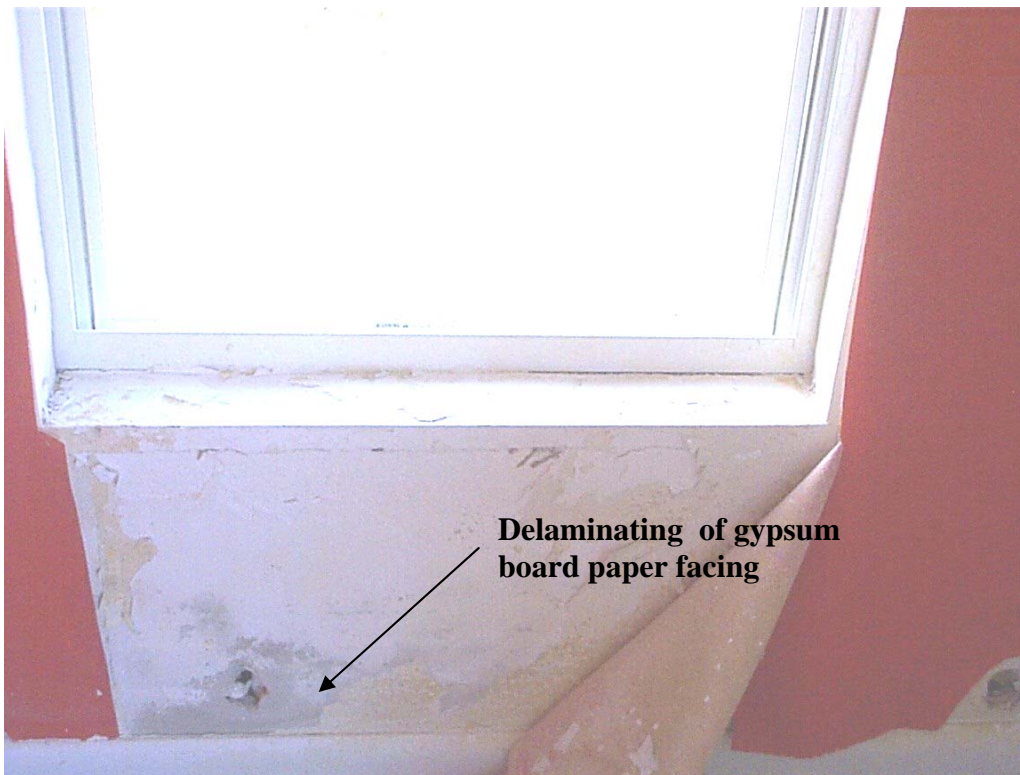

Figure 4-11 Module C-1 (Wall 1) Post-flood, Day 15. No change from Day 8.

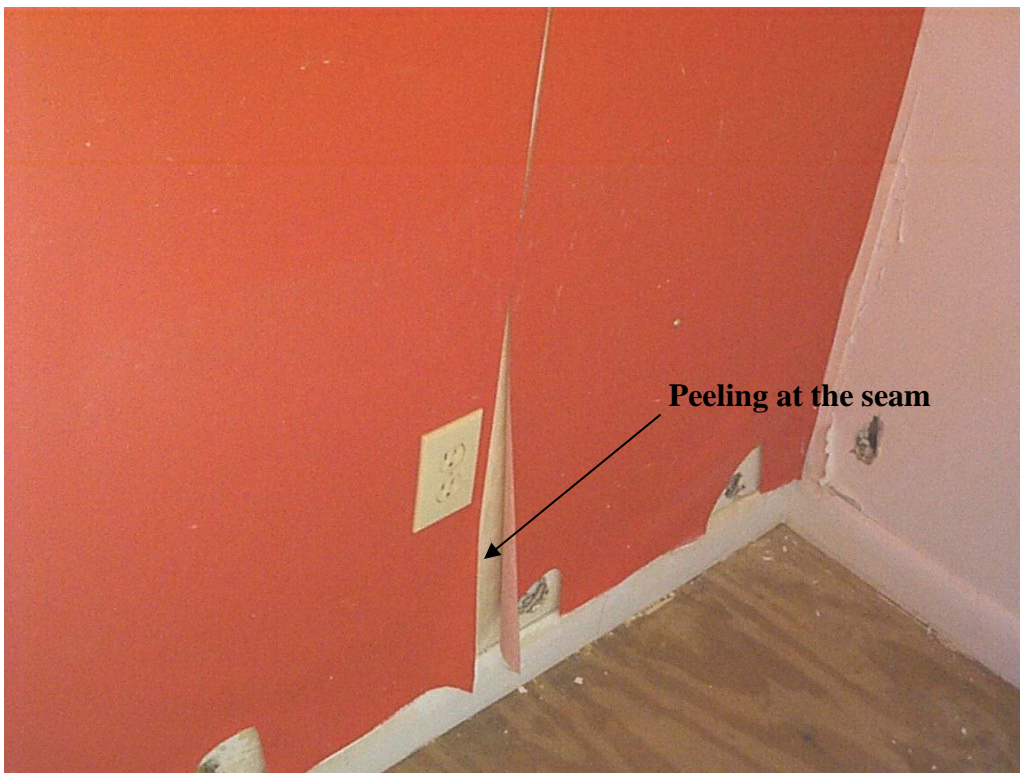

Figure 4-12 Module C-1 (Wall 1) Post-flood, Day 29. Vinyl wall covering is peeling at seams.



Depth to which unit will be flooded

Figure 4-13 Module S-1 (Wall 1, North Exterior Wall) Pre-flood. Wall is clean and in new condition.



Flood level

Figure 4-14 Module S-1 (Wall 1, North Exterior Wall) Post-flood, Day 4. Walls are stained below flood level.



Figure 4-15 Module S-1 (Wall 1, North Exterior Wall) Post-flood, Day 8 (before washing).
Walls are stained below flood level.



Figure 4-16 Module S-1 (Wall 1, North Exterior Wall) Post-flood, Day 15 (after washing).
Wall remains slightly stained.

Relative Humidity and Temperature Profiles

The relative humidity and temperature was measured at three locations in Modules S-1 and C-1. The locations (shown in Figure 3-5) were:

- In the cavity of Wall 3, 6 inches below the top plate,
- In Room 101, just below the ceiling,
- In the cavity of the interior wall (between Rooms 101 and 102).

ä

The relative humidity readings from Module S-1, along with the exterior relative humidity obtained from the weather station, are shown in Figure 4-17. The relative humidity readings in Modules S-1 and C-1 were similar. The relative humidity measured just below the ceiling went up rapidly during flooding and remained relatively constant until the door and window were opened after draining on Day 8. After that the pattern of the indoor relative humidity resembled that of the weather station, only it maintained a lower absolute value.

Initially, the relative humidity of the interior wall cavity was higher than the cavity of the exterior wall that contained fiberglass insulation. The difference became less pronounced at about the time that the module's door and window were opened to promote drying, Day 8. The two levels remained similar throughout the remainder of the drying period. The reasons for the initially lower readings in the exterior wall are not clear. Potentially the fiberglass insulation inhibited air movement in the cavity. This may have slowed the impact of the humidity rise due to flooding.

At the very end of the drying period the relative humidity of the exterior wall slightly exceeds that of the interior wall. The exterior wall is subject to sun exposure and would be expected to dry more quickly than the interior wall. The exterior wall cavity temperature consistently exceeded the interior wall cavity temperature. However, the exterior wall contained fiberglass insulation which appears to have retained moisture on its fibers and kept the RH elevated in this wall throughout the drying period. It appears that there is little correlation between relative humidity in the cavity of the interior and exterior walls with that of the weather station.

The temperature in the cavity of the exterior Wall 3, the cavity of the internal wall and Room 101 were monitored continuously. The relationship between temperatures and time for these locations as well as the outdoor temperature profile are shown in Figure 4-18. Temperature readings were the same for both modules. The exterior temperature profiles are based on two readings per day; one at 12:00 noon and the other at 12:00 midnight. As shown in Figure 4-18, the three readings follow that of the outside temperature. The difference in the temperature between the three readings in the module varies by at the most 6°C. These profiles are influenced by other factors such as fluctuation in the daily average outdoor temperature, wall orientation, wind-speed, rain etc.

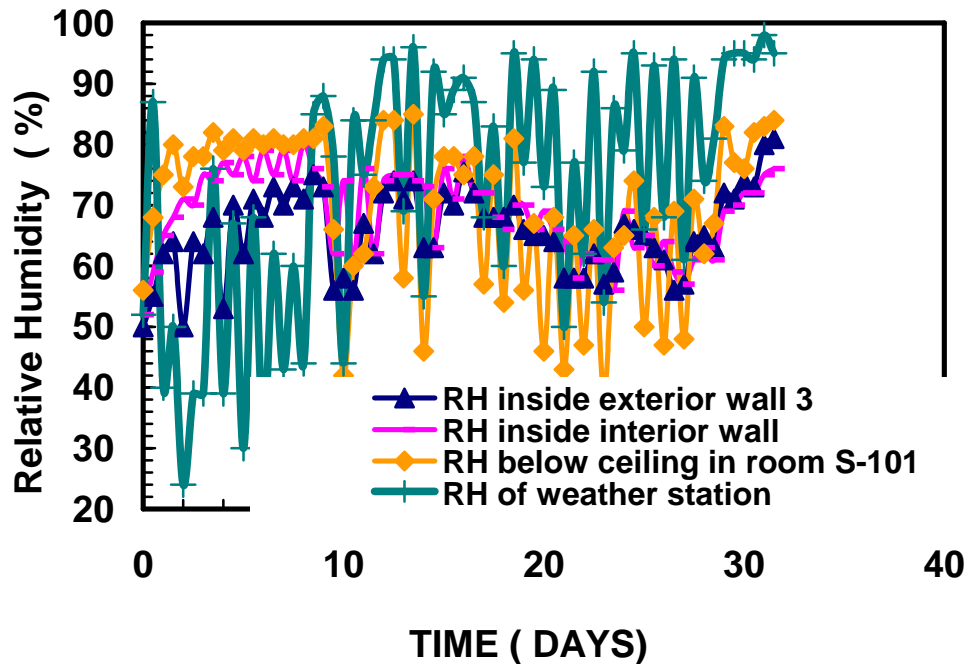

Figure 4-17 Relative humidity versus time at three different locations in Module S-1. Day 1 is the time at which the basins were completely filled. The basins were drained by Day 4 and the door and window were opened on Day 9.

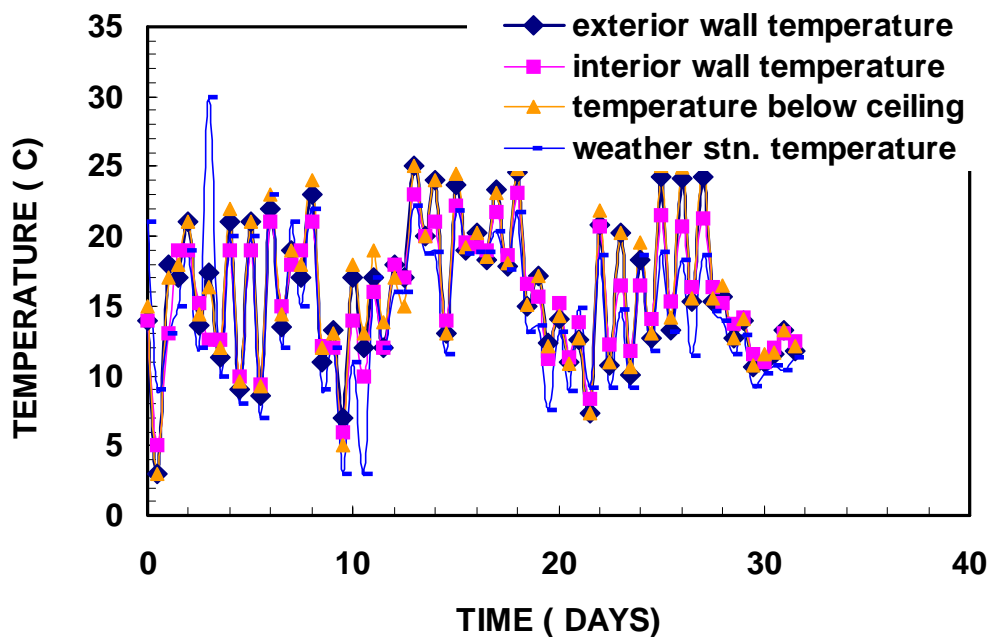

Figure 4-18 Temperature profiles for three different locations in Module S-1 and the outdoor air temperature. Day 1 is the time at which the basins were completely filled. The basins were drained at Day 4 and the door and window were opened on Day 9.

Materials Moisture Content

Studs

The moisture content was monitored at different elevations in a stud in Wall 3 in both Modules S-1 and C-1 (exterior facing south) and in the interior wall (dividing Rooms S-101 and S-102 and C-101 and C-102). Two extra sensors, M9 and M10 were installed in Module C-1 in the sub-flooring from the crawl space side and in a floor joist in the crawl space. The sensors are designated 1, 2, 3, and 4 for the exterior wall and sensors 5, 6, 7, and 8 in the interior wall. The sensors were installed prior to flooding and readings were taken every 20 minutes during the flood and every 3 hours after draining and throughout the drying period.

The moisture content is defined as:

$$\text{Moisture Content, \%} = \frac{\text{Weight of Wet Wood} - \text{Weight of Dry Wood}}{\text{Weight of Dry Wood}} \times 100$$

The relationship between the moisture content and time for Module S-1 is given in Figure 4-19 for the entire flood and drying period. Module C-1, Figure 4-20, was very similar, except there were two additional sensors. For sensors M1 through M8 in Module C-1, the measurements of moisture content and rates of wetting and drying were similar. Only sensors M1 and M5 (below the water level) had a significant change in the moisture content and this moisture content rose sharply at flooding. Day 1 represents the reading after the basin was completely filled. The rate of moisture absorption in the studs below water level, during flooding, is slightly higher for the stud in the exterior wall. The moisture content remained slightly higher during the entire flooding period as indicated from the reading of sensor M1. After draining, which occurred at Day 4 on Figure 4-19, both M1 and M5 have the same drying rate for about 1 day and then the drying rate at the location of sensor M1 in the exterior wall is faster than sensor M5. This indicates that the studs in the exterior walls dry faster than the studs in the interior walls. The remaining sensors appear to have a similar pattern throughout the flooding and drying period.

In Module C-1, two additional sensors (M9 and M10) were installed. (See Figure 4-20.) After draining, the reading of sensor M10 (joist in Module C-1) dropped rapidly from 80% to about 30% in one day. After this day it remained constant at about 30% moisture content throughout the drying period. The reading of M9 however, (subflooring in Module C-1) dropped slowly from the 80% at Day 4 to about 60% at Day 5. It remained at around 60% for almost 30 days from the start of the flood. At that time it was decided to remove the insulation underneath the subfloor at the location underneath the sensor. The reading after this point dropped to about 30%, which is in line with sensors M1, M5, and M10. It appears that the insulation under the subflooring kept the moisture content in the sub-flooring high.

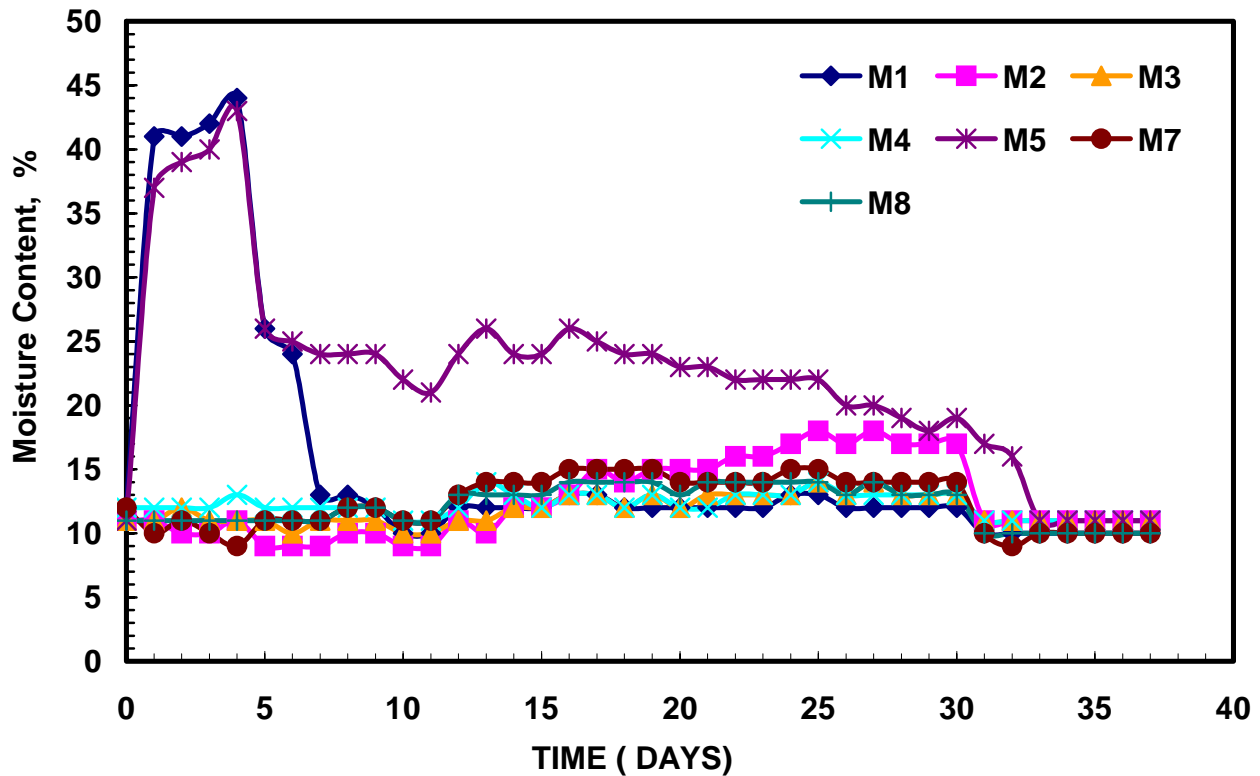

Figure 4-19 The relationship between the moisture content and time of exterior and interior wall studs in Module S-1 for 37 days. Day 1 through Day 4 is the period of flooding. The drying period begins with Day 4. The designation of the moisture sensors is as follows:

Sensor M1 is 1.5 feet above the floor in a stud in Wall 3 (south wall)

Sensor M2 is 2.5 feet above the floor in a stud in Wall 3

Sensor M3 is 4.5 feet above the floor in a stud in Wall 3

Sensor M4 is 6.5 feet above the floor in a stud in Wall 3

Sensor M5 is 1.5 feet above the floor in a stud in the interior wall dividing Rooms S-101 and S-102

Sensor M6 is 2.5 feet above the floor in a stud in the interior wall (not functioning in this test)

Sensor M7 is 4.5 feet above the floor in a stud in interior wall

Sensor M8 is 6.5 feet above the floor in a stud in interior wall

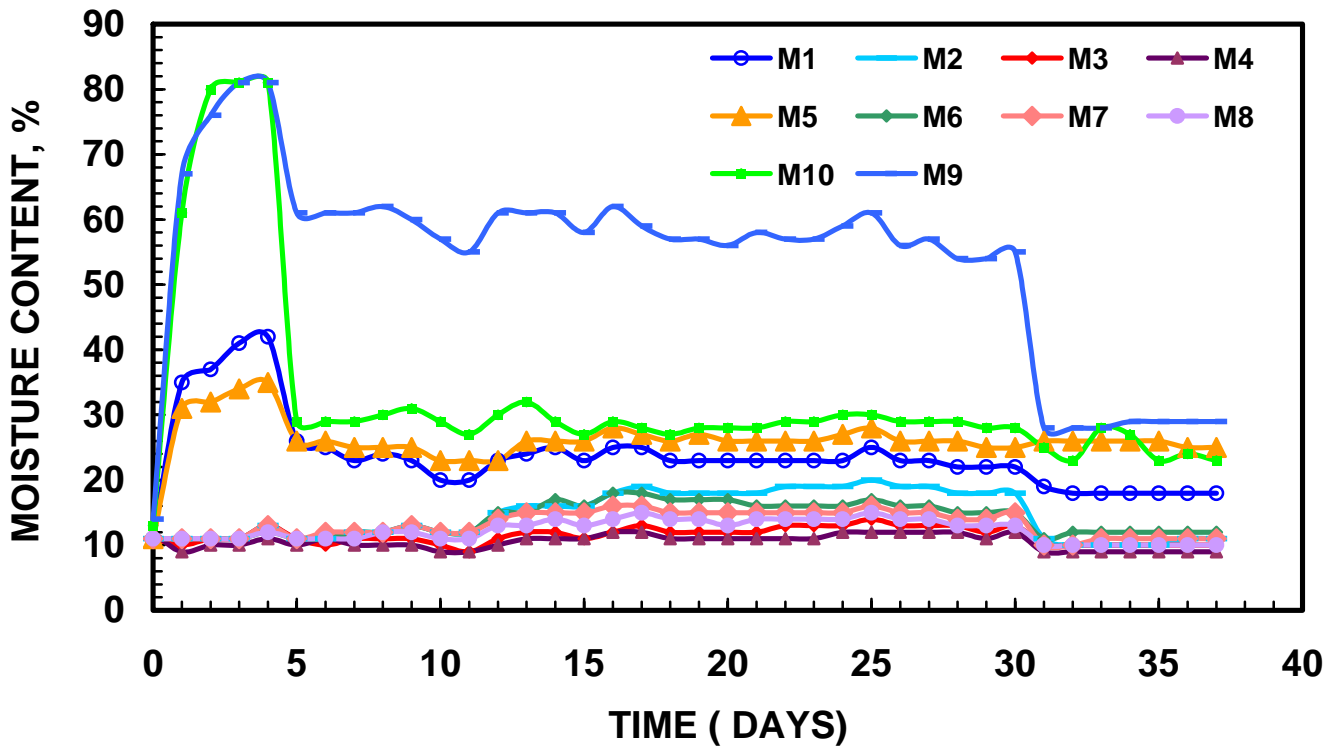

Figure 4-20 The relationship between the moisture content and time of exterior and interior wall studs for Module C-1 during the 37 days. Day 1 through Day 4 is the period of flooding. The drying period begins with Day 4. The designation of the moisture sensors is as follows:

- ä
- Sensor M1 is 1.5 feet above the floor level in a stud in Wall 3
- Sensor M2 is 2.5 feet above the floor level in a stud in Wall 3
- Sensor M3 is 4.5 feet above the floor level in a stud in Wall 3
- Sensor M4 is 6.5 feet above the floor level in a stud in Wall 3
- Sensor M5 is 1.5 feet above the floor level in a stud in the interior wall
- Sensor M6 is 2.5 feet above the floor level in a stud in the interior wall
- Sensor M7 is 4.5 feet above the floor level in a stud in the interior wall
- Sensor M8 is 6.5 feet above the floor level in a stud in the interior wall
- Sensor M9 is installed in the sub-flooring on the crawl space side
- Sensor M10 is installed in a joist in the crawl space

Exterior Siding

The moisture in the exterior siding of Modules S-1 and C-1 was measured using a hand-held moisture sensor. This was done before flooding and 1 day after draining the basin and throughout the remainder of the drying period. Readings were taken from two locations on Walls 1 and 3. Reading 1 was between the window and Wall 4. Reading 1' is on the other side of the window and closer to Wall 2. For Wall 3, reading 3 was taken between the door and Wall 2, while reading 3' was taken between the door and Wall 4. Only one location was used on Walls 2 and 4, which was in the middle of each of the walls. At each of these locations, measurements were made about 1 foot below the water level and about 1.5 feet above the water level.

The relationship between the moisture content and time for Module S-1 is shown on Figure 4-21. (The readings were similar for Module C-1.) The data are clustered in three groups. The drying rate for each group appears to be similar. Group 1, which has the highest moisture content consists of: Wall 1 lower, Wall 1' lower, and Wall 2 lower. The moisture content in this group started at about 40% after draining the basin. Group two consists of: Wall 1 upper, Wall 1' upper and Wall 2 upper. The moisture content in this group started at about 30%. Group 3 consists of: Wall 3 and 3' upper and lower, and Wall 4 upper and lower. Although the moisture content in Wall 3 upper and lower at the two locations are in this group there is a difference of about 8% between the above and below water level readings. In the case of Wall 4 the difference between the readings at the upper and lower locations is only a few percent. The moisture content for Walls 3 and 4 probably remained lower after flood exposure and dried closer to their original value due to the material they were covered with. Walls 3 and 4 were covered with hard board lap siding, while Walls 1 and 2 were covered with a plywood siding.

Plywood is more porous and contains a grainy structure that will hold and transport moisture. Hardboard siding is more dense and homogeneous, which tends to slow the penetration of moisture. The hardboard siding used in the test modules was new and had well-sealed edges. Older siding with less well-sealed edges may absorb significantly more moisture than the present tests reflect. The orientation of the walls did not appear to play a significant factor in the rate of drying in either Module S-1 or C-1. Wall 3 faces south, while Wall 4 faces west; however since these walls did not absorb as much water during flooding, during which time orientation would not have a significant effect.

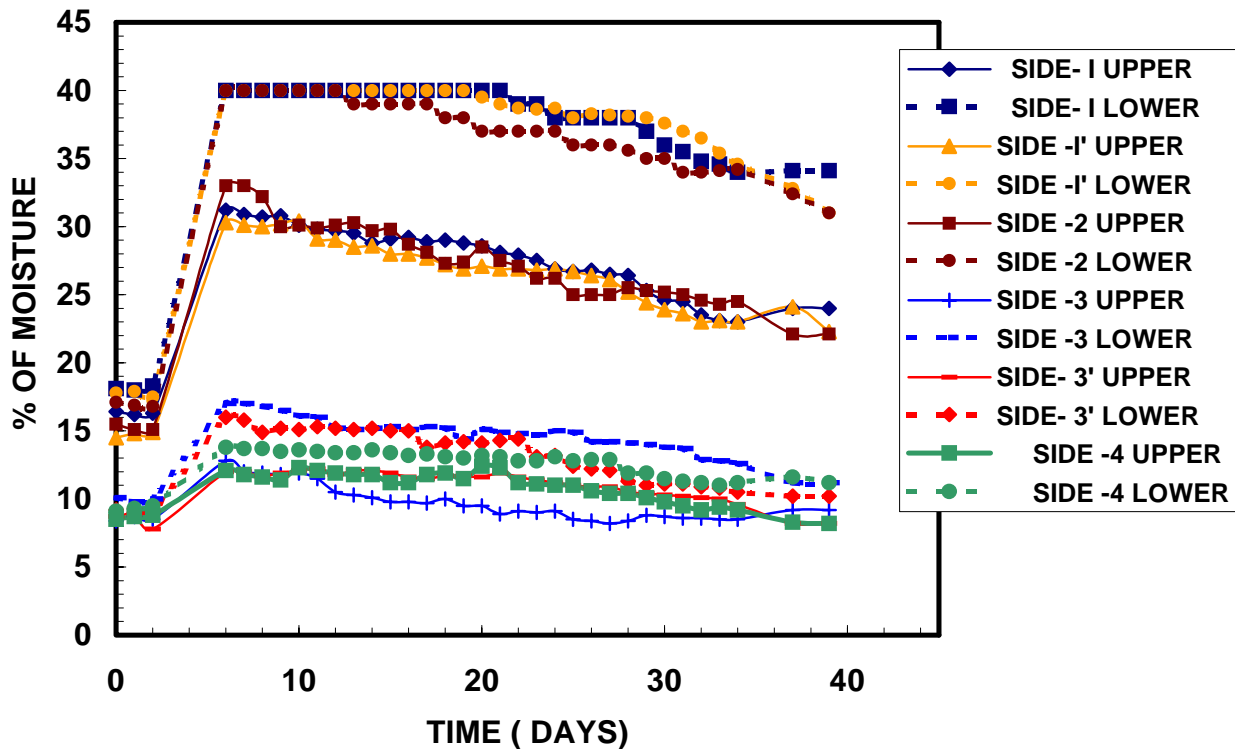

Figure 4-21 Moisture content versus time for the siding on Module S-1. Day 2 through Day 5 is the period of flooding. The drying period begins with Day 5.

Plywood Sheathing

The exterior siding was removed on the 21st of December, which was 2 days after the end of the drying period. The moisture content was measured below and above the water level on all 4 exterior walls. This was done for 12 days. The relationship between the moisture content and time is shown in Figure 4-22. The moisture content of the points below the water level is higher than those above the water level for all test locations. There is a significant difference in the moisture content for Wall 1 and Wall 2, for readings above and below the flood level. Wall 3 displays the lowest difference in moisture content. A slight increase in moisture content seen at 7 days was believed to be due to rain.

The sheathing on Walls 1 and 2 were covered with 4'x 8' sheets of plywood siding throughout the drying period. Walls 3 and 4 were covered with hardboard horizontal lap siding throughout the drying period. Walls 1 and 2 were oriented north and east respectively, while Walls 3 and 4 were oriented south and west respectively.

The initial difference in sheathing moisture content between Walls 1 and 2 and Walls 3 and 4 can be attributed to the difference in siding. Horizontal lap siding contains far more joints and therefore “breathes” more than the plywood siding. This would enable faster drying of the sheathing.

The initial difference in sheathing moisture content between the four walls appears to be

related to their orientation. The north wall has the least sun and most moisture. The east wall is next getting morning sun with lower morning air temperatures. The south wall has the lowest moisture content and the most sun (at least during the period of testing – November/December) along with mid-day temperatures. Finally, the west wall is subjected to afternoon sun (though not as much sun during the testing period) and the highest daytime temperatures and has the second lowest moisture levels.

Readings taken from the sheathing on all the walls (above and below the water level) nine weeks after the final drying period reading were taken and showed that all locations on all walls have dried back to a moisture content of between 6-9%. These readings were made in areas where the siding had been removed for an extended period, and it is doubtful that this level of drying would have occurred had the siding remained in place.

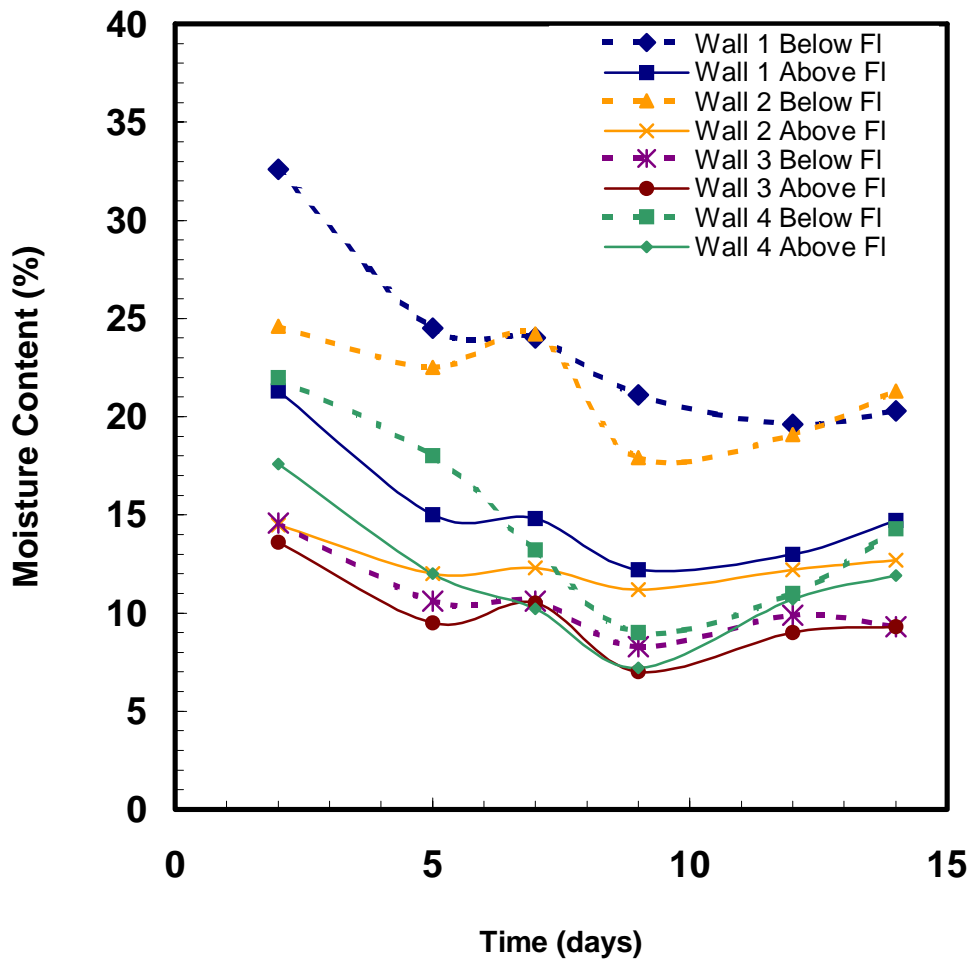

Figure 4-22 Relationship between the moisture content and time for the plywood sheathing. Measurements were taken after removal of the exterior siding at the end of the drying period 28 days after draining the basins.

Interior Walls - Gypsum Board

The moisture content of the gypsum board (dry wall) was measured before flooding and throughout the drying period. This was done on the interior walls between Rooms S-101 and S-102 and C-101 and C-102 from the 101 side and on the interior of Wall 3 at the following locations:

- At floor level - below flood level
- ä 1 foot above the floor - below flood level
- ä 2 feet above the floor - flood level
- ä 3 feet above the floor - above flood level
- ä 4 feet above the floor
- ä 5 feet above the floor
- ä 6 feet above the floor

The relationship between the moisture content and time for the gypsum board on the interior wall in Module S-1 is shown in Figure 4-23 for the various heights. Figure 4-25 shows the relationship between the moisture content and time for the gypsum board on the interior wall in Module C-1. The maximum moisture content was about 6% for floor level, 1 foot, 2 feet and 3 feet above floor level. The moisture content at heights 4 feet and above was about 1 percent and reached the pre-flood conditions at the end of the drying period. It took about 15 days from the opening of the house for the moisture content at these levels to reach the pre-flood condition. The moisture content for the gypsum board cannot be compared with that of wood products because of a difference in instrument calibration. All moisture contents given are relative to their original readings and not absolute values. The measurements taken at the floor level remained higher for about 10 days and then dropped rapidly.

The values in S-1 were similar to C-1 except for the floor level reading as seen in Figure 4- below. At floor level the gypsum board on the interior wall in Module C-1 dried slower than in S-1. In C-1, it took about 20 days from the opening of the house to reach the pre-flood condition, while in S-1 it only took about 15 days. This may be due to the plywood flooring and insulation in the crawl space under the flooring, which retained moisture; this slowed the drying process near the floor.

The relationship between the moisture content and time for the gypsum board on Wall 3 of Module S-1, an exterior wall facing south, is shown in Figure 4-24 below. Moisture content versus time for the gypsum board on Wall 3 was similar for Module C-1, as seen in Figure 4-26 below. Similar to the interior wall, the highest moisture content was about 6 % for the floor level, 1, 2 and 3 feet above the floor level. The moisture content at heights 4 feet and above was just under 1 percent after opening the door and window and it reached the pre-flood condition at the end of the drying period. Also the floor level moisture resembled that of the interior wall; however, it had a slower drying rate. This was the case for the floor level measurements and at 1 foot above the floor. For 2 and 3 feet above the floor the drying rate was faster in Wall 3.

The difference in drying rate between the interior and exterior walls at floor level is attributed to the impact of the fiberglass insulation in the exterior walls. The insulation retains more moisture at floor level. This increased moisture within the exterior wall cavity caused the exterior wall gypsum board to dry more slowly at the floor level. The drying rate at one foot above floor level is similar for both walls. At locations 2 and 3 feet above floor level, Wall 3 dried faster. This is attributed to the fact that Wall 3 is facing south and absorbs heat from the sun.

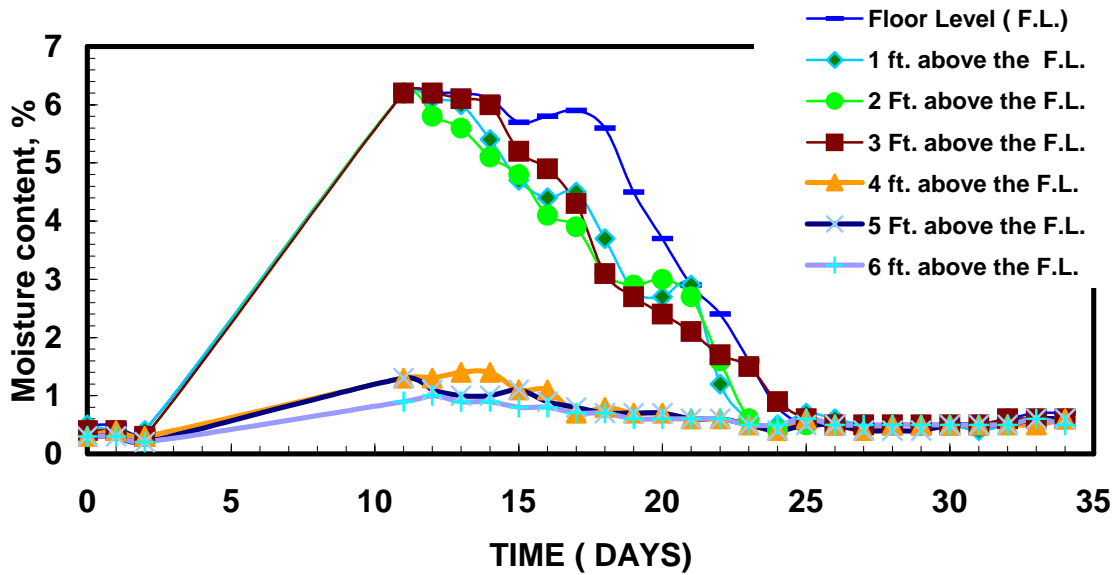

Figure 4-23 Moisture content versus time for the gypsum board on the interior wall of Module S-1. Day 2 is the beginning of flooding, Day 5 is the draining of the basin, Day 10 is the reentry into the module and the beginning of observation and measurement, Day 33 is the end of the drying period. *All moisture contents should be considered relative to their original readings and not absolute values.*

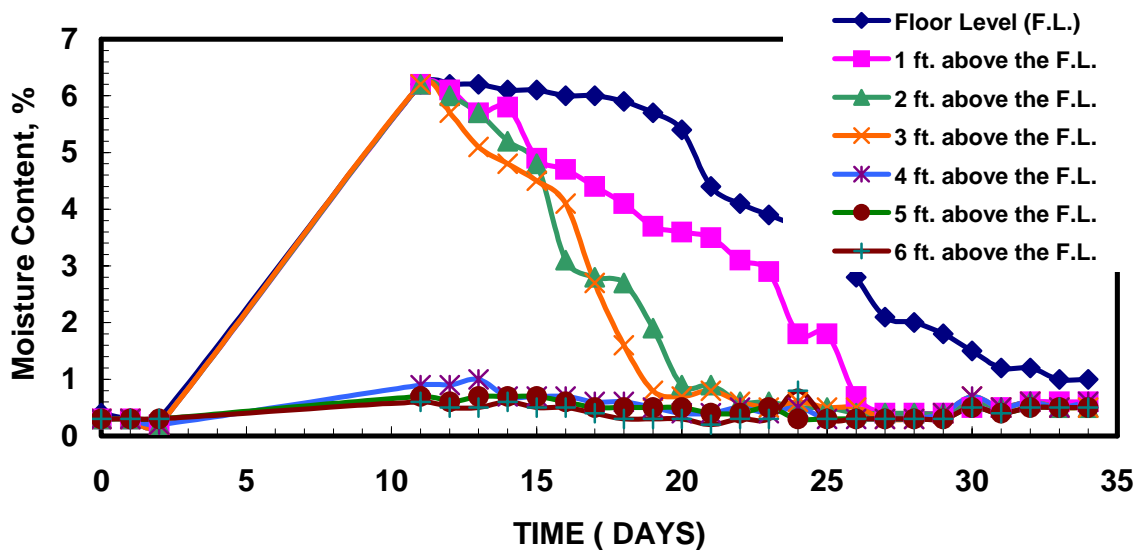

Figure 4-24 Moisture content versus time for the gypsum board in Module S-1 on the interior of Wall 3. Day 2 is the beginning of flooding, Day 5 is the draining of the basin, Day 10 is the reentry into the module and the beginning of observation and measurement, and Day 33 is the end of the drying period. *All moisture contents should be considered relative to their original readings and not absolute values.*

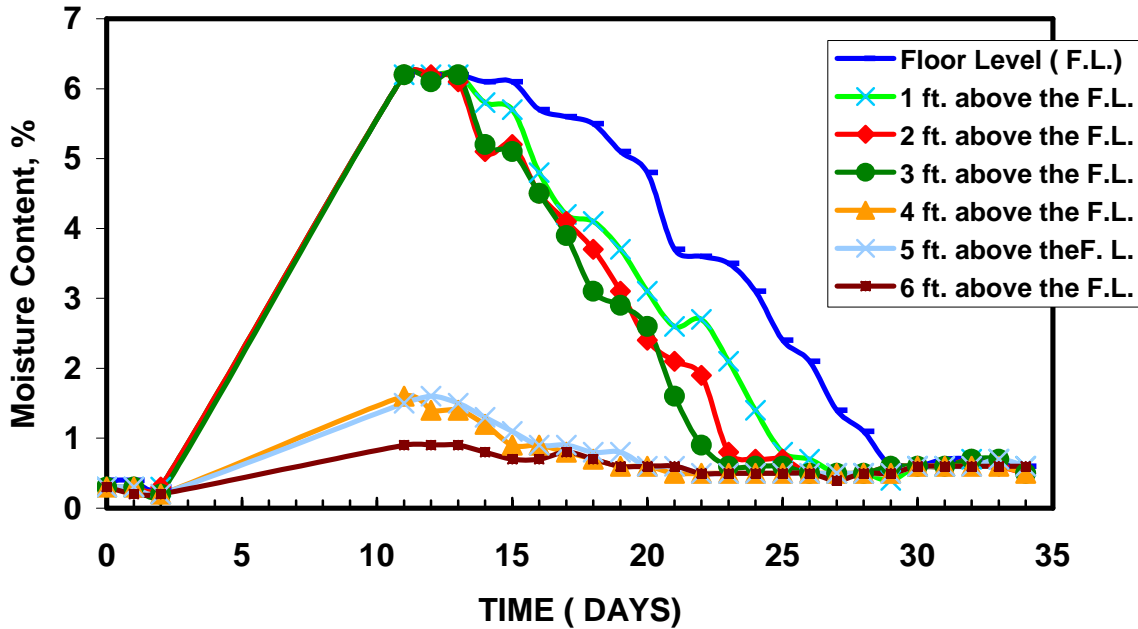

Figure 4-25 Moisture content versus time for the gypsum board on the interior wall of **Module C-1**. Day 2 is the beginning of flooding; Day 5 is the draining of the basin; Day 10 is the reentry into the module and the beginning of observation and measurement; Day 33 is the end of the drying period. *All moisture contents should be considered relative to their original readings and not absolute values.*

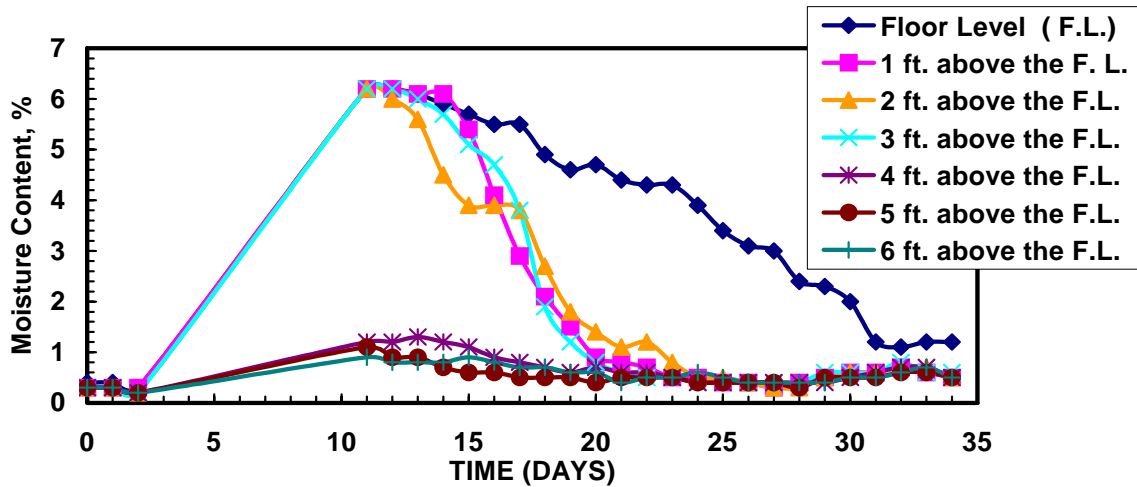

Figure 4-26 Moisture content versus time in the gypsum board on the interior of **Wall 3** (south wall) in **Module C-1**. Day 2 is the beginning of flooding, Day 5 is the draining of the basin, Day 10 is the reentry into the module and the beginning of observation and measurement, Day 33 is the end of the drying period. *All moisture contents should be considered relative to their original readings and not absolute values.*

Mold Observations

Mold growth is a major problem associated with floods. No mold was observed on any part of the building components prior to flooding. One day after draining, there was no visible mold found on the outside surface of the modules. However, a strong musty smell of moisture and mud was present in the interior. Upon reentering the modules (Day 8) no mold traces were seen. At no time throughout the testing was mold growth visible in the crawl space unit, Module C-1. Beginning on the Day 13, dark-yellowish mold spots were observed in Module S-1. A series of optical micrographs were recorded to show the morphology of such contaminants and mold spots. An example of these is shown in Figure 4-27.

Mold was only found in the slab-on-grade module mainly on the walls of Room S-101. This room differed from S-102 (very little mold) in that the walls were painted with flat latex paint as opposed to latex enamel and the room had carpet on the floor during the flood. The wet carpet was removed at reentry (Day 8). Mold growth was present on the gypsum board walls only above the water line and was concentrated in areas between the studs.

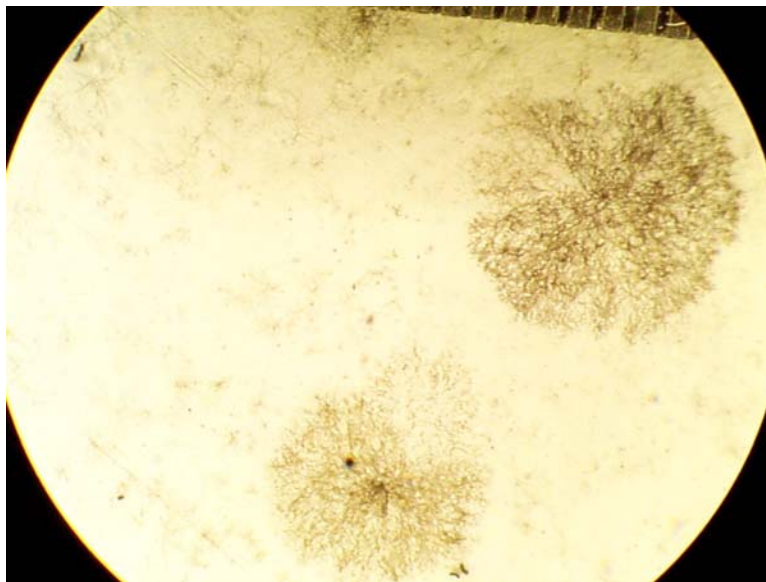

Figure 4-27 Optical micrograph at 5X, showing the size of typical molds. Diameters are from 0.8 mm to 15 mm (3 feet above floor level, Module S-1, Wall 3 in Room S-101).

Mechanical Properties Testing

Siding

Mechanical properties and failure modes were investigated for specimens from the two types of exterior siding which were exposed to three days of flooding followed by natural drying for 35 days. The samples were cut from the middle of each wall, above and below the water level, on Day 38. The specimens had dimensions of 8" x 1" x 0.5". The flexural strength of the siding was determined by three-point bending tests with a 6" load span. The relationship between the flexural strength and the moisture content (MC) of the siding was established. It was found that the specimens taken from areas well above the water level had about an 8~10% MC, while specimens from below the water level had a moisture content between 20-25%. The flexural strength and modulus for specimens from the siding of the four walls of Modules S-1 and C-1 are shown in Tables 4-3 and 4-4.

Table 4-3 Flexural Strength and Modulus of Siding for Module S-1

Module S-1	Wall 1 North Plywood		Wall 2 East Plywood		Wall 3 South Hardboard		Wall 4 West Hardboard	
	Above Water	Below Water	Above Water	Below Water	Above Water	Below Water	Above Water	Below Water
Flexural Strength	24MPa	28MPa	23MPa	30MPa	22MPa	27MPa	22MPa	29MPa
Flexural Modulus	1.69 GPa	1.69GPa	1.66GPa	1.67GPa	2.59GPa	2.21GPa	2.89GPa	2.63GPa

Table 4-4 Flexural Strength and Modulus of Siding for Module C-1

Module C-1	Wall 1 North Plywood		Wall 2 East Plywood		Wall 3 South Hardboard		Wall 4 West Hardboard	
	Above Water	Below Water	Above Water	Below Water	Above Water	Below Water	Above Water	Below Water
Flexural Strength	22Mpa	20Mpa	19MPa	23MPa	24MPa	25MPa	24MPa	26MPa
Flexural Modulus	2.90GPa	2.41GPa	2.67GPa	1.82GPa	2.13GPa	2.11GPa	2.28GPa	2.15GPa

The flexural strength is slightly higher for all walls below the water level, however the modulus decreased for the samples below the water level. The change in the strength and modulus do not constitute a major variation in the properties of the siding.

In-situ optical examinations of the texture and structure of the plywood specimens after three point bending were performed to identify the flexural failure mechanisms. Under three point bending conditions, simple tension and horizontal shear are the major failure modes.

Gypsum Board

Four point bending tests on gypsum board were also performed (Figure 4-28) to examine the flexural strength change due to the flooding. It was found that the flexural strength of the gypsum board on the exterior walls dropped by about 50% below the water line compared to that above the water line. The gypsum board on the interior wall of the unit showed no significant decrease in strength. It appears that the reason for the decreased flexural strength in the exterior wall gypsum board is that the fiberglass insulation in the interior cavities of the walls caused them to stay wet longer. The interior wall was hollow and thus dried quicker. The detailed test results are listed in Table 4-5. Results were virtually the same in Module C-1.

Table 4-5 Flexural Strength of Gypsum Board for Module S-1

Exterior Wall		Interior Wall	
Above Water	Below Water	Above Water	Below Water
3.2MPa	1.64MPa	3.68MPa	3.56MPa

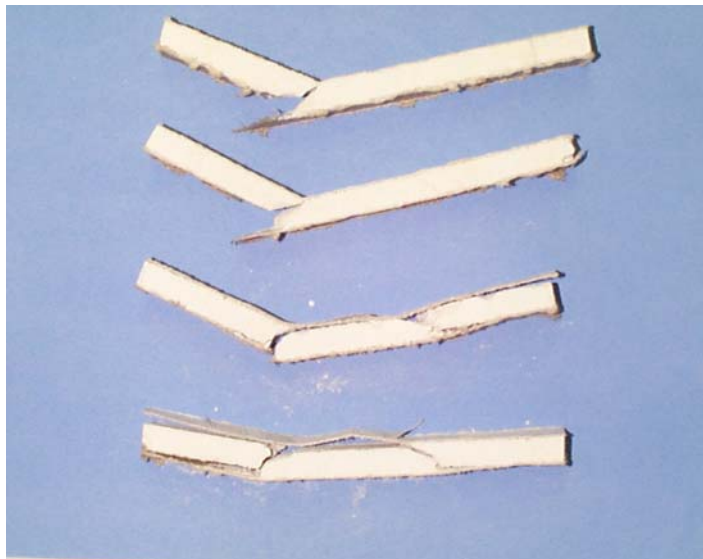

Figure 4-28 Four point bending samples from the gypsum board of Module C-1. Samples are taken from interior side of outside wall, below the water line.

DISCUSSION AND CONCLUSIONS

Flood damage resistance includes both physical and human health factors. The experimental modules were tested for resistance to physical degradation that results from the wetting and drying cycle associated with flooding. Testing did not address the structural impact on the envelope of externally applied hydrostatic pressures. Flood depth was limited to two feet above floor level, which applies a pressure that is within the strength capabilities of typical wood frame construction. Post flooding mold growth was documented and selected specimens analyzed. Bacteriological and toxic materials testing were not performed during this series of tests.

Within the limits described above the testing of conventional building envelope systems in two modules under simulated flood conditions revealed the following.

1. Newly installed and painted plywood and hardboard lap siding of 0.5" thickness appear to maintain their dimensional stability and mechanical properties when exposed to flooding. Both materials experienced some warping and buckling immediately after the flooding which was reduced with drying. The plywood also had checking or cracking of the face plies near the edge of the sheet after exposure to flooding. The hardboard lap siding had some paint flaking after washing. They also possess good washability but remained somewhat discolored. There was considerably more damage (cracking and warping) to the corner boards made from nominal 1 inch sawn lumber. These siding materials as tested could potentially be evaluated as passing the flood damage resistance requirements. However, older, weathered siding of the same materials and/or repeated wetting and drying over several cycles is projected to significantly deteriorate the repairability of these siding materials. This is based on observations made by one of the authors of existing housing using these sidings. While new and well maintained plywood and hardboard lap siding were adequately flood damage resistant in this test, actual long-term performance of these materials has not yet been demonstrated.
2. Plywood sheathing of 0.5" thickness maintained its integrity and mechanical properties. Below flood level it retained a considerable amount of moisture after 30 days of natural drying (23% when behind plywood siding, 13% when behind hardboard lap siding). Upon removal of the siding it took the sheathing that had been under water about 2.5 months to reach its pre-flood moisture content. Because water does not tend to escape, quickly from behind plywood siding, the combination of plywood siding and sheathing was not considered a good flood damage resistant system. Lap siding on the other hand tends to let moisture escape more quickly. If a flood damage resistant lap siding is used, the use of plywood as sheathing is likely to make an acceptable flood damage resistant system.
3. Moisture content in the gypsum board walls near and below flood level rose significantly during flooding. In both Modules S-1 and C-1, moisture content declined more slowly, and remained higher (about double) after 30 days of drying, at floor level when the wall cavity contained fiberglass insulation than when the wall cavity was empty. The gypsum board on exterior walls (with insulation) loses about 49% of its flexural strength while that on interior walls regains 97% its strength after a 30 day drying period. The wetter and weaker gypsum board is believed to be due to moisture on the fiberglass insulation

which appears to extend the drying period. In Modules 2 and 3 a different type of insulation, spray polyurethane foam – SPURF, was used in combination with fiber reinforced gypsum interior wall panels and water resistant, fiber reinforced gypsum sheathing. These gypsum panels dried faster and regained most of their strength during the drying period (78 to 87% for insulated walls and 82 to 130% for open cavity walls). Walls systems using conventional gypsum wallboard and fiberglass insulation might not be considered flood damage resistant system due to the extended drying period during which flexural strength is reduced.

4. While the moisture content of the gypsum board interior partitions near and below flood rose significantly during flooding, it returned to pre-flood conditions (both moisture and strength) within the drying period. The moisture level of the wood studs in Module S-1's partition also dropped to pre-flood levels within the drying period. In Module C-1, the moisture level dropped to pre-flood levels except near the bottom of the stud where the high moisture content on the subflooring may have had an impact. This suggests that empty cavity walls such as interior partitions may be able to be restored within the limited definition of flood damage resistant of this project and not require removal of the drywall. The subsequent tests confirmed this conclusion.
5. Wood sub-flooring in Module C-1 retained very high moisture content throughout the drying period. This flooring was insulated with unfaced fiberglass batts from underneath. In Modules 2 and 3 no floor insulation was used and the subflooring returned to pre-flood moisture levels during the drying period. Wood subflooring insulated with fiberglass might not be considered a flood damage resistant system if the insulation is allowed to remain after the flooding. Long term exposure to high moisture levels could cause warping or decay in the subfloor. Additional testing will be needed to determine if the extended drying period associated with the use of fiberglass insulation is long enough to cause permanent damage to the subfloor. Module 4-C will investigate the impact of SPURF insulation on wood subflooring as a potentially flood damage resistant system.
6. Severe blistering, peeling, and debonding of vinyl wall covering occurred after flooding. This is due to either the deterioration of the interface between the vinyl and the adhesive or the interface between the paper covering of the gypsum board and the gypsum core. In a majority of areas in this test the paper covering of the gypsum board adhered to the adhesive and the vinyl wall covering and peels from the core of the gypsum board permanently damaging the gypsum board. In addition, it is believed that the vinyl will also inhibit the drying of the gypsum or other substrates which could render them not restoreable. However, moisture measurements to confirm this were not taken during this test. Vinyl wall covering on gypsum board is not recommended for use in flood damage resistant applications.
7. In this test, the slab-on-grade module supported severe mold growth while the crawl space module did not. We cannot explain this difference. In Module S-1 mold growth occurred in a band above the water level. In this module, flat latex paint surfaces appeared to support mold growth, while semi-gloss latex paint surfaces appeared to be less conducive to mold growth. Potentially the "slicker" surface of semi-gloss or gloss paints is less conducive to mold growth (later test modules showed this theory to be

incorrect). Because the difference occurred in only one module, and an explanation cannot be provided for why it didn't occur in the other, we believe that further testing of various paints must be conducted in order to reach any valid conclusions.

8. The nonappearance of mold upon re-entry to a house does not mean that no mold will occur. In this test, mold growth occurred after washing the test modules and drying had begun. It took about 10 days from the time the water receded for the mold to appear in the slab-on-grade unit. Visible mold growth did not occur in the crawl space module. Some of the subsequent tests had visible mold growth upon reentering the test modules on Day 8. The delay in growth in Modules S-1 and C-1 appears to be related to the ambient temperatures during the early part of the test period (December) which were below those that typically support mold growth. Since mold growth can be an undesired outcome of flooding, we concluded that the testing protocol for subsequent modules should make provision to reduce or eliminate mold growth. However, no attempt was made to sanitize Modules S-1 and C-1. (The Protocol for Drying Out, Restoration, and Autopsy of Test Modules C2 and S2, Appendix C, details the method used to sanitize the subsequent modules.)
9. Punching holes above the floor molding on the interior surfaces of walls, as recommended by FEMA and other flood recovery manuals, does not drain any water nor does it appear to dry the wall any faster. This is especially true if the flood water has receded for several days. In fact, punching drainage holes damages walls that may otherwise be able to be easily repaired. We concluded that punching drain holes in gypsum board walls does not serve a useful purpose and should not be recommended in future flood recovery manuals.

5. FLOOD DAMAGE RESISTANT RESIDENTIAL ENVELOPE SYSTEMS: Modules S-2 (Slab-on-Grade), C-2 (Crawl Space)

PURPOSE

The purpose of Modules S-2 and C-2 was to evaluate potential residential envelope materials and systems that might be more flood-damage resistant and restorable than the conventional materials and systems that had been tested in Modules S-1 and C-1. Modules S-2 and C-2 were also used to test some hypothesis that arose as a result of what was learned in the previous modules. For example, in the first modules, holes were punched in the gypsum board wall to promote draining and drying in the wall cavities. When no water drained out, the question remained, does punching holes promoted drying of the wall. So, in the second modules, no holes were punched in walls and drying rates were monitored.

In Modules S-2 and C-2, unlike the previous modules, the interior exposed surfaces were sanitized and restored in order to assess the restorability of these materials and systems after a flood. A Protocol for Drying Out, Restoration, and Autopsy of Test Modules C-2 and S-2 was developed (Appendix C). According to the protocol vertical exposed surfaces were to be sprayed using a pumped garden sprayer with a solution of water, household bleach (25% by volume), and tri-sodium phosphate (5% by volume) until they were completely wetted. The floors were wet mopped with the same solution. At the end of the drying period, restoration of surfaces was attempted. Then modules were demolished and autopsied, and samples of the various materials made for testing and observation. The purpose of adding these procedures, beyond those done in Modules S-1 and C-1 was to determine not only how flood resistant the materials in Modules S-2 and C-2 were, but also how easily restorable they were after flooding.

DESCRIPTION

Based on what was learned in test Modules S-1 and C-1, a second set of test on Modules S-2 and C-2 (Figures 5-1 and 5-2) was conducted in April 2002. On the exterior, vinyl siding and fiber cement lap siding was installed, and foam-filled metal and foam-filled fiberglass exterior doors were installed. On the interior, a wood laminate hollow-core door and a six-panel, solid wood interior door were installed. Because the batt insulation appeared to contribute to the slow drying and degradation of the gypsum board interior walls, sprayed polyurethane foam (SPUF) was used in the exterior wall cavities. SPUF is not water absorbent, and therefore it was thought would minimize the amount of water that enters the wall cavity, allowing the walls to dry faster and more completely within the test period. United States Gypsum's (USG's) Fiberock, a fiber reinforced gypsum panel, was installed to see if it was more flood damage resistant than the conventional gypsum wallboard. Simulated wood flooring with a high percentage of plastic content was installed on the floors of both modules.

The overall size and configuration of these test modules was the same as used in the previous tests (see Figure 3-4). A detailed materials list was developed for Modules S-2 and C-2 (Tables 5-1 and 5-2).



Figure 5-1 (Left) Slab-on-Grade Module S-2 during flooding.

Figure 5-2 (Right) Crawlspace Module C-2 during flooding. The apparent color difference in the siding is due to light reflecting from the water in the basin.

Table 5-1 Building Materials and Configuration for Test Module S-2		
Component	Location	Material
Siding	North and west exterior walls	Vinyl lap siding (premium grade)
	East and south exterior walls	Fiber cement lap siding (premium grade)
Sheathing	North and east exterior walls	Exterior plywood sheathing (East wall - cover with 15# felt)
	South and west exterior walls	Water resistant, fiber reinforced gypsum exterior gypsum sheathing (Fiberock)
Insulation	All exterior walls	Spray polyurethane foam (against sheathing)
Housewrap	All exterior walls	Not used for test S-2
Interior wall board	All interior walls	Fiberock interior wallboard. Wall #3 paper faced drywall. Room S-201 interior partition same as Wall #3.
Wall finishes	Room with exterior door (S-201)	Low permeability paint that seals surface. Moderately high permeability paint on interior partition.
	Room with window (S-202)	Moderately high permeability paint that lets moisture out
(The above configuration means that one side of the interior wall between the two rooms in the test facility has high permeability paint finish and one side of the interior wall has low permeability paint finish.)		
Vapor barriers	All walls	No vapor barrier used for test S-2
Doors	Exterior	Foam-filled fiberglass
	Interior	Solid core wood composite, six panel
Windows	North wall	Vinyl (white), double pane (For windows and doors, seal between rough opening and finish frame with low expansion spray foam sealant.)
Electrical distribution	Interior walls	Traditional in-wall electrical wiring, same as for test S-1
Ceiling	Ceiling	Since ceiling in test 1-C is in good shape after flooding, then continue to use traditional gypsum board sheathing. Finish with white interior latex paint.
Attic and roofing	Attic and roof	Construct identical to test S-1
Floor structure	Floors	Concrete slab, same as test S-1

Floor finishes	Room with exterior door (S-201)	Floating , interlocking wood floor (plastic/wood fiber composite) on rubberized pad
	Room with window (S-202)	None

Table 5-2 Building Materials and Configuration for Test Module C-2

Component	Location	Material
Siding	North and west exterior walls	Vinyl lap siding (regular grade)
	East and south exterior walls	Fiber cement lap siding (regular grade)
Sheathing	North and east exterior walls	Foam plastic sheathing with galvanized metal strap diagonal bracing
	South and west exterior walls	Exterior plywood sheathing (West wall - cover with 15# felt)
Insulation	All exterior walls	Spray polyurethane foam (against sheathing)
Housewrap	All exterior walls	Not used for test C-2
Interior wall board	All interior walls	Water resistant, fiber reinforced gypsum exterior sheathing in Room 202 on Wall 1, Wall 5, and Wall 4 of Room 202; Fiberock interior wallboard on all other walls.
Wall finishes	Room with exterior door (C-201)	Low permeability paint that seals surface
	Room with window (C-202)	Moderately high permeability paint that lets moisture out
Vapor barriers	All walls	No vapor barrier used for test C-2
Doors	Exterior	Foam-filled metal
	Interior	Hollow core wood laminate
Windows	North wall	Aluminum, baked white enamel, double pane (For windows and doors, seal between rough opening and finish frame with low expansion spray foam sealant.)
Electrical distribution	Interior walls	Traditional in-wall electrical wiring, same as for test C-1
Ceiling	Ceiling	Since ceiling in test 1-C is in good shape after flooding, then continue to use traditional gypsum board sheathing. Finish with white interior latex paint.
Attic and roofing	Attic and roof	Construct identical to test C-1
Floor structure	Floors	Exterior grade plywood, same as test C-1
Floor finishes	Room with exterior door (C-201)	Floating, interlocking wood floor (plastic/wood fiber composite) on rubberized pad
	Room with window (C-202)	Quarry or ceramic tile (hard tile) Install over Fiberock (cement board) underlay. Fasten Fiberock to wood sub-flooring per USG's instructions for this product.

DOCUMENTATION OF TESTING

Chronology of Testing Modules S-2 and C-2:

Basin Flooding Start:	April 10, 2002 (Day 0)
Basin Draining Start:	April 13, 2002 (Day 3, 72 hour flood)
Module Door and Window Opening:	April 18, 2002 (Day 8)
Wash with water:	April 20, 2002 (Day 10)
Sanitizing:	April 24, 2002 (Day 14)
Start of restoration:	May 17, 2002 (Day 47)
Drying Period End:	May 20, 2002 (Day 50)
Autopsy and mechanical testing:	June 10, 2002 (Day 72)
Final autopsy and demolition:	August 20, 2002 (Day 113)

Inspection Findings

The following are the inspection findings upon opening of modules on Day 8 made in accordance with the protocol found in Appendix A.

Exterior Inspection Findings

1. Minor stains on all exterior walls below the water level. The stains appear to be washable. Vinyl lap siding is more noticeably stained than painted fiber cement lap siding.
2. No noticeable warp or deterioration in either the vinyl or the fiber cement lap siding.
3. No cracks within the corner trim boards. Minor separation of the corner trim boards occurred at the joints below the water level in all four corners.

Interior Inspection Findings

1. Exterior and interior doors each require about 20 lb. of force to open based on personal estimate and consensus of the observers. This is due to a slight swelling in the casing.
2. In Module S-2, strong musty smell when the front door was opened. Evidence of mold growth on walls, interior door and wooden door casing and trim. The concentration of mold on the walls is in a band from 0 to 20 inches above the water line. As indicated by a slight change in color due to moisture, the walls 20 inches above the water line appear to be moist. There are a few dark stain spots below the water line. Most of the mold on the door casing is below the water line. In C-2, there is substantial mold growth on the walls in a band from 0 to 20 inches above the water level and severe stains and discoloration with isolated patches of mold below the water level. Wooden casings and moldings have mold growth below the water level.
3. There is a coat of slimy dirt film on the floor in Rooms S-201 and S-202. Light mud and dirt build-up all over the floor. The floor in Room S-201 is an Armstrong simulated wood, while the floor in Room S-202 is a concrete slab. The simulated wood floor in C-2 is dryer than the simulated wood floor in S-2. No standing water on the floor in Rooms C-201 and C-202.
4. The interior doors in both modules are considerably warped and have mold and stain below the water level.

5. Based on the marks on the walls in both modules, the water level during flooding was 2 feet above floor level. There is a zone of moisture of about 20 inches above the flood level on all walls. This zone of moisture was not observed in Modules S-1 and C-1 with conventional gypsum board material.
6. Interior doors in both modules are starting to split at the bottom. There are cracks at the joints.
7. In Module C-2, part of Wall 1, the interior wall in Room C-202, and Wall 4 in Room C-202 had water resistant, fiber reinforced gypsum sheathing on the walls. All other interior walls in C-2 were covered with fiber reinforced gypsum interior panels. The difference between water resistant, fiber reinforced gypsum sheathing and the interior panels is that the interior panels are faced with about 1/8" cellulose pressed fibers on each side. The sheathing does not have this facing and is impregnated with silicon to increase its resistance to moisture. Mold was observed only on the interior panels, not on sheathing.
8. In Module S-2, the surface of the interior wall panels is deteriorated. Joint compound is coming off, especially below the water level.
9. In both modules, paint is blistering and peeling on the interior walls and falling off below the water level.
10. Flat paint is adhering better than the semi-gloss paint on the fiber reinforced gypsum material.
11. All interior walls are severely stained and discolored below the water level.
12. Interior doors in both modules are discolored below the water level.
13. In both modules, windows have no noticeable resistance to opening. Frames have no apparent damage. The vacuum seal appears intact, i.e. there is no fog between panes of glass.
14. In both modules, no water is found in the cavity of either the interior wall or the exterior walls. This is verified by drilling one inch diameter holes above the molding of both in interior and the exterior walls. No standing water is felt in the cavities of the exterior walls. In both modules, the interior wall has no standing water. The spray foam insulation is felt through the holes and it is not saturated.
15. The wooden baseboard in both modules is severely stained.
16. On Day 10, the amount of mold growth above the flood line on the interior of Module S-2 appears to be greater than that of Module C-2.
17. In both modules, there is no growth of mold on Day 10 below the water level on the walls. The wood casing has dark stains.
18. In both modules, the simulated wood floor has a gap of about 1/16 of an inch in the end joints (perpendicular to the interlocked edges of the panels). This appears to be due to shrinkage in the longitudinal direction.

Photographic Documentation

The interior and exterior of Modules S-2 and C-2 were digitally photographed. This was done before flood and at various intervals after flooding and at the same locations and at the same magnifications. Wall-1 is that which has the window and faces to the north. Both Wall-2 (east wall) and Wall-4 (west wall) have two portions; one from Room S-202, inner room, and

one from Room S-201, main entrance room. A sketch of the module showing wall numbers and orientation is shown in Figure 5-3.

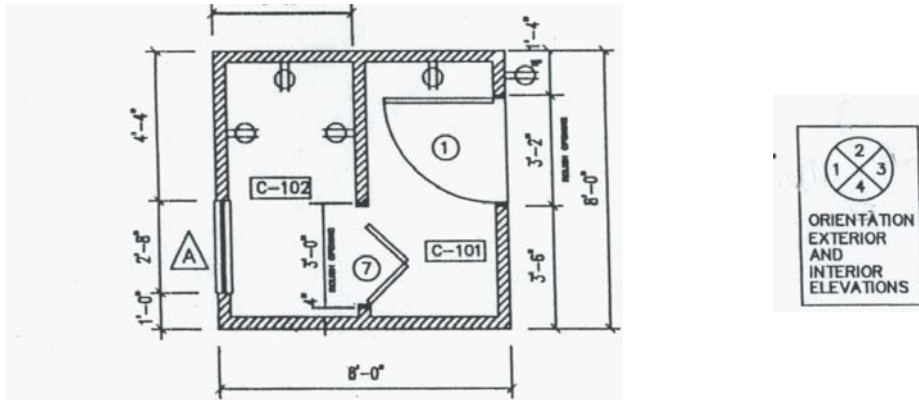

Figure 5-3 Floor plan for Modules S-2 and C-2. Walls were numbered according to the orientation key. Wall 1 is the North wall. Compass orientations are nominal.

Immediately after opening the door a set of pictures was taken. These are designated Day 8. The washing and drying protocols were then followed. A representative set of pictures for the various walls (Figures 5-4 to 5-19) is included in this report. Several points should be noted about these pictures:

- In S-2, the mold was concentrated on the walls, doors and wooden casing, in a band from 0 to 20 inches above the water line.
- In C-2, the mold was concentrated on the fiber reinforced gypsum interior panels only, in a band from 0 to 20 inches above the waterline.
- The mold appeared on all walls in S-2. In C-2, no mold appeared on the gypsum board portion of Wall 1 or on the water resistant, fiber reinforced gypsum exterior sheathing, which was used on the remainder of Wall 1 and Wall 4, Room C-202 and the interior wall of Room C-202.
- In C-2, Wall 2 and Wall 3 were tested for water retention in the cavity by drilling a few holes at the base of each wall. The spray foam insulation (SPUF) did not retain any water.
- Walls painted with latex enamel (semi-gloss) showed slightly more mold growth than those painted with flat paints in both modules.

The exterior walls all showed staining and discoloration following flooding. After washing, most of the dirt was removed and no further changes were observed on these walls for the remainder of the drying period. This can be seen in the pictorial history of the exterior walls. All of the exterior siding appears to be unaffected by the flood and the siding is 100% restorable.

Mold was observed upon reentry to the modules. However, mold was observed growing on the walls covered with the fiber reinforced gypsum panels, not on walls with gypsum board or gypsum sheathing. Views of the mold on an example wall are shown below. Further analysis of the mold count as well as the type of mold based on laboratory identification is discussed in a separate section of this report.

Walls 4 in Room S-202 and the interior wall in Room S-201, as well as the entrance and interior door were restored. Wall 1 and Wall 2 in Room C-202 were restored as well. The selection of these walls in C-2 was because Wall 1 has both gypsum board and gypsum exterior sheathing and Wall 2 is covered with fiber reinforced gypsum interior panels; thus a comparison

of the restoration between the three materials could be made. Restoration was done after the drying period, on the 17th of May. This involved sanding the surfaces and caulking any cracks and crevices and applying two coats of the original paint for the walls. In S-2 the interior door was sanded, and varnished. The exterior door had a very slight staining and after only 1 coat of paint it was completely restored. In C-2 the interior door was fully delaminated beyond restoration.

The wall restoration was applied on a strip 2' by 8' and compared with another strip adjacent to it. Four comparisons were made.

1. Compare the restored strip above and below flood level.
2. Compare the restored and the unrestored wall below the flood level.
3. Compare the restored and unrestored wall above flood level.
4. Compare the unrestored wall above and below the flood level.

Pictures showing the restored and unrestored walls and interior door are shown below in the pictorial history below.

The consensus of the examination team was that the walls and entrance door in S-2 are fully restorable. The inside door in S-2 was stained from the flood damage and it is not restorable based on the appearance following refinishing. No attempt was made to restore the interior door in C-2. The examination team's consensus was that the walls covered with all three materials in C-2 are fully restorable.

At the end of the drying period and following the completion of the restoration, an autopsy was performed on selected walls. In both Modules S-2 and C-2, Wall 1 exterior and Wall 2 exterior, as well as the interior wall were autopsied. The autopsy revealed no mold on the inside surfaces. The polyurethane foam appears to be intact with no discoloration or staining. On the exterior side, the cement and vinyl siding as well as the gypsum sheathing material were intact with no apparent mold or permanent damage.



Figure 5-4 Module S-2 (Wall 4) Pre-flood. Walls and floor are in new condition.



Figure 5-5 Module S-2 (Wall 4) Day 8. Mold growth and staining on walls



Figure 5-6 Module S-2 (Wall 4) Day 10 - After washing with water. Mold growth and staining on walls



Figure 5-7 Module S-2 (Wall 4) Day 15 - After sanitizing. Mold discoloration gone, some staining remains



Figure 5-8 Module S-2 (Wall 4) After Restoration. Wall is restorable. Although the fiber reinforced gypsum interior panels shown here on Wall 4 of Module S-2 supported mold growth due to flooding, sanitization and restoration efforts have brought the general appearance back to almost its original state.



Figure 5-9 Module C-2 (Wall 2) Pre-flood. Wall and floor in new condition

Water line
during
flooding



Figure 5-10 Module C-2 (Wall 2) Day 8 at re-entry. Wall is stained and mold growth observed



Figure 5-11 Module C-2 (Wall 2) Day 10 after washing with water. Staining and mold growth remain



Figure 5-12 Module C-2 (Wall 2) Day 15 after sanitizing. Staining remains, mold growth disappears

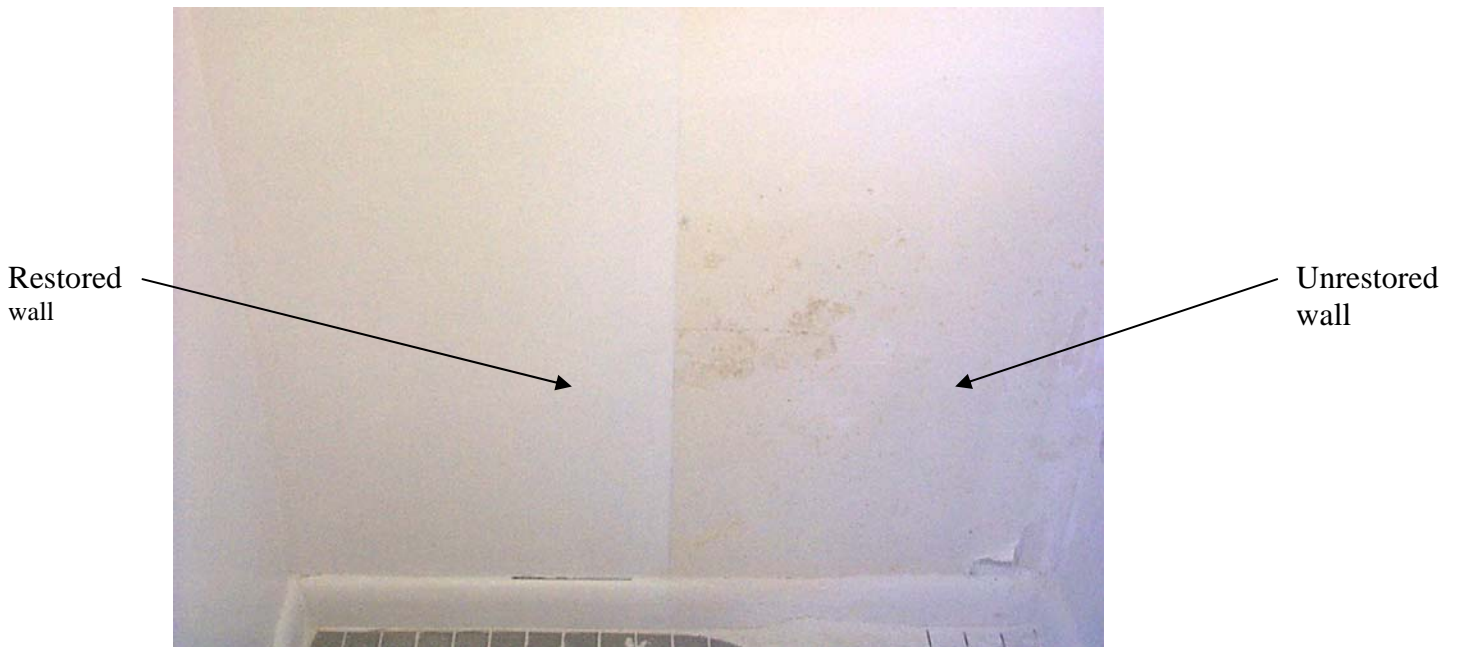

Figure 5-13 Module C-2 (Wall 2) After restoration. Wall is restored. Although the fiber reinforced gypsum interior panels shown here supported mold growth due to flooding, sanitization and restoration efforts have brought the general appearance back to almost its original state.



Figure 5-14 Module C-2 (Wall 1) North wall, Pre-flood. Wall is in new condition

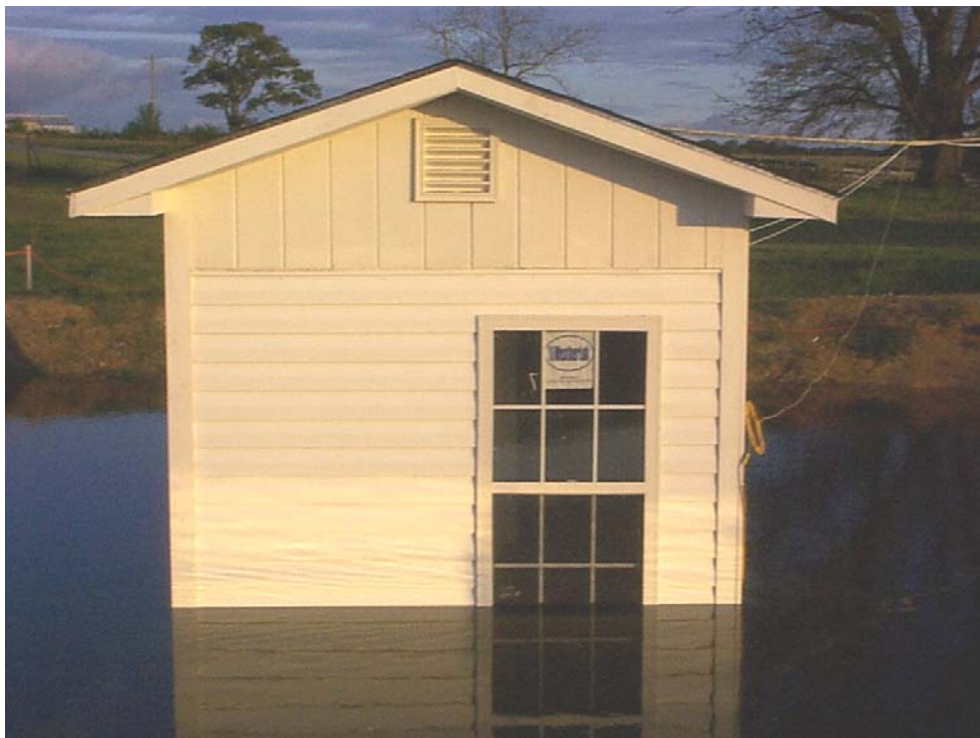

Figure 5-15 Module C-2 (Wall 1) during flood. Color variation on siding is due to light reflected from the flood water.



Depth to which unit was flooded

Figure 5-16 Module C-2 (Wall 1) Day 8 before washing. Wall is discolored



Figure 6-17 Inside of Module S-2 (Wall 4) at autopsy. Insulation and wall cavities are dry and in good condition



Figure 5-18 Module C-2 - Body of module at final autopsy and demolition



Figure 5-19 Module S-2 - Foundation of module at demolition

Relative Humidity and Temperature Profiles

The relative humidity and temperature was measured at three locations in Modules S-2 and C-2. These locations (shown in Figure 3-5) were:

- In the cavity of wall 3, 6 inches below the top plate
- In Room 201 just below the ceiling, and
- In the cavity of the interior wall, between Rooms 201 and 202

The relationship between the relative humidity at these locations together with the outdoor relative humidity obtained from the weather station, for the initial flooding period up to the point of opening the module are shown in Figure 5-20. (Module C-2 had similar readings over the 40 day period.) The relative humidity of the interior of the module, as measured just below the ceiling and the relative humidity inside the interior wall went up from about 55% to 85% during flooding and remained fairly constant until the door and window were opened. The relative humidity in exterior Wall 3 resembled that of the outdoor conditions, but with a lower magnitude during the first 8 days.

After opening the door, the pattern of the indoor relative humidity with time resembled that of the weather station only it mostly maintained a lower absolute value as can be seen from Figure 5-21, the relative humidity versus time for the entire 40 day period. Figure 5-21 indicates that the relative humidity in the cavity of the interior and exterior walls followed a similar pattern as that of the weather station, peaking during each 24 hr period, but at the same time the overall RH was becoming lower as the walls dried. Both the interior and exterior walls returned to their pre-flood RH by the end of the 40 day period.

The temperature in the cavity of the exterior Wall 3, the cavity of the internal wall and Room 201 in both modules was monitored continuously. The relationship between temperatures and time for these locations as well as the outdoor temperature profile are shown in Figure 5-22. (Module C-2 had a similar temperature profile.) The reading was taken every 20 minutes during the first 8 days of testing and every 2 hrs after opening the door on Day 8. In Figure 5-22 the three readings follow that of the outside temperature with a slight difference in the absolute value. This difference appears to depend on the sudden change in the outdoor temperature. The differences in the temperatures between the three readings in the module vary among themselves by at the most 6°C. These profiles are influenced by other factors such as fluctuation in the daily average outdoor temperature, wall orientation, wind speed, rain etc.

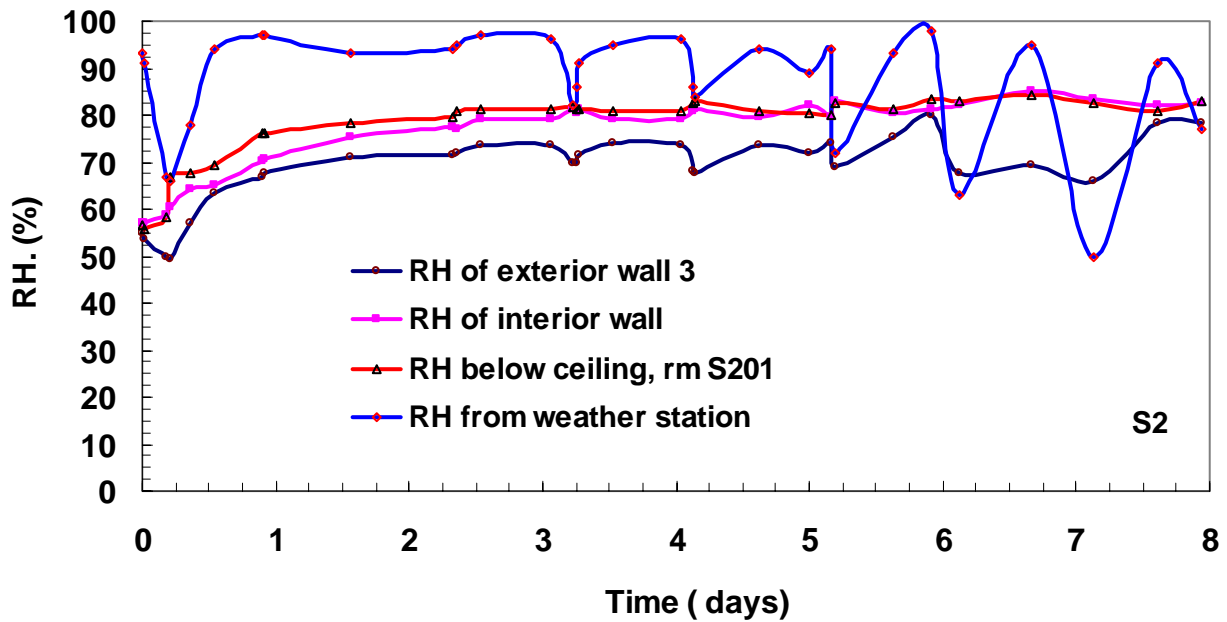

Figure 5-20 Relative humidity versus time at three different locations in Module S-2. Between the time of flooding (Day 0) and opening the module (Day 8)

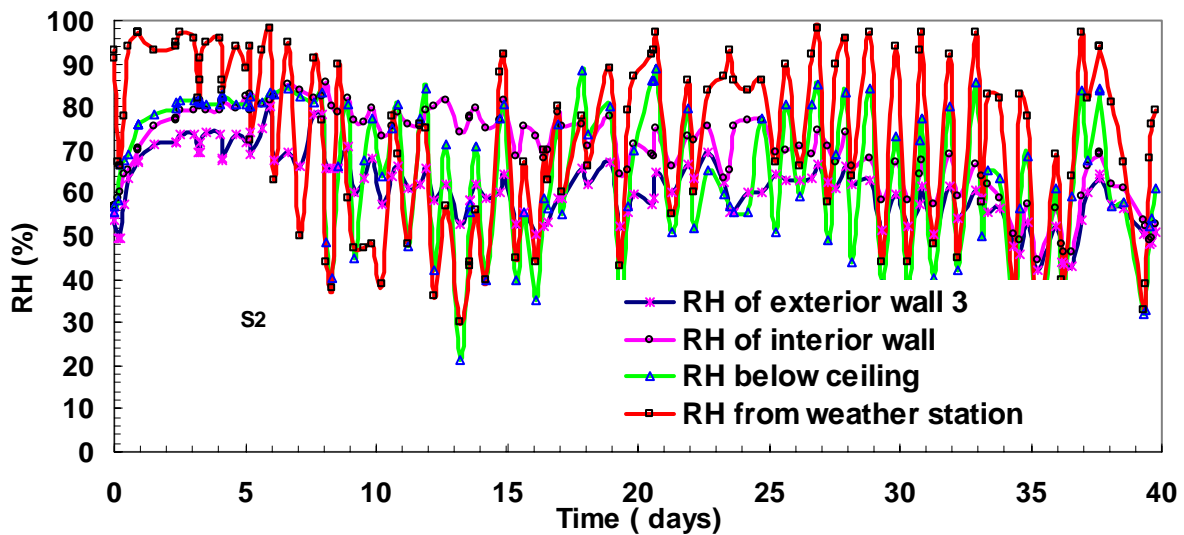

Figure 5-21 Relative humidity versus time at three different locations in Module S-2 for entire test period.

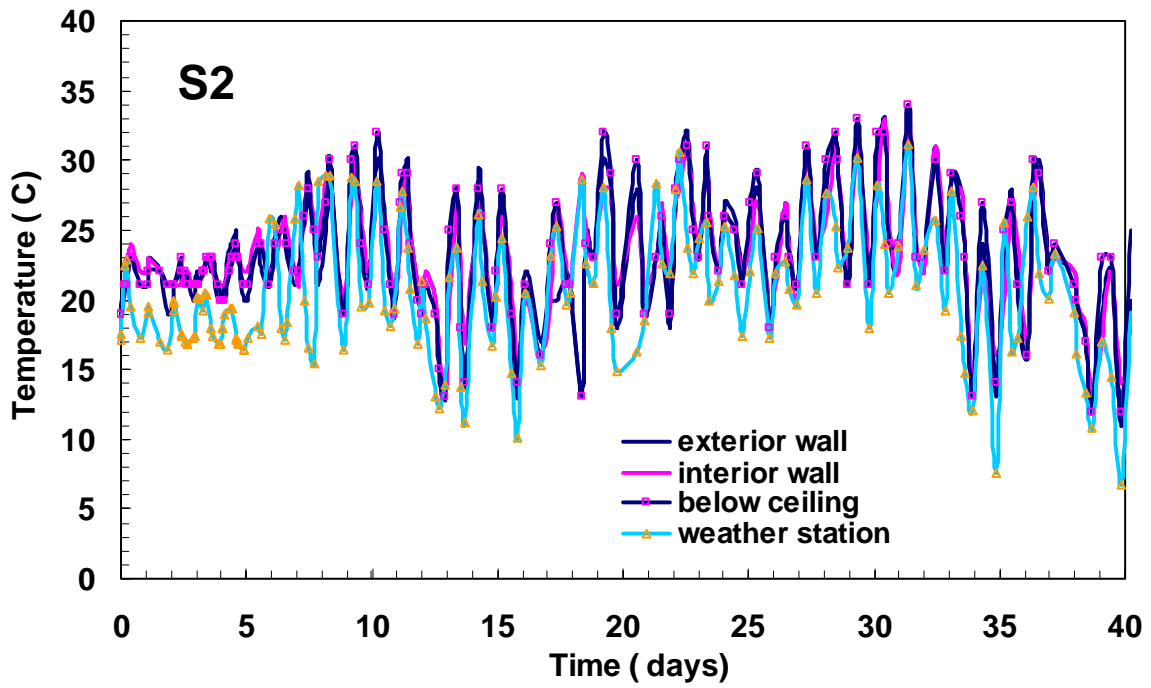

Figure 5-22 Temperature profiles for three different locations in Module S-2 and the outdoor air temperature.

Materials Moisture Content

Studs

The moisture content was monitored at different elevations in a stud in Wall 3 (exterior facing south), in the interior wall (dividing Room 201 and 202 in both modules) and in Wall 1 (an exterior wall facing north). The moisture sensors are designated M1, M2, M3, for the exterior Wall 3, located at elevations of 1.5, 2.5 and 4 feet above the floor level respectively. Sensors M4, M5, M6 were embedded in a stud in the interior wall at the same elevations. Sensors M7, M8 for the exterior Wall 1 facing north were embedded at 1.5 and 2.5 feet from floor level, respectively. Two extra sensors were installed in Module C-2 in the subflooring from the crawl space side and in a floor joist in the crawl space. The sensors were installed prior to flooding and readings were taken every 20 minutes during the flood and every 3 hours after draining and throughout the drying period. The measurements were terminated 40 days after flooding.

The relationship between moisture content and time for the two Modules S-2 and C-2 are shown in Figures 5-23 and 5-24. In Module S-2 (Figure 5-23), only sensors M1, M4 and M7 (below the water level) recorded significant changes in the moisture content, and other than the additional sensors in the floor, readings were similar to Module C-2. In Module C-2 (Figure 5-24), only the sensors below the water level, 1.5 feet from the floor, and the two extra sensors in the subflooring and the joists recorded significant changes in the moisture content. The moisture content rose sharply at flooding and remained almost constant during the flooding period. The moisture content in the sub-flooring reached about 80% towards the end of the flooding in Day 3. The next recorded highest moisture contents were in Wall 1 (1.5 feet from the floor), followed by the joist. The reading of the sensor 1.5 feet above the floor in Wall 3, reached about 36% at the end of the flooding period, while that in the interior wall at 1.5 feet from the floor reached about 45%. All of the remaining sensors, which were above the flood level did not show any appreciable increase during the first 8 days and throughout the remainder of the drying period.

After draining, the reading of the sensor in the joist in Module C-2 dropped in a similar manner to the other sensors; however it showed a slower drying rate than the others except the sub-flooring. The reading of the sensor in the sub-flooring dropped slowly from the 80% at Day 3 to about 60% at Day 4. It remained at around 60% for almost 22 days from the start of the flood. Following this, the moisture readings in all of the sensors converged to a moisture content band between 10 and 25%. The moisture reading of the subflooring after this point dropped to about 30%, which is comparable with the other sensors.

The relationship between moisture content and time for the entire 40 days is given in Figure 5-24. The rate of moisture absorption during flooding is higher for the subfloor and it took a longer time to dry. It reached about 80% during the flooding period and it took more than 22 days to drop to 30%. After draining, which occurred on Day 3, the readings of all other sensors dropped suddenly reaching a range of 25-35% on Day 5. All sensors above the water level appear to have a very similar pattern throughout the flooding and drying period.

The moisture content of the studs inside Wall 3 of Module C-2 is very similar to that of the studs inside Wall 3 of Module S-2. Both of these walls face south. The moisture content of the studs inside the interior wall of both modules is similar, also. The moisture content at 1.5 ft. from the floor in the stud in Wall 1 facing north was much higher during flooding and remained higher during the drying period in comparison with Wall 3 and the interior wall.

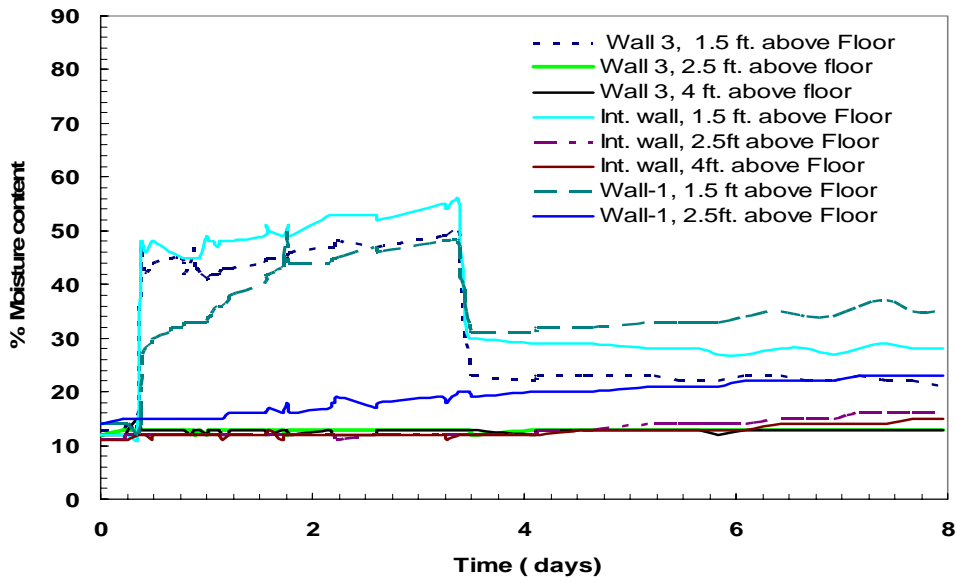

Figure 5-23 The relationship between the moisture content and time for exterior and interior wall studs in Module S-2, first 8 days. The period of flooding is 72 hours

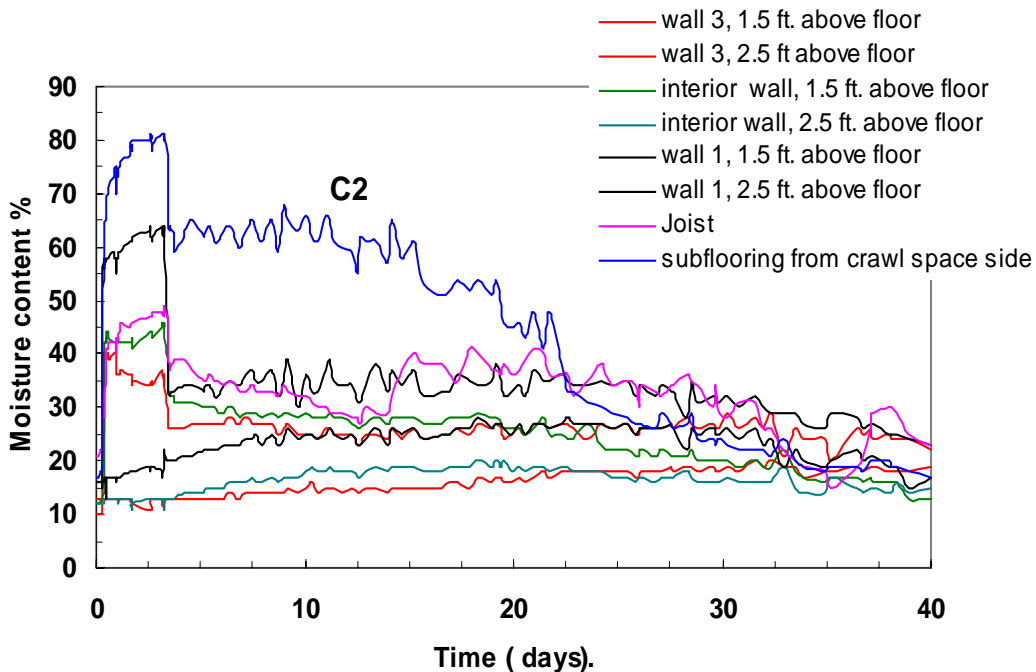

Figure 5-24 Relationship between the moisture content and time for exterior and interior wall studs, subflooring and joist in Module C-2. Days 1- 4 is the period of flooding. The drying period begins with Day 4.

Exterior Siding

Two types of exterior siding were used in Module S-2. These were cement board on Walls 2 and 3, and vinyl siding on Walls 1 and 4. Module C-2 used cement board siding only. In S-2, the sheathing on all walls was water resistant, fiber reinforced gypsum material. Both Wall 1 and 4 of S-2 have a felt membrane between the sheathing and siding. The sheathing has a very thin cellulosic fiber on the surface unlike the interior fiber reinforced gypsum panels. The latter has a fairly thick layer of fibers on each side of the panel. The thickness of each material is 1/2 inch. The thickness of the fiber layer on each side of the interior panel is about 0.125”.

The Delmhorst hand held measuring instrument did not have a specific calibration for the cement board siding, therefore Calibration -2 was used, due to the similarity between cement board and concrete. The hand held measuring instrument is standardized on a scale of 0 to 100% as follows for calibration -2.

- 0- 85% dry material
- 85 – 95% material has medium level moisture
- 95- 100% material is wet

The moisture content was measured for the cement board siding on Walls 2 and 3 in Module S-2 using the hand held moisture meter. The results in Figure 5-25 are for Walls 2 (east wall) and 3 (south wall), since these walls have the cement board siding. (Results for Module C-2 are similar.) The moisture content below the flood level was at maximum wetness from Day 8 to Day 14. Then, Wall 3 experienced a faster drying rate than Wall 2 due to its orientation to the south. In the time period from Day 0, which is pre-flood, to Day 8, no measurements were taken. Measurements started on Day 8, once the module had been drained and was open for inspection. Above flood level there was no significant change in the moisture content.

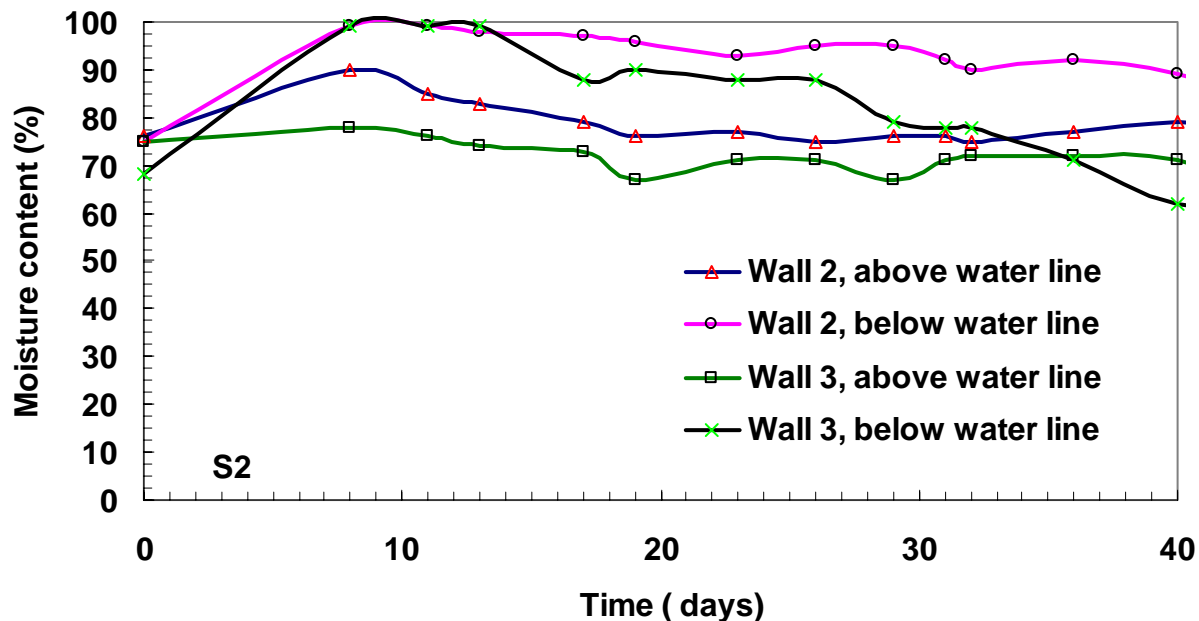

Figure 5-25 Moisture content of the cement siding, Walls 2 and 3 versus time for Module S-2. All moisture contents should be considered relative to their original readings and not absolute values.

Interior Walls – Fiber reinforced gypsum panels

The moisture content of the interior panels was measured before flooding and during the drying period with a Delmhorst hand held measuring instrument. This material is made by U.S. Gypsum and used instead of the conventional gypsum board. It is a sandwich type construction with a nominal thickness of 0.5". The core is gypsum with a thickness of about 0.25" while the two outside facings are of cellulosic material with a thickness of 0.125" each. To measure the moisture content in these gypsum panels, -3 gypsum board material was used. The instrument is standardized on a scale of 0-6 for gypsum board as follows.

0-0.5%, board is dry

0.5 – 1 %, board has a medium moisture level

1 –6.0%, the board is wet

In both modules, the moisture content of the interior panels was measured before flooding and again after reentry and the opening of the door and window. Measurement was continued throughout the remainder of the drying period and was done on all walls including the interior wall between Rooms 201 and 202 from each side, at the following locations:

At 6 inches above floor level which is identified as below the water line

At 4 feet above the floor level which is identified as above water line

In Module S-2, the relationship between the moisture content and time for all walls is shown in Figure 5-26 for the two locations on each wall. The maximum moisture content was about 6% for all locations below the water line (2 feet from floor). The maximum moisture content at heights 4 feet had a range between 1 and 2.5% and reached the pre-flood conditions at the end of the drying period. It took about 24 days from the opening of the unit for the moisture content below the water line for all walls to reach the pre-flood condition. *The moisture content for the interior fiber reinforced gypsum panels cannot be compared with that of wood products because of a difference in the instrument calibration. All moisture contents should be considered relative to their original readings and not absolute values.*

Examination of the relationship between the moisture content and time for all walls below the water line in Module S-2 reveals that Wall 6 (interior wall in Room S-201) has the fastest drying rate. It reached pre-flood conditions in about 20 days from flooding. This wall had a south exposure when the main door was kept open, which may explain the faster drying rate. Both Walls 2 and 5 took about 26 days to dry while Walls 3 and 4 took about 29 days to dry. Wall 1 had the slowest drying rate of about 32 days. Only Wall 6 had a noticeable moisture content of about 2.5% above flood line upon reentry on the 8th day of flooding. All other walls had a moisture range between 0.6 and 1.7%. The difference in drying rate between the four walls appears to be independent of the orientation. This difference in drying rate could be attributed to the impact of the spray foam insulation in the exterior walls. Unlike fiberglass insulation, the spray foam insulation did not retain significant moisture.

The relationship between the moisture content and time for the gypsum panels on the interior wall in Module C-2 is shown in Figure 5-27 for the two heights. In Module C-2 Wall 1, the interior wall in Room C-202 and Wall 4 within Room C-202 have water resistant gypsum exterior sheathing instead of gypsum interior panels. Figure 5-27 shows that the maximum moisture content was about 6% below the flood level on all walls. These values are very similar to those obtained for Module S-2.

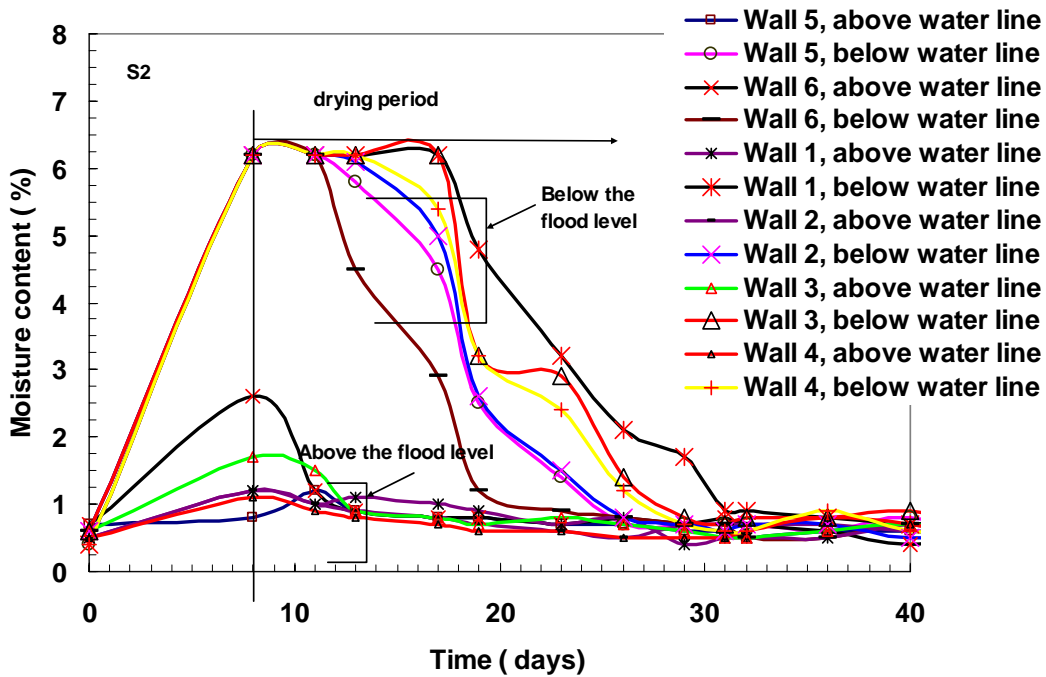

Figure 5-26 Moisture content vs. time, fiber reinforced gypsum panel interior walls in Module S-2. Day 0 is the beginning of flooding, Day 3 is the draining of the basin, and Day 8 is the reentry into the module and the beginning of observation and measurements. *All moisture contents should be considered relative to their original readings and not absolute values.*

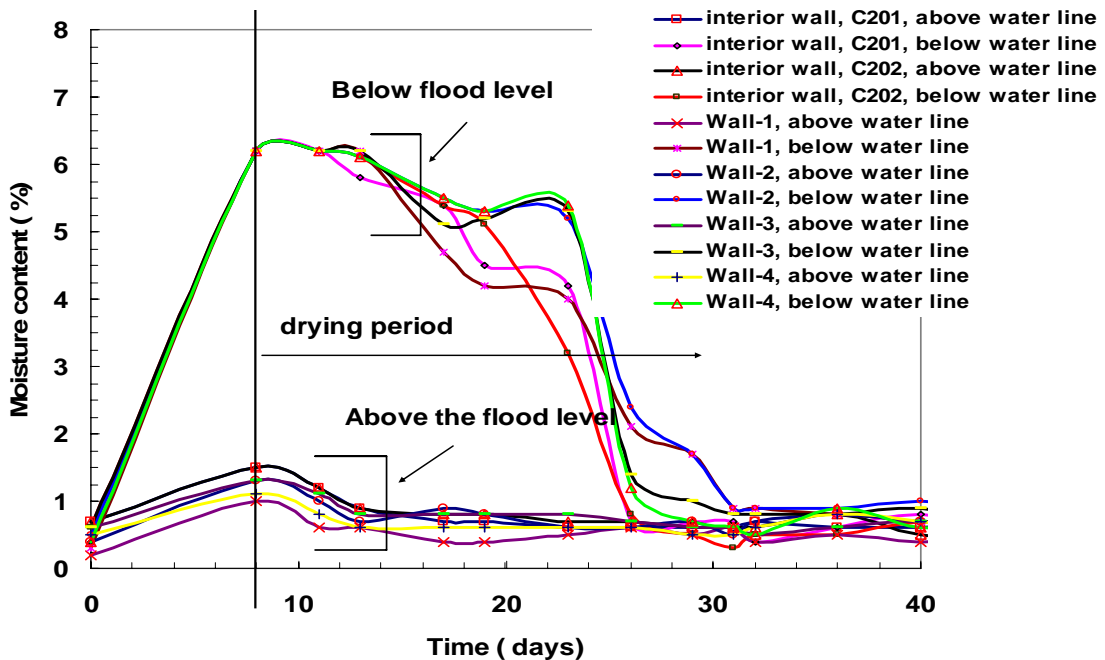

Figure 5-27 Moisture content vs. time, fiber reinforced gypsum panel interior walls in Module C-2. Day 0 is the beginning of flooding; Day 3 is the draining of the basin; Day 8 is the reentry into the module and the beginning of observation and measurement. *All moisture contents should be considered relative to their original readings and not absolute values.*

Mold Observations

Module C-2: The types of spores identified in Room C-201 were Cladosporium and Chaetomium which are both allergenic. In Room C-202 the mold spores identified were Penicillium, Aureobasidium and Aspergillus, which are also all allergenic.

Module S-2: In Room S-201 Penicillium, Rhodotorula and Aspergillus were identified as being present. In Room S-202 Alternaria, Ulocladium, Aureobasidium and Aspergillus were present. All of these molds are allergenic.

The mold spores in a 75 sq. in. area of each wall were counted. The minimum and maximum mold sizes were also identified and the area covered by mold was calculated. These results are shown in Tables 5-3 and 5-4. .

Table 5-3 Mold count data for Module S-2

Module S-2	Mold counts in the area of 75 in ²	Size of the molds (inch)		Area percentage covered by mold
		Minimum	Maximum	
Wall 1	30	0.25	1.25	35%
Wall 2, S-202	50	0.25	1.25	85%
Wall 2b, S-201	80	0.125	0.75	85%
Wall 3	35	0.125	0.75	40%
Wall 4, S-201	45	0.25	1.25	80%
Wall 4b, S-202	20	0.125	1.0	30%
Interior Wall, S-202	35	0.25	1.25	50%
Interior Wall, S-201	30	0.125	1.0	35%

Table 5-4 Mold count data for Module C-2

House C-2	Mold counts in the area of 75 in ²	Size of the molds (inch)		Area percentage covered by mold
		Minimum	Maximum	
Wall 1 Left	0	0	0	0
Wall 1 Right	0	0	0	0
Wall 2, C-202	100	0.125	0.75	75%
Wall 2, C-201	24	0.0625	1.25	25%
Wall 3	30	0.0625	0.75	20%
Wall 4, C-201	0	0	0	0
Wall 4, C-202	40	0.25	1.0	60%
Interior Wall, C-202	0	0	0	0
Interior Wall, C-201	11	0.25	1.25	10%

Mechanical Properties Testing

Materials

The effect of flooding on the mechanical properties of the exterior fiber cement lap siding, the interior wall board, the exterior sheathing (used on walls inside Module C-2), and the floor sheathing to construct Modules S-2 and C-2 was investigated. Three point bending tests were performed on five identical specimens from each material and from each module.

Specimens from the various locations were tested as follows:

- As received
- After autopsy, above water line (at 5 feet from floor)
- After autopsy, below water line (at one foot from floor)

Experimental Results

Specimens were cut from different locations as shown in Figures 5-28 and 5-29. Each specimen had a width of 5" and an overall length of 7". The thickness of the material varied depending on the type of material. The fiber cement lap siding had a thickness of 5/16" (8 mm). Exterior sheathing and interior wall board had a thickness of 0.5" (12.7mm). The floor sheathing had a thickness of 0.25" (6.5mm). The geometry and the loading configuration of the specimen used in the current study are shown in Figure 5-30.

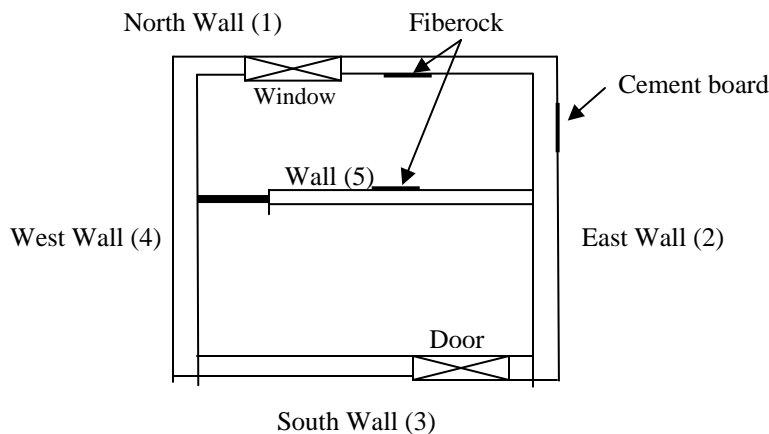

Figure 5-28 Schematic diagram of Module S-2 showing the location of the flexure test specimens.

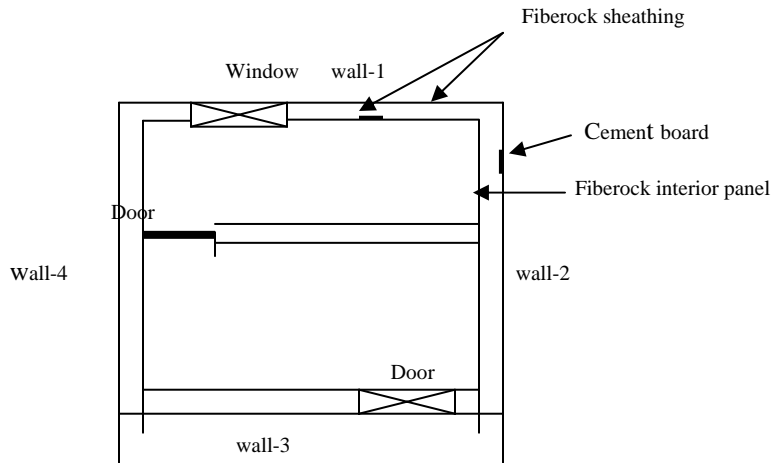

Figure 5-29 Schematic diagram of Module C-2 showing the location of the flexure test specimens.

All specimens were tested using an MTS Sintech 5/D machine following ASTM D1185 standard for three point flexural test. Five specimens from each material were used to evaluate the ultimate flexural strength and flexural modulus of the material from each location below or above the water line and the average is reported. (Ultimate flexural strength is considered the more critical measurement when evaluating flood damage resistance and restorability of these materials.)

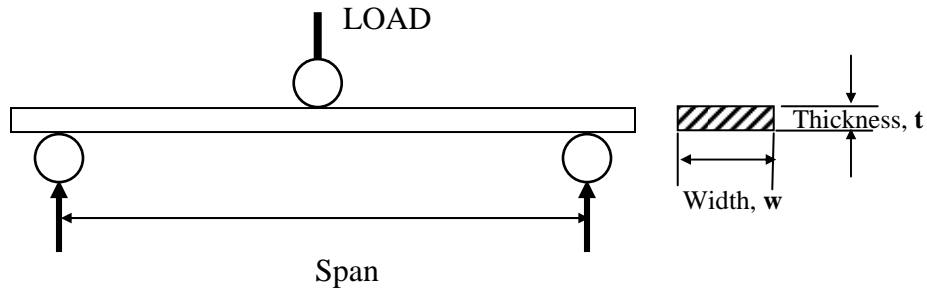

Fig.5-30 Specimen geometry and loading configuration

The ultimate flexural strength and flexural modulus were obtained from equations 5.1 and 5.2, respectively.

$$\text{Ultimate flexural strength, } \sigma_u = \frac{3PL}{2wt^2} \quad (5.1)$$

where P is the failure load, L is the length of the specimen, w is the width of the specimen, and t is the thickness of the specimen.

$$\text{Flexural Modulus, } E = \frac{L^3}{48I} \left(\frac{dp}{dv} \right) \quad (5.2)$$

where L is the length of the specimen, I is the Moment of inertia ($\frac{wt^3}{12}$), and $\left(\frac{dp}{dv} \right)$ is the slope of the first linear portion of the load versus deflection curve. The results of ultimate flexural strength and the flexural modulus of the fiber cement lap siding and the interior wall board for Module S-2 at different locations before flooding and after autopsy are given in Table 5-5.

Table 5-5 Mechanical properties of fiber cement lap siding and fiber reinforced interior wall board for Module S-2. A.W.L. in the table is “above water line”, and B.W.L. is “below water line”.

Exterior: Fiber cement lap siding

Location	Thickness in. (mm)	Observation Period	Mechanical properties	
			Ult. Flex. Strength (MPa)	Modulus (GPa)
As received	5/16” (8)	Before flood	19.8	7.2
Ext. Wall -2, B.W.L	5/16” (8)	After autopsy	19.7	5.2
Ext. Wall -2, A.W.L	5/16” (8)	After autopsy	19.4	7.7

Interior: Fiber reinforced interior wall board

As received	½” (12.7)	Before flood	4.0	2.1
Wall -1, B.W.L.	½” (12.7)	After autopsy	3.68	1.7
Wall -1, A.W.L.	½” (12.7)	After autopsy	4.19	1.97
Wall -5, B.W.L.	½” (12.7)	After autopsy	3.44	2.17
Wall -5, A.W.L.	½” (12.7)	After autopsy	4.21	2.25

The ultimate flexural strength of the fiber cement lap siding was not affected by the flooding. Values for ultimate flexural strength ranged between 19.4 and 19.8 MPa. This scatter is within experimental error. The flexural modulus of the fiber cement lap siding below the water level was about 28% lower than the as received material. There is no significant difference in the modulus of the fiber cement lap siding above the water line and the as received material.

The interior wall board results were compared for the as received material and samples taken from Wall 1 and Wall 5. In Table 5-5 there is no significant difference between the ultimate flexural strength of the as received material and that of the above water line material for the two walls. The samples taken for testing after flooding had plaster and paint applied to the wall board. The as received samples did not. The sample of Wall 1 below water level had 92% of the ultimate flexural strength that the as received sample had. The sample of Wall 5 below water level had 86% of the ultimate flexural strength that the as received sample had. The ultimate flexural strength of the below water line samples was high enough that the fiber reinforced interior wall board was considered restorable.

The failure of the fiber reinforced interior wall board under 3-point bend tests is shown in Figure 5-31. The failure initiated from the tension side of the specimen at the outer fibers.



Figure 5-31 Fractured specimens from fiber reinforced gypsum wall panels in Module S-2

Table 5-6 shows the mechanical properties of the materials used in Module C-2. From the flexural testing results of all the materials involved in Module C-2, it appears that there is no considerable degradation in the ultimate flexural strength of any of the materials after flooding. In most cases, there was a slightly lower ultimate flexural strength in materials sampled below the water line, but it was considered minor. Therefore, all of the materials were found to be restorable.

Table 5-6 Mechanical properties of fiber cement lap siding, interior wall board, exterior sheathing, and floor sheeting for Module C-2. A.W.L. in the table is “above water line”, and B.W.L. is “below water line”.

Exterior: Fiber cement lap siding

Location	Thickness Inch/(mm)	Observation Period	Mechanical properties	
			Ult. Flex.Strength (Mpa)	Modulus (Gpa)
As received	0.315inch (8mm).	Before flood.	19.8	7.2
Ext. wall -2 A.W.L	0.315inch (8mm).	After autopsy.	21.25	6.63
Ext. wall -2 B.W.L	0.315inch (8mm).	After autopsy.	18.64	5.96

Interior: Fiber reinforced gypsum interior wall board

As received	0.5inch (12.7mm).	Before flood.	3.99	2.06
Int. wall -2 A.W.L.	0.5inch (12.7mm).	After autopsy.	3.55	1.72
Int. wall -2 B.W.L.	0.5inch (12.7mm).	After autopsy.	2.79	1.34

Interior: Water resistant fiber reinforced gypsum exterior sheathing.

As received	0.5inch (12.7mm).	Before flood.	6.19	3.5
Ext. wall -1 A.W.L	0.5inch (12.7mm).	After autopsy.	5.83	1.74
Ext. wall -1 B.W.L	0.5inch (12.7mm).	After autopsy.	5.09	1.94
Int. wall -1 A.W.L.	0.5inch (12.7mm).	After autopsy.	4.79	1.77
Int. wall -1 B.W.L.	0.5inch (12.7mm).	After autopsy.	6.25	2.12

Interior: Fiber cement floor sheeting

As received	0.25inch (6.5mm).	Before flood.	10.81	5.2
Floor.	0.25inch (6.5mm).	After flood.	10.21	4.92

DISCUSSION AND CONCLUSIONS

Flood damage resistance includes both physical and human health factors. The experimental modules were tested for resistance to physical degradation that results from the wetting and drying cycle associated with flooding. Testing did not address the structural impact on the envelope of externally applied hydrostatic pressures. Flood depth was limited to two feet above floor level, which applies a pressure that is within the strength capabilities of typical wood frame construction. Post flooding mold growth was documented and selected specimens analyzed. Bacteriological and toxic materials testing were not performed during this series of tests.

Within the limits described above the testing of potentially flood damage resistant building envelope systems in two modules under simulated flood conditions revealed the following.

1. Two products made by USG—Fiberock water resistant fiber reinforced sheathing and Fiberock fiber reinforced gypsum wall panels—were tested as exterior sheathing and interior wallboard. The sheathing was used both externally as sheathing and internally a wallboard. At the time of these tests, USG was developing a new product for interior use (Acquatough) with the characteristics of the sheathing product. These products used on the interior walls were able to be sanitized, sanded, patched, and repainted to restore them to pre-flood condition. The sheathing which is described by USG as “water resistant,” supported little, if any, mold growth, when used either as exterior sheathing or interior wallboard. The fiber reinforced wallboard, however, had somewhat more mold growth than was observed on standard paper-faced gypsum wallboard subjected to the same conditions. The wallboard, like the sheathing, was able to be sanitized to remove the mold and restored to pre-flood condition, albeit with some additional effort. While both materials are somewhat more expensive to install than conventional gypsum wallboard, they have the ability to be restored with reasonable effort after a flood. While not tested, other water resistant gypsum wallboard products may have similar properties to those tested.
2. The substitution of spray polyurethane foam (SPUF) insulation for fiberglass in the exterior wall cavities enabled the adjacent gypsum wallboard and wood studs to dry at about the same rate as the interior wall with empty cavities. This factor coupled with the restorability of the wallboards described in Item 1.(above) suggests that SPUF insulation would be consider both flood damage resistant in itself and that it has a positive impact on the flood damage resistance of materials around it by allowing them to dry. Although SPUF is significantly more expensive than batt insulation, it can provides a higher R-value and a better air seal than batt insulation thereby reducing energy loss through the walls and lowering utility bills. In addition, because SPUF absorbs water very slowly it will not require treatment or replacement should a house be subjected to a subsequent flood.
3. Vinyl siding and fiber cement sidings both withstood flood conditions better than hard board lap siding and plywood siding. Only washing that portion of the siding that was

below flood level was required to restore them to pre-flood condition. They did not appear to have any adverse impact on adjacent materials in the wall system.

4. Vinyl and aluminum window frames, as well as insulated steel or fiberglass exterior doors, were able to be restored to pre-flood conditions with minimal effort. All of these components would be considered to be flood damage resistant.
5. The interior doors tested thus far were not considered economically restorable given the relatively low cost of replacement. Given this situation, interior doors should be considered expendable or “throw-away” items and not be judged against a flood damage resistance standard.
6. Sealed concrete floors in slab-on-grade construction resist damage from flooding, as do ceramic floor tile and wall tile in either slab-on-grade or crawlspace construction. Sealed concrete floors are considered flood damage resistant. Ceramic tile floors and tile walls are in themselves considered flood damage resistant. However, not enough testing has been accomplished to determine how well they will work as a component in a floor or wall system. The impermeable characteristics of these tiles could trap moisture within systems causing them to deteriorate over time.
7. All carpeting and padding tested thus far became dirty and smelly after flooding. It also absorbs and retains large amounts of moisture which can slow the overall drying rate throughout the house. Even if the carpet is able to withstand the flood it should be removed for cleaning and drying and to promote drying within the home. Where appropriate, carpeting should be replaced with other flooring materials with better attributes to withstand the impacts of flooding without requiring removal.
8. The simulated wood flooring tested was chosen because of its availability and relatively high plastic content. While approved for use in bathrooms (with special installation procedures) this material made no claims to either water or flood damage resistance. Our testing caused the material to warp and have open joints when left in place on the floor after the flood. This flooring material, when removed, washed, and stacked to dry after the flooding, had much less warping and some of the material could be reused. Unfortunately the process of removal damaged some of the pieces. Therefore this material, even with removal and reinstallation, would probably not be considered flood damage resistant.
9. In the first test (Modules S-1 and C-1) flat latex paint appeared to support mold growth better than semi-gloss paint. In the second tests (Modules S-2 and C-2) mold growth appear to be associated more with substrate than the paint. The water resistant wallboard had little or no mold growth, while the other wallboards supported mold growth regardless of the paint on the surface. Thus no clear conclusion can be reached from the first two tests regarding the impact of paint type on mold growth. This area was further evaluated in subsequent testing.
10. Punching a limited number of holes near the bottom of gypsum board walls was done

again to determine the amount of water remaining in the walls after the flood recedes. Like the first test no water was found. Unlike the first test which had fiberglass insulation, the SPUF insulation did not feel saturated. In many cases, gypsum board walls may be able to be cleaned, sanitized, and easily restored if holes are not punched. Unless there is a strong reason to believe that water remains trapped in the wall cavities, punching holes in gypsum board walls for drainage is not necessary.

6. FLOOD DAMAGE RESISTANT RESIDENTIAL ENVELOPE SYSTEMS: Modules S-3 (Slab-on-Grade), C-3 (Crawl Space), and S-3a (Slab-on-Grade)

PURPOSE

The primary purpose of testing in Module S-3 was to attempt to dry flood proof (no water inside) the module. If the module and its door and window openings could be sealed well enough to prevent water from entering the module, then this would be an effective method of making the interior flood damage resistant. The secondary purpose was to further evaluate the performance of potentially flood damage resistant materials and systems should the dry flood proofing attempt be unsuccessful.

Module C-3 was tested in the same manner as the previous Modules S-1, C-1, S-2, and C-2. The crawlspace foundation is vented and it would have been nearly impossible to have sealed the crawlspace from the floodwater. Instead operable flood vents were installed and tested, to allow water in and out of the crawlspace during and after flooding. Module C-3 provided the opportunity to do further flood damage resistance tests of residential materials and systems.

The sole purpose of Module S-3a was to make a second effort to dry flood proof the slab-on-grade module. Module S-3 was a first attempt to achieve dry flood proofing in the slab on grade, wood frame test module. The attempt failed due primarily to leakage between the sill plate and floor slab. Module S-3a reused the previously flooded S-3 module (with the modifications described later) for a second attempt.

DESCRIPTION

The protocols that were developed for previous modules, A Protocol for Field Testing Flood-Damage-Resistive Residential Envelope Systems and A Protocol for Drying Out, Restoration, and Autopsy of Test Modules, were adopted for Modules S-3 and C-3. If Module S-3 was successfully dry flood proofed, drying out and restoring the module would not be necessary. Unlike previous tests, Module S-3a only investigated the ability of the module to withstand floodwater entry. All other elements of our testing protocols were suspended for this test. The building materials and their configuration for Modules S-3 and C-3 are shown in Tables 6-1 and 6-2.

Table 6-1 Building Materials and Configuration for Module S-3 (also S-3a)		
Component	Location	Material
Siding	North, south, east, and west (all) exterior walls	Vinyl siding--Follow Owens Corning Vinyl Siding Installation Guidelines. Use accessories (end caps, framing at corners, doors, windows) as recommended in Siding and Accessories flyer under Horizontal Siding Installation. (This means that framing at corners, windows, doors, is vinyl, not wood.)
Sheathing	All exterior walls	Fiberock sheathing
At all points below 4 ft. above floor level, caulk and seal thoroughly at ALL intersections of materials. Where appropriate, use GE Silicone II 100% silicone sealant for caulking at all areas where water may leak through exterior wall. Where gaps are wider than 3/8 inch, use Dow Great Stuff insulating, low expansion, foam sealant. Seal at joint between bottom of stud and sill plate, at joint between sill plate and floor, along studs that meet at corners, at joints between finish frame and rough openings at door and window and any other potential path for water to penetrate to the interior of the structure. Tool sealant so that it is flush, and finish materials can be installed over the sealant.		
Insulation	All exterior walls	Spray polyurethane foam (against sheathing)
Housewrap	All exterior walls	None
Interior wall board	All interior walls	Standard, paper-faced ½ inch gypsum wallboard, with fiberglass mesh tape at joints and quick set joint compound
Wall finishes	All interior walls	Latex interior wall paint, 2 coats
Vapor barriers	All walls	None
Doors	Exterior	Use same type of door (new door) as used in 2-S. Seal carefully at jambs, and where rough and finish opening meet. (For doors, seal between rough opening and finish frame with low expansion spray foam sealant--Dow Great Stuff.) After threshold is attached to floor, drill 4 ea. 3/8 inch holes through the middle top of the threshold. Space holes evenly across length of threshold. Stick the nozzle of Dow Great Stuff Insulating Foam Sealant into the holes that have been drilled. Turn nozzle in all directions and fill the space below the threshold with sealant until the hole is filled. Also, seal outside and inside edge of threshold where it touches the floor with GE Silicon II 100% silicon sealant Barrier/dam designed and provided by ORNL.
	Interior	None
Windows	North wall	Aluminum , baked white enamel, double pane American Craftsman Series 2160 Single Hung window, clear, with LoE ² glass. (Seal between rough opening and finish frame must be thorough to achieve dry floodproofing. Use Dow Great Stuff or GE Silicone II 100% Silicone Sealant.) Barrier/dam designed and provided by ORNL
Electrical distribution	Interior walls	Traditional in-wall electrical wiring, same as for tests S-1 and S-2
Ceiling	Ceiling	Gypsum board ceiling, painted, 2 coats as in S-1 and S-2. Finish with white interior latex paint.
Attic and roofing	Attic and roof	Construct identical to tests S-1 and S-2.
Floor structure	Floors	Concrete slab, same as tests S-1 and S-2. After rough framing of module is complete, seal visible cracks in the concrete with Behr No. 980 Concrete and Masonry Waterproofer. When cured, seal entire slab with same material.
Floor finishes	Room with window	Farrington Floors' LiquaShield from Wear Dated Carpet (SKU# 211-765 TO at Home Depot) with Monterey cushion (S/O 685-643 at Home Depot) urethane core between 2 layers of vinyl film
	Room with exterior door	Floating vinyl floor: Armstrong Metro Cambray, Themes, or Sundial vinyl. Padding: Monterey cushion (S/O 685-643 at Home Depot) urethane core between 2 layers of vinyl film

Table 6-2 Building Materials and Configuration for Test Module C-3

Component	Location	Material
Siding	North and west exterior walls	Vinyl siding --Follow Owens Corning Vinyl Siding Installation Guidelines. Use accessories (end caps, framing at corners, doors, windows) as recommended in Siding and Accessories flyer under Horizontal Siding Installation. (This means that trim at corner and window is vinyl, not wood.)
	East and south exterior walls	Fiber cement siding with wood trim at corners
Sheathing	North and east exterior walls	Fiberock sheathing
	South and west exterior walls	Fiberock sheathing
Caulk and seal well, according to standard industry practice.		
Insulation	All exterior walls	Spray polyurethane foam (against sheathing)
	Below floor	None
Foundation vents	All	Smart Vents solid door flood vents (donated)--replaces both existing vents
Housewrap	All exterior walls	Not used for test C-3
Interior wall board	All interior walls	Fiberock sheathing--tape at joints with fiberglass mesh tape, NOT paper tape; use quick set joint compound
Wall finishes	C-302 (Room with window)	Water-based flat latex paint, 2 coats--cure paint for 14 days before flooding
	C-301 (Room with exterior door)	Oil-based flat enamel paint, 2 coats--cure paint for 14 days
Vapor barriers	All walls	No vapor barrier used for test C-3
Doors	Exterior	Use same type of door (new door) as used in C-2. Seal carefully at jambs, and where rough and finish opening meet. (For doors, seal between rough opening and finish frame with low expansion spray foam sealant--Dow Great Stuff.) After threshold is attached to floor, seal outside and inside edge of threshold where it touches the floor with GE Silicon II 100% silicon sealant.
	Interior	Formed wood composite (pressed wood): Raised panel interior door by Premdor, prehung, and primed. Finish with 2 coats of oil-based satin enamel. Paint ALL surfaces, including top and bottom of door.
Windows	North wall	Aluminum , baked white enamel, double pane American Craftsman Series 2160 Single Hung window, clear, with LoE ² glass. (For windows, seal between rough opening and finish frame with low expansion spray foam sealant--Dow Great Stuff.)
Electrical distribution	Interior walls	Traditional in-wall electrical wiring, same as for tests C-1 and C-2
Ceiling	Ceiling	Gypsum board ceiling, painted, 2 coats as in C-1 and C-2. Finish with white interior latex paint.
Attic and roofing	Attic and roof	Identical to C-1 and C-2
Floor structure	Floor joists	3/4" T&G plywood and standard 2 x 6 wood framing
Floor finishes	Room with window	Farrington Floors' LiquaShield from Wear Dated Carpet (SKU# 211-765 TO at Home Depot) with Monterey cushion (S/O 685-643 at Home Depot) urethane core between 2 layers of vinyl film
	Room with exterior door	Floating vinyl floor: Armstrong Metro Cambray, Themes, or Sundial vinyl. Padding: Monterey cushion (S/O 685-643 at Home Depot) urethane core between 2 layers of vinyl film

An attempt was made, while testing various building materials and configuration for flood damage resistance, to dry flood proof Module S-3. In order to dry flood proof Module S-3, the following procedures were performed.

1. All intersections of materials were caulked and sealed at all points up to 4 ft. above the floor level using GE Silicon II 100% silicone. This included the exterior sheathing and the gypsum board interior.
2. In gaps wider than 3/8", Dow Great Stuff insulation foam sealant was used.
3. The joint between the sill plate and floor slab was sealed on the inside of the module.
4. Cavities between studs that meet at corners were also sealed.
5. Joints between finish frame and rough openings at the door and the window and other potential path of water were sealed with low expansion spray foam (Dow Great Stuff).
6. After door threshold was attached to floor, four equally spaced holes (3/8" in diameter) were drilled through the middle top of the threshold. Sealant (Dow Great Stuff) was applied through these holes until the cavity was filled. Both the outside and inside edges of the threshold, where it touches the floor were sealed with GE Silicon II, 100% Silicone.
7. Gaps between the window rough opening and finish frame were thoroughly sealed using either Dow Great Stuff or GE Silicone II.
8. Visible cracks in the concrete slab were sealed with Behr No. 980 concrete waterproofer. The entire slab was also sealed with the same materials after the seal in the cracks were cured.
9. Two dams made of 2" thick rigid styrene foam insulation were fabricated and installed on the door and window of Module S-3. The dams are shown in the Figures 6-1 to 6-3.



Figure 6-1 Module S-3 Placement of flood proofing dam over window. Two beads of adhesive sealant were applied to seal the Styrofoam dam and then additional caulking was placed around all the sides.



Figure 6-2 Module S-3 Wall 1. Dam on window during flooding is staying in place.



Water from the inside of the module

Figure 6-3 Module S-3 Exterior door dam. Dam on door is leaking at right lower corner where it has been pushed out from the force of the retained water. Leakage was also observed at the corners of the test module as well as at the intersection of the interior partition and exterior walls along the slab foundation.

Module C-3 was tested in the same manner as the previous Modules C-1 and C-2. The exterior sheathing was water resistant, fiber reinforced gypsum panels. The interior finish of the walls was the same sheathing. No conventional gypsum board was used on the interior. The complete materials schedules for Modules S-3 and C-3 are provided below. Similar to Module S-3, two extra moisture sensors were installed in the middle stud of Wall 1 facing north at 1 and 2.5 feet above the floor level. Both Walls 3 and the interior wall have similar moisture sensors as Wall 1. Flood vents were installed by Smart Vent Inc. on Walls 2 and 4 to replace the standard crawls space vents. The function of the flood vents is to allow water in and out of the crawl space. The installation of the Flood Vent took about 10 minutes each (Figure 6-4) and it performed as intended in the test (Figure 6-5).



Figure 6-4 Installing an operable flood vent in Module C-3



Figure 6-5 Module C-3. Water draining out of open crawlspace flood vents

The building materials and configuration for Module S-3a were the same as those for Module S-3. These procedures were followed prior to flooding:

1. Remove interior base cove along exterior walls and inspect for gaps or unbonded portions in existing silicon caulk. Repair/replace caulk.
2. Remove the interior trim around the exterior door to expose the joint between the frame and rough opening and inspect for evidence of leaking. Repair/replace seal.
3. Remove vinyl siding from the bottom of the wall to a height of approximately 6" above the expected flood level.
4. Install silicon caulking in the exterior joint between the sill plate and floor slab. Inspect and caulk other joints/seams or other potential entry points for floodwater to a height of approximately 6" above the expected flood level.
5. Place a 6" band of adhesive backed butyl rubber tape with an aluminum foil facing all along the bottom of the module to cover the joint between the slab and the sheathing.
6. Activate the closed circuit TV cameras and prepare to monitor.
7. Place foam pellets on floor to assist in identifying water entry.
8. Mark expected flood level on interior wall in a manner that it is clearly visible to the TV cameras.
9. Activate the interior RH and temperature sensors and weather station and prepare to monitor.
10. Take moisture meter readings of interior wall surfaces per previous testing.
11. No other sensors are to be activated during this test.
12. Install the door and window flood dikes as per Test 3-S (to be accomplished at least 4 hours in advance of testing).

As part of the design of the experiment, the researchers decided to do the following procedures during flooding:

1. Flood basin per standard procedure from previous test modules.
2. Continually observe interior for entry of floodwater while raising the exterior water level to the maximum planned level.
3. If water covering the floor inside the module becomes evident during the filling of the basin, note the time after the exterior water reached floor level that this observation was made and terminate the testing.
4. If no water is observed during the filling process, continue to operate the TV camera and record the interior conditions for at least two hours after the completion of filling.
5. Monitor the TV images of the interior at least twice a day during the 72 hours that flood water is in the basin. If interior water becomes evident during this period, note when it was first observed and the depth at observation. Record the TV images on tape. If the interior water level reaches that of the exterior, the testing should be terminated at that time and the basin drained.
6. If the interior remains dry, or the interior water level remains lower than the exterior, continue the test for the full 72 hours after filling the basin. Then drain the basin per standard procedure from previous testing. Video the draining process as the exterior flood water level drops to below the floor level as was done in earlier tests.

7. If the interior remains dry, reenter the test module as soon as it is safe to do so (within 24 hours) and perform a detailed visual inspection looking for weeps or other conditions of interest. Record these conditions photographically.
8. If the interior remains dry, repeat moisture meter readings of interior wall surfaces per previous testing upon reentry.

The following changes to procedures were made during the actual test on February 11, 2003 after the module failed to achieve dry flood proofing:

1. Due to the differential between interior and exterior water levels continue the test until the standard exterior flood level is achieved. Continue to monitor the interior to determine when the interior level equals the exterior level.
2. Drain the basin when equilibrium in water levels was achieved and note the locations of water draining from the interior.
3. Reenter the module briefly after draining to inspect sources of leaks. Document these sources.
4. Re-close the module and continue to monitor the moisture conditions per the standard protocol.
5. Revert to standard post-flood protocols so that this test could simulate the impact of a short duration (~6 hour) flood as opposed to the standard 72-hour flood.

DOCUMENTATION OF TESTING

Chronology of Testing Modules S-3 and C-3

Basin Flooding:	November 7, 2002. (Day 0)
Basin Draining:	November 10, 2002 (Day 3, 72 hr flood)
Module Door and Window Opening:	November 15, 2002 (Day 8)
Wash with water:	November 17, 2002 (Day 10)
Sanitizing:	November 22, 2002 (Day 15)
Official Drying Period End:	December 10, 2002 (Day 33)

(Module S-3a follows after end of S-3, beginning on February 11, 2003)

Inspection Findings

The following are the inspection findings upon opening of modules on Day 8 made in accordance with the protocol found in Appendix A.

Exterior Inspection Findings, Module S-3

1. Force to enter door approximated as 20 lbs. based on personal estimation.
2. Caulking materials: failure at the bottom right corner from the door as well as spots on the door threshold possibly due to the pressure of escaping water during draining.
3. Exterior vinyl siding: intact, very little stain below water level.
4. Outside electrical outlet; wet, the outside screw had no corrosion.
5. Window: caulking for window dam appears to be intact.

Exterior Inspection Findings, Module C-3

1. Stain on Wall 1 and Wall 2 cement board below water line.
2. Water line was 5.5 in. above window sill.
3. Wall 3 and Wall 4 vinyl siding has some stain but appears to be washable.
4. No cracks on the wooden corner boards of the house.
5. Water line is clearly marked with a thick brown line.
6. No standing water in the crawl space.
7. Force to enter door 15 to 20 lbs. based on personal estimation.
8. Stain on exterior electrical outlet, but screw is not corroded.

Interior Inspection Findings, Module S-3

1. Vinyl flooring and carpet has a thin slimy film and a lot of bulging.
2. All walls and the ceiling were covered in condensate.
3. Paint peeled and blistered on all walls below water level (to ~26 in. above floor).
4. Wicking of water through gypsum board face to about 46 in. above the floor.
5. Mold exists on all walls in the 20 in. band above the water line (to ~46 in. above floor).
6. Gypsum board failing (especially under the window with paint peeling).
7. Severe stain and discoloration of all walls below water level.
8. Strong musty odor upon re-entry.
9. Brown stain spots on the interior of entrance door.

10. Failure of dry wall joint compound especially at corners.
11. Blistering of paint
12. Mold has an average diameter of 4 mm. and is concentrated above water line.

Interior Inspection Findings, Module C-3

1. Strong musty odor upon entry.
2. Water level is about 29.5 inches above floor level.
3. Slimy brown film on vinyl flooring.
4. Regular carpet in Room C-302 is completely saturated.
5. Wooden subfloor is completely wet.
6. Room C-302 water line appears to be 30 inches above floor.
7. There is a completely wet zone about 2 inches above water line on all walls. This appears to be caused by wicking of the moisture up by the reinforcing fibers of the wallboard.
8. Slimy film on floor and window sill in Room C-302, also on top of baseboards.
9. Window is stained below water line (still works properly).
10. Complete failure of interior hollow core door (glue failure) failure continues to door knob.
11. No mold on any of the walls with water resistant fiber reinforced sheathing.
12. Uncovered electrical outlet inside Room C-301 shows greenish colored screw and metal.
13. Paint failure below water line (to ~30 in. above floor).
14. Severe staining on all walls.
15. Severe paint wrinkling and blistering on all walls in Room C-302 which was painted with water based flat latex paint.
16. Blistering has "palm tree" type patterns.
17. Room C-301 has oil based flat enamel paint. No obvious wrinkling or blistering was observed.
18. All walls and the ceiling were covered in condensate.
19. Window is sweating on the frame.
20. Back of exterior door is severely stained.

Photographic Documentation

The interior and exterior of Modules S-3 and C-3 were digitally photographed. These pictures were taken at the same locations and at the same magnifications to the extent possible. Wall 1 has the window and faces to the north. Both Wall 2 (east wall) and Wall 4 (west wall) have two portions; one from Room 302, inner room, and one from Room 301, main entrance room. This follows the floor plan shown on the previous page in Figure 6-6.

Pictures were taken immediately after opening the doors (Day 8). The washing and drying protocols previously used in Modules S-2 and C-2 were then implemented. A representative set of photographs for the walls below the water line is shown in Figures 6-7 to 6-16. Several points should be noted in the photographs.

In Module S-3:

- The mold growth was observed immediately upon entry, five days after draining

the basin.

- The mold was concentrated on the gypsum board walls above the water line in a 20-inch wide horizontal band.
- The mold appeared on all walls with various intensities.
- Stains were apparent on all walls below the water line.
- The vinyl sided exterior walls had minimum staining that was completely removed by washing with water.

In Module C-3:

- No mold growth was observed upon entry, or at any time during the drying period, i.e. the exterior sheathing use on the interior did not encourage mold growth.
- The oil based flat enamel paint in Room 301 was not as badly wrinkled as the water based flat latex paint used in Room 302.

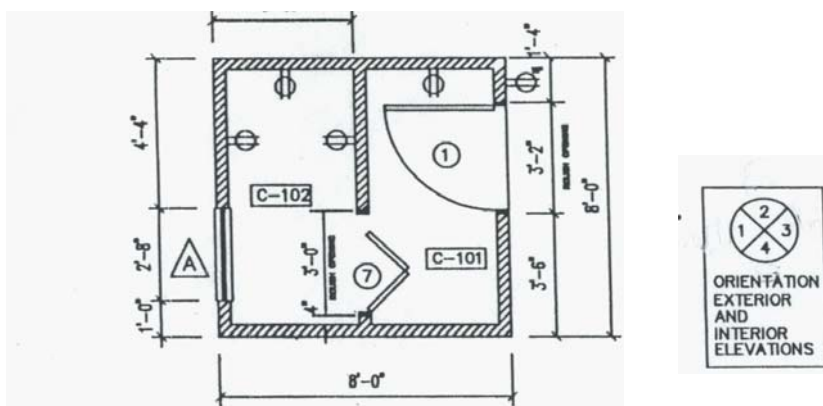

Figure 6-6 Floor plan for Modules S-3, S-3a and C-3. Walls were numbered according to the orientation key. Wall 1 is the North wall. Compass orientations are nominal.

All of the exterior walls in both modules showed staining and discoloration following flooding. After washing, most of the dirt was removed. No further changes were observed on these walls for the remainder of the drying period. All of the exterior siding was unaffected by the flood and is cosmetically restorable to pre-flood condition.

In Module S-3, mold was observed upon reentry to the unit. Views of the mold in Module S-3 are shown in Figures 6-8 and 6-9. In Module C-3, no mold was visible during the entire testing and drying period. Module S-3 was treated for mold growth in accordance with the protocol, but, since there was no mold observed, Module C-3 was not treated for mold growth.



Figure 6-7 Module S-3 (Wall 3) Pre-flood. Walls and floor in new condition



Figure 6-8 Module S-3 (Wall 3) Day 8 – Before washing. Wall is stained and there is mold growth.



Figure 6-9 Module S-3 (Wall 3) Day 10 - After washing with water. Mold remains



Figure 6-10 Module S-3 (Wall 3) Day 15 - After sanitizing. No mold visible



Figure 6-11 Module C-3 (Wall 2) Pre-flood. Walls and floor in new condition



Figure 6-12 Module C-3 (Wall 2) Day 8 – Before washing. *Note: “Pellets” on the floor at right bottom are Styrofoam which was placed on the floor of the unit prior to flooding. As floodwater rose, the pellets floated, and cameras could record locations where water appeared to flow into the unit.*



Figure 6-13 Module C-3 (Wall 2) Day 10 - After washing with water. No visible mold stains.



Figure 6-14 Module C-3 (Wall 2) Day 15. No sanitization occurred and no mold growth appeared; wall is restorable.



Figure 6-15 Module C-3 Interior door – Pre-flood. Door is in new condition.



Figure 6-16 Module C-3 Interior door – Day 8. Door surface is delaminating.

Relative Humidity and Temperature Profiles

The relative humidity and temperature was measured at three locations each in Modules S-3 and C-3. These locations (shown in Figure 3-5) were:

- In the cavity of Wall 3, 6 inches below the top plate,
- In Room 301, just below the ceiling,
- In the cavity of the interior wall (between Rooms 301 and 302).

The relationships between the relative humidity at these locations together with the outdoor relative humidity obtained from the weather station, for the initial flooding period up to the point of opening the units are shown in Figures 6-17 and 6-18. The relative humidity of the interior of the module, as measured just below the ceiling and the relative humidity inside the interior wall went up from about 70% to 80% in S-3 and from 70% to 90% in C-3 during flooding and remained fairly constant until the doors and windows were opened. The relative humidity in exterior Wall 3 of both modules resembled that of the outdoor conditions, but with a lower magnitude during the first 8 days.

After opening the door, the pattern of the indoor relative humidity with time resembled that of the weather station, but it maintained a lower absolute value as seen in Figures 6-19 and 6-20. (Note: the official designated drying period was 28 days, but observations were made through 40 days). The relative humidity in the cavity of the interior and exterior walls followed a similar pattern as that of the weather station, with a distinct difference in their magnitude. These two readings displayed lower values than the peak value of the outdoor RH and higher values than the minimum value of the outdoor relative humidity. This indicates a slower response of the RH in the cavity of the walls with respect to the change in the outdoor RH.

In Module C-3, the relative humidity in the crawl space was measured after opening the door. A hole of about one inch in diameter was drilled in the middle of the floor of Room C-302 and a dual RH/temperature sensor was inserted. The sensor was suspended at about 6" below the subfloor. The hole was sealed with silicon rubber caulking. The flood vents were kept open during the drying period. There was no water in the crawl space after entering on Day 8. The relationship between the crawl space relative humidity and outdoor relative humidity is shown in Figure 6-21. The crawl space RH was 100% during the entire drying period while outdoor RH averaged about 70%. This level of RH in the crawl space may cause structural decay or mold and other associated health problems over the long term.

The temperature in the cavity of the exterior Wall 3, the cavity of the internal wall and Room 301 was monitored continuously. The relationship between temperatures and time for these locations as well as the outdoor temperature obtained from the weather station are shown in Figure 6-22 for the 40 days of testing. (Figure 6-22 shows readings for Module C-3; results were similar for Module S-3). The readings clustered together and follow that of the outside temperature with a difference in the absolute value. The difference in the temperature between the three readings varies by at the most 5°F. These profiles are influenced by other factors such as fluctuation in the daily average outdoor temperature, wall orientation, wind speed, rain etc.

The relationship between the temperatures in the crawl space of Module C-2, together with the outdoor temperatures is shown in Figure 6-23. The crawl space temperature reflects that of the outdoor temperature with a lower magnitude and a slight time lag. The average temperature of the crawl space is about 2 °F lower than the average outdoor temperature. Flood vents were kept open during the entire drying period.

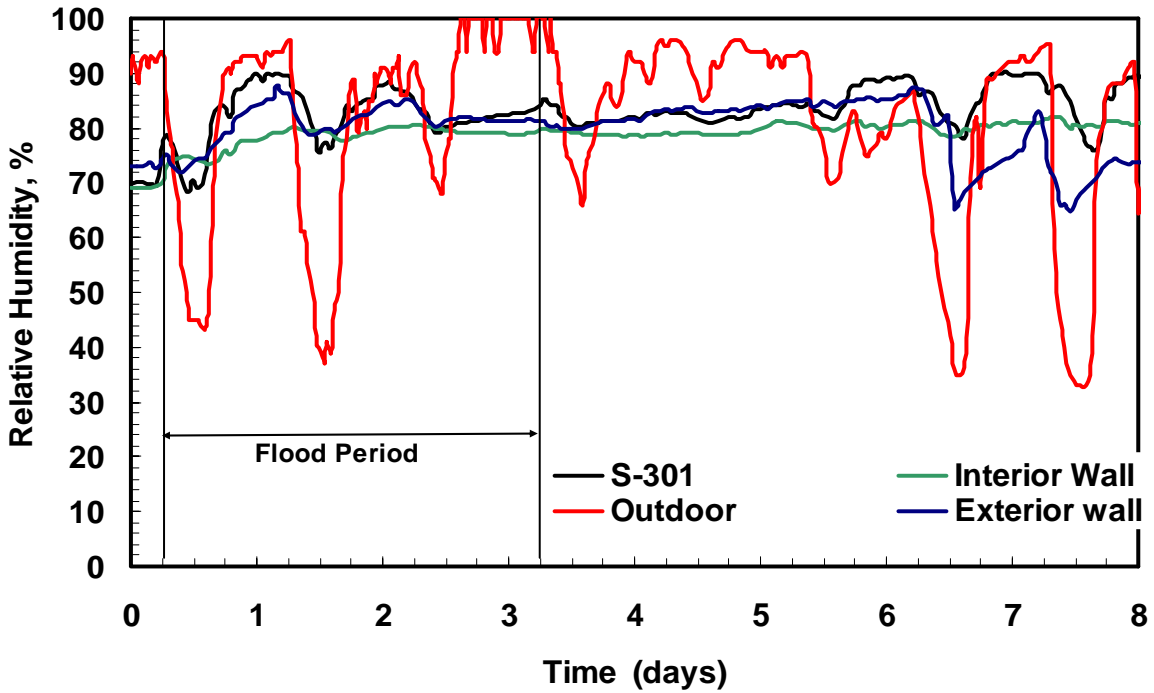

Figure 6-17 Relative humidity versus time at three locations in Module S-3. Between flooding on Day 0 and opening on Day 8. Time zero is 6 hours prior to flooding.

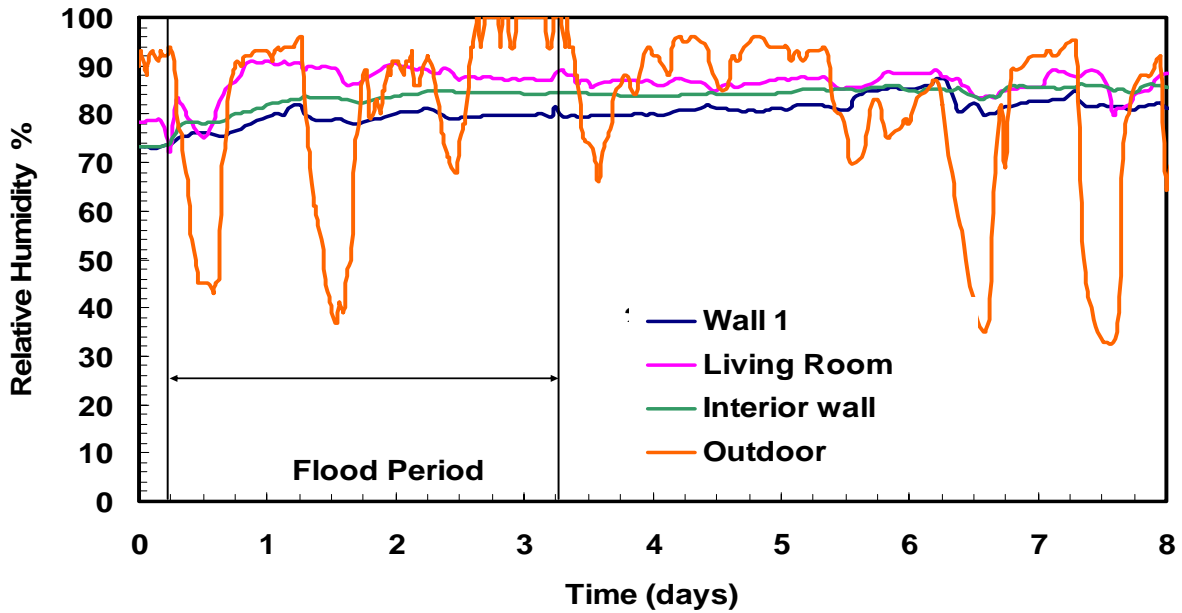

Figure 6-18 Relative humidity versus time at three locations in Module C-3. Between flooding on Day 0 and opening on Day 8. Time zero is 6 hours prior to flooding.

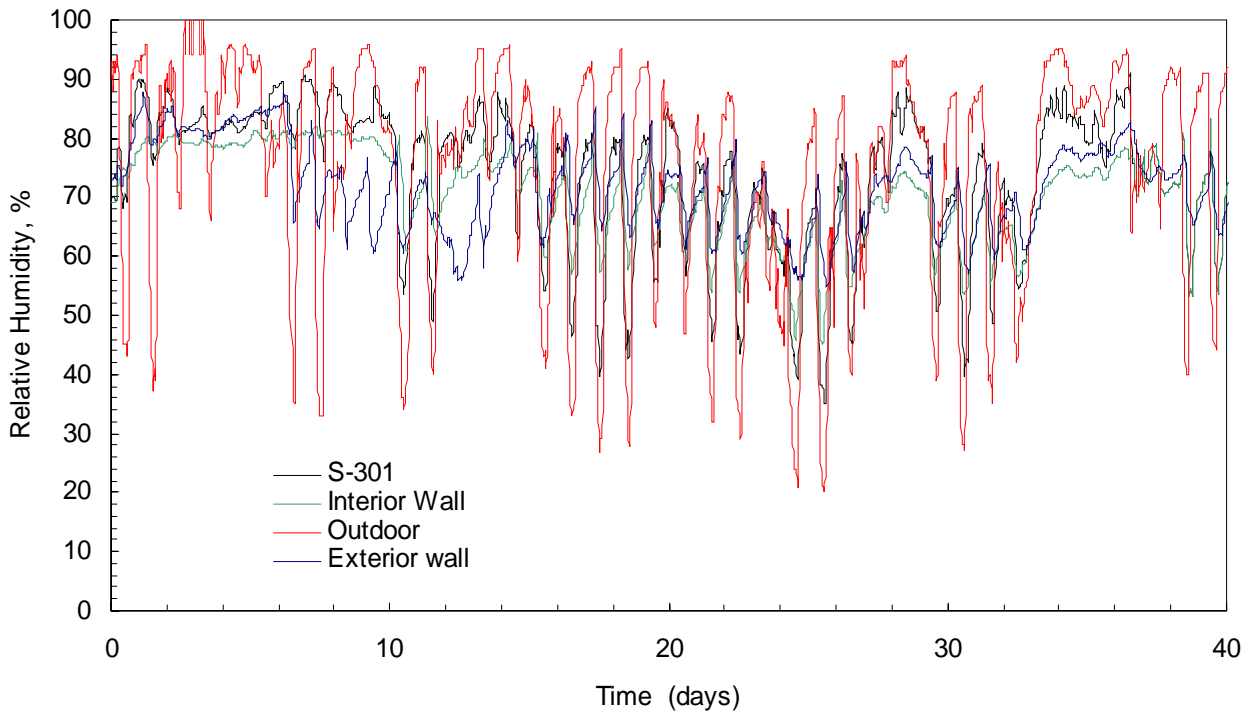

Figure 6-19 Relative humidity versus time at three different locations in Module S-3, entire test period. Time zero is 6 hours prior to flooding.

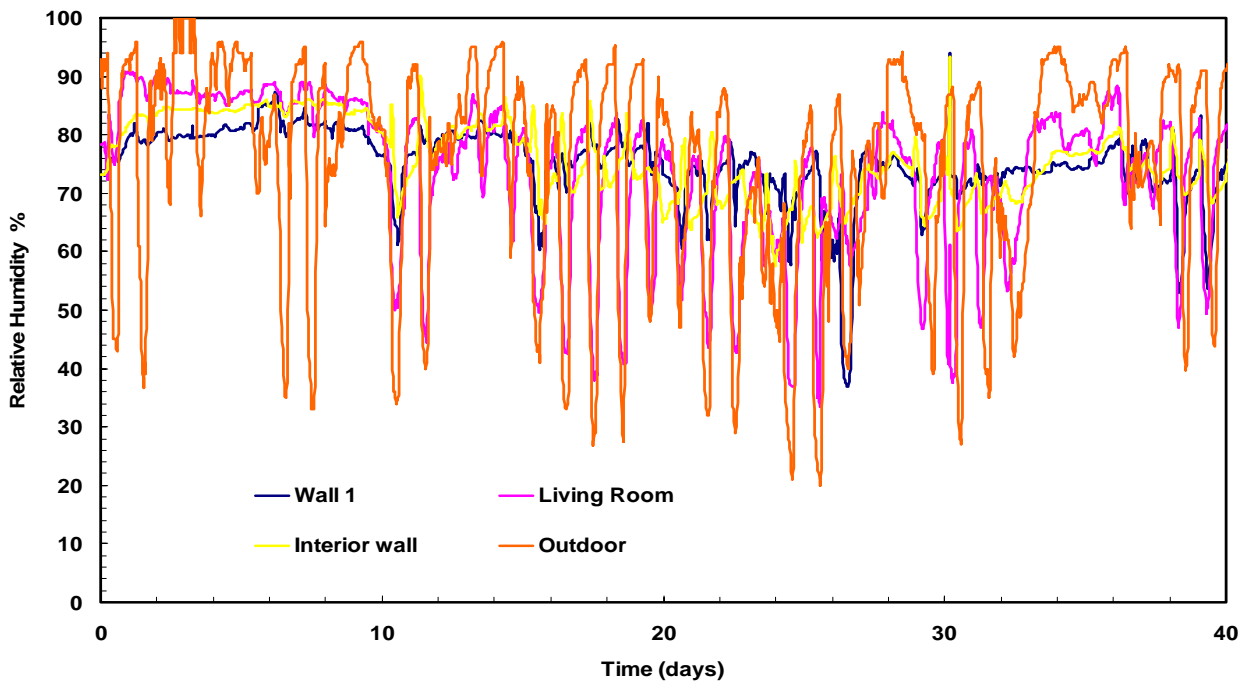

Figure 6-20 Relative humidity versus time at three different locations in Module C-3 for entire test period.

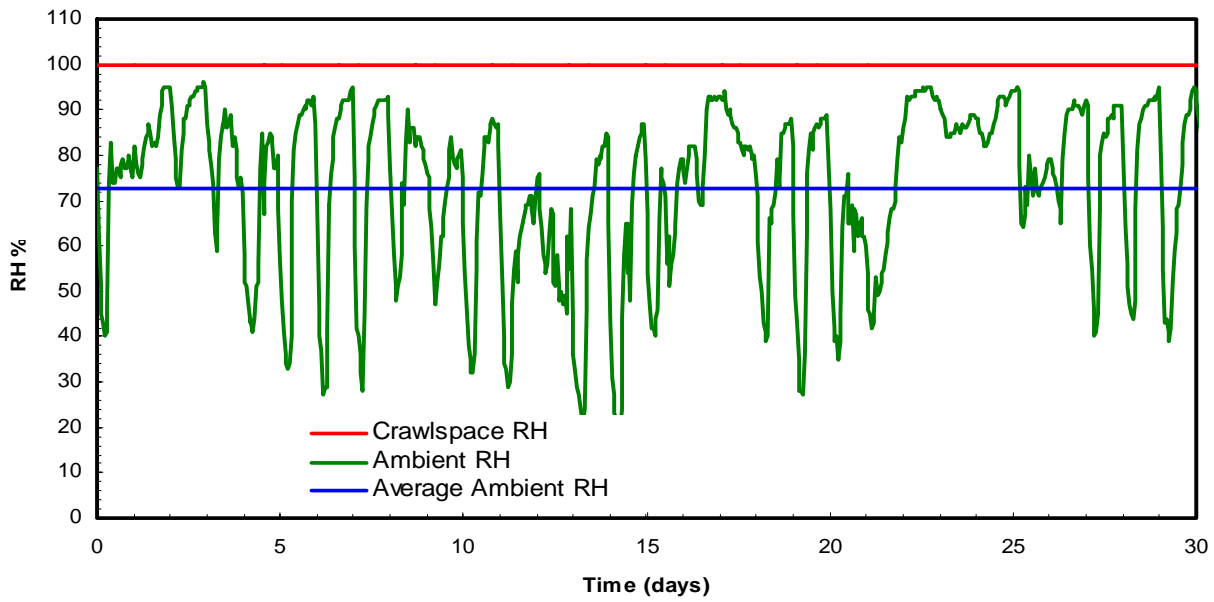

Figure 6-21 Relative humidity versus time in the crawl space, Module C-3

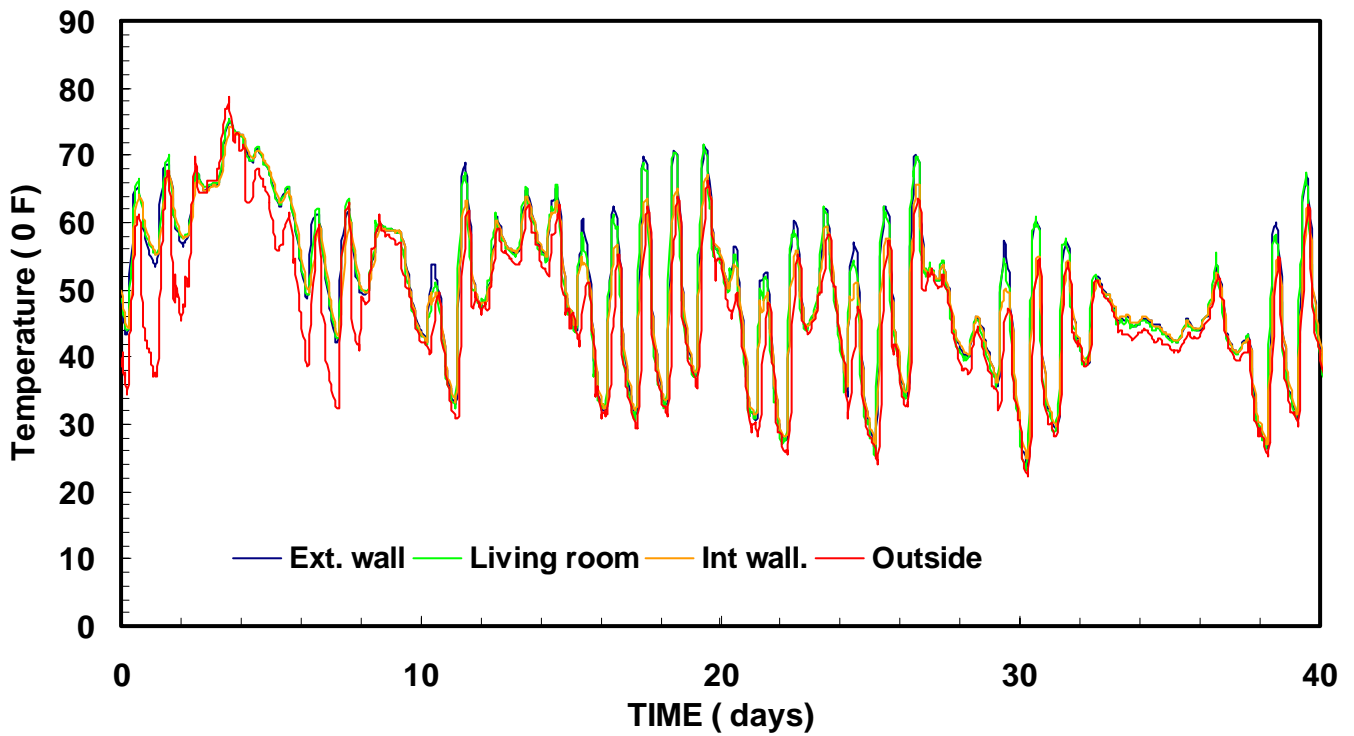

Figure 6-22 Temperature profiles for three different locations in Module C-3 and outdoor air temperature for test period. Time zero is 6 hours prior to flooding.

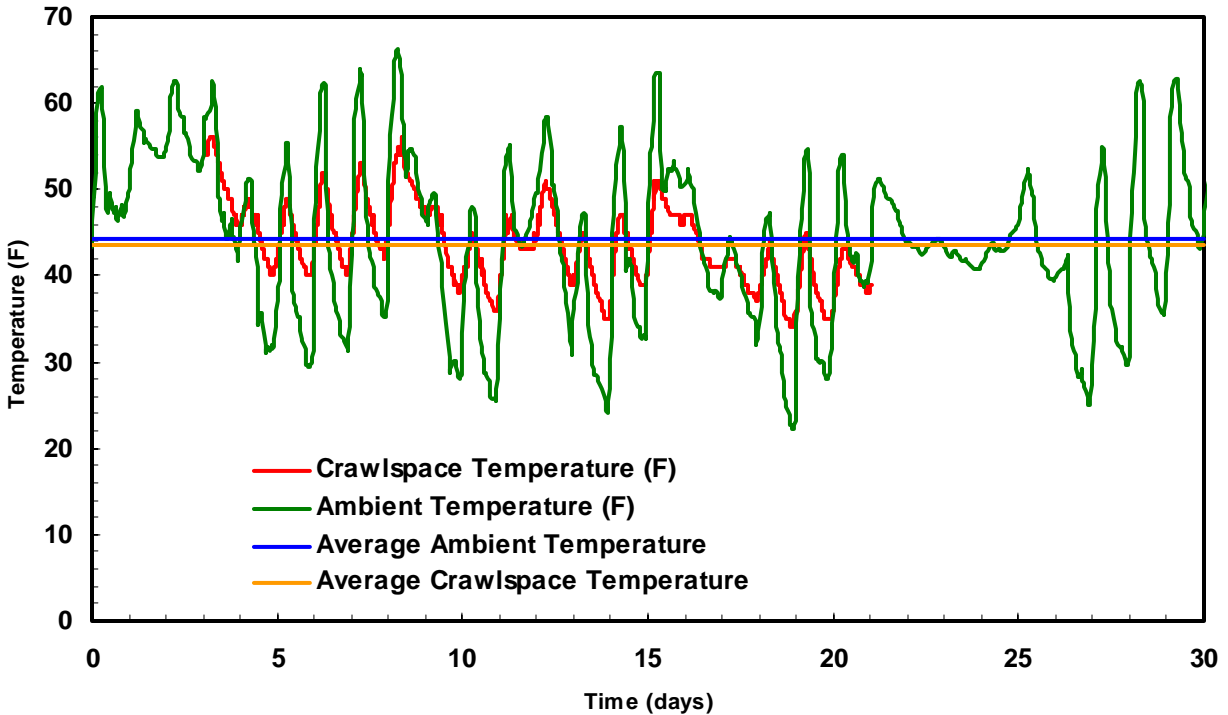

Figure 6-23 Crawl space temperature profile. Time zero is the 8th day after flooding

Materials Moisture Content

Studs

The relationship between the moisture content and time for Module S-3 is given in Figure 6-24 for the entire flooding and drying period. Only the sensors below the water level (located in a stud one foot above floor level) recorded significant changes in the moisture content. The moisture content rose sharply at flooding and reached its maximum value after 72 hours (End of Day 3) from the start of flooding. This was the case for all three walls. The maximum moisture reached after 72 hours was 45% (Wall-1), 41% (interior wall) and 34% (Wall-3). The rate of moisture absorption in the studs below water level during flooding was highest for the stud in Wall 3 in Module S-3 for 25 days from the start of flooding. By Day 25, the sensor in the stud in the Wall-1 (north) registered constant moisture content higher than that in all the other sensors. The moisture in the stud in the middle (interior) wall (2.5 ft. above floor level) rose slightly above that for the same locations in Walls 1 and 3, and reached a plateau of about 15-18% for the remainder of the drying period. Due to the cold weather (November/December) and frequent rain, the moisture in the studs in Wall 1 (north) and Wall 3 (south) did not reach their original moisture level by Day 34. There was about a +7% difference for Wall 1 (north) and +4% for Wall 3 (south).

The relationship between the moisture content and time for Module C-3 is given in Figure 6-25 for the entire flooding and drying period. The sensors below the water level (located in a stud one foot above floor level) recorded significant changes in the moisture content. The sensor at 2.5 ft. above water level recorded similar changes to that at one foot above the water

level. After entering the module the water level rose to very close to the upper sensor in Wall 1. This was done to keep the water level about 6 inches above the window sill, similar to Module S-3 which had the “window dam”. This higher water level explains the higher moisture content recorded by both sensors in Wall 1. The moisture content rose sharply at flooding and reached its maximum value after 72 hours (End of Day 3) from flooding, which was the case for all three walls. The maximum moisture reached after 72 hours was about 80% for all walls at one foot above floor level. The maximum moisture content was about 70% for Wall 3, at 2.5 feet above floor level. The moisture in the stud in Wall 1 was higher during the entire drying period. The moisture in the studs in the middle (interior) wall and Wall 3 (2.5 ft. above floor level) rose slightly above their initial readings and reached a plateau of about 20% for the remainder of the drying period. Due to the cold weather (November/December) and frequent rain, the moisture in the studs in Wall 1 (north) and Wall 3 below the flood level (south) did not reach their original value by Day 34.

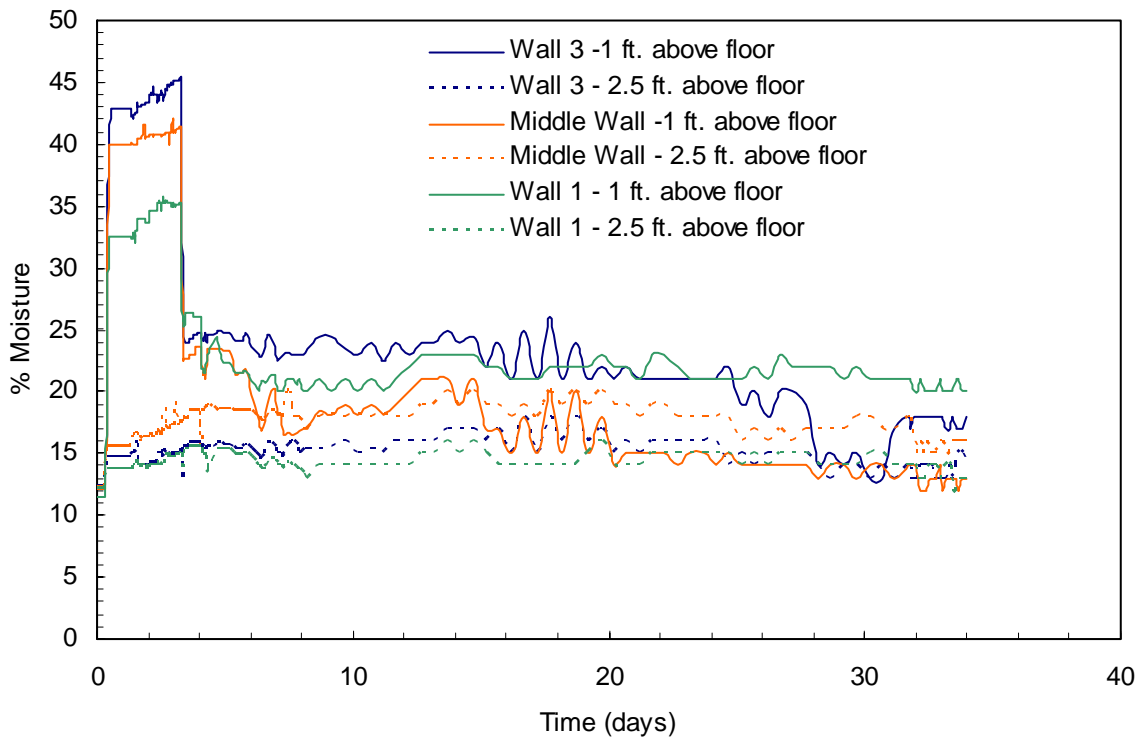

Figure 6-24 The relationship between the moisture content and time for exterior and interior wall studs in Module S-3. During the flooding and drying period

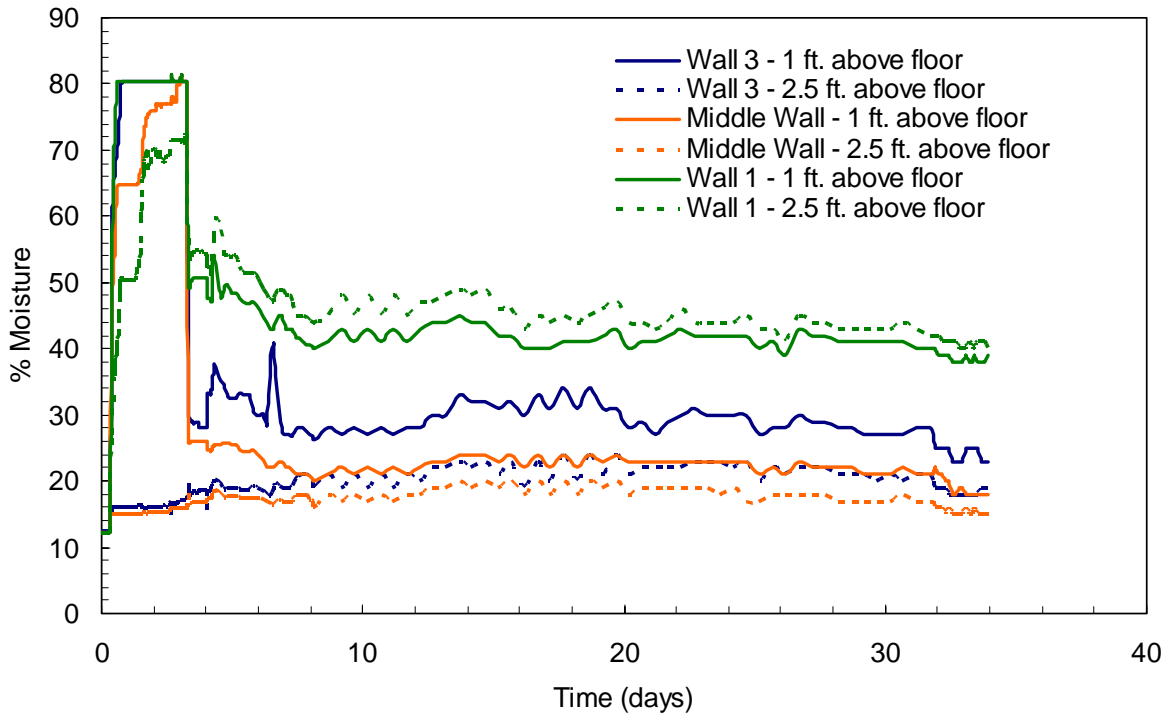

Figure 6-25 The relationship between the moisture content and time for exterior and interior wall studs in Module C-3. During the flooding and drying period

Interior Walls - Gypsum Board (Module S-3)

The moisture content of the gypsum board was measured before flooding and during the drying period. Gypsum board material calibration for the Delmhorst hand held moisture sensor was used. The instrument is standardized on a scale of 0-6 for gypsum board as follows:

- 0-0.5%, board is dry
- 0.5 – 1 %, board has a medium moisture level
- 1 –6.0%, the board is wet

The moisture content for the gypsum board cannot be compared with that of the wood products because of a difference in the instrument calibration.

The moisture content of the gypsum board was measured before flooding and again after reentry and the opening of the door and window in the test module. These measurements were continued throughout the remainder of the drying period. This was done on all walls including the interior wall between Rooms S-301 and S-302 from each side, at the following locations:

- At 6 inches above floor level which is identified as (“below” water line)
- At 4 feet above the floor level which is identified as (“above” water line)

The relationship between the moisture content and time for all walls is shown in Figure 6-26 for the two locations on each wall. The maximum moisture content was just over 6% for all locations below the water line (2 feet from floor). The maximum moisture content at 4 feet above floor level had a range between 2 and 3.5% and reached almost pre-flood conditions at the end of the drying period. It took until approximately Day 32 for the moisture content below the water line at all walls to reach almost pre-flood conditions. The moisture in Wall 1 was about 1.2% or twice the initial value of this wall. Examination of the relationship between the moisture content

and time for all walls below the water line in Module S-3 reveals that Wall 3 (south orientation) has the fastest drying rate. It reached almost the pre-flood conditions by approximately Day 32. Sunlight that shone on this wall appears to have aided drying. Walls 1, 2, 4, and 5 took longer.

Wall 2 (above the water line) had a moisture content of about 3.5% and Wall 5 had 2.5% above the flood line upon reentry on Day 8. All other walls had a moisture content of about 2%. The difference in drying rate between the four walls above the water line appears to be independent of the orientation. This could be attributed to the impact of the spray foam insulation in the exterior walls. Unlike fiberglass insulation, the spray foam insulation did not retain significant moisture.

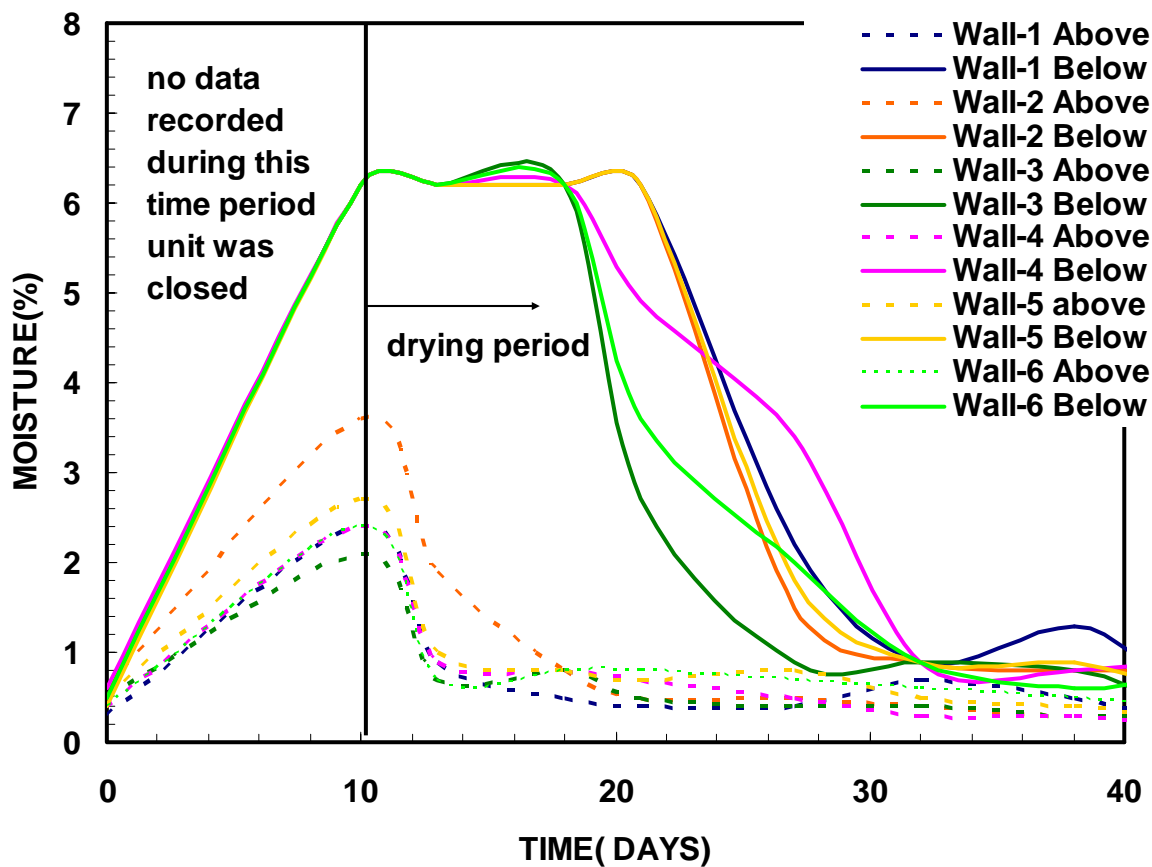

Figure 6-26 Moisture content versus time for the gypsum board interior of all walls in Module S-3. Day zero is the beginning of flooding, Day 3 is the draining of the basin, and Day 10 is the reentry into the module and the beginning of observation and measurements. *All moisture contents should be considered relative to their original readings and not absolute values.*

Interior Walls – Water resistant fiber reinforced gypsum sheathing panels (Module C-3)

The moisture content of the sheathing was measured before flooding and during the drying period. The sheathing material was used instead of the conventional gypsum board. It is a sandwich type construction with a nominal thickness of 0.5". To measure the moisture content in this panel, Calibration –3 Gypsum Board material was used. The instrument is standardized on a scale of 0-6 for gypsum board as follows.

0-0.5%, board is dry

0.5 – 1 %, board has a medium moisture level

1 – 6.0%, the board is wet

The moisture content for these panels cannot be compared with that of the wood products because of a difference in the instrument calibration.

The moisture content was measured on all walls including the interior wall between Rooms C-301 and C-302 from each side, at the following locations:

At 6 inches above floor level which is identified as (below water line)

At 4 feet above the floor level which is identified as (above water line)

The relationship between the moisture content and time for the sheathing on the interior wall is shown in Figure 6-27 for the two levels. The maximum moisture content was about 6%, which occurred below the flood level on all walls. These values are similar to those obtained for Module S-3 for the gypsum board. In Module C-3, it took until approximately Day 20 for the moisture content of Walls 1, 2, and 5 to reach approximately the pre-flood conditions. This was true for all readings below and above the water line. Walls 3, 6, and 5 dried much slower than Walls 2 and 4. It took Wall 3 about 20 days to dry to the pre-flood conditions Walls 4 and 6 reached the pre-flood conditions by approximately Day 40. In addition, the interior wall had a slightly faster drying rate presumably because it did not contain insulation. Wall 1 displayed a higher moisture content of about 3.5% above flood level while Walls 4, 5 and 2 displayed about 2% after reentry. However after 6 more days, the readings reached the pre-flood conditions. Walls 3 and 6 displayed very little change in their moisture content above the flood line, during the entire drying period.

Module C-3 also used two types of wall paint, latex in Room C-302 (with window) and oil base in Room C-301 (with door). The difference in permeability between latex and oil base paint was expected to impact the moisture content and drying rate of the walls. In Figure 6-27 walls 1, 4, and 6 were painted with latex paint, while walls 2, 3 and 5 were painted with oil based paint. On average the oil based painted walls appeared to dry more quickly than the latex painted walls. The latex painted walls dried at rates similar to the previous tests using latex paint except for Wall 4 which took until Day 40 to return to pre-flood moisture levels. The authors have not identified an explanation for this anomaly. Potentially it may have been caused by differing physical characteristics of the particular sheet of sheathing used in the location where the samples were taken.

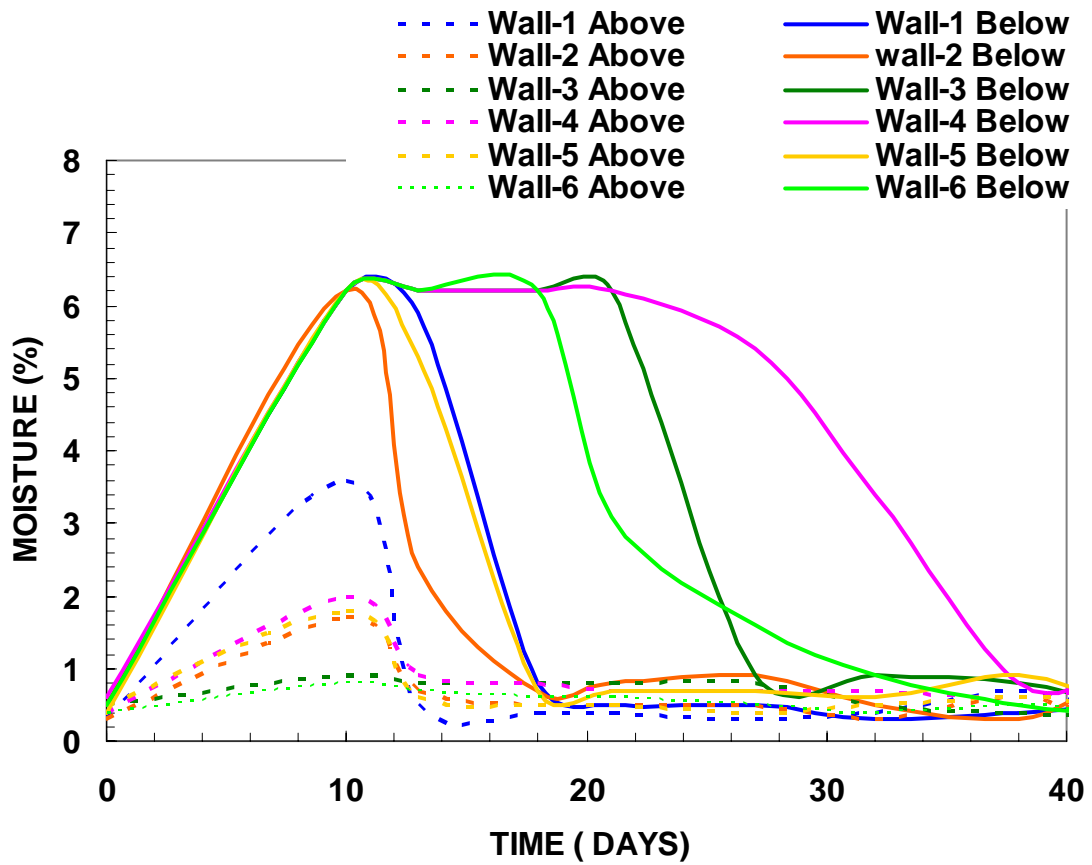

Figure 6-27 Moisture content vs. time, fiber reinforced gypsum panel interior walls in Module C-3. Day zero is the beginning of flooding; Day 3 is the draining of the basin; Day 8 is the reentry into the module and the beginning of observation and measurement. *All moisture contents should be considered relative to their original readings and not absolute values.*

DOCUMENTATION OF TESTING (MODULE S-3a - Second Attempt at Dry Flood Proofing)

Chronology of Testing Module S-3a

Basin Flooding Start:	February 11, 2003
Basin Draining:	February 11, 2003
Module Door and Window Opening:	February 16, 2003*
Wash with water:	February 18, 2003
Sanitizing:	March 18, 2003
Official Drying Period End:	March 18, 2003

* The unit was briefly entered on February 12, 2003 to permit the location, inspection and documentation of leakage pathways. The unit was re-closed until February 16, when it was opened and allowed to dry per the standard post flood testing protocol.

Photographic documentation, as well as relative humidity, moisture, and temperature measurements were made throughout the entire flooding and drying periods. However, this documentation and these measurements were quite similar to those of Module S-3. They do not add substantially to the understanding of flood resistant residential materials and systems and are not, therefore, included in this report.

Observations During Flooding and Draining

To observe the areas in which water might enter the module during flooding, two video cameras were installed. One camera was placed under the ceiling in the middle of Wall 4 to view Room S-301, including the door and the remainder of Wall 3. The camera was focused on the corner between the floor and the walls, but the viewing area included most of the floor and about 4 ft above the floor on the walls. The second camera was placed under the ceiling in the middle of room 2 to view Room S-302. The focus in this room was the window on Wall 1 and Wall 4 from Room S-302. The flooding and draining was recorded using a VCR in the control room. Special attention was given to the areas where the barrier dams were installed on the window and door. In addition, video was recorded from the outside of the unit during flooding and draining.

Caulking and sealing all points below 4 ft from the exterior, joints between the bottom of studs and sill plates, along the studs that meet at corners, joints between finish frame and rough opening between doors and windows, did not prevent but slightly slowed the water entering the unit during flooding, similar to Module S-3. The water level on the outside and inside of the test unit did not come to an equilibrium level immediately. After the water level outside reached about 7 in. above floor level, water was observed to start entering the inside of the test module. In the test units that have not been dry flood proofed, water starts entering immediately after it reaches the level of the floor. Water entered at the corners of the house at the corner of the door between the rough opening and the door jam at floor level on Wall 1 in Room S-301. The window dam was effective in keeping floodwater from entering through the window.

Similar video recording was done during the draining. The time required for draining was much slower than in the first dry flood proofing attempt. Water exited from the under the door frame but not under the threshold. The seal of the dam along the bottom edge of the door was broken and water was rushing out. Water was also observed to drain from the exterior electrical

outlet, once the water level on the outside of the house had receded to floor level. The difference in the water level between the inside and outside of the module was about 18 in. when the outside water had receded to about floor level. The corners of the module where the concrete slab was chipped also provided a place for water to escape. Very little water was seen on the east wall which was smooth, and the tape appeared to be well adhered to the slab and the sheathing. At one spot on the west wall, water was seen exiting through what may have been a nail hole in the sheathing at the edge of the tape.

Photographic Documentation

Figures 6-28 to 6-32 document the efforts to achieve dry flood proofing prior to testing. Figure 6-33 shows Module S-3a during the test. Figures 6-34 to 6-36 cover the post-flood inspection to determine leakage paths. Figures 6-37 to 6-41 cover the autopsy of the test module.



Figure 6-28 Silicon II caulking was installed on the threshold. Prior to reinstalling the polystyrene foam flood dams



Figure 6-29 Module S-3a, south wall with door dam and aluminum/butyl rubber adhesive sealant tape installed. Prior to flooding



Figure 6-30 Module S-3a, west wall with adhesive sealant tape installed. Prior to flooding



Figure 6-31 Module S-3a, north wall with window dam and adhesive sealant tape installed. Prior to flooding



Figure 6-32 Module S-3a, east wall with adhesive sealant tape installed. Prior to flooding



Figure 6-33 Module S-3a, south and west walls being inspected. Before flooding



Figure 6-34 Module S-3a South wall during flooding. Note the inward deflection of the flood dam at the door. This indicates a significant differential in water level (outside to inside) at the time of the photograph.

Post-Flood Inspection



Figure 6-35 Module S-3a Interior southeast corner of Room S-301 after second dry flood proof test. Water entered the module during flooding through the crack between the doubled studs (yellow knife) that form the door rough framing. It also entered through the crack between the corner studs and the sill plate (grey pry bar).



Figure 6-36 Module S-3a Interior south wall after second dry flood proof test. Water entered the module during flooding through the crack between the doubled studs (yellow knife and saw) that form the door rough framing.



Figure 6-37 Module S-3a Interior southwest corner of Room S-301 after second dry flood proof test. Water entered the module during flooding through the crack between the corner studs and the sill plate (yellow saw).

Autopsy of Module C-3



Figure 6-38 Module C-3, Wall 1, Exterior. No mold or severe staining was observed at autopsy which occurred 15 months after the flood test. The flood level was about 6” above the windowsill in this photograph.



Figure 6-39 Module C-3, Wall 2, Exterior. No mold or severe staining was observed at autopsy which occurred 15 months after the flood test.



Figure 6-40 Module C-3, Wall 3, Interior. No mold or severe staining was observed at autopsy which occurred 15 months after the flood test.



Figure 6-41 Module C-3, Wall 4, Interior. No mold or severe staining was observed at autopsy. The grey debris in the lower portion of the photo is the remains of the interior wall board.



Figure 6-42 Module C-3, Wall 5, Interior. No mold or severe staining was observed at autopsy which occurred 15 months after the flood test.

Discussion and Conclusions

Flood damage resistance includes both physical and human health factors. The experimental modules were tested for resistance to physical degradation that results from the wetting and drying cycle associated with flooding. Testing did not address the structural impact on the envelope of externally applied hydrostatic pressures. Flood depth was limited to two feet above floor level, which applies a pressure that is within the strength capabilities of typical wood frame construction. Post flooding mold growth was documented and selected specimens analyzed. Bacteriological and toxic materials testing were not performed during this series of tests.

Within the limits described above the testing of potentially flood damage resistant building envelope systems and attempted dry flood proofing in two modules under simulated flood conditions revealed the following.

Module S-3

1. Dry flood proofing was not achieved in Module S-3. Video cameras in the module revealed that water entered in similar amounts from all walls during flooding. There was no visible evidence that water had gotten through the door and window dams. However their performance cannot be confirmed because there was water on the inside from other sources that could have disguised a leak at the dams. During the flooding process, the outside water level was about 4 in. higher than the inside water level. The inside of Module S-3 flooded more slowly than either Module C-3 or the previous modules. One place where the module was particularly vulnerable to the entry and exit of water was at the joint between the interior partition and the exterior walls at floor level. When the module was drained, water exited at the corners of the module, between the door and the threshold, and at one bottom corner of the door dam which had been pushed outward by the differential pressure of retained water. During most of the draining period, the water level in the unit was about 6 in. higher than the water level outside the unit. Despite thorough efforts to seal potential water penetration points and dam windows and doors, flood water found a path in to the interior of the unit. Subsequent inspection of the interior of the module showed that the caulk between the sill plate and slab had failed in several locations. These locations corresponded to the points where water was first noticed on the video cameras. One further attempt was made to dry flood proof (See Module S-3a.). The second attempt focused attention on sealing the external joint between the sill and the slab and any other questionable areas on the exterior. Module S-3 was reused once it had completely dried from this test.
2. Even though dry flood proofing was not achieved, the window dam was intact and the door dam appeared to have worked during the flooding process. Flood water was not observed entering or exiting the module through the area around the window. The door dam held intact during flooding, but during draining, one corner of the door dam was pushed outward. Water drained from the bottom right corner of the door dam (See Figure 6-3.). The door and window dams appeared to work as intended during flooding and they were used again in the supplemental Module S-3a.

3. The conventional paper-faced gypsum board wicked moisture to a line approximately 20 in. above the flood level during the three days that the module was flooded. The gypsum board strongly supported mold growth, especially in a band extending 20 in. above the flood level. After sanitization removed visible mold, no mold was found inside Module S-3 throughout the remainder of the testing period. (The sanitization protocol is in Appendix C.) The sanitization process described in the protocol appears to remove visible mold growth from interior surfaces and appears to eliminate it for the long term as well. However, the long-term elimination of mold has not been verified.
4. Water based latex paint applied on gypsum board flaked and blistered. It is likely that in order for latex painted walls to be restored, the paint must be sanded, primed, and repainted.
5. Exterior vinyl siding was unaffected by flooding except for some minor dirt accumulation. After washing, it was completely restored to pre-flood condition.
6. The exterior fiberglass door was stained, however once it was washed, the exterior door was in pre-flood condition.

Module C-3

1. The water resistant fiber reinforced gypsum sheathing used on interior walls did not support visible mold growth. The sheathing is not intended to be used on interior walls, but was installed to represent a similar water resistant product that USG was developing for interior wall use with the trade name Acquatough. When the sheathing is finished and painted, it looks very similar to conventional gypsum board. It appears that this material is a good option for interior walls that are likely to be flooded again, particularly where there is concern about long-term mold growth.
2. Water based flat latex paint applied on sheathing used as the interior wall surface severely wrinkled and blistered. The sheathing itself was undamaged but the flat latex paint would have to be sanded, primed, and repainted in order to restore the wall to pre-flood condition. On the other hand, oil based flat enamel paint applied on the sheathing showed very little damage after 3 days of flooding. Oil based flat enamel, while initially more expensive than water based flat latex, required much less restoration effort to bring the walls back to a pre-flood condition. Oil based paints appear to perform better than water based paints when subjected to flooding. However, the impact of oil based enamel on the drying of adjacent materials and systems was not completely investigated in this testing.
3. The exterior metal door was stained during flooding, but once it was washed, it was completely restored to pre-flood condition.
4. The interior door hardboard simulated panel door was deemed not economically restorable. The faces had become delaminated from the edge frame and there was some staining of the face panels. While reglueing and repainting the door was possible the

labor costs to do so would likely exceed the labor and material costs of simply replacing it.

5. The crawl space relative humidity reached 100% during the drying period. Even when there was no visible water in the crawl space, and the vents were kept open, crawl space relative humidity remained at this level. Crawl space relative humidity was not measured in test C-2, nor was subfloor and joist moisture content measured in test C-3. However, there appears to be a correlation between the crawl space high relative humidity levels and the comparatively slower drying rate of the subfloor and joists. Crawl space relative humidity levels above ambient levels for extended periods could contribute to wood deterioration and/or mold growth. Additional study is needed to evaluate the post flood crawl space humidity levels and methods to foster the drying of subflooring and joist in a timely manner. Further, in order to keep from providing a path for potential mold to enter the interior of the house, the crawl space area must be effectively sealed and isolated from the interior of the house.
6. Both the cement board siding and the vinyl siding were unaffected by flooding. After washing, they were both restored to pre-flood condition.

Module S-3a (second attempt to dry flood proof)

1. Sealing the outside edges of the module slowed the entry of water. There was about a 7 in. difference in the equilibrium level inside and outside of the unit at the time the maximum flood level was reached on the outside of the unit.
2. Water entered the unit from the corners and underneath the door frame in spite of the efforts to seal these areas. Places where the concrete foundation was chipped appeared to be the problem areas based on observations at draining of water exiting from these locations.
3. Despite extraordinary efforts to dry flood proof it, the slab-on-grade module still flooded. We believe that the efforts we took to seal the outside of the Module S-3a were more thorough and detailed than homeowners and possibly contractors would make. If, after very careful efforts, we did not achieve dry flood proofing, we believe that other efforts would not succeed in dry flood proofing either.
4. We believe that dry flood proofing is not economical or practical to achieve with wood frame construction. We further believe that homeowners should not be given guidance that recommends dry flood proofing. Dry flood proofing is simply too difficult to achieve to be practical for residential applications.

7. SUMMARY OF CONCLUSIONS

The Department of Homeland Security, Emergency Preparedness and Response Directorate (formerly part of the Federal Emergency Management Agency - FEMA) defines flood damage resistance as the ability of materials, components, and systems to withstand direct and prolonged contact with flood water without sustaining any degradation that requires more than cosmetic repair to restore it to its original condition. Furthermore, materials that are considered flood damage resistant must not degrade adjacent materials or systems. Cosmetic repair includes cleaning, sanitizing, sanding, repair of joints and repainting. The cost of cosmetic repair must be less than the cost of replacement of affected materials and systems. This standard was adopted for these experiments and forms the basis of the conclusions below.

Flood damage resistance includes both physical and human health factors. The experimental modules were tested only for resistance to physical degradation that results from the wetting and drying cycle associated with flooding. Resistance to flood borne pollutants that could affect human health were not evaluated in these tests but will be investigated in subsequent testing in this project. Testing for the residual health effects of flooding on otherwise flood damage resistant materials and systems has not yet been accomplished and could potentially change the outcomes.

Finally, these conclusions are based on the results of the testing accomplished in this project and *do not* represent an “official” statement as to the flood damage resistance of a particular material or system. A certifying test procedure must be developed and adopted by consensus before the identification of materials as “flood damage resistant” will satisfy the requirement for the use of such material by the building code.

MATERIALS AND SYSTEMS

Siding

When exposed to floods, newly installed and painted plywood and hardboard lap siding maintained reasonable dimensional stability and mechanical properties (Modules S-1, C-1). They also possessed good washability but remained discolored. However, older, weathered siding of the same materials and/or repeated wetting and drying over several cycles is projected to significantly degrade the restorability of these siding materials. Vinyl and fiber cement sidings both withstood flood conditions better than hardboard lap siding and plywood siding. Both vinyl and fiber cement siding could be restored to preflood conditions through washing the portion below flood level (Modules S-2, C-2, S-3, C-3). The corner boards, which were made from nominal 1 inch sawn lumber cracked and warped. Vinyl corner trim showed no evidence of deterioration from flooding.

Sheathing

Water resistant, fiber reinforced gypsum sheathing maintained its integrity and mechanical properties. It dried to preflood levels during the drying period (Modules S-2, C-2, S-3, C-3). Plywood sheathing maintained its integrity and mechanical properties. However, it had not dried to preflood levels after 30 days. Because water does not tend to escape quickly from behind plywood siding, the combination of plywood siding and sheathing was not considered a good flood damage resistant system. Lap siding tends to let moisture escape more quickly. If a

flood damage resistant lap siding is employed, the use of plywood as sheathing is likely to make an acceptable damage resistant system (Modules S-1, C-1).

Wood Framing

Moisture levels in wood studs returned to pre-flood levels within the drying period. The wood studs also maintained their strength (all Modules). Wood studs were considered flood damage resistant.

Insulation

Fiberglass batt insulation appeared to retain moisture in the exterior wall cavities and below the floor (Modules S-1, C-1). The moisture on the fiberglass fibers appeared to keep adjacent walls and floor materials wetter longer and could potentially contribute to long-term damage to the subflooring, floor and wall framing, and the gypsum board walls. When spray polyurethane foam (SPUF) insulation was used in the wall cavities, the wall board and wood studs dried in exterior walls at the same rate as in the interior walls with empty cavities (Modules S-2, C-2, S-3, and C-3). SPUF absorbs water very slowly and was undamaged by flooding. SPUF did not retain moisture and as such had a positive impact on the flood damage resistance of the materials around it.

Interior Wall Board

When gypsum board was used with fiberglass batt insulation, the gypsum board lost about 50% of its flexural strength and remained wetter than interior walls (without insulation). Interior gypsum board walls dried out and maintained flexural strength (Modules 2 and 3). If gypsum board is able to dry completely within an appropriate time it can be restored to pre-flood condition with cosmetic restoration. Fiber reinforced gypsum interior wall board retained its initial strength and dried out during the drying period (Modules 2 and 3). Although it supported mold growth, it was able to be cleaned, sanitized, and restored. Water resistant, fiber reinforced gypsum exterior sheathing was applied to interior walls (Modules 2 and 3). It, too, maintained its initial strength and it dried out during the drying period. It did not support mold growth and its surface was easily cleaned and restored.

Wall Finishes

Ceramic tile performed well under flood conditions and showed no long-term deterioration. Both latex flat white paint and latex semi-gloss enamel paint peeled, blistered and stained in Modules S-1 and C-1. Mold grew on both types of paint in Module S-1 but did not grow on the paint surface in C-1. High and low permeability paints were tested in Modules S-2 and C-2. Both types of paints had to be sanded and new coats of paint applied in order for the walls to be restored subsequent to flooding. Water based flat latex and oil based enamel paints were tested in Modules S-3 and C-3. The water based latex flaked and blistered. Oil based flat enamel performed better than any other paint that was tested. It flaked and blistered very little and was much easier to restore than other paints. Of all the paints tested, oil based flat enamel paint was found to be the most flood damage resistant. However, the impact of oil based enamel on the drying of adjacent materials and systems was not completely investigated in this testing.

Vinyl wall covering blistered, peeled, and debonded after flooding. It damaged the surface of the gypsum board and it may inhibit drying of the substrate or wall system.

Exterior Doors

Exterior wood paneled, wood frame and exterior prehung metal clad, wood frame doors were stained slightly, but appeared to be able to be washed and restored. (No washing or restoration was done in Module 1). Foam-filled fiberglass and foam-filled metal were restored to preflood conditions with minimal effort in Modules S-2 and C-2. The fiberglass and metal doors used in the second modules were re-used in the third modules and were once again easily restored. All four door types were considered flood damage resistant.

Interior Doors

All interior doors that were tested in all three modules were severely stained and some were warped, split, and peeling. Considering the relatively low cost of replacement, none were economically feasible to restore.

Windows

All vinyl and aluminum window frames were able to be restored to preflood conditions with minimal effort (Modules S-2, C-2).

Floor Structure

The sealed concrete floor slab in all slab-on-grade modules remained undamaged during and after flooding. The wood sub-flooring in Module C-1 retained very high moisture content throughout the drying period due to the unfaced fiberglass batt insulation underneath the sub-flooring. In Modules C-2 and C-3, no floor insulation was used and the subflooring returned to preflood moisture levels during the drying period. Wood subflooring and framing insulated with fiberglass batts could experience long term moisture related problems.

Floor Finishes

Ceramic tile and quarry tile performed very well under flooding conditions and required only cleaning to be restored. All carpeting and padding in all modules (1-3) became dirty and smelly after flooding. It also retains large amounts of moisture which can slow the overall drying rate throughout the house. Even if the carpet is able to withstand the flood, it should be removed for cleaning and drying and to promote drying within the home. Carpeting and padding should always be removed subsequent to flooding. Simulated wood flooring warped and has open joints when left in place on the floor after the flood (Modules S-2, C-2). When removed, washed, and stacked to dry after flooding, the simulated wood floor had much less warping and shrinkage, but the process of removal damaged some of the pieces.

Foundation Vents

The operable flood vents were closed prior to flooding and opened by themselves during

the filling and draining of the flood water (Module C-3). They operated as designed. These vents were blocked open throughout the drying period. The crawl space humidity reached 100% and remained high during the drying period. This humidity level is unacceptable in the long term since it could contribute to both mold and wood decay. It is believed that the high humidity level in the crawl space was the result of the test module being placed in a basin that was subjected to significant amount of rain throughout the drying period. In order to keep from providing a path for mold to enter the interior of the module, the crawl space area must be effectively sealed from the interior of the house.

PROCEDURES

Punching Holes in Walls

Punching holes above the floor molding of the interior walls does not drain any water nor does it dry the wall any faster, especially if flood water has receded for several hours. In some instances if holes are not punched in the walls, the gypsum board can be easily repaired and restored. Punching holes in gypsum board walls is not an appropriate flood recovery procedure.

Cleaning

The cleaning protocols that were followed in Modules 2 and 3 did remove dirt and staining, but not mold. After sanitizing walls and floors, mold was removed and these surfaces restorable. Cleaning alone does not appear to be an appropriate flood recovery procedure.

Sanitizing

Severe mold growth occurred in Module S-1, but in the first module, no attempt was made to clean or sanitize surfaces. In Modules S-2, C-2, and C-3, efforts were made to sanitize and remove mold. Several types of wall board were applied in the second modules. The type of wall board appeared to have more influence on the amount of mold growth than the type of paint or whether the module was the slab-on-grade or the crawlspace module. The water resistant, fiber reinforced gypsum sheathing did not support mold growth. The gypsum wall board supported some mold growth, and the fiber reinforced gypsum interior wall board supported mold growth. However, after sanitization, there was no visible mold for the remainder of the testing period. (Although no mold appeared to return throughout the test period, long term elimination of mold has not been verified.) Sanitizing appeared to work and it is therefore a recommended procedure in the restoration of flood-damaged homes.

Restoring

Restoration efforts ranged from washing of materials (e.g. vinyl siding, ceramic tile floors and sealed concrete slab) to washing and sanitizing (e.g. some interior wall panel and trim) to washing, sanitizing, resurfacing and repainting (e.g. other interior wall panels). Most flooring

materials and interior doors tested required replacement, either because they could not physically be restored or they were not cost-effective to restore.

Dry Flood Proofing

Dry flood proofing was not achieved in Modules S-3 or S-3a. While the door and window dams that were used were effective in preventing the entry of water through doors and windows, water entered the units through other paths, such as the joint between the interior partition and the exterior walls at floor level. Although the joint between the sill plate and the concrete slab had been caulked, water entered there as well. In addition to the steps taken in Module S-3, in Module S-3a, the external joint between the sill and the slab and other questionable areas on the exterior were sealed. Despite all these efforts, flood water entered the modules. We believe that the efforts we took to seal the Module were more thorough and detailed than homeowners and possibly contractors would make. If, after very careful efforts, we did not achieve dry flood proofing, we believe that other efforts would not succeed in dry flood proofing either. Dry flood proofing is not considered a viable approach to flood damage resistance.

8. FOLLOW-ON WORK

The objective of the field-testing has been to scientifically investigate and document the performance of various currently available residential building materials as parts of complete envelope systems when they are subjected to representative flood conditions. However, a goal of the overall project is to develop a pre-standard for use in defining a formal testing procedure that would lead to the certification of materials as “flood damage resistant.” This certification would be used by code officials in determining which materials will meet the code requirement for the use of flood damage resistance in flood-prone areas. In order to develop a pre-standard, the following three tasks are planned.

DEVELOPMENT OF REPRESENTATIVE FLOOD WATER

The purpose of this task is to develop representative flood water that can be reproduced for standardized testing of materials and systems to determine their flood damage resistance performance. The task is intended to develop “representative”, not typical, flood water. There are too many variables in floods and flood water that may impact building systems and materials to able to define “typical” flood water. “Representative” means yielding test results that are comparable to the results from actual flooding on the flood damage resistance performance of materials and systems.

It is important to consider flood water characteristics when measuring flood damage or developing flood damage resistive residential materials and systems because contents of flood water can influence water absorption characteristics of building materials; contents of flood water can influence drying time of materials; contaminants may transport biological or embryonic forms into a building’s structure, which can become a health hazard unless sterilized; and flood water characteristics can influence the amount of work required to remove physical deposits and make repairs. Defining representative flood water will help to develop reproducible laboratory testing protocols that can be used to evaluate more accurately the flood damage resistance of building materials and systems.

DEVELOPMENT AND EVALUATION OF LABORATORY TESTING PROTOCOLS AND COMPARISON TO FIELD TEST RESULTS

One full-scale test module (Module C-4) will be built and tested in the field test facility per existing test protocols. This test will be used both to evaluate additional materials and systems and to as a point of comparison for the results of representative system laboratory tests. A number of full-scale test samples will be fabricated to match portions of the field test module. These will then be subjected to indoor testing in a basin of floodwater with the surrounding environment under temperature and relative humidity control. Additional laboratory test samples will be subjected to contaminants such as fuel oil, staining agent, or other materials deemed to provide a more challenging test of the systems’ ability to withstand flood damage. Various testing protocols will be evaluated in an attempt to closely replicate the results from the field-testing. In addition, the costs associated with these lab test protocols will be evaluated against the level of accuracy achieved by each protocol. The results of field-testing versus lab testing will be used in recommending test protocols to be used in the development of standards for the certification of materials as flood damage resistant.

DOCUMENTATION OF FINDINGS FOR USE IN STANDARDS DEVELOPMENT

In this task the findings of the final field test (Module C-4) and the laboratory tests will be documented and a report will be written. Recommendations will be made toward defining representative flood water and the methodology to be used in laboratory testing of building materials and systems for flood damage resistance certification.

APPENDIX A

**PROTOCOL 1
FIELD TESTING FLOOD-DAMAGE-RESISTIVE
RESIDENTIAL ENVELOPE SYSTEMS**

PROTOCOL 1
FIELD TESTING FLOOD-DAMAGE-RESISTIVE
RESIDENTIAL ENVELOPE SYSTEMS

November 16, 2001

Authors:

Heshmat Aglan, College of Engineering, Architecture and Physical Sciences,
Tuskegee University, Tuskegee, AL 36088, Tel: 334-727-8857 Email: aglanh@tusk.edu
Robert Wendt, Oak Ridge National Laboratory,
PO Box 2008 MS6070, Oak Ridge, TN 37831 Tel: 865-574-0260 Email: wendtrl@ornl.gov

1. Scope

- 1.1** This protocol provides the steps that should be followed in testing residential envelope systems to determine the extent of their flood damage resistance, under static (no horizontal water movement) flood conditions.
- 1.2** The test method described in this protocol will be used to determine the performance of residential envelope systems subjected to static flooding. A large-scale outdoor basin is used to simulate conditions which are representative of those typically found in floods. The performance determined by this method relates to the ability of elements or materials of building envelope to remain functional during a flood. This includes, but is not limited to, items such as interior and exterior walls, floor, windows, doors, insulating materials, siding, etc.
- 1.3** This protocol outlines a systematic approach to testing the flood resistance of residential envelope systems, including the identification of needed information, the performance of tests, the interpretation of data, and the reporting of results.
- 1.4** This protocol is intended to give a procedure for determining the flood damage resistance of residential envelope systems through field testing under simulated flood and drying conditions.
- 1.5** This protocol is a “living document” and as such is expected to change based on input from actual field testing and from other sources.

2. Significance

Floods and flooding are catastrophic environmental events that are often unpredictable. Since 1990, property damage in the United States related to flooding has been estimated to exceed \$30 billion and has left millions homeless. One of the single largest contributors to this total cost is the loss and replacement of residential housing. Many factors affect the actual damage to a building envelope during a flood, including water movement, duration and depth of the flood, pollutants in the water, building shape, terrain, surrounding structures, and other factors. The resistance of residential envelopes to flood damage is impacted by the building design, materials and systems installed, and the magnitude and duration of the flood event.

3. Descriptions of Terms in this Protocol

- 3.1** *Field Testing* - testing under natural climatic conditions of field test location

- 3.2 *Residential Envelope* – includes items such as, but not limited to, the exterior and interior walls, floor assemblies, and windows and doors to be tested.
- 3.3 *Resistance to flood damage* – the ability of a material/component/system to withstand direct and prolonged contact with flood water without sustaining any degradation that requires more than cosmetic repair to restore to original condition.
- 3.4 *Flood test* – a test in which building envelopes and components are exposed to simulated flood conditions to determine the level of potential degradation.
- 3.5 *Structural factor* – degradation that results from externally applied hydrostatic pressure. This excludes applied forces associated with water movement (i.e. currents).
- 3.6 *Biological factor* – degradation associated with biological invasion (i.e. uncontrolled mold and mildew growth).
- 3.8 *Degradation mechanism* – the sequence of physical or chemical changes, or both, that leads to detrimental changes in one or more properties of a building envelope or component when exposed to flood.
- 3.9 *Duration of exposure* – the length of time simulated flood water is in contact with the envelope systems being tested.
- 3.10 *Water Depth* – the uniform static water depth to which the building envelope or component would be subjected during testing.
- 3.11 *Critical performance characteristic* – any of the group of properties of a building envelope or component that must be maintained above a certain minimum level if the envelope or component is not to lose its ability to perform its intended functions.

4. Summary of Test Method

This test method consists of containing the test envelope structure in a large-scale outdoor basin, flooding the basin to a specified depth as measured on the envelope exterior according to a specific testing program, and observing, measuring, and recording the performance changes, and the nature of any distress or failure of the envelope assembly during and after the test. Schematics of the outdoor test basin for slab on grade and crawl space are shown in Figures 1-A and 1-B respectively.

5. Procedures

- 5.1 The procedures for testing flood-damage-resistive residential envelope systems are outlined in Figure 1-A.
- 5.2 The protocol will provide guidance in establishing the following:
 - < Determination of physical and/or performance characteristics of each evaluation element ;
 - < Determination of the minimum number of test runs;
 - < Methods for testing the subject before exposure to simulated flood water for the purpose of establishing baseline properties with respect to those characteristics that would be impacted by exposure to flood waters;
 - < Methods for testing the subject after exposure to simulated flood water for the purpose of establishing the changes from the properties of the control; and
 - < Methods for exposure of the subject to simulated flood-water.

I. PROBLEM DEFINITION

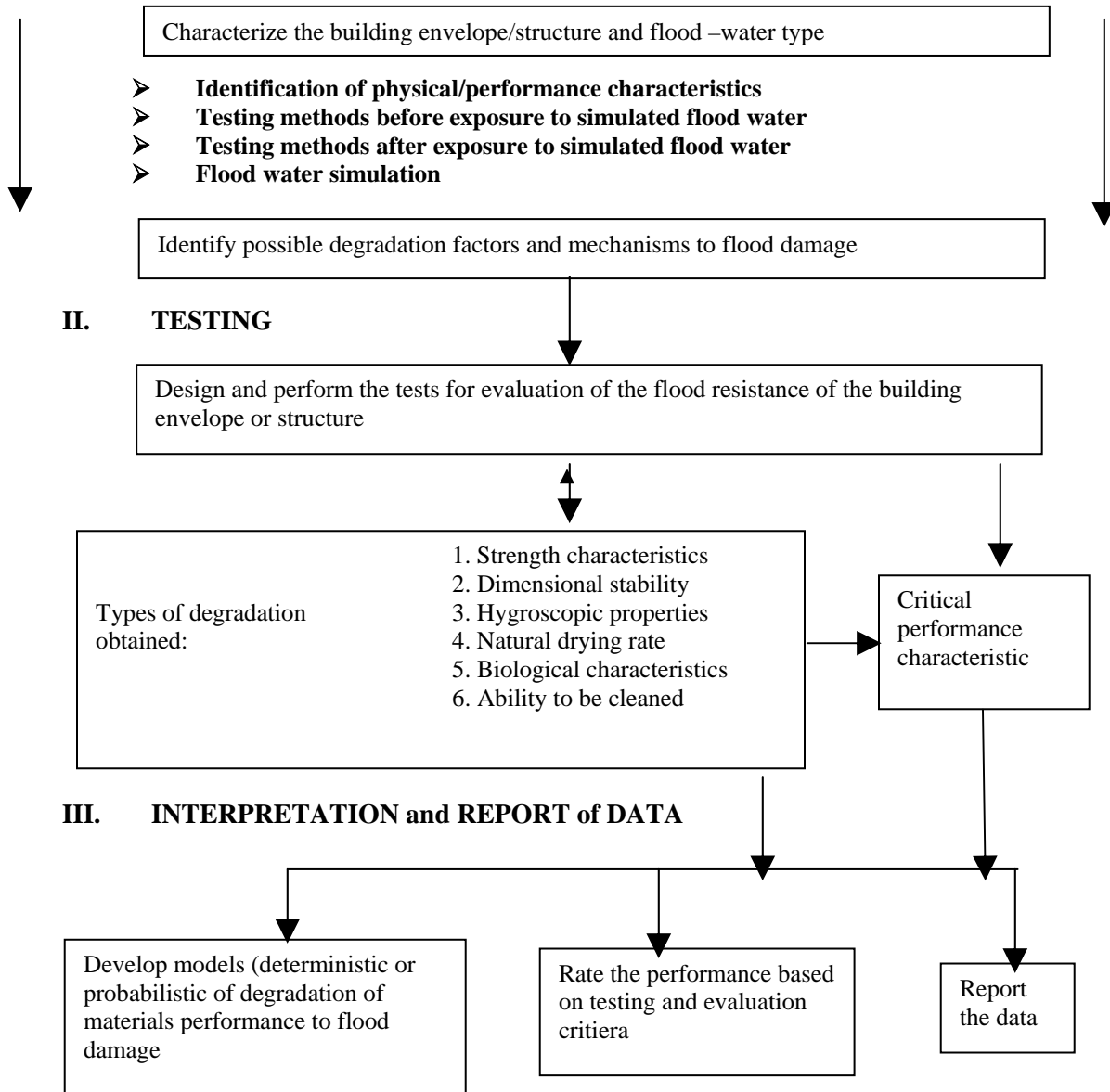

Figure 1-A. Procedures for flood-resistance tests of residential envelope systems

5.3 Simulated Flood-water Types

Determination of whether the subject's performance characteristics are affected differently when exposed to flood waters of riverine versus coastal flooding (e.g. fresh vs. salt water) must be considered. The specific characteristics of the water to be used (pH, electrical conductivity, organic materials, chemicals from fertilizer run-off etc.) should be defined so that testing at all locations will yield consistent results. The temperature of water should be monitored continuously and recorded at 15-20 minute intervals during the flood exposure period. This is a field test under natural ambient conditions and parameters such as temperature, wind speed, relative humidity, solar gain etc. should also be monitored continuously and recorded at 15-20 minute intervals during the flood exposure and drying periods.

5.4 Filling and Draining of Test Basin

The water must flow into the basin over the basin liner or over rip rap placed on the bank of the basins in such a manner as to minimize currents and horizontal water movement within the basin during filling. The rate of filling of the basins (flooding) will be between 6" and 12" per hour.

5.5 Duration of Testing and Depth of Exposure

The duration of exposure to simulated flood water shall be 72 hours, not including filling and draining time. The test module will be immersed to a depth of 2 feet above the module's finished floor. Where it is desired to determine the effects of exposure in excess of 72 hours, the report shall identify the exposure period used, and basis for the selection of the exposure period.

5.6 Drying of Test Module

After the exposure period, and prior to testing, the building envelope shall be dried at ambient natural conditions for 28 days. The ambient field conditions shall be monitored continuously and recorded at 15-20 minute intervals throughout the drying period, including temperature, humidity, wind velocity, weather (rain, clear, etc.), and amount of sunlight.

5.7 Size of Test Module

The amount of quality control utilized in the production of the test module must be considered when determining the minimum size of the module required. The size of the module should be such to allow standard building elements to be used (i.e. 4' x 8' plywood, drywall etc.). The recommended minimum size of the module should be 8' x 8' x 8' high. At least one interior wall should be included.

5.8 Characteristics to be Recorded

Tables 2 and 3 are to be used to maintain records of visual observations and measured quantities that will determine the performance of the envelope system under consideration. The items in Table 2, which are based on visual observation, are to be observed and recorded every 7 days starting at the completion of draining the test basin. Interior element/component observations

should be made after opening the doors and windows. This depends on the accessibility to the building and may take up to four days from the draining time. The items in Table 3 are to be measured after the end of the 28 day drying period.

5.8.1 Strength characteristics

The strength characteristics of critical elements to be measured shall be those necessary for the envelope assembly to be capable of performing the intended function after the flood exposure and after the drying period. This includes ultimate flexural strength and/or buckling resistance as measured from mechanical testing of samples taken from the test module. The length of the sample should be the length between supports for standard construction practice for mounting the material under investigation. These properties should be measured at the end of the 28 day drying period to establish the structural factor. It should be mentioned that the building elements that are not affected by flood exposure, based on visual observation, need not be tested.

5.8.2 Dimensional stability and Operating Force

The dimensional stability properties to be measured shall be those necessary for the material to be capable of performing the intended function after the flood exposure and drying. For fixed elements/components this may consist of effects such as swelling, shrinkage, or warping of the subject, for moveable elements this may consist of effects to the operation and/or functionality of the subject after exposure. Changes in the operating force (the amount of force it takes for the sash to operate) is pertinent to fenestration products.

5.8.3 Hygroscopic properties

The hygroscopic properties shall provide a means of establishing the amount of moisture absorbed after exposure to water and the amount of moisture retained after the drying period. The amount of moisture absorbed shall be determined gravimetrically.

5.8.4 Natural Drying Rate

The natural drying rate is defined as the time period required for the components of the envelope to obtain 90% of their pre-flood characteristics or properties. The maximum drying time should be 28 days. It should be noted that some elements/components may dry faster and therefore have a faster drying rate, however they should be tested at the end of the 28 day drying time.

5.8.5 Biological characteristics

Wet surfaces encourage mold growth, which discolors surfaces, leads to odor problems, deteriorates building materials, and may cause allergic reactions and other health problems in susceptible individuals. The nature and extent of biological factors such as mildew growth and coverage shall be observed and quantified based on microscopic counts per unit area. This should be done prior to flooding and at 14 day intervals throughout the 28 day drying time.

5.8.6 Ability to be cleaned and restored after flood water exposure

Test elements/components with visible solid deposits and stains shall be cleaned with a bleach/clothes washing detergent solution. Characteristics such as stain discoloration and remaining solid deposits shall be observed following the cleaning process. The characteristics to be measured related to the ability to be cleaned shall be those necessary for the material to be restored to the condition prior to flood exposure with nothing more than cosmetic repairs. Cosmetic repair includes the cleaning process along with minimal surface refinishing (sealing,

filling, sanding, and painting) with commonly available materials.

5.8.7 General appearance

The overall appearance of test element/components during and after the drying period shall be observed. Any apparent change in the overall appearance with respect to the appearance prior to flooding should be observed and documented. Photographic comparison at the same magnification can be used. This inspection should be based on the consensus of opinion of at least three people.

5.8.8 Color

Building elements/components shall be observed after the flood test and during the drying period for color changes. The change in color with respect to a reference point (i.e. panels or sections prepared in the same way during construction) shall be observed at 14 day intervals during the drying period. The observations shall be made using normal daylight by individuals with normal eyesight. This inspection should be based on the consensus of opinion of at least three people.

5.8.9 Texture

The texture of the surface of building elements/components shall be visually inspected during and after the drying period. Surface macrotexture shall be compared to that prior to flood testing. This can be achieved by feeling the surface before, during and after the drying period. A relative comparison based on the roughness of the surface can be made. This inspection should be based on the consensus of opinion of at least three people.

5.8.10 Cracking

Test elements/components after flood exposure and during the drying period should be examined for cracking, which is visible with the naked eye. Any observed cracking should be photographed. Cracking characteristics such as length, thickness, and frequency per unit area can be used for comparison before and after flood testing, as well as during the drying period.

5.8.11 Flaking/Scaling

Development of macroscales (those visible with the naked eye) on surfaces of building elements/components after flood testing and during the drying period should be observed and photographed. Comparisons or counts can be made to determine the extent of scaling on these surfaces. The size and /or scale aspect ratio as well as the number of scales per unit area can be used as a means for evaluation.

5.8.12 Efflorescence

Moisture ingress causes efflorescence (crystalline deposits of alkaline salts) on the surfaces of building elements such as concrete, brick, stucco, plaster, concrete blocks etc. The appearance of white blotchy spots or streaks on the surfaces of building elements / components during the drying process should be monitored and recorded photographically. Following the drying period any efflorescence deposits should be cleaned by dry brushing with water rinsing and/or rinsing with a dilute (5-10%) muriatic acid or vinegar and water solution. The ease and completeness of efflorescence removal from the building elements/components should be noted.

5.8.13 Odors

The building envelope should be inspected and any odors present should be noted, e.g. persistent or objectionable. This inspection should be based on the consensus of opinion of at least three people.

5.9 Materials Standards

When a material is subject to compliance with a specific standard, the characteristics required to be measured and controlled by that standard shall be considered in the flood resistance evaluation. In the absence of material standards available for a particular material, such properties as measured and controlled by the manufacturer's quality control program shall be measured, e.g., the creep or deformation of plastic /wood siding, R value of insulation, etc.

- Load carrying limitations, depending upon adjusted strength values.
- Other limitations based upon adjustments to other design values, such as thermal resistance, fire resistance, etc.

5.10 The Critical Performance Characteristics to be Measured

5.10.1 Determine thresholds for allowable loss of original properties

The loss of original properties after the flood test shall be calculated as a percentage of the measured properties of the control sample. The allowable loss shall be based upon the design level of the property necessary for the intended function. For example, the load carrying capability of a floor system. The reduced allowable design level shall be calculated by applying the percentage loss to the minimum design level required by the applicable standard or manufacturer's quality control program. If enough loss has occurred so that any applicable standard is not met, then this should be stated.

5.10.1.1 Allowable loss of dimensional stability

The material shall demonstrate no loss of dimensional stability that adversely impacts its capability of performing its intended function after flooding and subsequent drying. This shall be based on applicable materials standard and /or manufacturers' quality control standards. Examples include dry wall, floors, windows, doors, siding etc.

5.10.1.2 Acceptable hygroscopic properties

The material shall retain no excess moisture (beyond the control samples) that adversely impacts its capability of performing its intended function after flooding and subsequent drying. This includes expansion, shrinkage warping etc. Examples of elements that are expected to be affected include flooring, insulation, window and door frames etc. In addition, the material should not retain moisture sufficient to support mold growth.

6. Pre and Post Flood Test Evaluation Report

6.1 Date of test and the report.

6.2 Identification of the envelope system including all individual components by manufacturer,

- source of supply, dimensions, materials, and other pertinent information.
- 6.3 Detailed drawings or descriptions of the elements. An example of elements to be observed is given in Table 1. This matrix should be developed for the envelope system to be tested and used to describe all materials and components.
 - 6.4 Description of the simulated flood water. Specific characteristics: pH, electrical conductivity, organic materials, chemicals from fertilizer run-off , temperature, water speed during filling and draining, water flow direction, duration of exposure, subject's flood water depth.
 - 6.5 Records of ambient conditions, including temperature, wind speed, humidity, insolation, and rainfall during and after testing that have been recorded at 15-20 minute intervals throughout the flooding and drying period.
 - 6.6 A record of visual observations and measured quantities for identifying changes of the building envelope, component and materials. An example of how to record the observations and measured quantities for each element is given in Table 2. A record such as given in Table 2 should be filled out prior to flooding and used thereafter as a reference for comparisons. Comparison can also be made between the same element/component above and below the flood line. This matrix will then be filled-in at intervals specified in the specific items during the drying period for the visual observation parameters. It should also be noted that not all of the observations and the measured quantities are applicable to each building element. Table 2 is a generic format for visual observations and measured quantities for a building element with suggested standards and test methods.
 - 6.7 A record of measured quantities of test parameters related to the performance of building envelope, component and materials recorded after the end of the 28 day drying time. This should include the standards or test methods used. Other relevant standards and protocols such as [29-31] can also be consulted, in addition to those mentioned in Table 2 and listed in Section 7 of this protocol.
 - 6.8 The names and addresses of both the testing agency that conducted the tests and the requester of the tests.
 - 6.9 The names of the authors of the report.
 - 6.10 Signatures of persons responsible for supervision of the tests and a list of official observers.
 - 6.11 Any additional data or information considered to be useful for a better understanding of the test results, conclusions, or recommendations should be included in the report.

Table 1. Example of a building assembly for which observations are to be made.

Building element	Description
Interior Finishes	
Dry Wall	
Insulations	
Electrical Distribution System	
Windows	
Doors	
Siding	
Others	

Table 2. Evaluation matrix for the test protocol based on visual observations.

Building Element Evaluated:				
Date of Flooding: Date:	Prior to Flooding	After Flooding	Comments	Protocol Section or Standard Test Method to be Used
Visual Observations	Date:	Date:		
General Appearance				Protocol Section 5.8.7¹
Color				Protocol Section 5.8.8²
Texture				Protocol Section 5.8.9³
Washability				Protocol Section 5.8.6⁴
Cracking				Protocol Section 5.8.10⁵
Checking				ASTM D660-93
Flaking/Scaling				ASTM D772-86, Protocol Section 5.8.11⁶
Efflorescence				Protocol Section 5.8.12⁷
Biological				Protocol Section 5.8.5
Odors				Protocol Section 5.8.13

¹ Any apparent change in the overall appearance with respect to the appearance prior to flooding shall be observed and documented photographically. All photographs taken prior to and after flooding and restoration will be done with the same lighting and magnification.

² The change in color with respect to a reference point (i.e. panels or sections prepared in the same way during construction) shall be observed at 14 day intervals during the drying period. The observations will be made using normal daylight by three individuals with normal eyesight.

³ Surface macrotexture shall be compared to that prior to flood testing. This will be achieved by feeling the surface before, during and after the drying period. A relative comparison based on the roughness of the surface will be made. This observation will be made by three individuals.

⁴ Test elements/components with visible solid deposits and stains shall be cleaned with a bleach/clothes washing detergent solution. Characteristics such as stain discoloration and remaining solid deposits will be noted .

⁵ Any observed cracking shall be documented photographically. Cracking characteristics such as length, thickness, and frequency per unit area will be used for comparison.

⁶ Development of macroscales (those visible with the naked eye) on surfaces of building elements/components after flood testing and during the drying period shall be observed and photographed. The size and /or scale aspect ratio as well as the number of scales per unit area will be used as a means for evaluation.

⁷ The appearance of white blotchy spots or streaks on the surfaces of building elements / components during the drying process shall be observed and recorded photographically. The ease and completeness of efflorescence removal, using a dilute (5-10%) muriatic acid or vinegar and water solution, from the building elements/components during the restoration efforts will be noted.

Table 3. Evaluation matrix for the test protocol based on Measured Quantities

Building Element Evaluated:				
Date of Flooding:	Prior to Flooding Date:	After 28 days drying Date:	Comments	Protocol Section or Standard Test Method to be Used
Date:				
Blistering				ASTM D714-87(1994)
Surface wettability				ASTM D5725-99
Water absorption				ASTM C272-91, D5795-95, D1037-99
Operating force				ANSI/AAMA/NWWDA 101-I.S.2- 97
Dimensional stability				Protocol Section 5.8.2 ⁸
Thermal Properties				ASTM C1155-95, C1363, C1199, C177, C518, C1114, NFRC (1997)
Creep Deformation				ASTM E1803-99, D6112-97, D2990-95
Peel Strength				ASTM E2004-99, D903-98
Flexural Strength				ASTM D3043-95, E529-94
Tensile Strength				ASTM D1037-99, C474-97, E455-98
Compressive Strength				ASTM D1037-99
Shear Strength				ASTM E564-95
Adhesive				ASTM C1404-98, D906-98, D2339-98, D4680-98, C557-99, D2559-00, D3498-99

⁸ The nature and extent of biological factors such as bacteria count and mildew growth and coverage shall be observed, quantified, and documented based on microscopic counts per unit area.

⁹ The building envelope shall be inspected and any persistent or objectionable odors present noted. This inspection will be made by three individuals.

¹⁰ The dimensional stability properties to be measured shall be those necessary for the material to be capable of performing the intended function after the flood exposure and drying. For fixed elements/components this may consist of effects such as swelling, shrinkage, or warping of the subject, for moveable elements this may consist of effects to the operation and/or functionality of the subject after exposure. For example, changes in the operating force (the amount of force it takes for the sash to operate) is pertinent to fenestration products.

7. Referenced Documents

- ASTM Standards, American Society for Testing and Materials, West Conshohocken, PA.
1. D3450-00 Standard test method for washability properties of interior architectural coatings
 2. D660-93 Standard test method for evaluating degree of checking of exterior paints
 3. D772-86 Standard test method for evaluating degree of flaking (scaling) of exterior paints
 4. D714-87(1994) e1 Standard test method for evaluating degree of blistering of paints
 5. D5725-99 Standard test method for surface wettability and absorbency of sheeted materials using an automated contact angle tester
 6. C272-91 Standard test method for water absorption of core materials for structural sandwich constructions
 7. D5795-95 Standard test method for determination of liquid water absorption of coated hardboard and other composite wood products via "Cobb Ring" apparatus
 8. D1037-99 Standard test method for evaluating properties of wood-base fiber and particle panel materials
 9. C1155-95 Standard practice for determining thermal resistance of building envelope component from the in situ data
 10. C1363 Standard test method for thermal performance of building assemblies by means of a guarded hot box apparatus
 11. E1803-99 Standard test methods for determining structural capacities of insulated panels
 12. D6112-97 Standard test methods for compressive and flexural creep and creep-rupture of plastic lumber and shapes
 13. D2990-95 Standard test methods for tensile, compressive, and flexural creep and creep rupture of plastics
 14. E2004-99 Standard test method for facing cleavage of sandwich panels
 15. D903-98 Standard test methods for peel or striping strength of adhesive bonds
 16. D3043-95 Standard methods of testing structural panels in flexure
 17. E529-94 (1998) e1 Standard guide for conducting flexural test on beams and girders for building construction
 18. C474-97 standard test method for joint treatment materials for gypsum board construction
 19. E455-98 Standard method for static load testing framed floor or roof diaphragm construction for buildings
 20. E564-95 Standard practice for static load test for shear resistance of framed walls for buildings
 21. C1404/C1404M-98 Standard test method for bond strength of adhesive systems used with concrete as measured by direct tension
 22. D906-98 Standard test method for strength properties of adhesive in plywood type construction in shear by tension loading
 23. D2339-98 Standard test method fo strength properties of adhesive in two-ply wood construction in shear by tension loading
 24. D4680-98 standard test method fo creep and time to failure of adhesive in static shear by compression loading (wood-to-wood)
 25. C557-99 Standard specification for adhesive for fastening gypsum wallboard to wood framing
 26. D2559-00 Standard specification for adhesive for structural laminated wood products for use under exterior (wet use) exposure conditions

- 27.D3498-99 Standard specification for adhesive for field -glueing plywood to lumber framing for floor systems
- 28.E632-82 Standard practice for developing accelerated test to aid prediction of the service life of building components and materials
- 29.STP 1314 Water leakage through building facades
- 30.C1199-97 Standard Test Method for Measuring the Steady State Thermal Transmittance of Fenestration Systems Using Hot Box Methods
- 31.C177-97 Standard Test Method for Steady-State Heat Flux Measurements and Thermal Transmittance Properties by Means of the Guarded-Hot-Plate Apparatus
- 32.C518-98 Standard Test Method for Steady-State Thermal Transmittance Properties by Means of the Heat Flow Meter Apparatus
- 33.C1114-98 Standard Test Method for Steady-State Thermal Transmission Properties by Means of the Thin-Heater Apparatus
- 34.D2244-93(2000) Standard Test Method for Calculation of Color Differences From Instrumentally Measured Color Coordinates
35. AANSI/AAMA/NWWDA 101-I.S.2- 97, Voluntary specifications for Aluminum, Vinyl (PVC) and wood windows and glass doors
36. NES evaluation protocol for determination of flood-resistance properties of building elements, in preparation.
37. NFRC Test Procedure for Measuring the Steady-State Thermal Transmittance of Fenestration Systems (1997)

APPENDIX B

**PROTOCOL 2
DRYING OUT TEST FACILITIES
AFTER FLOOD WATER HAS BEEN DRAINED FROM BASINS**

PROTOCOL 2
DRYING OUT TEST FACILITIES
AFTER FLOOD WATER HAS BEEN DRAINED FROM BASINS

November 26, 2001

Authors:

Sherry Livengood, Oak Ridge National Laboratory,
PO Box 2008, Oak Ridge, TN 37831-6070, Tel: 865-574-2018, Email: livengoodse@ornl.gov
Robert Wendt, Oak Ridge National Laboratory,
Tel: 865-754-0260, Email: wendtrl@ornl.gov
Heshmat Aglan, PhD, Tuskegee University,
Tuskegee, AL 36088, Tel: 334-727-8857, Email: aglanh@tusk.edu

1. Scope

This protocol provides the steps that should be followed in drying out the two test facilities after flood water has been drained from the basins. (Procedures for draining basins have been established in the Protocol for Field Testing Flood-Damage-Resistive Residential Envelope Systems.) *It should be mentioned that this protocol was developed prior to actual testing and inspection of the test modules.*

2. Significance

The following paragraphs provide a projected scenario of what might occur in an actual flood.

Emergency authorities typically require that homeowners vacate their homes during and after flooding. Typically, authorities do not allow homeowners return to the area until several days after flood waters have receded and authorities have ascertained that it is safe for civilians to return to the area. After homeowners are permitted to return, they examine their homes and take preliminary steps to recover valuables and prevent further damage. The house must be dried out before extensive repairs can be made. A contractor must be hired to do the repairs that a homeowner cannot do himself; because other homes received equivalent damage, it may be weeks before the contractor can begin work on the house.

During the time that the homeowner is attempting to dry out the house and waiting for a contractor to come, the homeowner can be assumed to undertake some measures on his own. The homeowner would determine if it appears to be safe to re-enter the house and make sure electricity, gas, and other utilities are turned off. The homeowner would rescue valuable items such as insurance papers, jewelry, family heirlooms, photographs, etc. And the homeowner would probably take steps to prevent further damage (such as patching holes in the roof or walls). For the test module, none of the above activities are applicable.

Once the homeowner entered the home, he would open doors and windows to accelerate evaporation of flood water. He would presumably remove tree limbs, trash, or other debris. He

might attempt to drain the crawlspace or basement if there is one. If water had collected behind interior walls, he might try to drain the water from behind the walls. Because the mud left behind by flood waters can contain health hazards and slow the drying process, the homeowner would probably scoop out as much mud as possible. Carpets almost always have to be removed and replaced after a flood, and leaving them in place can also inhibit drying. Presumably, after debris and furniture have been removed, the owner could remove floor coverings. And, after flood water has drained from foundations, floors, and walls, the owner could reasonably be assumed to rinse down interior and exterior surfaces to remove dirt and mud, and to slow bacterial growth. (The previous scenario is based on preliminary steps recommended to homeowners in “*Repairing Your Flooded Home*” by FEMA and the American Red Cross.)

Since the intent of the research is to test flood damage to homes under “typical” conditions, the authors decided to attempt to reproduce the above scenario in the test facilities. The authors concluded that most homeowners would attempt to take some remedial steps themselves to move the house towards habitability. The following procedures were developed to approximate steps that the homeowner would typically take subsequent to flooding.

3. Procedures

The following test procedure reflects an effort to approximate expected homeowner behavior in the test module. All events are measured from the draining of the test basin (receding of the flood water).

1. After water has been drained from the basin, wait three days before reentering the test module. On the fifth day, open doors and windows and leave them open throughout the remaining drying period.
2. Using a shovel, scoop out as much mud as feasible from floors of test facilities on the fifth day. (If there is no mud, this step may be skipped.)
3. Pull up carpets and carpet padding on the fifth day. Cut in strips suitable for removal from the site, and remove from the test facilities.
4. Using a hammer, punch holes about 1 inch in diameter on one side of interior walls and on the interior side of exterior walls to drain the walls on the sixth day. Holes should be punched approximately 2 inches above floor surface and into every stud cavity.
5. Using a garden hose and potable water supply, rinse down all dirty surfaces of interior and exterior walls, ceilings, and floors until visible particles of dirt are removed on the seventh day. The authors anticipate that flooding of the test facilities will result in staining of wall and floor surfaces. Spraying down the wall and floor surfaces will not remove stains, but may be able to remove visible dirt and mud particles. Sweep or squeegee water from floors. Allow rinse water runoff to drain from basin. Do not pump or siphon the rinse water, but allow “natural” drainage.
6. If, after seven days, standing water remains in the crawlspace of the test facility, remove the drain plug and drain the remaining water.

7. Provide a written log describing drying activities over 28 days, noting such things as: level of water in crawlspace prior to and subsequent to siphoning efforts, any difficulties in opening doors or windows, time and duration of precipitation, nature and amount of debris or mud removed, approximate quantity of water drained from interior wall as a result of hammer holes, condition of floor covering that is removed, observed dirtiness, physical characteristics, approximate amount and duration of rinse water used

APPENDIX C

**PROTOCOL 3
DRYING OUT, RESTORATION, AND AUTOPSY OF
TEST MODULES C2 AND S2**

PROTOCOL 3
DRYING OUT, RESTORATION, AND AUTOPSY OF
TEST MODULES C2 AND S2

(After Flood Water Has Been Drained from Basins)

Revised: May 10, 2002

Authors:

Sherry Livengood, Oak Ridge National Laboratory,

PO Box 2008, Oak Ridge, TN 37831-6070, Tel: 865-574-2018, Email: livengoodse@ornl.gov

Robert Wendt, Oak Ridge National Laboratory,

Tel: 865-754-0260, Email: wendtrl@ornl.gov

Heshmat Aglan, PhD, Tuskegee University,

Tuskegee, AL 36088, Tel: 334-727-8857, Email: aglanh@tusk.edu

1. Scope

1.1 This protocol provides the steps that should be followed in drying out and restoring the test modules C2 and S2 after flood water has been drained from the basins. (Procedures for draining basins have already been established.)

2. Significance

The following paragraphs provide a projected scenario of what might occur in an actual flood.

Emergency authorities typically require that homeowners vacate their homes during and after flooding. Typically, authorities do not allow homeowners return to the area until several days after flood waters have receded and authorities have ascertained that it is safe for civilians to return to the area. After homeowners are permitted to return, they examine their homes and take preliminary steps to recover valuables and prevent further damage. The house must be dried out before extensive repairs can be made. A contractor must be hired to do the repairs that a homeowner cannot do himself; because other homes received equivalent damage, it may be weeks before the contractor can begin work on the house.

During the time that the homeowner is attempting to dry out the house and waiting for a contractor to come, the homeowner can be assumed to undertake some measures on his own. The homeowner would determine if it appears to be safe to re-enter the house and make sure electricity, gas, and other utilities are turned off. The homeowner would rescue valuable items such as insurance papers, jewelry, family heirlooms, photographs, etc. And the homeowner would probably take steps to prevent further damage (such as patching holes in the roof or walls). For the test module, none of the above activities are applicable.

Once the homeowner entered the home, he would open doors and windows to accelerate evaporation of flood water. He would presumably remove tree limbs, trash, or other debris. He might attempt to drain the crawlspace or basement if there is one. If water had collected behind interior walls, he might try to drain the water from behind the walls. Because the mud left behind by flood waters can contain health hazards and slow the drying process, the homeowner would probably scoop out as much mud as possible. Carpets almost always have to be removed and replaced after a flood, and leaving them in place can also inhibit drying. Presumably, after debris and furniture have been removed, the owner could remove floor coverings. And, after

flood water has drained from foundations, floors, and walls, the owner could reasonably be assumed to rinse down interior and exterior surfaces to remove dirt and mud, and to slow bacterial growth through applying a sanitizing solution to the exposed surfaces. (The previous scenario is based on preliminary steps recommended to homeowners in “*Repairing Your Flooded Home*” by FEMA and the American Red Cross.)

Since the intent of the research is to test flood damage to homes under “typical” conditions, the authors decided to attempt to reproduce the above scenario in the test facilities. The authors concluded that most homeowners would attempt to take some remedial steps themselves to move the house towards habitability. The following procedures were developed to approximate steps that the homeowner would typically take subsequent to flooding.

3. Procedures

The following test procedure reflects an effort to approximate expected homeowner behavior in the test module.

1. On the fifth day after water has been drained from the basin, open doors and windows and leave them open throughout the remaining drying period.
2. Using a shovel, scoop out as much mud as feasible from floors of test facilities on the fifth day. (If there is no mud, this step may be skipped.)
3. Using a garden hose and potable water supply, rinse down all dirty surfaces of interior and exterior walls, ceilings, and floors until visible particles of dirt are removed on the seventh day. The authors anticipate that flooding of the test facilities will result in staining of wall and floor surfaces. Spraying down the wall and floor surfaces will not remove stains, but may be able to remove visible dirt and mud particles. Sweep or squeegee water from floors. Allow rinse water runoff to drain from basin. Do not pump or siphon the rinse water, but allow “natural” drainage.
4. Remove wood flooring and padding from the test module on the seventh day. Salvage flooring for future reuse and dispose of padding. Flooring to be washed thoroughly and stacked to promote drying in rooms C-202 and S-202.
5. If on the tenth day, standing water remains in the crawlspace of the test facility, remove the remaining water by pumping or siphoning.
6. Sanitize the exposed surfaces of the interior of the test module on the eleventh day. Spray vertical surfaces using a pumped garden sprayer with a solution of water, household bleach (25% by volume), and tri-sodium phosphate (5% by volume) until they have been completely wetted. Wet mop the floors with the same solution. Do not attempt to scrub surfaces to remove dirt or stains at this time.
7. Provide a written log describing drying activities over 28 days, noting such things as: level of water in crawlspace prior to and subsequent to pumping/siphoning efforts, any difficulties in opening doors or windows, time and duration of precipitation, nature and amount of debris or mud removed, condition of floor covering that is removed, observed dirtiness, physical

characteristics, approximate amount and duration of rinse water used, and so forth.

8. After completing observations and data collection at the end of the drying period, prepare the modules for restoration efforts. Outline areas to receive restoration with a pencil. For interior wall surfaces each wall should have a representative two feet wide strip from floor to ceiling designated for restoration. For trim, doors, and all other surfaces designate the areas to be restored such that a side-by-side visual comparison can be made of restored and non-restored surfaces.

9. Perform restoration of surfaces to restore them to pre-flood appearance and performance. Specifics of restoration activities will vary with the material being restored. It may include: a. Further cleaning; b. Removal of the loose or irregular surface through scraping or sanding; c. Sealing of stains; d. Patching of cracks, wallboard joints, etc.; e. Repainting the surface; f. Reinstallation of the loose lay flooring on new padding; and g. Trimming doors or windows if needed to restore their proper operation.

10. Restoration work should be completed by the 35th day after draining the basins. Provide a written and photographic log of all restoration activities.

11. After completion and documentation of all restoration efforts and the performance of materials properties testing (as done with Modules C1 and S1), autopsy the both modules in the following manner:

- a. Remove a 2' wide strip of wallboard (floor to ceiling) from one side of the interior partition and inspect for: moisture content of the exposed wood stud; mold or mildew growth on previously hidden surfaces; any abnormality that could affect the long term performance of this system.
- b. Remove a 2' wide strip of wall board (floor to ceiling) on the interior of an exterior wall and inspect for: moisture content of the exposed wood stud; moisture content of the foam insulation; mold or mildew growth on previously hidden surfaces; any abnormality that could affect the long term performance of this system.
- c. Remove an approximately 2' wide strip of siding and building felt (if applied) on all four exterior walls in order to expose the sheathing and inspect for: moisture content of the exposed sheathing; moisture content of the siding (if measurable); mold or mildew growth on previously hidden surfaces; any abnormality that could affect the long term performance of this system.

12. If no conditions are found in Step 11 that would affect long-term performance, complete the demolition of the remainder of the test modules while observing and conditions or abnormality that could affect the long-term performance of this system. Note the roof system may be salvaged for reuse on future test modules.

13. If conditions are found in Step 11 that could impact the long-term performance delay the complete demolition of the test modules until approximately 60 days after the drying period began. This delay will permit the potential of additional drying to occur under ambient conditions. After approximately 60 days complete Step 12.

14. During the demolition of the test modules observe and document conditions or abnormality that could affect the long-term performance of this system that have not been previously seen and documented.

APPENDIX D
EXAMPLES OF VISUAL EVALUATION FORMS

EXAMPLES OF VISUAL EVALUATION FORMS

Evaluation matrix for visual observations based on the test protocol - INTERIOR (Summary)

Date of Flooding	Data sheets	Protocol Section or Standard Test Method to be Used	Number of Components Evaluated
Visual Observations Overall Interior S-1			<i>1 sheet for each component can be found in each of the following sections</i>
General Appearance	Data Sheet 1	Protocol Section 5.8.7	Noticeable change as explained below.
Color	Data Sheet 2	Protocol Section 5.8.8	Discoloration below water level on all walls and doors
Texture	Data Sheet 3	Protocol Section 5.8.9	Light scum on the walls
Washability	Data Sheet 4	Protocol Section 5.8.6	Not good, paint and tape was removed
Cracking	Data Sheet 5	Protocol Section 5.8.10	Paints and interior doors
Checking		ASTM D660-93	
Flaking/Scaling	Data Sheet 6	ASTM D772-86, Protocol Section 5.8.11	Severe on painted walls below water level
Efflorescence	Data Sheet 7	Protocol Section 5.8.12	-
Biological	Data Sheet 8	Protocol Section 5.8.5	None observed at the time of opening.
Odors	Data Sheet 9	Protocol Section 5.8.13	Musty odor

**Evaluation matrix for visual observations based on the test protocol - EXTERIOR
(Summary)**

Date of Flooding	Data sheets	Protocol Section or Standard Test Method to be Used	Number of Components Evaluated
Visual Observations Overall Exterior S-1			<i>1 sheet for each component can be found in each of the following sections</i>
General Appearance	Data Sheet 1	Protocol Section 5.8.7	Some solid deposits, no change
Color	Data Sheet 2	Protocol Section 5.8.8	Brown stains below water line
Texture	Data Sheet 3	Protocol Section 5.8.9	No change
Washability	Data Sheet 4	Protocol Section 5.8.6	Some stains removed by washing with water
Cracking	Data Sheet 5	Protocol Section 5.8.10	Minor cracking particularly in corners
Checking		ASTM D660-93	
Flaking/Scaling	Data Sheet 6	ASTM D772-86, Protocol Section 5.8.11	Some paint flaking and scaling especially after washing with hose
Efflorescence	Data Sheet 7	Protocol Section 5.8.12	N/A
Biological	Data Sheet 8	Protocol Section 5.8.5	-
Odors	Data Sheet 9	Protocol Section 5.8.13	No odors noticed from outside

Visual Observation Data Sheet 1: (General Appearance) Element/ Component:

1&2 Exterior Wall ___Interior Wall ___ Floor ___Other:

Component Description and Orientation Crawl Space C-1

Before Flooding

Date: 11/10/01

Location	Comments
1	White a bit moist look, nor mal surface finish, no stain or spot on the surface
2	Normal white paint looking dried., normal surface finish.
3	Joining of the wood very tight and rigid.
4	Normal white painted surface.

1 Day After Draining (exterior observations only)

Date: 11/16/01

Location	Comments
1	White color tarnished a bit, dead grass –debris stuck on the wall.
2	Wall looked soaked and wetted, Stain mud spot visible.
3	Color looked a bit pale and moist.
4	No change as like as before flood.

5 Days After Draining

Date: 11/20/01

Location	Comments
1	Hair splitting crack visible on the wood surface.
2	Off white dried color.
3	Few pale yellowish spot visible
4	No change.

12 Days After Draining

Date: 11/27/01

Location	Comments
1	Few yellowish dry spot visible.
2	Joints opened up a bit.
3	Apparently no spot or dried surface
4	No change

19 Days After Draining

Date: 12/04/01

Location	Comments
1	Dried cracks the visible, surface looked a bit rough.
2	Some micro cracks visible on Pale White dried surface
3	Apparently no spot on dried surface but some micro cracks
4	Almost no change but some micro cracks.

26 Days After Draining

Date: 12/11/01

Location	Comments
1	More micro cracks and joints opened up a bit.
2	Apparently no change but micro cracks.
3	Apparently no change but micro cracks.
4	Apparently no change but micro cracks.

Other comments may be written on the reverse side

* For interior and exterior walls locations 1, 2, 3, and 4 are at floor level, 1 foot, 2.5 feet and 4 feet above the floor level in the middle of the wall..

** For floors locations 1, 2, 3 and 4 are 1 foot away from the center of each of the four walls.

*** Observation locations of other elements should be specified on this sheet.