



# Technology Installation Review

A New Technology Demonstration Publication

DOE/GO-102007-2325

Federal Energy Management Program

Leading by example,  
saving energy and  
taxpayers dollars in  
federal facilities

## Coolerado Cooler Helps to Save Cooling Energy and Dollars

*New cooling technology targets peak load reduction*

### Executive Summary

A new evaporative cooling technology can deliver cooler supply air temperatures than either direct or indirect evaporative cooling systems, without increasing humidity. The technology, known as the Coolerado Cooler™, has been described as an “ultra cooler” because of its performance capabilities relative to other evaporative cooling products.

The Coolerado Cooler evaporates water in a secondary (or working) airstream, which is discharged in multiple stages. No water or humidity is added to the primary (or product) airstream in the process. This approach takes advantage of the thermodynamic properties of air, and it applies both direct and indirect cooling technologies in an innovative cooling system that is drier than direct evaporative cooling and cooler than indirect cooling. The technology also uses much less energy than conventional vapor compression air-conditioning systems and therefore can be a cost- and energy-saving technology for many Federal facilities in the United States.

Performance tests have shown that the efficiency of the Coolerado Cooler is 1.5 to 4 times higher than that of conventional vapor compression cooling systems, while it provides the same amount of cooling. It is suitable for climates having low to average humidity, as is the case in much of the western half of the United States. This technology can also be used to precool air in conventional heating, ventilating, and air-conditioning systems in more humid climates because it can lower incoming air temperatures without adding moisture.

### Introduction

Air-conditioning systems are a major contributor to summer peak electrical demands in most of the United States. Both electric power generators and conventional vapor compression electric air-conditioning systems operate at lower efficiencies when ambient air temperatures are high, and this increases the peak demand on the grid even further. Moreover, peak demand charges are often billed at a utility’s highest rates. Because a significant portion of summer air-conditioning loads occur when electricity is the most expensive, cooling is often more costly than other electrical loads. Therefore, reducing cooling energy demand can offset energy costs at a proportionally greater rate than other load-reduction strategies and yield greater cost savings for a given amount of energy savings.

This *Technology Installation Review*, prepared for the U.S. Department of Energy’s Federal Energy Management Program, describes the operating principles, measured performance,

Bringing you a prosperous  
future where energy is  
clean, abundant, reliable,  
and affordable



U.S. Department of Energy

Energy Efficiency  
and Renewable EnergyInternet: [www.eere.energy.gov/femp/](http://www.eere.energy.gov/femp/)

No portion of this publication may be altered in any form without prior written consent from the U.S. Department of Energy, Energy Efficiency and Renewable Energy, and the authoring national laboratory.

and energy savings potential of the Coolerado Cooler technology. Because this technology significantly reduces electric demand for cooling over the course of a cooling season, it can provide energy and cost savings and help Federal energy managers meet the energy-reduction goals stated in the Energy Policy Act (EPA) of 2005.<sup>1</sup> It can also help to reduce expensive peak demand charges.

The technology uses a water-fueled cooling system powered solely with fan energy to provide more cooling at a lower cost. Incorporating this concept with multiple purges of moist secondary/working air creates a staged indirect evaporative cooling process. This process, known as the Maisotsenko Cycle, is the innovation that led to the Coolerado Cooler's receipt of a prestigious R&D 100 Award from *R&D Magazine* in 2004.

The Coolerado Cooler is modular in design; thus, multiple units can be stacked as high and wide as needed to meet a building's cooling requirements. Capacity configurations range from 1-ton residential window units to 500-ton commercial units. With modifications, the Coolerado Cooler can be integrated into a precooling system for ventilation air in new or existing heating, ventilating, and air-conditioning (HVAC) systems. When used for precooling, it is capable of providing energy and cost savings in virtually any climate in the continental United States.

## Types of Cooling Systems

A wide variety of systems and technologies are used for cooling commercial and residential buildings. The following short descriptions of several system types provide a frame of reference for evaluating the Coolerado Cooler's performance.

### Conventional Systems.

Conventional HVAC systems condition supply air year-round to deliver fresh, comfortable air to building occupants. In summer, conventional air-conditioning systems cool the air and often remove the moisture in it simultaneously by passing the air over a cold surface. When warm, moist "inside" air is blown across the surface of a unit's cooling coil, the air temperature drops and the water vapor in it condenses. The conditioned air is both cooler and drier and therefore more comfortable.

Typically, conventional air-conditioning systems depend on a vapor-compression cycle to provide cooling. Common types of conventional vapor-compression systems are self-contained, factory-assembled packaged units, split units with outdoor compressor and condenser units and indoor air-handling units (AHUs), and chiller systems. Chiller systems use mechanical chillers to cool water that is then distributed to coils located in AHUs. With each of these systems, the cooled air is delivered via terminal devices (e.g., supply diffusers) to the space to be cooled.

**Evaporative Cooling.** When liquid water evaporates and becomes

water vapor, the heat that goes into the evaporation process is removed from the air, resulting in a cooler air temperature.

Evaporative coolers are effective in average- to low-humidity climates, and they consume much less energy than other types of air-conditioning systems.

Evaporative coolers can be either direct or indirect. In **direct evaporative cooling**, water evaporates directly into the supply airstream, reducing the dry-bulb temperature of the air while raising its humidity. The latent heat of the air is used to evaporate the water. Evaporation cools the air while increasing its moisture content or relative humidity. No heat is added or taken out of the air; thus, it is an adiabatic process.

In direct evaporative coolers, often called *swamp coolers*, the supply airstream is in direct contact with water by means of an evaporative medium or wetted pad (such as fiberglass, fabricated paper, or aspen pad) or a series of spray misters. The supply airstream gains a lot of moisture in this process, so cool, moist air must be exhausted from the cooled space and not reused or reconditioned.

Figure 1 illustrates a supply airstream being blown across an evaporative medium. Figure 2 diagrams a psychrometric (see Glossary of Terms for psychrometric terminology) analysis of this direct evaporative cooling process. The entering dry-bulb air temperature ( $T_{DB}$ ) is 110°F (43.3°C), the relative humidity (RH) is 15%, and the thermodynamic wet-bulb temperature ( $T_{WB}$ ) is 72°F (22.2°C).

<sup>1</sup> See [www.eere.energy.gov/femp/about/legislation\\_epact\\_05.html](http://www.eere.energy.gov/femp/about/legislation_epact_05.html), 2006.

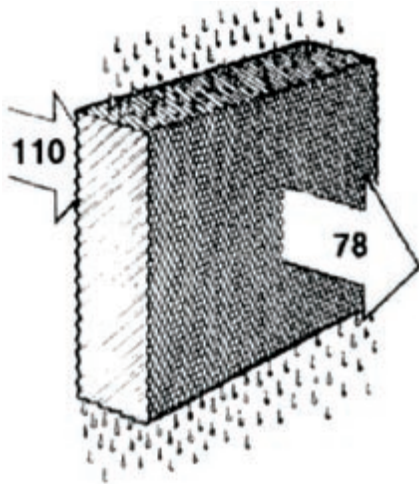

Figure 1. Direct evaporative cooling through a wetted medium. Source: [www.energy.ca.gov/appliances/2003rulemaking/documents/case\\_studies/CASE\\_Evaporative\\_Cooler.pdf](http://www.energy.ca.gov/appliances/2003rulemaking/documents/case_studies/CASE_Evaporative_Cooler.pdf)

Up to 38°F (21.1°C) of cooling can theoretically be achieved (110°F (43.3°C) – 72°F (22.2°C)) by simply adding water to the supply airstream. In this case, the supply airstream was cooled to within 6°F (3.3°C) of the thermodynamic wet-bulb limit, so it was 84% effective as 32°F (17.8°C) of cooling was achieved out of 38°F (21.1°C) that was theoretically possible. Achieving 90% to 95% of the wet-bulb temperature is often the target for direct cooling performance.

A psychrometric chart can show why direct evaporative cooling works well in dry climates and not as well in humid ones. Using Figure 3, if we start with 95°F (35°C)  $T_{DB}$  air (A) with relative humidity of 70%, that air can be directly cooled only 9°F (5°C) before it reaches saturation at a  $T_{WB}$  of 86°F (30°C). Moving up and to the left on the short red line at A, the final air temperature can be read by following the vertical lines to the dry-bulb temperature. Starting with 95°F (35°C)  $T_{DB}$  air (B) at 10% relative humidity, that

**PSYCHROMETRIC CHART**

Sea Level

PSYCHROMETRIC CHART (SEA LEVEL) inches of Mercury

Direct evaporative cooling process

**A:** Entering air properties

$T_{DB} = 110^{\circ}\text{F}$  (43.3°C)

$T_{WB} = 72^{\circ}\text{F}$  (22.2°C)

RH = 15%

**B:** Leaving air properties

$T_{DB} = 78^{\circ}\text{F}$  (25.6°C)

$T_{WB} = 72^{\circ}\text{F}$  (22.2°C)

RH = 75%

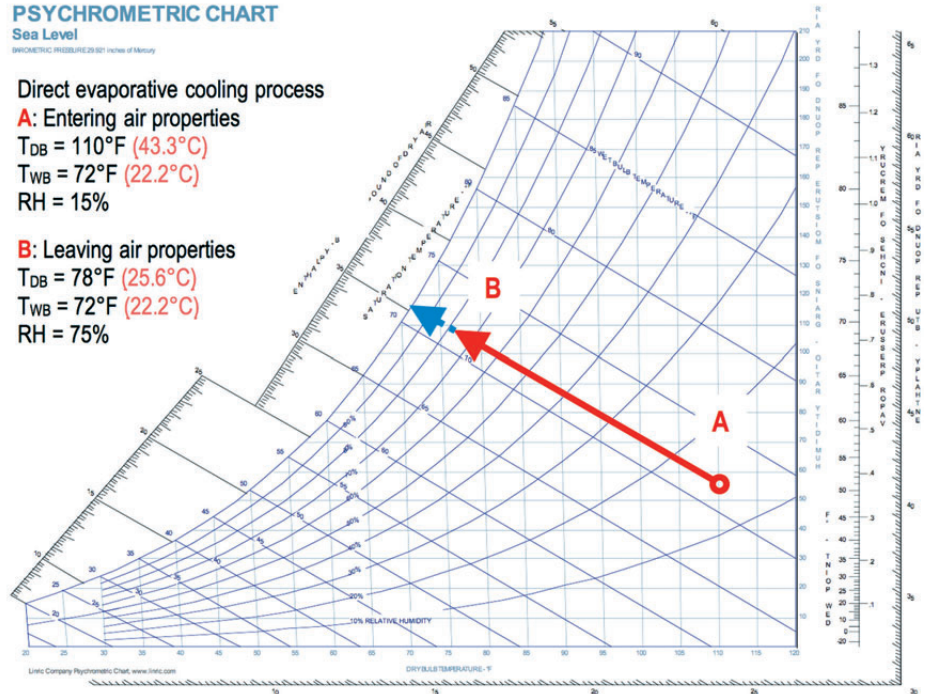

Figure 2. Direct evaporative cooling process shown psychrometrically.

Source: *PsycPro software at www.Linric.com*

**PSYCHROMETRIC CHART**

Sea Level

PSYCHROMETRIC CHART (SEA LEVEL) inches of Mercury

Potential cooling from direct evaporative cooling

**A:** 95°F (35°C) - 86°F (30°C) = 9°F (5°C) of cooling possible

**B:** 95°F (35°C) - 60°F (15.6°C) = 35°F (19.4°C) of cooling possible

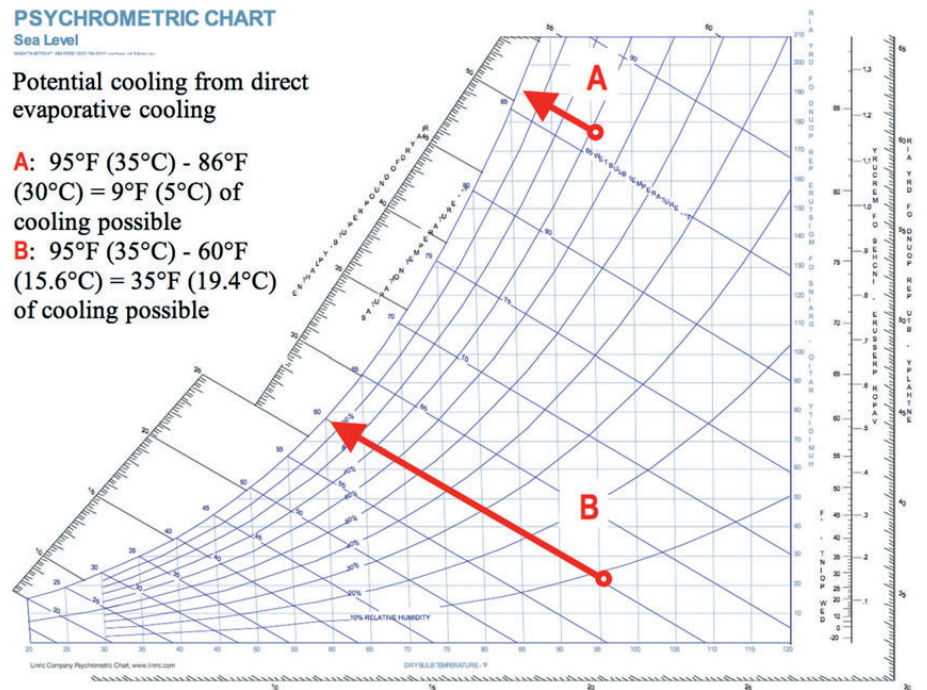

Figure 3. Comparison of the direct evaporative cooling possible when starting with  $T_{DB}$  of 95°F (35°C) at 70% RH vs. at 10% RH. Source: *PsycPro software at www.Linric.com*

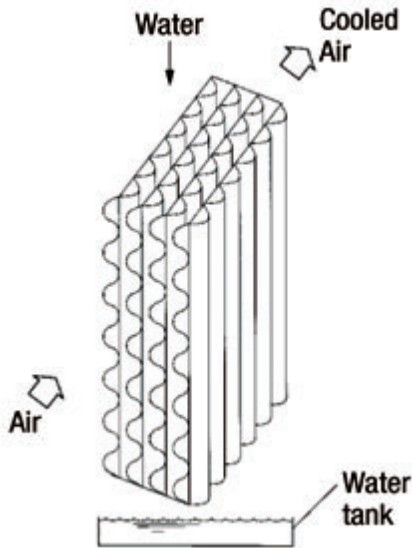

Figure 4. In an indirect evaporative cooling process, the primary airstream flows in a different channel than the secondary airstream. *Source: Wang, Shan K., Handbook of Air Conditioning and Refrigeration (2nd Edition), McGraw-Hill, p. 5, 2001; www.knovel.com/knovel2/Toc.jsp?BookID=568&VerticalID=0*

air can be cooled to 65°F (18.3°C) before condensing, for about 35°F (19.4°C) of cooling. This is a significant increase in the amount of cooling that can be delivered than from humid air at the same temperature. It shows that there is greater cooling potential in air that is initially at a lower relative humidity when a direct evaporative cooling process is used.

The cooling effect from direct evaporative coolers is a result of the amount of moisture added to the air. Direct systems are not as effective or efficient in climates in which the outside ambient air is typically humid (such as the eastern half of the United States), because little moisture can be added to the air and the cooling effect is minimized. In very dry climates (such as those in many parts of New Mexico and Nevada), direct cooling is quite effective at cooling dry ambient air. In

**PSYCHROMETRIC CHART**

Sea Level  
IPSCHEMTRIC CHART, 1982 (2011) version of Linric

Indirect evaporative cooling process

**A:** Entering air properties  
 $T_{DB} = 100^{\circ}\text{F}$  (37.8°C)  $T_{WB} = 65^{\circ}\text{F}$  (18.3°C) RH = 12.8% W = 36.7

**B:** Leaving air properties  
 $T_{DB} = 78^{\circ}\text{F}$  (25.6°C)  $T_{WB} = 56^{\circ}\text{F}$  (13.3°C)  
 RH = 28.4% W = 36.7

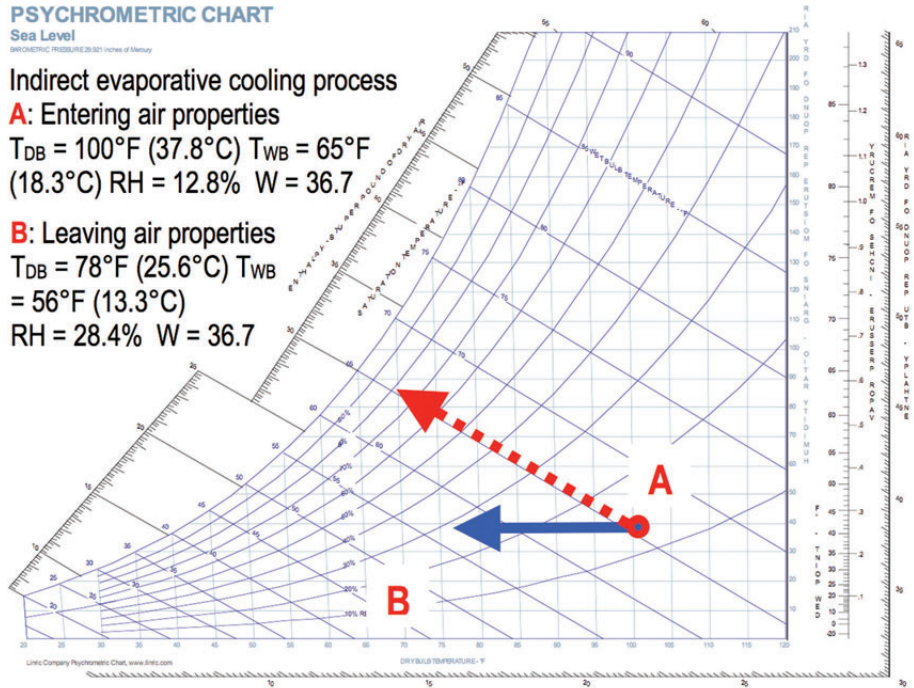

Figure 5. In the indirect evaporative cooling process, no water is shown being added to the primary airstream as it cools from A to B. *Source: PsycPro software, www.Linric.com*

addition, the added moisture in the air can be a bonus.

Direct evaporative coolers have several energy and cost advantages over vapor compression systems. Typically, they have lower installed costs and consume much less energy than central air conditioners. These are some additional advantages:

- Lower initial cost than alternatives
- Lower delivery temperature than indirect units
- Less water use per cubic foot per minute (cfm) than that of indirect evaporative coolers
- Substantial energy and energy cost savings compared with vapor compression systems
- Reduced peak power demand
- Wide variety of packaged systems available
- Easy integration into built-up systems

- No chlorofluorocarbon (CFC) usage
- Reduced pollution-causing emissions

The **indirect evaporative cooling process** typically involves two airstreams: one primary or product airstream and one secondary or working airstream (Figure 4). The indirect cooling process evaporates water and removes heat from the secondary/working airstream, while not adding moisture to the primary/product air. A heat exchange membrane is used between the working airstream and the supply airstream. The membrane's ability to transfer heat out of the supply airstream and the air flow rate determine the effectiveness of the system.

Psychrometrically, the indirect cooling process moves left horizontally across the chart, since no moisture is added (Figure 5). Theoretically, the air can be cooled

to the same wet-bulb temperature through indirect evaporative cooling as it can be through direct evaporative cooling. In practice, the direct evaporative cooling process typically delivers cooler air than the indirect process because of heat exchanger inefficiencies in the indirect process. Because the secondary/working airstream has added moisture, it is eventually exhausted from the building and no moisture is added to the primary/product airstream.

The thermodynamic wet-bulb temperature is often the target temperature for both direct and indirect evaporative cooling technologies. It is considered to be the lowest temperature attainable through thermodynamic processes without the need for additional energy.

**Combined Indirect/Direct Evaporative Cooling.** Both indirect and direct cooling processes can be combined into a single piece of equipment in a two-stage process (Figure 6). In typical indirect/direct systems, the secondary airstream sensibly cools the primary air in the first stage in an indirect process. The air is then directly cooled through evaporation to lower the temperature further (Figure 7). The primary or supply air may actually exit below the initial wet-bulb temperature. This approach increases the humidity of the primary or supply air. However, it can operate effectively in a wider range of climates than direct evaporative cooling, and related energy costs are lower than those of conven-

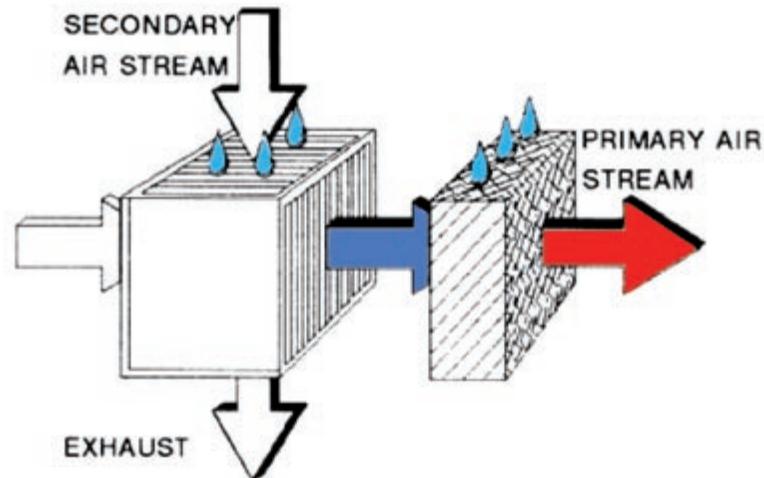

Figure 6. Two-stage indirect/direct evaporative cooling. Source: [www.energy.ca.gov/appliances/2003rulemaking/documents/case\\_studies/CASE\\_Evaporative\\_Cooler.pdf](http://www.energy.ca.gov/appliances/2003rulemaking/documents/case_studies/CASE_Evaporative_Cooler.pdf)

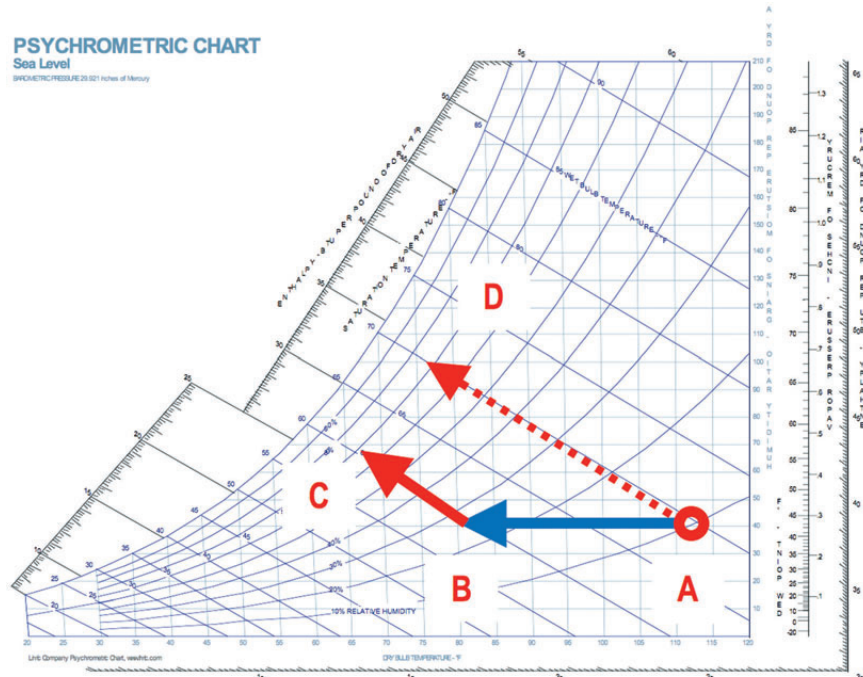

Figure 7. Two-stage indirect/direct evaporative cooling (indirect from A to B and then direct from B to C) yields a lower  $T_{DB}$  than does direct-only from A to D. Source: *PsycPro software at www.Linric.com*

tional vapor compression air conditioning.

### Ultracoolers

Several coolers are able to cool air below the thermodynamic wet-bulb temperature associated with the dry-bulb temperature of the outside ambient air. The Coolerado

Cooler is one such ultracooler. It differs markedly from conventional indirect/direct systems because the direct evaporative process does *not* involve the supply air; rather, it involves the secondary or working airstream. As a result, no moisture is added to the supply air throughout the entire cooling process, while the

<sup>2</sup> Source: [www.oasysairconditioner.com](http://www.oasysairconditioner.com), 2005.

effectiveness of the evaporative cooling process is notably increased. The Coolerado Cooler can cool below the wet-bulb temperature; the dew-point temperature is its cooling limit.

The OASys™ system<sup>2</sup> is another example of an innovative dual-stream ultracooler that employs both direct and indirect cooling processes in a single unit. This ultracooler can also add a controlled amount of moisture to the primary airstream.

The Coolerado Cooler uses both a direct and an indirect process operating in parallel and in stages to achieve cooler air than a direct or indirect system alone would achieve. Water is evaporated into air in one chamber within the cooler, and this cools the air flowing in an adjacent chamber. The cold air is used to cool the building while the water vapor holding the heat is exhausted.

### Coolerado Cooler Basics

Figure 8 shows typical supply air temperatures from several different types of cooling technologies, given ambient psychrometric conditions of 96°F (35.6°C)  $T_{DB}$ , 71°F (26.7°C)  $T_{WB}$ , 58°F (14.4°C) dew point, and RH of 29% at an elevation of 2500 ft (762 m). As shown, conventional air-conditioning delivers the lowest supply air temperature, but at a significant cost in terms of energy and dollars. Indirect evaporative coolers typically deliver air near the comfort threshold—either slightly above or slightly below it, depending on ambient outside air conditions.

**How It Works.** The Coolerado Cooler has a unique design approach to maximizing the

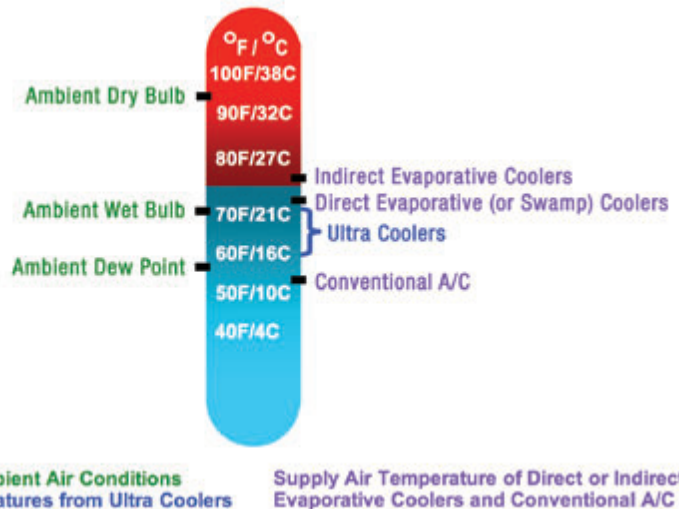

Figure 8. Supply air temperatures from several different cooling technologies. Source: Don Cameron, NREL, 2005.

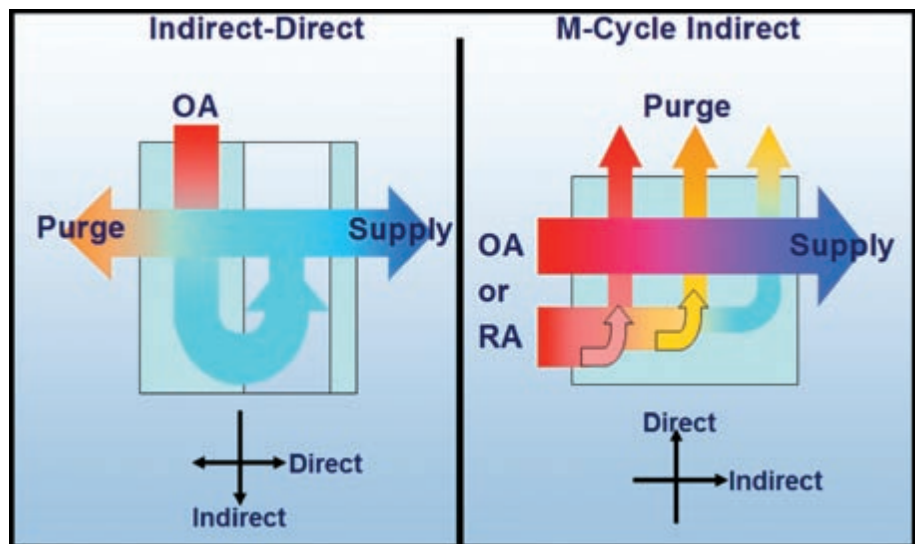

Figure 9. Comparison of conventional indirect/direct air flow vs. the Maisotsenko Cycle air flow. OA is outside air; RA is return air. Source: Steve Slayzak, NREL.

effectiveness of both the direct and indirect stages of its cooling process. The schematic in Figure 9 illustrates fluid movement through the patented Heat and Mass Exchanger™ (HMX). The HMX is made of plastic-coated, cellulose blend fiber in a geometric design that cools both the product and working airstreams without mixing them.

The development of a system of cascading incremental airflows creates a thermodynamic cycle called the Maisotsenko Cycle (or

M-Cycle), named for Dr. Valeriy Maisotsenko (see Figure 9). The cycle works by cooling both the primary/product air and the secondary/working air in stages—20 stages in all. Each stage contributes to cooling by lowering the wet-bulb temperature. The cumulative result is a lower primary/product air temperature than is possible with conventional evaporative cooling technology. The key difference between this and other direct/indirect processes is that the secondary/working air that is accumulating moisture is

exhausted at each stage, enabling more cooling to take place.

To better understand the process, it can be helpful to examine what happens in a single stage of the 20-stage process. In a typical indirect/direct evaporative cooling system, the working air is purged *once*, at the end of the cycle, so the limits of performance are based on the thermodynamics of initial conditions of relative humidity, dry-bulb, wet-bulb, and dew-point temperatures.

Here, the technology used for the Coolerado Cooler enhances its ability to further reduce primary/product air temperatures. It does so by taking the primary/product air at the ending conditions and starting the process over. That product air is split into two airstreams again—the primary/product air and the secondary/working air—but now at a lower dry-bulb temperature and a lower thermodynamic wet-bulb temperature. The new starting point of the primary/product air is to the left of the original starting point on the psychrometric chart, so it has a lower achievable thermodynamic wet-bulb temperature (Figure 10). No moisture is added at this point to either the primary/product air or this portion of the working/secondary air, so significant cooling capacity is available.

In Figure 10, the red arrows indicate the direct evaporative cooling taking place in the process airstream exhausted at each of the 20 stages. The blue arrows represent indirect cooling through the heat exchange membrane, which is taking place in the process/supply airstream with no moisture being added. Note that this portion of the working air does get mixed into the existing working air during the

### PSYCHROMETRIC CHART

Sea Level  
PSYCHROMETRIC HIGRA/REH/DBT Index of Moisture

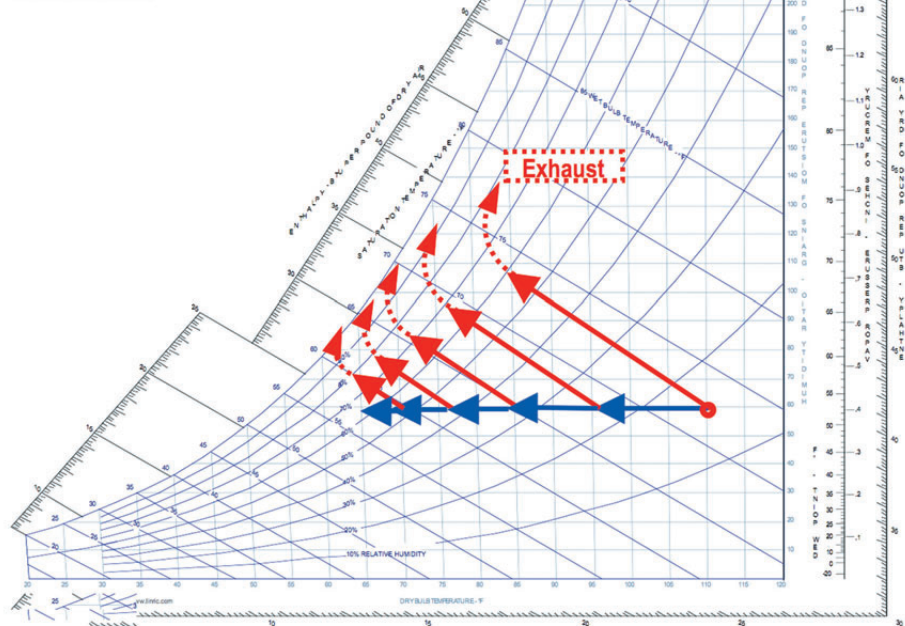

Figure 10. Conceptual psychrometric representation of the staged indirect cooling process with continual purge of secondary/working air. Source: *PsycPro* software at [www.Linric.com](http://www.Linric.com)

purge process, so it will mix with air at higher humidity but only in the working airstream that is continuously exhausted.

The advantage of the Maisotsenko Cycle is that the working air is purged repeatedly so that the initial conditions are essentially reset, as lower dry-bulb and wet-bulb temperatures are established with each purge cycle. This allows the eventual supply air temperature to be below what the original initial conditions would indicate possible—*below the thermodynamic wet bulb temperature*. This key cycling feature is essentially what sets the Coolerado Cooler apart from other indirect/direct evaporative cooling systems and enables greater cooling performance. This cycling continues in all 20 stages, and each contributes to lowering the temperature of the primary/product air.

Figures 10 and 11 illustrate the continuous purge process. Because

of this purging, the Coolerado Cooler requires greater total airflow than other types of cooling systems. However, because the supply air temperature is lower than that possible with direct and indirect evaporative cooling systems, less supply air is required to meet space conditioning needs.

#### Laboratory Testing Parameters.

Engineers at the National Renewable Energy Laboratory (NREL) in Golden, Colorado, operated a Coolerado Cooler unit in the NREL Thermal Test Facility (TTF) during the 2003-2004 time frame (Figure 12). NREL put the Coolerado Cooler through a range of tests to establish its performance capabilities and parameters. The system was equipped with a wide variety of sensors to measure relative humidity, wet-bulb and dry-bulb temperatures, pressure drops, and flow rates across the HMX. Researchers measured the fan power directly from a power transducer. These conditions were

- 1 Outside air is pushed into the Coolerado Cooler heat exchanger with a single fan.
- 2 Product Air Channels.
- 3 Working Air Channels.
- 4 Heat from the Product Air is transferred through the thin plastic and into the Wet Channels below.
- 5 Working Air is blocked from entering the building.
- 6 The Blocked Working Air is turned and passed through small holes into Wet Channels below the Product Air stream.
- 7 The Working Air is now moving through Wet Channels perpendicular or cross flow above and below the Dry Channels.
- 8 The heat that is passed from the Dry Channel is converted into water vapor.
- 9 Heat from the Product Air has been converted into water vapor and is now rejected as exhaust to the outside air.
- 10 The Product Air which has now traveled the length of the heat exchanger, enters the desired space, cold and dry.

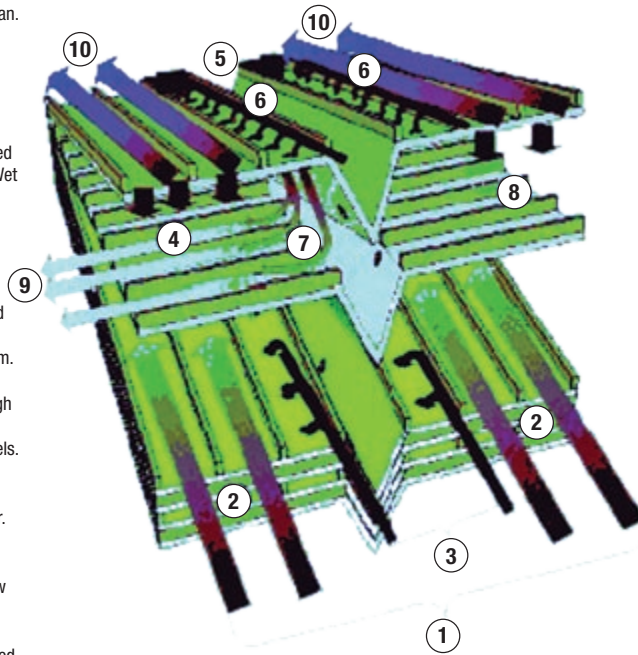

Figure 11. How the staged indirect/direct evaporative cooling process flows. Source: [http://www.idalex.com/technology/how\\_it\\_works\\_-\\_technological\\_perspective.htm](http://www.idalex.com/technology/how_it_works_-_technological_perspective.htm)

measured in a real-world type of environment with the unit installed and providing cooling to the TTF, rather than in a controlled-test setup.

The energy efficiency ratio (EER) on the Energy Guide label found on new air-conditioning equip-

ment states its EER under specific test conditions (see Glossary of Terms for cooling terminology). At NREL, the first test involved determining how effective or efficient the Coolerado Cooler was in providing cooling by determining its EER. The EER calculation was done repeatedly,

but under variable ambient conditions determined by Colorado's weather. Figure 13 shows the calculated EER for a variety of temperature differences between dry-bulb and wet-bulb temperatures.

The calculated EER values indicated a high degree of correlation between the difference between the dry-bulb and wet-bulb temperature and the EER (i.e., the greater the temperature difference, the greater the calculated EER). The Coolerado Cooler unit operates more efficiently when the weather is both hot and dry.

Given the operating characteristics of the Coolerado Cooler and its performance in Colorado, an extrapolation was done to estimate its potential performance in various cities in the western United States. Along with the correlation from the test data, an estimated EER value was calculated using 1% design wet-bulb and dry-bulb temperatures from the American Society of Heating, Refrigerating, and Air-Conditioning Engineers' (ASHRAE) design temperature data for several locations throughout the West.



Figure 12. Coolerado Cooler test unit at NREL's Thermal Test Facility. Source: NREL

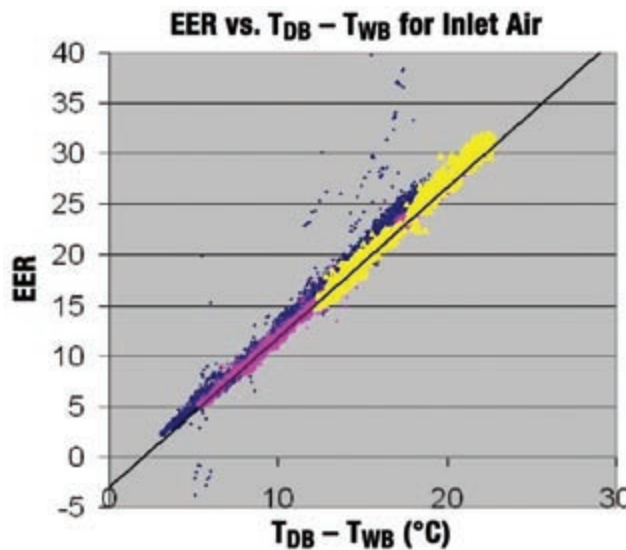

Figure 13. Energy efficiency rating versus wet-bulb temperature depression. Note: Different colors represent different air mixtures and dates. Source: Data collected at NREL's Thermal Test Facility, 2003-2004.



Table 1 shows the estimated EER values for cooling from April through September, averaged over both the month and the day. Peak temperature values with average to low humidity would lead to higher EERs when cooling demands are the highest.

Another analysis performed using the collected data was to determine how effectively the system cooled relative to the thermodynamic wet-bulb temperature. This measure of efficiency, known as *wet-bulb efficiency*, is defined as follows:

where

$$\epsilon_{wet-bulb} = \frac{T_{SI\_DB} - T_{SO\_DB}}{T_{SI\_DB} - T_{SI\_WB}}$$

where

$T_{SI\_DB}$  = Drybulb\_Temperature\_Supply\_Inlet

$T_{SO\_DB}$  = Drybulb\_Temperature\_Supply\_Outlet

$T_{SI\_WB}$  = Wetbulb\_Temperature\_Supply\_Inlet

A value of 1.0, or 100%, indicates that a cooling unit has achieved as much cooling as is theoretically possible, i.e., the thermodynamic wet-bulb temperature. Because the Coolerado Cooler efficiency increases on these units when the difference between dry- and wet-bulb temperatures is greater, a trend can be seen with the change in temperature (Figure 14). As the temperature differential increases beyond 12°-13°C (21°-23°F), efficiencies greater than 85% are regularly achieved.

### Applications for the Coolerado Cooler

The performance of the Coolerado Cooler will vary, depending upon average outside ambi-

State	City	April	May	June	July	August	Sept.
TX	El Paso	13.6	13.7	12.4	9.1	8.8	7.7
NM	Albuquerque	15.7	13.7	13.0	12.7	11.1	10.0
CO	Grand Junction	14.5	13.9	17.3	12.4	12.5	10.9
WY	Cheyenne	12.1	9.3	10.2	9.4	8.2	8.7
MO	Billings	14.6	12.8	13.9	12.8	15.8	14.2
ID	Boise	11.2	15.2	17.0	16.8	17.3	14.6
UT	Salt Lake City	13.1	11.9	16.4	13.3	10.3	10.9
AZ	Phoenix	20.5	20.8	19.5	15.1	13.6	14.5
NV	Las Vegas	20.0	18.5	24.0	16.8	15.1	13.0
CA	Bakersfield	14.8	19.4	21.4	19.5	15.2	13.3
WA	Spokane	9.7	13.9	13.7	15.2	15.2	14.8
OR	Pendleton	9.9	11.9	15.4	19.2	19.4	15.8

Table 1. Estimated average EER for the Coolerado Cooler based on test data correlations. Calculated at NREL (2004) using 1% design wet-bulb temperatures from ASHRAE 2001, Chapter 27<sup>3</sup>.

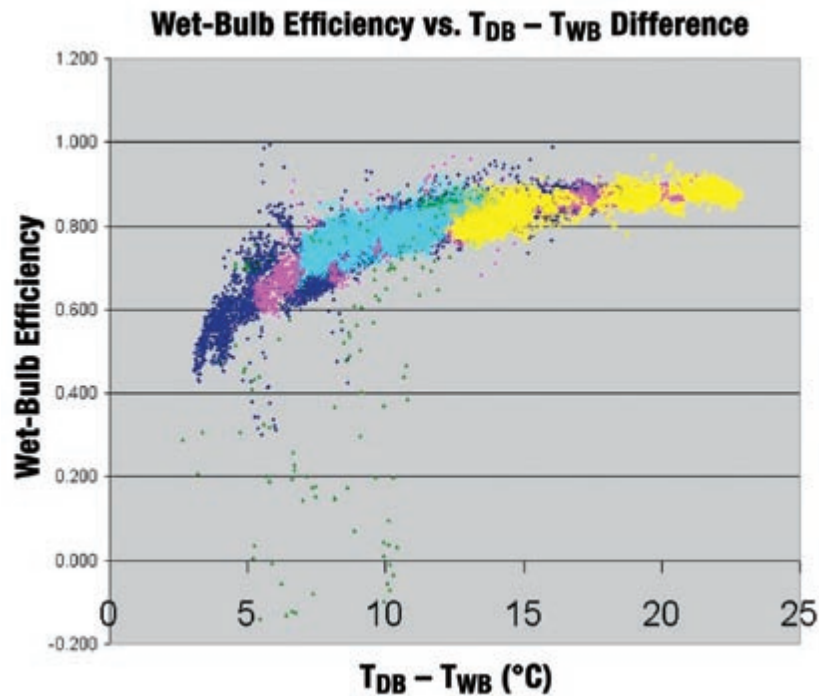

Figure 14. Wet-bulb efficiency rating versus wet-bulb temperature depressions. Note: Different colors represent different air mixtures and dates. Source: Data collected at NREL’s Thermal Test Facility, 2003–2004.

<sup>3</sup> Table 1B Cooling and Dehumidification Design Conditions, Chapter 27.7 – Climatic Design Information, 2001 ASHRAE Handbook Fundamentals.

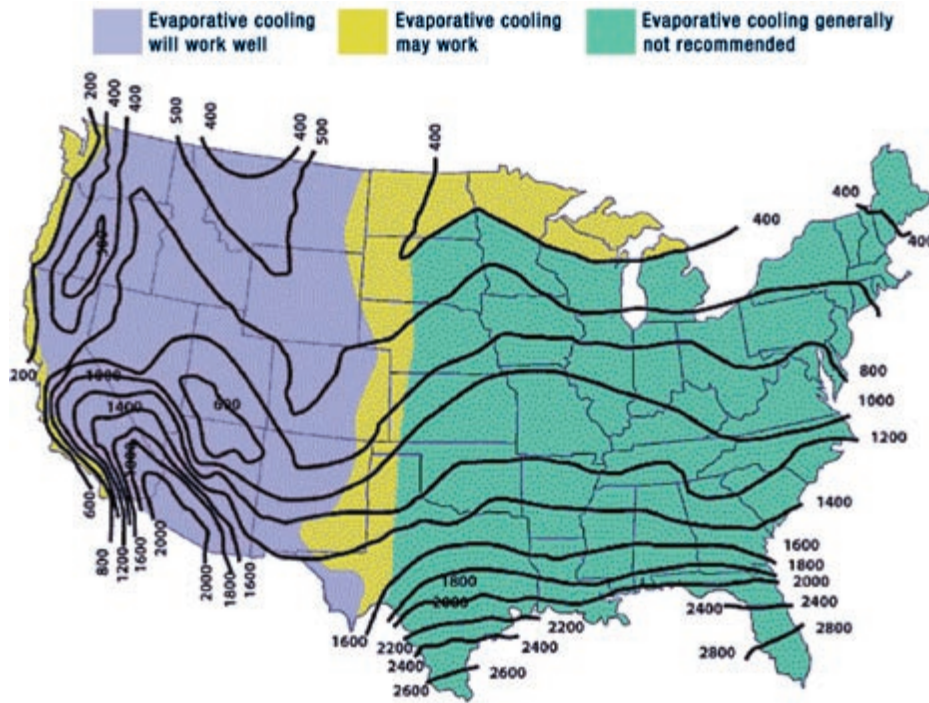

Figure 15. Map of summer cooling load hours. Source: ARI Unitary Directory, August 1, 1992, to January 31, 1993, pp. 16-17; Air-Conditioning and Refrigeration Institute, [www.energyexperts.org/ac\\_calc/default.asp](http://www.energyexperts.org/ac_calc/default.asp).

tions during the cooling season. The map in Figure 15 provides a color-coded graphical indication of where and how a direct evaporative cooler will be most effective. The Coolerado Cooler will work as well or better as a direct evaporative cooler does in the same regions but also in other regions, because it does not add moisture to the supply air. The map also shows the average number of summer cooling hours per year.

The purple area indicates regions in which this technology and direct evaporative coolers should work well in stand-alone applications. The large green area indicates regions in which the Coolerado Cooler has the potential to significantly reduce cooling energy

consumption if it is used to precool the air entering conventional vapor compression systems. Direct evaporative systems cannot be used in a similar manner in these conditions because they provide little cooling to moist air. The Coolerado Cooler is suitable for use throughout the country, though different configurations and energy savings are applicable in different climates.

### Water Use Issues

Water is used in both evaporative cooling and in ultracoolers such as the Coolerado Cooler and OASys systems. A significant amount of water is also used in thermal electric power plants to generate the electricity required to power

a conventional air conditioner. Reducing the amount of electrical energy consumed for cooling can thus also reduce the amount of water consumed, from the power plant to the cooled space.

The exact amount of water consumed in generating electricity varies, depending on the fossil fuel used (natural gas-fired plants use less water than coal-fired plants) and the type of conversion technology employed (combined-cycle power plants use less water than steam plants do). Generating a kilowatt-hour (kWh) of electricity at a new coal plant in the Southwest uses about 0.67 gallons (gal) (2.5 liters [L]) of water, while a new natural-gas-fired plant consumes about 0.33 gal (1.2 L) of water per kWh generated.<sup>4</sup> The national weighted average for thermoelectric and hydroelectric water use is 2.0 gal (7.6 L) of evaporated water per kWh of electricity consumed at the point of use.<sup>5</sup> The impact varies by the source—either surface water or groundwater. Water diverted or withdrawn is water removed from streams, groundwater, or other sources. Much of this water is consumed through use. The remainder returns to the local surface or groundwater system and is available for subsequent use downstream of its discharge.<sup>6</sup>

A conventional residential air-conditioning system does not consume water at the place where it delivers conditioned air if it has an air-cooled condenser. Most commercial HVAC systems include a wet cooling tower, which evapo-

<sup>4</sup> *The New Mother Lode: The Potential for More Efficient Electricity Use in the Southwest*, SWEET, 2002.

<sup>5</sup> Torcellini, P., Long, N., and Judkoff, R. *Consumptive Water Use for U.S. Power Production*, National Renewable Energy Laboratory, U.S. Department of Energy, December 2003.

<sup>6</sup> *The Last Straw: Water Use by Power Plants in the Arid West*, Clean Air Task Force, The Land and Water Fund of the Rockies, The Energy Foundation, and The Hewlett Foundation, April 2003.

Cooling system	Load determination	Operating characteristics	Cost parameters
Conventional air conditioning systems	<ul style="list-style-type: none"> <li>Based on all building thermal loads i.e., solar gains, building materials, internal gains by people, machines, appliances, etc.</li> </ul>	<ul style="list-style-type: none"> <li>Supply air can be heated or cooled to remove or add moisture</li> <li>Supply air made very cool then mixed with return air</li> <li>Cycles on and off between set points</li> <li>Low CFM</li> <li>High power consumption</li> </ul>	<ul style="list-style-type: none"> <li>installed cost per ton \$900–\$1,800/ton</li> <li>Power per ton 900–1,500 W/ton</li> </ul>
Direct evaporative coolers	<ul style="list-style-type: none"> <li>Size to blow enough air across wetted medium to evaporate water into the air thereby cooling it</li> <li>Based on square footage of building and air changes per hour for occupancy type</li> </ul>	<ul style="list-style-type: none"> <li>High CFM — delivers cool air with enough velocity to provide sensible cooling to building occupants</li> <li>Open system — windows or exhaust vents must be open</li> <li>Runs continuously during occupied hours with a cooling load</li> <li>Needs periodic bleed-off to avoid mineralization</li> <li>Low power consumption</li> </ul>	<ul style="list-style-type: none"> <li>Installed cost/ton \$280–\$670/ton</li> <li>Power per ton 250–400 W/ton</li> </ul>
Coolerado Coolers	<ul style="list-style-type: none"> <li>Sized based on square footage, thermal load, ambient air conditions</li> <li>Sized to about twice the CFM of air conditioning</li> </ul>	<ul style="list-style-type: none"> <li>Delivers cool air at moderate CFM</li> <li>High volume of moist air exhaust</li> <li>Low power consumption</li> <li>Constant low volume bleed-off</li> <li>Secondary/working air moisture (water) is exhausted from building</li> </ul>	<ul style="list-style-type: none"> <li>Installed cost per ton \$900–\$1,100/ton</li> <li>Power per ton 220–260 W/ton</li> </ul>

Table 2. Comparison of load, operating, and cost parameters for small office coolers.

Source: Compilation from R.S. Means Mechanical Cost Data 2005 and manufacturers' data sheets

rates the water. However, water associated with the generation of electricity used for cooling also needs to be accounted for in order to make a meaningful comparison of cooling methods. For both a direct evaporative cooler and ultracoolers, the electricity consumed in providing cooled air needs to be accounted for as well as on-site water consumed during the evaporation process.

A study of 46 residences in Phoenix, Arizona, found that direct evaporative coolers consumed about 4.4 gallons per hour (gal/hr) (16.7 L/hr) of water during operation without bleed-off and about 10.4 gal/hr (39.4 L/hr) with bleed-off<sup>7</sup> for an average of about 7.6 gal/hr (28.8 L/hr) for all systems. Bleed-off cycles, which flush

water through the evaporative medium, are often used to minimize mineral build-up on the medium. The Coolerado Cooler employs a small continual flow, rather than bleed-off cycles, to prevent mineral build-up. It uses about 10 gal/hr (37.9 L/hr) during peak operation and averages about 3.5 gal/hr (13.2 L/hr) during the entire cooling season.<sup>8</sup>

Chiller plants in larger commercial HVAC systems use water to remove heat from air and equipment. A general rule of thumb for water usage is 2 to 3 gal/ton (7.6 to 11.4 L per ton) of cooling.<sup>9</sup>

## Economic and Performance Data

Conventional air-conditioning systems, direct evaporative coolers, and ultracoolers all have different sizing, operational, and cost parameters (Table 2). Meaningful comparisons are difficult to make, because of the lack of conversion factors between systems designed to operate on different principles and data. This is especially true for a technology that is still fairly new and deployed in relatively small numbers in various locations with different environments. One cannot simply compare one system with another in a different location, or even in the same location in different ambient conditions, because the sizing and operating

<sup>7</sup> *Evaporative cooler water use*, Karpiscak, M.; Marion, M.; Arizona Cooperative Extension, <http://ag.arizona.edu/pubs/consumer/az9145.pdf>; 1994.

<sup>8</sup> Telephone conversation with R. Gillan, February 2006.

<sup>9</sup> *Evaluating and Improving Chiller Plant Efficiency*, Trane Corporation, [www.trane.com/commercial/issues/environmental/short.asp](http://www.trane.com/commercial/issues/environmental/short.asp), 2006.

parameters would yield different results. Unlike other building energy systems, ultracoolers are not yet readily modeled in terms of their energy use using currently available tools.

Because it is a relatively new technology, the Coolerado Cooler has not been the subject of a widespread study and has not undergone significant independent review, except as discussed earlier in this report. Consequently, the manufacturer has had to supply some of the economic and performance data.

Both direct evaporative coolers and the Coolerado Cooler consume 25% to 40% as much power as vapor compression air-conditioning systems do. The installed cost for the Coolerado Cooler can be 2 to 3 times higher than that of direct evaporative coolers, but it is either less expensive than most vapor compression air-conditioning systems or cost-competitive with them.

### Summary and Conclusions

The Coolerado Cooler technology can reduce cooling energy. Like other energy efficiency strategies, it can help Federal agencies, reach the energy-use reduction goals of EPA Act 2005, particularly in the western United States. This technology also has the potential to have a significant impact on an agency's energy bills in terms of reducing both energy and demand costs. Widespread deployment of this technology in average to dry climates in the United States could have a significant positive impact on electric demand and ease the burden on the utility grid. An added benefit is that no refriger-

ants are used in the cooling process.

The Coolerado Cooler can have the greatest impact on demand charges and cost and energy savings when peak demand is greatest. During the cooling season, these are the hottest times of the day; they are also times when air-conditioning loads are highest and power plant efficiencies are lowest. It performs best during those times and provides the benefits of cool, fresh, dry air at a much lower cost than that of a conventional air conditioner.

## Glossary of Terms

### Psychrometric Terms

*Dew-point temperature:* The temperature at which moisture in the air will condense on surfaces; HVAC designers work to avoid condensation on building surfaces and equipment. From a given dry- or wet-bulb temperature, move horizontally to the left on the psychrometric chart to find the lower temperature at which condensation will occur with no

change in water content [ $T_{Dew}$  measured in  $F^{\circ}$ ].

*Dry-bulb temperature:* The inside air temperature measured by a thermometer. These temperatures are shown as vertical lines on the psychrometric chart [ $T_{DB}$  measured in  $F^{\circ}$ ].

*Humidity ratio:* The ratio of the mass of water vapor to the mass of dry air in a moist-air mixture [ $W$  is the symbol used, measured as a decimal ratio].

*Psychrometrics* is the study of the thermodynamic properties of moisture content in atmospheric air. It is used in the design and analysis of performance for a wide variety of processes that involve warming or cooling air, which always contains some moisture. The amount of this moisture has a direct effect on the health and comfort of occupants. HVAC system designers and operators use *psychrometric analysis* techniques with *thermodynamic* properties and principles to optimize health and comfort levels within occupied spaces.

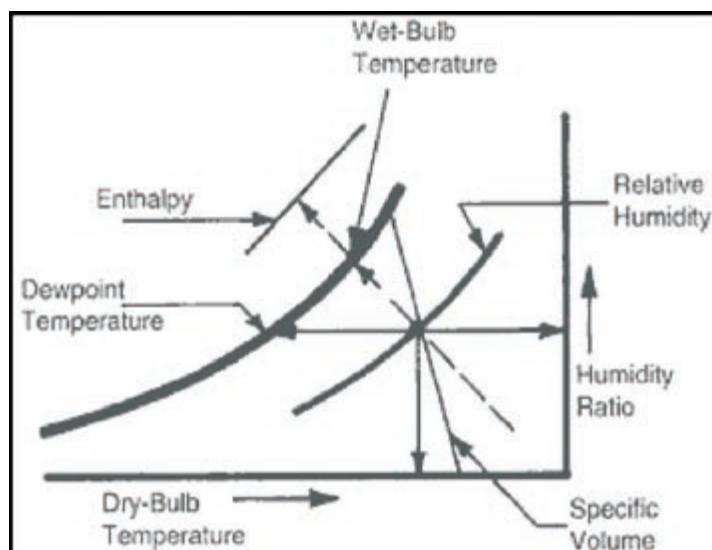

Figure G-1. Key properties measured in a psychrometric chart. Source: [http://www.sp.uconn.edu/~mdarre/NE-127/NewFiles/psychrometric\\_inset.html](http://www.sp.uconn.edu/~mdarre/NE-127/NewFiles/psychrometric_inset.html)

*Relative humidity:* The measure of the moisture content of a mixed airstream (dry air and water vapor) relative to the amount of moisture in saturated air at the same temperature. These curved lines are bounded by the dew-point curve, which is also 100% relative humidity [RH, often denoted by the symbol  $\phi$ , is measured in percent].

*Wet-bulb temperature:* An intermediate quantity that informs the HVAC designer about the moisture content in air, it is measured with a thermometer with a wetted wick and a specified airflow over that wick. It represents the maximum thermodynamic cooling that can be achieved before condensation. These are shown as diagonal lines moving up and to the left in a psychrometric chart and decreasing in temperature (cooling) [ $T_{WB}$  measured in  $F^\circ$ ].

## Cooling Equipment Terms

*Cooling capacity:* This is a measure of the amount of air (mass) being cooled per unit time, its specific heat capacity, and the change in temperature achieved. Typical units are in tons of cooling provided; 1 ton of cooling is equivalent to 12,000 Btu/hr of heat removed from a space.

*EER (energy efficiency ratio):* This is a measure of the instantaneous efficiency of a room air conditioner and is calculated by dividing the cooling capacity (Btu/hr) at an outdoor temperature of 95°F and

## Cooling calculation parameters:

- A ton of refrigeration is defined as the cooling power of one short ton (2000 lb or 907 kg) of ice melting in a 24-hour period.
- 1 ton of cooling equals 12,000 Btu/hr, or 3510 W.
- It takes 1 Btu to raise the temperature of 1 lb of water 1°F.
- It takes approximately 1000 Btu to evaporate 1 lb of water and approximately 8700 Btu to evaporate 1 gal of water.
- It takes 0.24 Btu to raise the temperature of 1 lb of air 1°F.
- 1 lb of air occupies 13.7 ft<sup>3</sup> of space at sea level when the temperature is 75°F.

50% RH by the power consumed (in watts [W]) in order to meet indoor requirements of 80°F and 50% RH. The resulting unit for EER is Btu/hr/W. Higher EERs are more efficient. The EER indicates peak performance on the hottest days.<sup>10</sup> The minimum required Energy Star® EER rating for a room air conditioner is 9.4 or greater. For an 8,000 to 13,999 Btu/hr capacity air conditioner without louvers, the Energy Star requirement specifies a minimum EER of 10.8. Energy Star EER requirements vary between 9.4 and 10.8 for other configurations and capacity sizes.

*SEER (seasonal energy efficiency ratio):* This is a measure of the seasonal efficiency of an air conditioner through the entire cooling season at a specific outdoor temperature (82°F), accounting for seasonal temperature variations. It is calculated by dividing the seasonal cooling energy (Btu) by the seasonal electrical energy

consumed (kWh). The result, in units of Btu/kWh, indicates seasonal performance. Higher SEERs are more efficient. A SEER of 13.0 or greater is required for Energy Star qualification. SEERs will always be higher than EERs for a given piece of cooling equipment because they are tested at less extreme or less rigorous conditions.<sup>11</sup>

## Acknowledgments

This publication was written by Robi Robichaud of the NREL FEMP Technical Assistance Team. The author wishes to thank the following for their valuable contributions: Ben Barnes, Mike Brandemuehl, Sheila Hayter, Erik Kozubal, Steve Slayzak, Vern Smith, Otto Van Geet, and Andy Walker. This analysis was funded by the U.S. Department of Energy, Office of Energy Efficiency and Renewable Energy, Federal Energy Management Program.

<sup>10</sup> Buying an Air Conditioner? Remember the EER. Pacific Gas and Electric, 2006, [www.pge.com/docs/pdfs/res/rebates/central\\_air/03eer\\_tech\\_v3.pdf](http://www.pge.com/docs/pdfs/res/rebates/central_air/03eer_tech_v3.pdf).

<sup>11</sup> Buying an Air Conditioner? Remember the EER. Pacific Gas and Electric, 2006, [www.pge.com/docs/pdfs/res/rebates/central\\_air/03eer\\_tech\\_v3.pdf](http://www.pge.com/docs/pdfs/res/rebates/central_air/03eer_tech_v3.pdf).



## Log on to FEMP's Web site for information about New Technology Demonstrations

[www.eere.energy.gov/femp/](http://www.eere.energy.gov/femp/)

### You will find links to

- A New Technology Demonstration Overview
- Information on technology demonstrations
- Downloadable versions of publications in Adobe Portable Document Format (pdf)
- A list of new technology projects under way
- Electronic access to a regular mailing list for new products when they become available
- How Federal agencies may submit requests to us to assess new and emerging technologies

### Disclaimer

This report was sponsored by the United States Department of Energy, Energy Efficiency and Renewable Energy, Federal Energy Management Program. Neither the United States Government nor any agency or contractor thereof, nor any of their employees, makes any warranty, express or implied, or assumes any legal liability or responsibility for the accuracy, completeness, or usefulness of any information, apparatus, product, or process disclosed, or represents that its use would not infringe privately owned rights. Reference herein to any specific commercial product, process, or service by trade name, trademark, manufacturer, or otherwise does not necessarily constitute or imply its endorsement, recommendation, or favoring by the United States Government or any agency or contractor thereof. The views and opinions of authors expressed herein do not necessarily state or reflect those of the United States Government or any agency or contractor thereof.

### A Strong Energy Portfolio for a Strong America

Energy efficiency and clean, renewable energy will mean a stronger economy, a cleaner environment, and greater energy independence for America. Working with a wide array of state, community, industry, and university partners, the U.S. Department of Energy's Office of Energy Efficiency and Renewable Energy invests in a diverse portfolio of energy technologies.

### For More Information

EERE Information Center  
1-877-EERE-INF or  
(877-337-3463)  
[www.eere.energy.gov/femp/](http://www.eere.energy.gov/femp/)

### General Contacts

#### Will Lintner

Team Lead, RSTT  
Federal Energy Management Program  
U.S. Department of Energy  
1000 Independence Ave, SW, EE  
Washington, DC 20585  
Phone: (202) 586-3120  
Fax: (202) 586-3000  
[william.lintner@ee.doe.gov](mailto:william.lintner@ee.doe.gov)

#### Steven A. Parker

Pacific Northwest National Laboratory  
P.O. Box 999, MSIN: K5-08  
Richland, WA 99352  
Phone: (509) 375-6366  
Fax: (509) 375-3614  
[steven.parker@pnl.gov](mailto:steven.parker@pnl.gov)

### Technical Contact

#### Robi Robichaud

National Renewable Energy Laboratory  
MS 1534  
1617 Cole Boulevard  
Golden, CO 80401  
Phone: (303) 384-7553  
Fax: (303) 384-7411  
[robi\\_robichaud@nrel.gov](mailto:robi_robichaud@nrel.gov)

Produced for the U.S. Department of Energy, Energy Efficiency and Renewable Energy, by the National Renewable Energy Laboratory

DOE/GO-102007-2325  
June 2007

