

Accelerator Development Department

Brookhaven National Laboratory
Associated Universities, Inc.
Upton, New York 11973

RHIC Technical Note No. 21

Magnets for RHIC

E. H. Willen

May 1986

MAGNETS FOR RHIC

E. H. Willen
 Brookhaven National Laboratory
 Upton, N.Y. 11973

The Relativistic Heavy Ion Collider (RHIC) is a proposed research facility (1) at Brookhaven National Laboratory for the study of extreme states of matter. By colliding two beams of ions, up to gold in mass and at energies up to 100 GeV/amu, high energy density will be achieved within the nuclei of the colliding ions, leading to a variety of fundamental effects not heretofore observed. The physics to be explored by this Collider is an overlap between the traditional disciplines of nuclear physics and high energy physics. The machine is proposed for construction in the now-empty tunnel built for the former CBA project. In addition to the tunnel, various other facilities needed for the machine are in place, including experimental halls, a beam transfer tunnel from the AGS, and a refrigerator for providing cryogenic helium. Soon to be commissioned is a beam line to carry heavy ions from the BNL Tandem Van de Graaff to the AGS, and a Booster (321 MeV/amu for gold) for the capture and acceleration of the ions prior to injection into the AGS is under construction. Though direct injection into the AGS will be possible, the Booster is necessary to efficiently capture and accelerate the heavier ion species. The AGS will then accelerate the ions (up to 10.7 GeV/amu for gold) prior to injection into the

Collider. Figure 1 shows the layout of the RHIC project on the laboratory site.

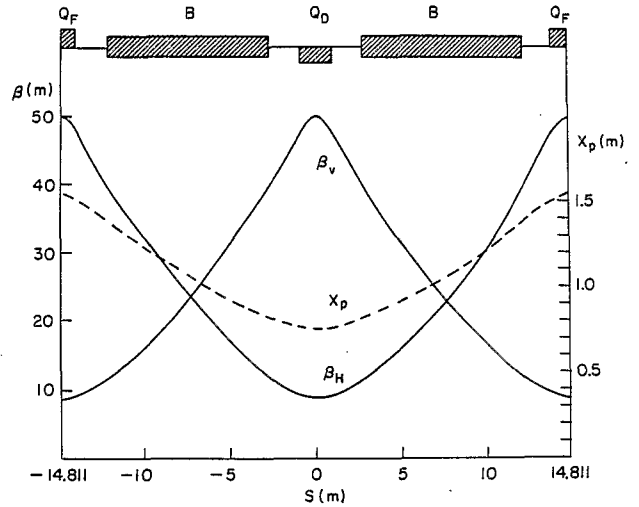

Figure 2. RHIC Regular Arc Cell.

The Collider, including the magnets, is in an advanced state of design. Figure 2 shows the layout of the basic RHIC regular arc cell. Seventy-two such cells are required to complete one ring. The lattice of magnets chosen in the design reflects the need for strong focussing to maintain a small beam size while coping with the severe intrabeam scattering of heavy ion beams. Each cell is 29.622 m long; it deflects the beam by 77.7 mrad and has a betatron phase advance of 90°.

The layout of the magnets to bring the beams into collision is shown in Fig. 3. Crossing angles from zero to several milliradians are allowed. Because of the need to accommodate both a range of energies and different ion species, from protons to gold, several special large dipole and quadrupole magnets are required near the collision point. Otherwise, the magnets in these intersection regions have characteristics similar to those in the regular arcs.

The characteristics of the dipole and quadrupole magnets required for the arcs and for the intersection regions are given in Table 1. Table 2 lists the total complement of magnets required in the machine, including the sextupole and multipole correctors located at each of the quadrupole magnets. Current plans are for 10-20% of these magnets to be built at Brookhaven and the rest to be built in industry over a 4-year construction period.

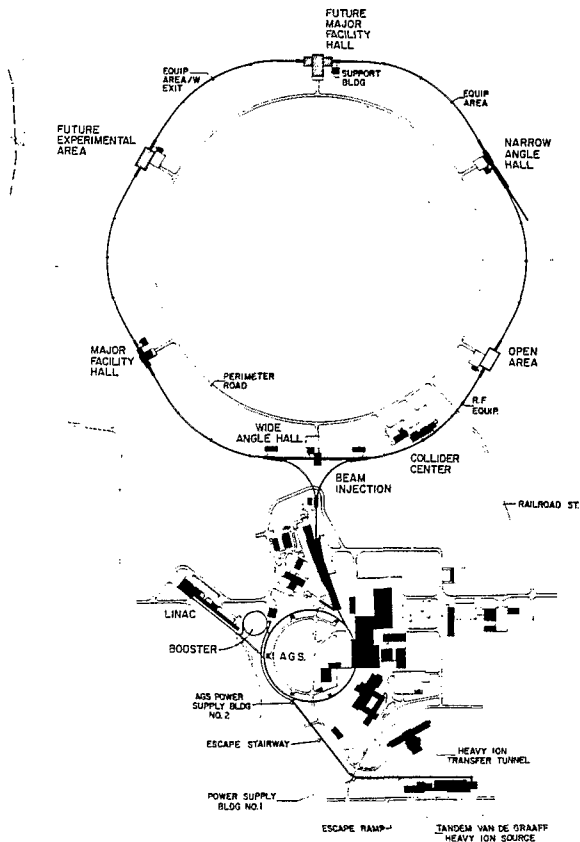

Figure 1. Site Map for RHIC.

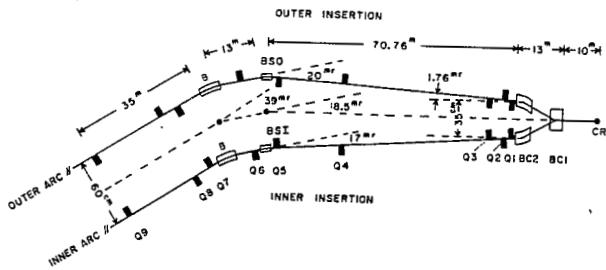

Figure 3. Magnet Layout in the Intersection Regions.

Table 1. Characteristics of the Arc and Intersection Region Dipoles and Quadrupoles for RHIC (100 GeV/amu Operation)

Magnet	Coil ID (mm)	Effective Length (m)	Field or Gradient
Arc			
dipole	80	9.475	3.45 T
quadrupole	80	1.18	71.4 T/m
Intersection dipoles			
BC1	200	3.3	4.63 T
BC2	100	4.4	2.73 T
BS Inner	80	3.57	3.45 T
BS Outer	80	5.46	3.45 T
B	80	9.46	3.45 T
quadrupoles			
Q1-Q3	130	1.34-2.21	57.4 T/m
Q4-Q9	80	1.03-1.74	67.4 T/m

Table 2. RHIC Magnet Inventory

<u>Regular Arcs</u>	
Dipoles	288
Quadrupoles	276
Sextupoles	276
Correctors	276
<u>Intersection Regions</u>	
<u>Standard Aperture Magnets</u>	
Dipoles	48
Quadrupoles Q4-Q9	144
Sextupoles @ Q9	12
Correctors	144
<u>Large Aperture Magnets</u>	
Dipoles (BC1)	12
Dipoles (BC2)	24
Quadrupoles (Q1-Q3)	72
Correctors	72
Skew quadrupoles @ Q2 or Q3	24
<u>Totals</u>	
Dipoles	372
Quadrupoles	492
Sextupoles	288
Correctors	492
Skew quadrupoles	24

Although there are less dipoles than there are quadrupole and corrector magnets, the arc dipoles nevertheless remain the dominant cost item in the machine. For this reason, the R&D effort has focussed on this device. Various models have been built, including four in industry, culminating in a half-length model with prototype cross section that was built and tested in the past year.

A cross section of the current dipole coil design is shown in Fig. 4. It has a single layer

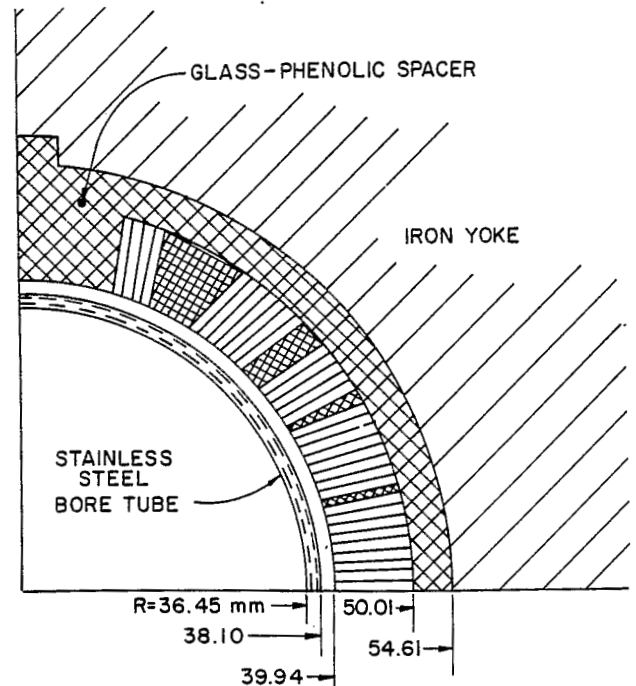

Figure 4. RHIC Dipole Coil Cross Section.

superconducting coil designed to provide the required 3.45 T bending field for 100 GeV/amu ions with a generous margin of safety. The superconductor used is the same as that used for the outer coil of the Superconducting Super Collider (SSC). Figure 5 shows a cross sec-

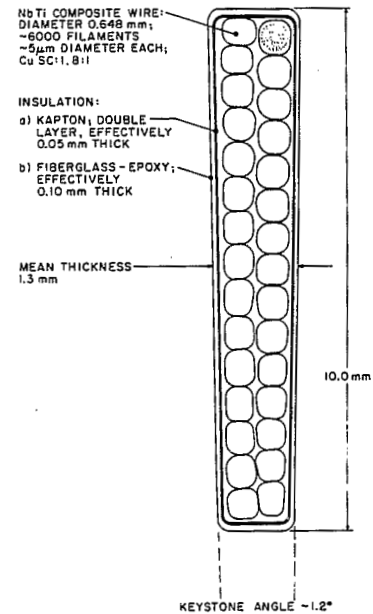

Figure 5. Cross Section of RHIC Superconductor Cable.

tion of this superconductor in its cabled form. Prestress is applied to the coil directly by the iron yoke through a 5 mm thick insulator-spacer surrounding the coil. The relatively close iron leads to some iron saturation field effects at high field that must be corrected with the lumped corrector magnets located at each quadrupole. There are no internal trim coils in these magnets. The 10 m long magnets are assembled in fixtures that introduce the required 47 mm sagitta during the construction process. The sagitta is locked in place via the outer stainless steel weldment, which also serves as the helium pressure vessel. The cold mass is supported in a cryostat with folded, insulating posts (originally designed by FNAL for the SSC) (2), as shown in Fig. 6. The

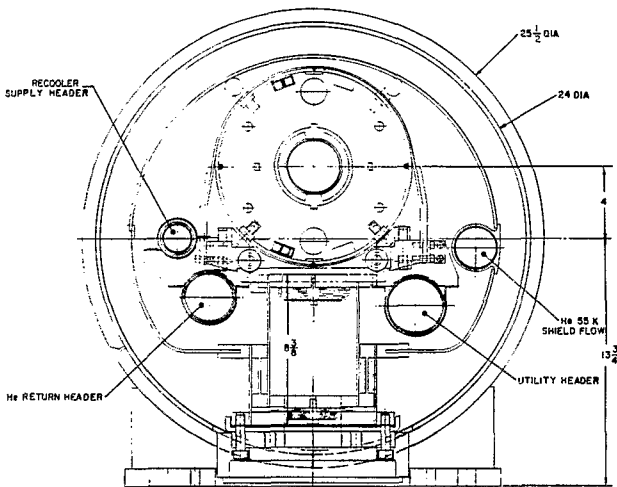

Figure 6. Cross Section of RHIC Dipole in Cryostat.

primary design parameters for the dipole magnet and the superconductor used in its construction are given in Table 3.

Table 3. Basic Arc Dipole and Superconductor Parameters

Dipole Parameters	
B, minimum operation	0.24 T
B, 100 GeV/amu	3.45 T
B, quench	4.6 T
Current for 100 GeV/amu operation	4.56 kA
Inductance	43 mH
Stored energy at 100 GeV/amu operation	490 kJ
Length, effective	9.460 m
Sagitta	47.2 mm
Coil, number of superconducting turns	33
Coil inner radius	39.9 mm
Iron outer radius	133.3 mm
Superconductor Parameters	
Cu/SC ratio	1.8:1
Wire diameter	0.648 mm
Critical current density @ 5T, 4.2 K	2400 A/mm ²
Number of wires in cable	30
Width of cable	9.73 mm
Mid-thickness of cable	1.16 mm
Keystone angle	1.2 deg.

The performance of the half-length model constructed and tested during the past year was excellent. Figure 7 shows the training history of

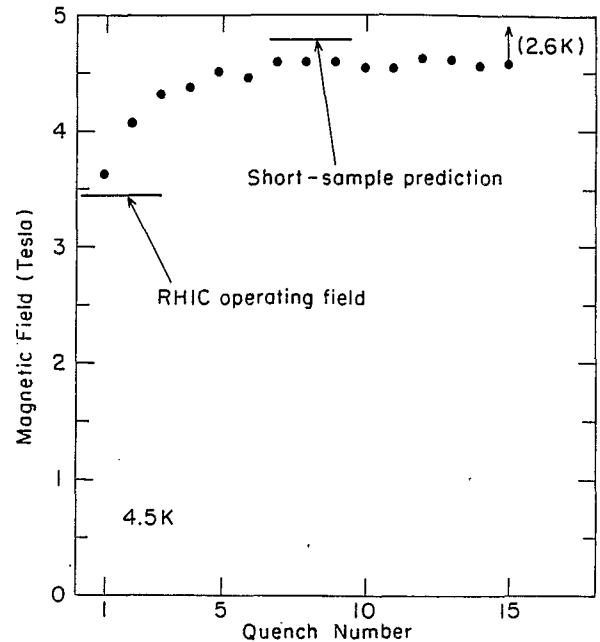

Figure 7. Training History of Prototype RHIC Dipole Magnet.

the magnet. The first quench was above the required operating field and after several additional quenches, the magnet's field reached a level near its short sample limit. It is expected that future magnets will reach a somewhat higher field because of continuing improvements in the current capacity of the superconductor and improved cable fabrication.

The measured transfer function, sextupole harmonic and decapole harmonic are shown in Fig. 8. The large magnetization evident in the harmonics at low field is due to the large filament size (20 μ m) in the superconductor used for this magnet. Future magnets are expected to benefit from the reduced filament size (<5 μ m) that is being developed in the very active superconductor R&D program (3) currently underway. Table 4 lists the measured mean values of the various harmonics, including also the expected mean value and the expected magnet-to-magnet variation extrapolated from CBA experience. It is seen that the harmonics in this prototype are well within the expected error distribution.

The design for the arc quadrupoles is shown in Fig. 9. It too is a single layer magnet using the same conductor as in the dipole. Again the use of copper wedges provides the needed degrees of freedom to achieve good field quality over the aperture of the magnet. The single layer design is particularly welcome in a quadrupole magnet to reduce the number of coils that must be built and assembled. The main parameters for the quadrupole are given in Table 5.

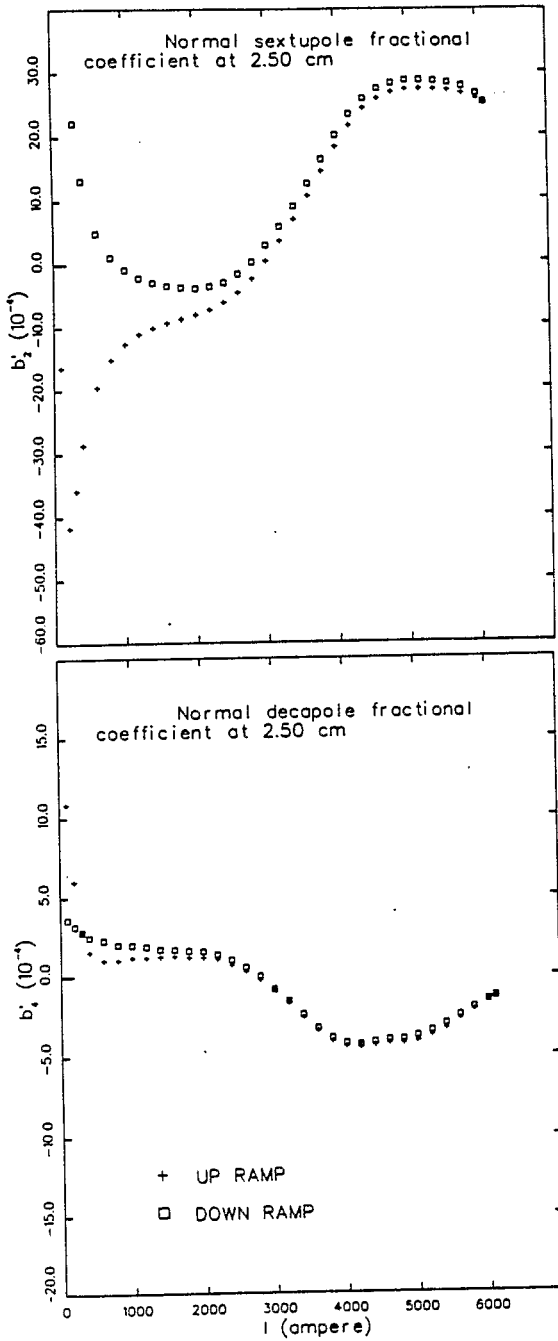

Figure 8. Measured Sextupole and Decapole Harmonics in Prototype RHIC Dipole Magnet.

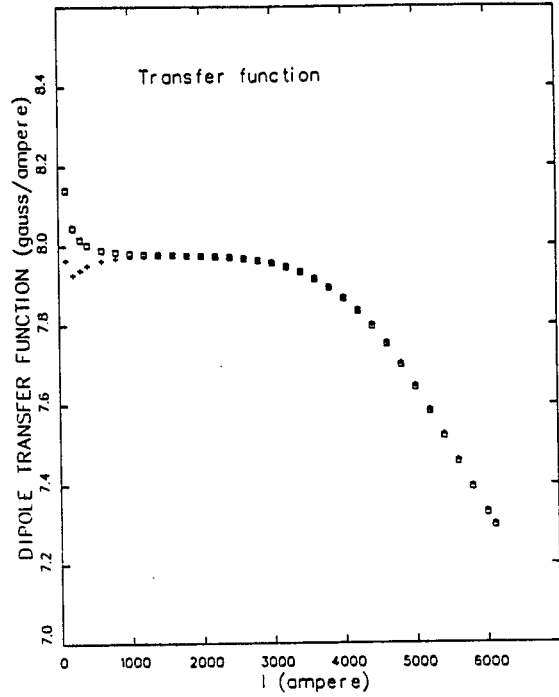

Figure 8 (cont). Measured Transfer Function in Prototype RHIC Dipole Magnet.

Table 4. Harmonics at 2.5 cm ($\times 10^{-4}$)

	Mean, Measured @ 1200 A	Mean, Expected, Including Magnetization for 20 μ m Filaments	Standard Deviation, Expected
b ₁	-0.2	-	2.1
b ₂	-11.2	-12	4.6
b ₃	-0.2	-	1.3
b ₄	1.1	-2.5	2.2
b ₅	-0.1	-	0.5
b ₆	1.1	0.8	0.8
b ₇	-0.1	-	0.2
b ₈	-0.1	-0.15	0.3
b ₉	0.3	-	0.1
a ₁	-3.8	-	4.3
a ₂	-0.8	-	1.3
a ₃	-0.3	-	2.2
a ₄	-0.2	-	0.6
a ₅	0.5	-	0.9
a ₆	-0.1	-	0.2
a ₇	0.2	-	0.3
a ₈	-0.1	-	0.1
a ₉	0.3	-	0.1

Single layer coil magnets are being specified for RHIC because the tunnel exists and the required field to achieve the design goals of the machine (100 GeV/amu) can be readily obtained in such magnets. In a study performed for the SSC, it was found that single layer magnets are at a

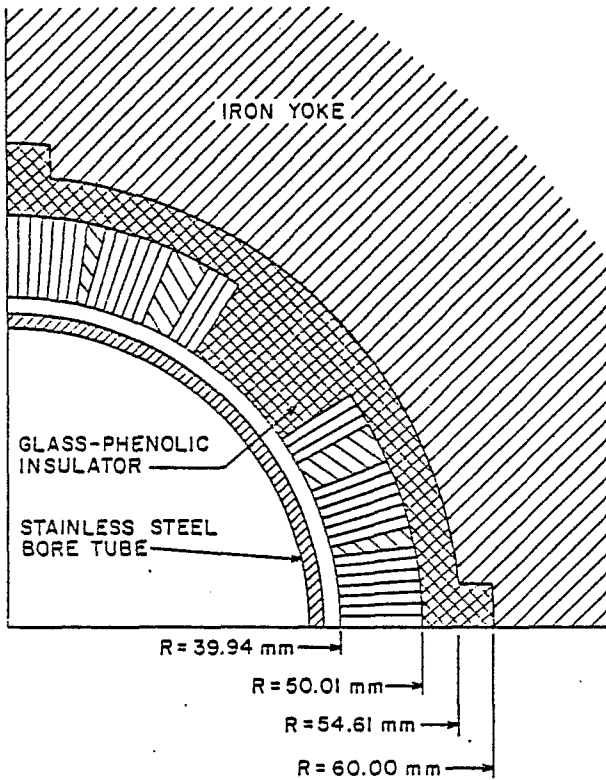

Figure 9. RHIC Quadrupole Cross Section.

Table 5. Basic Arc Quadrupole Parameters

G, minimum operation (corresponding to 0.24T in dipole)	
G, 100 GeV/amu	67.4 T/m
G, quench	108 T/m
Current for 100 GeV/amu operation	4.56 kA
Inductance	3 mH
Stored energy at 100 GeV/amu operation	20 kJ
Length, effective	1.24 m
Coil, number of superconducting turns	16
Coil, inner radius	39.9 mm
Iron, outer radius	133.3 mm

cost minimum of total magnet plus tunnel cost. This is illustrated in Fig. 10. The minimum occurs because the superconductor, which dominates the magnet cost, is less efficient in producing field in a two-layer coil design. Thus, the particular requirements of the RHIC machine have fortuitously led to a magnet design that is not only cost advantageous but also highly reliable by virtue of the relative simplicity of a single layer coil magnet.

Acknowledgement

The work reported here is mostly that of the Magnet Division of the Accelerator Development Department at Brookhaven National Laboratory. The design of the RHIC magnets has been largely carried out by Pat Thompson.

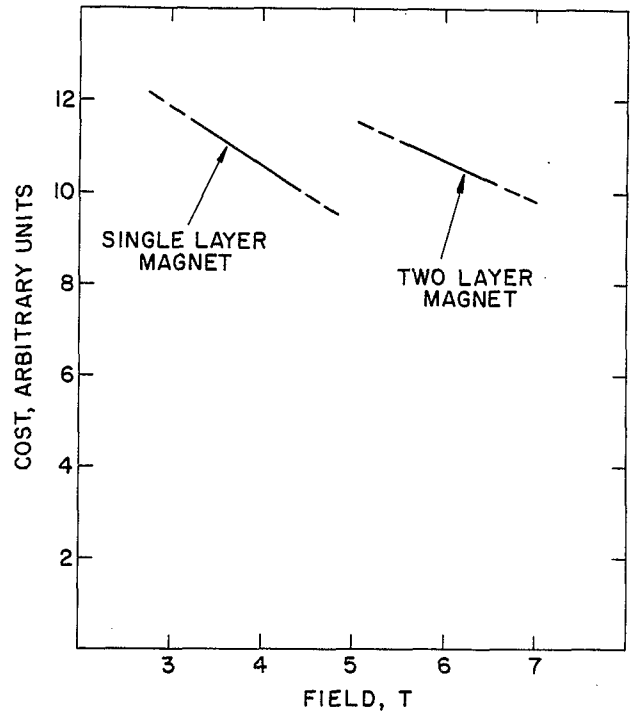

Figure 10. Relative Machine Costs, Including Tunnel, for Single Layer and Two Layer Dipole Magnets.

REFERENCES

- 1 Proposal for a Relativistic Heavy Ion Collider, BNL 51932, (March 1986).
- 2 R.C. Niemann et al., "Design, Construction and Performance of a Post Type Cryogenic Support," Adv. Cryo. Engr. 31 (1986) Plenum Press, New York (to be published).
- 3 A.F. Greene, D.C. Larbalestier, W.B. Sampson, R. Scanlon, BNL SSC Technical Note 39 (June 1985).