

The Scenarios Approach to Attenuation-Based Remedies for Inorganic and Radionuclide Contaminants

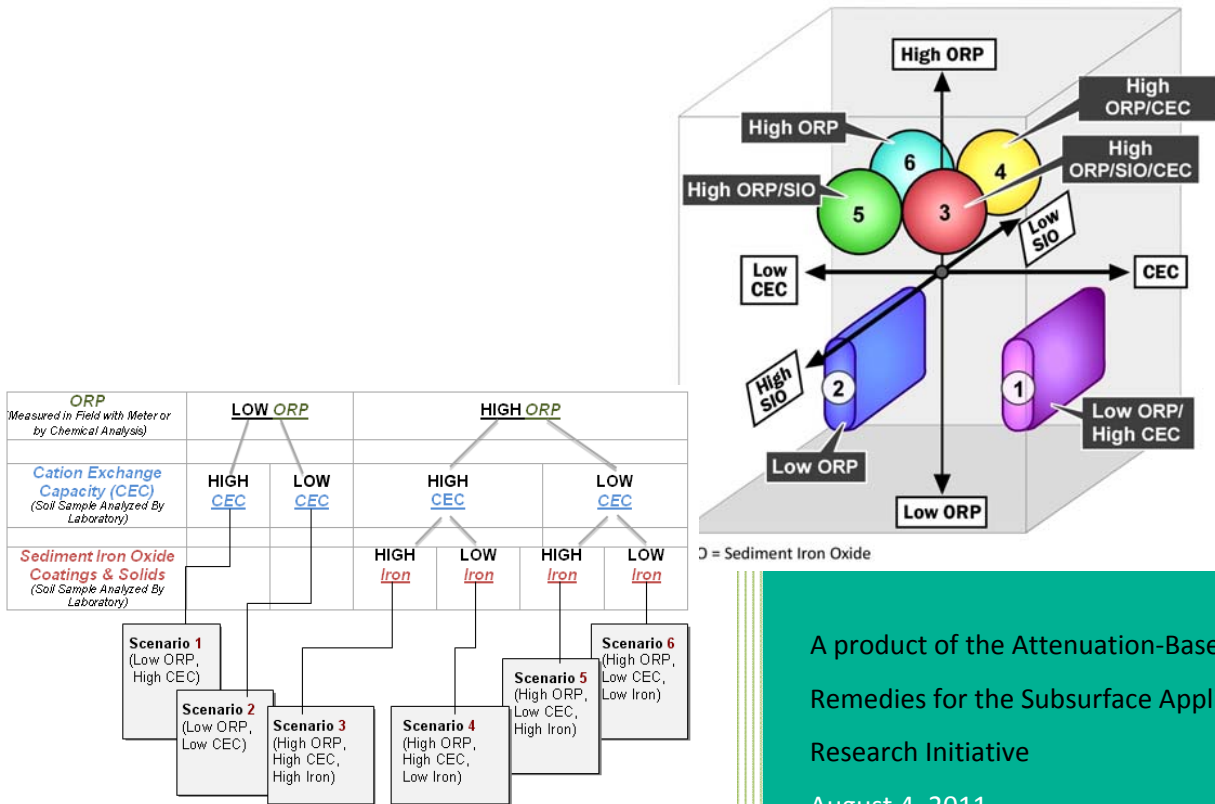

A product of the Attenuation-Based Remedies for the Subsurface Applied Field Research Initiative

August 4, 2011

Savannah River National Laboratory
 Savannah River Nuclear Solutions, LLC
 Savannah River Site
 Aiken, SC 29808

Prepared for the U.S. Department of Energy Under
 Contract Number DE-AC09-08-SR22470



DISCLAIMER

“This report was prepared by Savannah River Nuclear Solutions, LLC (SRNS) for the United States Department of Energy under Contract No. DE-AC09-08SR22470 and is an account of work performed under that contract. Neither the United States Government nor any agency thereof, nor any of their employees, nor any of their contractors, subcontractors or their employees assume any legal liability or responsibility for any third party’s use of the results of such use of any information, apparatus, product, or process disclosed, or represent that its use would not infringe privately owned rights. Reference herein to any specific commercial product, process or services by trademark, name, manufacturer or otherwise does not necessarily constitute or imply endorsement, recommendation, or favoring of same by SRNS or the United States Government or any agency thereof.”

Printed in the United States of America

**Prepared for
U.S. Department of Energy**

Forward

“The Scenarios Approach to Attenuation-Based Remedies for Inorganic and Radionuclide Contaminants” is a technical resource to guide waste site owners, regulators, stakeholders, or other interested parties through the process of evaluating attenuation-based remedies for sites contaminated with inorganic or radionuclide contaminants. It is a product of the Attenuation-Based Remedies for the Subsurface Applied Field Research Initiative led by the Savannah River National Laboratory and funded through the U.S. Department of Energy’s Office of Environmental Management.

The scenarios approach exploits important traits that waste sites may have in common that allow them to be grouped into six categories or scenarios. The common traits of each scenario are parameters or characteristics that are important to attenuation of inorganic and radionuclide contaminants. A single waste site may host multiple scenarios, each occurring in different segments of a contaminant plume or predicted to occur at different points in time during the evolution of the waste site.

There are three sections to the document:

Scenarios User Guide – steps the reader through using the scenarios approach, including how to choose a scenario, a discussion of the parameters on which the scenarios are based, and using worksheets to organize data

Scenarios – discusses specific attenuation processes affecting contaminant mobility, shows how to use a scenario to develop a site conceptual model, discusses how to apply monitored natural attenuation (MNA) and enhanced attenuation (EA) to specific scenarios, and ties the scenarios approach to the US Environmental Protection Agency’s (EPA) four tiers of evidence (EPA, 2007a) for demonstrating MNA

Scenarios Evaluation Guide – provides detail on attenuation mechanisms and development of conceptual models, discusses the EPA four tiered approach in more detail, and includes important additional information on geochemical reactions, monitoring, remediation, and costs

The six scenarios are based on aquifer geochemical properties. The three properties that define a scenario are oxidation-reduction potential, cation exchange capacity, and ferric iron oxide content.

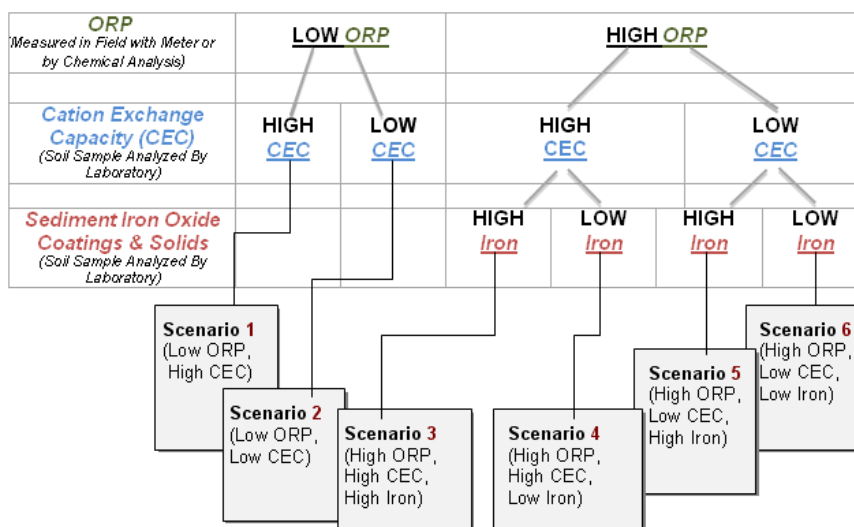

Primary and secondary modifying factors are considered as well. Primary modifying factors are chemical parameters associated with the groundwater -- pH, total dissolved solids, and sulfur species. Secondary modifying factors are facilitated transport mechanisms, source type, as well as hydrology and travel time to receptors. There is extensive discussion in the document on how these factors affect the mobility of several common common metal, radionuclide, and inorganic contaminants.

There is also extensive discussion relating the scenarios approach to the EPA guidance on using MNA. The document recommends tasks to be performed to gather evidence for Tiers II and III, as well as tools to perform these tasks. Tools are also recommended for helping a user to meet Tier IV in the EPA guidance. The user is guided to EA methods when evidence demonstrates that MNA is not appropriate.

Throughout the document the importance of waste site evolution and understanding future geochemical conditions is stressed. The concept of using geochemical gradients to understand waste site evolution is incorporated in the scenarios approach. Considering geochemical gradients also helps organize thoughts on the behavior of contaminants in multi-contaminant plumes.

“The Scenarios Approach to Attenuation-Based Remedies for Inorganic and Radionuclide Contaminants” is intended for waste site owners, regulators, stakeholders, and other interested parties that may not be experts in geochemistry. The goal was to provide a tool that simplifies the process of evaluating sites for attenuation-based remedies, a process in which geochemistry plays a dominant role. This is not meant to encourage this type of evaluation without the involvement of experts in all of the appropriate disciplines – hydrogeology, geochemistry, microbiology, etc. Rather it is intended to promote more active participation of decision makers in the technical evaluation by providing them with a synopsis of the important information required and a framework that simplifies the process of evaluating sites for attenuation-based remedies.

The Scenarios Approach to Attenuation-Based Remedies for Inorganic and Radionuclide Contaminants

Mike Truex, Pacific Northwest National Laboratory

Pat Brady, Sandia National Laboratory

Chuck Newell and Michal Rysz, GSI Environmental

Miles Denham, Savannah River National Laboratory

Karen Vangelas, Savannah River National Laboratory

June 2011

This page intentionally left blank.

The **SCENARIOS APPROACH** to Attenuation-Based Remedies for Inorganic and Radionuclide Contaminants

- Complex Issue:** Applying attenuation-based remedies for inorganic and radionuclide contaminants is challenging because of the complexity of the attenuation mechanisms, the key role played by the underlying geochemistry, and because degradation processes do not apply to most of these contaminants.
- Lots of Science Available:** The U.S. Environmental Protection Agency (EPA) has issued a comprehensive, three-volume technical protocol for Monitored Natural Attenuation (MNA) of inorganic contaminants that explains key attenuation processes for inorganic and radionuclide compounds in groundwater. In addition, there is a growing but dispersed body of scientific data, resource tools, and new concepts for MNA.
- Scenarios: A New Interpretation** The Scenarios Approach helps you evaluate and implement attenuation-based remedies by:
- Complementing—not replacing—the EPA Technical Protocol with extensive links and references to this valuable EPA resource
 - Providing a stepwise process to quickly select the “Scenario” (conceptual model framework) for evaluating attenuation-based remedies at any site
 - Helping refine this Scenario to create a tailor-made conceptual model for a specific site
 - Explaining how inorganic contaminants behave in different types of groundwater environments
 - Providing information about how to use Enhanced Attenuation (EA) approaches when necessary to augment MNA
 - Making relevant scientific knowledge more accessible and understandable.
- Target Audience** The document is intended to be a technical resource for MNA evaluators and to foster communication between site managers, regulators, stakeholders, and technical specialists.

SCENARIOS APPROACH: Three Separate Main Sections, Three Purposes

1 Read This First:

USER GUIDE

- Explains how the Scenarios Approach works
- Shows how to select the appropriate scenario for a site based on:
 - Oxidation-reduction potential
 - Cation Exchange Capacity
 - Sediment iron oxide content
- Explains other geochemical factors impacting attenuation

2 Then Use Your Scenario:

SCENARIOS

- Explains specific attenuation processes affecting contaminant mobility that are important for the selected scenario
- Shows how to use the selected scenario to develop a site-specific attenuation-based conceptual model for a site
- Describes how to apply MNA and EA at a site
- Describes how to use the EPA tiered MNA evaluation process at a site.

3 Read This to Get More Detail:

EVALUATION GUIDE

- Provides detail about attenuation processes and contaminant mobility
- Provides detail about developing an attenuation-based conceptual model for a site
- Provides detail about the EPA-tiered MNA evaluation process
- Includes 60-plus pages of information with reactions, sorption, monitoring, remediation, costs, and more.

Table of Contents

Section 1: Scenarios User Guide	1.1
1.0 Introduction.....	1.1
2.0 Step 1: Designate Plume Segments	1.4
3.0 Step 2: Select a Scenario.....	1.6
3.1 <i>Oxidation-Reduction Potential</i>	1.7
3.2 <i>Cation Exchange Capacity</i>	1.7
3.3 <i>Sediment Iron Oxide Content</i>	1.8
4.0 Step 3: Think About Modifying Factors at the Site	1.8
4.1 <i>Primary Modifying Factors</i>	1.9
4.2 <i>Secondary Modifying Factors</i>	1.10
5.0 Step 4: Go to the Scenarios Section.....	1.16
Section 2: Scenarios	2.1
1.0 Scenario Worksheet	2.1
2.0 Summary of Scenario Characteristics	2.2
3.0 Summary of Contaminant Mobility	2.3
4.0 Actions Needed to Evaluate Attenuation-Based Remedies	2.5
4.1 <i>Initial Actions and EPA Protocol Tier I Evaluations</i>	2.6
4.2 <i>EPA Tier II and Tier III Evaluations</i>	2.9
4.2.1 <i>Tasks to Augment Tier II and III Evaluations</i>	2.10
4.2.2 <i>Tools for Tier II and III Assessment</i>	2.11
4.3 <i>EPA Tier 4 Implementation</i>	2.12
Section 3: Scenarios Evaluation Guide	3.1
1.0 Introduction and Overview	3.1
2.0 Key Concepts	3.3
2.1 <i>Reactive Facies</i>	3.5
2.2 <i>Biogeochemical Gradients</i>	3.7
3.0 The Scenarios Approach	3.10
4.0 Evaluation Guide	3.11
4.1 <i>Overview of Contaminant Mobility</i>	3.11
4.3 <i>Attenuation Conceptual Model</i>	3.16
4.3.1 <i>Physical and Flux Components of the Attenuation Conceptual Model</i>	3.16
4.3.2 <i>Contaminant Behavior Components of the Attenuation Conceptual Model</i>	3.21

Table of Contents

4.3.3 Chromium (III) and Technetium (IV)	3.24
4.3.4 Chromium (VI) and Technetium-99 (VII),.....	3.25
4.3.5 Plutonium	3.26
4.3.6 Uranium.....	3.27
4.3.7 Cadmium, Copper, Lead, Nickel, and Zinc	3.28
4.3.8 Arsenic	3.29
4.3.9 Selenium.....	3.30
4.3.10 Strontium-90, Cesium, and Radium	3.31
4.3.11 Nitrate and Perchlorate.....	3.32
4.3.12 Iodine-129.....	3.33
4.3.13 Other Potentially Important Factors	3.33
<i>4.4 Data and Plume Analysis Tools.....</i>	<i>3.34</i>
<i>4.5 Cost Considerations.....</i>	<i>3.42</i>
4.5.1 Costs for Tier I Analysis	3.42
4.5.2 Costs for Tier II Analysis	3.43
4.5.3 Costs for Tier III Analysis	3.43
4.5.4 General Cost Drivers	3.43
<i>4.6 Enhanced Attenuation</i>	<i>3.44</i>
4.6.1 Definition	3.44
4.6.2 Enhanced Attenuation Categories	3.45
<i>4.7 Source Control Versus Enhanced Attenuation</i>	<i>3.46</i>
4.7.1 Traditional Remediation Technologies for Metals/Radionuclides.....	3.47
4.7.2 Crossover Remediation Technologies for Metals/Radionuclides.....	3.48
Section 4: References	4.1
Appendix A: Synopsis of Mass Flux (Adapted from ITRC)	A.1
Appendix B: Synopsis of Mercury Chemistry	B.1
Appendix C: Synopsis of Tritium, Radon, Americium, and Thorium.....	C.1

Section 1: Scenarios User Guide

Main Objectives

- ✓ Explain how the Scenarios Approach works
- ✓ Show how to select the appropriate scenario for a site based on:
 - Oxidation-reduction potential
 - Cation Exchange Capacity
 - Sediment iron oxide content
- ✓ Explain other geochemical factors impacting attenuation
- ✓ Lay out a step-by-step approach
- ✓ Provide worksheets to organize site data

1.0 Introduction

This document is designed to help evaluate and implement attenuation-based remedies for groundwater and vadose zones contaminated with metals and radionuclides. The document is intended to be a reference tool for users with various degrees of knowledge. All users will require at least a working familiarity with the principles of soil and groundwater contamination, contaminant migration and attenuation, methods of site characterization, analytical techniques, and the *Comprehensive Environmental Response, Compensation, and Liability Act of 1980* (CERCLA) process. This document does not address policy issues for a Monitored Natural Attenuation (MNA) remedy.

Using the comprehensive information provided in the U.S. Environmental Protection Agency (EPA) technical protocol for MNA of inorganic contaminants (EPA 2007a,b; 2010; hereafter referred to as "EPA Protocol") as a starting point, this document summarizes the primary factors controlling the migration and attenuation of groundwater contaminated with metals and radionuclides. The Scenarios Approach uses a conceptual model system to facilitate evaluating MNA and/or Enhanced Attenuation (EA) processes as a site remedy. Summarized in Table 1.1 are the main differences between the EPA Protocol and Scenarios Approach document.

Starting Point for Scenarios

This Scenarios Approach document was inspired by the EPA *Technical Protocol for Monitored Natural Attenuation (MNA) of Inorganic Contaminants* released in 2007 and 2010.

Section 1: Scenarios User Guide

Table 1.1. Differences Between EPA Protocol and Scenarios Approach Document

EPA Protocol	Scenarios Approach Document
Focuses on MNA only	Encompasses MNA and EA
Comprehensive discussion of mechanisms, analysis techniques, and models related to MNA for metals and radionuclides	Provides streamlined framework for selecting a site-specific conceptual model category and identifying specific data needs
Comprehensive, multiple-volume document	Limited, but focused presentation in three documents

The Scenarios Approach provides a stepwise process to identify an appropriate “Scenario” (conceptual model category) and refine it for a specific site. Six scenarios have been identified to categorize the primary characteristics of sites with respect to MNA/EA. Subsurface characteristics at some sites are spatially variable. The Scenarios Approach uses the concept of plume segments to divide a site into distinct segments if the geochemical conditions in different areas through which the plume is or will be moving possess differing oxidation-reduction potential (ORP) conditions, Cation Exchange Capacity (CEC), or sediment iron oxide content—the three characteristics used to define a scenario. Multiple scenarios may therefore be needed for some sites with variable geochemical conditions; however, at many sites, geochemical conditions are more uniform and there will be only a single plume segment and a single scenario.

For each scenario, the conceptual model identifies the attenuation processes that may exist for each contaminant and the attenuation-based remedies that may be appropriate. The Scenarios Approach uses ORP, CEC, and sediment iron oxide content to define scenarios and each of these parameters can be associated with *reactive facies* defined herein as units (e.g., layers, lenses, and zones) with hydrogeochemical properties that are different from surrounding units and react with contaminants in distinct ways. Mapping the distribution of reactive facies is therefore useful for designating segments and scenarios and may also be important for optimizing sampling and data collection activities.

Key Definition

The geologic definition of “facies” is a “distinct layer or lens within the subsurface distinguished from others by its hydraulic or chemical behavior, and recognized as characteristic of a particular depositional environment.”

In this Scenarios Approach document, we present the concept of “reactive facies,” or a zone of common hydrologic and/or geochemical conditions in the subsurface. For example, a peat layer may be an “ORP reactive facies” that needs particular attention because of its impact on contaminant transport. A reactive facies may also be a layer or lens of higher sorptive capacity (e.g., clay or high iron oxide layers). The key is to define the heterogeneity at a site that matters most for attenuation processes and the related mobility of contaminants.

The Scenarios Approach also incorporates the concept of *biogeochemical gradients*; i.e., spatial variations in geochemical conditions created by waste disposal or other phenomena. Biogeochemical gradients can evolve over time as geochemical conditions change; for instance, as neutral pH water displaces low pH water. When present, biogeochemical gradients can strongly affect contaminant mobility and thus identification and characterization of biogeochemical of gradients allows the contaminant attenuation-affecting conditions of a site to be projected into the future.

The Scenarios Approach uses the inputs and primary steps summarized in Figure 1.1 to provide key knowledge relevant to evaluation of MNA. This overall process is described in more detail in the text that follows the figure.

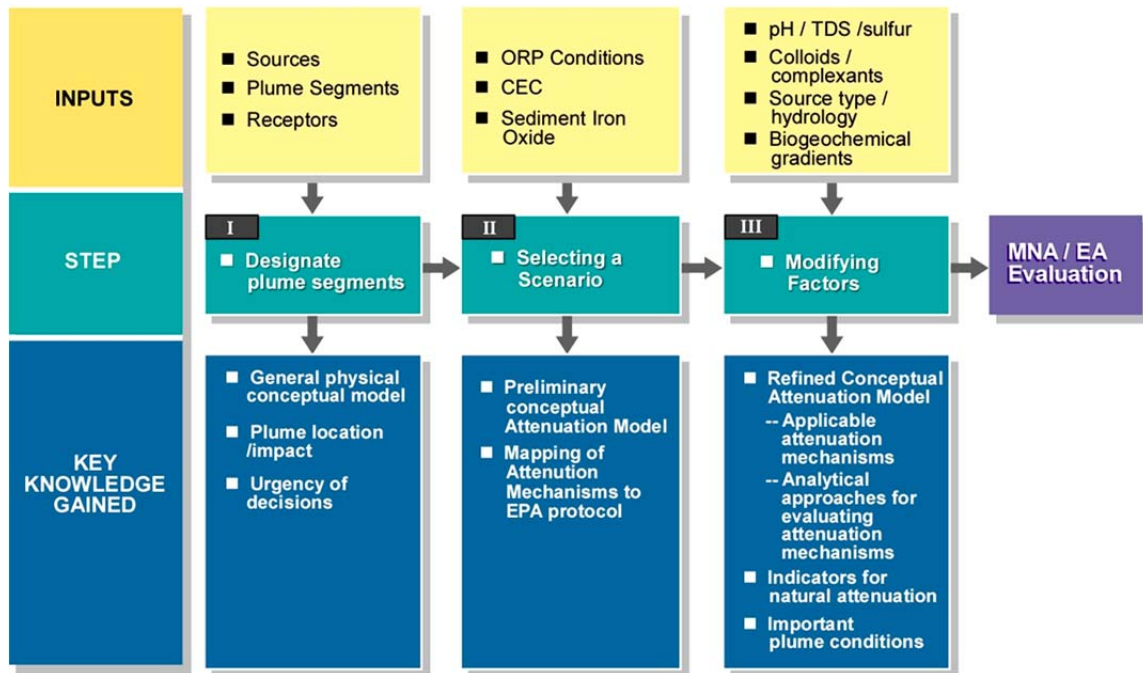

Figure 1.1. Summary of the scenarios approach inputs, steps, and key knowledge gained

2.0 Step 1: Designate Plume Segments

The first step in applying the Scenarios Approach is to divide a groundwater contamination site into the following components (as applicable) as shown in Figure 1.2:

- **Surface Source(s):** Point(s) on the surface where contaminants entered the subsurface.
- **Vadose Zone Source(s):** Source materials in the vadose zone; examples include dissolved, sorbed, and precipitated contaminants and pure-phase liquid contaminants.
- **Saturated Zone Source(s):** Source materials in the saturated zone, such as dissolved and sorbed contaminants and non-aqueous phase liquid (NAPLs).
- **Plume System:** A single hydraulically connected groundwater plume emanating from one or more subsurface sources, but separated from other plumes at the site by geography (in a different spatial location at the site) and/or hydrogeology (in a different hydrogeologic unit at the site).
- **Plume Segments:** Within a plume system, a geographic subarea in which the geochemical conditions and sediment properties—ORP, CEC, and sediment iron oxide content—can be defined and are different from an adjacent subarea. In many cases, there may be only one plume segment per plume system. The ORP, CEC, and sediment iron oxide content properties of a plume segment are used to select the appropriate scenario. At sites with multiple plume segments, a scenario must be designated for each plume segment.
- **Receptor(s):** Human and/or environmental receptors that are or could be affected by the plume (if present); some plume segments may not have any receptors.

A site may be represented by a few, simple components or it may require many complex components. Figure 1.2 uses a hypothetical uranium plume to illustrate the nomenclature and relationships of the basic site and plume components (e.g., sources, plume segments, reactive facies, and geochemical gradients). Figure 1.2 also shows an example biogeochemical gradient and how it is important to evaluating attenuation over time.

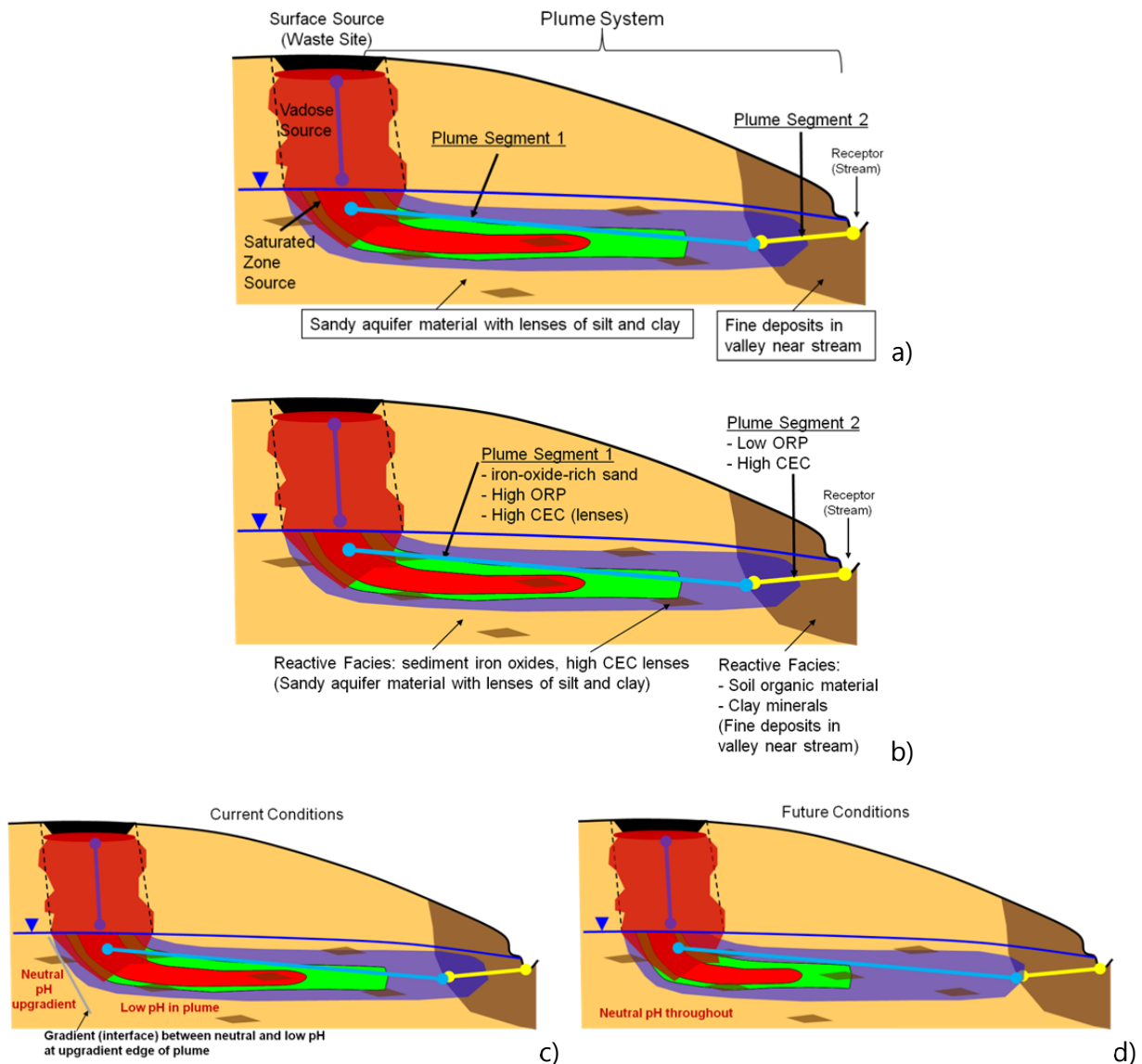

Figure 1.2. Plume nomenclature components (a) with identification of reactive facies (b). Biogeochemical gradients are illustrated using a hypothetical plume from a uranium-waste site under current site conditions (c) where the pH is low in the plume due to the waste discharge conditions, and in the future (d) the upgradient neutral pH groundwater has altered the geochemical conditions and impacted the plume. This change is important because the attenuation of uranium is higher under neutral conditions compared to low pH conditions. A key consideration in the MNA evaluation for uranium contamination is the rate at which the pH will evolve versus the rate of contaminant movement; however, the important factors may be different for other contaminants.

Section 1: Scenarios User Guide

3.0 Step 2: Select a Scenario

The second step in the Scenarios Approach process is to select a scenario for each plume segment using three different criteria:

- Oxidation-reduction potential (ORP);
- Cation Exchange Capacity (CEC);
- Sediment iron oxide content.

After determining these three factors, select the appropriate scenario out of the list of six possible scenarios shown in Table 1.2.

Table 1.2. Scenario Selection

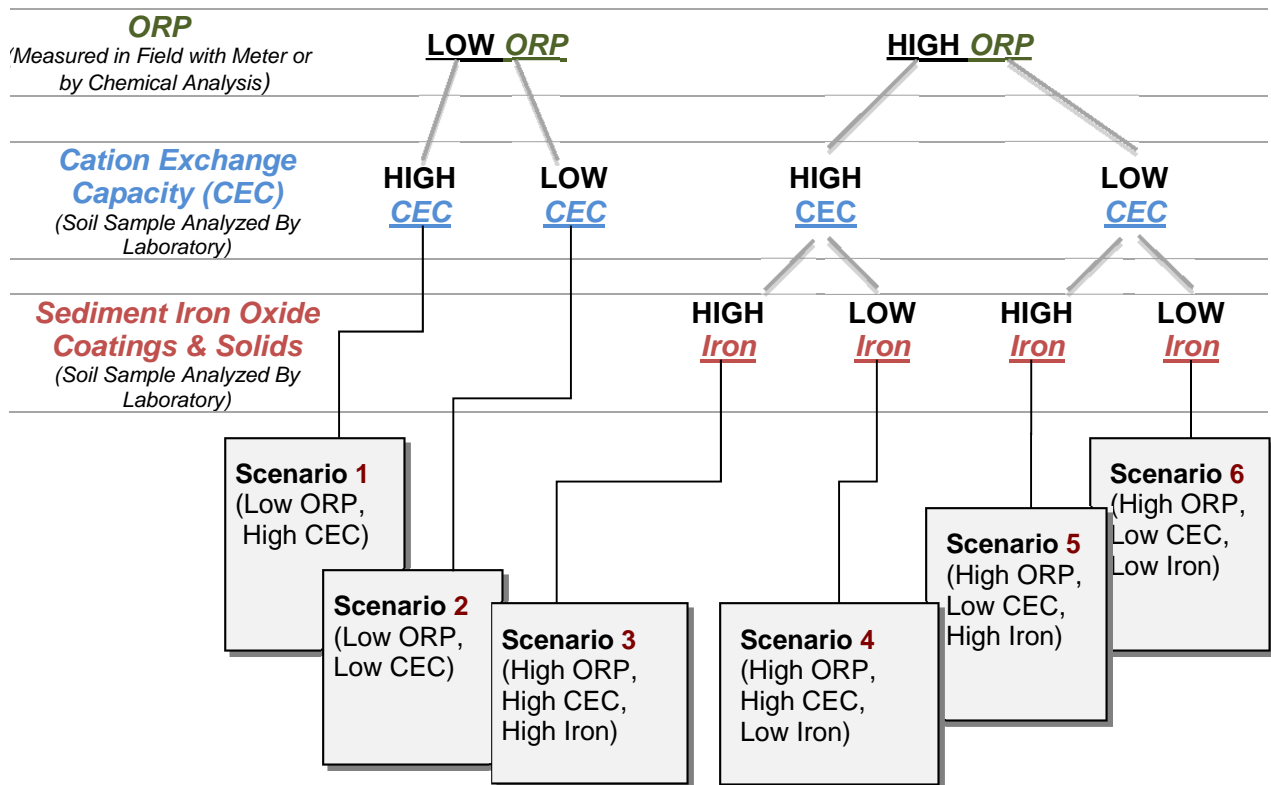

For discussions of CEC and iron-oxide measurement approaches, see Sections IIB.1.3 and IIIB.2.4, respectively, of *Monitored Natural Attenuation of Inorganic Contaminants in Ground Water Volume 1 - Technical Basis for Assessment* (EPA 2007a).

3.1 Oxidation-Reduction Potential

Oxidation-reduction reactions control the valence states of some elements (e.g., U, Tc, Pu). The valence state, in turn, influences the solubility and toxicity of the element. An assessment of the ORP of an aquifer is usually conducted using measurements of pe/Eh made on groundwater samples with a platinum electrode and meter. Measurements of dissolved oxygen, nitrate, sulfate, ferrous iron, and dissolved methane on groundwater samples are common indirect indicators of ORP in groundwater systems (see Section III.C of Volume I of the EPA Protocol for additional information).

Which ORP Condition?

HIGH ORP (oxidizing or aerobic environment): Eh > 0 mV

LOW ORP (anoxic or anaerobic environment): Eh < 0 mV

The Scenarios Approach divides sites into high (Eh > 0 mV) and low (Eh < 0 mV) ORP conditions. Interpretations of ORP conditions, however, should consider that processes typically occurring under high or low ORP conditions (e.g., significantly different than 0 mV) may be slow or absent for sites with near zero Eh. At these sites with near zero Eh, additional geochemical assessment may be needed to fully understand the attenuation processes.

3.2 Cation Exchange Capacity

Which CEC Condition?

HIGH cation exchange conditions: greater than 10 meq/100 grams of aquifer media

LOW cation exchange conditions: less than 10 meq/100 grams of aquifer media

Cation exchange is important because it influences the degree to which contaminant cations may be removed from contaminated groundwater and retained on mineral surfaces, especially clay minerals. This document recognizes two CEC conditions. High CEC corresponds to CEC >10 meq/100 g and low CEC to CEC <10 meq/100 g. High CEC means the sediment has a high surface charge and the ability to attract and hold cations. Contaminant cations are less mobile in high CEC sediments. CEC is routinely measured by soil testing laboratories.

Section 1: Scenarios User Guide

3.3 Sediment Iron Oxide Content

Sorption of inorganic contaminants onto sediment iron oxides (i.e., oxides and hydroxides of ferric iron [Fe³⁺] such as goethite, ferrihydrite, and hematite) is an important attenuation mechanism in oxic soils. Sediment iron oxides tend to have high surface areas and are often present both as discrete mineral phases and as mineral coatings. More crystalline sediment iron oxide phases have lower surface areas and are able to sorb less. Sorption to sediment iron oxides depends on both the contaminant and the pH (a modifying factor discussed in Step 3).

Sorption of cations typically increases with increasing pH above pH 5. Sorption of anions, such as arsenate, increases with decreasing pH below pH 7. Sediment iron oxide content is typically measured on sediment samples in the laboratory (see Table 3.1 of the EPA Protocol, Vol. 1 [EPA 2007a]). As shown in Table 1.2, for high ORP conditions the Scenarios Approach establishes two categories of sediment iron oxide content. High sediment iron oxide content corresponds to >0.1% Fe by weight (1 mg/g) and low sediment iron oxide content to below this value. For low ORP conditions, the relative amount of sediment iron oxide content is less important; therefore, the Scenarios Approach does not include consideration of this parameter.

Which Sediment Iron Oxide Content?

HIGH sediment iron oxide content: greater than 0.1% Fe by weight (1 mg/g)

LOW sediment iron oxide content: less than 0.1% Fe by weight (1 mg/g)

4.0 Step 3: Think About Modifying Factors at the Site

Scenarios are selected by identifying the ORP, CEC, and sediment iron oxide content conditions. After these conditions have been established and the correct scenario selected, the conceptual model must be refined to account for additional site-specific geochemical and hydrogeologic conditions that exert further influence on contaminant transport and attenuation. These conditions are referred to as primary and secondary modifying factors in each scenario (Table 1.3).

Table 1.3. Primary and Secondary Modifying Factors

Primary Modifying Factors	Secondary Modifying Factors
<ul style="list-style-type: none"> pH Total dissolved solids Sulfur species 	<ul style="list-style-type: none"> Facilitated transport mechanisms Source type Hydrology and travel time to receptors

4.1 Primary Modifying Factors

The following subsections address the general impact of each primary modifying factor.

pH: The pH is a primary modifying factor because it affects sorption, dissolution/precipitation reactions, and microbial activity, which in turn can affect contaminant attenuation. Soil and groundwater pH conditions can be spatially and temporally variable, and can be strongly influenced by waste disposal (including the chemistry and waste form, and the initiation and cessation of waste discharge). Variations in pH can induce changes to the subsurface geochemistry, depending on the magnitude of the pH change and the type of sediment minerals present.

Total Dissolved Solids: Depending on the particular species, total dissolved solids (TDS) can affect sorption, dissolution, and precipitation reactions, all of which can potentially affect contaminant attenuation. For example, high TDS might suppress contaminant sorption by filling sorption sites on mineral surfaces that could otherwise sorb contaminants. Depending on the composition of the dissolved solids, high TDS can increase or decrease contaminant solubility. For example, high phosphate concentrations may cooperatively bind with contaminants and form immobile precipitates. Alternatively, in some cases high TDS may cause formation of soluble contaminant compounds. In addition, high TDS can impact the rates of dissolution and precipitation reactions. As with other primary modifying factors, TDS conditions can be changed by waste disposal and therefore can vary over time.

Sulfur Species: The presence of sulfur is a primary modifying factor because metallic and radioactive contaminants can precipitate with sulfur ions. These precipitation reactions can alter the availability and solubility of contaminants. Under low ORP conditions, some metal contaminants will react with sulfur to form metal sulfides. Under high ORP conditions where the sulfate ion is present (e.g., in oxygenated aquifers containing gypsum), some contaminant metals (e.g., lead) may be attenuated by precipitation as sulfates.

Special Cases: At some sites and for some contaminants, certain special cases and extreme geochemical conditions can impose significant impact on contaminant attenuation.

Carbonate Alkalinity: Carbonate alkalinity is particularly important because carbonate can increase solubility, especially for uranium, while potentially decreasing the solubility of lead, cadmium, zinc, and nickel. Thus, sites with high carbonate concentrations or potential changes in carbonate concentration need to consider carbonate geochemistry, particularly if uranium is a contaminant of concern.

Extremely High or Low pH ($4 < \text{pH} > 9$): When the $\text{pH} > 9$, some contaminants such as Cr(III) and Tc(IV) can have greatly increased solubility. When $\text{pH} < 4$, most metal and radionuclide contaminants are generally highly mobile and do not sorb.

4.2 Secondary Modifying Factors

Facilitated Transport: If aquifer geochemical conditions favor the existence of colloids or complexants, these entities may be involved in facilitating (or attenuating) the transport of contaminants. For example, at some sites there may be significant movement of clay particles or other colloids with the groundwater. In these cases, particles can transport contaminants more quickly than would be predicted based on the primary factors.

Source Type: The location and strength of the source affect how the contaminants are released into the aquifer. Specific considerations of source term strength include the mass distribution, source flux, and source longevity. Table 1.4 presents typical categories of sources. A discussion of mass flux is included in Appendix A.

Hydrology and Travel Time to Receptors: The subsurface hydrology and location of receptors relative to the plume affect evaluation of MNA or EA as remedies and thus are secondary modifying factors. Table 1.5 presents typical factors that need to be considered.

Table 1.4. Source Configurations and Associated Considerations for Attenuation-Based Remedies

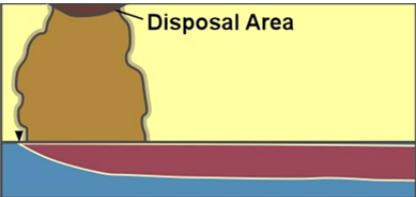
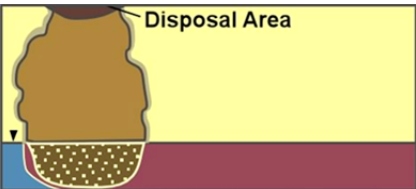
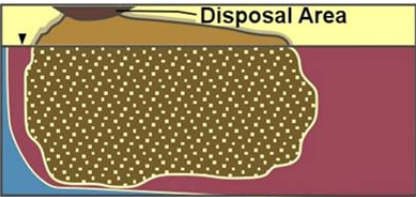
Source Type	Source Flux	Longevity
<p>Vadose Bleed</p> 	<p>Waste discharge relative to the vadose zone size was small enough that high concentrations of contaminants did not reach the aquifer beneath the waste site. Flux from the vadose zone into the aquifer is dependent on recharge and drainage.</p>	<p>While the magnitude of the source flux may be low, it may continue over a long period, driven by slow recharge and drainage from the vadose zone.</p>
<p>Vadose Bleed + Localized Submerged</p> 	<p>Waste discharge is sufficient to drive high concentrations of contaminants into the aquifer beneath the waste site. Current flux from the vadose zone is dependent on recharge and drainage, but likely much lower now than during the historical disposal period. High contamination zone in the aquifer can be a significant continuing source depending on the rate of release from solids. Release rate due to sorption and solubility may be influenced by biogeochemical gradients.</p>	<p>A moderately large total mass of sediment-associated contaminant may be present in the aquifer, and source longevity will likely be long-term and controlled by sorption and solubility as influenced by biogeochemical gradients. For low sorption/high solubility contaminants (e.g., anions such as chloride), the source longevity may be short in the groundwater, but the vadose zone recharge may be of concern and occur over a long time frame.</p>
<p>Vadose Bleed + Dispersed Submerged</p> 	<p>Large distribution of contaminants resulted from initial high discharge. Current flux from the vadose zone is dependent on recharge and drainage, but likely much lower now than during the historical disposal period. Large distribution in an aquifer can be a significant continuing source dependent on the rate of release from solids. Release rate due to sorption and solubility may be influenced by biogeochemical gradients.</p>	<p>A large total mass of sediment-associated contaminant may be present in the aquifer, and source longevity will likely be long term and controlled by sorption and solubility as influenced by biogeochemical gradients. For low sorption/high solubility contaminants (e.g., anions such as chloride), the source longevity may be short in the groundwater, but the vadose zone recharge may be a concern and occur over a long time frame.</p>

Section 1: Scenarios User Guide

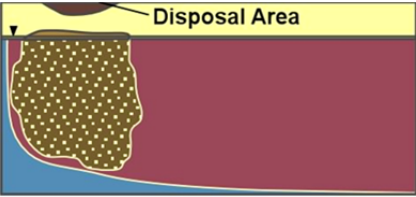
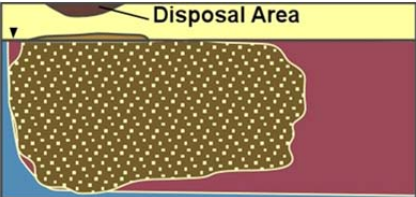
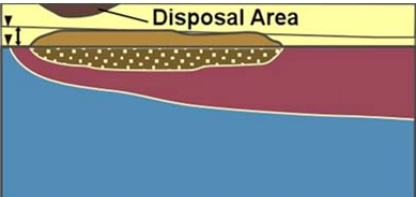
Source Type	Source Flux	Longevity
<p>Localized Submerged</p> 	<p>Waste discharge sufficient to drive high concentrations of contaminants into the aquifer beneath the waste site. Source flux from the vadose zone is no longer present. High contamination zone in the aquifer can be a significant continuing source dependent on the rate of release from solids. Release rate due to sorption and solubility may be influenced by biogeochemical gradients.</p>	<p>A moderately large total mass of sediment-associated contaminant may be present in the aquifer and source longevity will likely be long-term and controlled by sorption and solubility as influenced by biogeochemical gradients. For low sorption/high solubility contaminants (e.g., anions such as chloride), the source longevity may be short in the groundwater.</p>
<p>Dispersed Submerged</p> 	<p>Large distribution of contaminants resulted from initial high discharge. Source flux from the vadose zone is no longer present. Large distribution in aquifer can be a significant continuing source dependent on the rate of release from solids. Release rate due to sorption and solubility may be influenced by biogeochemical gradients.</p>	<p>A large total mass of sediment-associated contaminant may be present in the aquifer and source longevity will likely be long-term and controlled by sorption and solubility as influenced by biogeochemical gradients. For low sorption/high solubility contaminants (e.g., anions such as chloride), the source longevity may be short in the groundwater.</p>
<p>Concentrated Water Table Source</p> 	<p>Contaminants have been retained near the water table interface and the source flux is a function of the recharge rate, variations in water table elevation, and the contaminant sorption and solubility. Assessment of biogeochemical gradients may need consideration of changes due to water table variations and interface with the vadose zone.</p>	<p>While the magnitude of the source flux may be low, it may continue over a long period, driven by recharge and enhanced when water table variations periodically contact contaminated vadose zone sediments.</p>

Source Type	Source Flux	Longevity
<p>Concentrated Water Table Source + Dispersed Submerged Source</p> 	<p>Large distribution of contaminants resulted from initial high discharge. Source flux from the vadose zone is no longer present. Large distribution in aquifer can be a significant continuing source dependent on the rate of release from solids. Release rate due to sorption and solubility may be influenced by biogeochemical gradients. Contaminants have been retained near the water table interface and the source flux is a function of the recharge rate, variations in water table elevation, and the contaminant sorption and solubility. Assessment of biogeochemical gradients may need consideration of changes due to water table variations and interface with the vadose zone.</p>	<p>A large total mass of sediment-associated contaminant may be present in the aquifer and source longevity will likely be long-term and controlled by sorption and solubility as influenced by biogeochemical gradients. For low sorption/high solubility contaminants (e.g., anions such as chloride), the source longevity may be short in the groundwater. However, the source flux may continue over a long period, driven by recharge and enhanced when water table variations periodically contact contaminated vadose zone sediments.</p>
<p>Submerged Low Permeability Bleed</p> 	<p>Remaining contaminants are located in low permeability zones that have low advective flow compared to surrounding aquifer zones. Source flux may be low and controlled by diffusion from low permeability sediments. Biogeochemical gradients at the interface of low and high permeability zones may be important to consider. Biogeochemical conditions within the low permeability zones may be stable over time.</p>	<p>While the magnitude of the source flux may be low, it may continue over a long period, driven by diffusion from low permeability sediments.</p>

Table 1.5. Hydrology and Time to Receptors Considerations

Factor	Characteristic	Potential Impact
Hydrologic Setting	Simple	<ul style="list-style-type: none"> • Regular plume shape • More uniform sorption • Fewer vertical monitoring issues
	Complex	<ul style="list-style-type: none"> • Potential for irregularities in plume velocity and shape • Presence of zones that may have different sorption characteristics or slowly release contaminant over time • Large variations in concentration over short distances (a few meters) • Vertical monitoring issues may be important
Groundwater Flow Rate	Slow	<ul style="list-style-type: none"> • Lower contaminant flux • Low rate of change in biogeochemical gradients • Slow plume evolution rate • Less frequent monitoring • Plume will stabilize slowly if at all
	Fast	<ul style="list-style-type: none"> • Higher contaminant flux • High rate of change in biogeochemical gradients • Quick plume evolution rate • More frequent monitoring • Plume may stabilize quickly
Type of Discharge	Surface water	<ul style="list-style-type: none"> • Attenuation mechanisms and contaminant concentrations may change at surface water sediment discharge zone • May need to consider surface water dynamics and impact on aquifer gradients
	Groundwater	<ul style="list-style-type: none"> • May need to consider receptor well configuration and dynamics
Receptor Location	Close	<ul style="list-style-type: none"> • More frequent monitoring possible • Limited room for plume expansion before stabilization • Shorter time for evaluation, decisions, and implementing enhancements
	Far	<ul style="list-style-type: none"> • Less frequent monitoring possible • Room for plume expansion prior to stabilization • Longer time for evaluation, decisions, and implementing enhancements

5.0 Step 4: Go to the Scenarios Section

Record your site-specific information about each plume segment using the following chart, including any notations about previous or existing remediation activities. After this information is compiled, go to Section 2, "Scenarios" of this document and follow the process using the scenario-specific information provided. See Section 3, "Scenarios Evaluation Guide" for additional details about the MNA/EA evaluation process.

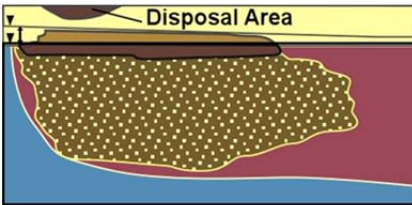
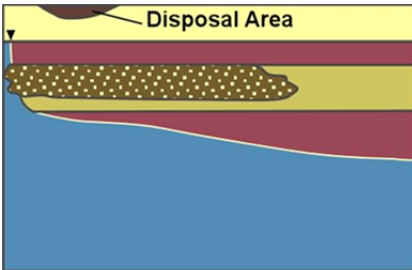
Section 1: Scenarios User Guide

Site-Specific Plume Segment Information

SITE NAME:	LOCATION	SEGMENT
ORP	HIGH (Eh > 0 mV) LOW (Eh < 0 mV)	Details _____ _____
CEC	HIGH (>10 meq/100g) LOW (<10 meq/100g)	Details _____ _____
Sediment iron oxide content	HIGH (>1mg/g) LOW (<1mg/g) ANY (1 mg/g)	Details _____ _____
PRIMARY MODIFYING FACTORS		
pH	<input type="checkbox"/> High (>7) <input type="checkbox"/> Neutral (~7) <input type="checkbox"/> Low (<7)	_____
Dissolved Solids (TDS)	<input type="checkbox"/> High (>1.6 mS/cm) <input type="checkbox"/> Low (<1.6 mS/cm)	Type _____
Sulfur (Low ORP only)	<input type="checkbox"/> High (>0.2 mM) <input type="checkbox"/> Low (<0.2 mM) <input type="checkbox"/> N/A	_____
Special Cases:		
High carbonate alkalinity	<input type="checkbox"/>	
Extreme pH (4 < pH < 9)	<input type="checkbox"/>	
SECONDARY MODIFYING FACTORS		
Facilitated transport	<input type="checkbox"/> Colloids <input type="checkbox"/> Complexants <input type="checkbox"/> Other	_____
Source configuration	<input type="checkbox"/> See evaluation guide	_____
Hydrology/ time to receptors	<input type="checkbox"/> Simple <input type="checkbox"/> Complex setting	_____
	<input type="checkbox"/> Fast <input type="checkbox"/> Slow flow rate	_____
	<input type="checkbox"/> Surface water <input type="checkbox"/> Groundwater discharge	_____
	<input type="checkbox"/> Close <input type="checkbox"/> Far receptor	_____
GRADIENTS PRESENT IN A SEGMENT		
(Gradients leading to changes in geochemical conditions over time)		
pH	<input type="checkbox"/> pH may be <u>higher</u> in the future	_____
	<input type="checkbox"/> pH may be <u>lower</u> in the future	_____
ORP	<input type="checkbox"/> ORP may be <u>higher</u> in the future	_____
	<input type="checkbox"/> ORP may be <u>lower</u> in the future	_____
Dissolved solids (TDS)	<input type="checkbox"/> TDS may be <u>higher</u> in the future	_____
	<input type="checkbox"/> TDS may be <u>lower</u> in the future	_____
Other geochemical conditions that may change over time (e.g., carbonate)	<input type="checkbox"/>	_____
Existing remediation	<input type="checkbox"/>	_____
Previous remediation	<input type="checkbox"/>	_____

Section 2: Scenarios

Main Objectives

- ✓ Explains specific attenuation processes affecting contaminant mobility that are important for the selected scenario
- ✓ Shows how to use the selected scenario to develop a site-specific attenuation-based conceptual model for a site
- ✓ Describes how to apply Monitored Natural Attenuation (MNA) and Enhanced Attenuation (EA) at a site
- ✓ Describes how to use the U.S. Environmental Protection Agency (EPA) tiered MNA evaluation process at a site.

1.0 Scenario Worksheet

The "Site-Specific Plume Segment Information" worksheet at the end of the Section 1, "Scenarios User Guide" can be used as a reference while progressing through the remainder of the Scenario. Information to assist in filling out this worksheet can be obtained in Section 1, "Scenarios User Guide" and Section 3, "Scenarios Evaluation Guide."

Section 2: Scenarios

2.0 Summary of Scenario Characteristics

Mobility Control Factor	Scenario 1 low ORP, high CEC	Scenario 2 low ORP, low CEC	Scenario 3 high ORP, high CEC, high Fe	Scenario 4 high ORP, high CEC, low Fe	Scenario 5 high ORP, low CEC, high Fe	Scenario 6 high ORP, low CEC, low Fe
Solubility / Degradation	<p>Low ORP conditions will be a significant control for contaminant mobility where precipitation of reduced compounds and degradation of inorganic compounds such as nitrate and perchlorate will favor their natural attenuation.</p> <p>Arsenic and iodine are mobile under low ORP conditions.</p>		<p>Chromium, selenium, iodine, and technetium compounds are anionic under high ORP conditions and anionic compounds will be generally mobile.</p> <p>Inorganic compounds such as nitrate and perchlorate are persistent and mobile under high ORP conditions.</p>			
Sorption (mobility)	<p>Significant mobility control for cationic compounds</p> <p>Cationic compounds:</p> <p>High CEC condition acts as a source of sorption sites</p>	<p>Limited mobility control effectiveness</p> <p>Low CEC condition</p>	<p>Sorption will be a primary control factor for contaminant mobility</p>			
Sorption (capacity)	<p>High overall site sorption capacity for cations.</p>	<p>Low overall site sorption capacity for cations.</p>	<p>High overall site sorption capacity.</p>	<p>High overall site sorption capacity for cations.</p>	<p>Moderate overall site sorption capacity.</p>	<p>Low overall site sorption capacity.</p>
	<p>Likely moderate sorption of neutral complexes (e.g., Pu, Th).</p>			<p>Moderate to low sorption of neutral complexes (due to the low sediment iron oxide content)</p>		
<p>ORP – oxidation-reduction potential CEC – Cation Exchange Capacity Fe – sediment iron oxide content</p>						

3.0 Summary of Contaminant Mobility

Table 2.1 provides information about the mobility of contaminants for each scenario. Contaminants in Table 2.1 are the same contaminants covered by the EPA Protocol with the exception of mercury, tritium, radon, americium, and thorium. Information pertinent to mercury contamination is provided in Appendix B of Section 3, "Scenarios Evaluation Guide." Information pertinent to tritium, radon, americium, and thorium contamination is provided in Appendix C of Section 3, "Scenarios Evaluation Guide."

To use Table 2.1, examine the mobility of contaminants at the site (or plume segment) for the appropriate scenario. Consider how variations in key parameters might impact the general mobility. For instance, if sediment iron oxide content is generally high, refer to adjacent scenarios to examine how heterogeneous conditions with locations of lower sediment iron oxide content might impact mobility. Similarly, the distribution of CEC at a site may be variable with high CEC in clay lenses and low CEC in adjacent sands. Table 2.1 can be used to examine the impact of high and low CEC on the contaminants at the site.

Contaminant plume conditions may change over time. For a description of how biogeochemical gradients impact attenuation, see Section 3, "Scenarios Evaluation Guide." For instance, if low ORP or low pH conditions are caused by a waste source, then ORP conditions will become more oxidizing over time and/or the pH will increase over time as the waste source diminishes or is remediated. Future ORP conditions should be evaluated using the appropriate scenario. The pH, ORP, sulfur compound concentrations, and total dissolved solids are examples of key parameters that may change at a site as a result of biogeochemical gradients. The general impact of these changes on contaminant mobility can be evaluated using the information on Table 2.1.

Special Considerations

Carbonate Alkalinity: Carbonate alkalinity is particularly important because carbonate can act as a mobilizing ligand, especially for uranium, while potentially decreasing the solubility of lead, cadmium, zinc, and nickel. Thus, sites that have high carbonate concentrations or potential changes in carbonate concentration need to consider carbonate geochemistry, particularly if uranium is a contaminant of concern.

Extremely Basic Conditions (pH > 9): Highly basic waters require special attention when contaminants are present that do not form insoluble metal-carbonates but do form metal-carbonate complexes and/or hydrolyze. Trivalent and quadrivalent cations, such as Cr(III) and Tc (IV), are in this category. Because highly basic waters often have high carbonate alkalinity, uranium will also tend to be more mobile at pH > 9.

Extremely Acidic Conditions (pH < 4): Extremely acidic conditions will cause mobilization of most metals.

Section 2: Scenarios

Table 2.1. Summary of Contaminant Mobility for 4 < pH < 9. See text for discussion of extreme chemistries and special considerations.

Contaminant	Scenarios					
	Scenario 1 <i>low ORP high CEC</i>	Scenario 2 <i>low ORP low CEC</i>	Scenario 3 <i>high ORP high CEC high SIO¹</i>	Scenario 4 <i>high ORP high CEC low SIO¹</i>	Scenario 5 <i>high ORP low CEC high SIO¹</i>	Scenario 6 <i>high ORP low CEC low SIO¹</i>
Cr(III)						
Cr(VI)						
⁹⁹ Tc(IV)						
⁹⁹ Tc(VII)						
Pu						
U						
Cd, Cu, Pb, Zn						
Ni						
As						
Se						
⁹⁰ Sr, Cs ² , Ra ³						
NO ₃ ⁻ , ClO ₄ ⁻	<i>can degrade</i>	<i>can degrade</i>				
¹²⁹ I						

	HIGH Mobility		Mobility increases above and below pH7		Increasing sulfur <u>decreases</u> mobility
	MEDIUM Mobility		Mobility increases above pH7		Increasing TDS <u>increases</u> mobility
	LOW Mobility		Mobility decreases above pH7 and increases below pH7		Transformed to other valence state

¹SIO: Sediment Iron Oxide content
²Cs attenuation is significantly increased when micaceous clays are present
³Radium forms RaSO₄ solids that may be important for attenuation

4.0 Actions Needed to Evaluate Attenuation-Based Remedies

Stakeholders at sites considering using MNA should follow the *tiered approach* described in the EPA Protocol. EPA's tiered approach (Section 1C of Volume 1 of the EPA Protocol) is illustrated in Figure 2.1 and compared to plume behavior and distance to a receptor. The EPA tiered approach progressively evaluates the suitability of MNA. For example, the following aspects would apply during an evaluation:

- MNA is more likely to be a stand-alone remedy when a contaminant plume is shrinking.
- MNA is unlikely to be relied on solely when the plume is growing and close to receptors.
- Enhanced Attenuation (EA) should be considered in some cases to enable obtaining or ensuring Tier IV where MNA alone is insufficient.

Key Point

For MNA as the sole remedy at an inorganic/radionuclide site, a site needs to pass Tier I, Tier II, and Tier III evaluations. This section explains how to get started. *An EA approach can be implemented to help pass an evaluation tier.*

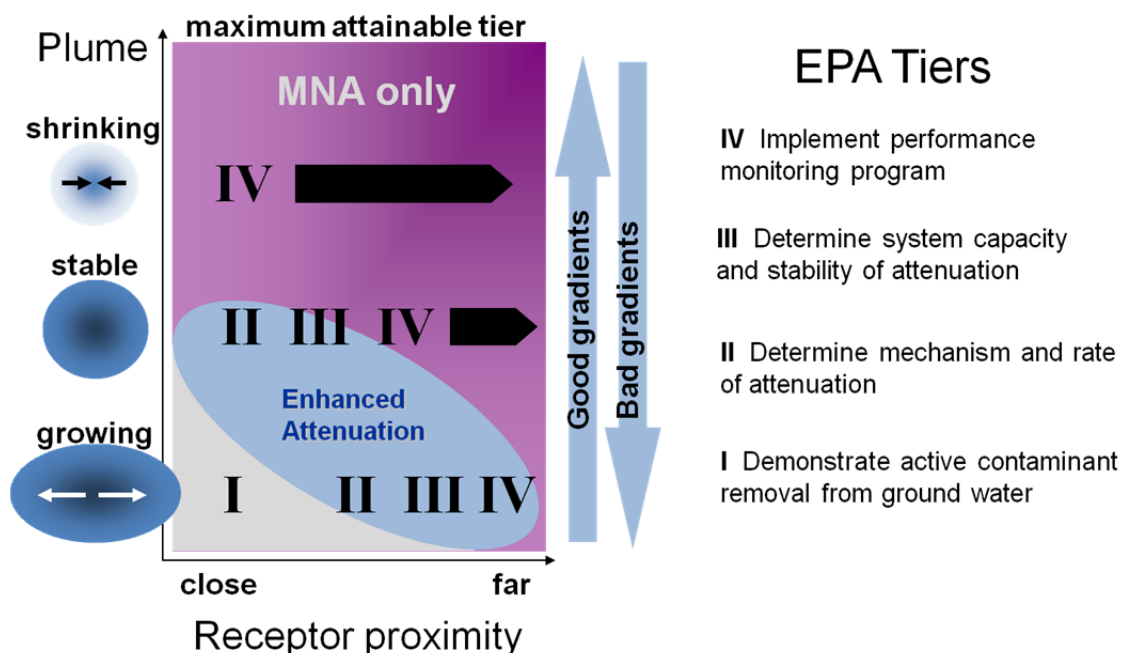

Figure 2.1. Schematic of EPA's tiered approach to MNA implementation plotted against plume behavior and receptor proximity. Enhanced Attenuation may enable obtaining Tier 4 for cases with stable or currently growing plumes. Gradients, as indicated on the right side of the figure, can change conditions over time and thereby change the ability for MNA to be suitable as a remedy. Some gradients are "good" in that they improve attenuation capacity and rate over time. Other "bad" gradients may be detrimental to attenuation processes.

The following subsections provide guidance in conducting the EPA tiered evaluations.

4.1 Initial Actions and EPA Protocol Tier I Evaluations

As an initial action, the site should be described in terms of conceptual model elements that explain the site in terms of the following:

- plume status (is the plume expanding, stable, or shrinking)
- importance of biogeochemical gradients
- proximity to receptors
- source strength.

Table 2.2 provides guidance on how these conceptual model elements can be used together to determine if a site passes the Tier I MNA evaluation as described by the EPA MNA Protocol (EPA 2007a,b; 2010). Additionally, Table 2.2 identifies where EA should be considered to help pass Tier I.

The key objective of a Tier I analysis is to determine whether active contaminant removal from groundwater is occurring. One way to make this determination is to compare the actual plume size to the predicted size of the plume if no attenuation were occurring. Another method is to compare soil/dissolved concentrations of the contaminant(s) at different points in the plume to determine if there is uptake of the contaminant on the soil. After this comparison is done, Table 2.2 can be used to broaden the Tier I evaluation to include the other conceptual model elements (gradients, receptor location, source strength) and an evaluation of MNA, EA, or source actions as components of the remedy.

What is the Objective of EPA Protocol Tier I?

The EPA Protocol states: “The objective under Tier I analysis would be to eliminate sites where site characterization indicates that the groundwater plume is continuing to expand in aerial or vertical extent.” (EPA 2007a)

If a site does not pass Tier I, then MNA alone is not likely to be effective.

Table 2.2. Flowchart Guidance for Tier I Assessments

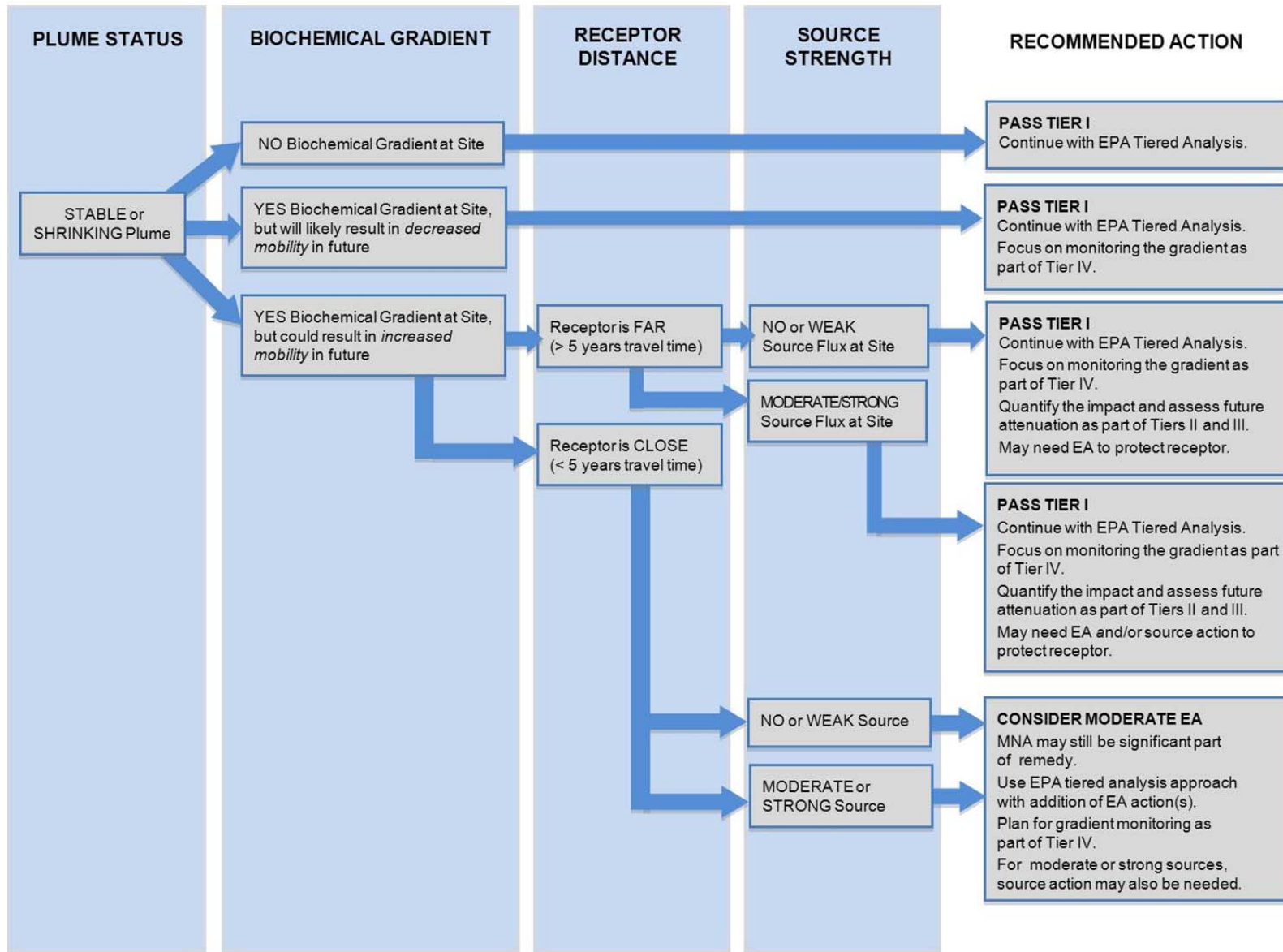

Section 2: Scenarios

Table 2.2 (cont)

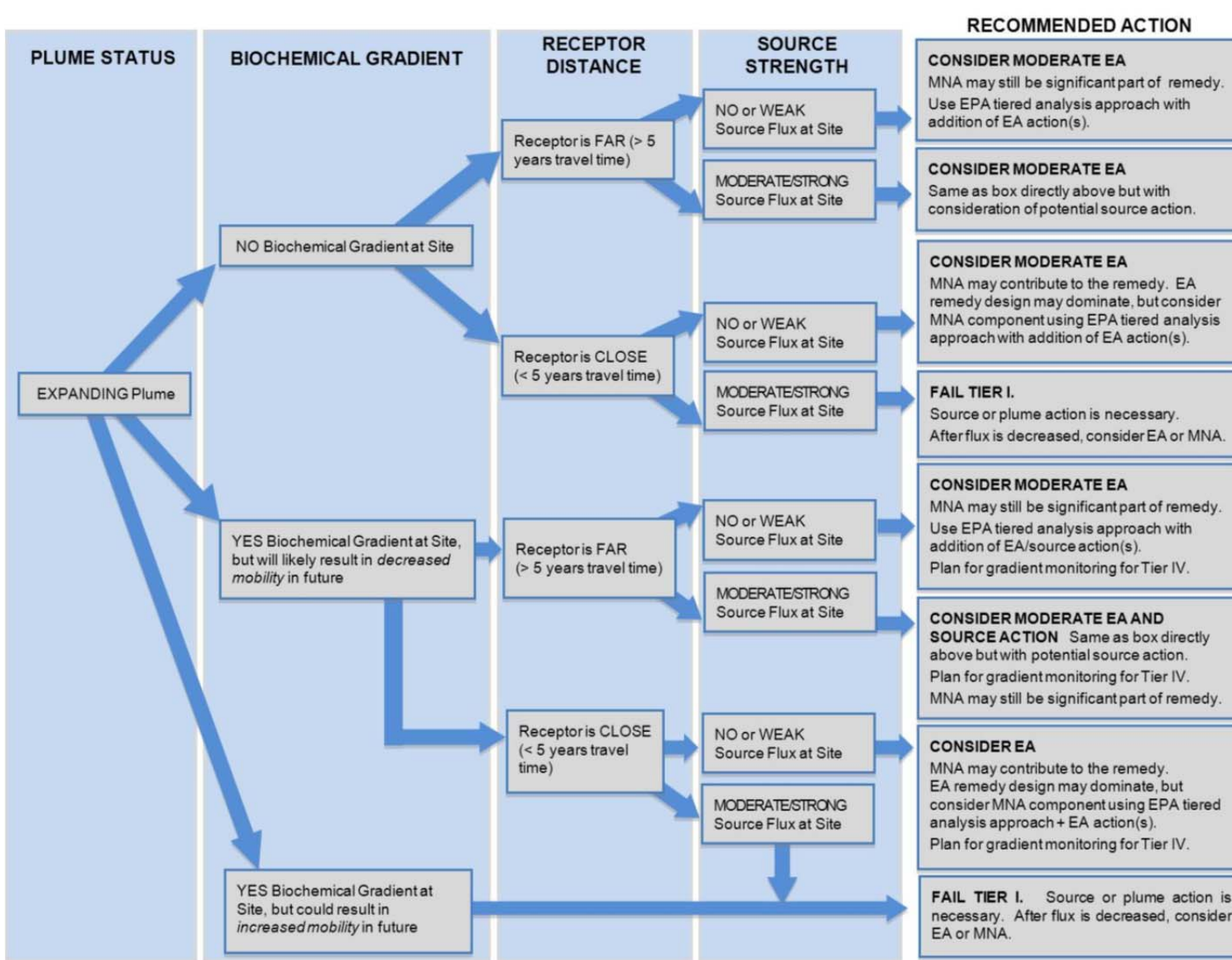

4.2 EPA Tier II and Tier III Evaluations

If a site passes the Tier I evaluation, the EPA Protocol then requires that Tier II and Tier III evaluations are conducted. A Tier II evaluation requires collecting information about the mechanism and rate of attenuation. If viable attenuation mechanisms are identified, a Tier III evaluation is then conducted to estimate the capacity of the site to attenuate the contaminants. The combined information about attenuation mechanism, rate, and capacity is needed as evidence to then evaluate whether natural attenuation will meet remediation goals (e.g., result in a stable and shrinking plume).

The EPA protocol states that Tier II and III evaluations must be able to determine the following:

- mechanism and rates of attenuation (Tier II)
- capacity and sustainability of attenuation (Tier III).

To facilitate conducting the Tier II and Tier III evaluations, the Scenarios Approach outlines a recommendation for developing an attenuation conceptual model that includes reactive facies, biogeochemical gradients, and the potential addition of EA to help meet remediation goals. Information about this approach is in the following subsections. Additional details regarding the Tier II and Tier III evaluation processes are in Section 3, "Scenarios Evaluation Guide."

4.2.1 Tasks to Augment Tier II and III Evaluations

Task 1: Construct an Attenuation Conceptual Model. Figure 2.2 provides an example of the components to consider.

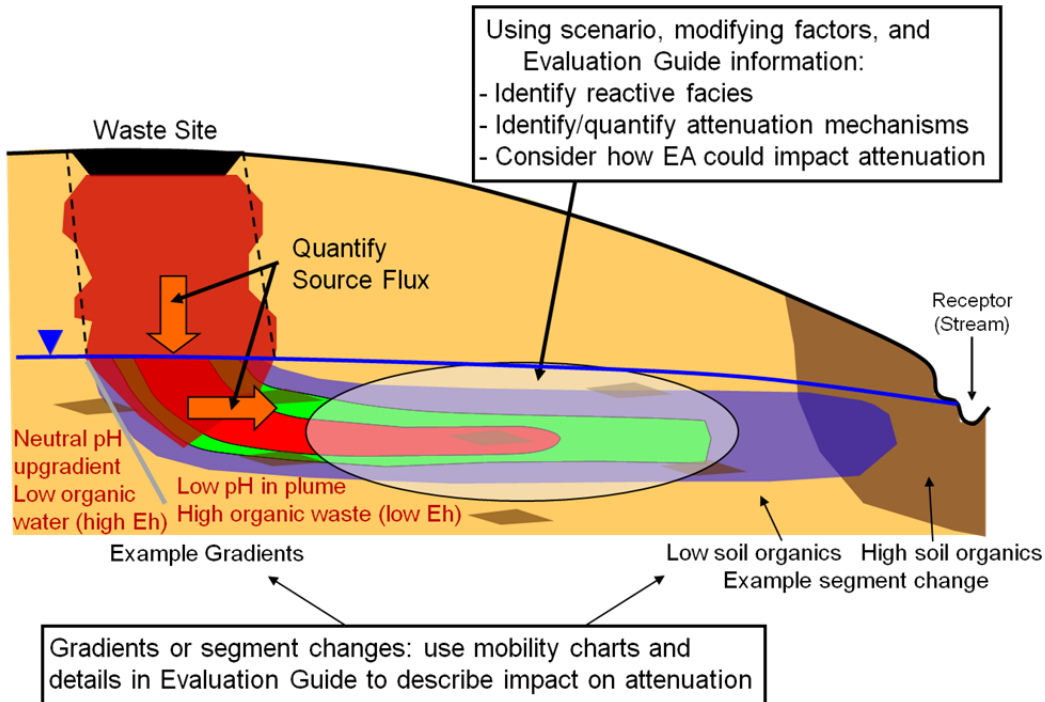

Figure 2.2. Components of the Attenuation Conceptual Model. Each relevant element must be described and quantified for Tier II and Tier III analyses. For more detailed information about each element, see Section 3, "Scenarios Evaluation Guide."

Task 2: Organize additional sampling and assessment based on reactive facies and biochemical gradient locations:

- With the idea that "facies controls fate," it follows that sampling and assessment should be organized around the distribution of different reactive facies at a site. On a large scale, this consists of defining plume segments and selecting the specific scenario for each segment. On a smaller scale, sampling and assessment should be targeted to evaluate conditions at leading and trailing gradients, and to include consideration of the zones that act as continuing sources of either contamination or that have significant control over the biogeochemical conditions and how these conditions will evolve over time.

Task 3: Establish how biogeochemical gradients impact the attenuation assessment (see Section 3, "Scenarios Evaluation Guide" for a description of gradients):

- Based on the gradients present and how biogeochemical conditions are expected to change over time (e.g., pH or ORP changing with time), conduct the Tier II and Tier III assessments for both the current conditions and anticipated future conditions.

- Define the relationship between the gradient and attenuation to determine when and how the attenuation conditions will change.
- Consider the rate of biogeochemical change due to a gradient or migration of the plume into different biogeochemical conditions (e.g., another plume segment) and the impact on attenuation. For example, if gradients that improve attenuation will change the biogeochemical conditions quickly relative to the rate of contaminant migration and there is sufficient distance to the receptor, a currently expanding plume may become fully attenuated in a future condition. Similarly, gradients that decrease attenuation may lead to unacceptable future conditions. ORP and pH gradients are typically the most significant gradients to consider.

Task 4: Consider EA and source actions in context of overall plume attenuation rate and capacity. These actions can be considered in terms of future conditions by using a new source flux and attenuation rate and capacity that is based on the expected impact of the EA action as part of the Tier II and Tier III assessments. Sustainability and overall capacity of EA are key parameters that must be established. Also, consider the impact of EA targeted at one contaminant or any others present, including naturally occurring contaminants such as arsenic.

4.2.2 Tools for Tier II and III Assessment

Several tools are available to help perform the above tasks and complete Tier II and Tier III evaluations. Tier II evaluations rely on *concentration versus time* and *concentration versus distance* rate calculations. The following tools help users evaluate and calculate these rates:

- The EPA's *Calculation and Use of First Order Rate Constants* report (Newell et al. 2002) documents the differences between the two types of rates, how to calculate both, and provides fully calculated examples.
- The *SourceDK Source Attenuation Tool* (Farhat et al. 2004) is a public domain software tool that helps users calculate concentration versus time decay rates for data obtained from monitoring wells.
- The *Estimating Times of Remediation Associated with Monitored Natural Attenuation* report (Chapelle et al. 2003) outlines a method for estimating time required for natural attenuation processes—such as dispersion, sorption, and biodegradation—to lower contaminant concentrations and mass to predetermined regulatory goals in groundwater systems.
- The *Mass Flux Toolkit* (Farhat et al. 2006) is a public domain software tool that helps users calculate mass discharge (mass flux) for plumes. Mass discharge can be used as the basis for a concentration versus time or a concentration versus distance rate.

- Solute transport models such as REMChlor (EPA 2007c) can be used to determine concentration versus distance rate constants. Site data can be entered into the model, and the first-order concentration versus distance decay constant can be changed to calibrate the model to the site data. Although REMChlor focuses on the fate and transport of chlorinated solvents, it can also be applied to many types of contaminants migrating in groundwater, including several metals and radionuclides.
- The EPA prepared *A Guide for Assessing Biodegradation and Source Identification of Organic Groundwater Contaminants Using Compound Specific Isotope Analysis (CSIA)*. CSIA is an emerging method that can be used to estimate concentration versus distance rate constants.

Tier III evaluations focus on determining the system capacity and stability of attenuation processes. The following tools help users perform these analyses:

- The *Scenarios for Chlorinated Solvent MNA* guide (Truex et al. 2006) provides information about sustainability, attenuation capacity, and Enhanced Attenuation for chlorinated solvents. Many of the same concepts are relevant to metals and radionuclides.
- The *BIOBALANCE Toolkit* (Kamath et al. 2006) is geared to evaluating mass balance of chlorinated solvents, but does include a module for evaluating the sustainability of anaerobic source zones.
- *A Framework for Assessing the Sustainability of MNA* (Chapelle et al. 2007) provides a method to assess the sustainability of chlorinated ethenes, but has information, calculation methods, and models that are transferrable to some metals/radionuclide scenarios.

4.3 EPA Tier IV Implementation

The objective for Tier IV is to 1) develop a monitoring program to track the performance of an MNA remedy, and 2) identify contingency measures that could be implemented if site conditions change and MNA processes become less effective. The monitoring program should be designed to track the plume status (expanding, stable, or shrinking) and track the basic reactive facies and biogeochemical factors that drive MNA processes. The EPA Protocol recommends that the "selection of groundwater parameters to be monitored also include constituents that provide information on continued stability of the solid phase with which an immobilized contaminant is associated." Thus, the key biogeochemical gradients identified for the site should be considered for monitoring. The Scenarios Approach also identifies the reactive facies and modifying factors important for the attenuation remedy; these items should be considered as part of developing the monitoring program.

Tools for Tier IV assessment related to monitoring programs are provided below.

- The MAROS system (Aziz et al. 2000) is an access-based software tool that helps users develop appropriate long-term groundwater monitoring programs and optimize existing monitoring systems.
- The EPA's and Corps of Engineers' *Roadmap to Long-Term Monitoring Optimization* (EPA 2005) was prepared to help site managers understanding the how, why, and where regarding long-term monitoring optimization studies, and provides a description of key tools.
- The Adaptive Environmental Monitoring System (Espinoza et al. 2005) uses genetic algorithms to search for optimal monitoring system designs and provides methods to determine the location of redundant wells in a monitoring program.
- The Summit Sampling Optimization and Data Tracker software (Harre 2009) performs a wide range of long-term monitoring optimization functions that can help users improve and optimize long-term monitoring programs.

Section 3: Scenarios Evaluation Guide

Main Objectives:

- ✓ Provides detail about attenuation processes and contaminant mobility
- ✓ Provides detail about developing an attenuation-based conceptual model for a site
- ✓ Provides details about the U.S. Environmental Protection Agency (EPA)-tiered Monitored Natural Attenuation (MNA) evaluation process
- ✓ Includes 60-plus pages of information with reactions, sorption, monitoring, remediation, costs, and more.

1.0 Introduction and Overview

This document is designed to help site managers evaluate and implement attenuation-based remedies for groundwater and vadose zones contaminated with metals and radionuclides. The document is intended to be a reference tool for users with various degrees of knowledge. All users will require at least a working familiarity with the principles of soil and groundwater contamination, contaminant migration and attenuation, methods of site characterization, analytical techniques, and the *Comprehensive Environmental Response, Compensation, and Liability Act of 1980* (CERCLA) process.

Using the comprehensive information provided in the EPA Technical Protocol for Monitored Natural Attenuation (MNA) of inorganic contaminants (EPA 2007a,b; EPA 2010; hereafter referred to as the "EPA Protocol") as a starting point, this document summarizes the primary factors controlling the migration and attenuation of groundwater contaminated with metals and radionuclides. The Scenarios Approach uses a conceptual model system to facilitate evaluating MNA and/or Enhanced Attenuation (EA) processes as a site remedy. Summarized in Table 3.1 are the main differences between the EPA Protocol and Scenarios Approach document:

Starting Point for Scenarios

This Scenarios Approach document was inspired by the EPA *Technical Protocol for Monitored Natural Attenuation (MNA) of Inorganic Contaminants* released in late 2007.

Section 3: Scenarios Evaluation Guide

Table 3.1. Differences Between EPA Protocol and Scenarios Approach Document

EPA Protocol	Scenarios Approach Document
Focuses on MNA only	Encompasses MNA and EA
Comprehensive discussion of mechanisms, analysis techniques, and models related to MNA for metals and radionuclides	Provides streamlined framework for selecting a site-specific conceptual model category and identifying specific data needs
Comprehensive, multiple-volume document	Limited, but focused presentation in three documents

The Scenarios Approach provides a stepwise process to identify an appropriate “Scenario” (conceptual model category) and refine it for a specific site. Six scenarios have been identified to categorize the primary characteristics of sites with respect to MNA/EA. Subsurface characteristics at some sites are spatially variable. The Scenarios Approach uses the concept of plume segments to divide a site into distinct segments if the geochemical conditions in different areas through which the plume is or will be moving possess differing oxidation-reduction (ORP) conditions, Cation Exchange Capacity (CEC), or sediment iron oxide content—the three characteristics used to define a scenario. Multiple scenarios may therefore be needed for some sites with variable geochemical conditions; however, at many sites, geochemical conditions are more uniform and there will be only a single plume segment and a single scenario.

For each scenario, the conceptual model identifies the attenuation processes that may exist for each contaminant and the attenuation-based remedies that may be appropriate. The Scenarios Approach uses ORP, CEC, and sediment iron oxide content to define scenarios and each of these parameters can be associated with *reactive facies* defined herein as units (e.g., layers, lenses, and zones) with hydrogeochemical properties that are different from surrounding units and react with contaminants in distinct ways. Mapping the distribution of reactive facies is thus useful for designating segments and scenarios and may also be important for optimizing sampling and data collection activities.

Key Definition

The geologic definition of “facies” is a “distinct layer or lens within the subsurface distinguished from others by its hydraulic or chemical behavior, and recognized as characteristic of a particular depositional environment.”

In this Scenarios Approach document, we present the concept of “reactive facies,” or a zone of common hydrologic and/or geochemical conditions in the subsurface. For example, a peat layer may be an “ORP reactive facies” that needs particular attention because of its impact on contaminant transport. A reactive facies may also be a layer or lens of higher sorptive capacity (e.g., clay or high iron oxide layers). The key is to define the heterogeneity at a site that matters most for attenuation processes and the related mobility of contaminants.

The Scenarios Approach also incorporates the concept of *biogeochemical gradients*; i.e., spatial variations in geochemical conditions created by waste disposal or other phenomena. Biogeochemical gradients can evolve over time as geochemical conditions change; for instance, as neutral pH water displaces low pH water. When present, biogeochemical gradients can strongly affect contaminant mobility, and thus identification and characterization of biogeochemical of gradients allows the contaminant attenuation-affecting conditions of a site to be projected into the future.

The Scenarios Approach uses the inputs and primary steps summarized in Figure 3.1 to provide key knowledge relevant to evaluation of MNA.

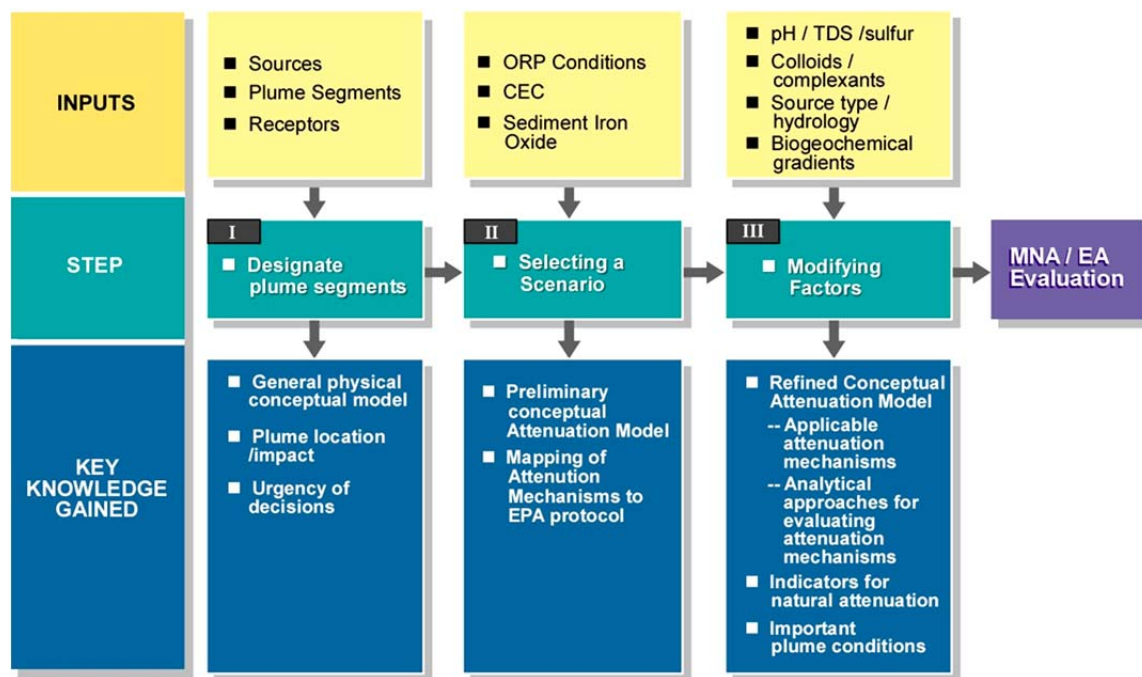

Figure 3.1. Summary of the Scenarios Approach inputs, steps, and key knowledge gained

2.0 Key Concepts

Reactive facies and biogeochemical gradients are key concepts used in the Scenarios Approach to facilitate effective evaluation of MNA and EA for a site. Figure 3.2 uses a hypothetical uranium plume to illustrate the nomenclature and relationships of the basic site and plume components (e.g., sources, plume segments, reactive facies, and geochemical gradients). This figure also shows an example biogeochemical gradient and how it is important to evaluate attenuation over time. Additional information about reactive facies and biogeochemical gradients is provided in Sections 2.1 and 2.2, respectively.

Section 3: Scenarios Evaluation Guide

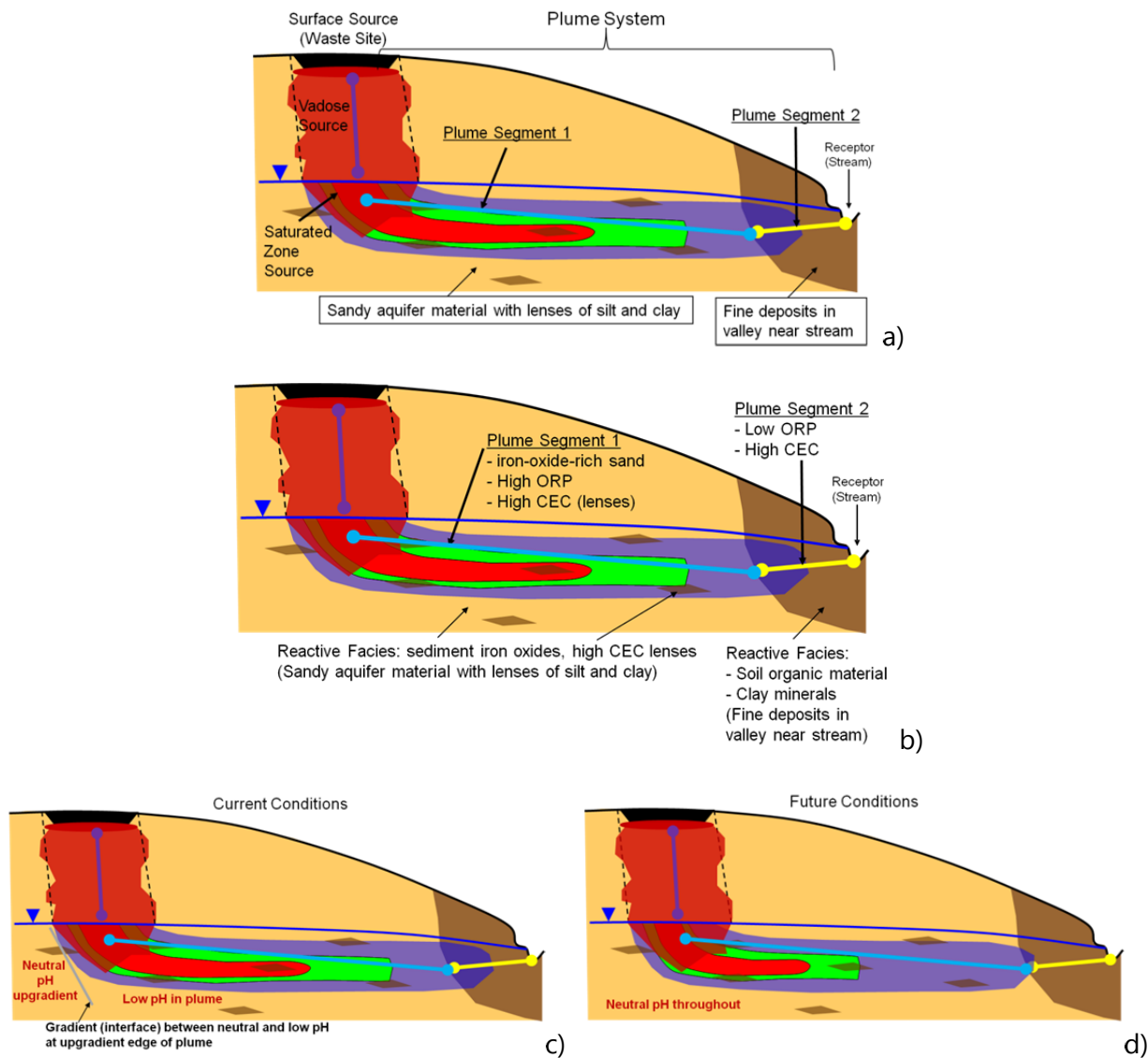

Figure 3.2. Plume nomenclature components (a) with identification of reactive facies (b). Biogeochemical gradients are illustrated using a hypothetical plume from a uranium-waste site under current site conditions (c) where the pH is low in the plume due to the waste discharge conditions, and in the future (d) the upgradient neutral pH groundwater has altered the geochemical conditions and impacted the plume. This change is important because the attenuation of uranium is higher under neutral conditions compared to low pH conditions. A key consideration in the MNA evaluation for uranium contamination is the rate at which the pH will evolve versus the rate of contaminant movement, but the important factors may be different for other contaminants. For example, if chromate [Cr(VI)] were the contaminant, the pH gradient would not be important. However, the low ORP segment would be a key factor in attenuation.

2.1 Reactive Facies

At most metals/radionuclide-contaminated sites, the ambient geochemistry controls the chemical form of the contaminant, not vice versa. That is, “facies controls fate,” with reactive facies being the term that describes the hydrogeochemical fabric of a site. Understanding the attenuation behavior of a metal or radionuclide contaminant requires the following:

- Understanding the reactive facies at a site
- Mapping contaminant-specific chemical behaviors onto these reactive facies.

The ORP, CEC, and sediment iron oxide content can have a significant effect on contaminant attenuation. Thus, the Scenarios Approach uses these parameters to define plume segments as portions of the subsurface with distinct characteristics with respect to contaminant attenuation. Each of these parameters can be associated with distinct features of the subsurface as a reactive facies.

For instance, layers or zones in the subsurface with high levels of soil organic matter may maintain low ORP, and these reactive facies would attenuate contaminants like chromium or uranium due to geochemical reduction. Thus, identifying these reactive facies is important for the attenuation conceptual model. Waste chemistry may temporarily alter ORP conditions, which is also important. However, this effect is temporary and would contribute to overall contaminant attenuation differently than a reactive facies with inherently low ORP conditions. Low ORP and high ORP facies are often associated with these conditions:

- Reactive facies associated with *low ORP* are typically identified based on high soil organic matter content. The soil organic matter induces microbial activity to maintain low ORP conditions. Lower permeability zones may also maintain lower ORP conditions under some conditions and should be evaluated as potential reactive facies associated with low ORP conditions.
- Reactive facies with *high ORP* have low soil organic matter content and significant water flow containing dissolved oxygen (e.g., typically higher permeability regions). The depositional environment and standard characterization information can provide a good starting point for identifying reactive facies for ORP conditions.

For some contaminants, cation exchange is the dominant mechanism that attenuates contaminant migration. Knowledge of the depositional environment and the distribution of clay materials can be helpful in identifying CEC reactive facies. Although oxide surfaces can contribute to soils' CEC, the Scenarios Approach primarily uses CEC as an indicator of attenuation on clay basal planes. Low and high CEC facies are often associated with these conditions:

- *High CEC facies* are typically comprised of fine-grained, clay-rich soils for certain types of clay minerals.
- *Low CEC facies* are typically comprised of coarse-grained soils lacking clays and organic matter.

Section 3: Scenarios Evaluation Guide

Sediment iron oxides are a key factor in adsorption for many contaminants. As with CEC, the sediment iron oxide content can be mapped based on limited borehole data and knowledge of the depositional environment to provide important information about the distribution of reactive facies where significant adsorption to iron oxides may attenuate contaminant transport. Low and high sediment iron oxide facies are very location specific, and soil testing may be required to determine the sediment iron oxide content in a particular facie.

In the Scenarios Approach, the primary criteria for selecting the appropriate individual scenario for a site are linked to identifying reactive facies in terms of the underlying primary plume migration controlling factors—ORP, CEC, and sediment iron oxide content (Figure 3.3). Other types of reactive facies may be important if they have a strong impact on the geochemistry related to contaminant attenuation. One example is carbonate because carbonate chemistry is important for uranium transport. The Scenarios Approach and the EPA Protocol (EPA 2007 a,b; EPA 2010) identify important geochemical factors for each contaminant. These factors should be considered when examining site data to evaluate the need to include additional types of reactive facies in the attenuation conceptual model.

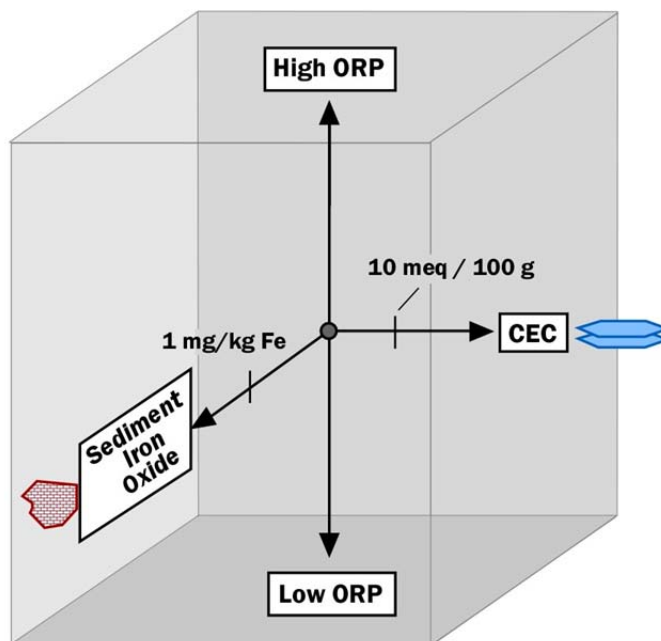

Figure 3.3. Important reactive facies related to metal and radionuclide attenuation. “High ORP” denotes oxidizing conditions ($E_H > 0$ mV); “Low ORP” denotes reducing conditions ($E_H < 0$ mV); and “Fe” refers to sediment iron oxide content. The dividing line between high and low sediment iron oxide content is 1 mg/g Fe under oxidizing conditions (no divide under reducing conditions); the dividing line between low and high CEC is 10 meq/100 g.

2.2 Biogeochemical Gradients

Biogeochemical gradients are created when waste disposal activities result in geochemically active constituents being introduced into an aquifer or when upgradient groundwater flow acts to slowly revert once-impacted aquifer zones to pre-waste conditions. Thus, biogeochemical gradients occur at an interface between geochemical groundwater regimes, and these interfaces can change position over time as one geochemical condition moves into another. A key concept for the Scenarios Approach is that natural and engineered biogeochemical gradients (e.g., ORP, pH, etc.), in conjunction with the distribution of reactive facies, control the migration of metals and radionuclides. That is, with information about the distribution of reactive facies and understanding of biogeochemical gradients and how they can change geochemical conditions with time, researchers can identify where and when contaminants will attenuate and be mobile.

Key Definition

An aquifer is an underground bed or layer of permeable rock, sediment, or soil that yields water. Some regulatory programs use the term “water-bearing unit” to reflect that remediation activities are focused on a wide range of hydrogeologic units and not just drinking water aquifers.

In this Scenarios Approach document, “aquifer” and “water-bearing unit” can be used interchangeably.

A contaminant plume is a transient perturbation of natural conditions within an aquifer. The contrast between the geochemical conditions within the plume and the natural geochemical conditions of the aquifer dictate that conditions in the subsurface will evolve as the plume moves. Thus, at any given location, natural attenuation mechanisms will also evolve with time. At some sites, a pendulum is a conceptual model used to illustrate the waste site life cycle (Figure 3.4). Under natural conditions, the pendulum hangs vertically. When the pendulum is perturbed by introduction of waste, it moves away from vertical; when the force that perturbs it ceases, its natural tendency is to move back toward vertical. Without intervention, the further the pendulum has been moved from vertical, the longer it will take to return to natural conditions.

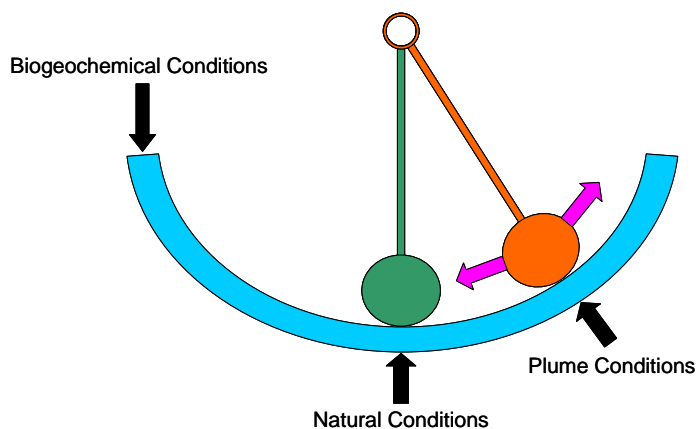

Figure 3.4. Analogy of pendulum to waste site life cycle

Section 3: Scenarios Evaluation Guide

The life cycle of a waste site begins when a waste source is created (typically many years ago; relatively few new waste sources are created now) and a plume is introduced to the subsurface—the life cycle ends when the subsurface is returned to near-natural biogeochemical conditions. The waste site may not return to exactly the same conditions that existed before the plume was introduced because the plume may induce some permanent changes in mineralogy, microbiology, and hydrology, but the site will always evolve toward that condition. Attenuation mechanisms for metals and radionuclides depend on chemical, mineralogical, microbiological, and hydrological conditions. If a particular contaminant at a waste site will be mobile under natural conditions, natural attenuation alone is unlikely to be a successful remedy. However, if a contaminant will be sufficiently attenuated under natural conditions, natural attenuation may be an option that deserves further consideration. Knowing that a waste site will move toward natural conditions is the simplest form of using waste site evolution to predict the potential success of a natural attenuation remedy. If natural attenuation is considered a potentially viable remedy or part of a remedy, the analysis of rate and extent of waste site evolution should be included as part of the remedy assessment.

One organizing principle to simplify understanding of the overall biogeochemical evolution of waste sites is that the most dynamic changes in contaminant attenuation occur at biogeochemical gradients induced by the plume. Figure 3.5 shows a hypothetical plume emanating from an industrial source at the surface. When the contaminant plume is introduced to the subsurface, a *leading biogeochemical gradient* is created when the leading edge of the plume displaces natural undisturbed groundwater. Dilution of the plume, reaction with aquifer minerals, adsorption of plume constituents, desorption of natural constituents, and changes in microbiology can all occur at this gradient. Different types of gradients may occur and migrate at different rates, though all are driven by the same hydrodynamic forces. As an example, consider that migration of a leading gradient caused by dilution alone is unimpeded by chemical reactions. In contrast, migration of a pH gradient is impeded by the buffering reactions associated with aquifer mineral dissolution and adsorption of free protons (H^+). Likewise, migration of a leading ORP gradient can be impeded by microbiological reactions and reaction with ORP-sensitive aquifer minerals.

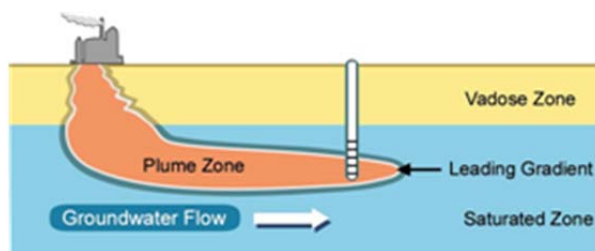

Figure 3.5. Illustration shows leading biogeochemical gradient in front of a contaminant plume. Biogeochemical conditions will evolve over time as the plume migrates.

Trailing biogeochemical gradients form where upgradient groundwater or rainwater flows into the infiltrating plume or enters the zone affected by the plume. As long as plume infiltration is relatively constant, the trailing gradient is stationary. After the source flux is eliminated or substantially reduced, the trailing gradient migrates into and through the plume zone (Figure 3.6). The rate of migration of trailing gradients are controlled by groundwater flow, dilution and dispersion, reaction of solutes with plume-altered minerals, and the influx or elimination of nutrients to sustain microbial growth. Examples of reactions with plume-altered minerals are desorption of free protons from plume zone minerals, or oxidation of reduced minerals created within the plume zone.

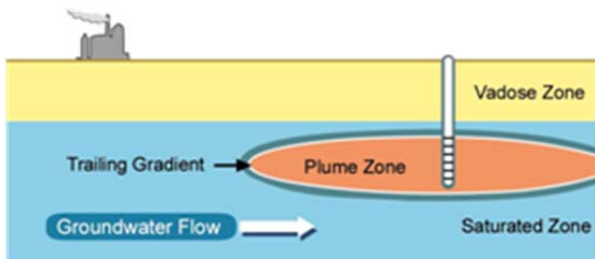

Figure 3.6. Illustration shows trailing spatial biochemical gradient where background groundwater encounters a contaminant plume. Biogeochemical conditions will evolve as background groundwater enters the current plume zone.

The biogeochemical gradient concept can simplify long-term prediction of natural attenuation by enabling contaminants to be classified by how contaminant migration is controlled. Migration of some contaminants will be controlled only by dilution, some will be controlled predominantly by pH, and others will be controlled predominantly by ORP conditions. Large changes in contaminant mobility only occur across sharp gradients in these controlling factors. Thus, the attenuation of contaminants is controlled by the migration rates of these gradients.

Another way in which consideration of biogeochemical gradients simplifies long-term prediction of natural attenuation is that it compartmentalizes characterization and modeling into zones of importance. This approach is based on the recognition that large changes in mobility only occur across controlling biogeochemical gradients. It focuses characterization and modeling on the leading and trailing gradients, which are most important in controlling overall contaminant mobility. For example, consider an acidic plume with contaminants predominantly controlled by adsorption, which in turn is controlled by pH. It is more important to characterize what is present in the downgradient flow of the leading pH gradient than what is between the leading and trailing gradient. Likewise, it is more important to understand and model the processes occurring in those parts of the aquifer in the vicinity of the gradients; less emphasis can be given to parts of the aquifer between these gradients.

Key Definition

A *biogeochemical gradient* is an interface between different geochemical conditions. This gradient can be for pH, ORP conditions, or other factors. Over time, geochemical conditions and associated gradient magnitude and location can change due to groundwater movement, for instance, as upgradient neutral pH water displaces low pH water in the plume (see Figure 3.2).

Key Concept

Large changes in contaminant mobility can occur across biogeochemical gradients.

Section 3: Scenarios Evaluation Guide

3.0 The Scenarios Approach

Section 1, "Scenarios User Guide" provides information for selecting a scenario(s) appropriate to the site. Six possible scenarios are shown in Table 3.2. For context, Figure 3.7 maps the scenarios in Table 3.2 to the reactive facies concept outlined in Figure 3.3.

Table 3.2. Scenario Selection

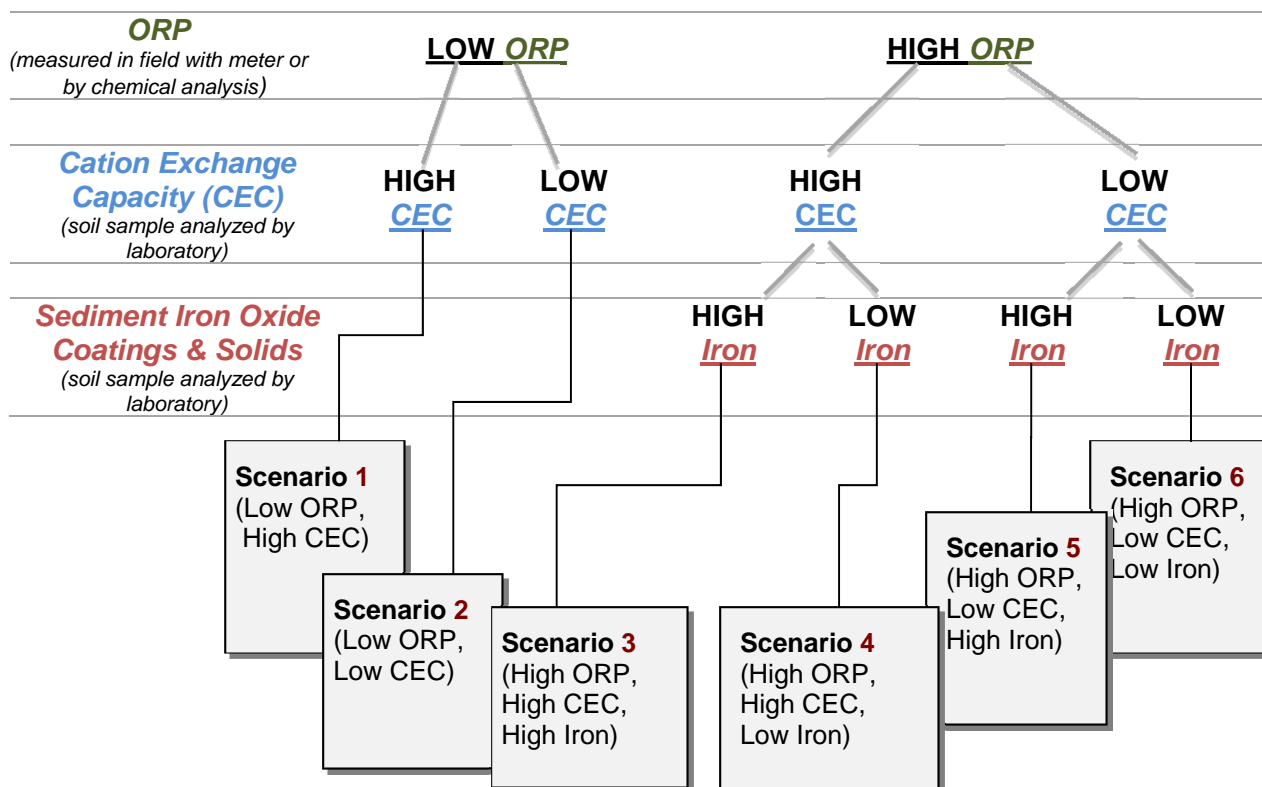

For discussions of CEC and iron oxide measurement approaches, see Sections IIB.1.3 and IIIB.2.4, respectively, of *Monitored Natural Attenuation of Inorganic Contaminants in Ground Water Volume 1 - Technical Basis for Assessment* (EPA 2007a).

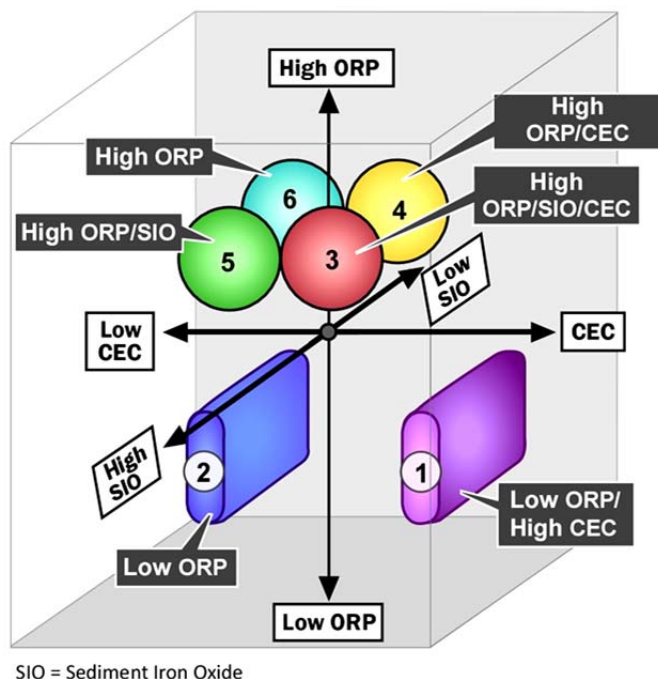

Figure 3.7. Three-dimensional chart mapping the six scenarios as reactive facies. Each reactive facies is associated with a unique combination of ORP conditions (oxic or anoxic), CEC (high or low), and sediment iron oxide content (high or low). For example, Scenario 3 corresponds to oxic conditions, high CEC, and high sediment iron oxide content (note that sediment iron oxides are not considered under anoxic conditions).

4.0 Evaluation Guide

The following sections provide information and additional details intended to augment the evaluation process outlined in each scenario.

4.1 Overview of Contaminant Mobility

Each scenario incorporates information about the potential mobility of each contaminant under the conditions expected for that scenario. The notion of contaminant mobility is based on the contaminant's retardation factor, R and is divided into three categories for R —high, medium, and low. In general, contaminants that sorb strongly have low mobility and large retardation factors ($R > 1000$), and vice versa. A mobility table (Table 3.3) was developed to categorize contaminant "mobility potential" as a summary of the contaminant behavior under the conditions that dominate each scenario. Table 3.3 also includes primary modifying factors of pH, total dissolved solids (TDS), and the presence of sulfur; the table indicates how these factors may impact contaminant mobility.

To use Table 3.3, examine the mobility of contaminants at the site (or plume segment) for the appropriate scenario. Consider how variations in key parameters might impact the general

Section 3: Scenarios Evaluation Guide

mobility. For instance, if sediment iron oxide content is generally high, look at adjacent scenarios to examine how heterogeneous conditions with locations of lower sediment iron oxide content might impact mobility. Similarly, the distribution of CEC at a site may be variable with high CEC in clay lenses and low CEC in adjacent sands. Table 3.3 can be used to examine the impact of high and low CEC on the contaminants at the site.

Contaminant plume conditions may change over time. For a description of how biogeochemical gradients impact attenuation, see Section 3, "Scenarios Evaluation Guide." For example, if low ORP or low pH conditions are caused by a waste source, then ORP conditions will become more oxidizing over time and/or the pH will increase over time as the waste source diminishes or is remediated. Future ORP conditions should be evaluated using the appropriate scenario. The pH, ORP, sulfur compound concentrations, and total dissolved solids are examples of key parameters that may change at a site due to biogeochemical gradients. The general impact of these changes on contaminant mobility can be evaluated using the information in Table 2.1.

For example, the pH can impact the solubility and sorption of some contaminants and change the contaminant mobility (see inset box). Table 3.3 also provides the overall impact of pH on mobility.

The mobility table (Table 3.3) is qualitative and used to identify those factors that merit the most attention for a contaminant under each scenario.

Note: The contaminants considered in the Scenarios Approach documents (Sections 1, 2, and 3) are the same contaminants covered in the EPA Protocol with the exception of mercury, tritium, radon, americium, and thorium. Information pertinent to mercury contamination is provided in Appendix B of Section 3, "Scenarios Evaluation Guide." Information pertinent to tritium, radon, americium, and thorium contamination is provided in Appendix C of Section 3, "Scenarios Evaluation Guide."

Key Concept Example of pH Impact on Mobility

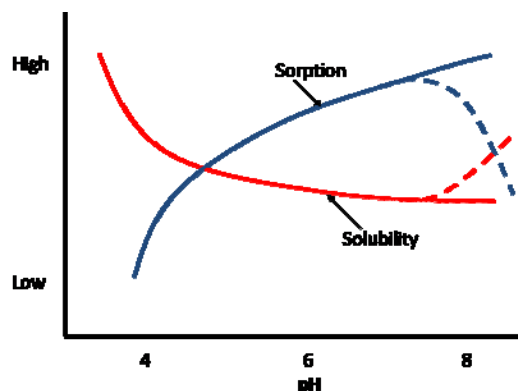

In almost all cases, pH below neutral causes an increase in solubility and often a decrease in sorption – mobility also increases.

Above neutral pH, mobility may *decrease* due to lower solubility and higher sorption (solid lines) or *increase* due to higher solubility and lower sorption (dashed lines).

Section 3: Scenarios Evaluation Guide

Table 3.3. Summary of Contaminant Mobility for 4 < pH < 9. See text for discussion of extreme chemistries and special considerations.

Contaminant	Scenarios					
	Scenario 1 <i>low ORP high CEC</i>	Scenario 2 <i>low ORP low CEC</i>	Scenario 3 <i>high ORP high CEC high SIO¹</i>	Scenario 4 <i>high ORP high CEC low SIO¹</i>	Scenario 5 <i>high ORP low CEC high SIO¹</i>	Scenario 6 <i>high ORP low CEC low SIO¹</i>
Cr(III)						
Cr(VI)						
⁹⁹Tc(IV)						
⁹⁹Tc(VII)						
Pu						
U						
Cd, Cu, Pb, Zn						
Ni						
As						
Se						
⁹⁰Sr, Cs², Ra³						
NO₃⁻, ClO₄⁻	<i>can degrade</i>	<i>can degrade</i>				
¹²⁹I						

HIGH Mobility	Mobility increases above and below pH7	Increasing sulfur <u>decreases</u> mobility
MEDIUM Mobility	Mobility increases above pH7	Increasing TDS <u>increases</u> mobility
LOW Mobility	Mobility decreases above pH7 and increases below pH7	Transformed to other valence state

¹SIO: Sediment Iron Oxide content
²Cs attenuation is significantly increased when micaceous clays are present
³Radium forms RaSO₄ solids that may be important for attenuation

Special Cases

At some sites—and for some contaminants—certain special cases and extreme geochemical conditions can impose significant impact on contaminant attenuation.

Carbonate Alkalinity: Carbonate alkalinity is particularly important because carbonate can act as a mobilizing ligand, especially for uranium, while potentially decreasing the solubility of lead, cadmium, zinc, and nickel. Thus, assessment of sites with high carbonate concentrations or potential changes in carbonate concentration needs to consider carbonate geochemistry, particularly if uranium is a contaminant of concern.

Extremely Basic Conditions (pH > 9): Highly basic waters require special attention when contaminants are present that do not form insoluble metal-carbonates but do form metal-carbonate complexes and/or hydrolyze. Trivalent and quadrivalent cations such as Cr(III) and Tc (IV) are in this category. Because highly basic waters often have high carbonate alkalinity, uranium will also tend to be more mobile at pH > 9.

Extremely Acidic Conditions (pH < 4): Extremely acidic conditions will cause mobilization of most metals—the one caveat is high sulfide levels (due to incomplete oxidation) may result in formation of insoluble metal sulfides.

4.2 Actions and Linkage to the EPA Protocol

EPA's tiered approach (EPA Protocol, Section 1C of Vol. 1 [EPA 2007a]) is schematically illustrated in Figure 3.8 and compared to plume behavior and distance to a receptor. For example, the following would apply to the EPA tiered approach:

- MNA is more likely to be a stand-alone remedy when a contaminant plume is shrinking. MNA is unlikely to be relied on solely when the plume is growing and close to receptors.
- EA should be considered in some cases to enable obtaining or ensuring Tier IV where MNA alone is insufficient.

The EPA tiered approach progressively evaluates the suitability of MNA. Sites inappropriate for MNA are identified first using a minimum of data. These Tier I sites are eliminated largely by showing that contaminant removal is not occurring. Sites where contaminant removal by natural processes does appear to be occurring are categorized as Tier II, where mechanism(s) and removal rates are estimated. Tier II sites where attenuation is occurring at rates too low to protect potential receptors remain at Tier II. If the attenuation mechanism(s) can be established and attenuation rates demonstrated to be potentially protective of receptors, Tier II sites are then categorized as Tier III. Tier III analysis involves modeling the system capacity for attenuation—typically, this is the abundance of reactants along the path separating the plume from receptors. Tier III sites that possess more than sufficient reactants to attenuate all contamination are categorized as Tier IV. Tier IV analysis involves developing a performance

monitoring program while considering alternative remediation approaches (EPA Protocol, Section 1E of Vol. 1 [EPA 2007a]).

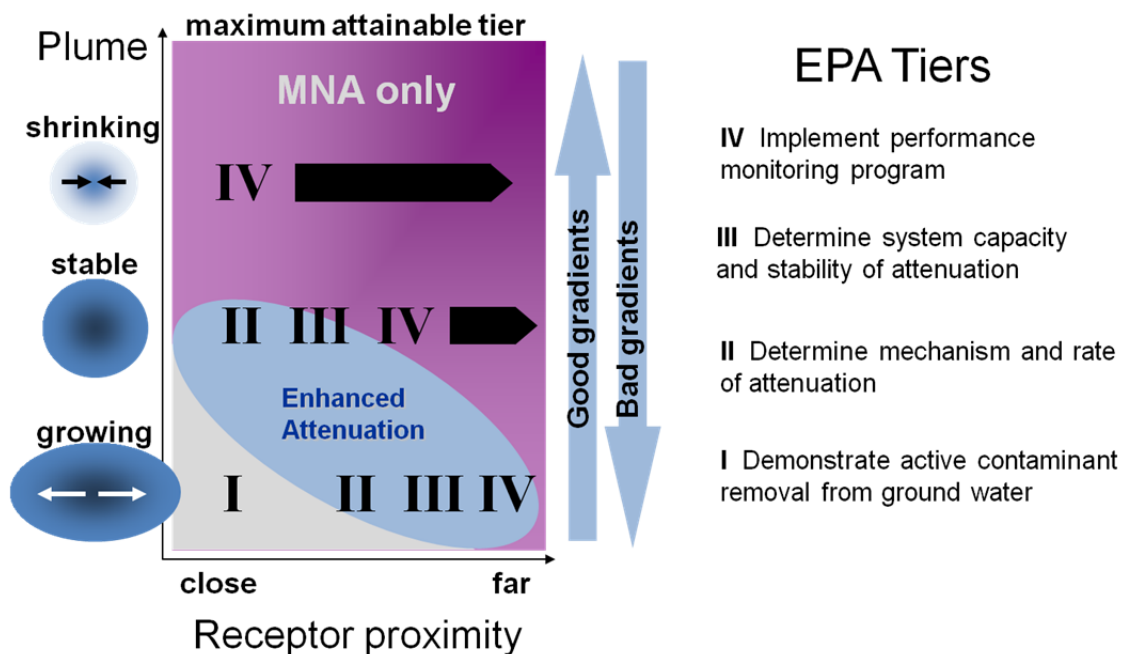

Figure 3.8. Schematic of the EPA tiered approach to MNA implementation plotted against plume behavior and receptor proximity. Enhanced Attenuation may enable obtaining Tier IV for cases with stable or currently growing plumes. Gradients, as indicated on the right side of the figure, can change conditions over time and thereby change the ability for MNA to be suitable as a remedy. Some gradients are “good” in that they improve attenuation capacity and rate over time. Other “bad” gradients may be detrimental to attenuation processes.

Development of an Attenuation Conceptual Model is central to how the Scenario Approach augments the tier analysis of the EPA approach. The Scenarios Approach considers multiple aspects (plume status, biogeochemical gradients, receptor proximity, enhancements) and both current and future site conditions in evaluating MNA and augmenting as necessary (i.e., EA). The Scenarios Approach also provides options for how to incorporate MNA and EA into solutions and be compliant with the EPA Protocol and MNA guidance. For example, the Scenarios Approach promotes consideration of beneficial biogeochemical gradients that may make MNA viable when

Key Point

The EPA guidelines are a standalone description of how to implement MNA. The Scenario Approach presented here is a means of categorizing conceptual models and mechanisms to facilitate the evaluation and implementation process and for considering enhanced attenuation (Section 4.3). The terms “reactive facies” and “biogeochemical gradients” are not part of the EPA guidelines. However, their usage is consistent with EPA guidelines. The concepts are introduced here to guide effective identification and deployment of MNA or Enhanced Attenuation (Section 4.3).

Section 3: Scenarios Evaluation Guide

current conditions appear unfavorable.

4.3 Attenuation Conceptual Model

At the core of the Attenuation Conceptual Model is an understanding of site-specific attenuation mechanisms, contaminant fluxes, and gradients (Figure 3.9). Fluxes from the source are reduced through attenuation mechanism(s) along the flow-path. Attenuation mechanisms are a function of reactive facies and biogeochemical gradients.

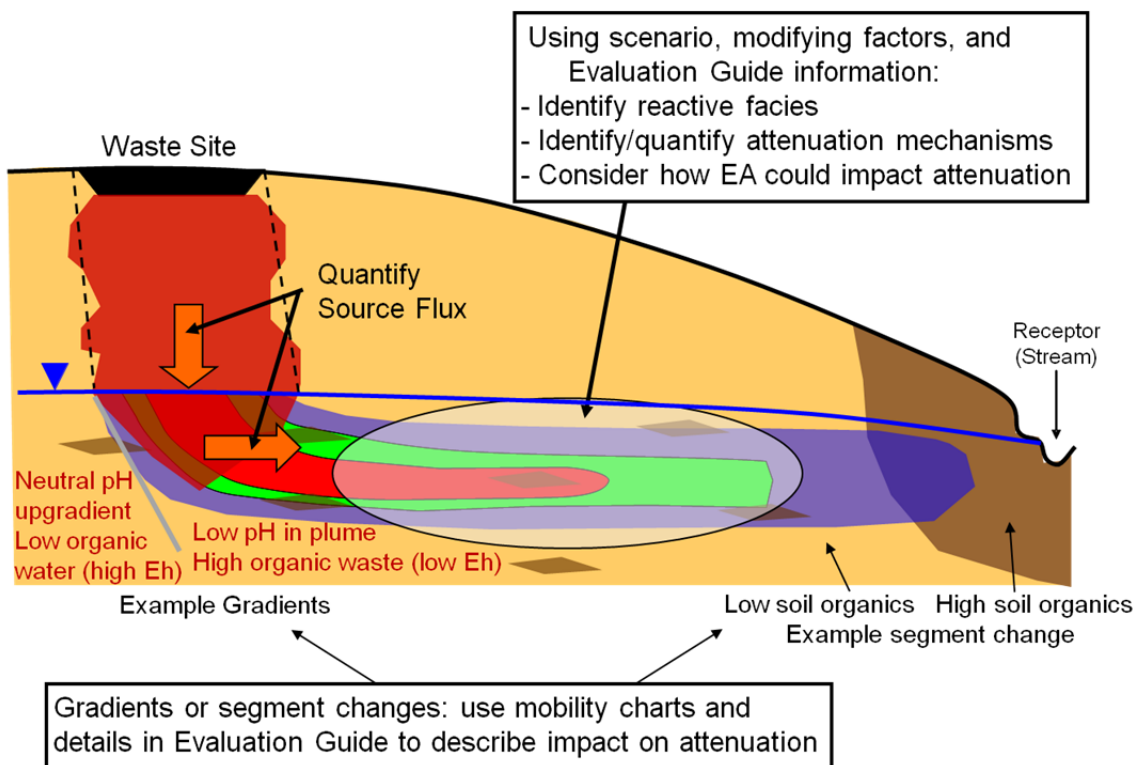
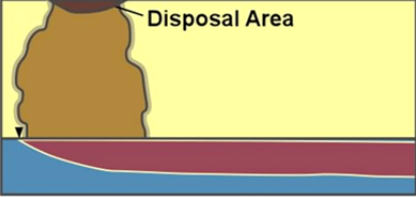
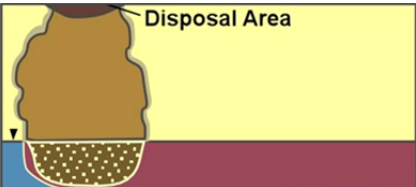
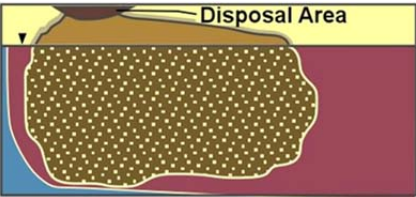

Figure 3.9. Conceptual model elements

4.3.1 Physical and Flux Components of the Attenuation Conceptual Model

Physical and flux aspects of the attenuation conceptual model include the source flux, hydrology, and travel time factors. Specific considerations of source term strength include the mass distribution, the source flux, and source longevity. Table 3.4 presents typical categories of sources. Table 3.5 presents typical hydrology and travel time factors that need to be considered.

Table 3.4. Source Configurations and Associated Considerations for Attenuation-Based Remedies

Source Type	Source Flux	Longevity
<p>Vadose Bleed</p> 	<p>Waste discharge relative to the vadose zone size was small enough that high concentrations of contaminants did not reach the aquifer beneath the waste site. Flux from the vadose zone into the aquifer is dependent on recharge and drainage.</p>	<p>While the magnitude of the source flux may be low, it may continue over a long period, driven by slow recharge and drainage from the vadose zone.</p>
<p>Vadose Bleed + Localized Submerged</p> 	<p>Waste discharge is sufficient to drive high concentrations of contaminants into the aquifer beneath the waste site. Current flux from the vadose zone is dependent on recharge and drainage, but likely much lower now than during the historical disposal period. High contamination zone in the aquifer can be a significant continuing source depending on the rate of release from solids. Release rate due to sorption and solubility may be influenced by biogeochemical gradients.</p>	<p>A moderately large total mass of sediment-associated contaminant may be present in the aquifer, and source longevity will likely be long-term and controlled by sorption and solubility as influenced by biogeochemical gradients. For low sorption/high solubility contaminants (e.g., anions such as chloride), the source longevity may be short in the groundwater, but the vadose zone recharge may be of concern and occur over a long time frame.</p>
<p>Vadose Bleed + Dispersed Submerged</p> 	<p>Large distribution of contaminants resulted from initial high discharge. Current flux from the vadose zone is dependent on recharge and drainage, but likely much lower now than during the historical disposal period. Large distribution in aquifer can be a significant continuing source dependent on the rate of release from solids. Release rate due to sorption and solubility may be influenced by biogeochemical gradients.</p>	<p>A large total mass of sediment-associated contaminant may be present in the aquifer, and source longevity will likely be long term and controlled by sorption and solubility as influenced by biogeochemical gradients. For low sorption/high solubility contaminants (e.g., anions such as chloride), the source longevity may be short in the groundwater, but the vadose zone recharge may be a concern and occur over a long time frame.</p>

Section 3: Scenarios Evaluation Guide

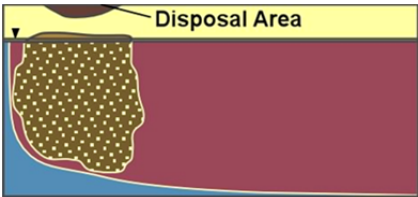
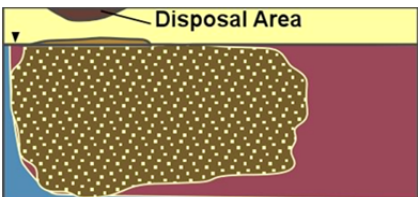
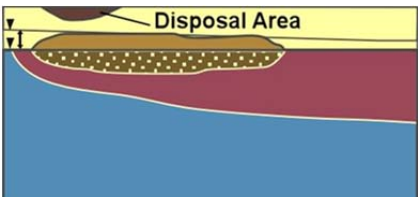
Source Type	Source Flux	Longevity
<p>Localized Submerged</p> 	<p>Waste discharge sufficient to drive high concentrations of contaminants into the aquifer beneath the waste site. Source flux from the vadose zone is no longer present. High contamination zone in the aquifer can be a significant continuing source dependent on the rate of release from solids. Release rate due to sorption and solubility may be influenced by biogeochemical gradients.</p>	<p>A moderately large total mass of sediment-associated contaminant may be present in the aquifer, and source longevity will likely be long-term and controlled by sorption and solubility as influenced by biogeochemical gradients. For low sorption/high solubility contaminants (e.g., anions such as chloride), the source longevity may be short in the groundwater.</p>
<p>Dispersed Submerged</p> 	<p>Large distribution of contaminants resulted from initial high discharge. Source flux from the vadose zone is no longer present. Large distribution in the aquifer can be a significant continuing source dependent on the rate of release from solids. Release rate due to sorption and solubility may be influenced by biogeochemical gradients.</p>	<p>A large total mass of sediment-associated contaminant may be present in the aquifer and source longevity will likely be long term and controlled by sorption and solubility as influenced by biogeochemical gradients. For low sorption/high solubility contaminants (e.g., anions such as chloride), the source longevity may be short in the groundwater.</p>
<p>Concentrated Water Table Source</p> 	<p>Contaminants have been retained near the water table interface and the source flux is a function of the recharge rate, variations in water table elevation, and the contaminant sorption and solubility. Assessment of biogeochemical gradients may need consideration of changes due to water table variations and interface with the vadose zone.</p>	<p>While the magnitude of the source flux may be low, it may continue over a long period, driven by recharge and enhanced when water table variations periodically contact contaminated vadose zone sediments.</p>

Source Type	Source Flux	Longevity
<p>Concentrated Water Table Source + Dispersed Submerged Source</p> 	<p>Large distribution of contaminants resulted from initial high discharge. Source flux from the vadose zone is no longer present. Large distribution in aquifer can be a significant continuing source dependent on the rate of release from solids. Release rate due to sorption and solubility may be influenced by biogeochemical gradients. Contaminants have been retained near the water table interface and the source flux is a function of the recharge rate, variations in water table elevation, and the contaminant sorption and solubility. Assessment of biogeochemical gradients may need consideration of changes due to water table variations and interface with the vadose zone.</p>	<p>A large total mass of sediment-associated contaminant may be present in the aquifer and source longevity will likely be long-term and controlled by sorption and solubility as influenced by biogeochemical gradients. For low sorption/high solubility contaminants (e.g., anions such as chloride), the source longevity may be short in the groundwater. However, the source flux may continue over a long period, driven by recharge and enhanced when water table variations periodically contact contaminated vadose zone sediments.</p>
<p>Submerged Low Permeability Bleed</p> 	<p>Remaining contaminants are located in low permeability zones that have low advective flow compared to surrounding aquifer zones. Source flux may be low and controlled by diffusion from low permeability sediments. Biogeochemical gradients at the interface of low and high permeability zones may be important to consider. Biogeochemical conditions within the low permeability zones may be stable over time.</p>	<p>While the magnitude of the source flux may be low, it may continue over a long period, driven by diffusion from low permeability sediments.</p>

Table 3.5. Hydrology and Time to Receptors Considerations

Factor	Characteristic	Potential Impact
Hydrologic Setting	Simple	<ul style="list-style-type: none"> • Regular plume shape • More uniform sorption • Fewer vertical monitoring issues
	Complex	<ul style="list-style-type: none"> • Potential for irregularities in plume velocity and shape • Presence of zones that may have different sorption characteristics or slowly release contaminant over time • Large variations in concentration over short distances (a few meters) • Vertical monitoring issues may be important
Groundwater Flow Rate	Slow	<ul style="list-style-type: none"> • Lower contaminant flux • Low rate of change in biogeochemical gradients • Slow plume evolution rate • Less frequent monitoring • Plume will stabilize slowly if at all
	Fast	<ul style="list-style-type: none"> • Higher contaminant flux • High rate of change in biogeochemical gradients • Quick plume evolution rate • More frequent monitoring • Plume may stabilize quickly
Type of Discharge	Surface water	<ul style="list-style-type: none"> • Attenuation mechanisms and contaminant concentrations may change at surface water sediment discharge zone • May need to consider surface water dynamics and impact on aquifer gradients
	Groundwater	<ul style="list-style-type: none"> • May need to consider receptor well configuration and dynamics
Receptor Location	Close	<ul style="list-style-type: none"> • More frequent monitoring possible • Limited room for plume expansion before stabilization • Shorter time for evaluation, decisions, and implementing enhancements
	Far	<ul style="list-style-type: none"> • Less frequent monitoring possible • Room for plume expansion prior to stabilization • Longer time for evaluation, decisions, and implementing enhancements

4.3.2 Contaminant Behavior Components of the Attenuation Conceptual Model

The mobility charts in the Scenarios Approach provide an overview of contaminant mobility and the impact of gradients on this mobility. A series of more detailed attenuation mechanism conceptual models is provided to augment information as needed. The attenuation mechanism conceptual models are based on the mechanism elements shown in Figure 3.10. For example, decay will be an important mechanism for attenuation of short-lived radionuclides; solubility will be an important mechanism for inorganic compounds that form insoluble solids under the conditions of a particular scenario, and so on. The relative importance of individual mechanisms identified in Figure 3.10 are contaminant specific and also depend on the Scenario Approach selection factors and primary modifying factors. Attenuation mechanisms are also discussed in the EPA Protocol Section IIB, Vol. 1 (EPA 2007a) and in the individual contaminant sections of Vol. 2 (EPA 2007b) and Vol. 3 (EPA (2010)).

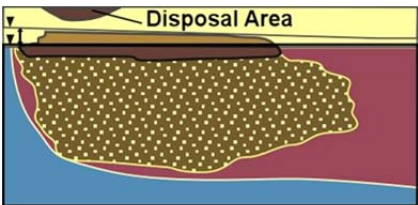
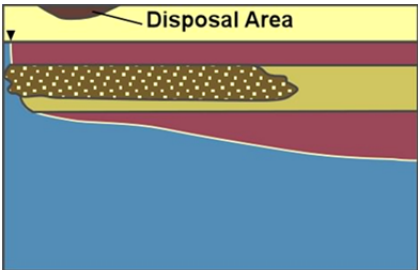
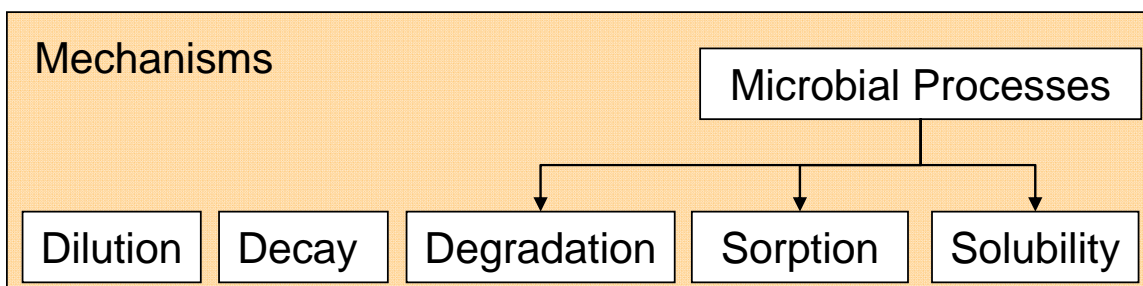

Figure 3.10. Attenuation mechanisms chart showing the five key attenuation mechanisms: dilution, decay, degradation, sorption, and solubility. The last three are influenced by microbial processes via changes in ORP conditions (oxic versus anoxic).

The key analytical methods related to three of the attenuation mechanisms are summarized in Figure 3.11. The scenarios conceptual model section is intended to highlight important data needs and identify less likely attenuation paths that do not require significant evaluation/data.

Degradation	Sorption	Solubility	
Substrate identification ORP assessment	Speciation calculations Ligand identification ORP assessment	Speciation calculations Ligand identification ORP assessment	Speciation
Not Applicable	Iron oxide availability Cation exchange capacity Surface area	Solubility calculations Surface characterization (XRF, XRD, etc.)	Host/Solid
Rate calculations or laboratory/field evaluation of degradation	Laboratory/field demonstration of sorption/desorption	Not Applicable	Quantity

Figure 3.11. Analytical approaches needed for evaluating attenuation mechanism(s)

The analyses described above are discussed broadly in the EPA Protocol, Vol. 1 (EPA 2007a). Speciation/solubility calculations and ORP assessment are covered in ID.2.3-4 (and IIIB.3.5) and IIIC.1-3, respectively, of the EPA Protocol. Iron availability, X-ray diffraction, X-ray fluorescence, and surface characterization in general are described in IIIB.2. Sorption assessments are described in IIIB.2 and IIIB.3 of the EPA Protocol.

For each of the potential contaminants—or groupings of contaminants, as appropriate—an attenuation conceptual model is presented in Sections 4.3.3 to 4.3.12 with an associated linkages to appropriate analysis techniques in the EPA Protocol and the impact of the scenario selection factors and primary modifying factors on contaminant transport. Note that green boxes indicate this process is active; a white box indicates this process is usually unimportant. The impact of secondary modifying factors at the site are then discussed in the context of all potential contaminants (Section 4.3.13). Volumes 2 (EPA 2007b) and 3 (EPA 2010) of the EPA Protocol devote individual chapters to extensive discussions of each contaminant. The below summary of attenuation mechanisms is therefore brief.

Section 3: Scenarios Evaluation Guide

The index to the contaminant-specific attenuation mechanism conceptual models is as follows:

<i>Chromium (III) and Technetium (IV):</i>	Section 4.3.3
<i>Chromium (VI) and Technetium-99 (VII):</i>	Section 4.3.4
<i>Plutonium:</i>	Section 4.3.5
<i>Uranium:</i>	Section 4.3.6
<i>Cadmium, Copper, Lead, Nickel, and Zinc:</i>	Section 4.3.7
<i>Arsenic:</i>	Section 4.3.8
<i>Selenium:</i>	Section 4.3.9
<i>Strontium-90, Cesium, and Radium:</i>	Section 4.3.10
<i>Nitrate and Perchlorate:</i>	Section 4.3.11
<i>Iodine-129:</i>	Section 4.3.12

4.3.3 Chromium (III) and Technetium (IV)

Insoluble chromium (III) oxides tend to limit dissolved Cr levels to below the MCL under low ORP conditions. Only at very high pH does the solubility of Cr(III) exceed the MCL. Under low ORP conditions, chromate would likely be converted to Cr(III) by microbial activity or by other reduced species (e.g., reduced iron). After chromate is reduced to Cr(III), it does not reoxidize except under unique conditions (e.g., high manganese concentrations). Tc(IV) compounds formed under low ORP conditions are relatively insoluble. However, if conditions become more oxidizing, Tc(IV) can be readily oxidized to more mobile Tc(VII).

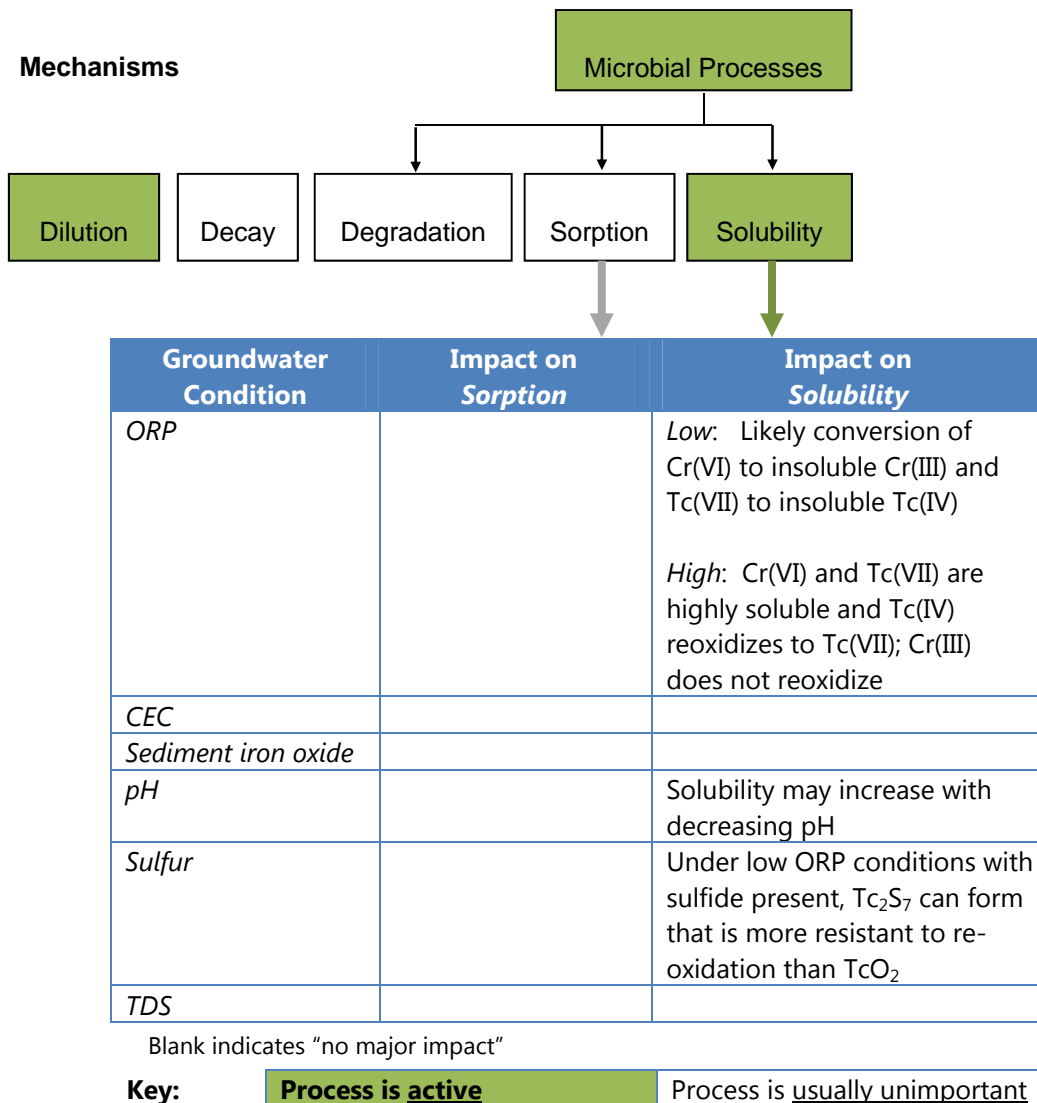

4.3.4 Chromium (VI) and Technetium-99 (VII),

Under high ORP conditions, Cr(VI) and Tc(VII) are mobile anions. Under low ORP conditions, chromate would likely be converted to Cr(III) by microbial activity or by other reduced species (e.g., reduced iron). After chromate is reduced to Cr(III), it does not reoxidize except under unique conditions (e.g., high manganese concentrations). Tc(IV) compounds are formed under low ORP conditions and are relatively insoluble. However, if conditions become more oxidizing, Tc(IV) can be readily oxidized to more mobile Tc(VII).

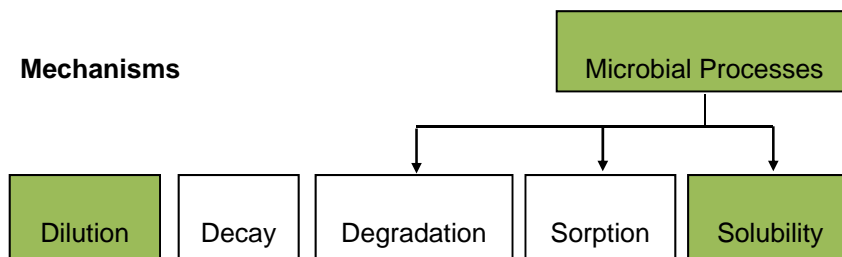

4.3.5 Plutonium

Plutonium has four possible oxidation states (i.e., +3, +4, +5, and +6) and can exist in any of these in aqueous solutions. The +4 state is the most stable state in soils, and plutonium in this form sorbs to clays and forms sparingly soluble hydroxides as well. It also forms colloidal species that are able to enhance its otherwise predicted slow transport through soils. High ORP conditions tend to favor more soluble plutonium compounds, as would high pHs and carbonate alkalinity due to the likely formation of plutonium hydroxy/carbonate species.

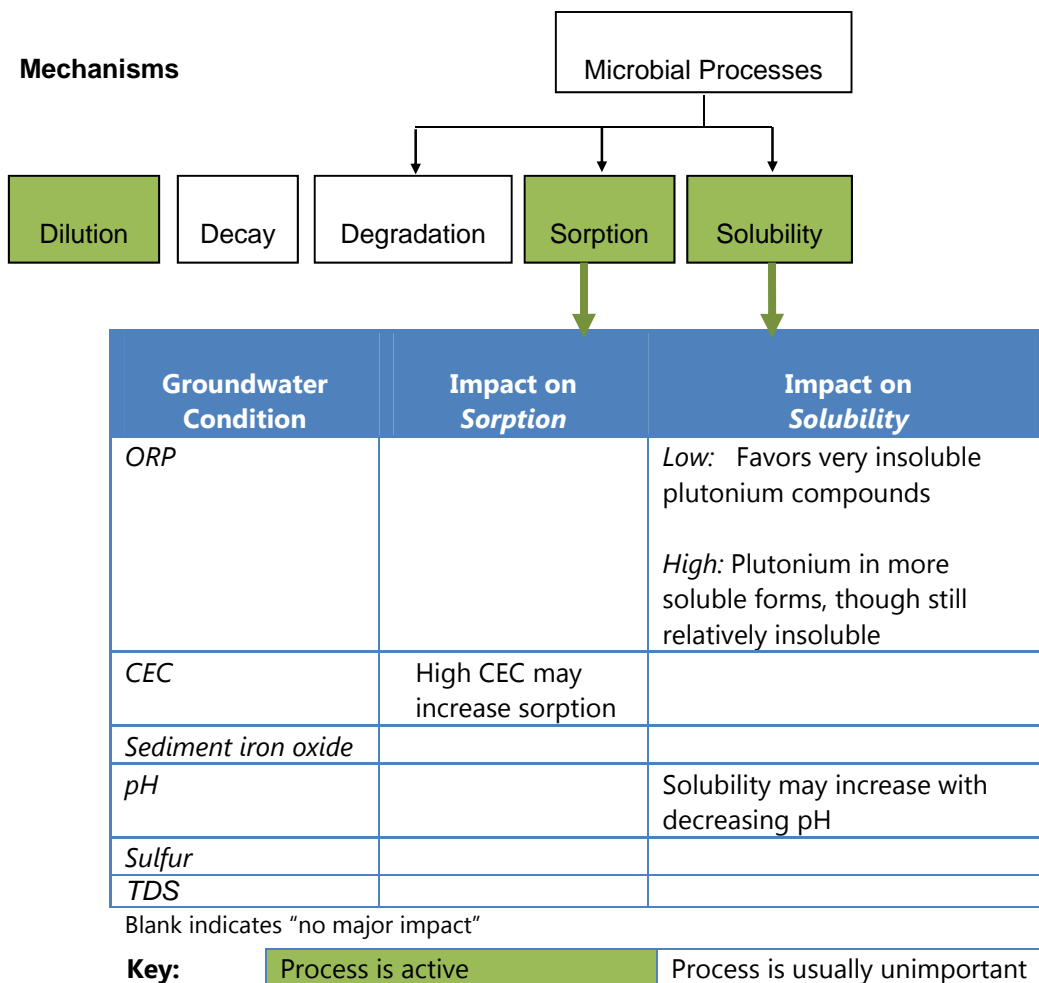

Section 3: Scenarios Evaluation Guide

4.3.6 Uranium

Under low ORP conditions, uranium will likely form low solubility U(IV) hydroxide and/or silicate solids. However, if conditions become more oxidizing, U(IV) can be oxidized to more mobile U(VI). Under high ORP conditions, only highly soluble U(VI) solids form. U(VI) sorbs, particularly to iron (hydr)oxides at near neutral pHs. In particular, high carbonate alkalinity leads to the formation of poorly sorbing anionic, uranyl-carbonate species.

Mechanisms

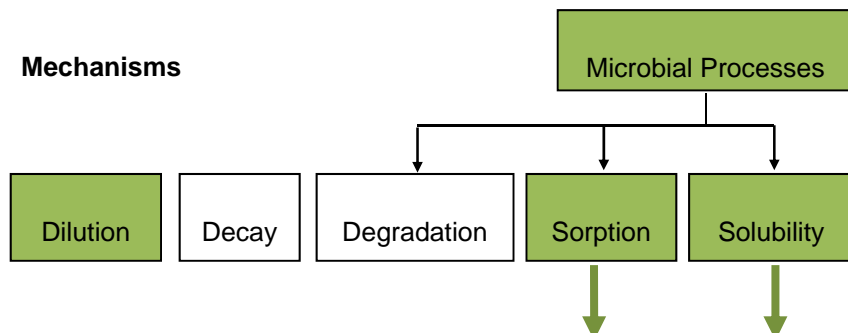

Groundwater Condition	Impact on Sorption	Impact on Solubility
ORP		<i>Low:</i> Most uranium compounds are relatively insoluble under low ORP conditions <i>High:</i> Uranium is generally soluble; U(IV) reoxidizes to U(VI)
CEC		
Sediment iron oxide	Iron oxides are major sorption sites for uranium	
pH	Sorption may decrease with decreasing or increasing pH compared to neutral Clay and iron mineral dissolution and precipitation of amorphous phases changes sorption sites	Changes U complexation and impacts solubility
Sulfur		
TDS		

Blank indicates "no major impact"

Key: Process is active Process is usually unimportant

4.3.7 Cadmium, Copper, Lead, Nickel, and Zinc

Under low ORP conditions, sulfide (from microbial sulfate reduction) may prompt formation of insoluble lead, cadmium, zinc, and copper compounds. Under high ORP conditions, each of the heavy metals can form low solubility (hydr)oxide or carbonate phases in soils. Under high ORP conditions, each of the metals sorbs to iron hydroxides, to clays, and to carbonates. Under high carbonate alkalinity conditions, solubility of these contaminants may decrease.

Mechanisms

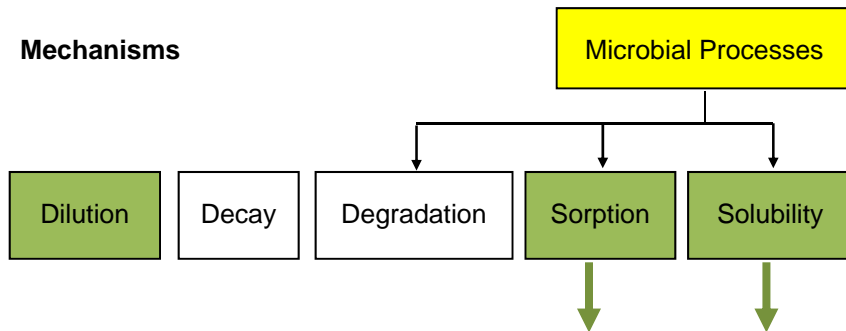

Groundwater Condition	Impact on Sorption	Impact on Solubility
ORP		Low: Potential for low solubility sulfide compounds High: No significant impact unless transitioning from low ORP and sulfides dissolve
CEC	High CEC may increase metal sorption	
Sediment iron oxide	Iron oxides are major sorption sites	
pH	Sorption may decrease with decreasing pH Clay and iron mineral dissolution and precipitation of amorphous phases changes sorption sites	Possible increases in solubility with decreasing pH
Sulfur		Under low ORP conditions sulfide compounds result in low solubility
TDS	Sorption may decrease with increasing TDS	

Blank indicates "no major impact"

Key:

Process is <u>active</u>	Process is <u>usually unimportant</u>
<u>Indirect</u> impact on contaminant	

4.3.8 Arsenic

Under low ORP conditions, arsenic will be present as arsenite As(III); under high ORP conditions, as As(V). As(III) can form low solubility arsenic sulfide minerals, or arsenic sulfide inclusions in pyrite, under low ORP conditions. Under high ORP conditions, As(V) sorbs to iron hydroxides from roughly pH 5 to 7, but is unlikely to form insoluble solids. Phosphate can inhibit As(V) adsorption. As(III) sorbs less strongly to iron hydroxides but can coordinate to clay edges. In between low and high ORP conditions, the attenuation of arsenic is complicated by the ORP-sensitive presence of iron hydroxides; transformations between As(III) and As(V); and the ORP-sensitive presence of sulfide.

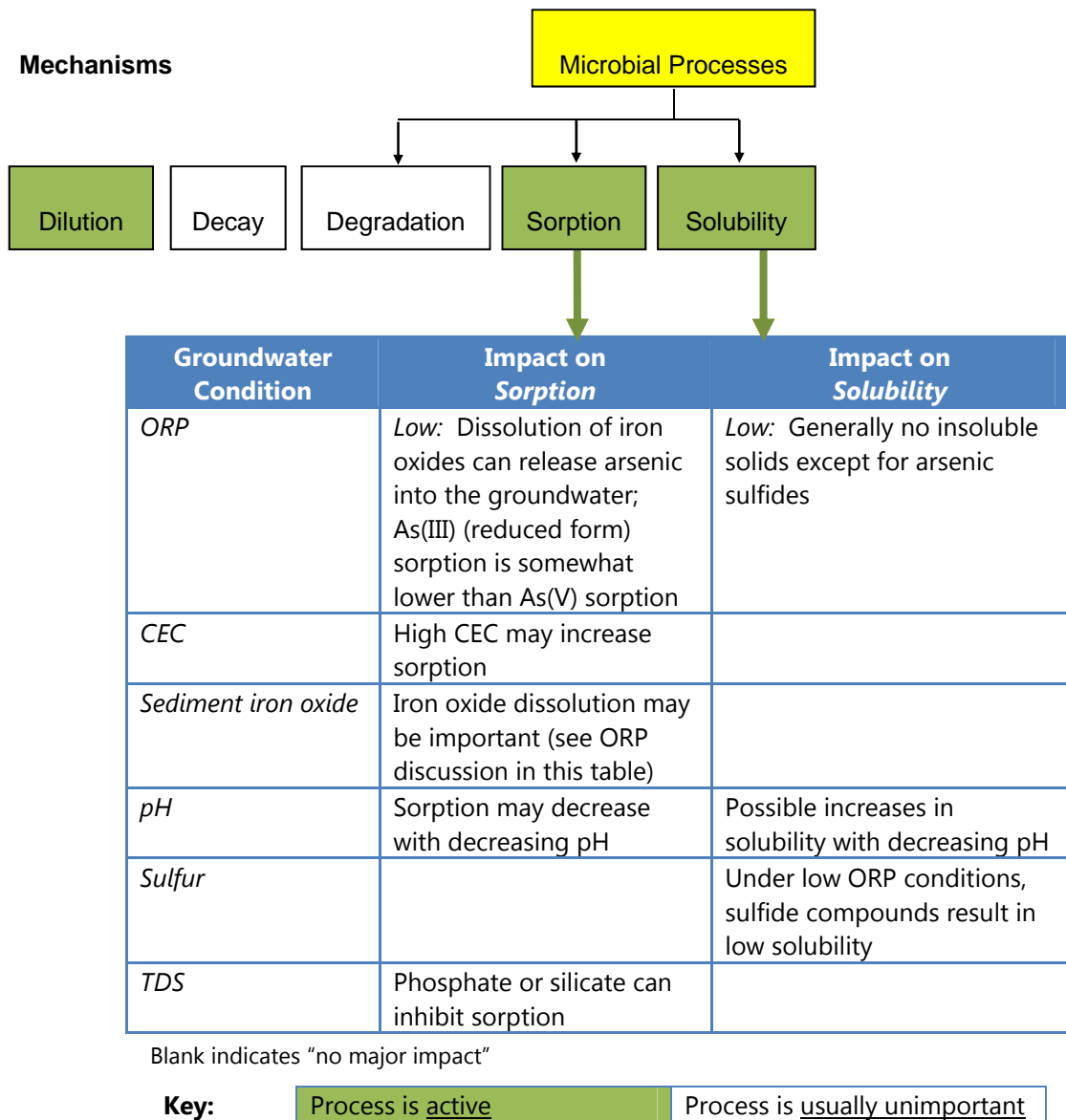

Indirect impact on contaminant

4.3.9 Selenium

Selenium can be present in a number of valence states. Selenate - Se(VI), present under high ORP conditions, behaves chemically analogous to sulfate and is unlikely to sorb strongly or form insoluble solids. Selenite – Se(IV), present under lower ORP conditions, behaves analogous to phosphate and is more likely to sorb to soil oxides, particularly at near neutral pH. Under low ORP conditions, selenium may be present as relatively insoluble Se(0) or other reduced forms. However, if conditions become more oxidizing, reduced selenium forms can be oxidized to more mobile selenate.

Mechanisms

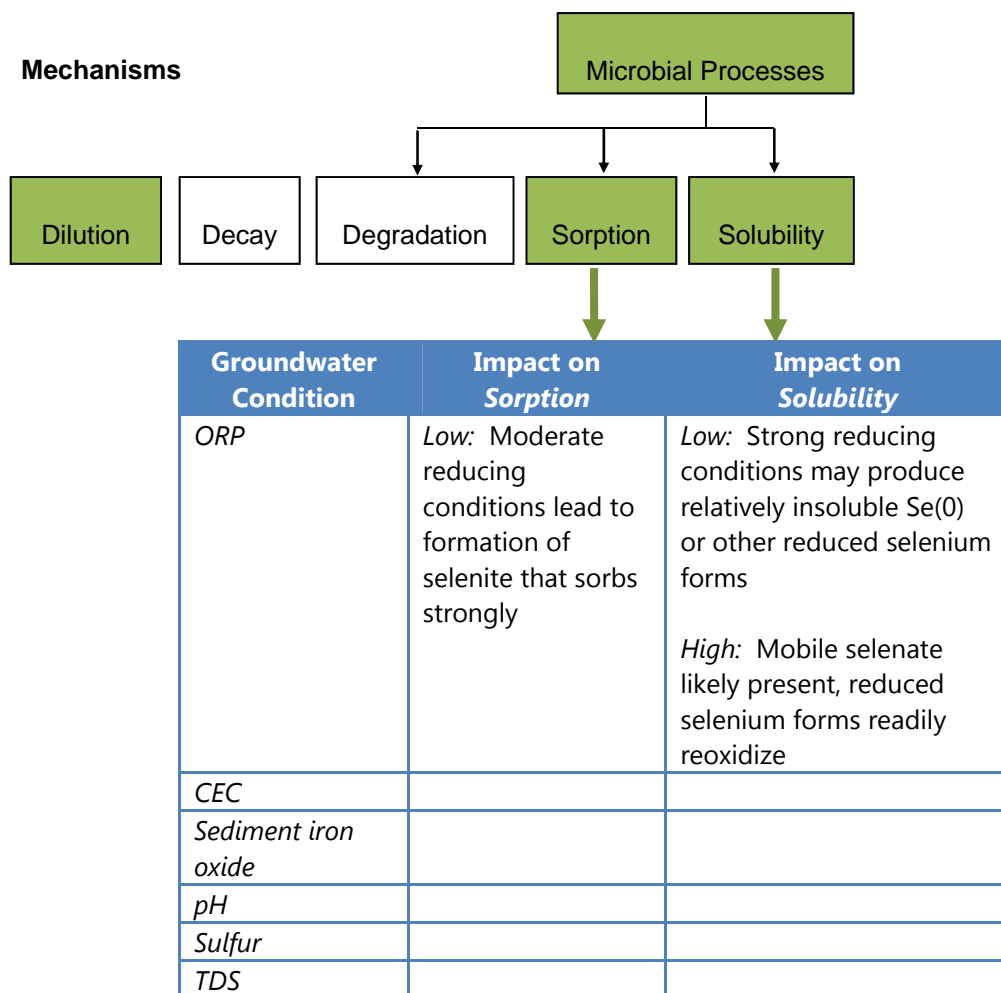

Blank indicates "no major impact"

Key: Process is active Process is usually unimportant

4.3.10 Strontium-90, Cesium, and Radium

Strontium attenuation is largely independent of ORP conditions. Strontium attenuation by exchange onto the basal planes of clays will be sensitive to soil CEC and TDS. Strontium incorporation into/onto calcium carbonate solids will be sensitive to changes in carbonate alkalinity and Ca²⁺ levels.

Cesium forms no insoluble solids or strong aqueous complexes. Cesium exchanges onto the basal planes of clays and at alkaline pHs sorbs to clay edges. Micaceous clay lattices collapse around exchanged cesium making its subsequent desorption (and engineered removal) difficult. A high fraction of micaceous clays will greatly enhance attenuation. ¹³⁷Cs, the most common form of cesium, has a half-life of 30 years.

Radium is an alkaline earth element and therefore behaves similarly to Strontium. It exists as Ra²⁺, reversibly exchanges onto the basal planes of clays and at alkaline pH sorbs to clay edges. Radium also forms RaSO₄ solids, often in solid solution with BaSO₄. Similarly RaCO₃ can form solids or solid solutions, though high solution alkalinities are required.

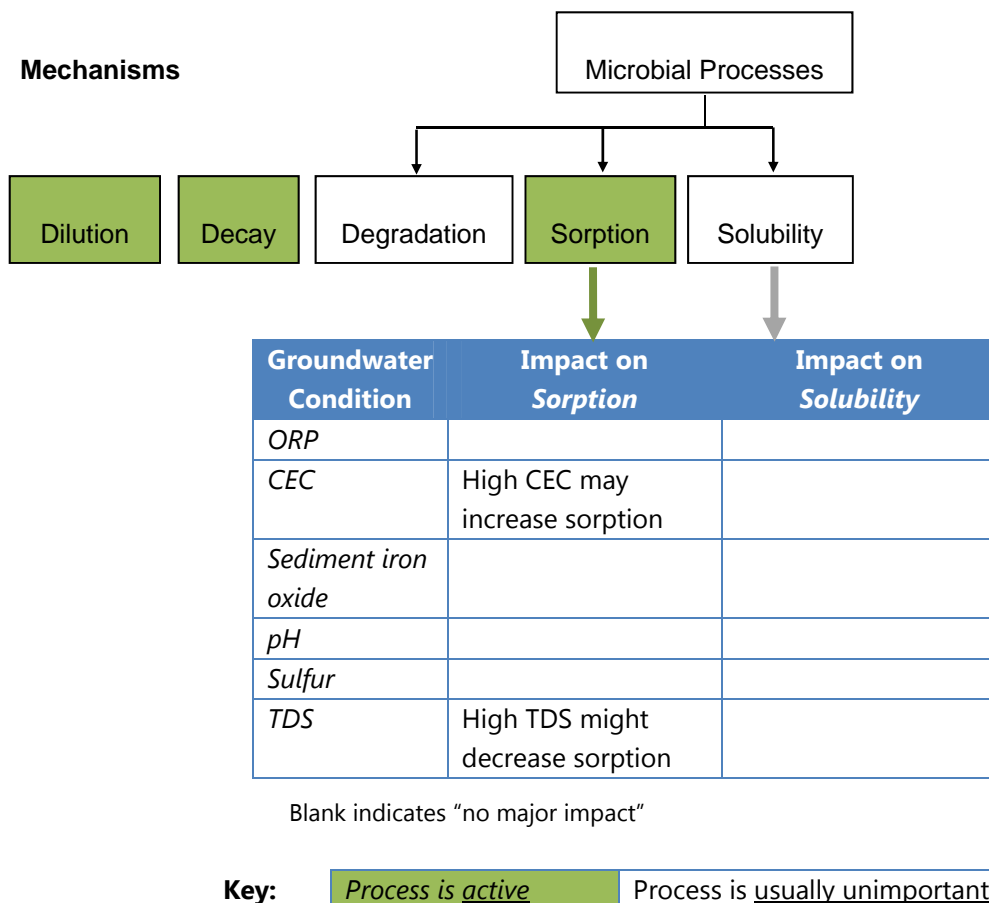

4.3.11 Nitrate and Perchlorate

Under oxidizing conditions, nitrate and perchlorate are not strongly attenuated. Under low ORP conditions when organic compounds are present, nitrate and perchlorate can be degraded to less harmful forms.

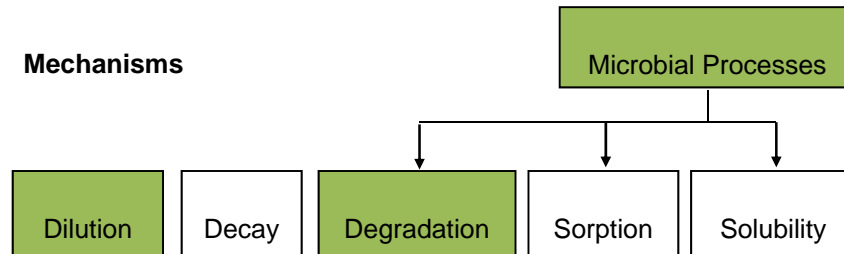

4.3.12 Iodine-129

There are no strong chemical attenuation mechanisms for iodine in soils.

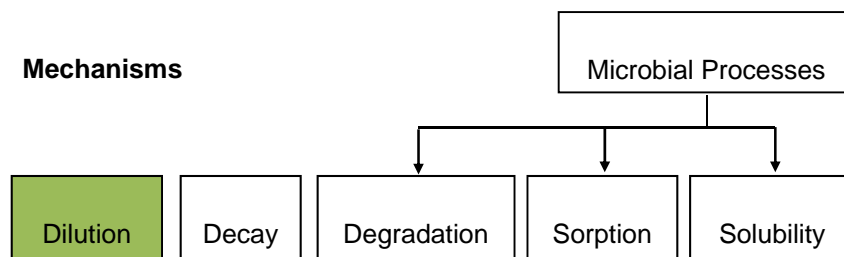

4.3.13 Other Potentially Important Factors

Secondary Modifying Factors

The secondary modifying factors to be identified for the scenario have the following overall impact on the evaluation of attenuation-based remedies.

Facilitated Transport: If aquifer geochemical conditions favor the existence of colloids or complexants, these entities may be involved in facilitating (or attenuating) the transport of contaminants. For example, at some sites there may be significant movement of clay particles and other colloids with the groundwater. Thus, these particles can transport contaminants more quickly than would be predicted based on the primary factors.

- Increases transport and may limit or minimize the impact of sorption, a primary attenuation factor in this scenario. Facilitated transport may radically change the transport and flux of contaminants. Thus, if these mechanisms are suspected, they should be investigated in detail as part of assessing the plume behavior.

Source Configuration: See Table 3.4, Section 4.3.1.

- Affects the flux of contaminants into the aquifer and thereby the attenuation capacity needed and the longevity of the source.

Hydrology/Time to Receptors: See Table 3.5, Section 4.3.1.

- Affects the distribution of attenuation processes, flux of contaminants, and the urgency of decisions.

Additional Factors

In some cases, the following additional factors may be considered as attenuation mechanisms and will generally require input from a geochemist to quantify the impact.

Precipitation Agents (Phosphate, Hydroxide, Other)

- Precipitation agents may be added as an enhancement and will significantly change the geochemical setting within the targeted zone. Thus, a conceptual model specific to this type of enhancement chemistry will need to be developed.

Co-precipitation

- Co-precipitation of contaminants may occur and will depend on the availability of co-precipitating ligands and the ratio of contaminant to other ions in solution. Under reducing conditions, co-precipitation of contaminants as metal sulfides (e.g., arsenic sulfide or lead sulfide as a trace component of an iron sulfide phase) should be considered. Contaminant incorporation into carbonate and phosphate minerals might also occur.

4.4 Data and Plume Analysis Tools

Comparing the *concentrations* of contaminants in groundwater against the concentrations on soil shows to what degree the aquifer matrix can remove aqueous contaminants from groundwater. *Geochemical data* can be used to determine which removal mechanisms are likely to be active. *Spatial and temporal trends* in groundwater data can be analyzed to estimate the rates of reactions. Finally, more detailed *scoping calculations* can provide more information on the capacity of the subsurface to capture and hold inorganic contaminants.

These scoping calculations are imbedded in EPA's technical basis for assessment (EPA 2007a) for inorganic MNA within four tiers.

- Demonstrate active contaminant removal from groundwater (Tier I)
- Determine the mechanism and rates of reaction (Tier II)
- Determine the system capacity and stability of attenuation (Tier III)
- Design a performance monitoring program and identify alternative remedies (Tier IV).

Section 3: Scenarios Evaluation Guide

Tier I: Demonstrate Active Contaminant Removal from Groundwater

Tier	Objective	Potential Data Types and Analysis
I	Demonstrate active contaminant removal groundwater	<ul style="list-style-type: none"> • Groundwater flow direction (calculation of hydraulic gradients); aquifer hydrostratigraphy • Contaminant concentrations in groundwater and aquifer solids • General groundwater chemistry data for preliminary evaluation of contaminant degradation

For Tier I co-located aqueous (groundwater) and solid-phase (soil cores) samples, data to establish plume extent and stability, and information about the presence of potentially important gradients are needed. This information can be used with the Scenarios Approach document and the Tier I approach described in the EPA Protocol.

- Co-located aqueous and solid-phase samples are used to compare the aqueous concentration to the solid concentration at locations along the axis of plume movement. This comparison provides evidence of attenuation if sediment concentrations increase with increasing aqueous (plume) concentrations (Figure 3.12).
- Concentration versus time plots at individual wells, concentration versus distance plots as a function of time, and plume maps over time can be prepared to evaluate plume extent and stability.
- Information from Table 3.3 of this Scenarios Evaluation Guide provides information on gradients that may impact the mobility of each contaminant. For each potentially important gradient, groundwater chemistry information at multiple locations can be used to map the gradient with respect to the plume.

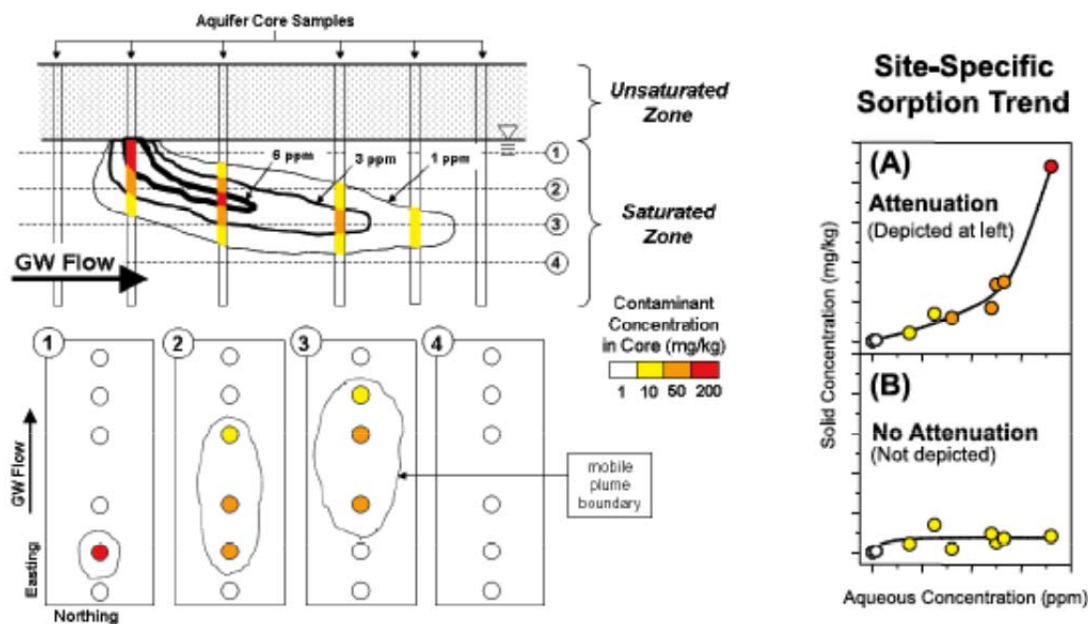

Figure 3.12. Conceptual depiction of the data collection effort to demonstrate whether sorption to aquifer solids attenuates contaminant transport in groundwater. The left side of the diagram provides a cross-sectional view of the spatial distribution of the contaminant concentration in groundwater and co-located aquifer solids for a site where sorption attenuates contaminant transport. The trend in aqueous and solid contaminant concentrations for this scenario is depicted in Panel (A) (right side). Panel (B) depicts the relationship between aqueous and solid contaminant concentrations for a site where sorption does not attenuate contaminant transport. (Source: EPA 2007a).

Tier II: Determine the Mechanism and Rates of Reaction

Tier	Objective	Potential Data Types and Analysis
II	Determine mechanism and rate of attenuation	<ul style="list-style-type: none"> Detailed characterization of system hydrology (spatial and temporal heterogeneity; flow model development) Detailed characterization of groundwater chemistry Subsurface mineralogy and/or microbiology Contaminant speciation (ground water and aquifer solids) Evaluate reaction mechanism (site data, laboratory testing, develop chemical reaction model)

Investigation of mechanisms can include 1) measurements of field water quality; 2) laboratory measurements of aquifer solids; 3) mineralogy of aquifer solids; and 4) chemical speciation of the contaminants. The EPA Protocol includes procedures for these investigations. A key consideration is to conduct these investigations on samples representative of the reactive facies and gradient conditions determined as important in the conceptual model.

Section 3: Scenarios Evaluation Guide

Rate calculations can be performed using two types of scoping calculations: concentration versus distance measurements, and concentration versus time measurements (Figure 3.13).

- Concentrations versus distance rates indicate the attenuation of the aqueous constituents after they migrate away from the original source zone.
- Concentration versus time rates from wells close to the source zone show how quickly the source term itself is attenuating, such as by long-term leaching of inorganic compounds from source materials. Concentration versus time rates calculated from downgradient wells in the plume (if concentrations are diminishing) show how quickly the aqueous plume is being depleted at the well of interest.

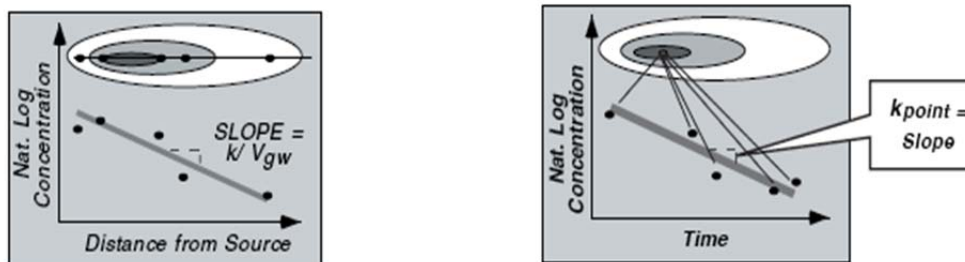

Concentration vs. Distance Rate: This calculation reflects attenuation processes in the plume as the contaminants migrate away from the source zone.

Concentration vs. Time Rate: This calculation indicates how attenuation processes are affecting the source term, and can provide information about the plume duration.

Figure 3.13. Types of analyses for rate estimation

Tier III: Determine System Capacity and Attenuation Stability

Tier	Objective	Potential Data Types and Analysis
III	Determine system capacity and stability of attenuation	<ul style="list-style-type: none"> Determine contaminant and dissolved reactant fluxes (concentration data and water flux determinations) Determine mass of available solid phase reactant(s) Laboratory testing of immobilized contaminant stability (ambient groundwater; synthetic solutions) Perform model analyses to characterize aquifer capacity and to test immobilized contaminant stability (hand-calculations, chemical reaction models, reaction-transport models)

System capacity and attenuation stability can be evaluated on several levels. A key component related to capacity and stability is the presence of biogeochemical gradients. Thus, plotting key geochemical data for the identified gradients over time to quantify gradients is an important tool for Tier III evaluations.

Mass flux calculations can also be used to estimate the attenuation rate (see Appendix A for more information about mass flux). Mass flux estimates are derived by combining groundwater velocity data, the cross-sectional area of the plume, and concentration data to determine the mass per time across a cross-section transect. The attenuation rate can be estimated using transects within the stable portion of the plume by comparing the mass flux of an upgradient transect to a downgradient transect. For instance, if there is no change in the two mass flux estimates, the aqueous constituent is conservative and no attenuation is occurring. If the mass flux gets smaller moving downgradient, attenuation is occurring.

Note of Caution: Transect comparison is not appropriate if the plume is not stable.

A mass balance based on mass flux and quantifying the attenuation capacity is another suitable tool for Tier III analysis. Low contaminant mass flux and large attenuation capacity is favorable for plume stabilization, while high flux with low reactant mass may indicate natural attenuation alone may be insufficient to stabilize the plume. Attenuation capacity can be estimated from the Tier II mechanism information with knowledge of the reactive facies distribution to estimate the quantity of a given mechanism available at a site (i.e., the capacity in moles or reaction per volume of aquifer).

Detailed laboratory experiments and numerical modeling are also tools that can be applied to Tier III evaluations if necessary. For complex sites and associated complex conceptual models, simple calculations may not be appropriate to describe the flow field, reaction processes, or transport processes. The need for these more significant efforts can be determined by first conducting the approaches described above and then evaluating the level of uncertainty associated with the results.

Section 3: Scenarios Evaluation Guide

ORP processes are of particular importance for this scenario with many of the potential contaminants. Table 3.6 provides a general overview of the effect of ORP on the contaminant mobility and the type of contaminant compounds that will prevail. The ORP reactions controlling contaminant mobility are complex and are treated in greater detail in the contaminant-specific chapters of the EPA Protocol. A brief overview is provided in Table 3.6 and in the following paragraphs. Figure 3.14 illustrates the general effect of ORP on iron mineral stability, and contaminant fate.

Under oxidizing conditions, many of the metals and radionuclides—Pb, Cu, Ni, Cd, Se, U, Tc, As, and Cr—sorb to iron hydroxides, or form metal-ferric surface precipitates. Under more reducing conditions, ferric hydroxides dissolve, decreasing the sorptive effect and releasing any previously sorbed contaminants. Under the same conditions, low-solubility U, Cr, and Tc solids form that limit the levels of U, Cr, and Tc in solution.

Table 3.6. General Impact of Low ORP on Contaminant Geochemistry

Contaminant	Impact of Low ORP
Cd/Cu/Pb/Ni	Formation of sulfide minerals, dissolution of ferric hydroxide hosts
Cr	Reduction to less soluble Cr(III), possible incorporation into ferric hydroxide hosts (if the latter are stable)
As	Formation of sulfides, dissolution of ferric hydroxide hosts, reduction of arsenate to less sorptive arsenite
NO ₃ ⁻	Possible reduction to nitrogen gas
ClO ₄ ⁻	Possible reduction to chloride
Se	Reduction of selenate to selenite
U	Reduction of U(VI) to U(IV) and formation of low solubility phases, dissolution of ferric hydroxide hosts
Pu	Possible reduction in solubility due to formation of more reduced Pu valence states, dissolution of ferric hydroxide hosts
Cs	None
Ra	None
¹²⁹ I	None
⁹⁹ Tc	Reduction to less soluble Tc(IV)
⁹⁰ Sr	None

Under particularly reducing conditions, elements Pb, Cu, Ni, Cd, Se, and Tc form low solubility metal sulfides, or form as inclusions in iron sulfides. Reducing conditions favor the conversion of nitrate to nitrogen gas and perchlorate to chloride. Reducing conditions have little effect on the mobility of Ra, Sr, and Cs because these contaminants neither sorb strongly to ferric hydroxides or sulfides, nor do they change valence state to less or more soluble forms. The

effect of ORP on arsenic mobility is particularly complex. Under high ORP conditions, arsenic (as arsenate) sorbs strongly to ferric hydroxides. Reducing conditions convert strongly sorbing arsenate to less strongly sorbed arsenite, while destabilizing the ferric hydroxide sorptive host. Under very reducing conditions, arsenic combines with sulfide to form insoluble arsenic sulfides.

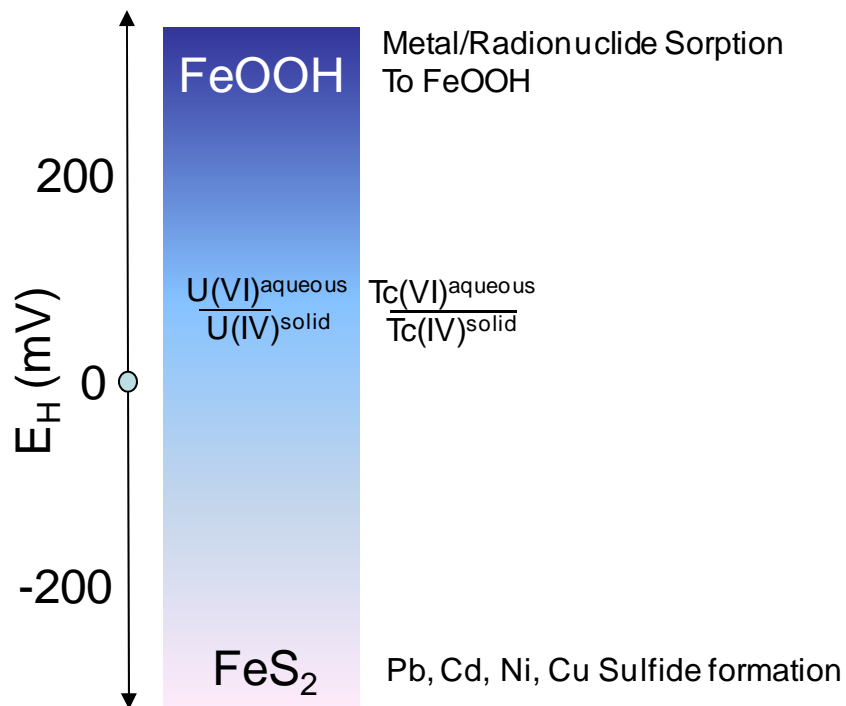

Figure 3.14. General effects of ORP on metal and radionuclide fate in soils

Tier IV: Design Performance Monitoring Program and Identify Alternative Remedies

Tier	Objective	Potential Data Types and Analysis
IV	Design performance monitoring program and identify alternative remedy	<ul style="list-style-type: none"> • Select monitoring locations and frequency consistent with site heterogeneity • Select monitoring parameters to assess consistency in hydrology, attenuation efficiency, and attenuation mechanism • Select monitored conditions that “trigger” re-evaluation of adequacy of monitoring program (frequency, locations, data types) • Select alternative remedy best suited for site-specific conditions

The objective for Tier IV is to develop a monitoring program to track the performance of an MNA remedy, and identify contingency measures that could be implemented if site conditions change and MNA processes become less effective. The monitoring program should be designed to track the plume status (expanding, stable, or shrinking) and the basic reactive facies and biogeochemical factors that drive MNA processes. The program identifies a few key hydrologic, contaminant, and geochemical indicators that can be used to track the overall performance of an MNA remedy for metals and radionuclides.

Statistical tools can be used to evaluate trends, and to determine if changes in key monitoring variables are statistically significant or represent background noise. For example, the MAROS program (Aziz et al. 2000; Aziz et al. 2003) is a public-domain freeware developed by the U.S. Air Force that can help identify trends in temporal groundwater datasets.

The concept of trigger values is important. In this case, a trigger value is a key groundwater measurements that, if exceeded, indicates performance loss, change of conditions, and possible failure of an MNA remedy. The trigger would lead to some type of change in the monitoring program to determine if site conditions are changing significantly and permanently, or if verified, could lead to the implementation of an alternative remedy.

Alternative technologies should be identified that tie into a potential spatial or temporal gradient. For example, if a Scenario 1 plume segment (low ORP, high CEC) is trending towards a Scenario 3 plume segment (high ORP, high CEC), then an alternative remedy for selenium would be required because selenium is more mobile under Scenario 3 compared to Scenario 1 (if selenium is a key constituent at the site).

4.5 Cost Considerations

Costs for evaluating MNA for metals and radionuclide is very site specific, but some generalizations are possible. The following cost considerations are compiled from various sources, including costing software, the authors' experience, laboratory rate sheets, and other sources. One key point is that the costs generally increase as more tiers are added to the MNA analysis.

4.5.1 Costs for Tier I Analysis

A groundwater sample for inorganic compounds from an existing well may have costs associated with sampling labor, waste disposal, equipment rental, field crew time, shipping, analytical, and data reduction. Obviously, actual costs can vary significantly. Relative analytical costs for Tier I sampling are provided in Table 3.7.

Table 3.7. Relative Analytical Costs for Metals and Radionuclides

Analyte or Analyte Group	Method	Cost to Analyze Groundwater Sample
Cation-exchange capacity of soils (sodium acetate)	SW846 9081	\$\$
Anion scan	Ion chromatography	\$\$
Anions (1 anion)	Ion chromatography	\$
Nitrate	EPA 353.2 (EPA 1993)	\$
TDS	EPA 160.1 (EPA 1971)	\$
Ferrous iron	SM 3500-FE D	\$
Arsenic speciation	SW846 7063 Mod	\$\$\$
Chromium (VI)	EPA 218.4	\$\$
Chromium (III)	Ion chromatography	\$\$
Perchlorate	LC/ESI/MS	\$\$\$
Lead, cadmium, zinc, nickel, copper, selenium	ICP	\$
Plutonium-241	Liquid scintillation counting	\$\$\$
Technetium-99 (VII)	Liquid scintillation counting	\$\$
Strontium-90	Gas proportional counting	\$\$\$
Iodine-129	Gamma spectroscopy	\$\$
Uranium	Alpha spectroscopy	\$\$

4.5.2 Costs for Tier II Analysis

Tier II analysis include a wider range of activities, such as hydrogeologic data, mineralogical analysis, speciation tests, and geochemical modeling. Relative costs for these activities are summarized below:

- Slug tests for determining hydraulic conductivity: \$\$\$\$
- Pump tests for determining hydraulic conductivity: \$\$\$\$\$
- Mineralogical analysis (spectroscopy): \$\$ per sample
- Laboratory tests for speciation: \$\$\$\$
- Geochemical modeling studies: \$\$\$\$\$.

4.5.3 Costs for Tier III Analysis

The cost of a mass flux (also called mass discharge) estimate varies significantly based on the type of mass flux calculation being performed and the amount of data already available. The *ITRC Use and Measurement of Mass Flux and Mass Discharge* document (ITRC 2010) provides detailed information on the different methods to determine mass flux/mass discharge at a site (see Appendix A). One method, using isocontours to develop transects for mass discharge calculations, is a very inexpensive way to obtain lower-accuracy, planning-level data if isocontour maps are already available. On the other end of the expense spectrum is to perform dedicated high-resolution transect sampling, where dozens of closely spaced groundwater samples are collected and analyzed to develop more refined mass flux/mass discharge estimates.

4.5.4 General Cost Drivers

While site-specific factors will determine the actual cost of MNA implementation at a site, there are some very general cost drivers. MNA costs generally *increase* with the following:

- Higher seepage velocities (typical seepage velocity for waste sites is about 90 ft per year)
- High mobility conditions (based on mobility charts in this scenarios document)
- Geochemical conditions that will likely change in the future (i.e., biogeochemical gradients that may change ORP, pH, or other factors important to contaminant attenuation)
- Close receptors
- Large plumes
- Deep plumes
- More complex hydrogeology
- Extended long-term monitoring period (tens of years)
- Sampling regimes with frequent sampling (quarterly).

MNA costs generally decrease with the following:

- Lower seepage velocities (typical seepage velocity for waste sites is about 90 ft per year)
- Low mobility conditions (based on mobility charts in this scenarios document)
- Distant receptors
- More simple hydrogeology
- Small plumes
- Shallow plumes
- Limited long-term monitoring period (a few years)
- Sampling regimes with less frequent sampling (annual or every few years).

4.6 Enhanced Attenuation

4.6.1 Definition

EA is a remediation strategy aimed at reducing plume loading from the source and increasing the natural attenuation capacity of a source-plume system, which depends “on the action of passive sustainable, attenuation mechanisms to reduce the mass flux of contaminants” (Looney et al. 2006). A sustainable enhancement has previously been defined as “an intervention that continues until such time that the enhancement is no longer required to reduce contaminant concentrations or fluxes” (Early et al. 2006). EA may be considered a bridge between source treatment and MNA, and applies to the entire system (source and plume), with potential enhancers implemented within the whole span of contamination with the goal of reducing the contaminant mass flux (Figure 3.15).

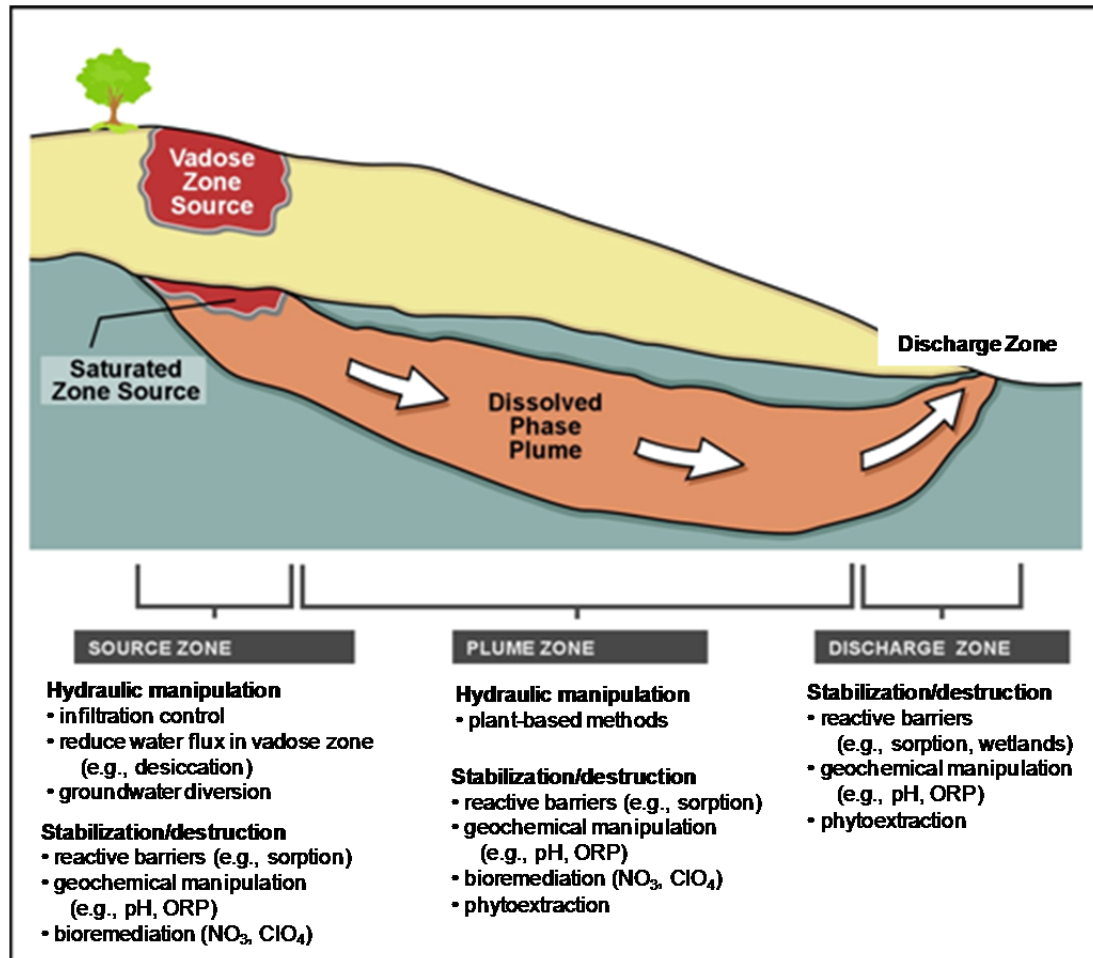

Figure 3.15. Source and plume system and type of EA for inorganic compounds (adapted from Looney et al. 2006)

4.6.2 Enhanced Attenuation Categories

EA may be grouped in two basic categories as described below: 1) source loading reduction, and 2) increased attenuation capacity.

1. **Source Loading Reduction** – EA may be implemented as an action to reduce the mass flux from the source zone such that the existing natural attenuation mechanisms will be able to reduce contaminant concentrations to below regulatory levels at a specified down gradient control plane (receptor). Examples of EA processes include hydraulic manipulation (such as caps), reactive barriers, geochemical manipulation, and bioremediation (Figure 3.15). At many sites, EA is most effective in the source zone due to the zone's relatively small size compared to the plume, often a manageable source depth (i.e., not very deep), and the availability of multiple enhancement options (Early et al. 2006). However, as with any generalization, there are exceptions to the above points and each system must be evaluated on an individual basis.

2. **Increased Attenuation Capacity** – Implementation of EA for the plume portion of the system is targeted at changing hydraulic or geochemical conditions to enable attenuation processes to reduce contaminant concentrations and meet remedial objectives. Examples include hydraulic manipulation using plants; reactive barriers in the plume; bioremediation of the plume, and phytoextraction (Figure 3.15). The natural attenuation mechanisms within the plume zone include physical (dispersion, diffusion, advection), geochemical (sorption, precipitation), and biological (transformation, ORP changes) mechanisms, and EA implementation should target the mechanism that can be most effectively enhanced to improve the attenuation capacity within the plume zone. Table 3.8 summarizes some of the natural attenuation mechanisms available for inorganic contaminants. However, due to the depth and extent of the plume zone, this segment of the system is often the most challenging when EA implementation is considered.

In addition to the source zone and the plume zone, EA may also be implemented in the discharge zone of the system (Figure 3.15). However, due to its proximity to potential receptors, and to prevent exceedance of regulatory thresholds at the control plane and/or receptor, EA must be carefully designed and implemented. In addition, the effect of EA on the reduction of mass flux and attenuation capacity must be well characterized, monitored, and documented. Nevertheless, enhancements in this zone may be cost effective because the release of contamination may occur within a small region, and the contaminants may be closer to the surface (Early et al. 2006).

Costs associated with remediation technologies applicable to EA are presented in Table 3.9. A remediation technologies matrix summarizing the applicability, effectiveness, and treatment capabilities of the remedial technologies is presented in Table 3.10.

4.7 Source Control Versus Enhanced Attenuation

As a guideline in the MNA directive (OSWER Directive 92000.4-17P [EPA 1999]), the EPA's expectation is that "source control measures will be evaluated for all contaminated sites and that source control measures will be taken at most sites where practicable," and that "source control measures should use treatment to address "principle threat" wastes wherever practicable. In this context, source control (source treatment) is an *aggressive* remedial approach aimed at reducing the mass flux out of the source zone. It is typically a one-time action for reducing the strength, size, and/or mass of the source zone. Examples include large

Source Control versus Enhanced Attenuation

Source control is defined here as a "one-time action for reducing the strength, size, and/or mass of the source zone."

Enhanced Attenuation (EA) is defined as "an action aimed at achieving long term sustainability of MNA."

excavation projects, in-situ soil flushing, immobilization projects, and construction of extensive containment systems using vertical barrier walls.

EA for the source zone, however, is as an action aimed at achieving long-term sustainability of MNA. Therefore, an EA source zone project would be less aggressive, but would be active longer than a conventional source zone remediation project (Truex et al. 2006).

The decision to use conventional source control measures versus EA techniques will depend on site conditions. Large source zones with high mass flux to groundwater may overtax attenuation processes in the plume by a large margin, and therefore some type of aggressive source control may be necessary. At other sites, the source mass flux and attenuation processes are more closely balanced, and therefore EA methods in the source or plume may be sufficient to apply an attenuation-based remedy.

4.7.1 Traditional Remediation Technologies for Metals/Radionuclides

In general, the remediation approaches for metal-contaminated media include isolation, immobilization, toxicity reduction, physical separation and extraction (Evanko and Dzombak 1997). Detailed information and discussion of the remediation technologies and pathways are presented in *Monitored Natural Attenuation of Inorganic Contaminants in Ground Water - Volume 2* (EPA 2007b; see also Table 3.8). A detailed discussion of these technologies and their applicability is also included in Evanko and Dzombak (1997). A comprehensive list of field-demonstrated technologies (including metal-remediation approaches) is contained in EPA (1996). Costs associated with remediation technologies are presented in Table 3.9.

Classes of remedial technologies that can be implemented as source control measures include the following:

- **Isolation:** Capping and subsurface barriers may be used to minimize water infiltration into the source to prevent further movement of contaminants out of the contaminated area. Synthetic membranes (e.g., high-density polyethylene) may be used for capping. Vertical steel, cement, or bentonite and grout slurry walls may be installed as barriers to natural groundwater flow.
- **Immobilization:** Includes solidification, stabilization, and vitrification technologies. Solidification involves the binding of the contaminant in a solid matrix. Stabilization (also known as fixation) relies on chemical reactions to reduce contaminant mobility. Vitrification involves high temperature treatment of the contaminated matrix, which results in a decrease in the mobility of the contaminant.
- **Toxicity and/or Mobility Reduction:** Chemical reactions involving oxidation, reduction, or neutralization can be used to detoxify, precipitate or solubilize metals, adjust the pH of soils, and precipitate insoluble metal salts from groundwater. Permeable reactive barriers may be used as remedial technologies involving physical, chemical, or biological processes, which reduce metal mobility and toxicity.

- **Mechanical Separation:** Ex-situ processes that rely on the physical characteristics of the metals. These processes separate the contaminants from the matrix based on particle size, density, or magnetic properties of the metals, and include screening, gravity concentration, and magnetic separation.
- **Extraction:** These processes include soil washing (chemical leaching) soil flushing, electrokinetic treatment, and pyrometallurgical separation. Soil washing (ex-situ) and soil flushing (in-situ) processes rely on the addition of extracting solutions that cause metal leaching from the soil matrix. During electrokinetic treatment, metals are mobilized by an applied electric current. Pyrometallurgical separation involves high temperature volatilization of metals from contaminated soil.

Most of the above-mentioned source control technologies are related to soils because most inorganic source zones are associated with surface disposal sites. As with any remediation technology, the processes and reactions responsible for inorganic contaminant removal are site specific and must be evaluated on an individual basis to ensure the selected treatment does not result in unanticipated mobilization of co-contaminants or causes additional contamination due to introduction of remedial chemical substances into the subsurface.

4.7.2 Crossover Remediation Technologies for Metals/Radionuclides

In addition to the commonly used remediation approaches for inorganic compounds, there are several technologies that have historically been employed for treatment of sites impacted by organic contaminants that are also applicable to treatment of certain metals/radionuclide problems.

The injection or emplacement of an electron donor (such as lactate or molasses) may be one approach that could facilitate the remediation of inorganic contaminants. One example of such a process is the sequence in which sulfate is reduced to sulfide by sulfate-reducing bacteria in the presence of an electron donor (biotic process), with the resulting sulfide subsequently precipitating the metals (abiotic process). Other sources of electron donors for this process may include vegetable oil, zero-valent iron (ZVI), and mulch/compost.

ZVI and mulch reactive barriers may serve as zones where the presence of electron donors enhances the natural biochemical conditions such that metal precipitation and reduction processes satisfactorily reduce the metal concentrations below regulatory levels. A mulch reactive barrier may act as a source of soluble carbon electron donors, and ZVI may serve a dual role in the potential treatment of metals by 1) acting as an electron donor for sulfate reduction, and 2) directly reducing heavy metals to metallic forms.

Another potential remediation approach for inorganic compounds would be the addition of an electron acceptor through the injection of air or oxygen into the subsurface to promote the formation of iron oxides, that in turn, would serve as adsorption sites for precipitation of dissolved metal species. Similarly, chemical oxidation with substances such as ozone, peroxide, and permanganate could potentially be implemented at sites contaminated with some inorganic

Section 3: Scenarios Evaluation Guide

species for the purpose of immobilization of these contaminants. However, detailed geochemical site characterization would need to be conducted before the implementation of these potential remedial technologies to determine contaminant composition and minimize the possibility of inadvertent co-contaminant mobilization. Table 3.10 summarizes remedial technologies with potential applications to in-situ treatment of inorganic contaminants.

Section 3: Scenarios Evaluation Guide

Table 3.8. Remediation Technologies, Attenuation and Mobilization Pathways of Various Metals and Inorganic Compounds (from EPA 2007b). Green boxes represent EA technologies.

Contaminant	Applicable Remediation Technologies			Pathways
	Soils	Groundwater	Natural Attenuation	
Cadmium	<div style="border: 1px solid black; background-color: #d9ead3; padding: 5px; margin-bottom: 5px;">Containment – caps, vertical barriers</div> <div style="border: 1px solid black; background-color: #d9ead3; padding: 5px; margin-bottom: 5px;">Geochemical manipulation - Solidification /stabilization</div> <div style="border: 1px solid black; background-color: #d9ead3; padding: 5px; margin-bottom: 5px;">Separation/concentration</div>	<div style="border: 1px solid black; background-color: #d9ead3; padding: 5px; margin-bottom: 5px;">Reactive barriers</div>	<p>Precipitation (pH > 8; carbonates, sulfides, hydroxides)</p> <p>Reversible sorption (to iron hydroxides, OM, carbonates sulfides, pH >6 - 8)</p> <p>Substitution for Zn in minerals</p>	<p>Dissolution (carbonates, sulfides)</p> <p>Degradation of OM</p> <p>Complexation/stabilization (with DOC)</p> <p>Desorption (low pH)</p> <p>Oxidation of metal sulfides</p>
	Lead	<div style="border: 1px solid black; background-color: #d9ead3; padding: 5px; margin-bottom: 5px;">Containment – caps, vertical barriers</div> <div style="border: 1px solid black; background-color: #d9ead3; padding: 5px; margin-bottom: 5px;">Geochemical manipulation - Solidification/stabilization – reactive agents (Portland cement, phosphate based compounds)</div> <div style="border: 1px solid black; background-color: #d9ead3; padding: 5px; margin-bottom: 5px;">Separation/concentration – ex-situ soil washing, in-situ soil flushing</div>	<p>Permeable reactive barriers (bench-top studies)</p>	<p>Precipitation (pH > 8; carbonates, sulfides, sulfates, phosphates)</p> <p>Reversible sorption (to iron hydroxides, OM, carbonates, sulfides at pH>5)</p>
Nickel	<div style="border: 1px solid black; background-color: #d9ead3; padding: 5px; margin-bottom: 5px;">Containment</div> <div style="border: 1px solid black; background-color: #d9ead3; padding: 5px; margin-bottom: 5px;">Physical removal</div>	<div style="border: 1px solid black; background-color: #d9ead3; padding: 5px; margin-bottom: 5px;">Permeable reactive barriers</div> <div style="border: 1px solid black; background-color: #d9ead3; padding: 5px; margin-bottom: 5px;">Extraction with above ground treatment</div>	<p>Precipitation (carbonate, layered double hydroxide, phyllosilicate phase, sulfide)</p> <p>Co-precipitation</p> <p>Adsorption (to iron</p>	<p>Dissolution (decreased pH, shift from reducing to oxidizing conditions)</p> <p>Desorption (low pH, high competing cations concentration, high DOC)</p>

Section 3: Scenarios Evaluation Guide

Contaminant	Applicable Remediation Technologies			Pathways
	Soils	Groundwater	Natural Attenuation	Mobilization
			oxyhydroxides, iron sulfides)	
Copper	<p>Immobilization - Solidification/stabilization</p> <p>Extraction – soil washing</p>	<p>Permeable reactive barriers</p> <p>Proposed bioremediation</p>	<p>Precipitation (hydrocarbonates, carbonates, sulfides, phosphates, pH>6)</p> <p>Sorption (to iron hydroxides, OM, carbonates, sulfides)</p>	<p>Dissolution (low pH, oxidative/reductive)</p> <p>Complexation/stabilization in presence of DOC</p> <p>Desorption (low pH)</p>
Arsenic	<p>Containment</p> <p>Immobilization</p> <p>Separation/concentration (within solid matrix followed by secondary immobilization treatment)</p>	<p>Permeable reactive barriers</p> <p>Pump and treat</p>	<p>Precipitation (metal arsenates or arsenites, arsenic sulfides)</p> <p>Co-precipitation</p> <p>Adsorption (to iron oxyhydroxides, iron sulfides)</p>	<p>Dissolution (change in pH, shift from reducing to oxidizing conditions or vice versa)</p> <p>Desorption (high pH)</p> <p>Complexation/stabilization in presence of DOC</p>
Chromium	<p>Geochemical I manipulation- Solidification /stabilization</p> <p>Chemical treatment</p> <p>Physical separation</p>	<p>Reduction and fixation (Permeable reactive barriers, chemical injections to establish reactive zones)</p> <p>Pump and treat (with chemical reduction Cr(VI) → Cr(III) and precipitation</p>	<p>Precipitation (metal chromates, Cr(III) oxyhydroxide or sulfide)</p> <p>Co-precipitation</p> <p>Adsorption (chromate to iron oxyhydrides, iron sulfides)</p>	<p>Dissolution (change in pH, acidification, shift from reducing to oxidizing conditions or vice versa)</p> <p>Desorption (high pH)</p> <p>Complexation/stabilization in presence of DOC</p>

Section 3: Scenarios Evaluation Guide

Contaminant	Applicable Remediation Technologies			Pathways
	Soils	Groundwater	Natural Attenuation	Mobilization
Selenium	<p>Geochemical manipulation- Solidification /stabilization</p> <p>Bioremediation</p> <p>Containment</p>	<p>Permeable reactive barriers</p> <p>Phytoremediation (absorption into plant mass or volatilization following uptake and conversion to organic species)</p> <p>Adsorption, ion exchange, chemical reduction</p>	<p>Reduction (biotic or abiotic by reduced Fe-bearing minerals)</p> <p>Precipitation (metal selenates or selenites)</p> <p>Adsorption (to iron oxyhydroxides, iron sulfides)</p>	<p>Cessation of microbial processes</p> <p>Reduction in Fe-bearing mineral mass</p> <p>Oxidation upon exposure to oxygen</p> <p>Dissolution (increased pH)</p> <p>Desorption (at high pH)</p> <p>Adsorption inhibition in presence of DOC or competing anions</p>
Nitrate	<p>Bioremediation</p>	<p>Permeable reactive barriers</p> <p>Denitrification (stimulation of native microbial populations)</p> <p>Phytoremediation</p> <p>Pump and treat (nitrate extraction or degradation via biotic or abiotic chemical reduction)</p>	<p>Biotic and abiotic transformation to other nitrogen species</p>	<p>Cessation in microbial processes</p> <p>Reduction in Fe-bearing mineral mass</p>

Section 3: Scenarios Evaluation Guide

Contaminant	Applicable Remediation Technologies			Pathways
	Soils	Groundwater	Natural Attenuation	Mobilization
Perchlorate	<div style="border: 1px solid black; background-color: #d9ead3; padding: 5px; margin-bottom: 5px;"> Bioremediation Phytoremediation </div> <div style="border: 1px solid black; background-color: #f5f5dc; padding: 5px;"> Thermal processes </div>	<div style="border: 1px solid black; background-color: #d9ead3; padding: 5px; margin-bottom: 5px;"> In-situ transformations (microbial stimulation, emplacement of media to achieve chemical reduction) </div> <div style="border: 1px solid black; background-color: #f5f5dc; padding: 5px;"> Pump and treat (extraction from groundwater or degradation through biotic or abiotic chemical reduction) </div>	Biotic and abiotic transformation to other chlorine species	Cessation in microbial processes

Section 3: Scenarios Evaluation Guide**Table 3.9.** Cost Estimates and Applicability of Metals Remediation Technologies (EPA 1997; Mulligan et al. 2001; Sale et al. 2008)

Remedial Technology	Applicability		Cost Range	
	EA	Source Control	\$/ton ⁽¹⁾	\$/cu yd ⁽²⁾
Physical Treatment				
Containment	●		10-90	14-122
Encapsulation		●	60-290	81-392
Vitrification		●	400-870	540-1175
Subsurface Barriers	●	●	3-10	-
Ex-situ Treatment				
Soil Washing		●	25-300	34-405
Physical Separation		●	60-245	81-331
Pyrometallurgical		●	200-1000	270-1350
In-situ Treatment				
Reactive barriers	●		60-245	81-331
Soil Flushing		●	60-200	81-270
Phytoremediation	●		25-100	34-135
Potential Technologies				
Enhanced Bioremediation (Electron Donor Delivery)	●	●	27-152	37-206
Reactive barriers (ZVI)	●		4500	-
Reactive barriers (mulch)	●		400	-

(●) Symbol indicates the treatment technology is applicable to the strategy.

(1) Costs do not include pretreatment, site preparation, regulatory compliance costs, costs for additional treatment of process residuals, or profit.

(2) Density of soil assumed: 100 lb/ft³.

Section 3: Scenarios Evaluation Guide

Table 3.10. Organic Compound In-situ Remediation Technologies with Potential to Treat Selected Metals and Inorganic Compounds

Remedial Approach	Organic Compounds		Inorganic Compounds and Metals	
	Goal (Mechanism)	Treats These Contaminants	Goal (Mechanism)	Treats These Contaminants
Electron donor addition (compounds to promote biotic contaminant transformations)	Generate H ₂ and acetate to promote biological reductive dechlorination	PCE TCE	Provide electron donor for sulfate reduction, leading to precipitation of metal sulfides that react with some metals/rads	U, Se, Tc, NO ₃ , Perchlorate, I
Zero valent iron to promote abiotic transformation	Abiotic contaminant reduction	PCE TCE	Provide electron donor for reduction and subsequent precipitation of metals Provide mineral surfaces for metal co-precipitation	U, Se, Tc, NO ₃ , Perchlorate, I
Electron acceptor addition (injection of air or pure oxygen gas)	Stimulate aerobic biodegradation of contaminants	BTEX Phenol Chlorobenzene Dichlorobenzene	Decrease solubility and stimulate immobilization of metals on precipitated iron species	As
Chemical oxidation (addition of oxidizing substance: ozone, peroxide, permanganate)	Stimulate abiotic transformation of contaminants	PCE TCE BTEX	Decrease solubility and stimulate immobilization of metals on precipitated iron species	As
Thermal remediation (addition of heat using steam, conductive heating, electrical resistive heating)	Volatilize/pyrolyze organic contaminants	VOCs, SVOCs	Volatilize metals	Mercury

BTEX = benzene, toluene, ethylbenzene, and xylenes; PCE = perchloroethylene; SVOC = semi-volatile organic compound; TCE = trichloroethylene; VOC = volatile organic compound.

Section 4: References

- Aziz, J.A. 2000. Monitoring and Remediation Optimization System (MAROS). <http://www.gsi-net.com/en/software/free-software/maros.html>
- Aziz, J.A., Ling, M., Rifai, H.S., Newell, C.J., and J.R. Gonzales. 2003. *MAROS: A Decision Support System for Optimizing Monitoring Plans*. Ground Water. 41(3): 355-367
- Chapelle, F.H., Widdowson, M.A., Brauner, J.S., Mendez III, E., and C.C. Casey. 2003. *Methodology for Estimating Times of Remediation Associated with Monitored Natural Attenuation*. Water-Resources Investigations Report 03-4057. U.S. Geological Survey.
- Chapelle, F.H., Novak, J., Parker, J., Campbell, B.G., and M.A. Widdowson. 2007. *A Framework for Assessing the Sustainability of Monitored Natural Attenuation*. Circular 1303. Toxic Substances Hydrology Program. U.S. Geological Survey, Reston, Virginia.
- Comprehensive Environmental Response, Compensation, and Liability Act of 1980. 1980. Public Law 96-510, as amended, 42 USC 9601 et seq.
- Early, T., Borden, B., Heitkamp, M., Looney, B.B., Major, D., Waugh, J., Wein, G., Wiedemeier, T., Vangelas, K.M., Adams, K.M., and C.H. Sink. 2006. *Enhanced Attenuation: A Reference Guide on Approaches to Increase the Natural Treatment Capacity of a System*. (WSRC-TR-2005-00198). Prepared for the U.S. Department of Energy. January 2006.
- EPA. 1971. *Residue, Filterable (Gravimetric, Dried at 180°C)*. EPA Method 160.1, U.S. Environmental Protection Agency, Washington, D.C.
- EPA. 1993. *Determination of Nitrate-Nitrite Nitrogen by Automated Colorimetry*. Method 353.2, Environmental Monitoring Systems Laboratory, Office of Research and Development, U.S. Environmental Protection Agency, Cincinnati, Ohio.
- EPA. 1996. *Completed North American Innovative Remediation Technology Demonstration Project*. (EPA 542-B-96-002; PB 96-153-127). August 12, 1996. , Office of Solid Waste and Emergency Response, U.S. Environmental Protection Agency
- EPA. 1997. *Engineering Bulletin: Technology Alternatives for the Remediation of Soils Contaminated with As, Cd, Cr, Hg, and Pb*. (EPA/540/S-97/500). August 1997. Office of Emergency and Remedial Response Washington, DC. Office of Research and Development, U.S. Environmental Protection Agency, Cincinnati, Ohio.

Section 4: References

- EPA. 1999. *Use of Monitored Natural Attenuation at Superfund, RCRA Corrective Action, and Underground Storage Tank Sites*. OSWER Directive 92000.4-17P, Office of Solid Waste and Emergency Response, U.S. Environmental Protection Agency, Washington, D.C.
- EPA. 2005. *Roadmap to Long-Term Monitoring Optimization*. (EPA 542-R-05-003). Office of Superfund Remediation and Technology Innovation. U.S. Environmental Protection Agency.
- EPA. 2007a. *Monitored Natural Attenuation of Inorganic Contaminants in Ground Water - Volume 1, Technical Basis for Assessment*. EPA/600/R-07/139, U.S. Environmental Protection Agency, Washington, D.C.
- EPA. 2007b. *Monitored Natural Attenuation of Inorganic Contaminants in Ground Water - Volume 2, Assessment for Non-Radionuclides Including Arsenic, Cadmium, Chromium, Copper, Lead, Nickel, Nitrate, Perchlorate, and Selenium*. EPA/600/R-07/140, U.S. Environmental Protection Agency, Washington, D.C.
- EPA. 2007c. *Remediation Evaluation Model for Chlorinated Solvents (REMChlor)*. <http://www.epa.gov/ada/csmos/models/remchlor.html>
- EPA. 2010. *Monitored Natural Attenuation of Inorganic Contaminants in Ground Water - Volume 3, Assessment for Radionuclides Including Tritium, Radon, Strontium, Technetium, Uranium, Iodine, Radium, Thorium, Cesium, and Plutonium-Americium*. EPA/600/R-10/093, U.S. Environmental Protection Agency, Washington, D.C. Espinoza, F.P., Minsker, B.S., and D.E. Goldberg. 2005. Adaptive Hybrid Genetic Algorithm for Groundwater Remediation Design. *Journal of Water Resources Planning and Management*, 121(1): 14-24.
- Evanko, C.R., and D.A. Dzombak. 1997. *Remediation of Metals-Contaminated Soils and Groundwater*. (TE-97-01), Prepared for the Ground-Water Remediation Technologies Analysis Center (GWR-TAC). October 1997.
- Farhat, S.K. 2004. SourceDK Source Attenuation Tool. <http://www.gsi-net.com/en/software/free-software/sourcedk.html>
- Farhat, S.K. 2006. Mass Flux Toolkit. <http://www.gsi-net.com/en/software/free-software/mass-flux-toolkit.html>
- Harre, K., Chaundhry, T., Greenwald, R., Jian, W., Davis, C., Zavislak, M., and B. Minsker. 2009. Final Report: Adaptive Long-Term Monitoring at Environmental Restoration Sites. ESTCP Project ER-0629, TR-2137-ENV. http://www.sampleoptimizer.com/index_files/ESTCP.html

Section 4: References

- ITRC (Interstate Technology & Regulatory Council). 2010. *Use and Measurement of Mass Flux and Mass Discharge*. MASSFLUX-1. Washington, DC.: Interstate Technology & Regulatory Council, Integrated DNAPL Site Strategy Team. www.itrcweb.org
- Kamath, R. 2006. BIOBALANCE ToolKit. <http://www.gsi-net.com/en/software/free-software/biobalance-toolkit.html>
- Looney, B.B., Early, T.O., Gilmore, T., Chapelle, F.H., Cutshall, N.H., Ross, J., Ankeny, M., Heitkamp, M., Major, D., Newell, C.J., Waugh, W.J., Wein, G., Vangelas, K.M., Adams, K.M., and C.H. Sink. 2006. *Advancing the Science of Natural and Enhanced Attenuation for Chlorinated Solvents*. (WSRC-STI-2006-00377). Prepared for the U.S. Department of Energy. December 27, 2006.
- Mulligan CN, RN Yong, and BF Gibbs. 2001. *Remediation technologies for metal-contaminated soils and groundwater: an evaluation*. Engineering Geology. 60, 193-207.
- Newell, C.J., Rifai, H.S., Wilson, J.T., Connor, J.A., Aziz, J.A., and M.P. Suarez. 2002. *Calculation and Use of First-Order Rate Constants for Monitored Natural Attenuation Studies*. (EPA/540/S-02/500). National Risk Management Research Laboratory, U.S. Environmental Protection Agency, Cincinnati, Ohio, November 2002.
- Sale, T., Newell, C., Stroo, H., Hincsee, R., and P. Johnson. 2008. *Frequently Asked Questions Regarding Management of Chlorinated Solvents in Soils and Groundwater*. Developed for the Environmental Security Technology Certification Program (ESTCP). July 2008.
- Truex, M.J., Newell, C.J., Looney, B.B., and K.M. Vangelas. 2006. *Scenarios Evaluation Tool for Chlorinated Solvent MNA*. (WSRC-STI-2006-00096). Prepared for the U.S. Department of Energy. August 16, 2006.

Appendix A: Synopsis of Mass Flux (Adapted from ITRC)

A.1 Mass Flux and Mass Discharge Concepts and Definitions

Mass flux and *mass discharge* have been used interchangeably in common engineering practice, even though the two terms represent different contaminant plume parameters. These terms may be defined as follows:

- *Mass Flux*: contaminant load per unit area, measured as mass per area per time.
- *Mass Discharge*: contaminant load past a transect (control plane), measured as mass per time

Although “mass discharge” defines the rate of contaminant mass discharge from a source or the total mass crossing a control plane (e.g., property boundary), “total mass flux” has been used more often in common practice when referring to the total estimated contribution from individual mass fluxes. Also, the term “mass flux” is often used to describe the estimate of the total mass of contaminant(s) moving in the impacted groundwater, and the term is also often used to describe the general concept.

Mass flux (J , units of mass/time/area, e.g., grams/day/m²) represents the mass of a chemical that passes through a defined cross-sectional area over a period of time, and is indicative of two key features of a contaminants plume: the concentration of the chemical and the groundwater flux. Although the mass flux is an important indicator of plume behavior and heterogeneities within the contaminated formation, mass flux measurements are limited to discrete segments of the entire plume. The “total mass flux” (also termed “integrated mass flux”) or mass discharge (M_d , units of mass/time, e.g., grams/day) represents the total mass conveyed by the plume at a certain distance, and may be used to characterize the strength of a source zone or the attenuation rate within a plume. Figure A.1 summarizes the mass flux and mass discharge concepts.

Appendix A: Synopsis of Mass Flux (Adapted from ITRC)

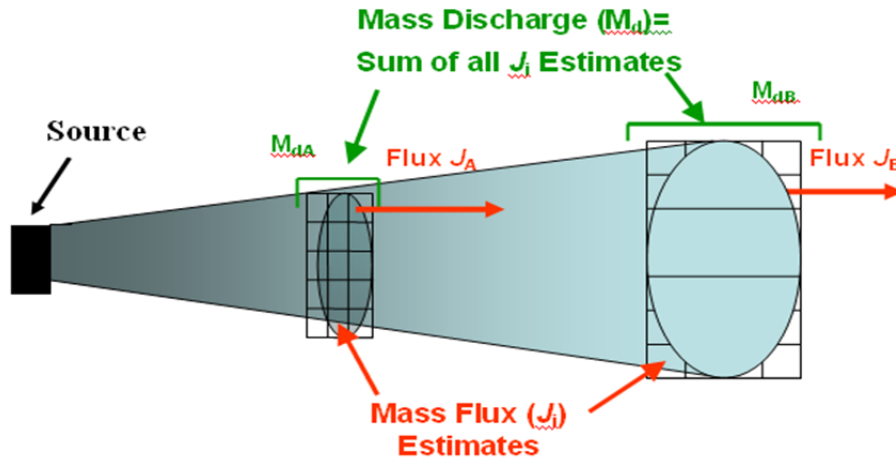

Figure A.1. The concepts of mass flux (J) and mass discharge (M_d). Flux describes the mass moving past a plane of given area per unit time (e.g., grams per day per square meter). Mass discharge describes the total flux integrated over the entire area of the plume (e.g., grams per day).

A.2 Mass Flux and Mass Discharge Measurement Methods

Several methods exist for calculating mass flux and mass discharge, and these include the following:

- Transect method
- Well capture / pump test method
- Passive flux meters
- Synthetic transects
- Application of solute transport models.

A.2.1 Transect Method

The transect method relies on the measurements of dissolved contaminant concentrations and the specific discharges across each control plane in single or multidepth monitoring locations (Figure A.2). Mass discharge is calculated for each monitoring area (discrete polygons), and the mass discharge is then determined by the summation of the mass fluxes for the entire control plane area, as seen in Equation (A.1):

$$q = -K \cdot i \quad (\text{A.1})$$

where: q = Darcy groundwater velocity ($L^3/L^2/T$ – e.g., liters/ m^2/d)

□ K = Saturated hydraulic conductivity (L/T – e.g., m/d)

i = Hydraulic gradient (L/L , e.g., m/m)

Appendix A: Synopsis of Mass Flux (Adapted from ITRC)

C = Contaminant concentration (M/L^3 – e.g., mg/L)

and,

$$M_d = \sum_{j=n}^{j=n} C_j q_j A_j \quad (\text{A.2})$$

where: C_n = concentration of constituent at polygon n in transect (M/L^3)

q_n = specific discharge through polygon n (L/T).

A_n = Flow area through polygon n (L^2)

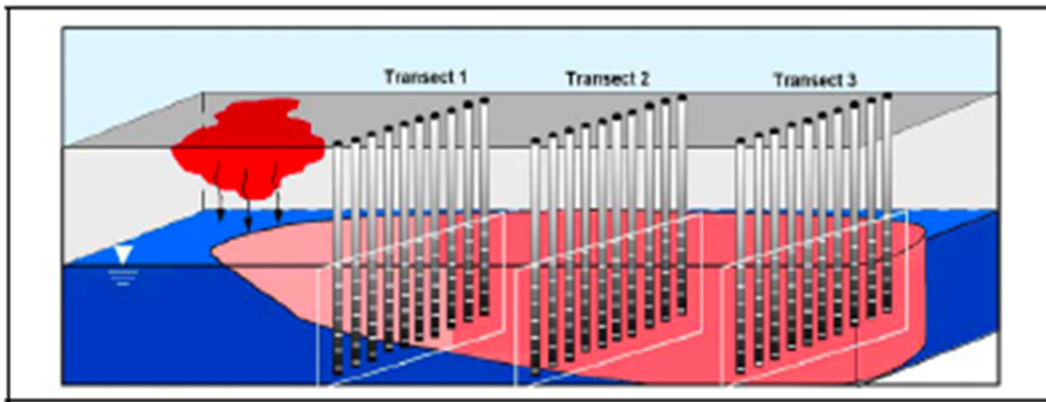

Figure A.2. Transect method control plane monitoring network

A.2.2 Well Capture / Pump Test Method

In this method, an extraction well(s) is used to capture a contaminant plume, and the measured flow rate and contaminant concentrations are used to determine the mass discharge as follows:

$$M_d = Q \cdot C \quad (\text{A.3})$$

where: Q = well flow rate (L^3/T)

C = concentration from the well (M/L^3)

In the case that multiple extraction wells are used to capture the plume, the mass discharge values calculated for each well are summed to obtain the mass discharge for the entire plume.

Appendix A: Synopsis of Mass Flux (Adapted from ITRC)

A.2.3 Passive Flux Meter (PFM) Method

Passive flux meters are constructed of a sorbent material (intercept the dissolved phase contaminant) containing a soluble tracer solution. As the groundwater moves past the deployed PFM, the dissolved contaminants sorb to the permeable sorbent while the tracer solution leaches out of the device. The PFMs are generally deployed in a dedicated borehole or a monitoring well for a period of approximately a few days to a month. After the completion of the test period, the mass of contaminant sorbed, and the mass of the tracer remaining in the PFM are determined and the mass flux (mass/area/time) calculated accordingly. If multiple passive flux meters are used an average mass flux and/or mass discharge across a control plane can be calculated.

A.2.4 Synthetic Transect Method

This method is based on contours of groundwater contaminant concentrations derived from the site's monitoring network, and may be used at sites where direct mass flux measurements are not available. Transect lines are drawn on the contour map, and the dimension of the polygons used for mass flux calculations are defined by the distance between contour lines on a transect (width) and the saturated thickness of the aquifer (depth). This method provides an estimate of the mass flux, and its results are based on the accuracy of the contouring, consequently, a more accurate contouring approximation will provide a more accurate estimate of the mass flux and/or mass discharge.

A.2.5 Solute Transport Models

Models which use contaminant concentrations and groundwater flow data are capable of generating mass flux result from the input parameters. The list below summarizes the models which may be used to estimate mass flux:

- BIOBALANCE
- BIOCHLOR
- BIOSCREEN
- MODFLOW/MT3D and MODFLOW/MT3DMS
- MODFLOW/RT3D

Table A.1 summarizes the advantages and limitations of the above describe mass flux and mass discharge estimation methods.

Appendix A: Synopsis of Mass Flux (Adapted from ITRC)**Table A.1.** Transect and Well Capture Mass Flux and Mass Discharge Estimation Methods Comparison

Mass Flux and Discharge Estimation Methods	Advantages	Limitations
Transect Method	<p>Greater data resolution including localized flux variations</p> <p>Reduced sample volume and disposal</p> <p>Natural flow regime undisturbed</p>	<p>Higher risk of interpolation errors</p> <p>Higher risk of missing discrete flux zones (especially high flux zones)</p> <p>Increased cost for transect points installation and sample analyses</p>
Wall Capture Method	<p>Reduced interpolation error</p> <p>Higher probability of capturing entire contaminant mass</p> <p>Low probability of missing variable flux zones</p>	<p>Potential for error due to under- or over- capture</p> <p>Disturbed flow regime – potential for induced migration</p> <p>Increased cost for wells, analyses and water disposal</p>
Passive Flux Meter Method	<p>Direct measurement of solute flux</p> <p>Measure cumulative groundwater and contaminant fluxes</p> <p>Improved spatial characterization over the depth of the aquifer</p>	<p>Tracer compounds may be influenced by site remedial activities</p> <p>Formation type may influence the applicability</p> <p>Method assumes horizontal flow</p>
Synthetic Transect Method	<p>Existing monitoring wells may be used to estimate mass flux</p>	<p>Potential inaccuracy due to limited number of monitoring wells or misinterpretation of monitoring data</p>
Solute Transport Models	<p>Groundwater flow and concentration data provide mass flux estimates</p> <p>Accurate input data (flow and concentration) allows accurate mass flux estimates</p>	<p>Analytical models with simplifying assumptions should only be used for screening purposes</p> <p>Model calibration and uncertainty must be determined to ensure accurate site representation</p>

Appendix B: Synopsis of Mercury Chemistry

Mercury occurs naturally as a metallic mineral (quicksilver) or as cinnabar (HgS), which is found in sulfide ores. Mercury is commonly associated with the by-products of processing ore that contains sulfide, oxide, and chloride minerals. Soil background concentrations are 20-410 ppb (world) and 40-280 ppb (United States) (Kabatas-Pendias and Pendias 1984). The specific state and form in which the mercury is found in an environmental medium is dependent upon a number of factors, including the ORP and pH of the medium. The most reduced form of mercury is metallic mercury, which is a liquid at ambient temperatures but readily vaporizes. In soils and surface waters, mercury can exist as mercuric (Hg^{+2}) and mercurous (Hg^{+}) ions. Mercury(II) forms relatively strong complexes with Cl^- , OH^- , and CO_3^{2-} . In aerobic freshwater, the HgOHCl species often predominates (Stumm and Morgan 1981). Additionally, other Cl^- species present under aerobic conditions include HgCl^+ , HgCl_2 , HgCl_3^- , and HgCl_4^{2-} . Mercury also forms complexes with F^- , Br^- , I^- , SO_4^{2-} , S^- , and PO_4^{3-} . Mercury(II) forms strong complexes with sulfhydryl groups, amino acids, humic acids, and fulvic acids.

The solubility of mercury is very high under oxidized aquatic conditions due to its strong complexation with inorganic and organic ligands. Additionally, the solubility of some mercury solid phases (HgS , HgO , and HgCl_2) increase in the presence of humic acids.

Mercury is likewise strongly sorbed to humic materials. Inorganic mercury sorbed to particulate material is not readily desorbed. Thus, freshwater sediments are important repositories for inorganic forms of the compound, and leaching is a relatively insignificant transport process in soils. However, surface runoff is an important mechanism for moving mercury from soil to water, particularly for soils with high humic content.

The most common organic form of mercury, methylmercury, is soluble and mobile and quickly enters aquatic food chains. Methylmercury in surface water is rapidly accumulated by aquatic organisms; concentrations in carnivorous fish at the top of freshwater food chains (e.g., pike) are biomagnified on the order of 10,000 to 100,000 times the concentration found in ambient waters. Aquatic macrophytes also have been found to bioconcentrate methylmercury.

The large number of chemical and biological reactions in which mercury can participate complicates accurate fate and transport and risk models. Accurate risk assessment is critical in implementing monitored natural attenuation of mercury (e.g., Wang, Daekeun, et al. 2004).

Appendix B: Synopsis of Mercury Chemistry

References

Kabatas-Pendias A and A Pendias. 1984. *Trace Elements in Soils and Plants*. CRC Press, Boca Raton, Florida.

Stumm W and JJ Morgan. 1981. *Aquatic Chemistry*. Wiley Press, New York.

Wang Q, K Daekeun, et al. 2004. "Sources and remediation for mercury contamination in aquatic systems: a literature review." *Environmental Pollution* **131**: 323-336.

Appendix C: Synopsis of Tritium, Radon, Americium, and Thorium

Tritium: Tritium (^3H) has a half-life of 12.3 years and quickly combines to form tritiated water where decay and dilution are the only attenuation mechanisms. Enhancements to provide sufficient time for decay may be useful.

Radon: Radon (^{222}Rn) forms from the decay of ^{226}Ra where ^{226}Ra is formed by decay of uranium and thorium and has a 3.82 day half-life. Radon is a colorless, odorless noble gas that will be transported in the subsurface either through open pore spaces or dissolved in groundwater (Radon also partitions into organic liquids). Because of its relatively short half-life, radon's concentration is largely controlled by that of its parent ^{226}Ra . Considering ^{226}Ra scenarios is therefore a critical first step to assessing radon issues.

Americium: Americium ion Am^{3+} forms hydroxyl complexes and two relatively insoluble solids – $\text{Am}(\text{OH})_3$ and AmOHCO_3 . The pH of minimum americium solubility is \sim pH 8. Higher pHs with higher alkalinities cause greater americium mobility through the formation of Am-carbonate complexes. Americium also sorbs and/or co-precipitates to iron and manganese hydroxides, clays, carbonates, and sulfides.

Thorium: Thorium exists in most waters as $\text{Th}(\text{OH})_4^{\text{aq}}$ or as $\text{Th}(\text{OH})_4$ colloids or polymers. Thorium forms thorium-carbonate complexes at high pH and thorium-sulfate complexes at low pH. A control over thorium solubility is the formation of $\text{ThO}_{2(\text{am})}$. Thorium sorbs strongly to a wide range of soil solids over the breadth of soil pHs.