

# HIGHER ORDER MODES DAMPING ANALYSIS FOR THE SPX DEFLECTING CAVITY CYROMODULE\*

L. Xiao, Z. Li, C. Ng, SLAC, Menlo Park, CA 94025, USA  
 A. Nassiri, G. Waldschmidt, G. Wu, ANL, Argonne, IL 60439, USA  
 H. Wang, R. Rimmer, JLAB, Newport News, VA 23606, USA

## Abstract

A single-cell superconducting deflecting cavity operating at 2.815 GHz has been proposed and designed for the Short Pulse X-ray (SPX) project for the Advanced Photon Source (APS) upgrade. A cryomodule of 4 such cavities will be needed to produce the required 2-MV deflecting voltage. Each deflecting cavity is equipped with one fundamental power coupler (FPC), one lower order mode (LOM) coupler, and two higher order mode (HOM) couplers to achieve the stringent damping requirements for the unwanted modes. The damping of the LOM/HOM below the beampipe cutoff has been analyzed in the single cavity geometry and shown to meet the design requirements. The HOM above the beampipe cutoff in the 4-cavity cryomodule, however, may result in cross coupling which may affect the HOM damping and potentially be trapped between the cavities which could produce RF heating to the beamline bellows. We have evaluated the HOM damping in the 4-cavity cryomodule using the parallel finite element EM code suite ACE3P developed at SLAC. We will present the results of the cryomodule analysis in this paper.

## INTRODUCTION

The Advanced Photon Source (APS) can provide pulses with several tens to hundreds of picoseconds. However, there are growing requests from users who want to utilize short pulse X-rays (SPX) for the analysis of short time-scale physical processes. Without disrupting the regular X-ray pulse usage for other users, it has been proposed at APS [1] to utilize a pair of superconducting deflecting cavity modules to generate  $\sim 1$ ps X-ray pulses. There were two different designs (on-cell and off-cell damping) for a single-cell deflecting cavity operating at 2.815 GHz being studied for the SPX project [2]. The on-cell damping scheme has been selected as the SPX deflecting cavity design. In the on-cell damping scheme, the low order mode (LOM) coupler is directly attached to the cell at the cavity equator which can offer a more compact geometry with enhanced LOM and higher order mode (HOM) damping. A cryomodule of four such cavities will be needed to produce the required 2-MV deflecting voltage [3].

Each SPX deflecting cavity is equipped with one fundamental power coupler (FPC), one LOM coupler, and two HOM couplers to achieve the stringent damping requirements for the unwanted modes. The FPC and two HOM couplers form a Y-end group on the beampipe. The trapped modes damping below the beampipe cutoff has

\*Work supported by the U.S. Department of Energy, Office of Science, Office of Basic Energy Sciences, under Contract No. DE-AC02-06CH11357

been analyzed in the single cavity without the FPC and LOM coupler windows [4]. And their damping has shown to meet the design requirements. However, the LOM/HOM damping could be affected by the presence of the windows, especially the FPC window which is narrow band. In addition, the HOM above the beampipe cutoff in the 4-cavity cryomodule may result in cross coupling or potentially be trapped in the beam pipe between the cavities. We have used the parallel finite element EM code suite ACE3P developed at SLAC to analyze the trapped mode damping in the single-cell SPX deflecting cavity with and without the FPC and LOM coupler windows, and the damping of the propagating HOMs in the 4-cavity SPX deflecting cavity cryomodule. In this paper, we will present the results of these studies.

## TRAPPED MODES IN THE SINGLE SPX DEFLECTING CAVITY

### *Single Cavity without FPC, LOM Coupler Windows*

The single SPX deflecting cavity without the FPC and LOM coupler windows is shown in Figure 1. Here, the x and y-axis correspond to the APS vertical and horizontal planes. The trapped modes below the beampipe cutoff ( $\sim 3.38$  GHz) are simulated using the parallel finite element EM code suite ACE3P [5]. The shunt impedances of the monopole and dipole modes are presented in Figure 2. There are three important modes that are below the beam pipe cutoff – the lower order monopole mode (LOM) around 2.24GHz which is below the operating mode frequency, and a pair of dipole modes around 3GHz that have higher transverse shunt impedances. All the trapped modes below the beampipe cutoff are shown to be effectively damped by the couplers with a larger safety margin.

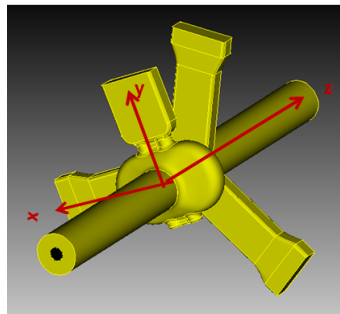

Figure 1: SPX deflecting cavity design without the FPC and LOM coupler windows.

Due to the asymmetry of the end group and on-cell damping waveguide, there are two dipole modes in the y polarization (see Figure 1) with their electric center significantly off the beam axis. The field profile of one of these dipole modes is shown in Figure 3. Such modes will be excited even the beam is on axis and induce dipole wakefield. Their equivalent monopole components are calculated and presented in Figure 2 (a). The effect on the beam needs to be further analyzed.

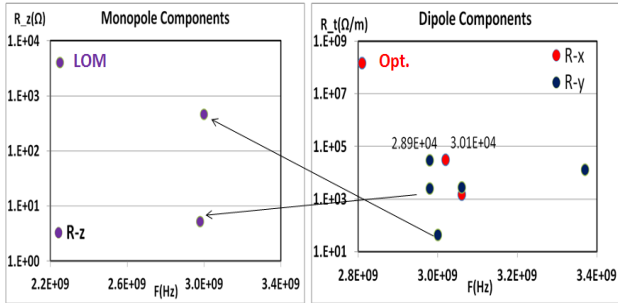

Figure 2: The trapped modes shunt impedances in the single SPX deflecting cavity without the FPC and LOM coupler windows. (a) monopole impedances and (b) dipole impedances in vertical and horizontal directions.

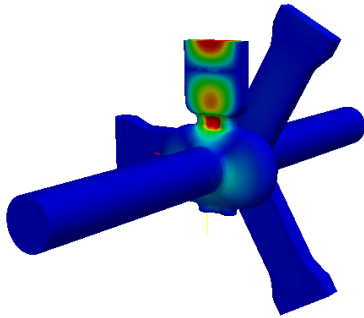

Figure 3: One of the off center dipole modes.

### Higher Shunt Impedance Dipole Modes in the Single Cavity with FPC, LOM Coupler Windows

The LOM/HOM damping below the beampipe cutoff has been analyzed in the single SPX deflecting cavity without the FPC and LOM coupler windows. All the trapped modes have shown to meet the design damping requirements. However, one waveguide in the Y-shaped damper will be used as the FPC coupler (Figure 4). The FPC window is a simple block window which has a fairly narrow band transmission around 2.815 GHz. The LOM coupler double windows are designed to have a broad pass band. The transmission curve of the LOM coupler windows below the beampipe cutoff is plotted in Figure 5. It has a narrow stop band around 3.2 GHz. To evaluate the effect of these windows on damping, the pair of dipole modes having higher shunt impedances is calculated in the single cavity geometry with the FPC and LOM coupler windows included as shown in Figure 4.

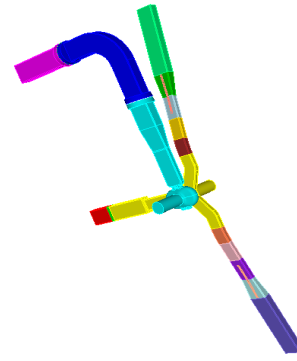

Figure 4: SPX deflecting cavity layout with the FPC and LOM coupler windows.

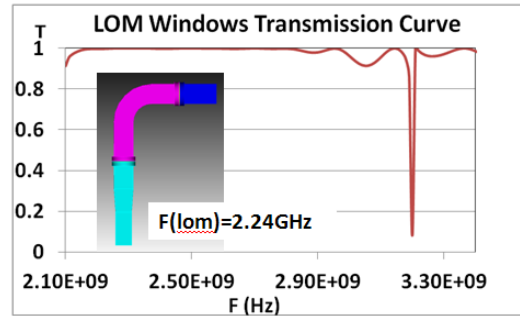
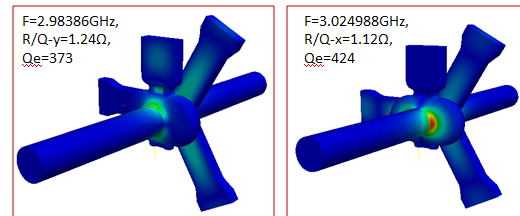
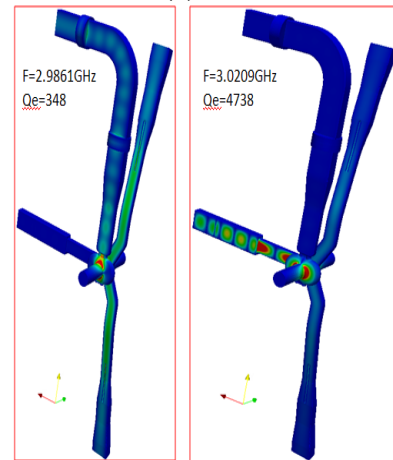

Figure 5: The transmission curve of the LOM coupler windows below the beampipe cutoff.



(a)



(b)

Figure 6: The higher shunt impedance dipole modes in the single SPX deflecting cavity (a) without and (b) with the FPC and LOM coupler windows.

In the calculation, the FPC port is terminated with an electric boundary condition since the FPC does not allow well the propagation of power at the frequencies of the interested higher order modes. The dipole modes which have higher shunt impedances around 3 GHz in the full loaded single cavity geometry are presented in Figure 6 (b). Comparing the damping results in Figure 6 (a) and (b), the waveguide step and the FPC window do present noticeable effects on the damping. However, they are still within the design requirements. There are more extra modes found below the beampipe cutoff frequency due to the windows waveguide transition. Those modes concentrate more in the waveguide regions and have low shunt impedances and are efficiently damped.

## PROPAGATING MODES IN THE FOUR DEFLECTING CAVITY CYROMODULE

The single cavity simulation is focused on the modes that are below beampipe cutoff. The propagating modes above the beampipe cutoff in the 4-cavity cyromodule can couple between the cavities that may affect the HOM damping as well as induce trapped modes between the cavities which could produce RF heating to the beamline bellows. The layout of a 4-cavity SPX deflecting cavity cyromodule is shown in Figure 7 (a). The RF model for the propagating HOM calculations is shown in Figure 7 (b). The FPC and LOM windows are not included in the 4-cavity module in the present study.

The HOM damping calculation up to 5 GHz in the 4-cavity cryomodule is performed with two different cavity spacings to study the effect of the cavity separation on the HOM damping. The beam pipes on both ends are assumed matched (as these modes will propagate). The damping results are shown in Figure 8.

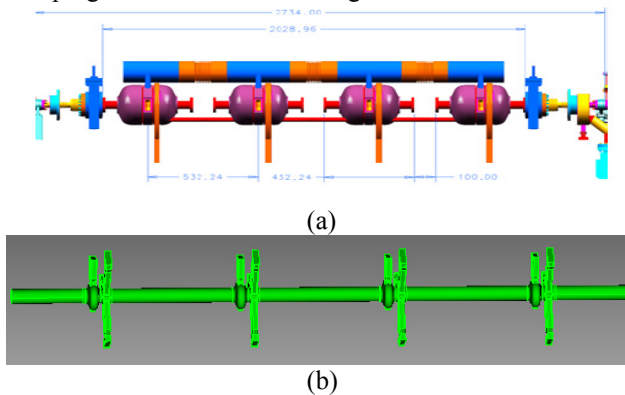

Figure 7: (a) Four cavity string's cyromodule layout and (b) cyromodule simulating model.

The simulations show that the cavity separation has no significant effect on the propagating HOM damping. There are no strong trapped modes up to 5 GHz found between the cavities.

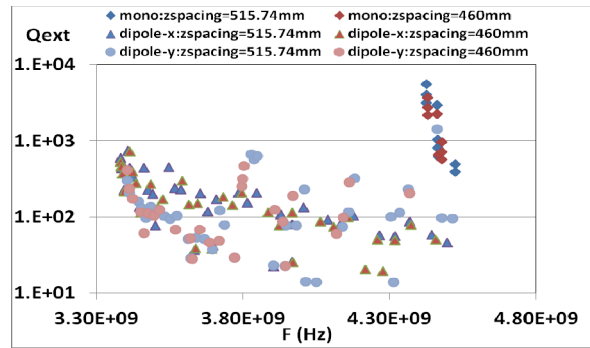

Figure 8: The propagating HOM damping results in the SPX deflecting cavity cyromodule.

## SUMMARY

We have evaluated the trapped mode damping in the single SPX deflecting cavity with and without the FPC and LOM coupler windows, and the propagating modes damping in the SPX 4-cavity cyromodule using the parallel finite element code suite ACE3P. The simulation results show that the trapped modes are heavily damped by the LOM and HOM couplers. The electric center of some of the dipole modes are shifted off center due to the asymmetry of the dampers. Further beam dynamic analysis might be required to evaluate their effects on the beam. Furthermore, the propagating modes up to 5 GHz are also damped to meet the design requirements. There is no trapped mode between the cavities. In near future, we would evaluate the damping of the 4-cavity module with the presence of waveguide windows, to evaluate the broadband impedance of the beampipe bellows. We will further perform integrated analysis including the EM and thermal effects of the deflecting cavity module.

## ACKNOWLEDGEMENT

The work used the resources of NERSC at LBNL which is supported by the Office of Science of the U.S. DOE under Contract No. DE-AC03-76SF00098.

## REFERENCES

- [1] A. Zholents et al., NIM A 425 (1999) 385.
- [2] G. Waldschmidt et al., "Superconducting Cavity Design for Short-Pulse X-Rays at the Advanced Photon Source", PAC11, New York, USA.
- [3] A. Nassiri et al., "Status of the Short-Pulse Project (SPX) at the Advanced Photon Source", in this proceedings.
- [4] H. Wang et al., "Crab Cavity and Cyromodule Prototype Development for the Advanced Photon Source", PAC11, New York, USA.
- [5] K. Ko et al., "Advances in Parallel Electromagnetic Codes for Accelerator Science and Development", LINAC2010, Tsukuba, Japan.