



# Targeting Net Zero Energy at Marine Corps Base Kaneohe Bay, Hawaii: Assessment and Recommendations

K. Burman, A. Kandt, L. Lisell, S. Booth,  
A. Walker, J. Roberts and J. Falcey

NREL is a national laboratory of the U.S. Department of Energy, Office of Energy Efficiency & Renewable Energy, operated by the Alliance for Sustainable Energy, LLC.

## Technical Report

NREL/ TP-7A40-52897

November 2011

Contract No. DE-AC36-08GO28308

# Targeting Net Zero Energy at Marine Corps Base Kaneohe Bay, Hawaii: Assessment and Recommendations

K. Burman, A. Kandt, L. Lisell, S. Booth,  
A. Walker, J. Roberts and J. Falcey

Prepared under Task No. IDHW.9180

**NREL is a national laboratory of the U.S. Department of Energy, Office of Energy Efficiency & Renewable Energy, operated by the Alliance for Sustainable Energy, LLC.**

## NOTICE

This report was prepared as an account of work sponsored by an agency of the United States government. Neither the United States government nor any agency thereof, nor any of their employees, makes any warranty, express or implied, or assumes any legal liability or responsibility for the accuracy, completeness, or usefulness of any information, apparatus, product, or process disclosed, or represents that its use would not infringe privately owned rights. Reference herein to any specific commercial product, process, or service by trade name, trademark, manufacturer, or otherwise does not necessarily constitute or imply its endorsement, recommendation, or favoring by the United States government or any agency thereof. The views and opinions of authors expressed herein do not necessarily state or reflect those of the United States government or any agency thereof.

Available electronically at <http://www.osti.gov/bridge>

Available for a processing fee to U.S. Department of Energy and its contractors, in paper, from:

U.S. Department of Energy  
Office of Scientific and Technical Information  
P.O. Box 62  
Oak Ridge, TN 37831-0062  
phone: 865.576.8401  
fax: 865.576.5728  
email: <mailto:reports@adonis.osti.gov>

Available for sale to the public, in paper, from:

U.S. Department of Commerce  
National Technical Information Service  
5285 Port Royal Road  
Springfield, VA 22161  
phone: 800.553.6847  
fax: 703.605.6900  
email: [orders@ntis.fedworld.gov](mailto:orders@ntis.fedworld.gov)  
online ordering: <http://www.ntis.gov/help/ordermethods.aspx>

Cover Photos: (left to right) PIX 16416, PIX 17423, PIX 16560, PIX 17613, PIX 17436, PIX 17721



Printed on paper containing at least 50% wastepaper, including 10% post consumer waste.

## **Contacts**

### **National Renewable Energy Laboratory**

Kari Burman  
National Renewable Energy Laboratory  
[Kari.Burman@nrel.gov](mailto:Kari.Burman@nrel.gov)  
303-384-7558

Alicen Kandt  
National Renewable Energy Laboratory  
[Alicen.Kandt@nrel.gov](mailto:Alicen.Kandt@nrel.gov)

### **MCBH Kaneohe Bay, HI**

William H. Nutting, PE, RA  
Energy Manager/Utilities Engineer  
Phone: (808) 257-1667  
Email: [William.nutting@usmc.mil](mailto:William.nutting@usmc.mil)

John Dunbar  
Resource Efficiency Manager  
Phone: (808) 257-1537  
Email: [John.r.dunbar1.ctr@usmc.mil](mailto:John.r.dunbar1.ctr@usmc.mil)

Ronald Hochbrueckner  
Facilities  
Phone: (808) 257-6883  
Email: [ronald.hochbrueckner@usmc.mil](mailto:ronald.hochbrueckner@usmc.mil)

## **Acknowledgements**

This work is sponsored by the U.S. Department of Energy (DOE) in partnership with the state of Hawaii and the Hawaii Clean Energy Initiative (HCEI).

The National Renewable Energy Laboratory (NREL) would like to thank William H. Nutting, PE, RA (Energy Manager/Utilities Engineer); John Dunbar, PE, CEM (Resource Efficiency Manager) and Ronald P. Hochbrueckner (Electrical Engineer) and the energy team at Marine Corp Base Hawaii-Kaneohe Bay for their invaluable assistance in support of this work.

## Abbreviations and Acronyms

AC	Alternating current
AFV	Alternative fuel vehicle
AHU	Air handling unit
ARRA	American Recovery and Reinvestment Act
Btu	British thermal unit
C&D	Construction and demolition
CHP	Combined heat and power
CNG	Compressed natural gas
CO <sub>2</sub>	Carbon dioxide
COE	Cost of energy
CSP	Concentrating solar power
CSU	Colorado Springs Utilities
CV	Constant volume
DDC	Direct digital controls
DG	Distributed generation
DHW	Domestic hot water
DOD	U.S. Department of Defense
DOE	U.S. Department of Energy
DX	Direct expansion
EE	Energy efficiency
EEAP	Energy Engineering Analysis Program
ECIP	Energy Conservation Investment Program
ECM	Energy conservation measure
EISA	Energy Independence and Security Act of 2007
E.O.	Executive order
EPA	U.S. Environmental Protection Agency
ESCO	Energy service company
ESPC	Energy savings performance contract
EUI	Energy use intensity
FAR	Federal Acquisition Regulation
FEMP	Federal Energy Management Program
FFRDC	Federally Funded Research and Development Center
FFV	Flex fuel vehicle
FRREC	Front Range Renewable Energy Consortium
ft <sup>2</sup>	square foot
GHG	Greenhouse gas
GIS	Geographic information system
GSA	U.S. General Services Administration
GSHP	Ground Source Heat Pump
HCEI	Hawaii Clean Energy Initiative
HECO	Hawaii Electric Company
HEV	Hybrid electric vehicle
HQ	Headquarters
HVAC	Heating, ventilating, and air conditioning
KCF	Thousand cubic feet

kg	kilogram
kVA	kilovolt-ampere
kWh	kilowatt-hour
LCOE	Levelized cost of energy
LED	Light-emitting diode
MCBH	Marine Corps Base Hawaii
MCCS	Marine Corps Community Service
MMBtu	Million British thermal units
MSW	Municipal solid waste
MVA	Mega Volt-Amp
MW	Megawatt
MWe	Megawatt-electrical
MWh	Megawatt-hour
NEPA	National Environmental Policy Act
NETL	National Energy Technology Laboratory
NEV	Neighborhood electric vehicle
NREL	National Renewable Energy Laboratory
NZEI	Net zero energy installation
O&M	Operations and maintenance
PEM	Proton exchange membrane
PNNL	Pacific Northwest National Laboratory
PPA	Power purchase agreement
PSD	Potential for Significant Deterioration
PV	Photovoltaics
RDF	Refuse-derived fuel
REC	Renewable energy certificate
SAM	Solar Advisory Model
SNL	Sandia National Laboratory
SUV	Sport utility vehicle
TES	Thermal energy storage
PACOM	U.S. Pacific Command
VAV	Variable air volume
VFD	Variable frequency drive
W	watt
WTE	Waste to energy
WTG	Wind turbine generator
ZEB	Zero energy building

## Executive Summary

The U.S. Department of Defense (DOD) has long recognized the strategic importance of energy to its mission, and is working to reduce energy consumption, as well as enhance energy security by drawing on local clean energy sources. A recent Defense Science Board report stated that critical military missions are at a high risk of failure in the event of an electric grid failure.<sup>1</sup> The development of on-site renewable energy supplies can reduce this risk, and may become an increasingly important strategic concern. Renewable energy can also contribute to improved security of the energy supply and of the site, decreased or more predictable energy costs, and responsiveness to energy-related Federal or DOD mandates.

DOD's U.S. Pacific Command has partnered with the U.S. Department of Energy's (DOE) National Renewable Energy Laboratory (NREL) to assess opportunities for increasing energy security through renewable energy and energy efficiency in Hawaii installations. On the basis of the installation's strong history of energy advocacy and extensive track record of successful energy projects, NREL selected Marine Corps Base Hawaii (MCBH), Kaneohe Bay to receive technical support for net zero energy assessment and planning funded through the Hawaii Clean Energy Initiative (HCEI). NREL performed a comprehensive assessment to appraise the potential of MCBH Kaneohe Bay to achieve net zero energy status through energy efficiency, renewable energy, and electric vehicle integration. This report summarizes the results of the assessment and provides energy recommendations.

### Defining a Net Zero Energy Installation

This report defines a *net zero energy installation* (NZEI) as follows:

A net zero military installation produces as much energy on-site from renewable energy generation, or through the on-site use of renewable fuels, as it consumes in its buildings, facilities, and fleet vehicles.

*Net zero energy* is a concept of energy self-sufficiency based on minimizing demand and using local renewable energy resources. A complete net zero solution considers all uses of energy within an installation for buildings, transportation, community infrastructure, and industry. NREL's net zero energy assessment for MCBH Kaneohe Bay focused on five areas:

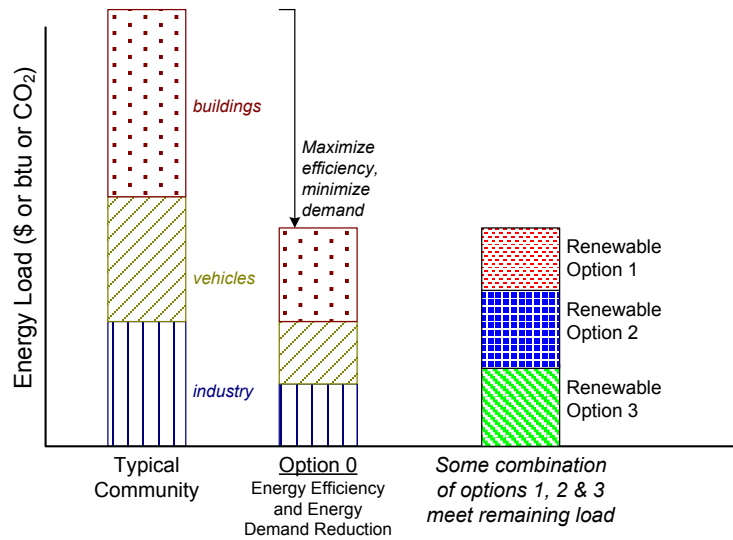
1. An energy baseline
2. Energy efficiency improvements
3. Renewable energy potential
4. Electrical systems analysis
5. Transportation fuel use analysis

Figure 1 shows the phased progression from a typical installation or community, to an installation that has a reduced energy load, to a renewably powered installation.

---

<sup>1</sup> More Fight Less Fuel, Defense Science Board Report. February 2008. [www.acq.osd.mil/dsb/reports/ADA477619.pdf](http://www.acq.osd.mil/dsb/reports/ADA477619.pdf). Accessed May 2010.





**Figure 1. Net zero energy concept**

### MCBH Kaneohe Bay’s Energy Baseline

The first step in a net zero energy assessment is to determine an energy baseline. The baseline provides an analysis of current energy consumption on base. It gives planners and managers a metric to measure progress against. MCBH Kaneohe Bay’s energy baseline includes all energy use in buildings, facilities, and fleet vehicles on the main base, excluding housing, which is privatized.

**Table 1. MCBH Kaneohe Bay Energy Baseline**

Energy Source	2009 Energy Use		
	Site Energy (Variable units)	Site Energy (MMBtu)	Source Energy (MMBtu)
<b>Buildings and Facilities</b>			
Electricity	107,088,800 kWh	365,387	1,432,317
Propane	206,900 gallons	18,890	21,724
<b>Total Building Energy Use</b>		<b>384,277</b>	<b>1,454,040</b>
<b>Fleet Fuel</b>			
Gasoline	181,802 gallons	9,334	10,734
Diesel	93,967gallons	13,860	15,939
<b>Total Fleet Energy Use</b>		<b>23,194</b>	<b>26,673</b>
<b>Total MCBH Kaneohe Bay Energy Use</b>		<b>407,471</b>	<b>1,480,713</b>

### Energy Efficiency

The second step in a net zero energy assessment is to evaluate the potential for reductions in energy use through improvements in energy efficiency. Through discussion with base personnel, analysis of previous energy audits, and modeling of typical buildings, NREL estimated the

energy efficiency savings potential of the base. Table 2 summarizes the potential energy savings at MCBH Kaneohe Bay, which totals 17.03% electrical load reduction, 6.62% propane load reduction, and 16.5 % overall energy reduction.

**Table 2. Energy Efficiency Savings Potential**

<i>Measure</i>	<i>Savings (% of fuel type)</i>		<i>MMBtu Equivalent Savings</i>	<i>% Total Site Savings</i>	
<b>Specific Base Facilities</b>					
Commissary (32% reduction)	MWh	1,401	2.4%	4,780	2.1%
Barracks (40% reduction)	MWh	7,497	12.8%	25,587	11.4%
Offices (43% reduction)	MWh	3,215	5.5%	10,972	4.9%
Gym (52% reduction)	MWh	467	0.8%	1,593	0.7%
Mess Hall (40% reduction)	MWh	1,310	2.2%	4,470	2.0%
<b>Base Wide ECMs</b>					
Retro-commissioning	MWh	2,023	3.5%	6,904	3.1%
Lighting Occupancy Sensors	MWh	935	1.6%	3,190	1.4%
Computer Energy Mgmt	MWh	1,387	2.4%	4,732	2.1%
Water Heater Boilers	MMBtu	1,251	4.8%	1,251	0.6%
<b>Total</b>					
Electricity	MWh	18,233	17.03%	62,211	15.9%
Propane	MMBtu	1,251	6.62%	1,251	0.6%
			<b>Total</b>	<b>63,462</b>	<b>16.5%</b>
			<b>MMBtu</b>		

### Renewable Energy Analysis

After assessing energy use reduction opportunities at MCBH Kaneohe Bay, NREL evaluated the potential for renewable energy generation to meet energy needs that would remain after any energy efficiency improvements were implemented. The most promising technologies for implementation include solar hot water, solar photovoltaics, and wind. Implementation of these projects would provide 100% of electrical energy and 59% of thermal energy from renewable sources at MCBH Kaneohe Bay. A summary of the technologies and their savings can be seen in Table 3 below.

**Table 3. Renewable Energy Technologies: Potential Energy Savings and Payback Period**

<i>Project Name</i>	<i>Size</i>	<i>Savings</i>	<i>Source Btu Savings MMBtu</i>	<i>% of Total MMBtu</i>
PV	10 MW	15,432,643 kWh	206,412	14%
Wind Turbines	28.5 MW	92,879,232 kWh	1,242,263	86%
Solar Hot Water	257,509 ft <sup>2</sup>	11,239 MMBtu	12,925	59%
Daylighting	99,140 ft <sup>2</sup>	2,092,540 kWh	27,988	2%
Totals				161%

## Transportation

The analysis evaluated options for reducing transportation energy use at MCBH Kaneohe Bay, including:

- **Track fleet fuel use:** Tracking allows better management of fuel use and fuel savings opportunities.
- **Right-size the fleet:** Reduce the total number of vehicles in the fleet and allocate savings to other fleet needs.
- **Switch to alternative fuel vehicles:** MCBH Kaneohe Bay is moving quickly to incorporate alternative fuel vehicles in its fleet. MCBH Kaneohe Bay recently installed E85 and B20 refueling pumps. If MCBH Kaneohe Bay replaced half of the gasoline vehicles with flex fuel vehicles (FFV) that run on E85, and if personnel consistently fueled them with E85, this would displace nearly 154,532 gallons of gasoline consumption per year. If biodiesel were used consistently in the diesel vehicle fleet, MCBH Kaneohe Bay could displace another 93,967 gallons of petroleum per year. MCBH Kaneohe Bay should always use E85 in FFVs and B20 biodiesel for diesel vehicles.
- **Hybrid electric vehicles (HEVs) and electric vehicles (EVs):** HEVs are also being introduced into the MCBH Kaneohe Bay fleet to reduce their fuel use. The fleet manager recently mentioned that there are around 100 neighborhood electric vehicles that they operate.
- **Hydrogen fuel cell vehicles:** NREL understands that MCBH- Kaneohe Bay is converting some of their fleet to new hydrogen fueled vehicles. They are also procuring electrolysis equipment to produce hydrogen on site. The hydrogen vehicle fleet is presently 3 sedans that use ~4 kg of hydrogen per tank and 12 kg/week. The electrolysis equipment produces 1 kg/ hr or 168 kg of hydrogen per week. An additional 13 sedans could be purchased to replace gasoline vehicles.

## Implementation

MCBH Kaneohe Bay has several options for implementing energy projects, including energy savings performance contracts (ESPCs), utility energy services contracts (UESCs), power purchase agreements (PPAs), and appropriated funds. Government-owned projects funded through appropriations reduce contractor financing and markup fees, but require up-front capital and would prevent MCBH Kaneohe Bay from receiving federal tax incentives. Government-owned projects would also place an operations and maintenance (O&M) burden on MCBH Kaneohe Bay. By contrast, privately-owned projects would allow MCBH Kaneohe Bay to implement renewables without any upfront capital, and with reduced O&M responsibility. Privately-owned projects would also allow MCBH Kaneohe Bay to take advantage of federal tax credits, although some of the money gained in tax credits will go toward contractor financing and mark-up fees.

Federal energy projects require funding to generate results. Carefully matching available financing mechanisms with specific project needs can make the difference between a stalled,

unfunded project and a successful project, generating energy and cost savings. FEMP supports federal agencies in identifying, obtaining, and implementing alternative financing to fund energy projects.

For assistance with ESPCs, contact:

---

**Scott Wolf**

6848 Cooper Point Road NW  
Olympia, WA 98502  
Phone: 360-866-9163  
Fax: 360-866-9683  
[scott.wolf@ee.doe.gov](mailto:scott.wolf@ee.doe.gov)

---

For UESCs, contact:

---

**David McAndrew**

Federal Energy Management Program  
202-586-7722  
[david.mcandrew@ee.doe.gov](mailto:david.mcandrew@ee.doe.gov)

---

**Karen Thomas**

National Renewable Energy Laboratory  
202-488-2223  
[karen\\_thomas@nrel.gov](mailto:karen_thomas@nrel.gov)

---

For PPAs, contact:

---

**Tracy Logan**

Federal Energy Management Program  
202-586-9973  
[tracy.logan@ee.doe.gov](mailto:tracy.logan@ee.doe.gov)

---

**Chandra Shah**

National Renewable Energy Laboratory  
303-384-7557  
[chandra.shah@nrel.gov](mailto:chandra.shah@nrel.gov)

---

For more information about alternative financing, visit the FEMP Financing Mechanisms Web page at [www.femp.energy.gov/financing/mechanisms.html](http://www.femp.energy.gov/financing/mechanisms.html).

## **Conclusion**

The analysis conducted by NREL shows that MCBH Kaneohe Bay has the potential to make significant progress toward becoming a net zero installation. If the identified energy projects and savings measures are implemented, then a 96% site Btu reduction and a 99% source Btu reduction will be achieved by the base. Using excess wind and solar energy to produce hydrogen for a fleet and fuel cells could significantly reduce their energy use, and could bring the MCBH Kaneohe Bay to net zero. Further analysis with an environmental impact and interconnection study will need to be completed. By achieving this status, the base will set an example for other military installations, provide environmental benefits, reduce costs, increase energy security, and exceed its goals and mandates.

# Table of Contents

Contacts.....	i
Acknowledgements.....	ii
Executive Summary.....	v
Table of Contents.....	x
1 Introduction.....	1
1.1 Overview of the DOD Energy Context.....	1
1.2 Energy Strategies for DOD Installations: Key Considerations.....	2
1.3 NZEI Concept.....	3
1.4 Assessment Approach.....	6
2 MCBH Kaneohe Bay Energy Baseline.....	8
2.1 Overview.....	8
2.2 Site Description.....	8
2.3 MCBH Kaneohe Bay Boundary.....	8
2.4 Total Consumption Breakdown.....	9
2.5 The Electrical Baseline.....	10
2.6 Propane Baseline.....	12
2.7 Transportation Baseline.....	12
2.8 Utility Costs.....	13
3 Reducing Energy Demand by Engaging People.....	14
4 Energy Efficiency Assessment.....	16
4.1 Overview.....	16
4.2 Summary of Proposed Energy Efficiency Projects.....	16
4.3 Base Wide Conservation Measures.....	17
4.4 Privatized Housing.....	20
5 Additional Load Reduction and Renewable Energy Projects.....	22
5.1 Overview.....	22
5.2 Renewable Energy Resource Assessment.....	22
5.3 Renewable Energy Optimization.....	23
5.4 Solar Hot Water.....	24
5.5 Daylighting.....	25
5.6 Photovoltaic.....	27
5.7 Concentrating Solar Power.....	28
5.8 Wind Turbines.....	29

5.9	Fuel Cell.....	31
5.10	Landfill Gas .....	34
5.11	Anaerobic Digestion .....	34
5.12	Hydropower/Ocean Wave Energy .....	35
5.13	Hybrid System Optimization .....	35
6	Transportation Assessment.....	40
6.1	Analysis.....	40
6.2	Additional Strategies to Reduce Load and Footprint.....	42
7	Electrical Systems Assessment and Recommendation.....	45
7.1	Electrical Distribution System Overview .....	45
7.2	Impact Analysis of Distributed Generation .....	46
7.3	Interconnection .....	46
8	Net Zero Energy Potential .....	49
8.1	MCBH Kaneohe Bay Projects .....	49
8.2	Recommended Additional Energy Projects .....	49
8.3	Net Zero Energy Potential .....	50
9	Implementation: Project Planning and Financial Assessment.....	51
9.1	Implementation Options.....	51
9.2	Financial Analysis.....	55
10	Conclusion .....	60
Appendix A. Renewable Energy Resource & Environmental Maps.....		61
Appendix B. Specific Energy Efficiency measures.....		68
Appendix C. Solar PV Projects Identified by MCBH Kaneohe Bay.....		76
Appendix D: Wind Resource & Turbine Placement.....		83
Appendix E: Distribution Feeder Capacity and Load.....		88

## List of Figures

Figure 1. Net zero energy concept .....	vi
Figure 2. DOD Energy Use Breakdown .....	2
Figure 3. Net Zero Energy Concept .....	4
Figure 4. MCBH Properties .....	8
Figure 5. Land use zones .....	9
Figure 6: Typical daily load profile .....	11
Figure 7: Annual load profile.....	11
Figure 8. Fuel use at MCBH Kaneohe Bay 2009 .....	12
Figure 9. Hawaii Electric Cost versus the Price of Oil .....	13
Figure 10. Typical ‘small office’ wall switch sensor application and coverage.....	20
Figure 11. Typical 'open space' ceiling mounted sensor application and coverage.....	20
Figure 12. Direct SHW system .....	24
Figure 13. Daylighting applicable to the MCBH Kaneohe Bay site.....	26
Figure 14. Depiction of major components of grid-connected PV system.....	27
Figure 15. Vergnet 275 kW wind turbine (2 blades) .....	30
Figure 16. Cost curve for Wind Technology .....	30
Figure 17. PowerBuoy .....	35
Figure 18. Monthly average electric production.....	37
Figure 19. Monthly average electric production.....	39
Figure 20: MCBH Kaneohe Bay single line electrical drawing .....	45
Figure 21: Existing MCBH Kaneohe Bay electrical map.....	47
Figure 22. Possible future energy costs .....	57
Figure 23. Energy costs in net metering renewable energy scenario.....	58
Figure 24. Energy costs in feed in tariff renewable energy scenario.....	59
Figure 25. Wind resource on Oahu .....	61
Figure 26. Solar resource on Oahu .....	62
Figure 27. Concentrated solar power resource map for Oahu .....	63
Figure 28. Flood zones.....	64
Figure 29. Biological sensitive lands .....	65
Figure 30. Geothermal resource on Oahu .....	66
Figure 31: Biomass resource maps for all Hawaii islands.....	67
Figure 32. Modeled electricity end use office buildings.....	68
Figure 33. Modeled electricity end use in the commissary .....	70
Figure 34. Modeled electricity end use in barracks .....	71
Figure 35. Modeled electricity end use in main gym.....	73
Figure 36. Modeled Electricity End Use Food Services.....	74
Figure 37. Anemometer placement at N.E tip of MCBH Kaneohe Bay.....	83
Figure 38. Monthly wind speed profile at MCBH Kaneohe Bay .....	84
Figure 39. Diurnal wind speed profile .....	84
Figure 40. Potential sites for wind turbines .....	85
Figure 41. Potential wind turbine placement .....	86
Figure 42. Potential wind turbine placement .....	86
Figure 43. Potential wind turbine placement .....	87
Figure 44. Distribution feeder capacities and load .....	88

## List of Tables

Table 1. MCBH Kaneohe Bay Energy Baseline.....	vi
Table 2. Energy Efficiency Savings Potential .....	vii
Table 3. Renewable Energy Technologies: Potential Energy Savings and Payback Period .....	vii
Table 4. MCBH – Kaneohe Bay Energy Baseline.....	9
Table 5. Fuel Use Annual Baseline.....	12
Table 6. Project Savings Summary .....	16
Table 7. Overall Summary from REO .....	23
Table 8. Total Solar Hot Water.....	25
Table 9. Total Daylighting Savings .....	26
Table 10. PV Capital and Maintenance Costs .....	28
Table 11. PV Economic Analysis .....	28
Table 12. Cost for a 1.5 MW Wind Turbine.....	31
Table 13. Economics for 27 MW Wind Farm .....	31
Table 14. Electrolyzer and Fuel Cell Calculations .....	33
Table 15. Wind Turbine/Grid Hybrid System .....	36
Table 16. Wind Turbine/Grid Annual Energy Production.....	36
Table 17. Wind Turbine/Grid Annual Grid Sales.....	36
Table 18. Wind Turbine Technology and Estimated Number of Turbines for NZEI.....	37
Table 19. PV Modeled Cost.....	38
Table 20. Wind Turbine/PV/Grid Hybrid System .....	38
Table 21. Wind Turbine/PV/Grid Annual Production.....	38
Table 22. Wind Turbine/PV/Grid Annual Grid Sales.....	38
Table 23. Fuel Use Baseline, MCBH Kaneohe Bay .....	40
Table 24. Gasoline Savings for Changing to E85.....	42
Table 25. Gasoline Reduction for Changing to H2.....	42
Table 26. Energy Efficiency Savings Potential .....	49
Table 27. Renewable Energy Technologies: Potential Energy Savings and Payback Period .....	50
Table 28. Modified Accelerated Depreciation Schedule .....	53
Table 29. Base Case Energy Costs .....	56
Table 30. Carport PV Sites for MCBH Kaneohe Bay .....	77
Table 31. Rooftop PV sites for MCBH Kaneohe Bay .....	78
Table 32. MCBH Kaneohe Bay PV Projects Phased Award Plan.....	82



# 1 Introduction

The U.S. Department of Defense (DOD) has long recognized the strategic importance of energy to its mission, and is working to reduce energy consumption, as well as to enhance energy security by drawing on local clean energy sources. A recent Defense Science Board report stated that critical military missions are at a high risk of failure in the event of an electric grid failure.<sup>2</sup> Failures may occur as a result of malicious activities (for example, physical or cyber attacks) or due to blackouts on an aging electric grid infrastructure. The development of on-site renewable energy supplies can reduce this risk, and may become an increasingly important strategic concern. Renewable energy can also contribute to improved security of the energy supply and of the site. It can decrease energy costs or make them more predictable, as well as increase the base's responsiveness to energy-related Federal or DOD mandates.

In 2008 the DOD and U.S. Department of Energy (DOE) defined a joint initiative to address military energy use by identifying specific actions to reduce energy demand and increase use of renewable energy on DOD military installations. In light of DOD priorities, early attention was given to the possibility of net zero energy installations (NZEI), that is, installations that would meet their energy needs with local renewable resources. Because of MCBH Kaneohe Bay's strong history of energy advocacy and extensive track record of successful energy projects, the DOE's National Renewable Energy Laboratory (NREL) selected MCBH Kaneohe Bay to receive technical support through the Hawaii Clean Energy Initiative (HCEI) for net zero energy assessment and planning.

NREL's task was to perform a comprehensive assessment of MCBH Kaneohe Bay's potential to achieve net zero energy status and provide energy project recommendations, and assist in the development of an optimal energy strategy for the base.

## 1.1 Overview of the DOD Energy Context

The DOD is the largest energy consumer in the U.S. government. Present energy use patterns impact DOD global operations by constraining freedom of action and self-sufficiency, demanding enormous economic resources, and putting many lives at risk in associated logistics support operations in deployed environments. There appear to be many opportunities to more effectively meet DOD energy requirements through a combination of human actions, energy efficiency technologies, and renewable energy resources. DOD's corporate hierarchy offers advantages in the implementation of these opportunities at speed and scale: the military has often been a market leader in the adoption of new technologies and complex systems. The present focus of DOD leaders on exploring improvements to energy provision and use in the departments operations—at home and abroad—is timely.

In fiscal year (FY) 2008, the DOD consumed 889 trillion site-delivered British thermal units (Btu) and spent on the order of \$20 billion on energy. The majority of DOD energy consumption is fossil fuel based (coal, oil, natural gas, or electricity produced from these), often from foreign sources. The DOD accounts for about 1.8% of total U.S. petroleum consumption and 0.4% of the world's consumption. A summary of DOD energy use is shown in Figure 2 below. The focus of

---

<sup>2</sup> More Fight Less Fuel, Defense Science Board Report. February, 2008. [www.acq.osd.mil/dsb/reports/ADA477619.pdf](http://www.acq.osd.mil/dsb/reports/ADA477619.pdf). Accessed May 2010.

this report is the 26% of energy used in goal subject buildings<sup>3</sup>, buildings exempted from these mandates, and fleet vehicles. Tactical fuel use is not considered at this time.<sup>4</sup>

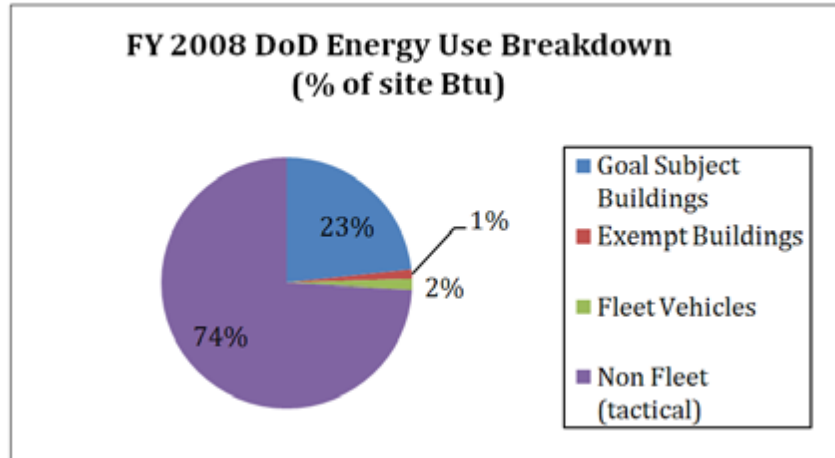


Figure 2. DOD Energy Use Breakdown

## 1.2 Energy Strategies for DOD Installations: Key Considerations

A net zero energy assessment is a framework for a military installation to develop a holistic and systematic energy strategy. An installation's energy strategy should reflect a number of constraints and considerations:

- **Mission compatibility:** Mission accomplishment is the top priority. Even if attractive by other measures, incompatibility with the installation's mission eliminates any energy-related proposal. Wind turbines sited near a runway are one example of an energy technology incompatible with the flying mission at many military installations.
- **Security:** Energy security, surety and reliability, as well as overall physical security of the site, must be maintained or enhanced by the installation's energy system. For example, a biomass-fueled power system may not be suitable to some sites due to offsite truck traffic required to bring in fuel. On the other hand, the ability to meet an installation's critical load using onsite renewable sources (e.g., landfill gas, geothermal power, solar energy) in an islanding mode may greatly enhance energy security. This is underscored not only by the threat of malicious activities (e.g., physical or cyber attacks), but also by possibility of major blackouts such as have occurred in the U.S. many times

---

<sup>3</sup> Federal Buildings are subject to mandated energy efficiency reductions under the National Energy Conservation Policy Act (NECPA) and Executive Order 13423. Some buildings are exempt from these requirements. Guidelines for exempting buildings can be found here. ([http://www1.eere.energy.gov/femp/pdfs/exclusion\\_criteria.pdf](http://www1.eere.energy.gov/femp/pdfs/exclusion_criteria.pdf))

<sup>4</sup> Alternative fuels are in development and testing. Also, tactical fuel use can be reduced through reduction in tactical system use (for example, in favor of simulator-based training), and through application of energy-saving technologies (e.g., skin coatings for aircraft and ships, improvements in aerodynamic/hydrodynamic design, hybrid drive systems for ground vehicles).

in recent decades. More blackouts are anticipated due to aging electric grid infrastructure, decreased maintenance investment, increasing loads, and the lack of situational awareness on the part of grid operators.<sup>5</sup> A recent Defense Science Board report stated that critical military missions are at a high risk of failure in the event of an electric grid failure.<sup>6</sup> The development of onsite energy supplies and smart microgrids, which are part of a net zero energy solution, can reduce this risk, and may become an increasingly important strategic concern.

- **Economics:** Life-cycle, system-based economic assessment of alternatives should reflect such factors as technological maturity; fuel availability and cost; energy storage requirements; distribution and interconnection arrangements; financing options; federal/state/local incentives; environmental impacts; and costs for operations/maintenance and repair/replacement.
- **Agency goals and federal mandates:** The DOD has a strategic energy plan to reduce consumption, leverage new technologies, drive personnel awareness, and increase energy supply; a primary goal is to achieve 25% renewable electrical energy use by 2025. Further, the Army has a plan to create five NZEIs by 2025. By creating these installations the Army will help meet its additional energy security and renewable energy goals.
- **Site resources:** Energy system siting opportunities (buildings; disturbed or undisturbed land; accessibility) vary among installations, as do local climates, renewable energy resources, and electrical system interconnection opportunities.

The contribution of a net zero energy assessment to the development of site-specific energy strategies responsive to these constraints is discussed below.

### 1.3 NZEI Concept

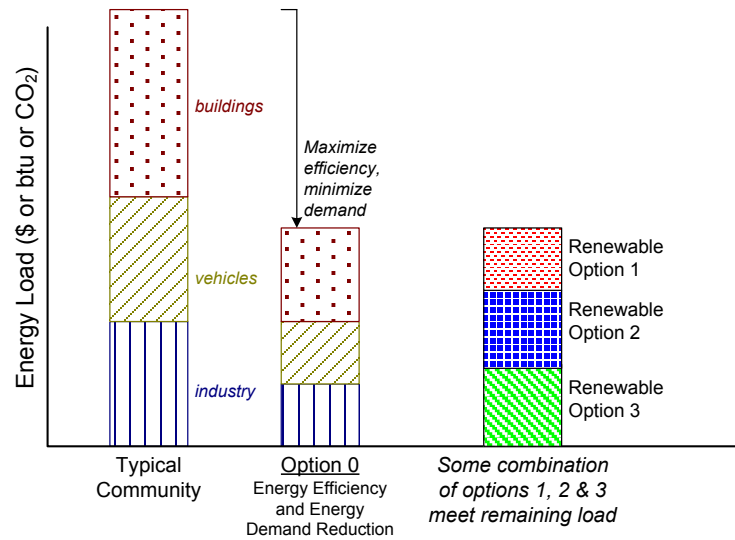
Net zero energy is a concept of energy self-sufficiency based on minimized demand and use of local renewable energy resources. While net zero energy status *per se* is not inherently a high priority for DOD installations, it can serve as a design point well suited to a disciplined exploration of how energy is provided and used. First developed in the context of individual houses, where the challenge is to provide all required energy using onsite renewable resources, the concept has been extended in recent years to communities, campuses, and installations. In principle, a net zero energy installation, or NZEI, should reduce its load through conservation (use what is needed) and energy efficiency (get the biggest bang from the energy buck), then meet the remaining load through onsite renewable energy. Defining an NZEI is complicated by the need to consider – in addition to individual buildings, public facilities and infrastructure – the questions of how to treat energy used for various forms of transportation, and mission – specific energy requirements such as tactical fuel demands.

The NZEI concept is shown graphically in the figure below.

---

<sup>5</sup> *The Smart Grid, An Introduction*. US Department of Energy. No.DE-AC26-04NT41817, Subtask 560.01.04, [http://www.oe.energy.gov/DocumentsandMedia/DOE\\_SG\\_Book\\_Single\\_Pages.pdf](http://www.oe.energy.gov/DocumentsandMedia/DOE_SG_Book_Single_Pages.pdf). Accessed April 2010.

<sup>6</sup> More Fight Less Fuel, Defense Science Board Report. February, 2008. <http://www.acq.osd.mil/dsb/reports/ADA477619.pdf> Accessed May 2010.



**Figure 3. Net Zero Energy Concept**

The original definition of an NZEI adopted by the DOD-DOE task force was, “An installation that produces as much energy on or near the installation, as it consumes in its buildings and facilities.” The definition was elaborated in consultation with the task force to include a focus on renewable energy, on-site generation, and fleet fuel use. The following definition was used for this assessment:

**“A net zero energy military installation produces as much energy onsite from renewable energy generation or through the onsite use of renewable fuels, as it consumes in its buildings, facilities, and fleet vehicles.”**

A more detailed explanation of this elaboration and the net zero definition is given below.

- “Net Zero” means that the energy produced onsite over the period of a given year is equal to the installation’s energy demand. This implies a connection to a local power grid, which in a sense “banks” the energy. Thus onsite renewable resources, say, solar energy systems, may produce energy greater than that used by the installation during the day, with excess energy fed into the local grid. At night, when the solar system is not producing energy, the installation relies on energy from the grid.
- Energy consumption may be in the form of electricity, heat, or direct use of fuel.
- A military installation is taken to be any defined facility, which may be a contiguous area or may comprise separate areas. When assessing the energy of the installation, all activities within the defined boundaries are included regardless of whether their energy is managed by the base energy manager, or paid for by different agencies.
- The task force’s willingness to include energy production “on or near the installation” was left open to interpretation. The assessment team focused primarily on the possibilities of onsite energy production, accepting forms of energy generated onsite from renewable sources and renewable fuel used onsite. The set of onsite renewable energy sources followed standard DOE practice: commercially available solar (photovoltaic,

concentrating solar power, water heating), wind and hydropower systems, and electricity or heat generated from natural gas produced in onsite landfills or by burning the installation's trash or municipal solid waste (waste-to-energy).

- Renewable fuels include various forms of biomass (wood waste, agricultural byproducts); methane produced, for example, from external landfills or as a byproduct of sewage processing; and various renewable transportation fuels (ethanol- E85, biodiesel).
- As employed here, the net zero energy concept does not include non-primary energy imported from offsite (e.g., electricity from a local offsite renewable source), or purchases of renewable energy credits (RECs), that is, getting credit for renewable energy generation somewhere else in the world. This is in keeping with the NZEI concepts' emphasis on meeting energy needs with local resources.
- The task force definition does not explicitly discuss minimizing the installation's load, an essential first step toward net zero energy status. This can be accomplished through personnel actions to conserve energy or reduce energy waste, or by identifying approaches to conserving energy without impacting the mission. This also includes the implementation of standard facility energy efficiency technologies to the extent that is economically feasible. These may include heating, ventilation and air conditioning (HVAC) and lighting upgrades (efficient chillers and boilers, solar ventilation pre-heat, fluorescent or light-emitting diode (LED) lighting); environmental control systems; systems generating both electricity and heat (cogeneration systems) where both forms of energy are needed; and building envelope upgrades or design features such as insulation, high-performance windows, and daylighting.
- Installation energy consumption can be measured several ways. Possible measurement approaches include:
  - **Net Zero Site Energy:** Energy used by the installation is accounted for at the site, for example, as indicated by building electricity and gas meters. This approach is generally straightforward, but omits transmission losses to bring energy to the site.
  - **Net Zero Source Energy:** Source energy refers to the primary energy used to generate and deliver the energy to the site, for example: a local utility generation site and transmission system. For transportation fuel, source energy would include a multiplier to account for the energy required to transport the fuel to the fueling station.
  - **Net Zero Energy Costs:** In this approach, the amount of money the utility pays the installation for renewable energy generated onsite and exported to the grid is compared with the amount the owner pays the utility for energy used over a year.
  - **Net Zero Energy Emissions:** Here the installation aims to produce onsite and use at least as much clean renewable energy as it uses from offsite local energy sources annually, offsetting the offsite emissions. (Torcellini et al<sup>7</sup>)

---

<sup>7</sup> Torcellini et al. (2006), "Zero Energy Buildings (ZEB): A Critical Look at the Definition." Golden, Colorado: National Renewable Energy Laboratory.

Net zero source energy was selected as the basis for energy accounting for this assessment because it is the most representative measure of primary energy consumption.

- Transportation fuel use is included with the following limitations: All transportation fuel consumption data is gathered for the purpose of establishing an installation's total footprint, data permitting. This can include government ground fleet vehicle fuel use, fuel associated with commercial air travel for official business, fuel used in personnel commuting, and tactical fuel use. However, only the government fleet use is further addressed in the NZEI; potential reduction measures include converting to electric vehicles, using electricity generated onsite from renewable sources, or the use of renewable fuels in fleet vehicles.

Since the DOD's capability to significantly affect energy used in commercial air travel and by commuters is limited to minimizing trips, encouraging carpooling or telecommuting (where possible), or providing electric vehicle charging stations as an incentive for employees to consider electric vehicles when these become widely commercially available, these categories are not considered. Tactical fuel requirements are not addressed in the assessment since renewable fuel alternatives are not yet commercially available. DOD can (and does) examine training requirements and opportunities to use simulators instead of real tanks/personnel carriers, aircraft, ships and submarines, and also to explore logistical variations in theater that can also reduce fuel use, but these options are not addressed here.

Again, the NZEI concept can be seen as a useful entry point into an exploration of demand reduction through human action and energy efficiency technology, and meeting remaining energy needs with local renewable energy resources. Some installations will be able to exceed net zero status to become net energy producers, while others won't be able to approach it. In fact, a net zero goal too strictly applied can lead to solutions that make poor sense from economic or other perspectives. Assessment of a site's net zero potential, combined with consideration of the other constraints identified in the preceding section, provides a disciplined basis for identifying an optimal energy strategy tailored to the requirements of each site.

#### **1.4 Assessment Approach**

The approach developed for this assessment includes seven steps, which are briefly summarized here and addressed in detail in the remaining chapters of this report.

- **Establish MCBH Kaneohe Bay Energy Baseline (Section 2):** Identify the installation mission, geographic boundaries, and any special energy requirements (e.g., reliability, performance in emergency situations, etc.). Summarize annual (source) energy used by all identified sources supporting the mission as well as its type and means of distribution. Become familiar with energy projects already planned onsite.
- **Demand Reduction through Human Action (Section 3):** Identify approaches to minimizing wasted energy while maintaining or improving the quality of mission execution.
- **Energy Efficiency Project Assessment and Recommendations (Section 4):** Identify specific onsite energy-efficiency projects and their effect on installation energy demand.

- **Renewable Energy and Additional Load Reduction Projects (Section 5):** Identify projects exploiting onsite renewable energy for electricity and heat production, or employing renewable fuels onsite for electricity production or for fleet transport.
- **Transportation Assessment (Section 6):** Identify projects to reduce and replace fossil fuel use in fleet vehicles.
- **Electrical Assessment (Section 7):** Outline the characteristics of a smart microgrid to support emergency operations in the event of a public grid outage. Identify the impacts of renewable energy projects on the microgrid.
- **Characterize MCBH Kaneohe Bay Net Zero Energy Potential (Section 8):** Bringing together findings from the preceding chapters, calculate the extent to which the installation can approach net zero energy status. Then, with reference to broader installation and mission constraints, recommend a set of energy projects.
- **Outline Implementation Steps (Project Planning and Financial Assessment) (Section 9):** Demonstrate how the recommended projects, in concert with projects already planned by the installation, can be implemented - with attention to timelines and financing alternatives.

## 2 MCBH Kaneohe Bay Energy Baseline

### 2.1 Overview

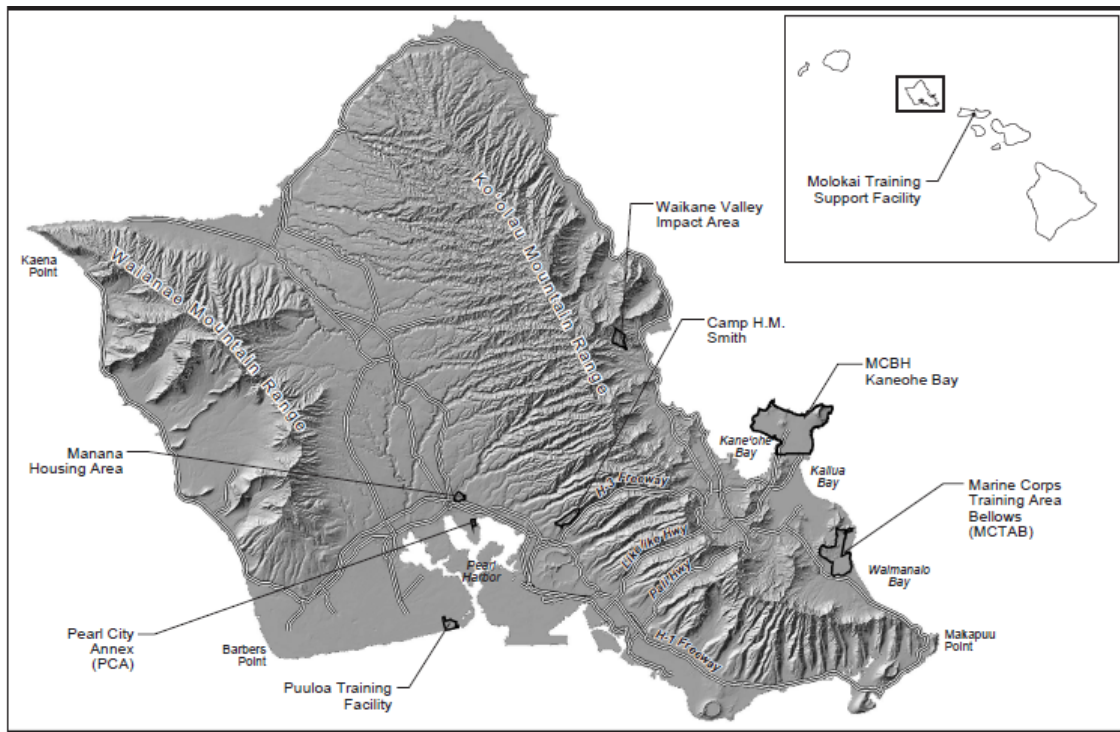
The first step in a net zero energy assessment is to determine an energy baseline. The baseline is used to evaluate net zero energy potential and includes energy use in on-site buildings, facilities, and fleet vehicles. The baseline serves as a reference point against which to measure progress.

### 2.2 Site Description

Marine Corps Base Hawaii (MCBH), Kaneohe Bay is located on the eastern side of Oahu, Hawaii. The MCBH is on the Mokapu Peninsula between Kane’ohe Bay and Kailua Bay. MCBH Kaneohe Bay is separated from the Honolulu area by the Ko’olau Mountain Range. This coastal region is referred to as “windward” Oahu since it is exposed to northeasterly trade winds.

### 2.3 MCBH Kaneohe Bay Boundary

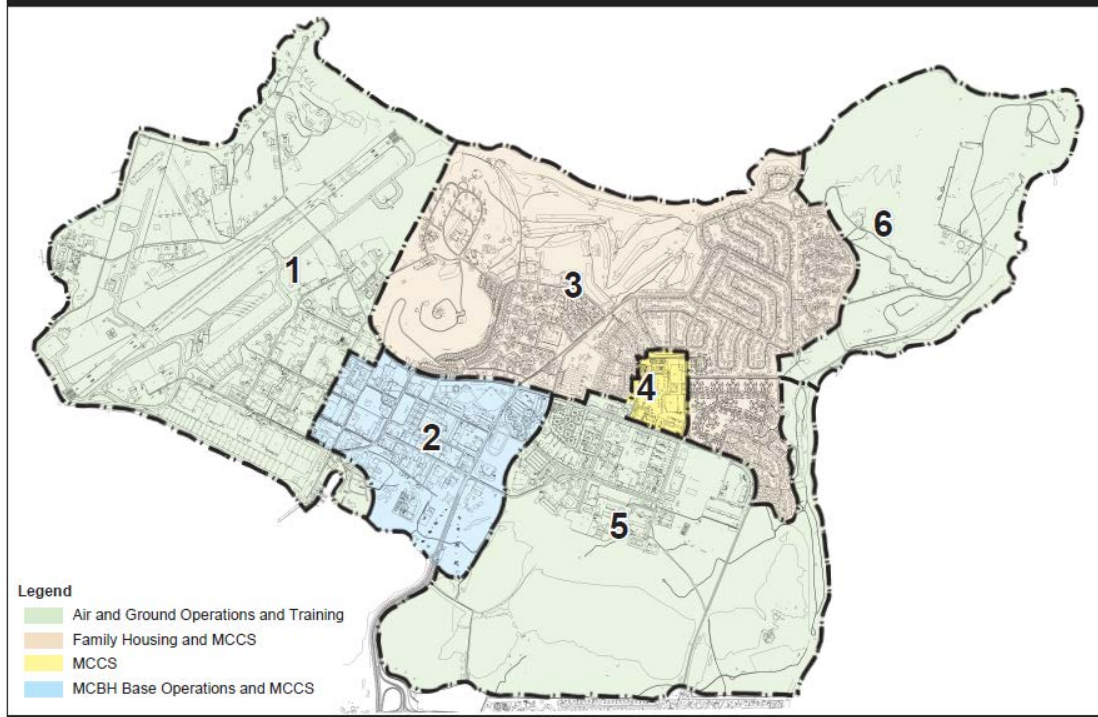
This study will be concentrating on the MCBH Kaneohe Bay only and does not include Camp H.M. Smith, Marine Corp Training Area Bellows, Manana Housing area, or Puuloa Training Facility that are often associated with this installation. Figure 4 and Figure 5 are maps from the MCBH Master Plan 2006 and show the boundary area of MCBH Kaneohe Bay addressed in this study.



**Figure 4. MCBH Properties**

Source: MCBH Master Plan 2006





**Figure 5. Land use zones**

Source: MCBH Master Plan 2006

## 2.4 Total Consumption Breakdown

Working with MCBH Kaneohe Bay, NREL determined an energy boundary for the MCBH Kaneohe Bay baseline that includes all on-site buildings and facilities, and fleet vehicles. An energy baseline provides an analysis of current energy consumption on base, as well as a metric against which to measure progress. Baseline energy consumption for MCBH Kaneohe Bay is shown below.

**Table 4. MCBH – Kaneohe Bay Energy Baseline**

<i>Baseline Annual Energy Usage Information 2009</i>				
Energy Use		units	Site MMBtu	Source MMBtu
Electricity	107,088,800	kWh	365,387	1,432,317
Propane	18,890	MMBtu	18,890	21,724
Gasoline	181,802	Gallons	20,744	23,855
Diesel	93,967	Gallons	13,860	15,939
<b>Total Energy Use</b>			<b>418,881</b>	<b>1,493,835</b>

The total site Btu's are 418,881 Million British thermal units (MMBtu). These site Btu values were converted into source Btu utilizing conversion factors developed by NREL (3.92 source Btu/site Btu for electricity and 1.15 source Btu/site Btu fuel). The total source Btu is 1,493,835 MMBtu. 95.88% of the source Btu's are from electricity and 4.12% are from fuels.

Many people are familiar with site Btu or site energy, which is the amount of fuel and electricity consumed and reflected in utility bills. However, energy may be delivered to a facility as either primary or secondary energy. Primary energy is raw fuel that is burned onsite to create heat or electricity. Secondary energy is the product of the combustion of the raw fuel as thermal energy or electricity. It is not possible to directly compare primary and secondary energy because the former is a raw fuel and the latter is a product of combustion of the raw fuel. Utilizing source energy as the common metric for analysis, as is done for this assessment, permits comparison of the two energy types, and also better supports assessment of DOD goals for fossil fuel reduction and renewable energy generation. A source Btu analysis allows for the accounting of the energy required to transport fuel to the base and the energy losses due to inefficiencies in the electrical generation process. For raw fuels, the difference between site and source energy is minimal and accounts for fuel distribution and dispensing but not fuel production. For example, diesel fuel losses for fuel transport, storage, and dispensing are accounted for, but energy used in extracting crude oil and refining it into diesel fuel is not accounted for. The same basic analysis applies for electricity: losses in producing the fuel to be combusted for electrical energy production are not accounted for. However, the losses in the conversion of a primary chemical fuel, such as coal, to a secondary fuel, such as electricity, are accounted for.

The calculation of a conversion factor to translate between site and source Btu for a specific installation can be difficult. The exact ratio will depend on many factors such as the location of the installation, the efficiency of the energy distribution system, and the location from which the installation's energy is sourced. For example, the electrical energy conversion factor will depend on the specific power plant from which an installation receives its energy, its efficiency, and the proximity to the installation. Analyzing a site-to-source conversion in this manner will penalize or credit an installation based on the relative performance of its electrical energy source. However, it would be unfair and impractical to trace installation energy use down to the level of a specific power plant. Additionally, location is a factor outside the control of an installation. For this analysis a Hawaii specific electrical site-to-source ratio and national ratios for propane were utilized.

## **2.5 The Electrical Baseline**

### ***Grid Connection***

We obtained MCBH Kaneohe Bay's load profile from 15-minute metered data from the Hawaiian Electric Company (HECO) website databases for 2009. We also received monthly utility consumption. Figure 6 shows the typical day load and Figure 7 depicts the annual load profile. The daily-load profile shows electricity use peaks around noon and tapers off around 7:00 pm. The annual load profile shows an annual peak load of 18 megawatts (MW) that occurred in August and October.

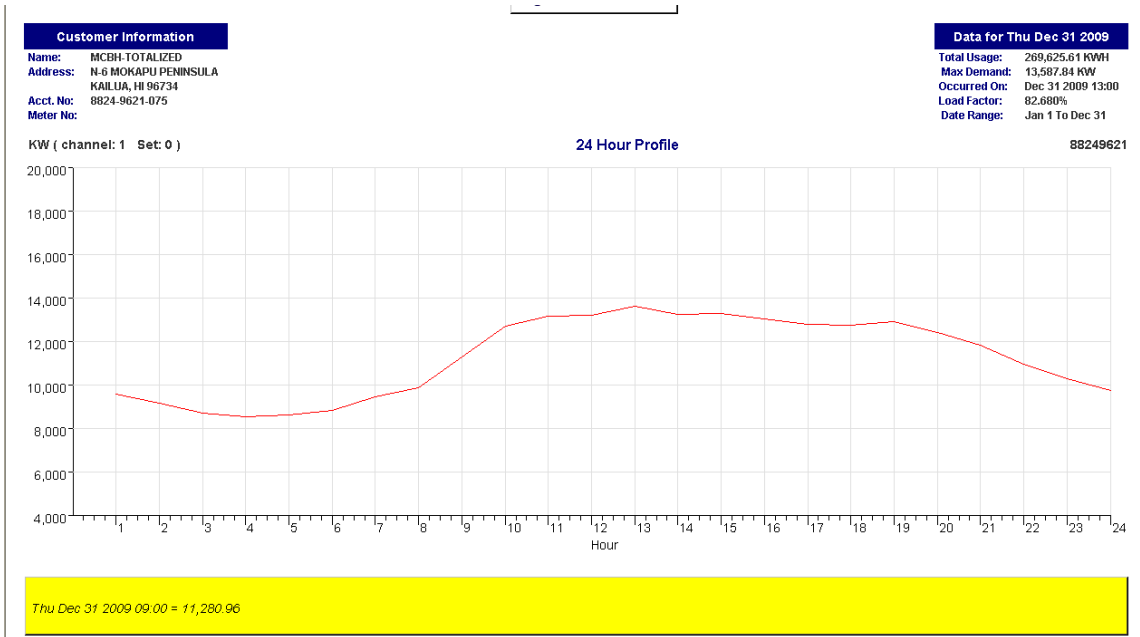


Figure 6: Typical daily load profile

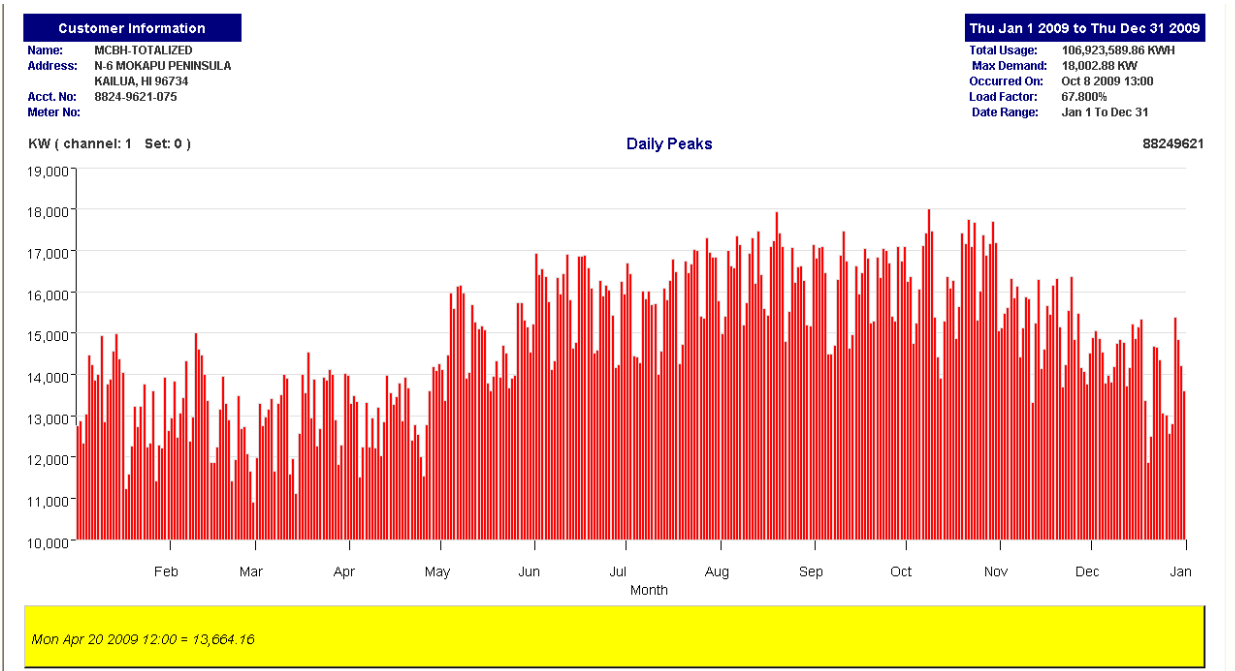


Figure 7: Annual load profile

## 2.6 Propane Baseline

Propane use at MCBH Kaneohe Bay was provided to NREL for FY09. This data was utilized to establish the annual propane baseline of 206,900 gallons which is equivalent to 18,890 MMBTU. Propane is used for hot water at MCBH Kaneohe Bay. This includes barracks boiler plants, officers club, laundry, gym, and clinics.

## 2.7 Transportation Baseline

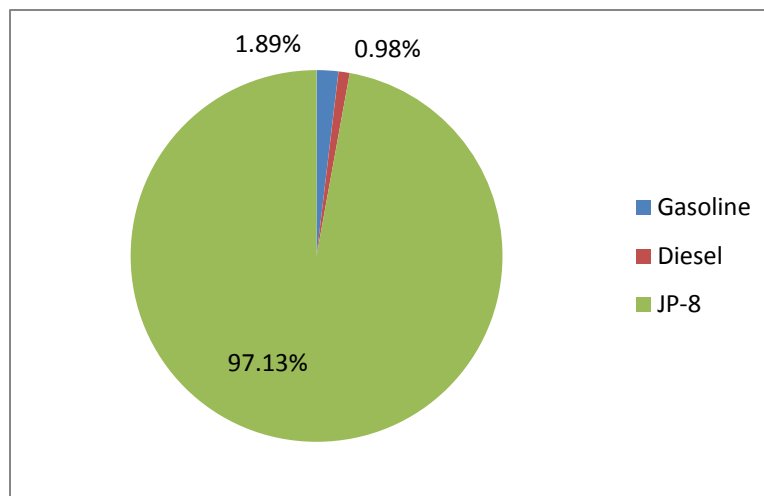
NREL personnel visited MCBH Kaneohe Bay in early 2010 and in March 2011, and were able to obtain basic information about their total fuel consumption at MCBH Kaneohe Bay. MCBH Kaneohe Bay provided tactical jet fuel (JP-8), gasoline, and diesel fuel use data for 2009. The breakdown of fuel use by gallon is shown below.

**Table 5. Fuel Use Annual Baseline**

<i>Baseline Annual Fuel Usage Information</i>	
Total Gasoline (gallons)	181,802
Total Diesel (gallons)	93,967
Total JP-8 (gallons)	9,335,777

JP-8 is exclusively used for tactical use and is the majority of the fuel consumed, thus tactical use accounts for the bulk of the transportation related baseline as shown in Figure 8.

The amounts of fuel used for tactical operations are outside of the control of the installation energy managers. Although there are opportunities for future analysis in examining the potential to reduce the use of fuel in training operations, this project did not include this use.



**Figure 8. Fuel use at MCBH Kaneohe Bay 2009**

MCBH Kaneohe Bay is well on their way to transforming the way their fleet is fueled. In 2011, both E85 and B20 fueling stations were installed. Existing flex-fuel vehicles are fueled with E85 and the large diesel vehicles are fueled with B20. MCBH Kaneohe Bay is transferring to electric

and hydrogen fleet by 2020. Hydrogen will be generated on base with electrolysis equipment that is being installed this year.

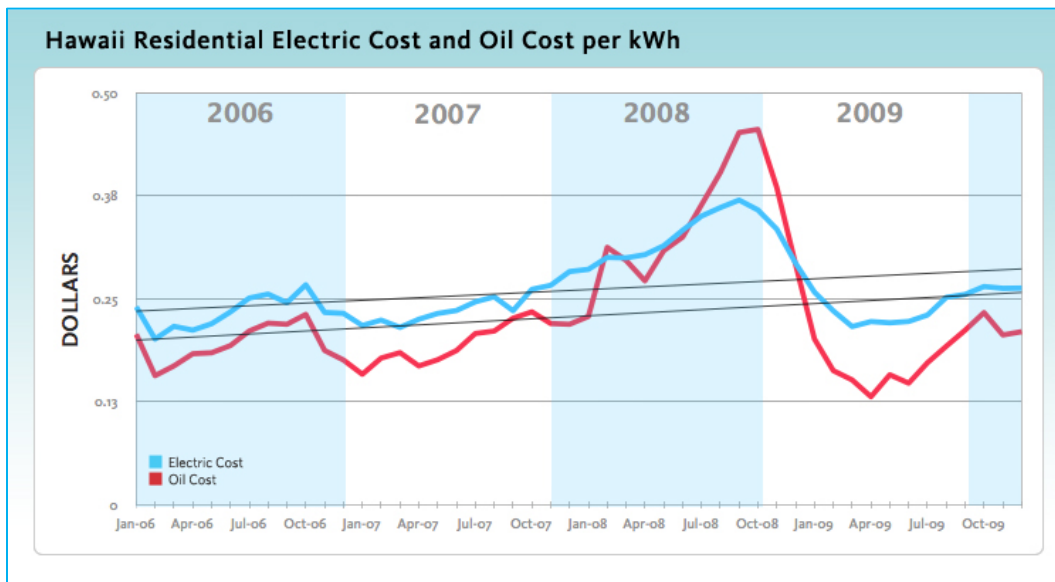
## 2.8 Utility Costs

The current cost of energy is one important factor in determining the economic viability of investments in energy efficiency or renewable energy. MCBH Kaneohe Bay’s electrical energy is provided by the Hawaii Electric Company (HECO) to the main base substation. The base owns, operates, and maintains the distribution network beyond the substation.

The cost of electricity averaged for the whole year at MCBH is summarized below:

- 2007: \$0.17/kilowatt-hour (kWh) (unit cost + demand)
- 2008: \$0.26/kWh (unit cost + demand)
- 2009: \$ 0.16/kWh (unit cost + demand)

Energy at MCBH Kaneohe Bay has been quite volatile over the last several years. The volatility in the rate is largely due to the fact that the majority of energy production on the island is from diesel fuel, which is derived from crude oil. The cost of electricity tracks and follows the cost of oil, which is a volatile commodity. The price of oil versus the cost per kWh for Hawaii over the last few years is shown in the figure below.



**Figure 9. Hawaii Electric Cost versus the Price of Oil<sup>7</sup>**

The range in electrical costs each month for 2009 was from \$0.164-0.23/kWh. NREL spoke with MCBH Kaneohe Bay and agreed to use \$0.20/kWh in this analysis.

The total cost for propane at MCBH Kaneohe Bay in FY09 was about \$427,272. The cost per gallon of propane was approximately \$2.00.

<sup>7</sup> Hawaii Energy. <http://www.hawaiienergy.com/10/hawaii-residential-electric-cost-and-oil-cost-per-kwh> Accessed September, 2010.

### 3 Reducing Energy Demand by Engaging People

Having established baseline energy use, analysts turned to the task of identifying the most economic ways to reduce the installation's energy demand. There are two main approaches: 1) identifying actions to reduce energy use without the need for capital expenditures, and 2) implementing energy-efficient technologies and design strategies. Identifying opportunities for procedural, behavioral, process, or operational energy-saving actions relies on engaging the attention and creativity of personnel, especially those with experience at the installation. Implementing energy-efficient technologies and design strategies is largely a technical exercise, which the next section will address.

Security, economic, and environmental objectives support a DOD-wide—and national—transition to clean energy that may be viewed, in part, as a culture change, requiring individual awareness of energy costs, new habits of energy use, and continuing creative attention to ways of reducing energy demand. There is no silver bullet or purely technological solution to our present energy challenges: even with the adoption of energy efficient technologies, there is a tendency for energy demand to increase with growing populations and the arrival of new generations of energy-using devices. In conjunction with an NZEI analysis, DOD leaders should institutionalize ways of engaging peoples' ingenuity to reduce energy demand. It should be emphasized by the superiors/management that wasting energy goes against the values and goals of the DOD's mission and therefore all personnel should be required to conserve. This assessment does not attempt to quantify energy reductions due to behavior changes; however, the outline of a recommended approach follows.

- **Assess potential demand reduction:** Estimate potential energy demand reductions from personnel actions, changes to processes, improvements to mission execution, and other sources (provide estimates in energy units and dollars). Create dedicated teams in functional areas across the installation's operations to identify actions to permanently minimize energy use. Suggested actions should have a neutral effect on mission performance, or improve it. Consider energy use in facilities (lighting intensity, heating or air conditioning set points, and hours of operation), transport (vehicle miles, need for travel versus teleconferencing or videoconferencing), and mission uses (required hours of use of aircraft/ships/subs/ground vehicles for training and operations).
- **Continuous improvement:** Beyond the net zero energy assessment, MCBH Kaneohe Bay can engage peoples' ingenuity in saving energy on a continuing basis:
  - **Institute an "Energy Awareness" campaign:** Establish attention to energy use as a normal part of all activity, including planning, training, and mission execution.
  - **Create competitions/contests/incentives for new ideas, or for reduced energy use:** Make it a point of pride to help increase national energy independence through reducing dependence on energy from imported and/or "dirty" sources.

- **Create leadership/personnel teams to continue developing ways to save energy:** Leading by example is a powerful influence across officer, enlisted, government civilian, and contractor elements of the military team.
- **Implement energy scoreboards:** The scoreboards would assess energy usage by individuals, buildings, or organizations and recognize best performers and practices.

The Federal Energy Management Program has published several guides on how to conduct an energy awareness campaign:

**Creating an Energy Awareness Program**

[http://www1.eere.energy.gov/femp/pdfs/yhtp\\_ceap\\_hndbk.pdf](http://www1.eere.energy.gov/femp/pdfs/yhtp_ceap_hndbk.pdf)

*Handbook from the Federal Energy Management Program on how to create an energy awareness program and campaign.*

**Promoting Behavior Based Energy Efficiency in Military Housing**

[http://www1.eere.energy.gov/femp/pdfs/military\\_hndbk.pdf](http://www1.eere.energy.gov/femp/pdfs/military_hndbk.pdf)

*Handbook from the Federal Energy Management Program on promoting energy efficiency in military housing.*

**Energy Managers Handbook**

<http://www.wbdg.org/ccb/DOD/DOD4/DODemhb.pdf>

*Department of Defense Handbook for energy managers that provides tools to help facility and installation energy managers perform their jobs more effectively by answering questions and illustrating best practices.*

## 4 Energy Efficiency Assessment

### 4.1 Overview

Energy efficiency is typically the most cost effective energy project investment. Prior to conducting further analysis of the renewable energy generation technologies, the potential for energy efficiency improvement potential should be evaluated. Energy efficiency and conservation analysis were conducted first as they will reduce the electrical and propane fuel loads at the base and decrease the sizes of the renewable energy systems required.

MCBH Kaneohe Bay has several projects already planned to increase the efficiency of its building portfolio. The NREL team was not able to include all of these measures in the analysis of efficiency improvement potential for the base. The savings outlined in this report reflect the energy efficiency measures that were identified at the time of the site visit.

The energy efficiency measures proposed below were done on a high level with very general base information. These calculations should not be considered investment grade calculations, and should not be used for determining the economics of a potential investment. The recommendations should only be used for planning, and for the purpose of identifying energy conservation measures (ECMs) for further investigation.

### 4.2 Summary of Proposed Energy Efficiency Projects

It was beyond the scope of this project to conduct detailed energy audits of the approximately 163 installation facilities at MCBH Kaneohe Bay. However, through discussion with base personnel, and a walk-through of several of the facilities on base the savings potential for energy efficiency at MCBH Kaneohe Bay was estimated by auditing a few representative buildings.

- Total electrical reduction = 18,233 megawatt-hours (MWh) or 62,221 MMBtu (17.03% electrical load reduction)
- Total propane reduction = 1,251 MMBtu (6.62% propane load reduction)
- Total reduction = 63,462 MMBtu (16.5% total reduction)

The savings estimates are shown in Table 6 below:

**Table 6. Project Savings Summary**

<i>Measure</i>	<i>Savings (% of fuel type)</i>		<i>MMBtu Equivalent Savings</i>	<i>% Total Site Savings</i>
<b>Specific Base Facilities</b>				
Commissary (32% reduction)	MWh	1,401 2.4%	4,780	2.1%
Barracks (40% reduction)	MWh	7,497 12.8%	25,587	11.4%
Offices (43% reduction)	MWh	3,215 5.5%	10,972	4.9%
Gym (52% reduction)	MWh	467 0.8%	1,593	0.7%
Mess Hall (40% reduction)	MWh	1,310 2.2%	4,470	2.0%
<b>Base Wide ECMs</b>				
Retro-commissioning	MWh	2,023 3.5%	6,904	3.1%
Lighting Occupancy Sensors	MWh	935 1.6%	3,190	1.4%
Computer Energy Mgmt	MWh	1,387 2.4%	4,732	2.1%
Water Heater Boilers	MMBtu	1,251 4.8%	1,251	0.6%



<i>Measure</i>	<i>Savings (% of fuel type)</i>		<i>MMBtu Equivalent Savings</i>	<i>% Total Site Savings</i>	
	<b>Total</b>				
Electricity	MWh	18,233	17.03%	62,211	15.9%
Propane	MMBtu	1,251	6.62%	1,251	0.6%
			<b>Total</b>	<b>63,462</b>	<b>16.5%</b>
			<b>MMBtu</b>		

### 4.3 Base Wide Conservation Measures

Numerous recommendations were developed to reduce energy usage across all base facilities.

#### **Central Energy Plants**

The majority of the cooling systems on the base were distributed single building systems. There were only a couple of places on the base where there were central energy plants. The exchange and the food courts were on a large water cooled chiller that was recently brought on line. According to the onsite staff, the plant was designed with the intention of expanding the capacity to the commissary and a few other surrounding buildings. The site is encouraged to pursue this opportunity, and expand the central cooling plant. The commissary currently cools water using relatively old air cooled chillers, and could greatly reduce the amount of energy required to cool the facility by switching over to the central plant. The commissary is currently the largest energy user on the base, and has a large potential for improvement.

The other locations that utilize central cooling plants are the barracks. It was observed during the site visit that several of the barracks buildings share air cooled chillers. These central chillers should be replaced with water cooled chillers. The replacement chillers should specify a coefficient of performance (COP) of six or higher.

Further on-site studies would be necessary to confirm current operation and feasibility of implementation.

#### **HVAC - Chillers**

Many of the facilities at MCBH Kaneohe Bay are operating moderately efficient chillers. There is a mix of water cooled, and air cooled chillers on the base. Water cooled chillers are much more efficient than air cooled chillers, and the high price of electricity at MCBH Kaneohe Bay would allow a very quick return on investment for high efficiency chillers. It is recommended that all chillers over 75 tons be replaced with water cooled chillers. Because of the corrosive environment at MCBH Kaneohe Bay, air cooled chillers are typically replaced every 5 years. Most water cooled chillers are located indoors as opposed to the air cooled chillers which are often kept outdoors. This reduced exposure to the caustic environment would extend the life of the equipment. The cooling tower of the water cooled chiller would still be exposed to the elements, but cooling towers are much less expensive to replace than chillers. It is recommended that all facilities be analyzed for high efficiency chiller upgrades as it is likely significant savings potential exists across the base.

### *HVAC - Air Handling Units*

There is a mix of constant volume (CV) and variable air volume (VAV) air delivery systems at MCBH Kaneohe Bay. According to the onsite staff, all new construction uses VAV systems, but all of the old construction has CV systems. Upgrading the remaining units to VAV systems would save energy by reducing the amount of air that would need to be cooled. It is recommended that the AHU across the base be evaluated and upgraded to VAV models where appropriate.

### *Water Heating*

The efficiency of the domestic hot water boilers at MCBH Kaneohe Bay varies; some of the boilers are old and inefficient while others are new. A substantial amount of energy could be saved by replacing all of the old inefficient boilers with new high efficiency boilers. It was observed that there were several chillers equipped with heat recovery units. This type of system can save large amounts of energy, so these should be implemented wherever possible to offset hot water loads on the boilers. Boilers with efficiencies less than 85% should be examined for replacement potential with high efficiency boilers that can reach up to 95% efficiency. Factors to be considered include expected time to replacement of existing as well as required supply and return water temperatures. Note that 95% efficiency is available with condensing boilers, but they require low return water temperatures that are not applicable for all applications. The estimated energy savings for high efficiency boilers is 1,251 MMBtu.

### *Energy Star Refrigerators*

Energy savings could be realized by replacing refrigerators on the main base with energy star models. It is assumed that small refrigerators are located in each of the barracks units and it was assumed that the office buildings contained them as well. Savings would vary by the model being replaced but would be 50-200 kWh per year for each fridge.

### *Controls*

According to the onsite staff, 70 of the 163 buildings on the base have direct digital controls (DDC) and are connected to the central control system. It is unknown whether the remaining buildings are scheduled to be added to the DDC system or not. All of the buildings that have HVAC systems should be added to the central DDC system. This will allow the implementation of base wide set points, night time setbacks, and will allow optimization of the system operation that would not otherwise be possible. A central DDC system could potentially save a significant amount of energy. The base requires numerous control system upgrades (i.e. replace pneumatic system) and building retro commissioning. Some of the potential control upgrades include:

- Chiller optimization (chilled water reset and sequencing)
- Cooling tower optimization (recommendation to only run as many fans as needed to meet condenser water set point)
- DDC controls
- Electric demand limiting
- Static pressure set point adjustment
- Mixed air dampers – for economizer

- Night setback
- Night purge (night-pre cooling of bldg)
- Occupancy sensor control
- Lighting scheduling (centralized lighting control)
- Optimal start/stop HVAC systems
- Outdoor air reduction
- Supply air reset
- VAV and variable pumping.

### ***Retro commissioning of all mechanical systems***

The entire base should be retro commissioned building by building. Retro commissioning involves going through all of the mechanical systems of a building, verifying operation, and optimizing all functions. Retro commissioning can resolve operating problems, improve occupant comfort, and reduce energy use. During retro commissioning, the systems are not replaced with more efficient components; instead, the existing systems are given a tune-up. The American Council for an Energy Efficient Economy estimated that retro commissioning could save 5-20% of building energy consumption.<sup>8</sup> The estimated energy savings for retro commissioning is 2,023 MWh per year.

### ***Plug Loads***

The NREL team utilized its screening tools to estimate the potential for plug load reduction at MCBH Kaneohe Bay. Currently, there is no computer power management program in place. One of the largest energy users in an office setting is computers. By implementing a computer program management program, the computers can be put in an energy saving mode when not in use. This can save a significant amount of energy. Savings were estimated for utilizing power management software on 3,000 desktop computers. The estimated energy savings for plug load reduction is 1,387 MWh per year.

### ***Occupancy Sensors***

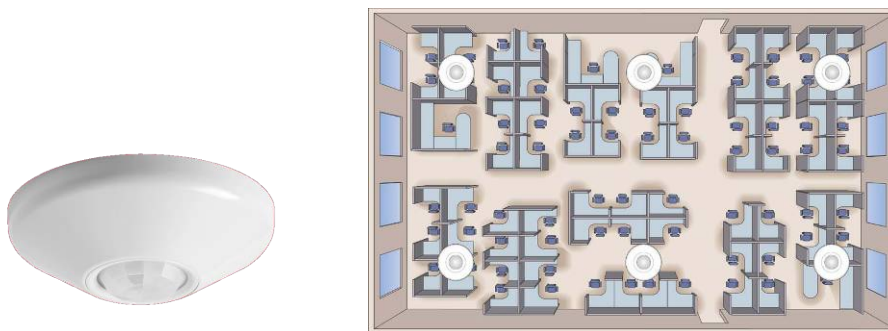
There are few working occupancy sensors currently installed in the office buildings at MCBH Kaneohe Bay. Occupancy sensors can save energy by turning off lights when spaces are unoccupied. Large cubicle workstation areas, conference rooms, private offices, and restrooms comprise the majority of the lighting load in a typical office building. It is likely that many of these areas are intermittently occupied or vacant throughout the course of the day, and energy savings could be realized by installing occupancy sensors.

---

<sup>8</sup> “Retrocommissioning Program Strategies to Capture Energy Savings in Existing Buildings”. Jennifer Thorne and Steven Nadel. American Council for an Energy Efficient Economy. June 2003.  
<http://www.aceee.org/pubs/a035full.pdf>



**Figure 10. Typical 'small office' wall switch sensor application and coverage**



**Figure 11. Typical 'open space' ceiling mounted sensor application and coverage**

It is recommended that MCBH Kaneohe Bay install ceiling-mounted, infrared occupancy sensors to automatically activate and deactivate space lighting circuits based on occupancy. This measure will not reduce peak demand but will reduce annual energy consumption. The estimated energy savings for infrared occupancy sensors is 935 MWh per year.

The analysis of building specific energy efficiency measures can be found in Appendix B.

#### **4.4 Privatized Housing**

At the time of the assessment the NREL team was unable to conduct an analysis of the residential energy efficiency potential at MCBH Kaneohe Bay.

However, there are some ECMs that are typical to most residential housing developments. The following ECMs were not identified at the site, but could potentially be applicable:

- Install programmable thermostats to save on cooling
- Install low flow faucets, shower heads and toilets
- Decrease ventilation levels
- Use seasonal natural ventilation
- Add insulation to the walls and attic

- Replace existing windows with high performance low-e windows
- Use interior shading to reduce cooling loads
- Replace all lighting with florescent technology
- Replace current domestic hot water heaters with high efficiency water heaters
- Switch out any appliances that aren't currently Energy Star
- Encourage residents to save energy with energy awareness campaigns and incentives
- Reduce irrigation use
- Turn off the power and gas to unoccupied homes to eliminate standby losses.

## 5 Additional Load Reduction and Renewable Energy Projects

### 5.1 Overview

After reducing the energy use through conservation measures, the remaining energy needs of an NZEI are met through renewable energy. In addition to the basic resource assessment, the NREL team conducted an initial assessment of the renewable energy opportunities for MCBH Kaneohe Bay based on high-level energy data provided by MCBH Kaneohe Bay and the Navy staff, using resource potential and NREL's Renewable Energy Optimization (REO) software tool. The initial screening evaluated the following technologies:

Further load reduction:

- Daylighting
- Solar hot water
- Geothermal/Ground source heat pump

Renewable energy generation projects:

- PV
- Wind energy
- Solar thermal or CSP
- Biomass gasification CoGen/Boiler
- Anaerobic digesters

### 5.2 Renewable Energy Resource Assessment

NREL began its analysis of the renewable energy generation potential of MCBH Kaneohe Bay by examining the high-level resource and project potential. The analysis includes MCBH Kaneohe Bay's specific solar and wind resource maps, Appendix A. The renewable energy resource maps were provided by the NREL geographic information system (GIS) group. Overall, the resource maps indicate good solar and wind resource potential, moderate geothermal potential, and poor biomass potential.

Also included in Appendix A, are maps of biological sensitive land areas and flood zones. The environmental maps were obtained from the MCBH Master Plan for MCBH Kaneohe Bay 2006. These maps help in determining potential areas for implementing renewable energy projects.

#### **Solar**

The solar resource map for PV indicates that all of MCBH Kaneohe Bay falls in the 5.75 – 6.00 kWh/m<sup>2</sup>/day category, which indicates a good resource. The direct-normal solar resource is also significant at 5.50 – 6.00 kWh/m<sup>2</sup>/day. Direct-normal radiation excludes scattered light that results from humidity and atmospheric particles. It is a measure of only the direct, or shadow-

casting, sun rays. High direct-normal radiation levels are good for systems that focus or concentrate the sun's rays on central collector or pipe.

### **Wind**

The wind resource is good (class 4-5, see wind resource map in Appendix A), and NREL has wind-speed data that was monitored over a year-long period (August 1, 2009-July 31, 2010). More detailed information is available in the “Kaneohe, Hawaii Wind Resource Report.”

### **Geothermal/Ground Source Heat Pump**

Information on the direct geothermal resource at MCBH Kaneohe Bay was not available. The national version of the geothermal resource map indicates moderate geothermal project potential at the site. During the site visit to MCBH Kaneohe Bay base personnel stated that the area had problems with ground shift and ground source heat pumps would likely not be possible. Since the industry is not fully developed and project costs for retrofits are higher than new buildings, NREL did not consider this technology.

### **Biomass**

The biomass resource on the island of Oahu, particularly in the vicinity of MCBH Kaneohe Bay, is not sufficient to support the development of a large scale biomass energy project.

Presently MCBH Kaneohe Bay has a 35,800 ft<sup>3</sup> anaerobic digester that is not currently in use. The anaerobic digester is located at the waste water treatment facility. To achieve the net zero energy solution NREL included the existing digester in the analysis.

## **5.3 Renewable Energy Optimization**

Following our analysis of renewable energy resources, we used NREL's REO tool to estimate the sizes of each technology required to achieve net zero. REO suggested the following technology sizes in Table 7 below:

**Table 7. Overall Summary from REO**

Considered Technology		Total Capacity	Central Plant Capacity	Building-level Projects	Initial Investment	Annual Savings
					\$	\$/year
				Quantity		
Photovoltaics	kW	8,509	8,509	0	\$ 57,201,071	\$ 2,358,340
Wind Energy	kW	43,890	43,890	0	\$ 104,193,884	\$ 898,304
Solar Ventilation Air Preheat	ft <sup>2</sup>	0	-	0	\$ -	\$ -
Solar Water Heating	ft <sup>2</sup>	257,509	-	130	\$ 31,536,377	\$ 97,031
Solar Thermal Parabolic Trough	ft <sup>2</sup>	0	0	-	\$ -	\$ -
Thermal Storage	therms	0	0	-	\$ -	\$ -
Solar Thermal Electric	kW	0	0	-	\$ -	\$ -
Biomass Gasification Boiler	MBH	0	0	-	\$ -	\$ -
Biomass Gasification Cogen	MBH	0	0	-	\$ -	\$ -
Biomass Anaerobic Digester	ft <sup>3</sup>	35,800	35,800	-	\$ 0	\$ 203,365
Biomass Anaerobic Digester Cogen	ft <sup>3</sup>	116	116	-	\$ -	\$ 203,365
Skylight Area	ft <sup>2</sup>	99,140	-	78	\$ 4,320,360	\$ 377,745

Considered Technology		Total Capacity	Central Plant Capacity	Building-level Projects	Initial Investment	Annual Savings
Ground Source Heat Pump	tons	0	-	0	\$ -	\$ -
<b>Total</b>		<b>444,964</b>	<b>88,315</b>	<b>208</b>	<b>\$ 197,430,691</b>	<b>\$ 4,138,150</b>

Several technologies were eliminated from further analysis based on the resource assessment, REO screen, and discussions with MCBH Kaneohe Bay. Technologies eliminated from additional analysis are, Solar thermal CSP, biomass, and geothermal/ground source heat pump. Technologies to be considered further are: solar hot water, daylighting, PV, small CSP (dish), wind turbines, fuel cells, existing anaerobic digester, and existing hydro (wave energy).

#### 5.4 Solar Hot Water

The NREL team evaluated the feasibility of installing solar water heating systems on 28 of the buildings at MCBH Kaneohe Bay. The system utilizes an insulated flat-plate collector that preheats water before entering the existing water heater, thus reducing the amount of fuel that must be used to heat the water. The system would utilize a preheat tank to store the heat, and a pump to circulate the water. The proposed system was designed to provide a solar fraction of approximately 60%, meaning 60% of the total water heating load is provided by solar energy.

Figure 12 shows a schematic of how the system should be laid out. The tank labeled “aux tank”, meaning ‘auxiliary tank’, would be the existing water heater. Water is pumped through this system when the controller detects that the solar collector is hotter than the preheat tank.

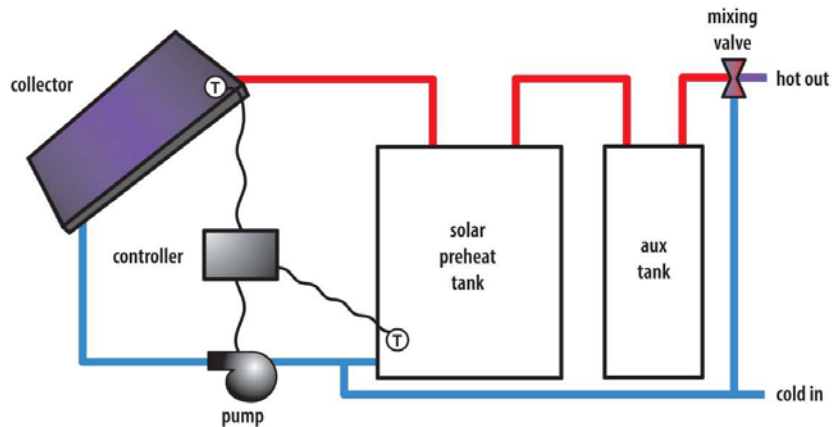


Figure 12. Direct SHW system

If the water from the solar preheat tank is not sufficiently heated, the existing water heater compensates accordingly. If no solar heat is available, the existing water heater has the capacity to meet all the water heating needs of the building as it did prior to installation of a solar system, and the controller will not cycle the pump on. When there is solar energy being collected, the solar preheat tank will provide water to the existing water heater that is above the temperature of the water coming from the water mains. By heating the tank in this way, the fuel or electricity consumed by the existing water heater is reduced.



The most common area to mount a solar water heating system is on the rooftop of a building. For any building that may be replaced or removed in the next 25 years, the site should consider a ground mounted system.

**Solar Collector Parameters:**

The solar hot water system was modeled as a selective surface flat plate collector system. The slope of the panel collector was set at 21° (Latitude), while the azimuth angle of the collector was set at 0° (due South).

**Savings Estimates:**

All of the system calculations were done using the REO tool. The tool calculated system size and energy production. The system production along with the economics for the entire base can be seen in Table 8 below.

**Table 8. Total Solar Hot Water**

Solar Water Heating Area (ft <sup>2</sup> )	Solar Water Heating Heat Delivery (MMBtu/year)	Solar Water Heating Initial Cost (\$)	Solar Water Heating Energy Savings (MMBtu/year)	Solar Water Heating Annual Utility Cost Savings (\$/year)	Payback Period (years)
257,509	9,589	\$31,536,377	11,239	\$254,713	14

The energy savings reported are based on 2009 utility data. The energy savings have the potential to fluctuate depending on facility usage and troop occupancy rates. The SHW analysis assumed that other energy efficiency measures analyzed in this report were installed. However the water flow reduction technologies and some energy efficiency technologies will likely be more cost effective than a SHW system.

**5.5 Daylighting**

**Technology Overview Daylighting**

A complete daylighting system consists of apertures (skylights), to admit and distribute solar light, and a controller to modulate artificial light in order to achieve energy cost savings. Daylighting requires no scheduled maintenance, although skylights may add to roof maintenance. Daylighting is screened by using a site’s solar luminance values (from our GIS resource database) to determine the optimum amount of skylight area (as a percentage of total roof area). We balance savings from reduced electric light usage against the cost of installing a daylighting system and the expense of heat loss through the skylights.



**Figure 13. Daylighting applicable to the MCBH Kaneohe Bay site**

Source: FEMP Booklet, NREL/BK-71-25807.

**Planned Projects**

Skylights have been installed in some of the buildings at MCBH Kaneohe Bay, so a detailed assessment of the office building and warehouses would need to be done. NREL’s analysis did not include housing, but focused primarily on warehouse and office buildings.

**Economic Analysis**

All of the system calculations were done using the REO tool. The tool calculated system size and energy production. The system production along with the economics for the entire base can be seen in Table 8 below.

**Table 9. Total Daylighting Savings**

<i>Non-Office Skylight Area (ft<sup>2</sup>)</i>	<i>Office Skylight Area (ft<sup>2</sup>)</i>	<i>Annual Electric Savings (kWh/year)</i>	<i>Daylighting Capital Cost (\$)</i>	<i>Daylighting Annual Cost Savings (\$/year)</i>	<i>Daylighting Payback Period (years)</i>
99,123	0	2,092,540	\$4,320,360	\$377,745	11.4

**Recommendations**

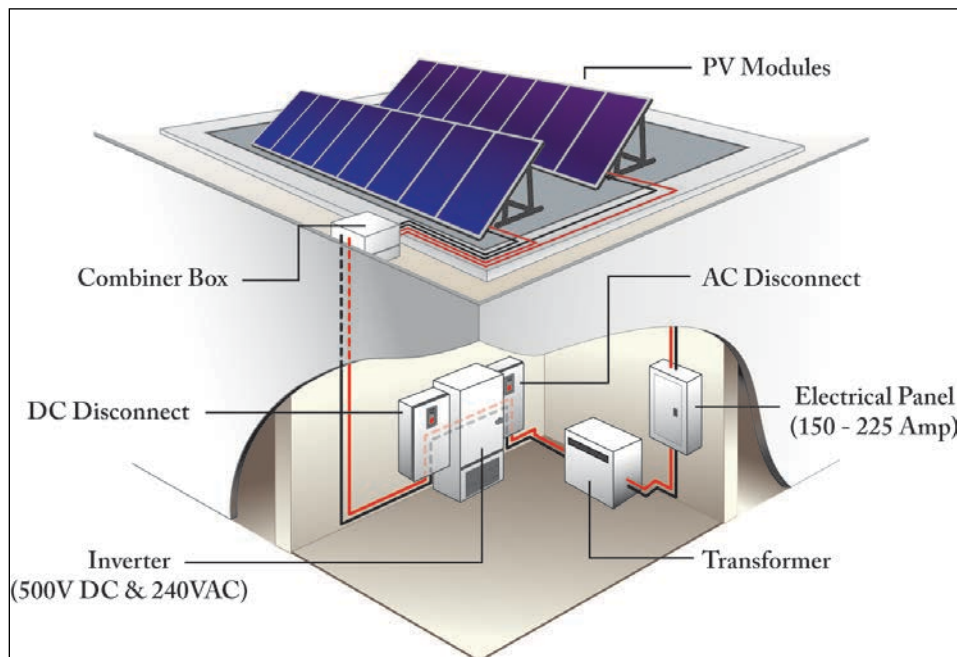
The analysis for daylighting only considered warehouse type buildings and offices. We did not include housing. NREL generally does not recommend retrofitting daylighting in most existing buildings as it is not cost-effective. There are retrofitting opportunities in warehouse-type buildings because roofs are often metal and uninsulated. Daylighting, however, can be

incorporated at no additional cost in the design stage of a building, so we recommend that all new construction at MCBH Kaneohe Bay incorporate daylighting strategies.

## 5.6 Photovoltaic *Technology Overview PV*

Photovoltaics (PV) are semiconductor devices that convert sunlight into electricity. They do so without any moving parts and without generating any noise or pollution. They must be mounted in an unshaded location: rooftops, carports and ground-mounted arrays are common mounting locations. They are very reliable and last 20 years or longer.

The amount of energy produced by a panel depends on the efficiency. This depends on the type of collector, the tilt and azimuth of the collector, the temperature and the level of sunlight. An inverter is required to convert the direct current (DC) to alternating current (AC) of the desired voltage compatible with building and utility power systems. The balance of the system consists of conductors/conduit, switches, disconnects, and fuses. Grid-connected PV systems feed power into the facility's electrical system and do not include batteries. Figure 14 shows the major components of a grid-connected PV system and illustrates how these components are interconnected in a grid-connected PV system.



**Figure 14. Depiction of major components of grid-connected PV system**

Source: Jim Leyshon (NREL)

PV systems can be sized to meet almost any load since they are modular systems consisting of strings of interconnected panels. The cost-effectiveness of grid-connected PV systems depends largely on the solar resource and the incentives offered.

### **Planned PV Projects**

MCBH Kaneohe Bay provided NREL with the proposed sites for solar PV projects (see Appendix C). These sites include selected carports and rooftops areas. Over 24 carports were selected as potential sites for PV. The estimated power production from these sites is 2.72 MW. The total estimated rooftop area is 745,066 ft<sup>2</sup> with estimated power production calculated to be ~7.45 MW peak. The total amount of power that can be generated from the selected carports and rooftop sites is ~10.2 MW peak.

### **Economic Analysis**

For the economic analysis, the Hybrid Optimization Model for Electric Renewables (HOMER) tool was used. NREL modeled 10 MW of PV with the following capital and maintenance costs listed in Table 10, and the simple payback calculated in Table 11.

**Table 10. PV Capital and Maintenance Costs**

<i>Quantity</i>	<i>Capital (\$)</i>	<i>Replacement (\$)</i>	<i>O&amp;M (\$/yr)</i>
1 MW	6,000,000	5,000,000	5,000

**Table 11. PV Economic Analysis**

<i>Metric</i>	<i>Value</i>
Net Present worth	\$ -28,035,740
Annual worth	\$ -2,193,144/yr
Return on investment	4.23 %
Simple payback	24.9 yrs
Discounted payback	n/a

### **Recommendations**

MCBH Kaneohe Bay has a number of potential sites for PV installation on ground areas, rooftops, and carports. Ground mount systems generally have the best payback period therefore we recommend pursuing these opportunities first. MCBH Kaneohe Bay has outlined a Power Purchase Agreement (PPA) and request for proposal (RFP) with a phased award plan for all their PV projects. The PV sites and approximate available areas for each task order are in the plan. There are five task orders in the phased award plan. MCBH Kaneohe Bay may also be able to fund individual rooftop systems through Army Corps of Engineer building funds.

## **5.7 Concentrating Solar Power**

### **Technology Overview**

Electricity and useful heat can be produced through a solar thermal process using concentrating solar power (CSP). Collectors focus solar heat onto a fluid, the heat creates steam, which turns a turbine or engine attached to a generator to create electricity. CSP requires direct solar radiation and cloud cover greatly impacts the power output. Motors and controls track the sun. Although these systems include minimal moving parts, they do require preventative and unscheduled maintenance. The most common power production technologies are dish Stirling engines, parabolic troughs, and power towers which use heliostats to focus sunlight on a tower-mounted receiver.

NREL has developed a database (<http://www.nrel.gov/csp/solarpaces>) of worldwide CSP projects either operational, under construction, or under development. There are approximately fifty parabolic trough systems included in the database. World-wide there are a few smaller, distributed generation scale parabolic trough systems (1 to 5 MW scale), however the vast majority of the systems are 50 MW and larger. The small scale systems are either proof of concept or tied directly to existing power plants to supplement other conventional fuel-powered plants. Dish Stirling systems may be more appropriate for distributed generation and there are a few manufacturer's working in this space (10 kW and 25 kW), however the technology is pre-commercial. The NREL database includes only two dish Stirling systems.

### ***Existing or Planned Projects***

There are no existing or planned CSP projects at the MCBH Kaneohe Bay.

### ***Economic Analysis***

The great majority of commercially operating CSP systems are utility scale, 50 MW to 1,000 MW. A few projects of 5 MW in size and smaller have been deployed or are in planning but capital and operation and maintenance costs cannot be readily determined nor reasonably applied to potential projects at MCBH Kaneohe Bay.

### ***Recommendations***

For distributed generation, CSP is pre-commercial and not appropriate for consideration as a proven, reliable technology for MCBH Kaneohe Bay deployment. The MCBH Kaneohe Bay should consider participating in CSP proof-of-concept or field trials if presented with an opportunity that does not require financial backing of the base or commitment to long term contracts.

## **5.8 Wind Turbines**

### ***Technology Overview***

Wind turbines consist of rotating blades that convert the momentum of the wind to electric power. They have several moving parts and require regularly scheduled and unscheduled maintenance. Turbines are available from as small as 250-watt to as large as 5 MW, with the larger wind turbines being most economical. Wind turbines work best when installed in areas of wide open space.

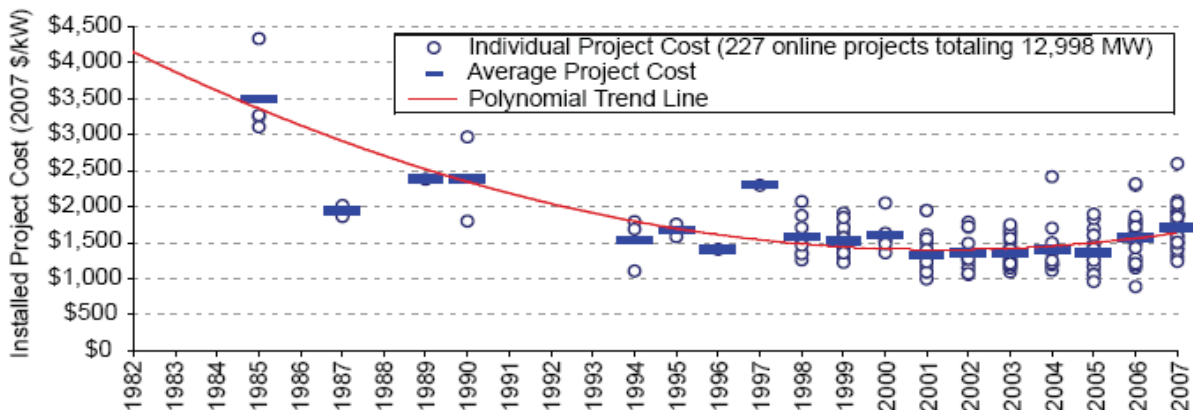
Some of the challenges as wind turbines get larger are deploying them to the island nations. Roads and transmission infrastructure are often not available at the sites. The blade sizes are often too large for transporting into remote areas on small roads. Cranes are often required to mount the wind turbine and perform maintenance. Installation and maintenance can increase the cost dramatically for wind turbines in Hawaii.

A new technology that is being used in the Caribbean is a wind turbine designed by a French company, Vergnet. The turbine is a small light weight wind turbine with a two blade rotor – teetering hub, light foundations, and guyed tower. These wind turbines can be lowered to protect them during hurricanes. Traditional turbines on the other hand use three blade rotors, a heavy tower, and large, deep foundations. The Vergnet are smaller units (275 kW – 1 MW) compared with 2 to 5 MW traditional wind turbines.



**Figure 15. Vergnet 275 kW wind turbine (2 blades)**

The cost of wind technology decreased sharply in the 1990s but then began to increase in 2006 due to increasing cost of materials (copper, steel and concrete) and market demand.



Source: Berkeley Lab database (some data points suppressed to protect confidentiality).

**Figure 16. Cost curve for Wind Technology**

**Existing or Planned Projects**

The only planned wind turbine at this time is a small 2.4 kW Skystream turbine being installed at the school. Initial screening suggests MCBH Kaneohe Bay’s strong wind resource could result in wind turbine capacity factors of 30 – 35%.

**Economic Analysis**

The economics are highly favorable for wind turbines. A 1.5 MW turbine was modeled in HOMER with the cost assumptions shown in Table 12. The number of wind turbines needed to offset all the on-site electricity is 19 for a total of 28.5 MW. The economics in Table 13 show a favorable payback of 2.78 years.



**Table 12. Cost for a 1.5 MW Wind Turbine**

<i>Quantity</i>	<i>Capital (\$)</i>	<i>Replacement (\$)</i>	<i>O&amp;M (\$/yr)</i>
1	3,500,000	2,500,000	200,000
2	6,000,000	5,000,000	250,000

**Table 13. Economics for 27 MW Wind Farm**

<i>Metric</i>	<i>Value</i>
Present worth	\$ 168,389,744
Annual worth	\$ 13,172,577/yr
Return on investment	35.1 %
Simple payback	2.78 yrs
Discounted payback	3.13 yrs

### **Recommendations**

MCBH Kaneohe Bay should consider installing wind turbines on their base; see Appendix D for wind resource and potential sites. Large wind turbines could significantly reduce their electrical use, and could possibly bring the MCBH Kaneohe Bay to net zero depending on how large a wind farm could be installed. An interconnection study would need to be done. HECO has limitations on how much power can be sold back to the grid. If there is an excess MCBH Kaneohe Bay could use the energy in their electrolysis process and create hydrogen that can be stored for their planned hydrogen fleet or to possibly run a fuel cell for backup power. Using excess wind or solar energy to produce hydrogen is being studied extensively as a way to store excess renewable energy.<sup>9</sup>

## **5.9 Fuel Cell**

### **Technology Overview**

Fuel cells offer another option for generating power at MCBH Kaneohe Bay. Fuel cells have high efficiency and low emissions in comparison with other conventional cogeneration systems. There are several different types of fuel cells, such as phosphoric acid, proton exchange membrane (PEM), solid oxide, and molten carbonate. The fuel source for these cells is typically hydrogen or a methane-based fuel, such as natural gas or renewably derived biogas. Electricity and heat produced from fuel cells is considered renewable energy when produced from a renewable biogas or hydrogen. Fuel cell systems are sized based primarily on the thermal load that can be displaced in a particular area. The electrical energy produced by the fuel cell would be put into the base distribution network and could be utilized anywhere on base; however, the thermal load must be used on site. Housing areas, with their high space-heating and domestic hot water needs, are prime candidates.

During a grid outage, the fuel cell power plant disconnects from the utility grid in milliseconds and then continues to produce power to serve the customer's critical loads. This "island" operation would strictly serve dedicated loads (as well as the loads of the fuel cell system itself), without allowing any power to be exported to an otherwise unpowered utility grid. After power returns to the utility grid and is stable, the fuel cell is designed to automatically synchronize its power to the grid, while providing continuous power to the critical loads. If critical backup is not

<sup>9</sup> K.W. Harrison, G.D. Martin, T.G. Ramsden, and W.E. Kramer; The Wind-to Hydrogen Project: Operational Experience, Performance Testing, and Systems Integration., NREL/TP-550-44082, March 2009.

required by the customer, then the fuel cell power system uses island mode to maintain power for its own process loads and remains ready for reconnection to the utility grid on return of live-grid power.

### ***Planned Projects***

In 2005 or 2006, fuel cells were installed at a few bases in Hawaii including MCBH Kaneohe Bay as part of a pilot study. NREL gathered from talking with the staff at MCBH Kaneohe Bay that there were problems with the fuel cell and it was often down for maintenance. Thus, MCBH Kaneohe Bay is not looking into installing fuel cells at the present time. Fuel cell technology has improved significantly in the past three years and MCBH Kaneohe Bay may want to reconsider fuel cells as an alternative power plant in conjunction with their on-site hydrogen production.

### ***Economic Analysis***

The electrolyzer that is being installed in MCBH Kaneohe Bay is for a 350-bar vehicle filling station. An additional 700-bar filling station will be installed in 2012. According to the Hawaii Natural Energy Institute, the approximate power consumption of the components are:

- Electrolyzer – 82 kWh/kilogram(kg)H<sub>2</sub>
- 350-bar compressor (10 HP) – 8 kWh/kgH<sub>2</sub>
- 700-bar compressor (40 HP) – 10 kWh/kgH<sub>2</sub>

The electrolyzer produces 1 kg of hydrogen per hour which is approximately 168 kg of hydrogen per week. This is a small electrolyzer to supply hydrogen to their fuel cell fleet. They currently have three sedan-type vehicles that use around 12 kg of hydrogen per week and are planning to increase the number of fuel cell vehicles in the future.

To accommodate a large fuel cell for an alternative power plant, MCBH Kaneohe Bay will need to look at industrial scale components. The electrolyzer for large scale production would need to produce 1,000 kg/day and would cost ~\$2 million. These units take ~54 kWh of electricity to produce 1 kg of hydrogen. Two manufacturers make units of 1,000 kg/day or (~2250 kW). The efficiency of the units is 62%. The utility scale electrolyzer could supply a fuel cell enough hydrogen to produce ~1.5 MW of electrical power. This is assuming that the when excess renewable energy from wind and solar is available, the the power is used to run the electrolyzer, and the fuel cell is off. When the renewables are not available, the fuel cell operates, and the electrolyzer is off. Hydrogen storage is ~\$1,000/kg and is assumed to be sufficient for the calculations. The entire system of this size would cost ~\$10 million. The calculations with assumptions are presented in the Table 14 below.

It is important to pause before deciding what to do with the hydrogen. There are three options at this point:

- Sell the hydrogen as merchant hydrogen
- Use the hydrogen to refuel vehicles
- Use the hydrogen to produce electricity.



From past analysis the most economic option is to refuel cars and busses. This does not contribute to on-site emission reductions, but does help with scope-3 emissions (which includes transportation). It would be prudent to evaluate how much hydrogen could be used for transportation before using the remainder for power production.

Power generation with fuel cells at the MW scale was demonstrated for the first time last year by Ballard Power, in conjunction with a large energy utility company. It is not certain what their costs would be for the next iterations of their design. The units will be available in 1 MW and 500 kW increments.<sup>10</sup>

As mentioned in the technology overview for fuel cells of this report, the power generation from fuel cells is capable of near-instantaneous response in demand change. Using a large, utility-scale system, can offer voltage and frequency control to balance MCBH Kaneohe Bay load dynamics and renewable power. The fuel cell could also be useful for load management.

**Table 14. Electrolyzer and Fuel Cell Calculations**

<i>PARAMETER</i>	<i>VALUE</i>	<i>Units of Measurements</i>	<i>NOTES</i>
<b>Electrolyzer</b>			
Electrolyzer size	2250	kWe	This variable can be adjusted
Production electricity use	54	kWhe/kgH2	
Electrolyzer production	41.67	kg H2/h	When renewables are available, electrolyzer operates, and the fuel cell is off.
Electrolyzer operating fraction	65%	% of time	
Average week electrolyzer operating hours	109	hours/week	
<b>Fuel Cell</b>			
Average week H2 production	4550.0	kg/week	When renewables are <b>not</b> available, FC works and ELZR stops.
Fuel cell operating fraction	35%	% of time	
Average week fuel cell operating hours	59	hours/week	
Fuel cell hydrogen consumption rate	77.38	kg/hour	Assumes fuel cell is 62% efficient and 33.34 kg/kWh
Fuel cell average power output	1599.53	kWe	
<b>Storage</b>			
Largest window of zero renewables	48	hours	This variable can be adjusted
Minimal hydrogen storage required	3,714.29	kg	
<b>Costs</b>			
Electrolyzer	2000000	\$	Assuming electrolyzer cost \$2 M Assuming storage is already sufficient
Storage	0	\$	
Fuel cell	9,997,631	\$	

<sup>10</sup> Ballard Power, <http://www.ballard.com/>

## **5.10 Landfill Gas**

### ***Technology Overview***

It is also possible to generate energy through the anaerobic decomposition of carbon-based waste streams deposited in a landfill. Landfill gas is primarily composed of methane and carbon dioxide. Typically, a gas handling system at the landfill traps, collects, and transports the gas produced. It is often necessary to clean landfill gas prior to combustion in order to remove potentially hazardous compounds such as sulfur. Once a landfill is capped and closed off, it will continue to produce gas for 15-20 years.

A good candidate for landfill gas collection should have at least 1 million tons of waste in place, be at least 30 feet deep, and be active or recently closed. It should also have a high organic content, because non-organic waste does not break down and emit methane.

### ***Analysis***

During the site visit, the NREL team discussed landfill use with the MCBH Kaneohe Bay energy team. MCBH Kaneohe Bay has two landfills on site that are primarily composed of construction and demolition (C&D) waste. The C&D landfills are not appropriate for landfill gas collection because most of the waste is not organic.

MCBH Kaneohe Bay should consider looking at landfills offsite. Offsite landfills would not provide an onsite source of renewable energy, however, if landfill gas were generated at these sites, it could be stored, transported, and used instead of propane gas. MCBH Kaneohe Bay could then utilize the renewable landfill methane gas. This arrangement would provide a renewable fuel source for MCBH Kaneohe Bay's boilers.

### ***Recommendations***

We recommend discussing offsite landfill gas generation projects with the utility that provides the propane and local landfill owners to evaluate whether local landfills are appropriate for landfill gas systems and if it is feasible to pipe gas to MCBH Kaneohe Bay.

## **5.11 Anaerobic Digestion**

### ***Technology Overview***

Anaerobic digestion is the conversion of wet biomass feedstocks such as confined animal waste, industrial effluent, or wastewater, to methane fuel. Because of its high water content, it is not efficient to transport wet feedstocks. Instead, they must be converted on site where they are generated.

### ***Analysis***

MCBH Kaneohe Bay owns an anaerobic digester that is located at their wastewater treatment plant. The size of the digester is 36,800 cubic feet. The anaerobic digester is not in service at this time but it has the potential to produce 116 kW. This small generator could produce ~1 MWh of energy each year and save MCBH Kaneohe Bay \$203,365/year in utility costs.

Like the landfill gas discussed earlier, it might be possible to look off base at the nearby waste water treatment plant for the area and treat the methane gas and have MCBH Kaneohe Bay purchase it to displace conventional propane. This arrangement would provide a renewable fuel source for MCBH Kaneohe Bay's boilers or future fuel cells.

## **Recommendations**

We recommend discussing offsite methane gas generation projects with their propane provider and the City of Kaneohe Bay.

### **5.12 Hydropower/Ocean Wave Energy**

There is a small demonstration project presently installed at MCBH Kaneohe Bay for Ocean Wave Energy. The company, Ocean Power Technologies, is testing their model PowerBuoy shown in Figure 17. The device converts wave motion into electricity with a moored buoy that floats freely up and down in the water. A structure with a piston moves as the PowerBuoy bobs in the waves. This movement drives a turbine and electric generator. The PowerBuoy installed at MCBH Kaneohe Bay is tied to the grid and rated at 40 kW. Present reports given to the electrical engineering staff at Kaneohe indicate that the PowerBuoy generates less than 10 kW.



**Figure 17. PowerBuoy**

Source: Ocean Power Technologies, Inc.

## **Recommendations**

We recommend MCBH Kaneohe Bay continue to participate in pilot demonstrations of new technologies. This will help accelerate the market development of cutting edge renewable energy technologies.

### **5.13 Hybrid System Optimization Renewable Energy Hybrid Systems**

Based on the initial REO analysis and the technologies that looked most feasible (PV and wind turbines) NREL ran a more detailed analysis using the software modeling tool, HOMER.<sup>11</sup> We took hourly load data for MCBH Kaneohe Bay from 2009 along with hourly wind data monitored from the site, and hourly solar resource data from the NASA website. HOMER calculates the optimal solution to meet the electrical load for each hour at the lowest net present cost. We ran two scenarios in HOMER:

---

<sup>11</sup> HOMER Energy LLC, Hybrid Renewable and Distributed Power Design Support. <http://homerenergy.com/>

- **Wind/ Grid Net Metered:** This analysis identifies the total wind turbine capacity needed so that MCBH Kaneohe Bay generates as much electrical energy as it uses on an annual basis to be net zero electrical energy consumption.
- **PV/Wind/ Grid Net Metered:** This analysis identifies the best mix of PV and wind such that the PV and wind turbines generate as much electrical energy on site as MCBH Kaneohe Bay uses on an annual basis.

**Wind Turbines/Grid Net metered**

NREL analysis shows that it is possible for MCBH Kaneohe Bay to become a net-zero electrical energy site with a wind turbine/grid system. 28.5 MW of wind turbines will generate as much energy as MCBH Kaneohe Bay uses on an annual basis. When the wind turbines are producing more energy than the site needs, excess energy will be sold back to the grid. When they are producing less energy than the site needs, energy will be purchased from the grid. With 28.5 MW of wind turbines, there is enough excess energy produced onsite and sold back to the grid to make it a net-zero electrical energy installation.

The modeling cost assumptions are listed in Table 12 above. The expected lifetime of a wind turbine is 20 years. The optimal wind turbine/grid tied system is summarized in Table 15, 16, and 17. The levelized cost of energy is reduced from \$0.20/kWh to \$0.05/kWh, a 75% reduction. Figure 18 illustrates the monthly average electric production from wind and purchased from the grid. The results indicate that wind power is likely a cost-effective option. The total installed capacity that the site could support would need to be further studied and depends on, among other things, siting constraints, electrical system infrastructure issues, utility interconnection rules, and net-metering limits.

**Table 15. Wind Turbine/Grid Hybrid System**

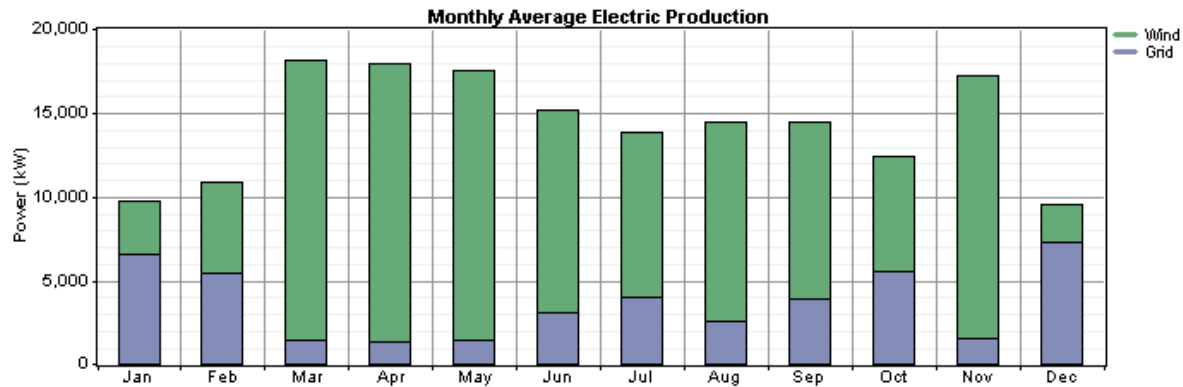
<i>Component</i>	
Wind Turbines 19 (1.5 MW each)	28.5 MW
Utility Cost	\$0.20/kWh
Levelized Cost of Energy of Wind/Grid System	\$0.05/kWh

**Table 16. Wind Turbine/Grid Annual Energy Production**

<i>Production</i>	<i>kWh/yr</i>	<i>%</i>
Wind turbines	92,879,232	74
Grid purchases	32,200,204	26
Total	125,079,440	100

**Table 17. Wind Turbine/Grid Annual Grid Sales**

<i>Consumption</i>	<i>kWh/yr</i>	<i>%</i>
Kanehoe Bay load	88,928,208	71
Grid sales	36,151,164	29
Total	125,079,376	100



**Figure 18. Monthly average electric production**

Table 18 compares commercially available turbines to examine how many turbines will be required for a wind-only NZEI. There is a significant constraint as to where turbines could be placed and larger machines will require fewer sites and less land.

The number of turbines and land required for a full NZEI using only wind varies widely. Available land area should be considered when making a turbine choice. Potential sites for wind turbines within MCBH Kaneohe Bay are shown in Appendix D.

**Table 18. Wind Turbine Technology and Estimated Number of Turbines for NZEI**

<i>Turbines</i>	<i>Hub Height (m)</i>	<i>Wind Speed (m/s)</i>	<i>Time A Zero Output (%)</i>	<i>Time At Rated Output (%)</i>	<i>Mean Net Power Output (kW)</i>	<i>Mean Net Energy Output (kWh/yr)</i>	<i>Net Capacity Factor (%)</i>	<i>Number of turbines required for NZEI</i>
GE 1.6-100	80	7.08	10.25	7.04	777.6	6,812,106	48.6	13
GE 1.6-82.5	80	7.08	10.26	3.23	614	5,378,799	38.4	16
REpower MM92	80	7.08	7.68	4.85	859.2	7,526,912	41.9	12
Siemens SWT-2.3-101	80	7.08	10.25	1.25	928	8,129,035	40.3	11
Vestas V100 - 1.8 MW	80	7.08	10.07	3.71	866	7,586,233	48.1	13
Vestas V100 - 2.0 MW	80	7.08	9.74	0.03	873	7,647,703	43.7	11
Vestas V100 - 2.6 MW	75	7.05	9.94	0.05	901.4	7,896,506	34.7	11
Vestas V112 - 3.0 MW	84	7.11	7.45	3.4	1,220.60	10,692,560	40.7	8
Vergnet GEV HP	70	7.01	10.7	0.04	316.9	2,775,885	31.7	31

All of the above turbines are applicable for the wind resource and assumed extreme winds at Kaneohe. Some manufacturers may not warranty their turbines in this location due to cyclone exposure. Not all turbines are guaranteed available for use on this project. An economic optimization for turbine selection should be performed to capture O&M, balance of plant, delivery, installation, and costs.

***PV/Wind Turbines/Grid Net metered***

Similar analysis was done to see how 10 MW of PV can affect the hybrid mix of generation for a NZEI and the levelized cost of energy. The PV size was limited to 10 MW, which is the expected

amount of PV presently being planned at MCBH Kaneohe Bay. PV was modeled with the following cost assumptions:

**Table 19. PV Modeled Cost**

<i>Size (kW)</i>	<i>Capital (\$)</i>	<i>Replacement (\$)</i>	<i>O&amp;M (\$/yr)</i>
1000	6,000,000	5,000,000	5,000

On an annual basis, with 24 MW of wind and 10 MW of PV, there is enough excess energy produced onsite and sold back to the grid to make it an NZEI. The modeling cost assumptions are listed in Table 10 above. The expected lifetime of a wind turbine and PV system is 20 years. The optimal wind/PV/grid tied system for an NZEI is summarized in Table 20, 20, and 21. The levelized cost of energy is reduced from \$0.20/kWh to \$0.09/kWh, a 55% reduction, and the renewable energy fraction at MCBH Kaneohe Bay is 78%.

**Table 20. Wind Turbine/PV/Grid Hybrid System**

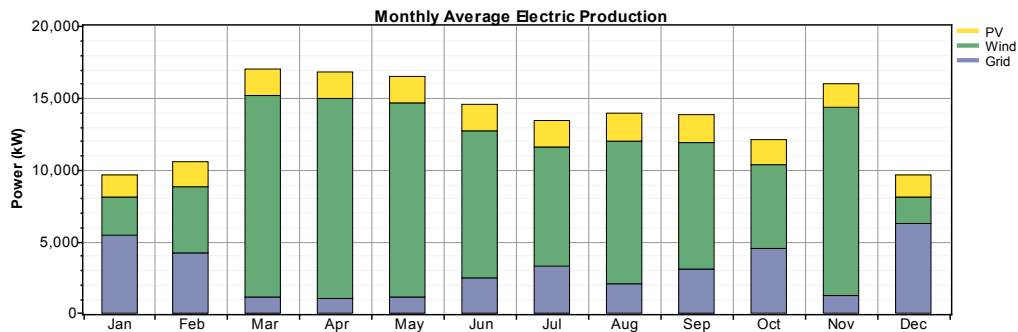
<i>Component</i>	
PV array	10.0 MW
Wind Turbines 16 (1.5 MW each)	24.0 MW
Utility Cost	\$0.20/kWh
Levelized Cost of Energy of Wind/PV/Grid Hybrid System	\$0.09/kWh

**Table 21. Wind Turbine/PV/Grid Annual Production**

<i>Production</i>	<i>kWh/yr</i>	<i>%</i>
PV array	15,432,643	13
Wind turbines	78,213,952	65
Grid purchases	26,186,056	22
Total	119,832,648	100

**Table 22. Wind Turbine/PV/Grid Annual Grid Sales**

<i>Consumption</i>	<i>kWh/yr</i>	<i>%</i>
AC primary load	88,928,208	74
Grid sales	30,904,518	26
Total	119,832,728	100



**Figure 19. Monthly average electric production**

***Recommendations***

The renewable energy analysis indicates that the installation of 28.5 MW of wind generation is the most cost effective means of obtaining net zero electricity. Adding the planned 10 MW of PV or more would further increase MCBH Kaneohe Bay’s onsite production and reduce the amount of electricity purchased from the grid. Though adding PV to the hybrid solution for NZEI slightly increases the levelized cost of energy, the PV will diversify the power generation. Often, there is wind resource at night when solar resource is not available complimenting the solar production.

## 6 Transportation Assessment

NREL personnel visited MCBH Kaneohe Bay in early 2010 and were able to obtain basic information about MCBH Kaneohe Bay’s fleet fuel consumption including a fleet list and estimated driving usage, however, we did not obtain the commuting patterns of staff. NREL is presently working with the energy management team at MCBH Kaneohe Bay to complete this analysis. In March, when NREL visited MCBH Kaneohe Bay, it was brought to our attention that a portion of their fleet is being converted to hydrogen vehicles by 2015. The data gathering and analysis is presently being updated.

### 6.1 Analysis

Although MCBH Kaneohe Bay’s fleet fuel consumption is a small component of fuel consumption at MCBH Kaneohe Bay, it is relevant because this fuel is subject to various statutory and Executive Order (EO) requirements, including EO 13423, EPLA 2005, and EO 13514. As fleet fuel consumption data was available, NREL was able to establish a NZEI transportation baseline for the fleet, see Table 23. Note: JP-8 is for tactical use and is not part of the baseline.

**Table 23. Fuel Use Baseline, MCBH Kaneohe Bay**

<i>Baseline Annual Fuel Usage Information</i>	
Total Gasoline (gallons)	181,802
Total Diesel (gallons)	93,967
Total JP-8 (gallons)	9,335,777

MCBH Kaneohe Bay recently provided information indicating that both an E85 and B20 refueling pumps were installed on base in summer 2011. MCBH Kaneohe Bay is moving quickly to transform their fuel use. Biodiesel B20 is currently used in MCBH Kaneohe Bay diesel-fueled vehicles such as buses. Diesel vehicles are generally capable of using biodiesel fuel, so biodiesel likely represents the best option for alternative fuel use at MCBH Kaneohe Bay, especially considering NREL’s baseline calculations indicate that the majority of fleet fuel is consumed in MCBH Kaneohe Bay heavy-duty tanker trucks and tractor-trailers. Generally, dispensing equipment does not need to be modified for blends of 20% biodiesel or lower, although tank cleaning is recommended when switching to B20 fuels. The dispensing systems will not need protection from freezing in Hawaii.

#### ***Transform MCBH Kaneohe Bay’s Vehicle Inventory***

MCBH Kaneohe Bay’s vehicle inventory should be transformed by “rightsizing” the overall fleet, and ensuring that the right type of vehicles is in the fleet. “Rightsizing” can be accomplished by adopting a car pool approach, and includes eliminating excess vehicles. Eliminating most of the vehicles that are driven less than 50 miles per month would be a good start. Additionally, it is recommended that MCBH Kaneohe Bay look for opportunities to transform fleet composition. MCBH Kaneohe Bay has indicated that replacing light-duty trucks and SUVs with light-duty cars is not a feasible option due to the rough terrain at the base; but adopting smaller and/or more fuel-efficient vehicles (e.g., using two-wheel drive rather than 4x4 pick-ups, or vehicles with a V6 versus a V8 engine, depending on the mission of these vehicles)



may be an alternative. Since MCBH Kaneohe Bay has installed E85 and biodiesel refueling infrastructure on-site, it is important that the base acquire vehicles that can use these types of fuel and institute policies that support the use of alternative fuel in AFVs (e.g., requiring that light-duty diesel trucks use biodiesel exclusively). Decision-assisting guidance that might look something like the following might be helpful, and could be applied to every vehicle in MCBH Kaneohe Bay's fleet.

- Does the vehicle need to exist? If the vehicle is a low mileage vehicle, consider getting rid of it and using a pool approach.
- If the vehicle is required, can it be a neighborhood electric vehicle (NEV) or some other type of smaller electric vehicle?
- If a NEV is not acceptable, can the vehicle be an HEV?
- If the vehicle cannot be a HEV, can it be a diesel vehicle and use biodiesel fuel?

At the least, replacing older, less fuel-efficient gasoline-fueled vehicles with vehicles that have better fuel economies would be a strategy to consider as well.

### ***Use Alternative Fuel***

NREL recommends that MCBH Kaneohe Bay fully commit to B20 use 100 percent of the time in its diesel vehicles. This will require MCBH Kaneohe Bay to work with its diesel supplier to obtain B20. Mixing diesel fuel and biodiesel fuel in engines and storage tanks will have adverse effects on diesel vehicle performance, so fleet users should avoid mixing biodiesel and diesel in both vehicle engines and thoroughly clean storage tanks before replacing diesel with biodiesel. If poor results with biodiesel use are experienced, consider switching fuel suppliers. Biodiesel specifications are in place that guarantee a certain quality of biodiesel fuel; so diesel vehicles at MCBH Kaneohe Bay should perform as well using biodiesel fuel as they would if they were using diesel fuel.

These measures would help MCBH Kaneohe Bay work toward petroleum reduction requirements under EO 13514, EPOA 2005, and EO 13423 and begin developing a culture that emphasizes the use of alternative fuels.

The recent addition of an E85 fueling station to MCBH Kaneohe Bay gives the base the ability to replace a large portion of the fleet's fossil fuel with ethanol. The general composition of the fleet and an estimate of fleet gasoline usage was obtained by NREL and was used to estimate the gasoline savings that could be achieved by switching certain classes of fleet vehicles over to E85. By phasing out gasoline-powered vehicles for E85 vehicles, the fossil fuel savings are shown in the table below.

**Table 24. Gasoline Savings for Changing to E85**

Percentage of light/medium duty vehicles changed to E85	Gasoline Reduction (Gallons/year)
10%	6,303
20%	12,606
50%	31,514
80%	50,423
100%	63,029

Hydrogen used in conjunction with fuel cell vehicles gives the base the ability to produce its own fuel without relying on infrastructure. At the moment, hydrogen vehicles are prohibitively expensive, but if prices fall, MCBH Kaneohe Bay may want to consider changing over to hydrogen fueled vehicles since they will be generating their own fuel primarily from renewable technologies. The potential gasoline savings from changing a percentage of light and medium duty vehicles to hydrogen is shown in the table below.

**Table 25. Gasoline Reduction for Changing to H2**

Percentage of light/medium duty vehicles changed to H2	Gasoline Reduction (Gallons/year)
10%	7,878
20%	15,757
50%	39,392
80%	63,028
100%	78,785

NREL understands that MCBH- Kaneohe Bay is converting some of their fleet to new hydrogen fueled vehicles. They are also procuring electrolysis equipment to produce hydrogen on site. The hydrogen vehicle fleet is presently three sedans that use ~4 kg of hydrogen per tank and 12 kg/week. The electrolysis equipment produces 1 kg/ hr or 168 kg of hydrogen per week. If the price comes down on hydrogen vehicles an additional 13 sedans could be purchased to replace gasoline vehicles.

## **6.2 Additional Strategies to Reduce Load and Footprint**

### ***Tactical Fuel Use Reduction***

Tactical fuel use accounts for the majority of all transportation-related fuel use at MCBH Kaneohe Bay, and a significant component of total energy use at MCBH Kaneohe Bay as well. Clearly, any reasonable efficiency analysis should at least consider tactical fuel use. NREL staff believe that the potential exists for reduced tactical fuel use. The emphasis of this analysis is not necessarily displacing tactical fuel with a bio-based fuel; but rather through adopting efficiencies.

NREL recommends that MCBH Kaneohe Bay conduct additional analysis on the potential for reduced tactical fuel use based on efficiencies. Some NREL staff associated with the MCBH Kaneohe Bay analysis are ex-military officers and/or have supported DOD extensively in the past, and they understand the unique challenges and opportunities faced by the military services.

### ***Biodiesel and Biomass Based Jet Fuel***

The potential use of tactical fuel manufactured from biomass sources presents an opportunity for MCBH Kaneohe Bay. As discussed in the fleets section, the use of biodiesel may be an option for reducing diesel consumption, as long as tanks and vehicles are dedicated to biodiesel use. Additionally, several military and commercial demonstration projects of biologically-based aviation fuels are currently underway. However, at this point there is no commercially available and affordable option to replace tactical aviation fuel derived from petroleum with a fuel derived from biomass products. MCBH Kaneohe Bay should monitor the technical development of the demonstration projects and look for opportunities to reduce its footprint with a biomass based jet fuel as soon as feasible.

### ***Fuel Delivery Systems Efficiency***

MCBH Kaneohe Bay should examine efficiency of its fuel distribution system. Since the base consumes about 9,335,777 gallons of fuel annually the fuel distribution system should be analyzed to make sure that tanks and pipelines are performing optimally.

### ***Commuter Fuel Use Reduction***

Changing commuter behavior is a difficult challenge, since often there is little flexibility in the number of trips required to and from work, and the number of miles required to drive to reach work. Even so, the following are a few recommendations for MCBH Kaneohe Bay to consider in an attempt to reduce commuter fuel consumption and associated GHG emissions.

- **Alternative Work Schedules:** MCBH Kaneohe Bay employees may be able to engage in alternative work schedules. For example, it is not uncommon for some employees to work nine hours per day (rather than eight) and to take every other Friday off, or to telecommute occasionally. These types of policies have the potential to greatly reduce commuter fuel use.
- **Ride Sharing:** NREL recommends that MCBH Kaneohe Bay encourage its staff to participate in ride-sharing programs, and, if possible, extend the use of van-pooling to areas that are not currently covered. One approach is to e-mail all employees asking for volunteers of who might be interested in sharing rides to and from work. Interested parties would provide their address information, and would be matched with other personnel living nearby. A second approach is to incentivize vanpooling by offering vouchers to pay the fare of employees who participate in official vanpools. For example, NREL's Vanpool Incentive Program provides monthly vouchers for up to \$200 to pay the fair of vanpooling employees.
- **Shuttles:** Another possible way to reduce employee commuting is for MCBH Kaneohe Bay to provide commuter shuttles between MCBH Kaneohe Bay and areas of high employee concentration, such as Honolulu. Shuttles provide an excellent opportunity to reduce commuter fuel consumption. Available advanced vehicle options include diesel

hybrid electric and plug-in diesel hybrid electric. Shuttles can also be operated using alternative fuel such as propane or biodiesel.

NREL staff did not attempt to quantify the number of personnel at MCBH Kaneohe Bay who might be interested in alternative work schedule arrangements or additional ride-sharing. However, if MCBH Kaneohe Bay were able to reduce commuter travel by 5 percent, 9,090 gallons of petroleum use would be eliminated.

# 7 Electrical Systems Assessment and Recommendation

## 7.1 Electrical Distribution System Overview

MCBH Kaneohe Bay is served by Hawaii Electric Company (HECO) at a single substation. Transmission is via a 138-kilovolt (kV) line with two 46-kV feeders to the three transformers in the main substation. The three HECO transformers have 12.5 MVA capacities. Figure 20 illustrates the MCBH Kaneohe Bay electrical one-line diagram provided by the MCBH Kaneohe Bay energy staff.

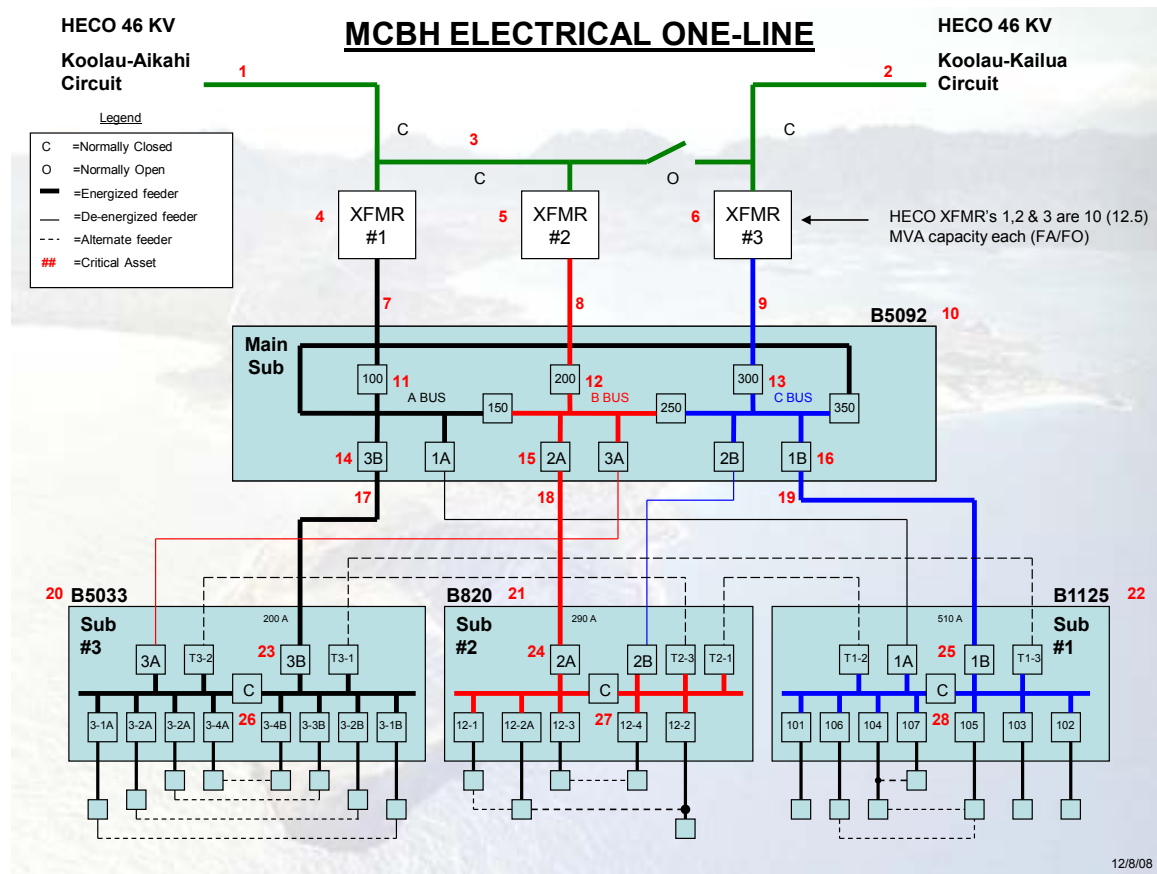


Figure 20: MCBH Kaneohe Bay single line electrical drawing

There are three substations that are fed from the main substation. Substation 1 is in building 1125 and distributes power to the east side of the base which includes the housing district and supports approximately half the base load. Substation 2 is housed in building 820 and provides service to the central part of the base including many of the operations facilities. Substation 3 is located in building 5033 and provides power to the airfield and tactical facilities.

## **7.2 Impact Analysis of Distributed Generation**

The output of the PV array and wind turbines will be stepped up via separate transformers that tie into the 12.47-kV primary distribution system. The higher voltage (69 kV) is considered (sub) transmission level and supplies the substation transformer. Transmission lines are typically not accessible to renewable energy system operators for safety reasons and utility operating requirements. Voltage connection levels are dictated by the existing utility system. Large distributed generation (DG) systems generally interconnect onto the distribution system and then tie back to a substation which is fed by a transmission line.

To maintain the integrity of the reconfigurable distribution system, each feeder must not only be able to support the DG that is proposed to be connected to that feeder, but it must also be able to support the DG that could be switched onto the feeder via reconfiguration.

## **7.3 Interconnection**

This section of the report primarily focuses on the interconnection of proposed large wind turbines into the existing electrical infrastructure at MCBH Kaneohe Bay. The interconnection for the planned PV projects (carports, ground mount, and rooftops) was not analyzed in detail here since the individual distributed generation sizes are not as significant as the wind farms. Each task order for PV projects will need to evaluate the proposed interconnection.

### ***MCBH- Kaneohe Bay constraints***

The existing electrical infrastructure at MCBH Kaneohe Bay does not present large opportunities to integrate the full 20-30 MW of wind turbines that are proposed.

Figure 21 shows the electrical configuration between the HECO interconnection and the infrastructure on base at MCBH Kaneohe Bay.

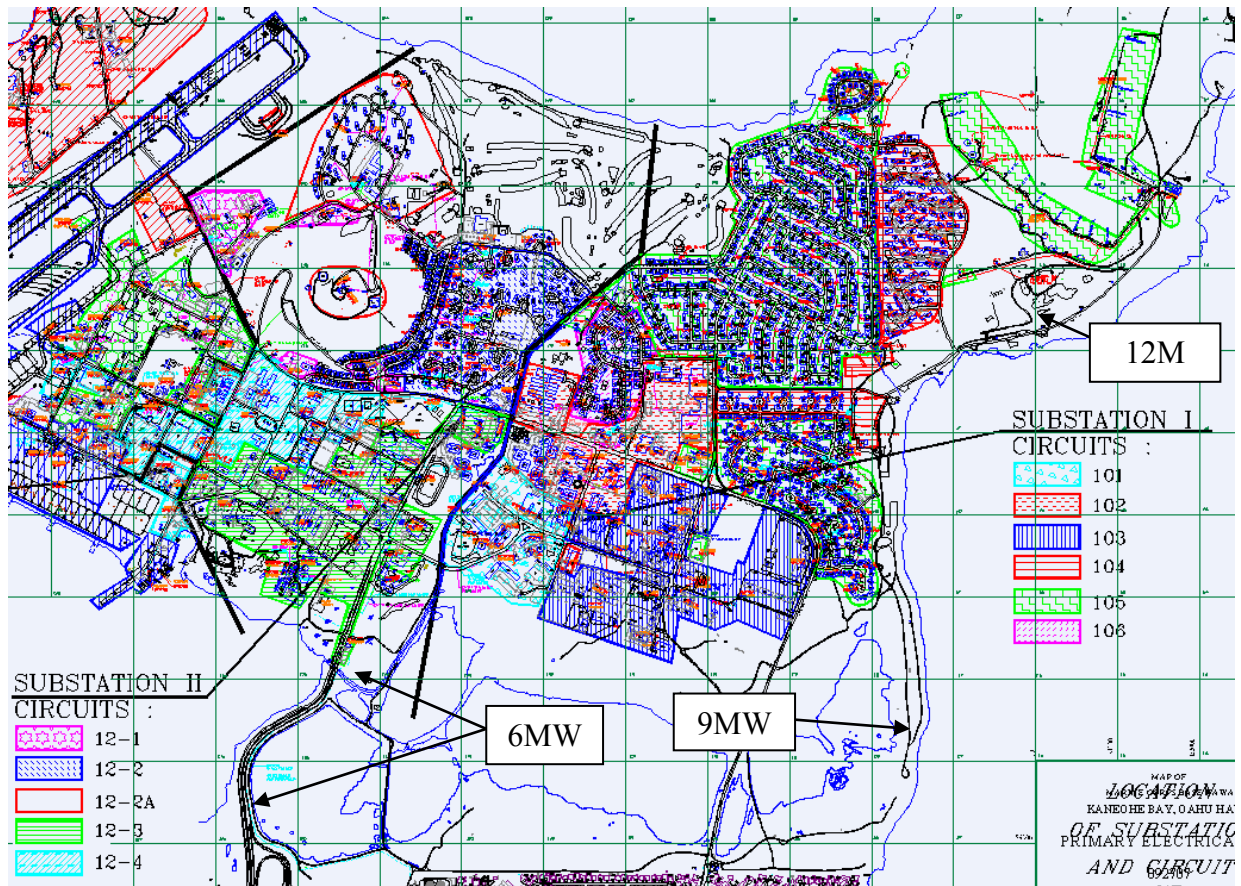


Figure 21: Existing MCBH Kaneohe Bay electrical map

Figure 21 shows the service areas of specific circuits. The feeder capacities in Appendix E show that with the proposed wind turbine configuration the wind turbines could tie into circuits 105 and 104 (both limited to approximately 5 MW), 103 (limited to 3.7 MW), and 12-3, (limited to 4.9 MW). This total capacity and individual feeder capacity falls short of the proposed wind turbine installation capacities, however turbine choice and what exact sites are deemed constructible will dictate which circuits may prove economical to interconnect with.

### Recommendations

Create a power flow model for the base to validate any assumptions about integrating PV and wind turbines into the existing infrastructure. This should be modeled independently of the HECO grid to expose any base induced power flow issues. Also, perform an economic evaluation of integrating the PV and turbines with various existing circuits.

### Oahu constraints

MCBH Kaneohe Bay lies along a 46 kV line that has the advantage of being closer to the load centers along the Southwest coast of the island compared to the existing wind farms on Oahu. Existing wind farms on the Northern shores of Oahu require some backup energy storage devices to not only smooth the fluctuations of the wind turbine output but also to provide voltage support since the turbines are far away from the other generators on the Oahu grid. Some form of voltage

support or spinning reserve may be required for this proposed 20-30 MW installation of wind turbines and 10 MW of PV at MCBH Kaneohe Bay but this will need to be modeled by HECO.

HECO has a large model and study for integration of more wind in the GE study.<sup>12</sup> The GE study found that 100 MW of wind on Oahu would not require any curtailment and thus the MCBH Kaneohe Bay proposed 20-30 MW wind project may be advantageous for HECO as this will increase spatial smoothing. However, the existing 30 MW Kahuku Wind farm combined with the proposed 70 MW Kawaihoa Wind project will fulfill the study's 100 MW assumption.<sup>13</sup> There is also a second phase transmission and wind/solar study including interconnection to Maui,<sup>14</sup> which discusses mainly the transmission strategies for interconnecting the islands, and illustrates the planning and modeling that HECO has undertaken.

Close coordination and planning in conjunction with HECO will help identify possible project scenarios. These discussions should be started as soon as possible to avoid conflicts later in the project.

Using an electrolyzer to produce hydrogen on base could also assist smoothing the output from the wind farm by consuming energy when the grid cannot handle a ramp event at high wind speeds. The electrolyzer may act as energy storage to increase power if there is a significant fall in the output of the turbine generators either due to a fault or sudden drop in wind speed. Sizing of this electrolyzer could be optimized for the final wind farm size as well as vehicle fuel demand.

---

<sup>12</sup>[http://www.hnei.hawaii.edu/PDFs/Oahu\\_Wind\\_Integration\\_Study.pdf](http://www.hnei.hawaii.edu/PDFs/Oahu_Wind_Integration_Study.pdf)

<sup>13</sup>[http://www.nrel.gov/wind/systemsintegration/pdfs/2011/owits\\_transmission\\_interconnection.pdf](http://www.nrel.gov/wind/systemsintegration/pdfs/2011/owits_transmission_interconnection.pdf)

<sup>14</sup>[http://www.nrel.gov/wind/systemsintegration/pdfs/2011/owits\\_phase2.pdf](http://www.nrel.gov/wind/systemsintegration/pdfs/2011/owits_phase2.pdf)



## 8 Net Zero Energy Potential

### 8.1 MCBH Kaneohe Bay Projects

MCBH Kaneohe Bay has implanted some energy efficiency measures with their Energy Savings Performance Contract (ESPC) submitted January 2008 by NORESKO. The ESPC covered savings in the following categories: lighting, water conservation, occupancy sensors, and HVAC controls. NORESKO estimated a total savings of 6,504,301 kWh with the four categories of energy conservation measures.

MCBH Kaneohe Bay is planning on installing between 10 and 12 MW of PV with funding from power purchase agreements. These projects are in a phased award plan with five task ordering agreements listed in Appendix C. To be conservative, projects totaling 10 MW were assumed for this analysis. The estimated production from this system is 15,432,643 kWh. The annual savings from this system would be about \$3,086,528 in year one and increasing in subsequent years as the cost of grid electrical energy increases.

### 8.2 Recommended Additional Energy Projects

#### **Energy Efficiency**

NREL estimated the energy efficiency savings potential of the base. Table 26 summarizes the potential energy savings at MCBH Kaneohe Bay, which totals 17.03% electrical load reduction, 6.62% propane load reduction, and 16.5 % overall energy reduction.

**Table 26. Energy Efficiency Savings Potential**

<i>Measure</i>	<i>Savings (% of fuel type)</i>		<i>MMBtu Equivalent Savings</i>	<i>% Total Site Savings</i>
<b>Specific Base Facilities</b>				
Commissary (32% reduction)	MWh	1,401 2.4%	4,780	2.1%
Barracks (40% reduction)	MWh	7,497 12.8%	25,587	11.4%
Offices (43% reduction)	MWh	3,215 5.5%	10,972	4.9%
Gym (52% reduction)	MWh	467 0.8%	1,593	0.7%
Mess Hall (40% reduction)	MWh	1,310 2.2%	4,470	2.0%
<b>Base Wide ECMs</b>				
Retro-commissioning	MWh	2,023 3.5%	6,904	3.1%
Lighting Occupancy Sensors	MWh	935 1.6%	3,190	1.4%
Computer Energy Mgmt	MWh	1,387 2.4%	4,732	2.1%
Water Heater Boilers	MMBtu	1,251 4.8%	1,251	0.6%
<b>Total</b>				
Electricity	MWh	18,233 17.03%	62,211	15.9%
Propane	MMBtu	1,251 6.62%	1,251	0.6%
			<b>Total</b>	<b>16.5%</b>
			<b>MMBtu</b>	

#### **Renewable Energy Analysis**

After assessing energy use reduction opportunities at MCBH Kaneohe Bay, NREL evaluated the potential for renewable energy generation to meet energy needs that would remain after any

energy efficiency improvements were implemented. The most promising technologies for implementation include solar photovoltaics, wind turbines, solar hot water, and daylighting. A summary of the technologies and their savings can be seen in Table 27 below.

**Table 27. Renewable Energy Technologies: Potential Energy Savings and Payback Period**

<i>Project Name</i>	<i>Size</i>	<i>Savings</i>	<i>Source Btu Savings MMBtu</i>	<i>% of Total MMBtu</i>
PV	10 MW	15,432,643 kWh	206,412	14%
Wind Turbines	28.5 MW	92,879,232 kWh	1,242,263	86%
Solar Hot Water	257,509 ft <sup>2</sup>	11,239 MMBtu	12,925	59%
Daylighting	99,123 ft <sup>2</sup>	2,092,540 kWh	27,988	2%
Totals				161%

Large wind turbines are the most cost effective form of renewable energy at MCBH Kaneohe Bay. Kaneohe Bay should investigate installing large wind turbines near the Ulupau Crater which rises ~100-200 m (~330-660 ft) above sea level and is ~3-5 km (~2-3 mi) away from the MCBH Kaneohe Bay airport. There is a training area and landfill nearby. Depending on the land area available large turbines should be installed with capacity of around 25- 28.5 MW. This wind farm could generate excess energy that could be sold back to the utility or utilized to generate hydrogen through MCBH Kaneohe Bay’s electrolysis fuel station being installed for their fleet.

### **8.3 Net Zero Energy Potential**

MCBH Kaneohe Bay can achieve net zero electrical energy through the installation of renewable energy technologies and investment in energy efficiency. Net zero energy status can be met with a variety of combinations of efficiency, wind turbines, and solar power.

It is not recommended at this time that MCBH Kaneohe Bay pursue thermal renewable energy. MCBH Kaneohe Bay’s current thermal energy source is propane. Approximately half of the propane usage on base can be replaced with energy efficiency measures and solar hot water systems. However it is not recommended at this time that the base abandon all propane use as this would require replacing propane powered cooking and hot water systems with either hydrogen or electrical systems. Currently a Btu of electrical energy is more expensive than a Btu from propane thus this switch would not make financial sense. If MCBH Kaneohe Bay wanted to become a full NZEI, it would need to replace its propane powered systems with hydrogen or electrical power created by renewable energy. As systems reach the end of their useful life and need to be replaced it is recommended that this option be examined.

## 9 Implementation: Project Planning and Financial Assessment

### 9.1 Implementation Options

MCBH Kaneohe Bay has a variety of available options for implementing the recommended energy projects. The following sections describe these options (note: information on financing mechanisms adapted directly from [www.femp.energy.gov/financing/mechanisms.html](http://www.femp.energy.gov/financing/mechanisms.html))

#### ***Energy Savings Performance Contract (ESPC)***

ESPCs enable federal agencies to accomplish energy-savings projects without up-front capital costs and without special Congressional appropriations.

An ESPC is a partnership between a federal agency and an energy service company (ESCO). The ESCO conducts a comprehensive energy audit for the federal facility and identifies improvements to save energy. In consultation with the federal agency, the ESCO designs and constructs a project that meets the agency's needs and arranges the necessary financing. The ESCO guarantees that the improvements will generate energy cost savings sufficient to pay for the project over the term of the contract. After the contract ends, all additional cost savings from that time on accrue to the agency. Contract terms up to 25 years are allowed.

The average contract price for a Super ESPC contract undertaken by a federal agency between 1998 and 2008 was \$15.3 million.<sup>15</sup> Typically ESPC contracts need to be at least \$1-\$2 million in size to generate interest from the private sector. It should be noted, however, that the life-cycle costs of appropriations-funded projects versus ESPC contracts have been shown to be approximately the same, if we include all costs and the longer time cycle of appropriations funding.<sup>16</sup>

#### ***Utility Energy Services Contract (UESC)***

Another way for federal agencies to implement efficiency and renewable energy projects is through utilities. Federal agencies often enter into UESCs to implement energy improvements at their facilities. With a UESC, the utility typically arranges financing to cover the capital costs of the project. Then the agencies repay the utility over the contract term, drawing on the cost savings that the energy efficiency measures generate. Using this arrangement, agencies can implement energy improvements with no initial capital investment; the net cost to the federal agency is minimal, and the agency saves time and resources by using the one-stop shopping provided by the utility.

#### ***Power Purchase Agreement (PPA)***

PPAs allow federal agencies to finance on-site renewable energy projects while incurring no up-front capital costs.

With a PPA, a developer installs a renewable energy system on agency property under an agreement that the agency will purchase the power that the system generates. The agency pays

---

<sup>15</sup> DOE Awarded Task Order Report. Federal Energy Management Program. Awarded Energy Service Performance Contracts. Accessed 8-24-09. [http://www1.eere.energy.gov/femp/pdfs/do\\_awardedcontracts.pdf](http://www1.eere.energy.gov/femp/pdfs/do_awardedcontracts.pdf)

<sup>16</sup> Hughes, P.J.; Shonder, J.A.; Sharp, T.; Madgett, M. Evaluation of Federal Energy Savings Performance Contracting-Methodology for Comparing Processes and Costs of ESPC and Appropriations Funded Energy Projects. ORNL/TM-2002/150. Oak Ridge, Tennessee: Oak Ridge National Laboratory. 2003.

for the system through these power payments over the life of the contract. After installation, the developer owns, operates, and maintains the system for the life of the contract. MCBH Kaneohe Bay has plans to use a PPA to finance the 10 MW solar rooftop and carport projects as is outlined in their task ordering plan (Appendix C).

### ***Other Implementation Considerations***

#### ***Net Metering***

Net metering for systems on HECO's grid is limited to 100 kW. So under the current rules MCBH Kaneohe Bay would not be able to build a large enough system to become a net zero energy installation. On site storage is an alternative to net metering, but would be prohibitively expensive.

#### ***Interconnection***

Interconnection of renewable energy systems into HECO's grid is limited by utility rules. The rules state that when the aggregate generating capacity per distribution feeder exceeds 10% of the peak annual KVA load of the feeder an additional technical study is needed to examine the risk of voltage regulation problems and protection malfunction from reverse power flow. Analyses such as feeder load flow dynamic stability analysis, transient overvoltage, short circuit, and relay coordination may be needed.

#### ***Incentives***

Renewable energy projects at MCBH Kaneohe Bay would likely be eligible for a variety of state and federal incentives. Energy projects could also be eligible for tax credits if they were owned by a third party with tax liability. An overview of the incentives is presented below.

- Federal Investment tax credit or rebate for PV, CSP, wind, and solar hot water systems – 30% credit of the capital cost.
- The solar hot water systems that displace electrical energy at MCBH Kaneohe Bay would be eligible for state incentives. The incentives are \$125 per deferred kW, plus \$0.05/kWh for retrofits and \$0.06/kWh for new construction.<sup>17</sup>
- Hawaii recently passed a feed in tariff program. System sizes up to 5MW are eligible for interconnection. Prices and details for the program have yet to be fully developed. However the feed in tariff's program does provide an incentive for renewable energy projects and likely simplified interconnection requirements.<sup>18</sup>
- Modified Accelerated Depreciation Schedule- A program to reduce tax liability through faster than normal depreciation. Approximate schedule is shown below:

---

<sup>17</sup> DSIRE, [http://www.dsireusa.org/incentives/incentive.cfm?Incentive\\_Code=HI06F&re=1&ee=1](http://www.dsireusa.org/incentives/incentive.cfm?Incentive_Code=HI06F&re=1&ee=1) , accessed September, 2010.

<sup>18</sup> DSIRE, [http://www.dsireusa.org/incentives/incentive.cfm?Incentive\\_Code=HI29F&re=1&ee=1](http://www.dsireusa.org/incentives/incentive.cfm?Incentive_Code=HI29F&re=1&ee=1), accessed September, 2010.

**Table 28. Modified Accelerated Depreciation Schedule**

<b>Year</b>	1	2	3	4	5	6
<b>Fraction</b>	0.200	0.320	0.192	0.115	0.115	0.058

### **NEPA**

When planning for and installing the energy projects, MCBH Kaneohe Bay must be aware of National Environmental Policy Act considerations. NEPA requires federal agencies to consider the environmental impacts of projects. The requirements for NEPA vary based on the specific project being undertaken. There are three levels of possible required analysis; categorical exclusion, environmental assessment, and an environmental impact statement.<sup>19</sup> Building energy efficiency upgrades, rooftop energy systems such as PV, daylighting, and solar hot water could qualify for categorical exclusion since they are modifications to existing facilities. However projects such as ground mount PV or concentrating solar power could require more detailed NEPA assessments since they are disturbing land. The environmental assessment would be required to determine if these projects would have a significant environmental impact. If it was deemed that the projects would have a significant environmental impact a more detailed environmental impact study would be required.

### **Radar and Wind Turbines**

Wind turbines are the recommended renewable energy technology for MCBH Kaneohe Bay. The base has an airfield that is used for training operations and there are sometimes compatibility issues between wind turbines and radar. Many military and civilian installations have turbines located near the airfield and with proper siting of turbines and coordination it is believed that these issues can be avoided at MCBH Kaneohe Bay. The military installations listed below have successfully resolved this issue.<sup>20</sup>

- F.E. Warren Air Force Base, Wyoming – two 660-kW turbines (<http://www.afcee.brooks.af.mil/ms/msp/center/Vol11No3/10.asp>)
- U.S. Navy at Guantanamo Bay, Cuba – four 950-kW turbines ([http://www.defenselink.mil/news/Mar2005/20050329\\_342.html](http://www.defenselink.mil/news/Mar2005/20050329_342.html))
- U.S. Air Force Space Command on Ascension Island – four 225-kW and two 900-kW turbines ([http://www.inl.gov/powersystems/ascension\\_island.shtml](http://www.inl.gov/powersystems/ascension_island.shtml))
- U.S. Navy at San Clemente Island Base – three 225-kW turbines ([http://www.nelp.navy.mil/pdf\\_cases/Conservation\\_Wind\\_Power\\_SCI.pdf](http://www.nelp.navy.mil/pdf_cases/Conservation_Wind_Power_SCI.pdf))

<sup>19</sup> US EPA <http://www.epa.gov/Compliance/basics/nepa.html>

<sup>20</sup> “Wind Turbines and Radar and Informational Resource”, The American Wind Energy Association. [http://www.awea.org/pubs/factsheets/060602\\_Wind\\_Turbines\\_and%20Radar\\_Fact\\_Sheet.pdf](http://www.awea.org/pubs/factsheets/060602_Wind_Turbines_and%20Radar_Fact_Sheet.pdf) Accessed, September, 2010.

## ***Implementation Plan***

In order for MCBH Kaneohe Bay to achieve net zero energy status and significant reductions in source Btu's, the base needs to implement energy efficiency measures and renewable energy systems. MCBH Kaneohe Bay can use ESPC again for energy efficiency measures outlined in Section 4. The implementation of renewable energy systems large enough to make the base net zero is limited by utility regulations on the maximum size of systems and the cost of energy storage systems. Various implementation options are discussed in this section.

### ***Option#1 Hydrogen Production***

Since wind and PV are intermittent generation systems, MCBH Kaneohe Bay would need a way to store the energy produced by the systems to balance out demand and generation. These systems are discussed in this report and include generation of hydrogen through electrolysis used to fuel the new hydrogen fleet and/or possibly a hydrogen fuel cell. The base will soon be able to produce hydrogen and in this scenario it would eliminate the need to purchase additional electricity from HECO to run the electrolysis for this operation.

### ***Option #2 Enhanced Use Lease***

A second option for the base to become a net zero energy installation would be an enhanced use lease for a large wind turbine project. Kaneohe has a very high quality wind resource as shown in the wind resource assessment done by NREL attached to this report. The base could find a developer interested in a large wind farm project on Hawaii. As a consideration for allowing the developer to site a wind farm on Kaneohe property the base could receive free electrical energy. The Navy has an enhanced use lease program and office setup to support his type of transaction. (Additional information on the Navy's enhanced use lease program can be found here: <http://www.cnic.navy.mil>).

### ***Option #3 Utility Cooperation for Expanded Net Metering or a UESC***

A third option for the base to achieve net zero energy status is reach a deal with HECO to allow for the interconnection of larger amounts of renewable energy. HECO's current rules prevent MCBH Kaneohe Bay from interconnecting enough renewable energy to achieve net zero status. Reaching a deal with HECO where generation is limited to certain conditions like specific ramp rates or giving the utility the ability to control and curtail loads would be an effective solution for MCBH Kaneohe Bay. MCBH Kaneohe Bay could build renewable energy systems larger than their current needs which would allow HECO to receive and sell the additional power, thus giving HECO a financial incentive for allowing the interconnection of larger renewables at MCBH Kaneohe Bay. A mechanism that could be utilized to facilitate this transaction could be a utility energy services contract (UESC). This would allow for the utility to act as a project developer for wind energy at MCBH Kaneohe Bay and the base could simply purchase renewable power from the utility. Utilizing the utility for this type of arrangement would likely make the ability to interconnect a much simpler process.

### ***Option #4 Feed In Tariff***

Hawaii recently passed a feed in tariff program. System sizes up to 5 MW are eligible for interconnection. Prices and details for the program have yet to be fully developed. However the feed in tariff's program does provide an incentive for renewable energy projects and likely simplified interconnection requirements. MCBH Kaneohe Bay could delay investment until the full details of this program are released and develop a project under the feed in tariff.

Depending on the technology desired at the base, the optimal implementation option will vary. It is recommended that MCBH Kaneohe Bay pursue the lowest net-present cost implementation option as well as one that will allow simple interconnection.

## **9.2 Financial Analysis**

This section presents a basic financial analysis of the recommended solution to approaching NZEI status. This analysis simply provides a sample case and does not necessarily represent the actual financial costs of these recommendations. The analysis does not present sufficient detail for project implementation but is intended to serve as the basis for further analysis and refinement of the energy strategy at MCBH Kaneohe Bay.

For the purposes of financial analysis it was necessary to make numerous assumptions. These assumptions include:

- A 20-year project lifetime
- 50% of the solar hot water projects are built in 2011 and the remaining 50% are built in 2012
- 257,509 ft<sup>2</sup> solar hot water systems have a capital costs of \$31,536,377
- O&M costs for solar hot water were 0.5% of capital cost escalated at the rate of inflation annually
- 99,123 ft<sup>2</sup> of Daylighting has a capital costs of \$4,320,360
- 10 MW of PV are installed at a capital cost of \$60,000,000
- PV O&M is \$0.006 per kWh or \$46,854 per year escalated at the rate of inflation annually
- 28.5 MW of wind turbines are installed in 2013 and 2014 at a capital cost of \$37,250,000
- Wind turbine O&M is \$3,960,373 per year escalated at the rate of inflation annually
- A discount factor of 3% from National Institute of Standards and Technology 2009 Energy Price Indices Analysis report was used
- A inflation rate of 1.2% annually from NIST 2009 Energy Price Indices Analysis report was used
- Grid electrical energy average price of \$0.20 per kWh in 2010
- Propane average price of \$2.00 per gallon in 2010
- Propane price escalation rate = 2% annually
- Electrical energy price escalation rate = 2% annually
- Electrical energy load growth rate = 3% annually
- Propane load growth rate = 3% annually
- It was assumed that the projects were financed with appropriations and were not eligible for incentives.

### **Base Case**

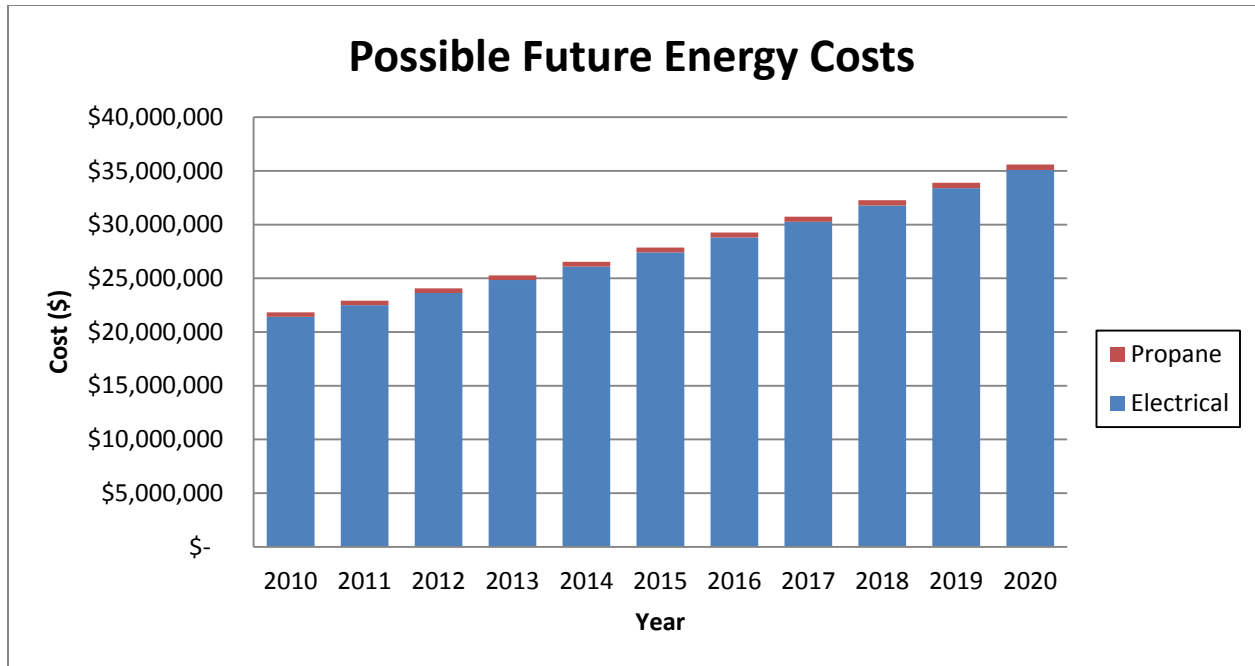
The energy baseline and cost data obtained for MCBH Kaneohe Bay were used to determine a base case for financial comparison. The base case for 2009 is shown in Table 29 below.

**Table 29. Base Case Energy Costs**

<b>Base Case</b>	<b>2009</b>
Totals	
Grid Electricity (kWh)	107,088,800
Electrical Cost per kWh	\$ 0.20
Total Electricity Cost	\$ 21,417,760
Propane (Gallons)	206,900
Propane Cost (Per Gal)	\$ 2.00
Total Propane Cost	\$ 413,800
Total Cost	\$ 21,831,560

Using the estimates above and a 20-year lifetime, the approximate cost of the base case scenario with no energy efficiency or renewable energy projects was analyzed. The future energy costs for any installation are difficult to estimate. For Hawaii, energy costs are particularly difficult to estimate because they are largely depended on the price of oil which has been very volatile over the last few years. Depending on the future development at MCBH Kaneohe Bay for range complexes, new buildings, and troop levels, the electrical load could vary. However, a possible scenario is shown in Figure 22 with an energy price increase of 2% annually and a 3% load growth rate. For the next 20 years. Under this scenario, energy at Kaneohe will cost \$780.8 million, with a net present cost of \$543.8 million.





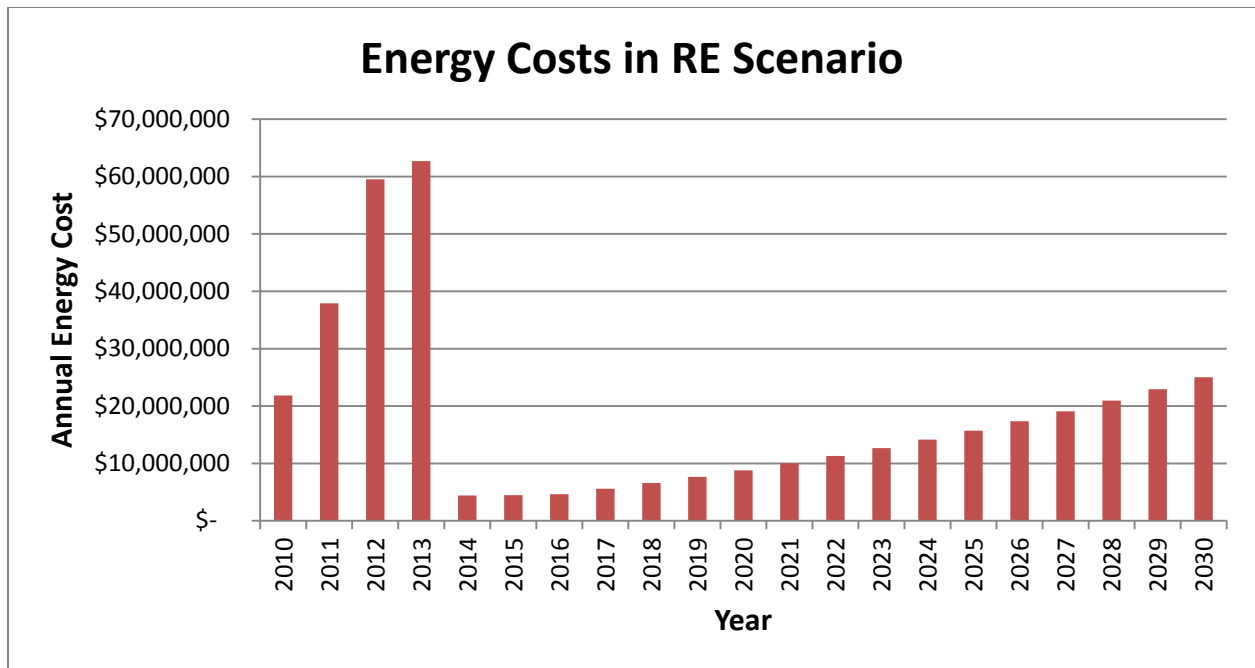
**Figure 22. Possible future energy costs**

***Recommended Scenario***

If the recommended renewable energy technologies listed in Table 27 are installed, MCHB MCBH Kaneohe Bay will likely be able to achieve cost savings. The exact amount of the cost savings will be determined by factors such as energy prices, capital costs, implementation mechanism, and incentive availability. The most crucial factor for determining the cost savings at Kaneohe will likely be a negotiated agreement with HECO to interconnect larger amounts of renewables. Without some type of agreement with HECO becoming a net zero energy installation will likely not be possible. Several scenarios for cost savings were analyzed.

***Net Metering***

If MCBH Kaneohe Bay were able to interconnect renewables under an expanded net metering arrangement with HECO, the financial scenario would be very attractive. Under this scenario the electrical bill of the base would be zero for about half of the project lifetime until the load grows enough to surpass the energy generated by the turbines in 2022. This scenario has large capital costs for the turbine in 2012 and 2013 and does not assume any incentive eligibility. The total cost for this scenario is \$393 million with a net present cost of \$301.7 million. The annual costs are shown in Figure 23.

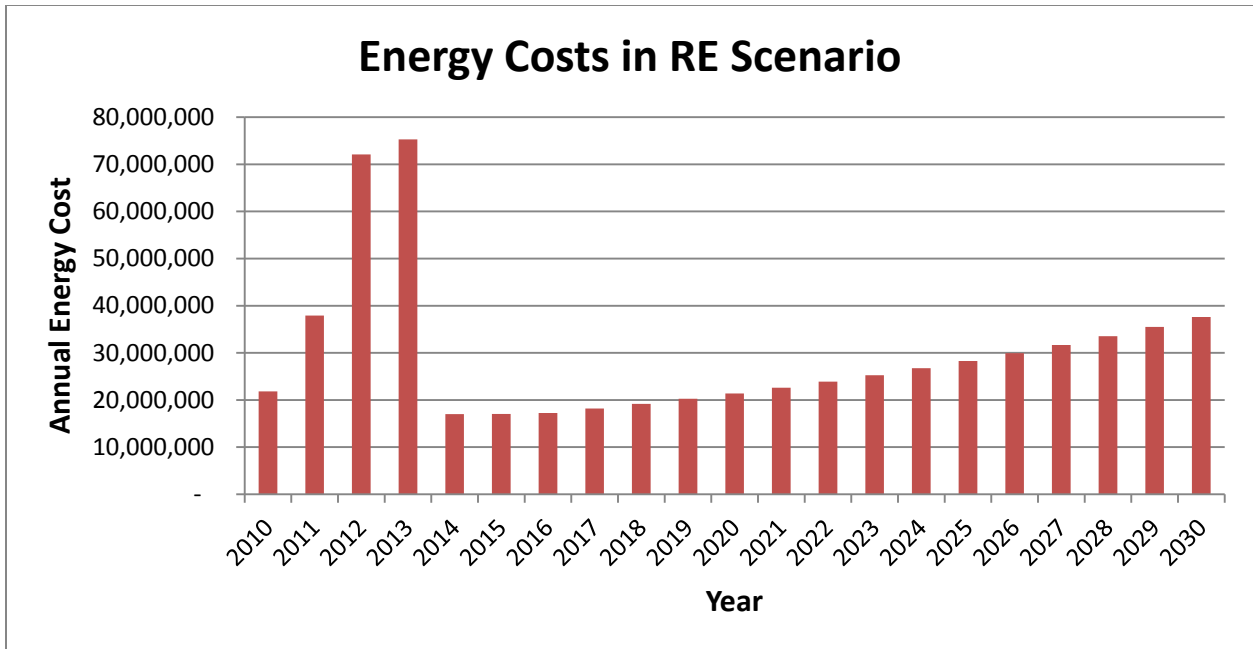


**Figure 23. Energy costs in net metering renewable energy scenario**

**Feed in Tariff**

Hawaii recently passed legislation to create a feed-in tariff (FIT) policy for renewable energy. The details of the program are still being determined regarding interconnection, pricing, and technology sizing. The military will be eligible to participate in this program, and MCBH Kaneohe Bay could be a great candidate for this program with its wind turbines since they are presently most cost effective. Assuming that the base is allowed to connect the turbines under this program a cost savings to the base would be likely. The amount of savings would be less than under net metering but still significant. The FIT rate for wind on Oahu has not been set yet. For this analysis, we estimated it to be \$0.161 per kWh, and we assumed this rate did not increase over the 20-year project lifetime.<sup>21</sup> Under this scenario, the wind energy generated by the turbines at MCBH Kaneohe Bay would be bought by the utility company at the FIT price of \$0.161/kWh. MCBH Kaneohe Bay would still be purchasing power at the HECO rate, thus the annual savings to MCBH Kaneohe Bay are the difference between the revenue generated by selling wind power to HECO and the cost of buying power. These savings are approximately \$12.6 million per year. The total cost for this scenario is \$632.5 million with a net present cost of \$471.7 million. The annual costs are shown in Figure 24.

<sup>21</sup>John Cole, National Association of Regulatory Utility Commissioners Meeting, July 2010. [http://www.narucmeetings.org/Presentations/John%20Cole\\_NARUC.Hawaii%20FIT.pdf](http://www.narucmeetings.org/Presentations/John%20Cole_NARUC.Hawaii%20FIT.pdf)



**Figure 24. Energy costs in feed in tariff renewable energy scenario**

***Enhanced Use Lease***

This scenario requires the base to find a developer interested in a large wind farm project on MCBH Kaneohe Bay land that would sell energy to the utility. As a consideration for allowing the developer to site a wind farm on MCBH Kaneohe Bay property, the base could receive free electrical energy. Since MCBH Kaneohe Bay has a very good renewable energy resource, but land is restricted, this scenario is not likely possible. The scenario where this might be possible is if MCBH Kaneohe Bay were to host the substation for the submarine cable from the big wind project on Lanai. The substation is estimated to require five acres of land to convert the DC transmitted power to AC power for use on the island. Presently, the submarine cable will be routed through MCBH Kaneohe Bay to the HECO substation near the base. MCBH Kaneohe Bay could become an NZEI by purchasing a portion of the transmitted energy from the Big Wind project on Lanai. This would require the base give to up some of its land and it is unclear if the base is able to do so with its mission requirements.

## **10 Conclusion**

NREL's net zero analysis evaluated opportunities for energy efficiency, renewable energy, and transportation fuel reduction at MCBH Kaneohe Bay. The analysis shows that MCBH Kaneohe Bay has the potential to make significant progress toward becoming a net zero installation. If the base implements the recommended energy projects and savings measures, it would achieve a 96% site energy reduction and a 99% source energy reduction. By achieving this status, the base will set an example for other military installations, provide environmental benefits, reduce costs, increase energy security, and exceed its goals and mandates.

# Appendix A. Renewable Energy Resource & Environmental Maps

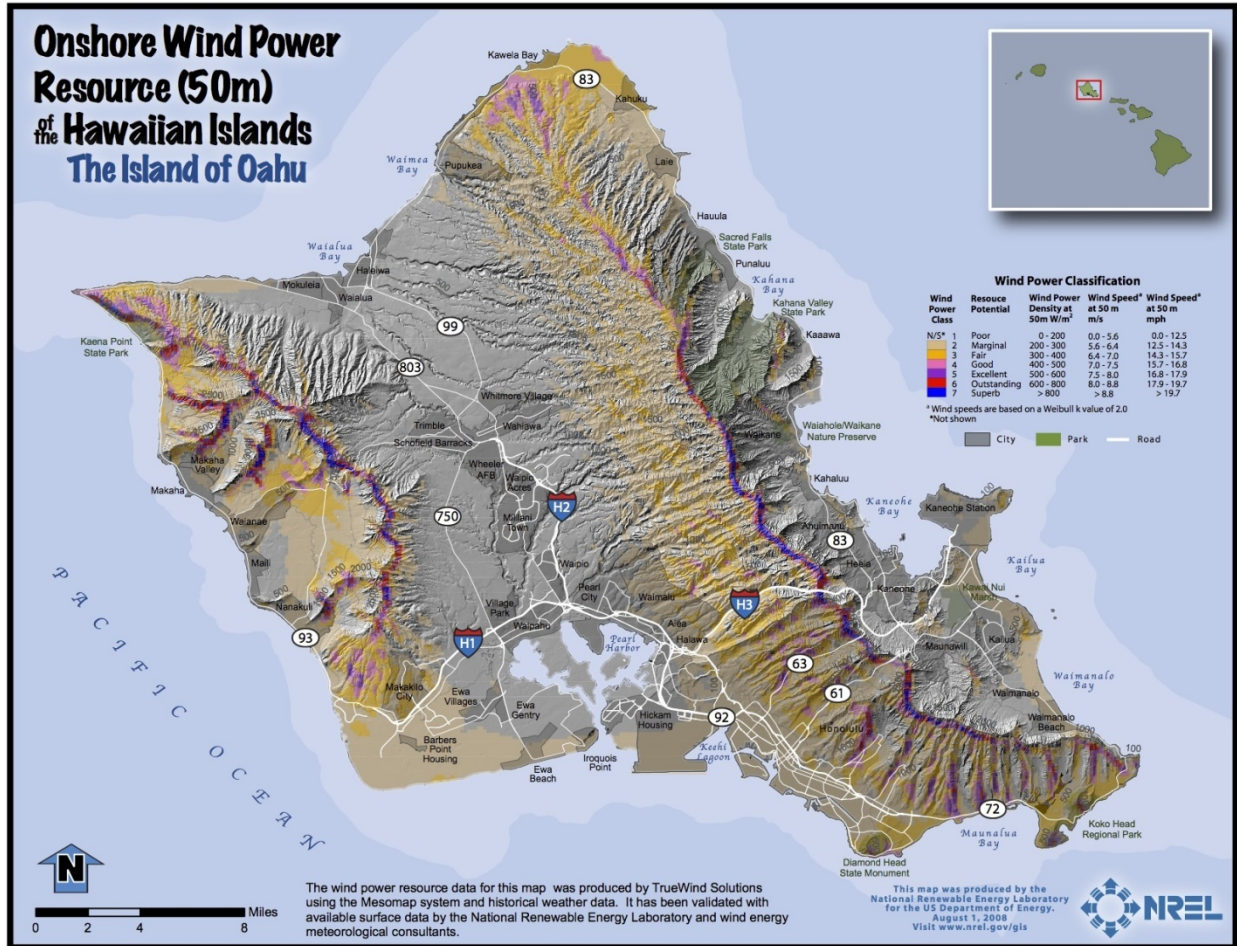
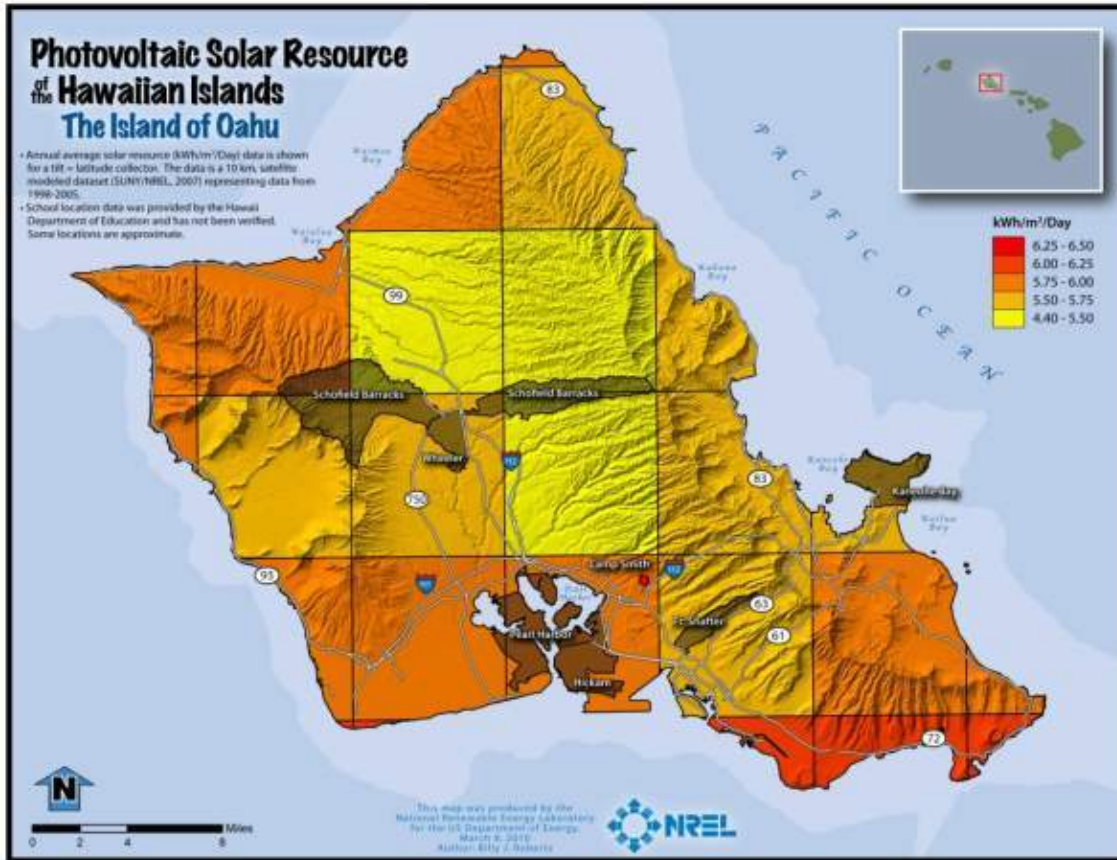


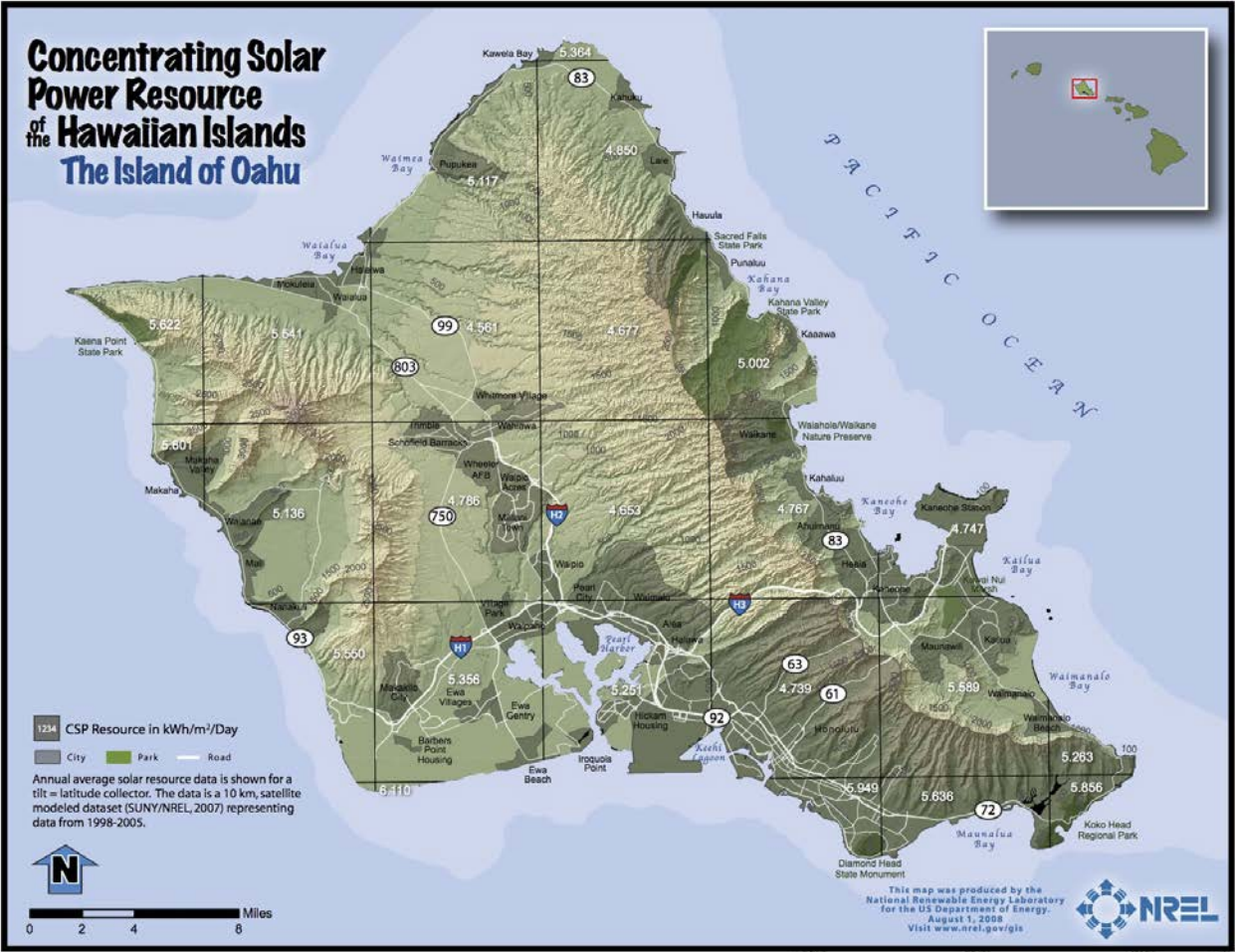
Figure 25. Wind resource on Oahu



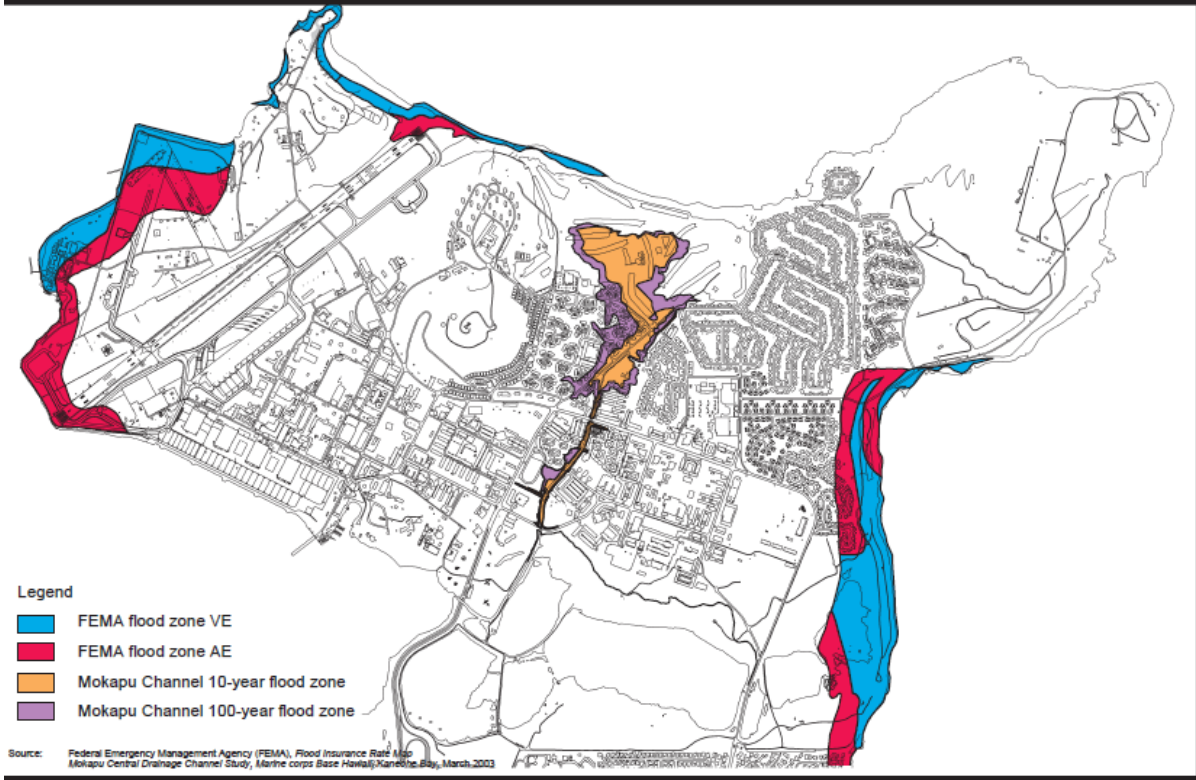
**Figure 26. Solar resource on Oahu**

(Note: MCBH Kaneohe Bay is in the solar grid with average 5.50-5.75 kWh/m<sup>2</sup>/Day)





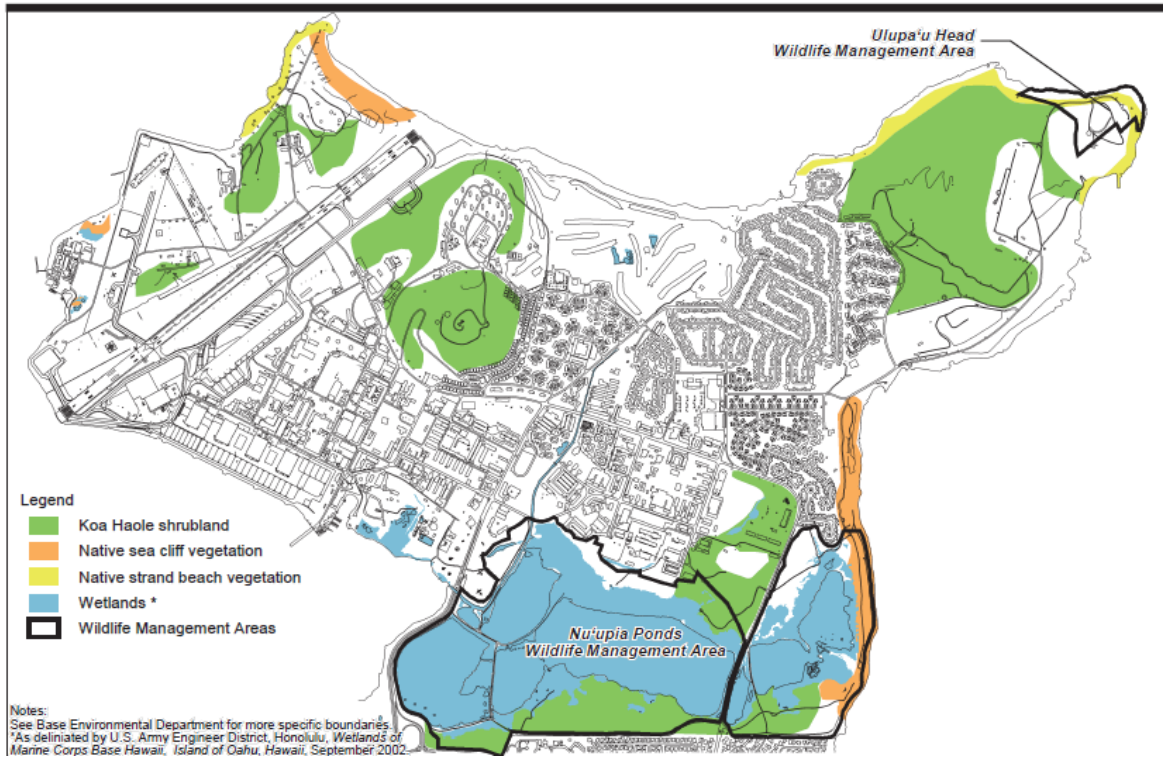
**Figure 27. Concentrated solar power resource map for Oahu**  
 (Note: MCBH Kaneohe Bay’s average solar resource is 4.747 kWh/m<sup>2</sup>/Day)



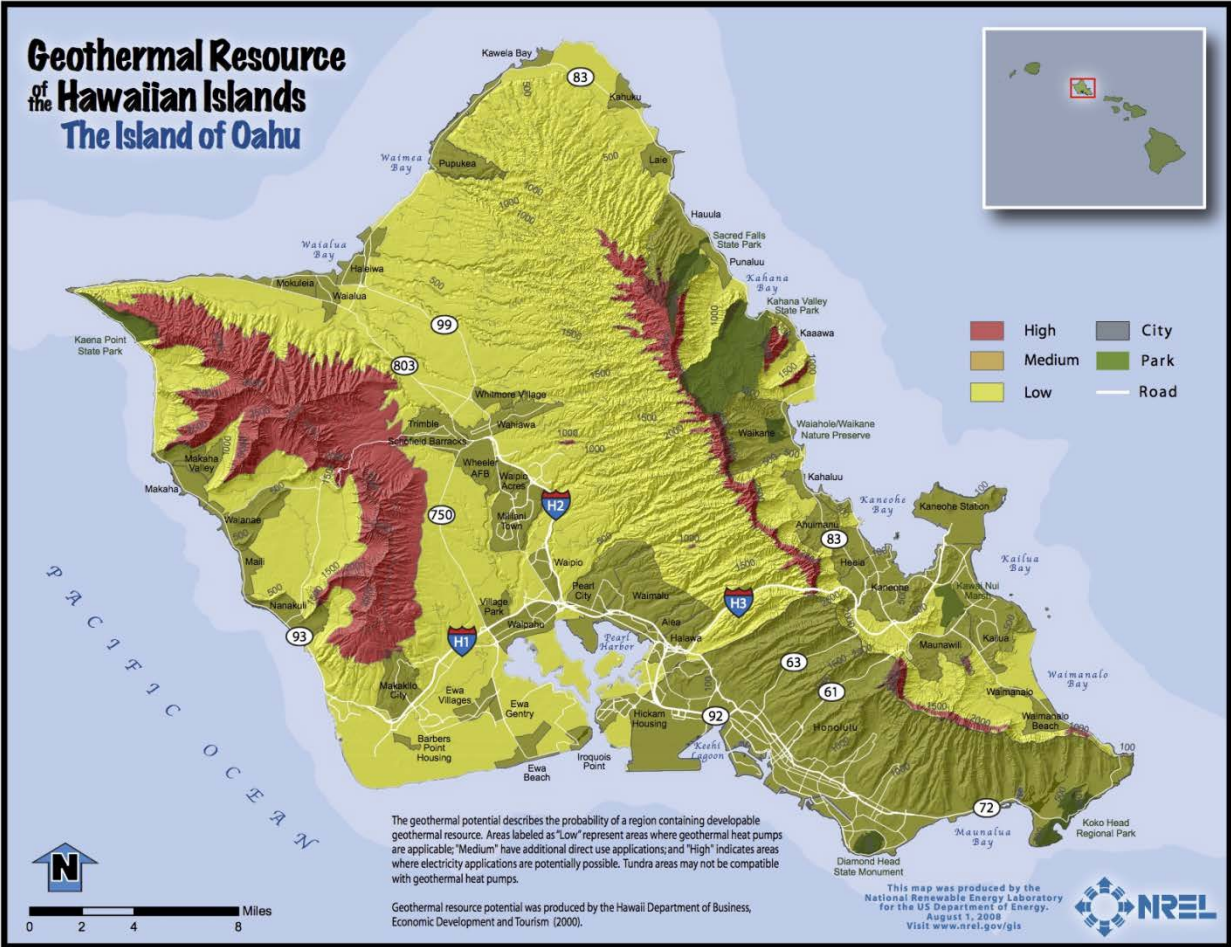
**Figure 28. Flood zones**

Source: MCBH Kaneohe Bay Master Plan 2006



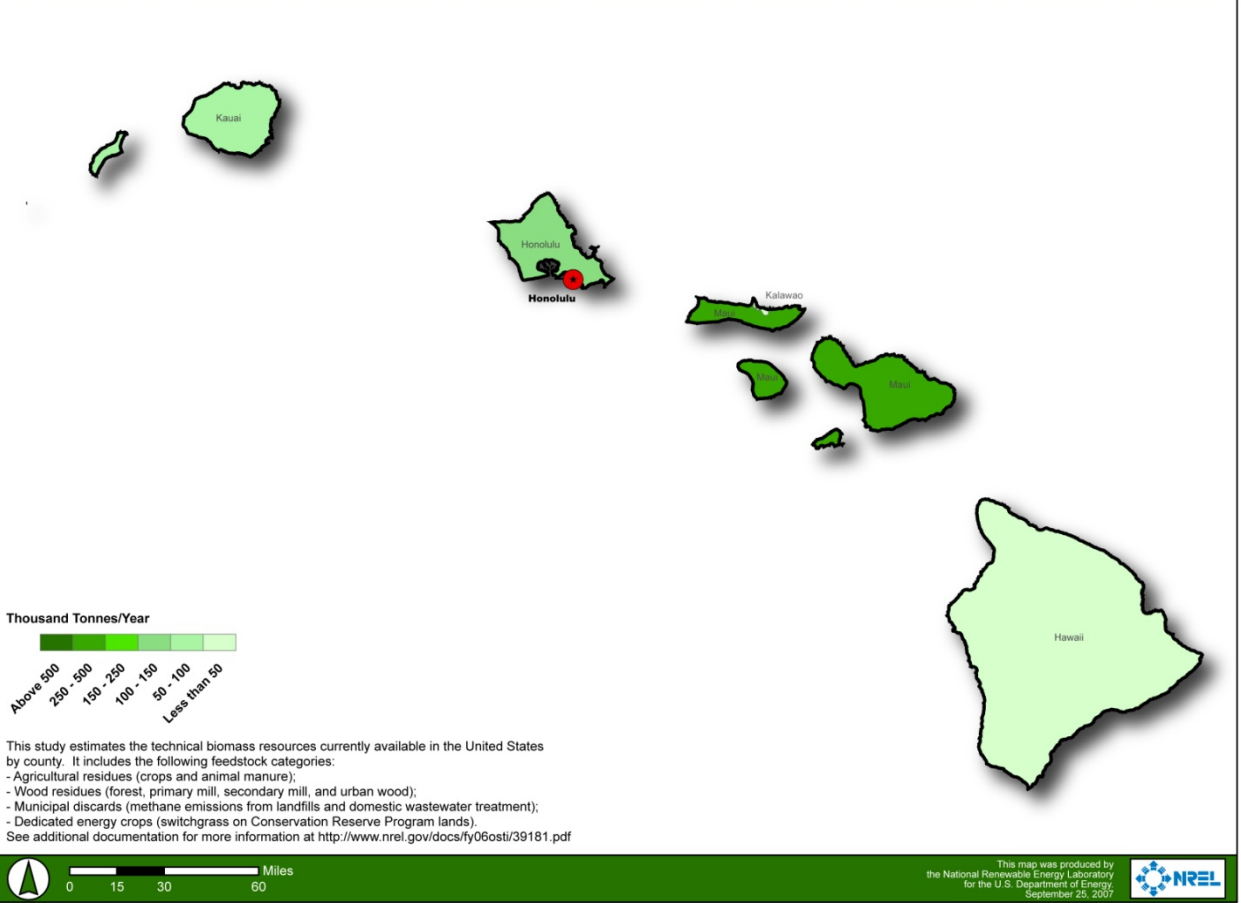


**Figure 29. Biological sensitive lands**  
Source: MCBH Kaneohe Bay Master Plan 2006



**Figure 30. Geothermal resource on Oahu**

(Note: MCBH Kaneohe Bay is very low geothermal resource)



**Figure 31: Biomass resource maps for all Hawaii islands**

(Note: Oahu has 50-100 Thousand Tonnes/year of Biomass)

## Appendix B. Specific Energy Efficiency measures

### Specific Main Base Facilities

#### Offices

There is over 391,816 ft<sup>2</sup> of office space on the base at MCBH Kaneohe Bay. The average building size is 10,590 ft<sup>2</sup>. Offices comprise 11.5% of the total installation building square footage. The office spaces consume an estimated 7,512 MWh of electrical energy each year. The offices consume a very small amount of propane, which is used for domestic water heating. An energy model of the average office building was built<sup>22</sup> to estimate the energy reduction potential of the offices at MCBH Kaneohe Bay. The average energy use intensity (EUI) for the office spaces at MCBH Kaneohe Bay is 67.3 MMBtu/1000 ft<sup>2</sup>/Yr. The HECO benchmark for office buildings in Hawaii is 77.9 MMBtu/1000 ft<sup>2</sup>/Yr. Although the offices are operating below the HECO benchmark, there is still a significant amount of savings that could be realized through energy efficiency measures.

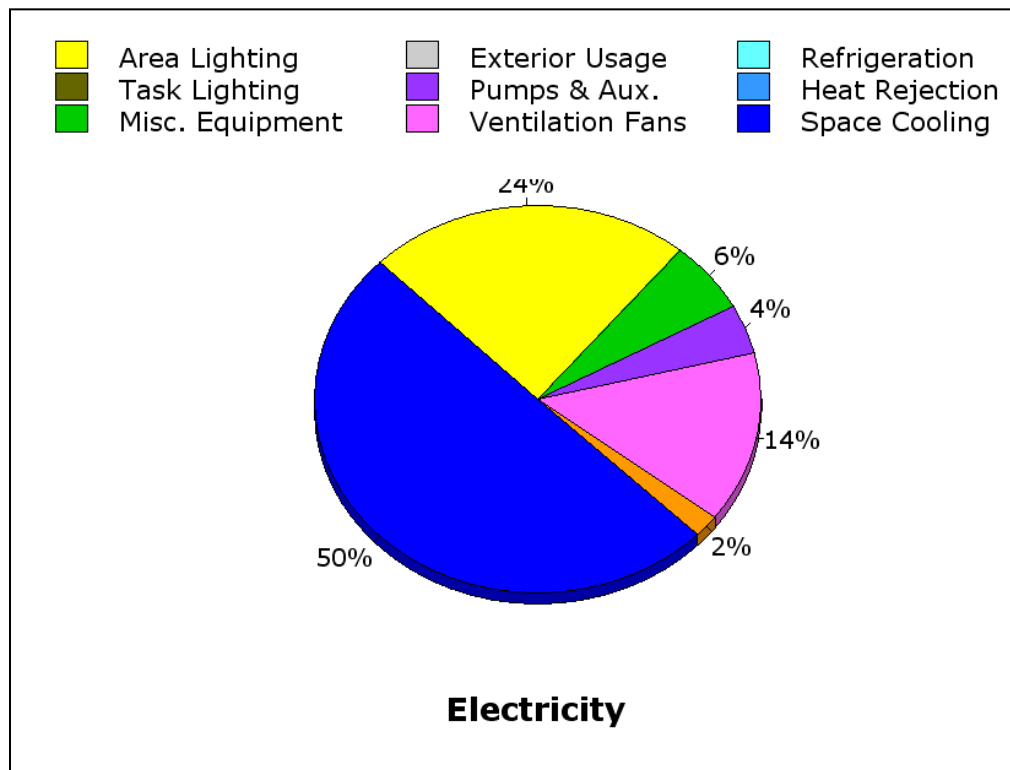


Figure 32. Modeled electricity end use office buildings

The NREL team spoke with the onsite staff about the base buildings, and visited several of the buildings while on site. Several opportunities for savings were identified based on discussions about the base-wide mechanical systems. The team built a basic energy model using typical office building assumptions and bundled the following ECMs to estimate the energy that could be saved in the offices.

<sup>22</sup> The energy modeling program eQUEST was used to build the energy model.

Energy model ECMs included:

- Implement a night time and weekend setback on the HVAC system
- Close the outside air dampers during unoccupied hours
- Replace air cooled chillers with a variable speed water cooled chillers
- Convert CV air delivery systems to a VAV system
- Put a VFD on the cooling tower fan
- Implement a condenser water temperature reset
- Chiller water temperature reset
- Put a VFD on the chilled water pumps.

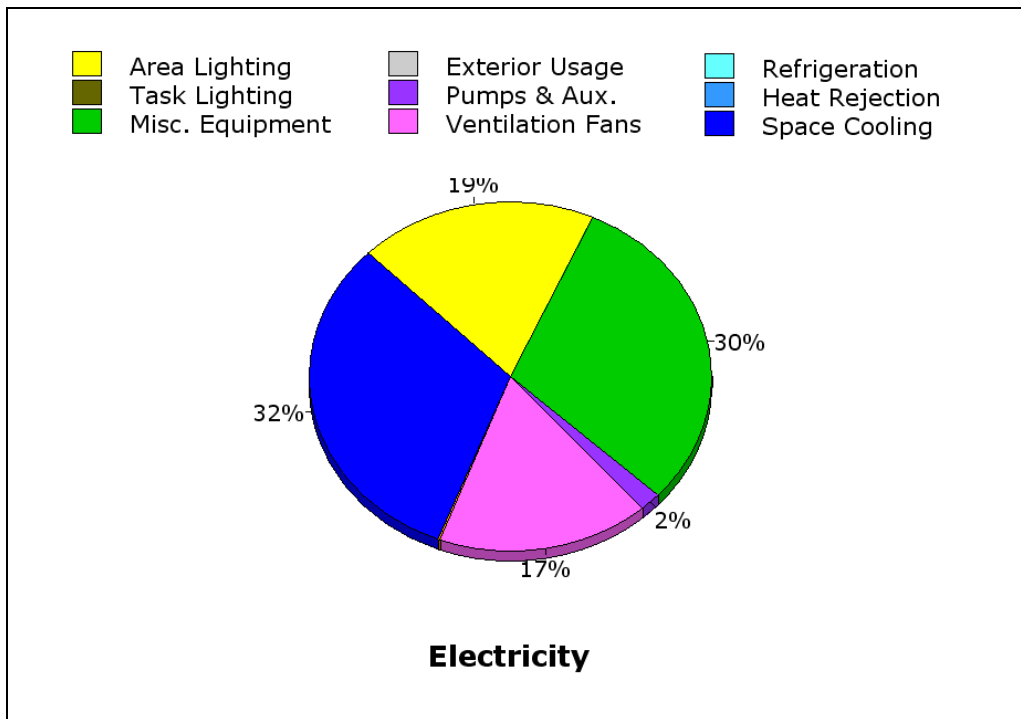
The energy reduction potential was calculated to be 43% for the average size office building. Expanding this reduction potential to all of the office space at MCBH Kaneohe Bay equates to 3,215 MWh/yr.

Typical office ECMs that could potentially be implemented, but were not investigated by the NREL team include:

- Lighting level reduction, and use of LED task lighting
- Replace all existing faucets and toilets with low flow devices
- Put all offices on the central DDC system.

### *Commissary*

The commissary is an on-base commercial facility that provides goods and services to military personnel and their families. The commissary is 89,625 ft<sup>2</sup>, which comprises 2.6% of the total installation building square footage. The commissary consumes an estimated 4,427 MWh per year of electrical energy. The commissary does not consume any propane. The commissary represents 7.6% of total base electrical energy consumption. The energy use breakdown of the commissary is shown below. The EUI for the commissary at MCBH Kaneohe Bay is 168.5 MMBtu/1000 ft<sup>2</sup>/Yr. The HECO benchmark for grocery stores in Hawaii is 181.0 MMBtu/1000 ft<sup>2</sup>/Yr. Although the commissary is operating below the HECO benchmark, there is still a significant amount of savings that could be realized through energy efficiency measures.



**Figure 33. Modeled electricity end use in the commissary**

The NREL team spoke with the onsite staff about the base buildings and examined the mechanical systems while on base. The team built a basic energy model using typical food sales assumptions and bundled the following ECMs to estimate the energy that could be saved at the commissary.

Energy model ECMs include:

- Implement a night time setback on the HVAC system
- Close the outside air dampers during unoccupied hours
- Convert the system from a CV system to a VAV system.
- Replace the current chiller with a high efficiency water cooled variable speed chiller
- Put a VFD on the cooling tower fan
- Implement a condenser water temperature reset
- Chiller water temperature reset
- Put a VFD on the chilled water pumps.

With these measures bundled, the commissary has the potential to save 1,401 MWh which represents a 32% reduction in the electrical load of the commissary.

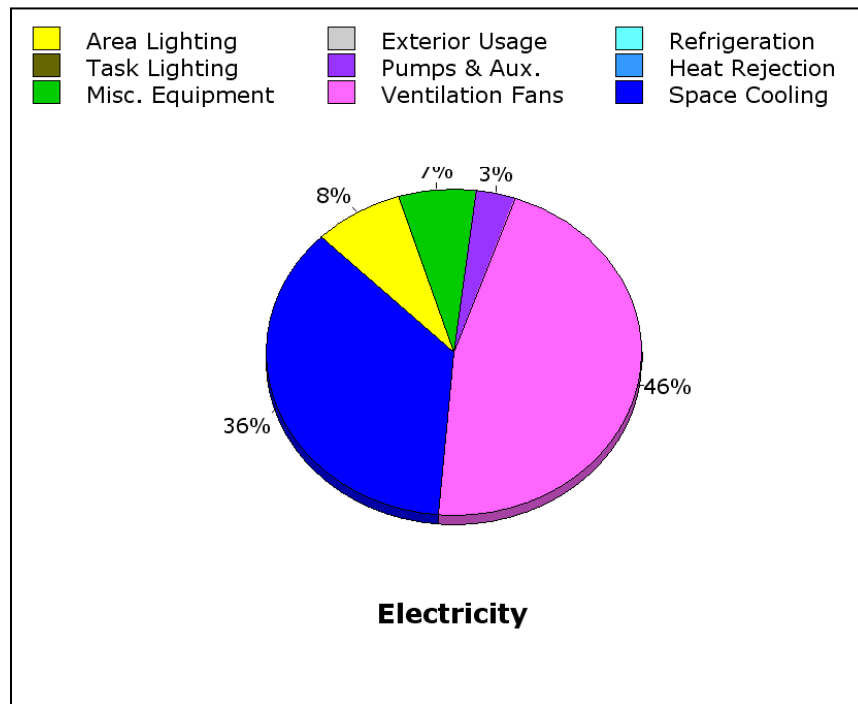
Typical food-sales ECMs that could potentially be implemented, but were not investigated by the NREL team include:

- Lighting level reduction

- Switching the light bulbs in freezers and refrigerators to LED bulbs to save on both cooling and lighting energy. Incandescent bulbs give off significant amounts of heat and increase the refrigeration energy requirements. The heat produced by standard bulbs increases energy requirements for the freezers 25%-50%.<sup>23</sup>
- Utilize waste heat from refrigeration to reduce the domestic hot water load of the building
- Implement static pressure reset.

### **Barracks**

The barracks of the base at MCBH Kaneohe Bay provide housing for service members on the base. There are over 1,155,386 ft<sup>2</sup> of barracks and similar housing on the base at MCBH Kaneohe Bay. The average building size is 30,405 ft<sup>2</sup>. Barracks and similar housing comprise 32% of the total installation building square footage. The barracks consume an estimated 18,668 MWh per year of electrical energy, and an estimated 4,696 MMBtu of propane. The barracks use propane to heat water. The EUI for the barracks at MCBH Kaneohe Bay is 61.9 MMBtu/1000 ft<sup>2</sup>/Yr. The HECO benchmark for lodging in Hawaii is 55.1 MMBtu/1000 ft<sup>2</sup>/Yr. The barracks at MCBH Kaneohe Bay are slightly higher than the HECO benchmark. This combined with the measures that were identified during the site visit indicate that there are improvements that can be made in energy efficiency.



**Figure 34. Modeled electricity end use in barracks**

The NREL team spoke with the onsite staff about the barracks and looked at the mechanical systems for some of them. Several opportunities for savings were identified based on discussions about the base wide mechanical systems. The team built a basic energy model using typical

<sup>23</sup> “Lighting The Way to Greener Retail”, Nualight. [http://www.nualight.ie/lighting\\_the\\_way\\_to\\_greener\\_retail.pdf](http://www.nualight.ie/lighting_the_way_to_greener_retail.pdf)

barracks assumptions and bundled the following ECMs to estimate the energy that could be saved in the barracks.

Energy model ECMs include:

- Replace the air cooled chiller with an HE water cooled chiller
- Convert the CV air delivery system to VAV
- Implement a variable flow chilled water system
- Replace pump and fan motors with premium efficiency motors
- Replace all fan belts with cogged v-belts.

The energy reduction potential was calculated to be 40% for the average size barrack. Expanding this reduction potential to all of the barracks at MCBH Kaneohe Bay equates to 7,497 MWh/yr.

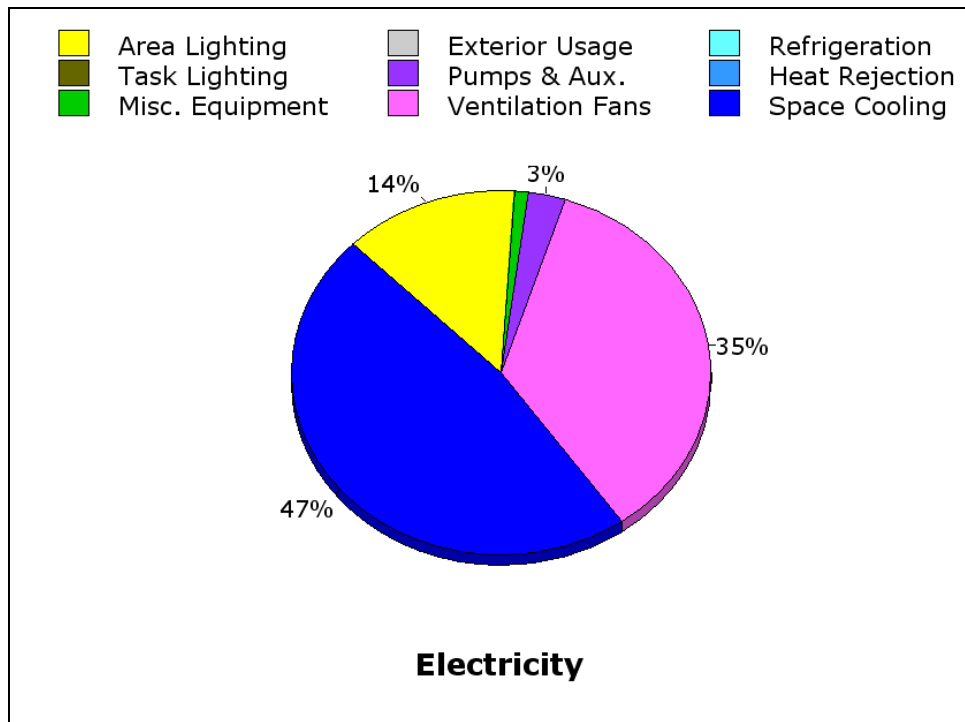
Typical housing ECMs that could potentially be implemented, but were not investigated by the NREL team include:

- Replace washer and dryer with energy star appliances
- Install low flow faucets, showerheads, and toilets
- Install occupancy monitoring devices such as card readers to ensure that non-occupied units are not being heated or cooled.

### ***Main Gym***

The main gym on base provides a work out facility for military personnel and their families. The gym consists of gymnasium space, weight rooms, aerobics rooms, and other spaces for exercise. The main gym comprises 0.6% of the total installation building square footage. The gym consumes an estimated 899 MWh per year of electrical energy, and 1.020 MMBtu per year of propane. The main gym uses propane for domestic hot water. The facility also utilizes some waste heat from the chillers to heat domestic hot water. The gym represents 1.5 % of total base electrical energy consumption. The energy use breakdown of the gym is shown below.





**Figure 35. Modeled electricity end use in main gym**

The NREL team spoke with the onsite staff about the gym and looked at the mechanical systems. Several opportunities for savings were identified based on discussions about the base wide mechanical systems. The team built a basic energy model using typical gym assumptions and bundled the following ECMs to estimate the energy that could be saved.

Energy Model ECMs include:

- Implement an unoccupied setback on the HVAC system
- Close the outside air dampers during unoccupied hours
- Replace the air cooled chiller with a HE water cooled chiller
- Convert the CV air delivery system to VAV
- Implement a variable flow chilled water system.

With these measures bundled, the main gym has the potential to save 467 MWh which represents a 52% reduction in the building's electrical load.

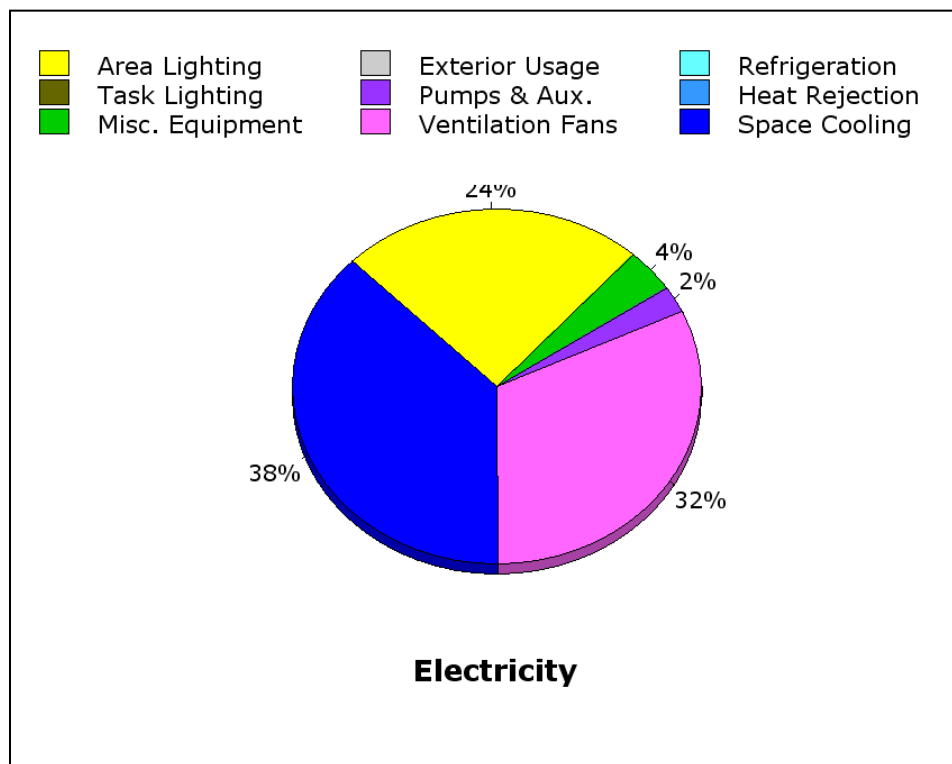
Typical gym ECMs that could potentially be implemented, but were not investigated by the NREL team include:

- Lighting level reduction
- High bay lighting improvements
- Lighting controls for nighttime and weekend setbacks

- Occupancy sensors in the restrooms
- Low flow faucets and toilets
- Low flow showers.

### Food Services

The food services on base provide dining facilities for all military and civilian personal and on the base. There are several facilities consisting of everything from fast food chains to mess halls. The food services comprise 2.9% of the total installation building square footage. The food services consume an estimated 3,266 MWh per year of electrical energy, and over 4,526 MMBtu per year of propane. The main gym uses propane for domestic hot water and cooking. The food services represent 5.6% of total base electrical energy consumption. The energy use breakdown of the food services is shown below. The EUI for the Food Services at MCBH Kaneohe Bay is 176.5 MMBtu/1000 ft<sup>2</sup>/Yr. The HECO benchmark for restaurants in Hawaii is 180.4 MMBtu/1000 ft<sup>2</sup>/Yr. Although the food services are operating below the HECO benchmark, there is still a significant amount of savings that could be realized through energy efficiency measures.



**Figure 36. Modeled Electricity End Use Food Services**

The NREL team spoke with the onsite staff about the food services and looked at the mechanical systems. Several opportunities for savings were identified based on these discussions and the site visit. The team built a basic energy model using typical food service assumptions and bundled the following ECMs to estimate the energy that could be saved.

Energy model ECMs include:

- Implement an unoccupied setback on the HVAC system
- Configure the kitchen exhaust fans to operate on demand
- Replace the air cooled chiller with a HE water cooled chiller
- Convert the CV air delivery system to VAV
- Implement a variable flow chilled water system.

With these measures bundled, the main gym has the potential to save 1,310 MWh which represents a 40% reduction in the building's electrical load.

Typical Food Service ECMs that could potentially be implemented, but were not investigated by the NREL team include:

- Heat recovery from the chillers to heat domestic hot water
- Low flow faucets and toilets.

## **Appendix C. Solar PV Projects Identified by MCBH Kaneohe Bay**

The following tables were received from MCBH Kaneohe Bay during the site visit and map out each potential site for PV on carports and rooftops. PV Watts Version 1 was used to calculate the annual output of energy for a given carport area. Table 30 lists the potential carports for PV installation. There are 24 carport sites selected that could generate ~2.70 MW of DC peak power.






Table 31 lists all the potential rooftop area available for PV. The condition of the roof and number of existing skylights is noted in the table. The total area available for PV is 745,066 ft<sup>2</sup> and could produce ~7.45 MW of peak power.




Table 32 outlines the proposed sites in each task order for the phase award plan provided by MCBH Kaneohe Bay.





**Table 30. Carport PV Sites for MCBH Kaneohe Bay**

<b>MCBH Solar PV Carports</b>					
Revised: 5 June 2009					
<b>Scope:</b> Based on carport structure and amorphous silicon photovoltaic roofing. Work includes installation of power inverter and all electrical connections, including electric grid connection, and small building to house inverters at each of 24 locations.					
Bldg - Parking Lot	Parking Stalls	Watts/Stall	Peak Capacity KW (dc)	(1) Annual Output kWh	Remarks
<b>+++ Kaneohe Bay +++</b>					
1604/1632	82	900	74	102,125	Two row carport to cover parking spaces in the center of the parking lot with head-to-head parking from each side (37).
1634/1635	60	900	54	74,523	Two row carport to cover parking spaces in the center of the parking lot with head-to-head parking from each side (27).
1655/1656	156	900	140	193,209	Three separate carport structures will cover parking spaces in the center of the parking lot with head-to-head parking from each side (24,24,22).
6109/6477/6088	546	900	491	667,612	One single row carport structure (40), three double row (30), three double row (26), six double row (27,25,23,15,12,9)
1090	248	900	223	307,754	One double row carport structure (49), three single row (51,51,48)
CSSG-3 Motor Pool, 3017	168	900	151	208,390	Six single row carport structures (20) for tactical vehicles, and one double row (8), three single row (13,13,6) for POVs
3037	104	900	94	129,726	Two double row carport structures (22,30)
5070/5071	54	900	49	67,623	One double row carport structure (27)
221-229, 4009	281	900	253	349,156	Two double row carport structures (34), four single row carport structures (30,36,34,45)
219	142	900	128	176,648	Two double row carport structures (23), three single row carport structures (15,15,20)
242	74	900	67	92,464	Carport to cover parking spaces in the center of the parking lot with head-to-head parking from each side (19). Carport along each edge for head-in parking (24 + 12)
Facilities Motor Pool, 352	72	900	65	89,704	Four single row carport structures (18), high bay to accommodate trucks and buses
3rd Rad Batt Motor Pool, 373	75	900	68	93,844	Three single row carport structures (25) for tactical vehicles
Deployed Veh Parking, 370	700	900	630	869,441	Five double row carport structures (70) for deployed vehicle parking
503	80	900	72	99,365	Two single row carport structures (40)
502	61	900	55	75,904	Three single row carport structures (8, 18, 35)
3088	119	900	107	147,667	Two double row carport structures (15, 24) and two single row carport structures (15, 26)
<b>SUBTOTALS</b>	<b>3,022</b>		<b>2,720</b>	<b>3,745,155</b>	
Assumptions: 1) PV Watts, Ver 1, used to calculate annual output      Total Rounded 2) Current electric rate is \$0.20/kWh 3) Installation cost is \$11/watt (based on Solar Integrated Inc.quote + \$5,000 for a Monitoring System Radio Link)					

Table 31. Rooftop PV sites for MCBH Kaneohe Bay

<i>Location is MCBH Kaneohe Bay, unless noted otherwise</i>							↓ South	Rev: 6/5/2009	6/5/2009	
<b>LOC+ MAP GRID</b>	<b>FAC NO</b>	<b>YEAR BUILT</b>	<b># FLRS</b>	<b>BLDG NAME DESIGN DESC</b>	<b>TOTAL BLDG AREA</b>	<b>APPROX AREA FOR PV</b>	<b>LONG AXIS ORIENTATION</b>	<b>ROOF SUPPORT</b>	<b>CONDITION, REROOF, OR REPAIR</b>	<b>NOTES</b>
H18	101	1941	2	Aircraft Maint Hangar	110,085	93,000	 NNE -SSW	Steel Truss	99%, Reroofed 1988	28 Plastic Dome Skylights
H18	102	1941	2	Aircraft Maint Hangar	106,620	93,000	 NNE -SSW	Steel Truss	74%, Reroofed 1988	32 Plastic Dome Skylights
H17	208	1941	1	Warehouse	27,450	31,000	 NNE -SSW		99%, Reroofed 2001	
H17	209	1941	1	Warehouse	55,840	54,000	 NNE-SSW		81%, Roof Repairs 2007	5 Roofs, HI0403M compl 8/2007
H17	242	1941	1	Admin/Warehouse	20,710	24,866	 NNE -SSW	Wood	81%, Reroofed 2006	

<i>Location is MCBH Kaneohe Bay, unless noted otherwise</i>					↓ South			Rev: 6/5/2009	6/5/2009	
<b>LOC+ MAP GRID</b>	<b>FAC NO</b>	<b>YEAR BUILT</b>	<b># FLRS</b>	<b>BLDG NAME DESIGN DESC</b>	<b>TOTAL BLDG AREA</b>	<b>APPROX AREA FOR PV</b>	<b>LONG AXIS ORIENTATION</b>	<b>ROOF SUPPORT</b>	<b>CONDITION, REROOF, OR REPAIR</b>	<b>NOTES</b>
K16	250	1943	1	Warehouse	47,460	52,700	 NNE -SSW		100%, Reroofed 2005	5 Roofs, HI0106M compl 11/2007
J16	271	1944	1	Warehouse	15,360	16,000	 WNW-ESE			HI0208M- completed 9/2005
K18	373	1943	2	Vehicle Maint Shop	57,775	22,500	 WNW-ESE	Rigid Steel Frame & Purlins	88%, Reroofed 2003	32 FRP skylight panels excludes whse portion
J18	375	1944	2	Aircraft Maint Hangar	62,740	32,700	Various	Steel Truss	MCD- in progress	2 Roofs
G12	1090	1953	1	Exchange Retail	72,650	35,000	Various	Concrete	60%, Reroofed 1988	North, East, and West Roofs

<i>Location is MCBH Kaneohe Bay, unless noted otherwise</i>					↓ South			Rev: 6/5/2009	6/5/2009	
LOC+ MAP GRID	FAC NO	YEAR BUILT	# FLRS	BLDG NAME DESIGN DESC	TOTAL BLDG AREA	APPROX AREA FOR PV	LONG AXIS ORIENTATION	ROOF SUPPORT	CONDITION, REROOF, OR REPAIR	NOTES
G13	1092	1953	1	Warehouse	20,100	22,000	 NW-SE	Concrete	41%, Reroofed 2002	Existing roofing damage not yet repaired as of 2/21/08
96.G12	1404	1973	2	MX Warehouse	37,158	27,600	 NNE -SSW	Rigid Steel Frame & Purlins	38%, HI0502M- Roofing Replacement in progress	
G14	1629	1974	1	Enlisted Club	32,256	25,500	 WNW-ESE	Rigid Steel Frame & Purlins	40%, Original Roof 1974	
H14	1666	1976	1	Bowling Alley	17,040	17,300	 NNW-SSE	?	45%, Reroofed 2000	
J13	3037	1983	1	Gymnasium	32,800	30,000	Various	Rigid Steel Frame & Purlins	81%, New Addition Roof 1998	3 Roofs, 22 FRP Skylight Panels







<i>Location is MCBH Kaneohe Bay, unless noted otherwise</i>					↓ South			Rev: 6/5/2009	6/5/2009	
<b>LOC+ MAP GRID</b>	<b>FAC NO</b>	<b>YEAR BUILT</b>	<b># FLRS</b>	<b>BLDG NAME DESIGN DESC</b>	<b>TOTAL BLDG AREA</b>	<b>APPROX AREA FOR PV</b>	<b>LONG AXIS ORIENTATION</b>	<b>ROOF SUPPORT</b>	<b>CONDITION, REROOF, OR REPAIR</b>	<b>NOTES</b>
L16	4005	1987	1	Warehouse	27,904	33,800	 NW-SE		HI0309M- completed 8/2006	
L17	4075	1987	1	Warehouse	18,880	22,500	 NW-SE			
G11	4088	1987	1	Med Warehouse	37,589	33,600	 NNE -SSW	Rigid Steel Frame & Purlins	94%, Roof Repair 2008	22 FRP Skylight Panels, HI0308M- in progress
J11	6109 & 6477	1996 & 1998	1	Exchange Retail	103,207	78,000	 N-S		97%, Original Roofs	incl Svc Outlet Bldg 6477
					<b>TOTAL PV ROOF AREA</b>	<b>745,066 ft<sup>2</sup></b>			<b>7,451 kW peak</b>	

Table 32. MCBH Kaneohe Bay PV Projects Phased Award Plan

MCB HAWAII PV PROJECT SITES & APPROXIMATE AVAILABLE AREAS FOR EACH TASK ORDER													
LOCATION	FACILITY TYPE	FACILITY NUMBER	TOTAL BLDG AREA	Approx. Building Footprint (SqFt)	AREA FOR PV	EST. PEAK KW		PHASED AWARD PLAN					Historically Sensitive
						THIN FILM PV	CRYSTAL-LINE PV	TO#1	TO#2	TO#3	TO#4	TO#5	
Marines, MCB	BEQ	1604/1632	82 stalls	16,400	16,400	74	164			16,400			
Marines, MCB	BEQ	1634/1635	60 stalls	12,000	12,000	54	120				12,000		
Marines, MCB	BEQ	1655/1656	156 stalls	31,200	31,200	140	312			31,200			
Marines, MCB	Exchange Retail	6109/6477/6088	546 stalls	109,200	109,200	491	1,092		109,200				
Marines, MCB	Exchange Retail	1090	248 stalls	49,600	49,600	223	496			49,600			
Marines, MCB	CSSG-3 Motor Pool	3017	168 stalls	33,600	33,600	151	336		33,600				
Marines, MCB	Gymnasium	3037	104 stalls	20,800	20,800	94	208	20,800					
Marines, MCB	BEQ	5070/5071	54 stalls	10,800	10,800	49	108	10,800					
Marines, MCB	BEQ	221-229, 4009	281 stalls	56,200	56,200	253	562					56,200	YES
Marines, MCB	Theatre	219	142 stalls	28,400	28,400	128	284					28,400	YES
Marines, MCB	Facilities	242	74 stalls	14,800	14,800	67	148	14,800					
Marines, MCB	Facilities Motor Pool	352	72 stalls	14,400	14,400	65	144					14,400	YES
Marines, MCB	3rd Rad Batt Motor Pool	373	75 stalls	15,000	15,000	68	150	15,000					
Marines, MCB	Deployed Veh Parking	370	700 stalls	140,000	140,000	630	1,400				140,000		
Marines, MCB	BOQ	503	80 stalls	16,000	16,000	72	160					16,000	YES
Marines, MCB	Officer's Club	502	61 stalls	12,200	12,200	55	122					12,200	YES
Marines, MCB	Senior Enlisted Club	3088	119 stalls	23,800	23,800	107	238			23,800			
Marines, MCB	Aircraft Maint Hangar	101	110,085	110,085	93,000	419	930				93,000		
Marines, MCB	Aircraft Maint Hangar	102	106,620	106,620	93,000	419	930					93,000	
Marines, MCB	Exchange Retail	6109 & 6477	103,207	103,207	78,000	351	780		78,000				
Marines, MCB	Warehouse	209	55,840	55,840	54,000	243	540				54,000		
Marines, MCB	Warehouse	250	47,460	47,460	52,700	237	527	52,700					
Marines, MCB	Exchange Retail	1090	72,650	72,650	35,000	158	350			35,000			
Marines, MCB	Warehouse	4005	27,904	27,904	33,800	152	338	33,800					
Marines, MCB	Med Warehouse	4088	37,589	37,589	33,600	151	336			33,600			
Marines, MCB	Aircraft Maint Hangar	375	62,740	62,740	32,700	147	327			32,700			
Marines, MCB	Warehouse	208	27,450	27,450	31,000	140	310					31,000	
Marines, MCB	Gymnasium	3037	32,800	32,800	30,000	135	300		30,000				
Marines, MCB	MX Warehouse	1404	37,158	37,158	27,600	124	276		27,600				
Marines, MCB	Enlisted Club	1629	32,256	32,256	25,500	115	255			25,500			
Marines, MCB	Puuloa Training Area	Ground-Mounted			25,000	113	250	25,000					
Marines, MCB	Admin/Warehouse	242	20,710	20,710	24,866	112	249	24,866					
Marines, MCB	Vehicle Maint Shop	373	57,775	57,775	22,500	101	225			22,500			
Marines, MCB	Warehouse	4075	18,880	18,880	22,500	101	225			22,500			
Marines, MCB	Warehouse	1092	20,100	20,100	22,000	99	220	22,000					
Marines, MCB	Bowling Alley	1666	17,040	17,040	17,300	78	173		17,300				
Marines, MCB	Warehouse	271	15,360	15,360	16,000	72	160	16,000					
Marines, MCB	Pearl City Annex	Ground-Mounted			3,000	14	30	3,000					
		Totals			1,377,466	6,199	13,775	238,766	295,700	292,800	299,000	251,200	
		1/5=			275,493	6.7 to 14.8 MW total							

## Appendix D: Wind Resource & Turbine Placement

The data was collected from an anemometer towers installed at 50 meters, Latitude: 21° 26' 32.5" N and Longitude: 157° 44' 16.7" W, elevation 4 meters. Prevailing wind direction is 60-75°. Average annual wind speeds from collected data at two different heights is:

- 80m – 7.08m/s
- 100m-7.21m/s

The average air density for the monitoring period was 1.185 kg/m<sup>3</sup>. This site is characterized by very low shear, with a power law exponent of approximately 0.070, and low turbulence. Turbulence intensity (TI) is essentially a measure of the ‘gustiness’ of the wind, and is defined as the standard deviation of the wind speed divided by the average wind speed for a given measurement period (typically 10 minutes). Simply put, the turbulence intensity measured at this site is relatively low, which allows the use of IEC class IIIA turbines. The Mean TI was measured at 0.078 and representative TI being 0.107, both these are from the IEC 3<sup>rd</sup> revision from 2005 standard.

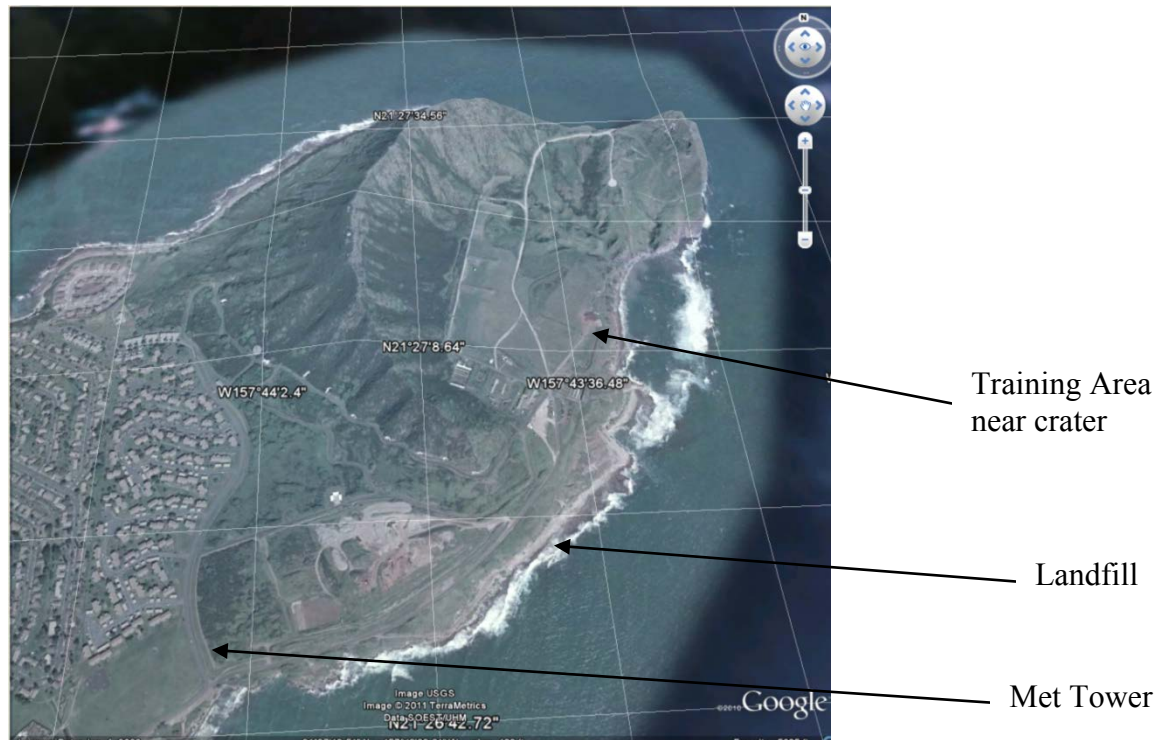


Figure 37. Anemometer placement at N.E tip of MCBH Kaneohe Bay

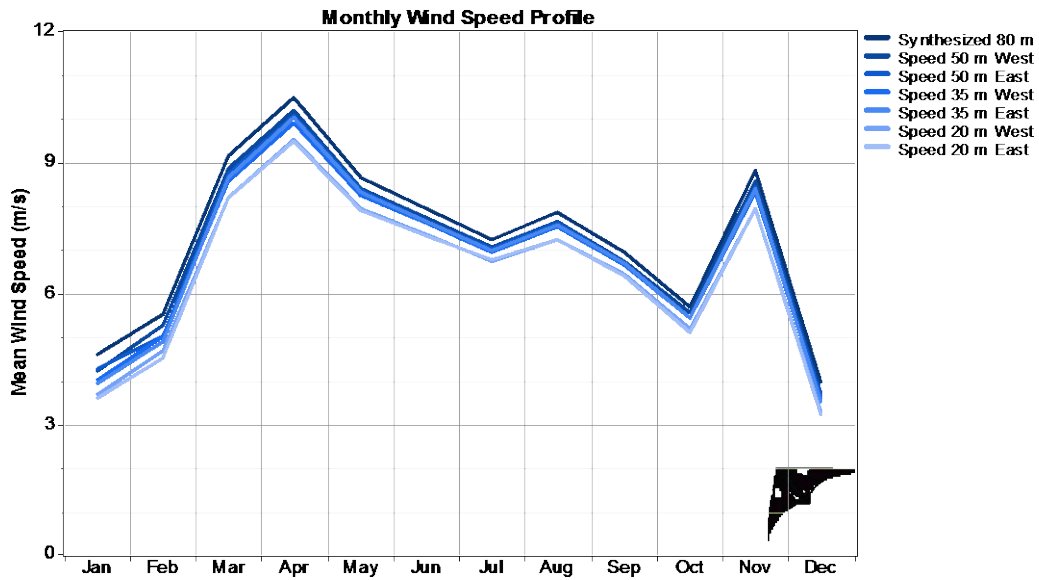


Figure 38. Monthly wind speed profile at MCBH Kaneohe Bay

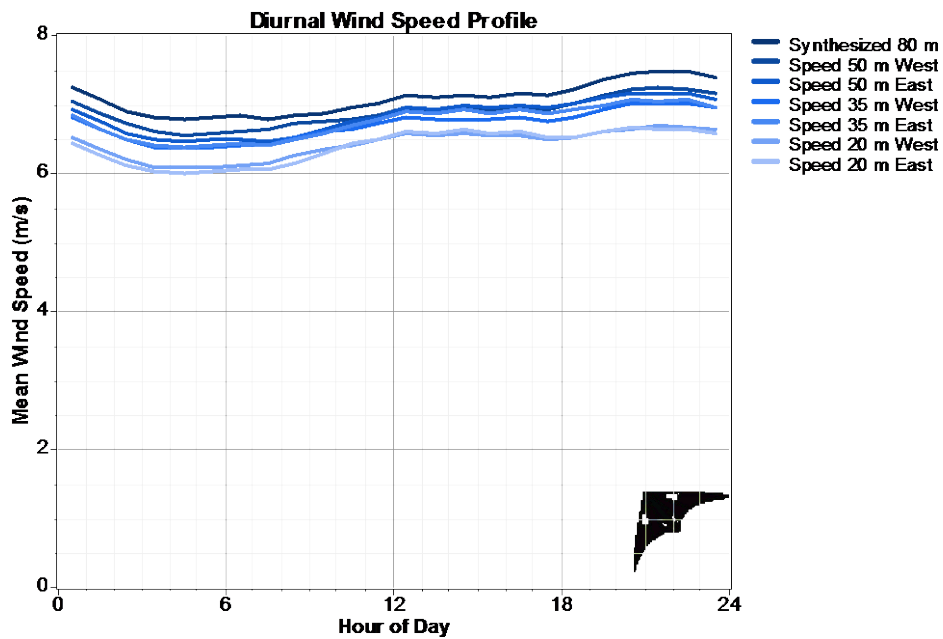
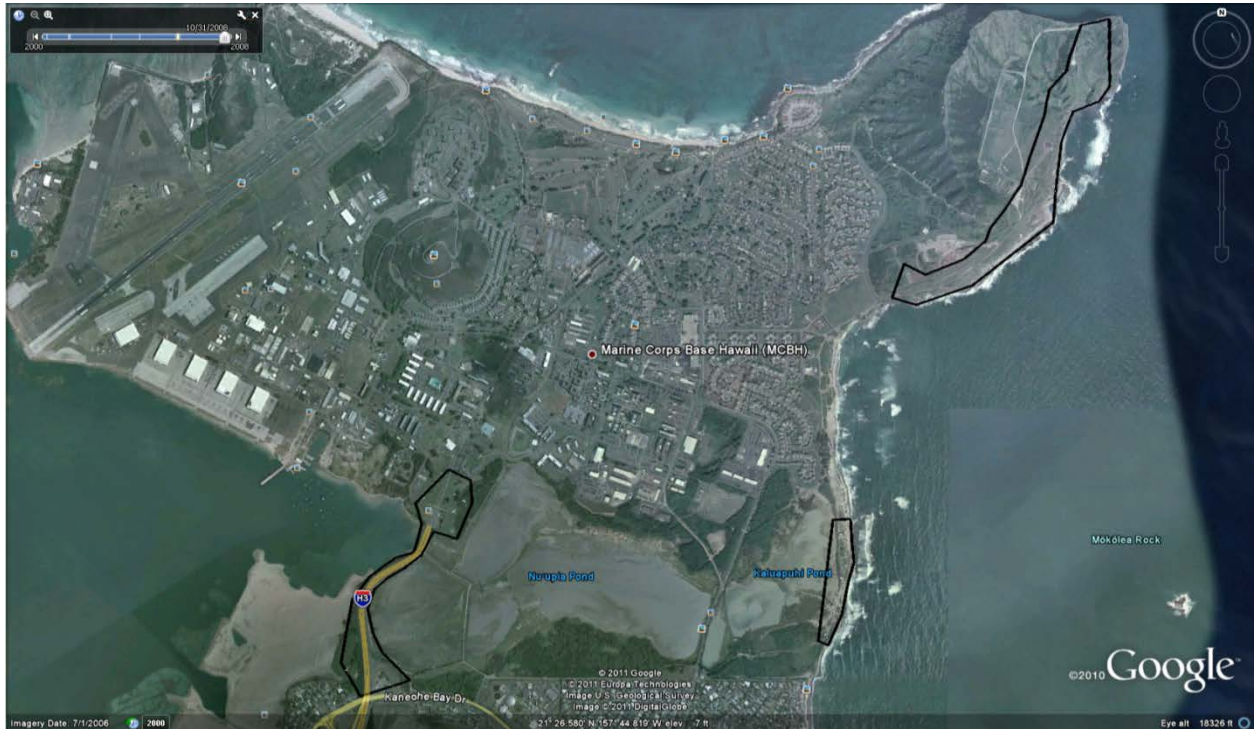


Figure 39. Diurnal wind speed profile

The wind data month of April for 2010 was lost and this plot in Figure 38 does not represent the true monthly variation that will be seen on site. The HOMER model wind resource file was synthesized by using data from May to replace the missing data.

The following figures show wind turbines placed within MCBH Kaneohe Bay on potential sites with good wind resource. The spacing between the turbines assumes 2-3 rotor diameters. The spacing also considers proximity to housing for noise and flicker reasons.



**Figure 40. Potential sites for wind turbines**





Figure 41. Potential wind turbine placement

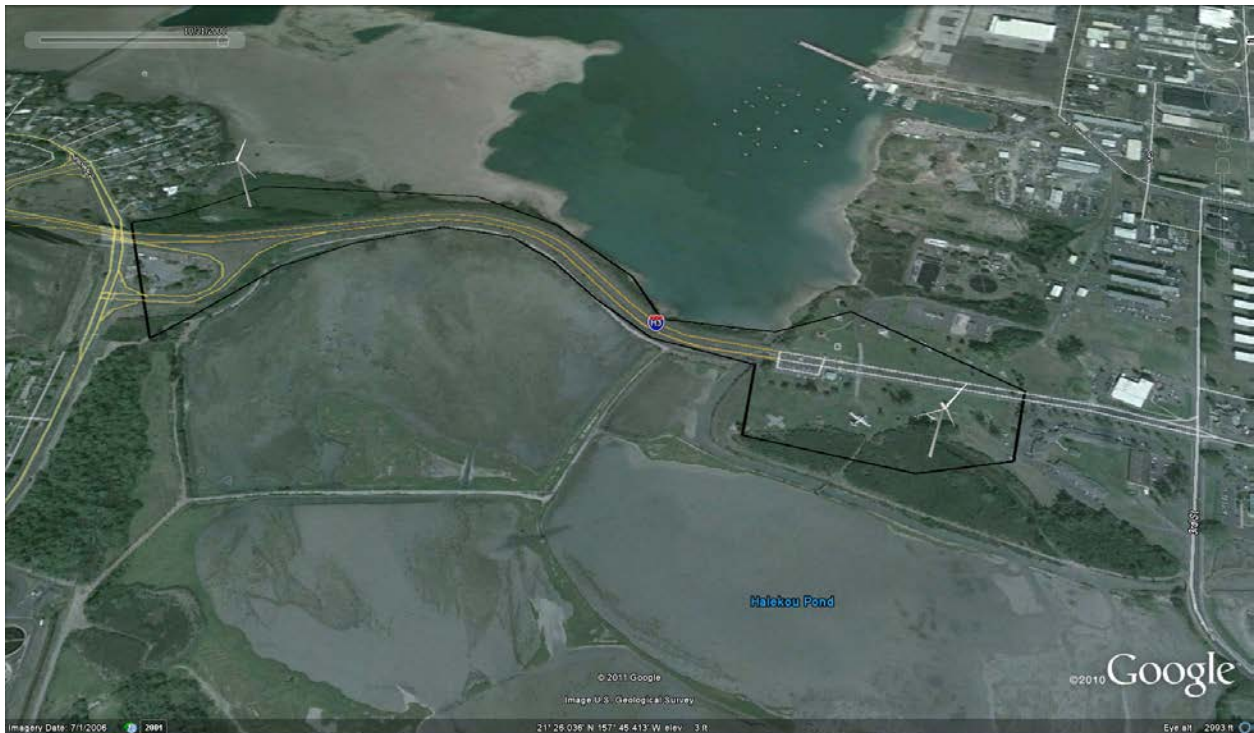
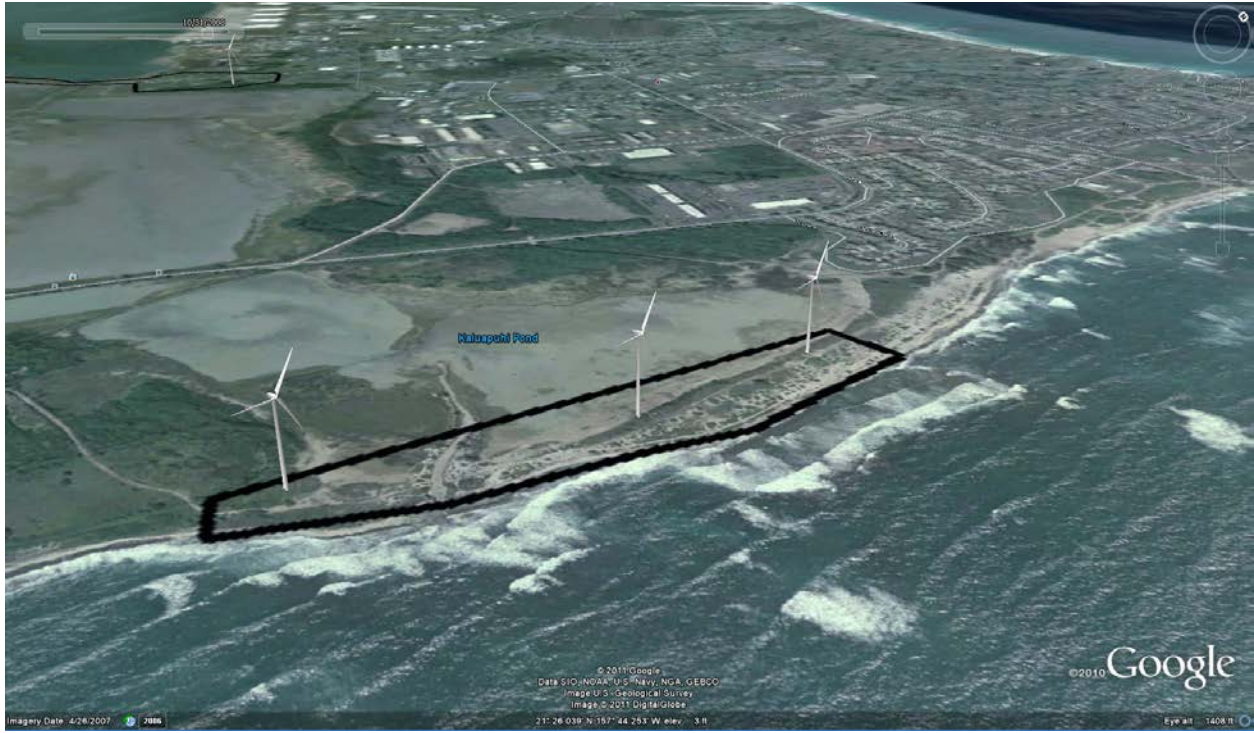


Figure 42. Potential wind turbine placement



**Figure 43. Potential wind turbine placement**

# Appendix E: Distribution Feeder Capacity and Load

## FEEDER CAPACITIES AND LOADS

*6/00*

SUBSTA NO.	FEEDER NO.	FEEDER DESCRIPTION			AMPACITY		MEASURED PEAK DEMAND			
					AMPS	(kVA)	(AMPS)	(kVA)		
I	1A	(2) 3-1/C	500 MCM	CU	EPR	740	14,739	235	4,675	<i>need meter</i>
	101	3-1/C	2/0	CU	XLP	185	3,685	69	1,373	<i>need meter</i>
	104	3-1/C	250 MCM	CU	XLP	260	5,179	102	2,036	
	106	3-1/C	4/0			240	4,780	46	918	
	TIE 1A-2B	3-1/C	500 MCM	CU	XLP	370	7,370			
	TIE 1A-1B	3-1/C	500 MCM			370	7,370			
	1B	(2) 3-1/C	500 MCM	CU	EPR	740	14,739	282	5,613	<i>need meter</i>
	102	3-1/C	2/0	CU	XLP	185	3,685	94	1,873	<i>need meter</i>
	103	3-1/C	2/0	CU	XLP	185	3,685	72	1,439	<i>need meter</i>
	105	3-1/C	250 MCM	CU	XLP	260	5,179	153	3,039	
TIE 1B-3B	3-1/C	500 MCM	CU	EPR	370	7,370				
II	2A	3-1/C	500 MCM	CU	EPR	370	7,370	136	2,707	
	12-1	3-1/C	4/0	CU	XLP	240	4,780	55	1,097	<i>need meter</i>
	12-2A	3-1/C	350 MCM	AL	XLP	245	4,880	21	418	
	12-3	3-1/C	350 MCM	AL	XLP	245	4,880	82	1,624	
	TIE 2A-2B									
	2B	3-1/C	500 MCM	CU	EPR	370	7,370	171	3,398	
	12-2	3-1/C	4/0	CU	XLP	240	4,780	89	1,771	
	12-4	3-1/C	350 MCM	AL	XLP	245	4,880	93	1,850	
	TIE 2B-1A	3-1/C	500 MCM	CU	XLP	370	7,370			
	TIE 2B-3A	3-1/C	500 MCM	CU	EPR	370	7,370			
III	3A	3-1/C	500 MCM	CU	EPR	370	7,370	200	3,984	
	3-1A	3-1/C	4/0	CU	XLP	240	4,780	42	831	
	3-2A	3-1/C	4/0	CU	XLP	240	4,780	93	1,860	
	3-3A	3-1/C	4/0	CU	XLP	240	4,780	7	141	
	3-4A	3-1/C	350 MCM	CU	EPR	310	6,175	14	283	
	TIE 3A-2B	3-1/C	500 MCM	CU	EPR	370	7,370			
	TIE 3A-3B									
	3B	3-1/C	500 MCM	CU	EPR	370	7,370	0?	0?	
	3-1B	3-1/C	4/0	CU	EPR	240	4,780	37	728	
	3-2B	3-1/C	350 MCM	CU	EPR	310	6,175	4	72	
3-3B	3-1/C	4/0	CU	EPR	240	4,780	46	909		
3-4B	3-1/C	350 MCM	CU	EPR	310	6,175	3	56		
TIE 3B-1B	3-1/C	500 MCM	CU	EPR	370	7,370				

fdr cap & loads.xls

**Figure 44. Distribution feeder capacities and load**

Source: MCBH Kaneohe Bay Electrical Study