

# **Technical Assessment of Compressed Hydrogen Storage Tank Systems for Automotive Applications**

---

**Nuclear Engineering Division**

**About Argonne National Laboratory**

Argonne is a U.S. Department of Energy laboratory managed by UChicago Argonne, LLC under contract DE-AC02-06CH11357. The Laboratory's main facility is outside Chicago, at 9700 South Cass Avenue, Argonne, Illinois 60439. For information about Argonne and its pioneering science and technology programs, see [www.anl.gov](http://www.anl.gov).

**Availability of This Report**

This report is available, at no cost, at <http://www.osti.gov/bridge>. It is also available on paper to the U.S. Department of Energy and its contractors, for a processing fee, from:

U.S. Department of Energy

Office of Scientific and Technical Information

P.O. Box 62

Oak Ridge, TN 37831-0062

phone (865) 576-8401

fax (865) 576-5728

[reports@adonis.osti.gov](mailto:reports@adonis.osti.gov)

**Disclaimer**

This report was prepared as an account of work sponsored by an agency of the United States Government. Neither the United States Government nor any agency thereof, nor UChicago Argonne, LLC, nor any of their employees or officers, makes any warranty, express or implied, or assumes any legal liability or responsibility for the accuracy, completeness, or usefulness of any information, apparatus, product, or process disclosed, or represents that its use would not infringe privately owned rights. Reference herein to any specific commercial product, process, or service by trade name, trademark, manufacturer, or otherwise, does not necessarily constitute or imply its endorsement, recommendation, or favoring by the United States Government or any agency thereof. The views and opinions of document authors expressed herein do not necessarily state or reflect those of the United States Government or any agency thereof, Argonne National Laboratory, or UChicago Argonne, LLC.

# Technical Assessment of Compressed Hydrogen Storage Tank Systems for Automotive Applications

---

prepared by

Thanh Hua<sup>1</sup>, Rajesh Ahluwalia<sup>1</sup>, J-K Peng<sup>1</sup>, Matt Kromer<sup>2</sup>, Stephen Lasher<sup>2</sup>,  
Kurtis McKenney<sup>2</sup>, Karen Law<sup>2</sup>, and Jayanti Sinha<sup>2</sup>

<sup>1</sup>Nuclear Engineering Division, Argonne National Laboratory, Argonne, Illinois

<sup>2</sup>TIAX LLC, Lexington, MA

September 2010

## Table of Contents

Abstract.....	6
Introduction.....	7
On-board Assessments.....	8
Performance Model.....	10
Cost Model.....	11
Performance Results for Type IV Single Tank Systems .....	14
Cost Results .....	17
Assessments of Type-III vs. Type-IV Tanks .....	19
Off-board Assessments .....	23
Performance Results .....	24
Cost Results .....	25
Summary and Conclusions .....	26
References.....	31
APPENDIX A: Performance Assessment of Compressed Hydrogen Storage Systems....	32
APPENDIX B: Cost Assessment of Compressed Hydrogen Storage Systems .....	43

## List of Figures

Figure 1: On-board compressed hydrogen storage system schematic .....	8
Figure 2: Base case weight and volume distributions for the compressed hydrogen storage systems .....	15
Figure 3: Gravimetric and volumetric capacities of compressed hydrogen storage systems and their sensitivity to tank empty pressure and carbon fiber translation efficiency ...	16
Figure 4: Base case component cost breakout for the compressed hydrogen storage system.....	17
Figure 5: On-board compressed hydrogen storage for dual tank system.....	20
Figure 6: Comparison of capacities for Type-III and Type-IV tanks, single and dual tank 350-bar storage systems.....	21
Figure 7: Comparison of capacities for Type-III and Type-IV tanks, single and dual tank 700-bar storage system .....	21
Figure 8: Comparison of system cost projections for Type-III and Type-IV tanks, single and dual tank systems, and 350-bar and 700-bar storage.....	22

## List of Tables

Table I: Summary results of the assessment for compressed hydrogen storage systems compared to DOE targets.....	6
Table 1: On-board compressed hydrogen storage system design assumptions .....	9
Table 2: Base case material versus processing cost breakout for compressed hydrogen storage systems .....	18
Table 3: Summary results of the on-board cost assessment for 350 and 700-bar compressed hydrogen storage systems compared to DOE cost targets .....	18
Table 4: Life cycle assumptions for pipeline delivery scenario .....	24
Table 5: Fuel system ownership cost assumptions and results .....	26
Table 6: Summary results of the assessment for compressed hydrogen storage systems .....	27
Table 7: Summary results of the assessment for Type-III and Type-IV single and dual tank compressed hydrogen storage systems.....	30

## **Acknowledgement and Disclaimer**

This report was prepared as an account of work sponsored by an agency of the United States Government. Neither the United States Government nor any agency thereof, nor TIAX LLC, nor any of their employees, makes any warranty, express or implied, or assumes any legal liability or responsibility for the accuracy, completeness, or usefulness of any information, apparatus, product, or process disclosed, or represents that its use would not infringe privately owned rights. Reference herein to any specific commercial product, process, or service by trade name, trademark, manufacturer, or otherwise does not necessarily constitute or imply its endorsement, recommendation or favoring by the United States Government or any agency thereof. The views and opinions of authors expressed herein do not necessarily state or reflect those of the United States Government or any agency thereof.

This report, and the conclusions contained herein, are the result of the exercise of Argonne National Laboratory (Argonne, ANL) and TIAX's professional judgment, based in part upon materials and information provided to us by third parties, which in certain cases, have not been independently verified. Argonne and TIAX accept no duty of care or liability of any kind whatsoever to any third party, and no responsibility for damages, if any, suffered by any third party as a result of decisions made, or not made, or actions taken, or not taken, based on this document, or use of any of the information contained herein. This report may be produced only in its entirety.

The cost analysis for the compressed gas tank systems assumes Year 2009 technology status for individual components, and projects their cost at production volumes of 500,000 vehicles/year. It is not known whether the exact system configuration adopted for this cost analysis currently exists as an integrated automotive hydrogen storage system, or how well the components and subsystems inter-operate with each other. In developing the system configuration and component manifests, we have tried to capture all of the essential engineering components and important cost contributors. However, the system selected for costing does not claim to solve all of the technical challenges facing hydrogen storage transportation systems or satisfy DOE or FreedomCAR on-board hydrogen storage performance, safety, and durability targets.

# Technical Assessment of Compressed Hydrogen Storage Tank Systems for Automotive Applications

T. Q. Hua, R. K. Ahluwalia, and J-K Peng  
Argonne National Laboratory, Argonne, IL 60439

M. Kromer, S. Lasher, K. McKenney, K. Law, and J. Sinha  
TIAX LLC, Lexington, MA 02421

## Abstract

The performance and cost of compressed hydrogen storage tank systems has been assessed and compared to the U.S. Department of Energy (DOE) 2010, 2015, and ultimate targets for automotive applications. The on-board performance and high-volume manufacturing cost were determined for compressed hydrogen tanks with design pressures of 350 bar (~5000 psi) and 700 bar (~10,000 psi) capable of storing 5.6 kg of usable hydrogen. The off-board performance and cost of delivering compressed hydrogen was determined for hydrogen produced by central steam methane reforming (SMR). The main conclusions of the assessment are that the 350-bar compressed storage system has the potential to meet the 2010 and 2015 targets for system gravimetric capacity but will not likely meet any of the system targets for volumetric capacity or cost, given our base case assumptions. The 700-bar compressed storage system has the potential to meet only the 2010 target for system gravimetric capacity and is not likely to meet any of the system targets for volumetric capacity or cost, despite the fact that its volumetric capacity is much higher than that of the 350-bar system. Both the 350-bar and 700-bar systems come close to meeting the Well-to-Tank (WTT) efficiency target, but fall short by about 5%. These results are summarized in Table I below.

**Table I: Summary results of the assessment for compressed hydrogen storage systems compared to DOE targets**

Performance and Cost Metric	Units	350-bar	700-bar	2010 Targets	2015 Targets	Ultimate Targets
System Gravimetric Capacity	wt%	5.5	5.2	4.5	5.5	7.5
System Volumetric Capacity	g-H <sub>2</sub> /L	17.6	26.3	28	40	70
Storage System Cost	\$/kWh	15.4	18.7	4	2	TBD
Fuel Cost	\$/gge*	4.22	4.33	2-3	2-3	2-3
WTT Efficiency (LHV**)	%	56.5	54.2	60	60	60

\*gge: gallon gasoline equivalent

\*\*Lower heating value



## Introduction

The DOE Hydrogen Program sponsored performance and cost assessments of compressed hydrogen storage for automotive applications during 2006–2009, consistent with the Program’s Multiyear Research, Development and Demonstration Plan. This report summarizes the results of these assessments. The results should be considered only in conjunction with the assumptions used in selecting, evaluating, and costing the systems discussed below and in the Appendices.

Compressed hydrogen storage refers to storing hydrogen at high pressures, typically 350 and 700 bar (~5,000 and ~10,000 psi), in a pressure capable vessel. This assessment was based primarily on publicly available information and design schematics of Quantum’s Type IV compressed hydrogen storage tanks, which they manufacture in low-volume production today. The assessment included an independent review of the tank design and technical performance by Argonne National Laboratory (Argonne, ANL) [Hua 2010], an independent cost assessment by TIAX LLC (TIAX) [Kromer 2010], and comments received from the FreedomCAR & Fuel Partnership Hydrogen Storage Technical Team, Quantum, Toray, Structural Composites Inc. (SCI), and other tank developers/manufacturers. We analyzed the compressed hydrogen system for its potential to meet the DOE 2010, 2015, and ultimate hydrogen storage targets for fuel cell and other hydrogen-fueled vehicles. Presentations by Argonne and TIAX describing their analyses in detail are given in Appendices A and B, respectively.

The assessments established the baseline system performance and cost of typical 350- and 700-bar tanks suitable for automotive applications. Results include both “on-board” (i.e., hydrogen storage system required on the vehicle) and “off-board” (i.e., fuel cycle and infrastructure necessary to refuel the on-board storage system) metrics, including:

- On-board Assessments: Performance metrics include the on-board system weight and volume. Cost metrics include the on-board system high-volume (i.e., 500,000 units/year) manufactured cost.
- Off-board Assessments: Performance metrics include the off-board Well-to-Tank (WTT) energy efficiency and greenhouse gas (GHG) emissions. Cost metrics include the refueling costs and combined fuel system “ownership cost” on a \$/mile driven basis.

Results of the assessments are compared to DOE targets for the on-board fuel system gravimetric capacity, volumetric capacity, and system factory cost, as well as the off-board fueling infrastructure energy efficiency, GHG emissions, and refueling cost. Other DOE targets, including on-board system durability/operability, are expected to be met by compressed hydrogen storage systems, so they were not included in these assessments. A summary of the assessment methods and results follows.

## On-board Assessments

We evaluated compressed hydrogen system designs with nominal design pressures of 350 bar and 700 bar, suitable for high-volume manufacturing for automotive applications, in particular hydrogen fuel cell vehicles (FCV). The base case designs assume carbon fiber-resin (CF) composite-wrapped single tank systems, with a high density polyethylene (HDPE) liner (i.e., Type IV tanks) capable of storing 5.6 kg usable hydrogen. Additional analysis of dual tank systems and aluminum lined (i.e., Type III) tanks was also conducted. Significant balance-of-plant (BOP) components include a primary pressure regulator, solenoid control valves, fill tube/port, and pressure gauge/transducer. Additional design assumptions and details are presented in Table 1, and an overall system schematic is presented in Figure 1.

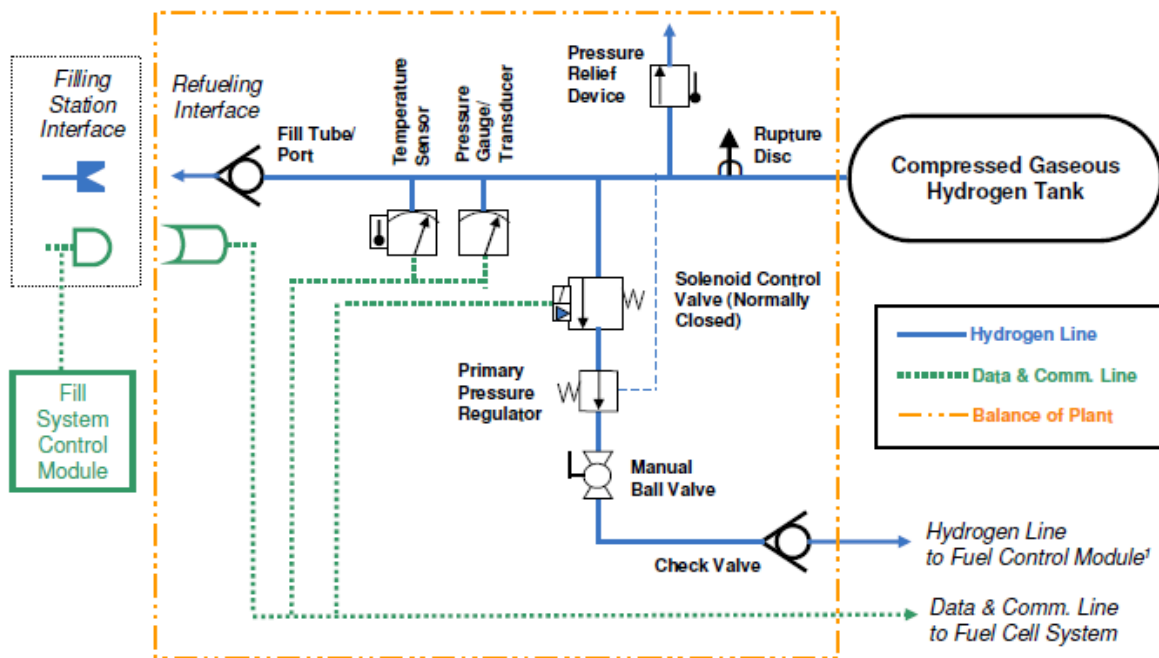

\* Schematic based on the requirements defined in the draft European regulation "Hydrogen Vehicles: On-board Storage Systems" and US Patent 6,041,762.  
<sup>1</sup> Secondary Pressure Regulator located in Fuel Control Module of the Fuel Cell System.

**Figure 1: On-board compressed hydrogen storage system schematic**

The hydrogen storage system analysis assumes Year 2009 technology status for individual components, and projects their performance in a complete system, and their cost at production volumes of 500,000 vehicles/year. In developing the system configuration and component manifest, we tried to capture all of the essential engineering components and important performance and cost contributors. However, the system selected for this assessment does not necessarily solve all of the technical challenges facing hydrogen storage for transportation systems, nor fully satisfy DOE or FreedomCAR on-board hydrogen storage targets.

**Table 1: On-board compressed hydrogen storage system design assumptions**

<b>Design Parameter</b>	<b>Base Case Value</b>	<b>Basis/Comment</b>
<b>Nominal Pressure</b>	350 and 700 bar	Design assumptions based on DOE and industry input
<b>Number of Tanks</b>	Single and Dual	Design assumptions based on DOE and industry input
<b>Tank Liner</b>	Aluminum (Type III) HDPE (Type IV)	Design assumptions based on DOE and industry input
<b>Maximum Filling Pressure</b>	350-bar: 438 bar 700-bar: 875 bar	125% nominal pressure is assumed required for fast fills to prevent under-filling
<b>“Empty” Pressure</b>	20 bar	Discussions with Quantum, 2008
<b>Usable H<sub>2</sub> Storage Capacity</b>	5.6 kg	Design assumption based on drive-cycle modeling for 350 mile range assuming a mid-sized, hydrogen FCV [Ahluwalia 2004 and 2005]
<b>Tank Size (water capacity)</b>	350-bar: 258 L 700-bar: 149 L	Calculated based on Benedict-Webb-Rubin equation of state for 5.6 kg usable H <sub>2</sub> capacity and 20 bar “empty pressure” (6.0 and 5.8 kg total H <sub>2</sub> capacity for 350-bar and 700-bar tanks, respectively)
<b>Safety Factor</b>	2.25	Industry standard criteria (e.g., ISO/TS 15869) applied to nominal storage pressure (i.e., 350 bar and 700 bar)
<b>Length/Diameter Ratio</b>	3.0	Discussions with Quantum, 2008; based on the outside of the CF wrapped tank
<b>Carbon Fiber (CF) Type</b>	Toray T700S	Discussions with Quantum and other developers, 2008
<b>CF Composite Tensile Strength</b>	2,550 MPa	Toray material data sheet for 60% fiber by volume
<b>Adjustment for CF Quality</b>	10%	Reduction in average tensile strength to account for variance in CF quality, based on discussion with Quantum and other developers, 2010
<b>CF Translation Efficiency</b>	350-bar: 82.5% 700-bar: 80.0%	Assumption based on data and discussions with Quantum, 2004-09
<b>Tank Liner Thickness</b>	5 mm HDPE (Type IV) 7.4 mm Al (Type III, 350-bar) 12.1 mm Al (Type III, 700-bar)	Discussions with Quantum for Type IV tanks, 2008; ANL calculations for Type III tanks
<b>Liner Cycle Life</b>	5500 cycles	SAE J 2579
<b>Overwrap</b>	1 mm glass fiber	Discussions with Quantum, 2008; common but not functionally required
<b>Protective End Caps</b>	10 mm foam	Discussions with Quantum, 2008; for impact protection

## Performance Model

Working with Quantum, we set up a design and performance model of a Type IV compressed tank system. Developing such a model enabled us to scale the tank system design to different sizes, for example, for providing 5.6 kg of usable hydrogen rather than the smaller sizes typical in current designs for demonstration hydrogen FCVs. We used the Benedict-Webb-Rubin equation of state to calculate the amount of stored H<sub>2</sub> for 5.6 kg of recoverable H<sub>2</sub> at 20-bar minimum delivery pressure. The model used a netting analysis algorithm to determine the optimal dome shape with a geodesic winding pattern, and to determine the thickness of the geodesic and hoop windings in the cylindrical section for specified maximum storage pressure and length-to-diameter ratio (L/D). Our model was validated by comparing the computed CF weights and volumes with Quantum's analysis and data. The agreement was within 1% for the 350-bar tank, and within 10% for the 700-bar tank.

Filament winding is one of the most popular and affordable techniques for high performance composite structures, such as pressure vessels, fuel tanks, pipes and rocket motor cases. However, winding patterns vary, depending on the manufacturing process, fiber layout, machine accuracy, and cost [Lee 1993]. Since filament-wound composite pressure vessels are prone to fail in their dome sections, the design of the dome is critical to their structural stability. For given length-to-diameter (L/D) and boss opening-to-diameter ratios, the optimal dome shape was generated using geodesic winding in accordance with Vasiliev and Morozov [2001]. Geodesic winding involves having the fiber filaments wound along the isotenoids. In the cylindrical section, the filament paths include both geodesic and hoop windings. In calculating the carbon fiber composite thickness, the model applied a safety factor of 2.25 and a translation efficiency of 82.5% and 82.0% [Liu 2009] to the tensile strength of the composite (2,550 MPa) for the 350- and 700-bar systems, respectively. Based on recent data and feedback from tank developers [Newhouse 2010], we reduced the CF strength in our analyses by 10% to account for the variability in CF quality at high-volume manufacturing. Our on-board performance results include sensitivity analyses that cover a range of translation efficiencies for both the 350- and 700-bar systems.

Beyond the main tank assembly, the model included balance-of-plant (BOP) components shown in Figure 1. The weight (~19 kg) and volume (~6 L) of BOP components were estimated from commercial sources and were the same for the 350- and 700-bar systems.

In addition to the performance model for Type IV single tank systems that formed the initial scope of our analysis, we expanded our physical storage model to include the effects of autofrettage on the fatigue life of metal liners (aluminum) in Type III pressure vessels, and on the load distribution between the liner and the carbon fiber (CF). We modeled the autofrettage process applied to composite tanks for service at ambient and cryogenic temperatures. For service at ambient temperatures we determined the induced residual compressive stresses in the metal liner and tensile stresses in the CF. We used the model to determine the liner and CF thicknesses to meet the target life of 5500 pressure cycles at 25% over the nominal working pressure [SAE J2579, SAE International, 2009].

## Cost Model

We applied a proprietary technology-costing methodology that has been customized to analyze and quantify the processes used in the manufacture of hydrogen storage tanks and BOP components. The bottom-up, activities-based, cost model is used in conjunction with the conventional Boothroyd-Dewhurst Design for Manufacturing & Assembly (DFMA®) software. The model was used to develop costs for all the major tank components, balance-of-tank, tank assembly, and system assembly. The DFMA® concurrent costing software was used to develop bottom-up costs for other BOP components. Bottom-up costing refers to developing a manufacturing cost of a component based on:

- Technology Assessment – Seek developer input, conduct literature and patent reviews.
- Cost Model Development – Define manufacturing process unit operations, specify equipment, obtain cost of raw materials and capital equipment, define labor rates, building cost, utilities' cost, tooling cost, and cost of operating & non-operating capital with appropriate financial assumptions:
  - Fixed Operating Costs include Tooling & Fixtures Amortization, Equipment Maintenance, Indirect Labor, and Cost of Operating Capital.
  - Fixed Non-Operating Costs include Equipment & Building Depreciation, Cost of Non-Operating Capital.
  - Variable Costs include Manufactured Materials, Purchased Materials, Direct Labor (Fabrication & Assembly), Indirect Materials, and Utilities.
- Model Refinement – Seek developer and stakeholder feedback, perform single-variable sensitivity and multi-variable Monte Carlo analyses.

We contacted developers/vendors, and performed a literature and patent search to explicate the component parts, specifications, material types and manufacturing processes. Subsequently, we documented the bill-of-materials (BOM) based on the system performance modeling, determined material costs at the assumed production volume, developed process flow charts, and identified appropriate manufacturing equipment. We also performed single-variable and multi-variable (Monte Carlo) sensitivity analyses to identify the major cost drivers and the impact of material price and process assumptions on the high-volume hydrogen storage system cost results. Finally, we solicited developer and stakeholder feedback on the key performance assumptions, process parameters, and material cost assumptions; and we calibrated the cost model using this feedback. A brief discussion of the key performance, process, and cost assumptions is presented below.

### *Performance Parameters*

Key performance assumptions such as those presented in Table 1 were developed based on modeling and data from Quantum's Type IV tank design. We used sensitivity analyses to capture the impact of variation in key performance assumptions including tank safety factor, composite tensile strength, and translation efficiency.

### *Carbon Fiber Price*

The cost of carbon fiber is a significant factor in all high-pressure systems. In order to maintain a common basis of comparison with previous cost analyses, we chose a base case carbon fiber price of \$13/lb (\$28.6/kg) based on discussions with Toray in 2007 regarding the price of T700S

fiber at high volumes. Carbon fiber is already produced at very high-volumes for the aerospace and other industries, so it isn't expected to become significantly less expensive in the near term. However, there are DOE programs that are investigating ways to significantly reduce carbon fiber costs (e.g., Abdallah 2004). We used sensitivity analyses to capture the impact of the uncertainty in carbon fiber prices, using \$10/lb at the low end and \$16/lb at the high end.

We assumed the hydrogen storage system manufacturer purchases pre-impregnated (referred to as "prepreg") carbon fiber composite at a price that is 1.27 times (prepreg/fiber cost ratio) the cost of the raw carbon fiber material [Du Vall 2001]. An alternative approach would be to assume a wet resin winding process that would allow the purchase of raw carbon fiber material instead of buying prepreg tow fiber. We chose a prepreg winding process, based on the assumption that this process results in greater product throughput and reduced environmental hazards (including VOCs, ODCs, and GHG emissions) compared to a wet winding process. According to Du Vall, greater throughput is typically achieved because prepreg tow allows for more precise control of resin content, yielding less variability in the cured part's mechanical properties and ensuring a more consistent, reproducible, and controllable material, compared to wet winding. In addition, wet winding delivery speeds are limited due to the time required to achieve good fiber/resin wet out. The downside is that the prepreg raw material costs are higher than for wet winding. But, when all aspects of the finished product cost are considered (i.e., labor, raw materials, throughput, scrap, downtime for cleanup, and costs associated with being environmentally compliant), Du Vall found that prepreg materials provided an economic advantage compared to wet winding for high-volume production of Type II and IV compressed natural gas (CNG) tanks.

It might be possible to reduce the overall manufactured cost of the CF composite, perhaps closer to the cost per pound of the carbon fiber itself (\$13/lb) or even lower (since the resin is less expensive per pound), if the wet winding process is proven to be more effective, in particular, if wet winding throughputs are increased. However, the detailed evaluation that is required to explore these cost trade-offs was beyond the current scope of work. Instead, we address the potential impact of significantly lower carbon fiber composite costs by the sensitivity analysis.

### *BOP Cost Projections*

BOP costs were estimated using the Delphi method, with validation from top-down and bottom-up estimates described below (see Appendix B for details for each cost estimation approach).

- Delphi Method: Projections solicited from industry experts, including suppliers, tank developers, and end users.
  - End users (e.g., automotive OEMs) and, to some extent, tank developers, are already considering the issues of automotive scale production volumes.
  - In some cases, end-user or developer estimates are too low or based on unreasonable targets; in other cases estimates may be too high due to not taking into account process or technology developments that would be required for automotive-scale production volumes.
  - We used our judgment of the projections and results from top-down and bottom-up estimations (see below) to select a reasonable base case cost for each component.

- Top-Down: High-volume discounts applied to low-volume vendor quotes using progress ratios (PR).
  - Provides a consistent way to discount low-volume quotes.
  - Attempts to take into account process or technology developments that would be required for automotive-scale production volumes.
  - Requires an understanding of current base costs, production volumes, and markups.
- Bottom-Up: Cost Modeling using DFMA® software.
  - Calculates component costs using material, machining, and assembly costs, plus an assumed 15% markup for component supplier overhead and profit.
  - May not be done at the level of detail necessary for estimating the true high-volume manufactured cost of the component.

### *Vertically Integrated Process vs. Outsourcing of Tank Components*

In reporting the “Factory Cost” or “Manufactured Cost” of the hydrogen storage system, we have assumed a vertically integrated tank manufacturing process; i.e., we assumed that the automotive OEM or car company makes all the tank components in-house. Therefore, intermediate supply chain markups are not included for individual tank components. The major tank costs (liner, carbon fiber layer, and tank assembly) are "bottom-up" estimated, and reported with no added supplier markup. In practice, the manufacturing process is likely to be a combination of horizontally (procured) and vertically (manufactured in-house) steps, with appropriate markups.

### *Markup of BOP Components*

In our model, some major BOP costs (e.g., fill tube/port, pressure regulator, pressure relief valve) are "bottom-up" estimated as well (similar to the major tank costs). Since we assume that the automotive OEM buys all the BOP components/subsystems from suppliers, and assembles the overall system in-house, we assume a uniform supplier-to-automotive OEM markup of 15% for all major BOP components. Raw materials and some BOP hardware are purchased and implicitly include (an unknown) markup. We assume that supplier markup includes cost elements for:

- Profit
- Sales (Transportation) & Marketing
- R&D - Research & Development
- G&A - General & Administration (Human Resources, Accounting, Purchasing, Legal, and Contracting), Retirement, Health
- Warranty
- Taxes

Based on discussions with industry, we learned that automotive Tier 1 suppliers would most likely not have any Sales & Marketing expense since they often have guaranteed 5-year supply contracts with the OEMs. Also, the warranty and R&D cost is increasingly being shared by the supplier and the OEM. (Previously, the OEM covered the warranty costs themselves; now the supplier supports their own warranty; furthermore, the OEMs share in some of the R&D costs). The OEMs usually negotiate 5% per year cost reduction for 5 years with the supplier, further squeezing the supplier's margin. Therefore, currently, profit margins for Tier 1 suppliers are typically only in the single-digits (perhaps 5–8%), with a 15% markup being rare. We address

these markup uncertainties and other BOP component cost uncertainties by the sensitivity analyses.<sup>1</sup>

### *Tank QC and System QC*

At the high production volume of 500,000 units/year, we have assumed that the hydrogen storage system production process is mature and that all quality issues are “learned out”. We have included only rudimentary tank and system Quality Control (QC) such as leak tests and visual and ultrasonic inspections.

### *Process Yield, Material Scrap and Reject Rate*

The cost models include assumptions about Process Yield (i.e., the percentage of acceptable parts out of the total parts that are produced), Material Scrap Rate (i.e., the recyclable left-over material out of the total materials used in the process), and Reject Rate (i.e., the percentage of unacceptable parts out of the total parts that are produced) based on experience from similar manufacturing processes at high-volumes. An appropriate material scrap credit is applied to the left-over material; however, the material recycling process was not included in the scope of our analysis. We address the impacts of uncertainties in these assumptions by the sensitivity analyses.

### *Other Technical Issues*

The goal of this assessment was to capture the major cost contributions to the overall hydrogen storage system cost. The system chosen for assessment does not necessarily solve all of the technical issues facing developers today. For example, the costs of added vehicle controls required to operate the storage system are not included, nor are the costs of hydrogen leak detection sensors and controls included. These BOP components are not expected to make a significant contribution to the total storage system cost at present; however, if the costs of the tank and major BOP components decrease significantly, the balance of the system may represent a larger proportion of the total system cost in the future.

## **Performance Results for Type IV Single Tank Systems**

The results of the performance analyses indicate that both the 350- and the 700-bar base case systems exceed the DOE 2010 gravimetric target of 4.5 wt%,<sup>2</sup> and that the 350-bar system also meets the 2015 target of 5.5 wt%. The gravimetric capacity of the 700-bar system is about 24% lower than the 2015 target, however, despite the intrinsically higher density of the stored hydrogen, due to the weight of the additional CF composite required to withstand the higher pressure (25.9-mm thick CF layer for the 700-bar tank versus 14.7 mm for the 350-bar tank). Further, the volumetric capacities of the two systems are 6 and 37% lower than the DOE 2010 target of 28 g H<sub>2</sub>/L and 34 and 56% lower than the DOE 2015 target of 40 g H<sub>2</sub>/L for the 700-bar and 350-bar systems, respectively. Indeed, the density of the compressed hydrogen gas by itself at these pressures (and room temperature) makes it impossible to meet the 2015 volumetric target. Neither system is projected to be able to meet the ultimate DOE gravimetric or volumetric

---

<sup>1</sup> The supplier markup does not include the markup for the hydrogen storage system manufacturer (e.g. automotive OEM) that sells the final assembled system.

<sup>2</sup> Wt% is defined here as the weight of usable hydrogen (i.e., 5.6 kg) divided by total tank system weight.



capacity targets of 7.5 wt% and 70 g/L. These results are summarized in Table I. Detailed performance results are given in Appendix A.

The weight and volume distributions are shown in Figure 2 for the two base case scenarios. For the 350-bar tank system, the carbon fiber accounts for 53% of the total system weight and 10% of the system volume. Other contributors to the system weight are the liner (11%), glass fiber (6%), foam (5%), H<sub>2</sub> (6%), and BOP (19%). The largest contributor to the 350-bar tank system volume is the stored H<sub>2</sub> (81%), with less than 5% each of the liner, foam, glass fiber, and the BOP. For the 700-bar tank system, the carbon fiber accounts for 62% of the system weight, BOP 17%, liner 7%, with the H<sub>2</sub>, foam, and glass fiber each accounting for 5% or less of the total system weight; the two major contributors to the system volume are the stored H<sub>2</sub> (70%) and the carbon fiber (20%), with 4% or less of liner, foam, glass fiber, and the BOP.

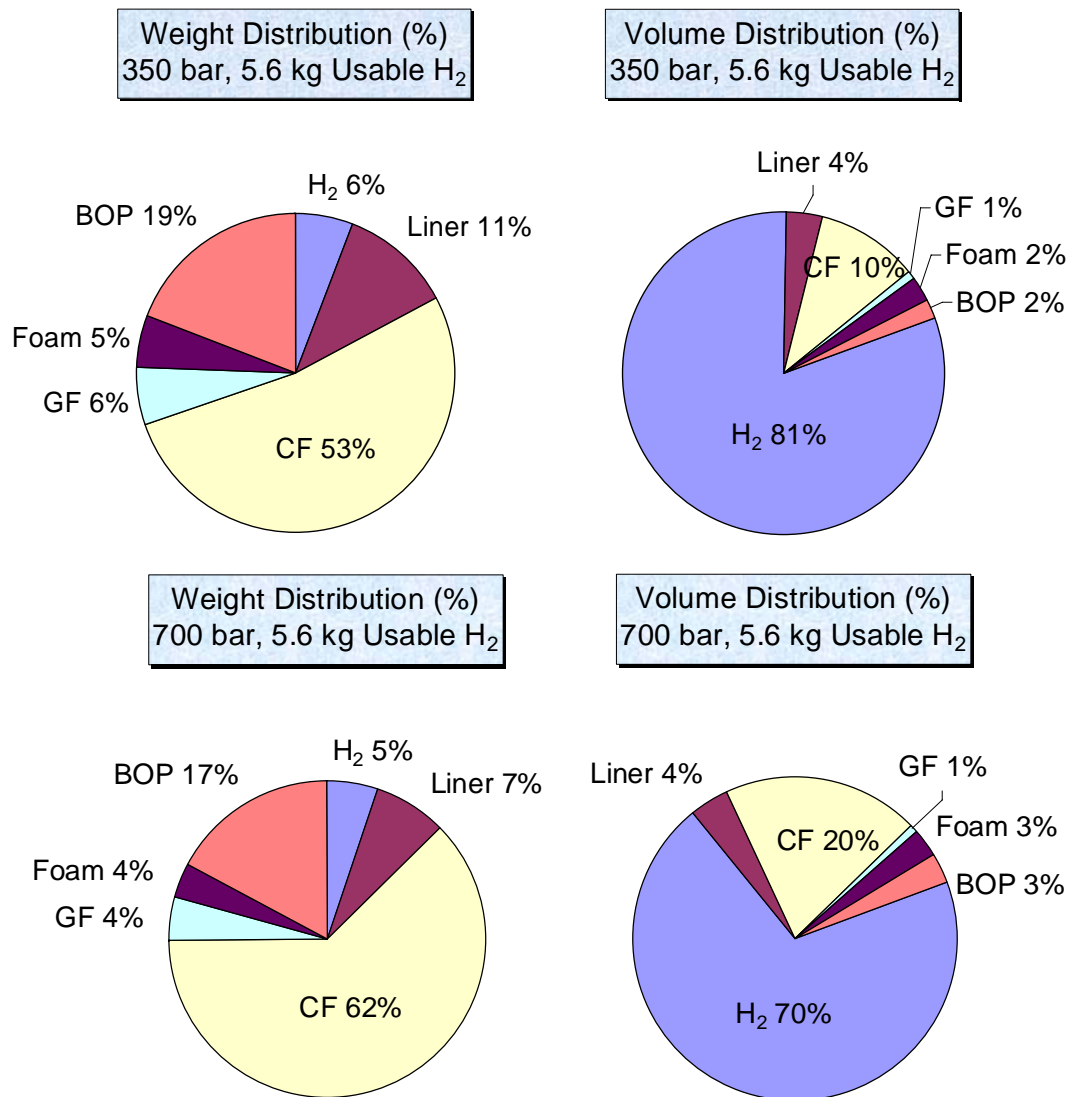

**Figure 2: Base case weight and volume distributions for the compressed hydrogen storage systems**

As shown in Figure 3, the gravimetric capacity of the 350-bar system is 5.5 wt%, which increases to 5.8 wt% if the design “empty” pressure is reduced to 3 bar (~45 psia) and to 5.7 wt% if the CF translation efficiency improves to 90% with assumed advances in filament winding technology. The gravimetric capacity for the 350-bar system with 20-bar empty pressure approaches 6.0 wt% if the CF translation efficiency reaches the ultimate, or theoretical, value of 100%. The gravimetric capacity of the base case 700-bar system is 5.2 wt%, which increases to 5.3 wt% if the “empty” pressure is reduced to 3 bar (~45 psia) and to 5.6 wt% if the CF translation efficiency is increased to 90%. The gravimetric capacity for the 700-bar system with 20-bar empty pressure approaches 5.9 wt% if the CF translation efficiency reaches 100%. Varying other design parameters, such as the tank length-to-diameter ratio to between 2 and 4, has relatively little effect (~0.1 wt %) on the gravimetric capacity of the two systems.

For the base case conditions, the stored hydrogen accounts for about 81% of the total volume of the 350-bar system, and for about 70% of the total volume of the 700-bar system. As shown in Figure 3, reducing the empty pressure from 20 bar to 3 bar increases the volumetric capacity from 17.6 to 18.6 g-H<sub>2</sub>/L for the 350-bar system and from 26.3 to 27.2 g-H<sub>2</sub>/L for the 700-bar system. Improving the winding process to obtain 90% CF translation efficiency increases the volumetric capacity from 17.6 to 17.7 g-H<sub>2</sub>/L for the 350-bar system and from 26.3 to 26.9 g-H<sub>2</sub>/L for the 700-bar system. The volumetric capacity assuming 100% CF translation efficiency approaches 17.8 g-H<sub>2</sub>/L for the 350-bar system and 27.5 g-H<sub>2</sub>/L for the 700-bar system. Varying other performance assumptions, such as the tank length-to-diameter ratio, has only a small effect on the volumetric capacity of the systems.

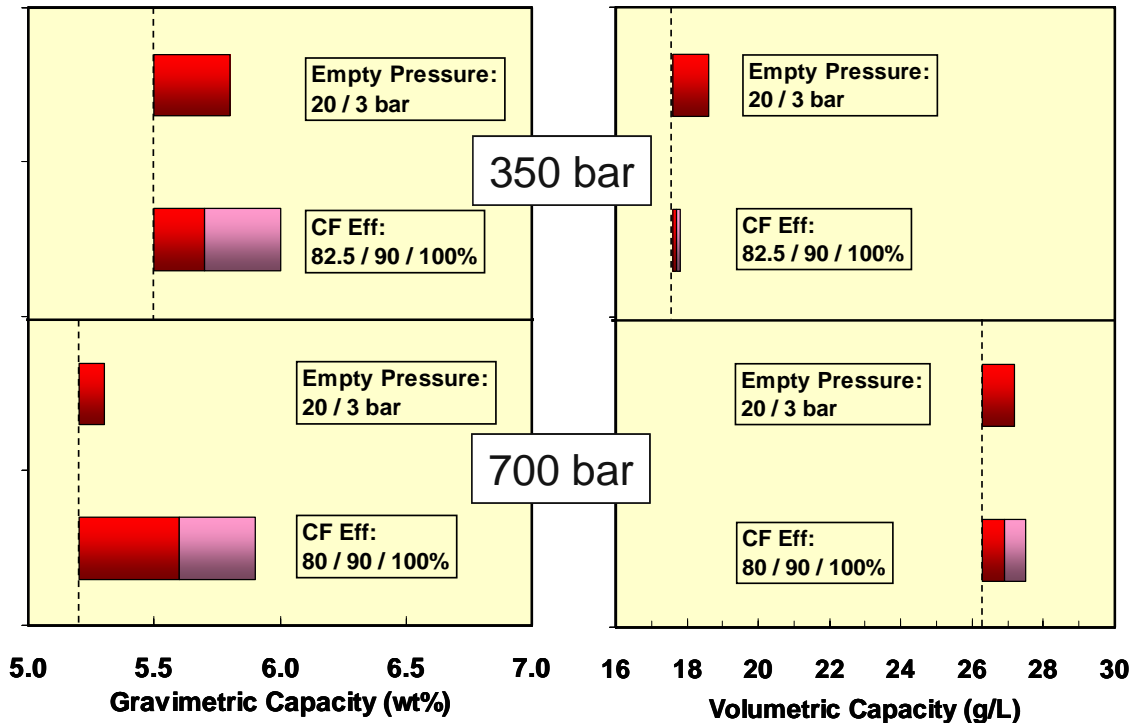

Figure 3: Gravimetric and volumetric capacities of compressed hydrogen storage systems, and their sensitivity to tank empty pressure and carbon fiber translation efficiency.

## Cost Results

We evaluated the costs of compressed 350- and 700-bar onboard storage systems for Type III and Type IV pressure vessels, and for single- and dual-tank configurations. Our cost assessment projects that the 350- and 700-bar on-board storage systems will cost 4–5 times the DOE 2010 cost target of \$4/kWh, even at high production volumes. Dual-tank systems are projected to cost on about \$0.5/kWh more than single-tank systems. Type III tanks are projected to cost \$1.2 to \$2.2/kWh more than Type IV tanks for the 350-bar and 700-bar tanks, respectively. The discussion in the following paragraphs focuses primarily on Type IV, single-tank systems; additional discussion of the Type III and dual-tank systems is included near the end.

As seen in Figure 4, the main cost contributor to single-tank Type IV systems is the carbon fiber composite layer, which accounts for approximately 75% and 80% of the base case 350- and 700-bar system costs, respectively.

As shown in Table 2, processing cost makes up just 5% of the total system cost due to the assumed high production volumes and number of purchased components. This processing cost fraction is low, compared to the current cost to manufacture similar tanks systems. Manufacturing a compressed tank today using relatively low-volume production techniques requires more complex and labor intensive processes due to the high-pressure requirement (i.e., carbon fiber wrapped tank). There is uncertainty and disagreement among different developers and automotive OEMs about the level of automation that can be achieved in the future, but we have assumed that substantial cost savings would occur with economies of scale, once high production volumes are achieved over a sustained period of time. Similarly, we have assumed BOP component costs would be much lower than today’s vendor quotes for similar components at the current low volumes of manufacture (see Appendix B for details).

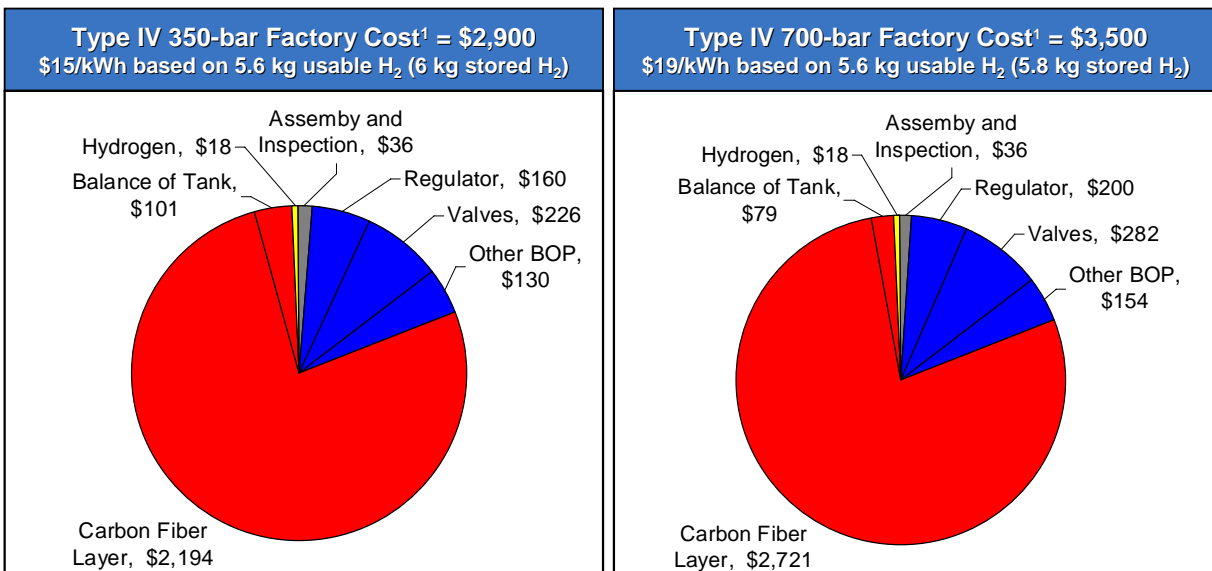

<sup>1</sup> Cost estimate in 2005 USD. Includes processing costs.

**Figure 4: Base case component cost breakout for the compressed hydrogen storage systems.**

**Table 2: Base case material versus processing cost breakout for compressed hydrogen storage systems**

On-board System Cost Breakout – Compressed Gas	Type IV 350-bar Base Case			Type IV 700-bar Base Case		
	Material, \$	Processing, \$	Processing Fraction	Material, \$	Processing, \$	Processing Fraction
Hydrogen	\$18	(purchased)	-	\$18	(purchased)	-
Compressed Vessel	\$2,193	\$102	4%	\$2,681	\$119	4%
<i>Liner &amp; Fittings</i>	\$20	\$11	34%	\$14	\$10	43%
<i>Carbon Fiber Layer</i>	\$2,111	\$83	4%	\$2,619	\$102	4%
<i>Glass Fiber Layer</i>	\$30	\$7	18%	\$23	\$6	21%
<i>Foam</i>	\$32	\$2	5%	\$25	\$1	5%
Regulator	\$160	(purchased)	-	\$200	(purchased)	-
Valves	\$226	(purchased)	-	\$282	(purchased)	-
Other BOP	\$130	(purchased)	-	\$155	(purchased)	-
Final Assembly & Inspection	-	\$36	-	-	\$36	-
<b>Total Factory Cost</b>	<b>\$2,727</b>	<b>\$138</b>	<b>5%</b>	<b>\$3,334</b>	<b>\$156</b>	<b>4%</b>

Single-variable sensitivity analyses were performed by varying one parameter at a time, while holding all others constant. We varied the overall manufacturing assumptions, economic assumptions, key performance parameters, direct material cost, capital equipment cost, and process cycle time for individual components. According to the single variable sensitivity analysis results, the range of uncertainty for the tank’s carbon fiber purchased cost and safety factor assumptions have the biggest impact on the total system cost projections (i.e., sensitivity results for these assumptions are roughly 15–20% of the total system cost each).

Multi-variable (Monte Carlo) sensitivity analyses were performed by varying all the parameters simultaneously, over a specified number of trials, to determine a probability distribution of the cost. We assumed a triangular Probability Distribution Function (PDF) for the parameters, with the “high” and “low” values of the parameter corresponding to a minimum probability of occurrence, and the base case value of the parameter corresponding to a maximum probability of occurrence. The parameters and ranges of values considered were the same as for the single-variable sensitivity analysis. According to the multi-variable sensitivity analysis results, the system factory cost will likely range between \$10.6 and \$19.7/kWh for the 350-bar system and between \$13.5 and \$27.2/kWh for the 700-bar system.<sup>3</sup> These results are compared to DOE cost targets in Table 3. Detailed assumptions and results are given in Appendix B.

**Table 3: Summary results of the on-board cost assessment for 350- and 700-bar compressed hydrogen storage systems compared to DOE cost targets**

Cost Projections, \$/kWh	350-bar System	700-bar System	2010 Target	2015 Target
High	19.7	27.2	4	2
Base Case	15.4	18.7		
Low	10.6	13.5		

<sup>3</sup> Range is defined here as the 95% confidence interval based on the data fit for the sensitivity analyses.

These costs compare well to industry factory cost projections for similarly sized tanks at lower production volumes.<sup>4</sup> Industry factory cost projections for medium-volume manufacturing (i.e., 1,000 units per year) range from \$45–55/kWh for 350-bar tank systems and \$55–65/kWh for 700-bar tank systems without valves and regulators. Removing valve and regulator costs from the base case cost projections results in a high-volume (500,000 units per year) factory cost of \$13/kWh and \$16/kWh for 350-bar and 700-bar tank systems, respectively. These results compare well to the lower-volume industry projections assuming progress ratios of 85–90%.<sup>5</sup> While this progress ratio range is reasonable, it is perhaps a bit on the high end of what would be expected (progress ratios of 60-90% are typical) due to carbon fiber representing such a large fraction of the overall system cost. Unlike other system components, carbon fiber is already produced at high volumes for the aerospace and other industries, so it is not expected to become significantly less expensive due to the typical learning curves assumed by projections based on progress ratios.<sup>6</sup>

### **Assessment of Type III Tanks and Dual-Tank Systems**

In addition to the performance and cost projections for Type IV, single tank systems that formed the initial scope of our analyses, we conducted analyses of Type III (aluminum-lined) tanks and of dual-tank systems. These two alternative configurations offer several potentially attractive characteristics:

- Dual-tank systems offer packaging flexibility compared to single-tank systems, which has the potential to mitigate issues associated with the relatively large footprint of compressed gas hydrogen storage systems.
- Type III tanks may offer cost and volume advantages compared to Type IV tanks, because the aluminum liner can support a portion of the pressure load, thereby reducing the amount of carbon fiber required.

We assumed that the dual-tank system design utilizes a single balance-of-plant subsystem (see Figure 5). This assumption is not consistent with current CNG dual-tank designs, in which two redundant balance-of-plant subsystems are typically employed. However, it was assumed that future high volume systems would likely employ the simpler design used in this analysis

---

<sup>4</sup> Industry projections are for 100–120 liter water capacity tanks versus 149–258 liter water capacity tank designs evaluated here.

<sup>5</sup> The progress ratio (pr) is defined by speed of learning (e.g., how much costs decline for every doubling of capacity).

<sup>6</sup> However, there are DOE programs that are looking at ways to significantly decrease carbon fiber costs [Abdallah 2004].

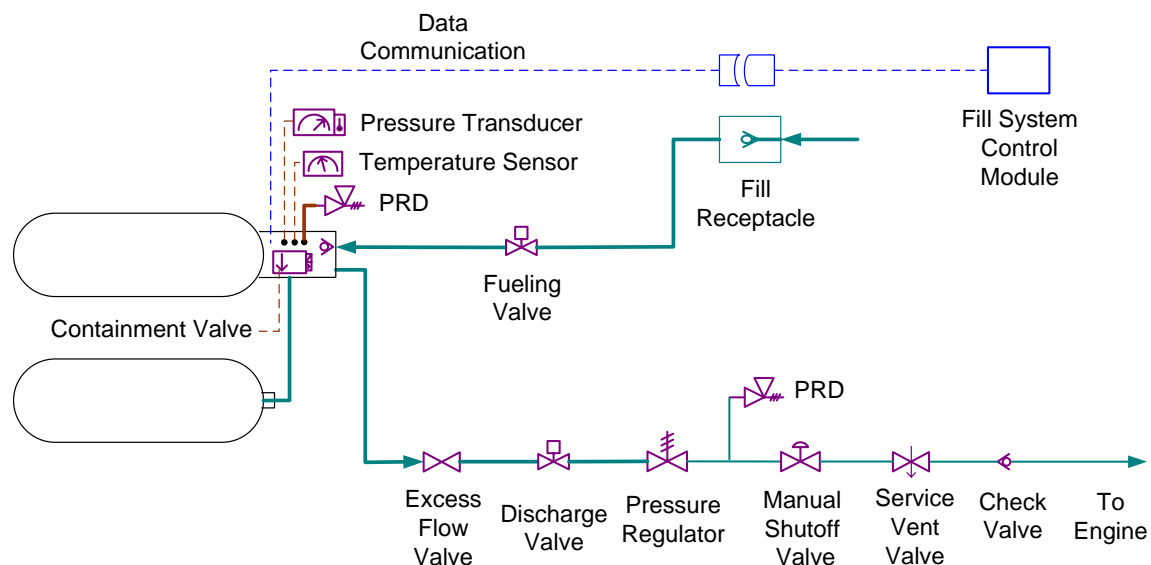

**Figure 5: Schematic of dual-tank compressed hydrogen storage system.**

Figure 6 shows the calculated gravimetric and volumetric capacities for Type III and Type IV, single- and dual-tank 350-bar systems. For single-tank systems, we calculate that the CF in a 350-bar, 5.6-kg usable H<sub>2</sub>, Type III tank system can carry 90% of the total load, the Al liner thickness is 7.4 mm, and the usable storage capacities are 4.2 wt% and 17.4 g/L. The corresponding capacities for the Type IV tank system (5-mm HDPE liner) are higher, 5.5 wt% and 17.6 g/L. For dual-tank systems, we calculate that the Al liner thickness is 5.9 mm for Type III tanks, and the usable storage capacities are 4.0 wt% and 17.2 g/L. The corresponding capacities for the Type IV dual-tank system (5-mm HDPE liner) are higher, 5.0 wt% and 17.2 g/L.

Figure 7 shows the calculated system capacities for Type III and Type IV, single- and dual-tank 700-bar systems. For Type III single-tank systems, we calculate that the Al liner thickness is 12.1 mm, and the usable storage capacities are 3.6 wt% and 25.0 g/L. The corresponding capacities for the Type IV tank system (5-mm HDPE liner) are higher, 5.2 wt% and 26.3 g/L. Because the HDPE liner carries negligible load, the liner thickness is unchanged between 350-bar and 700-bar pressures. For dual tank systems, we calculate that the Al liner thickness is 9.6 mm for Type III tanks, and the usable storage capacities are 3.5 wt% and 24.7 g/L. The corresponding capacities for the Type IV dual-tank system (5-mm HDPE liner) are higher, 4.8 wt% and 25.6 g/L.

We conclude that among the various compressed hydrogen tank systems analyzed, only the 350-bar, Type IV, single-tank system can potentially meet the 2015 gravimetric target of 5.5 wt% for 5.6 kg of recoverable hydrogen. None of the analyzed systems was found capable of meeting the 2015 volumetric target of 40 g/L.

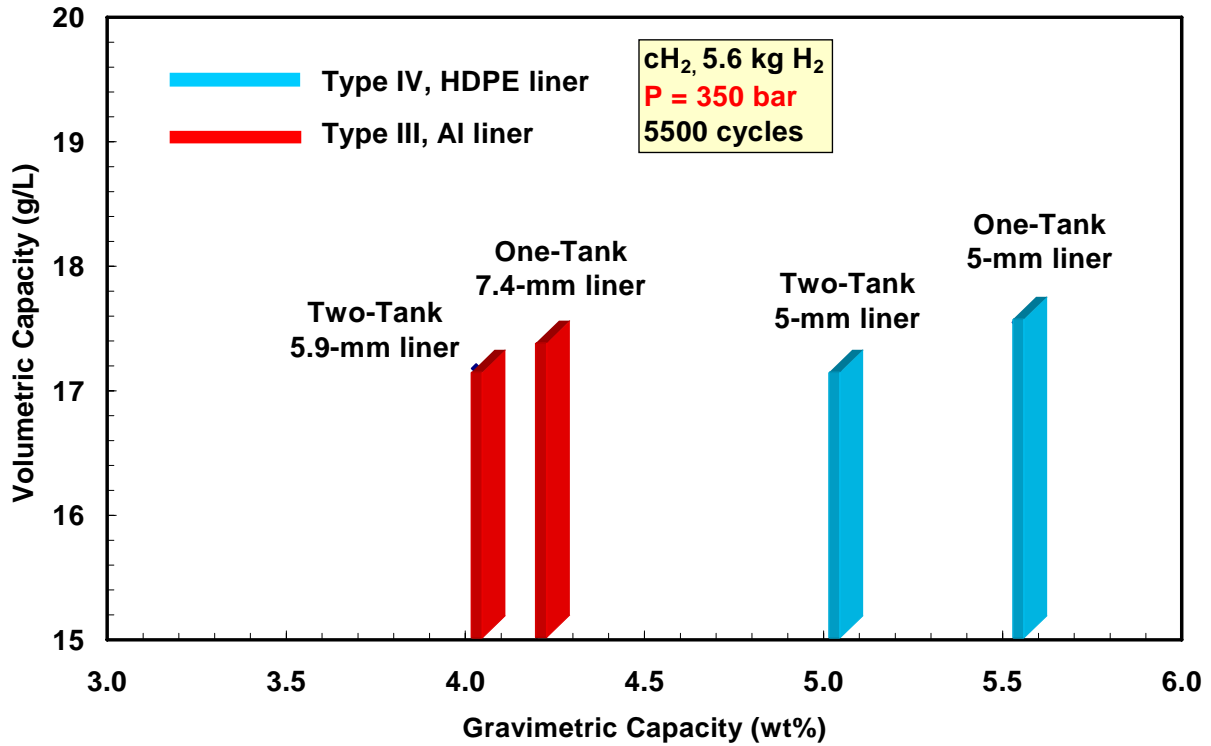

Figure 6: Comparison of the capacities of Type III and Type IV, single- and dual-tank, 350-bar hydrogen storage systems.

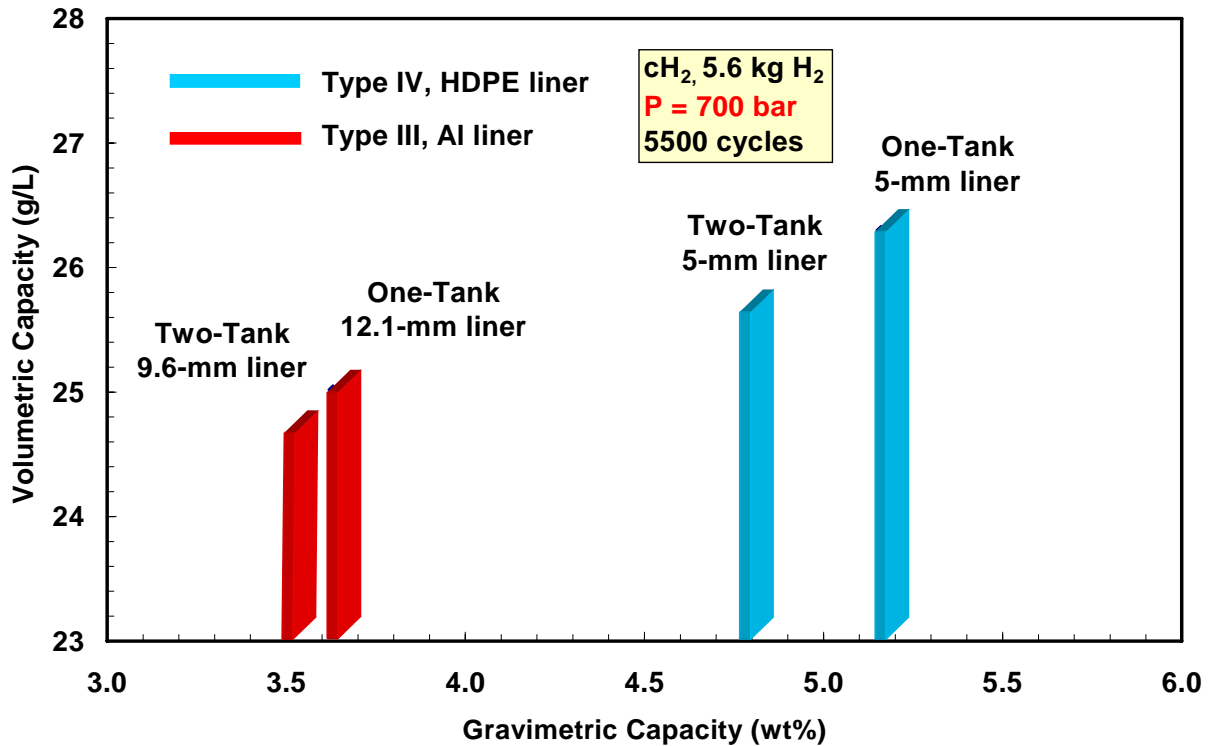
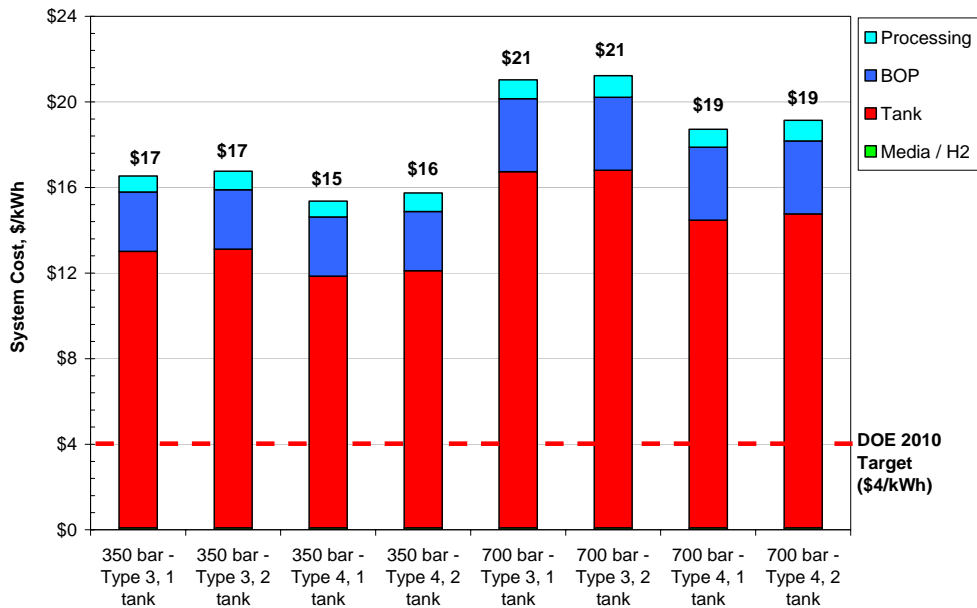

Figure 7: Comparison of the capacities of Type III and Type IV, single- and dual-tank, 700-bar hydrogen storage systems.

The results of the independent performance analyses of the system gravimetric and volumetric capacities of Type III and Type IV tanks were compared with the DOE Hydrogen Storage Grand Challenge “Learning Demos” data [NREL 2009]. The comparison is generally favorable, although there are some differences that need further investigation (see Appendix A for the comparison).

Our cost projections assume that a similar manufacturing process and system design is used for each of the compressed gas system configurations. However, for Type III tanks, a minor adjustment was made to the Type IV manufacturing process to include an autofrettage step – a process that is used to increase the liner’s fatigue life. For dual-tank systems, our cost analysis assumes that a single balance-of-plant subsystem is used to regulate both storage tanks.<sup>7</sup>

In total, eight different compressed system configurations were evaluated. These configurations include each combination of 350- and 700-bar, single- and dual-tank, and Type III and Type IV systems. A summary of the resulting cost projections is shown in Figure 8. For each of the systems analyzed, the tank comprises upwards of 80% of the system cost – primarily due to the high cost of the carbon fiber material. The Type IV, single-tank configurations are the lowest cost configurations for both the 350-bar and the 700-bar systems. The Type III configuration adds approximately \$1.2/kWh and \$2.2/kWh to the cost of the 350-bar and the 700-bar systems, respectively. A comparison of the price breakdown between Type III and Type IV systems (see Appendix B) indicates that, although the Type III tanks require less carbon fiber, this saving is more than offset by the additional expense of the aluminum liner compared to the HDPE liner.



**Figure 8: Comparison of system cost projections for Type III and Type IV, single- and dual-tank systems for 350-bar and 700-bar hydrogen storage.**

<sup>7</sup> An alternate configuration using a redundant balance of plant configuration was assessed for sensitivity analyses.



The dual-tank system adds less than \$0.5/kWh to the cost of both the 350-bar and 700-bar single-tank systems for Type III and Type IV systems. This result reflects a slightly higher material cost and a significantly higher processing cost, compared to a single-tank configuration:

- The pressure vessels used in the single-tank system require vessel walls that are approximately 25% thicker than those needed for the smaller pressure vessels used in the dual-tank system. This increased thickness nearly counter-balances the lower surface area of the single tank. As such, the material cost for the dual-tank system is less than 5% higher than the material cost for an equivalent single-tank system.
- The processing costs are 15 to 20% higher for the dual-tank system, but processing costs account for only about 5% of the total system cost.

As noted above, the dual-tank system design assumes that both tanks use a single balance-of-plant subsystem. Results of a single-variable sensitivity analysis of the dual-tank system indicate that if a redundant balance-of-plant subsystem is used for each tank, system costs would increase by \$2.7/kWh and \$3.4/kWh compared to the single-tank, 350- and 700-bar systems, respectively.

### **Off-board Assessments**

We evaluated the fuel cycle and infrastructure necessary to support refueling compressed hydrogen systems in automotive applications. These off-board assessments make use of existing, publicly available models to calculate the cost and performance of the hydrogen fuel cycle on a consistent basis. The performance assessment uses results from ANL's GREET [Wang 2005] and FCHtool [Ahluwalia 2007] models, while the cost assessment uses results from DOE's Hydrogen Delivery Scenarios Analysis Model, HDSAM [DOE 2009]. Key design assumptions for both analyses include central production via natural gas steam reforming (i.e., SMR), hydrogen delivery via compressed gas pipeline, and refueling to 25% over the nominal storage pressure (i.e., to 438 and 875 bar for 350 and 700 bar tanks, respectively). Additional design assumptions and details are listed in Table 4.

We performed an ownership cost analysis that included both on-board and off-board costs. Off-board (or refueling) costs for the complete fuel cycle necessary to support 350-bar and 700-bar compressed tank systems were estimated using DOE's Hydrogen Delivery Scenarios Analysis Model (HDSAM) version 2.06 [DOE 2009a]. This off-board cost was converted to the refueling portion of the ownership cost by using an assumed fuel economy of the hydrogen FCV. The on-board storage system cost was converted to the fuel system purchased cost portion of the ownership cost by applying the appropriate Retail Price Equivalent (RPE) multiplier (MSRP relative to the cost of manufacturing) as well as other assumptions (e.g., Annual Discount Factor and Annual Mileage) to convert the purchased cost to an equivalent \$/mile estimate.

The RPE multiplier actually consists of two markups to go from automotive OEM "Factory Cost" to MSRP – the hydrogen storage system manufacturer markup and the dealer markup. The RPE multiplier ranges between 1.46 and 2.00: Vyas et al. [2000] suggest that the RPE multiplier should be 2.00, while Rogozhin et al. [2009] develops an automobile industry average weighted RPE multiplier of 1.46 based on 2007 data, and an RPE multiplier of 1.70 based on McKinsey data for the automobile manufacturing industry. We assumed an RPE multiplier of 1.74 based on a recent DOE Report to Congress [DOE 2008].

**Table 4: Life cycle assumptions for pipeline delivery scenario**

Process/Process Fuels	Parameter and Value	Basis/Comment
Electricity production	Thermal efficiency 32.2%	EIA projected U.S. grid for 2015, inclusive of 8% transmission loss from power plant to user site
North American NG	Production efficiency 93.5%	GREET data
H <sub>2</sub> production by SMR	Process efficiency 71%	Data for industrial SMR
Thermal energy from NG	Heat transfer efficiency 85%	FCHtool model, consistent with large scale boilers
H <sub>2</sub> delivery by pipeline	Pressure drop 50 bar	H2A 50% market share scenario
H <sub>2</sub> compression	Isentropic efficiency 88% (central plant) 65% (fueling station)	HDSAM data
Precooling for fast fills	25°C to -40°C	Only for 700-bar tanks, no precooling assumed for 350-bar tanks
GHG emissions	Range	Emission factors data from GREET

## Performance Results

We evaluated the well-to-tank (WTT) energy efficiency of and GHG emissions from the fuel cycle necessary to support refueling the compressed hydrogen systems for automotive applications. The results discussed here are for hydrogen production by steam methane reforming (SMR) at a central plant and pipeline delivery of the hydrogen to the refueling stations.

The analysis assumed that SMR produces fuel quality hydrogen at 20 bar (290 psia), after which the gas is compressed to the final pressure in three steps. In the first step, hydrogen is compressed at the central station for pipeline delivery to the fueling station. We assumed that a three-stage, intercooled, centrifugal compressor is used at the production facility to compress hydrogen from 20 bar to 70 bar (1,030 psia) and that a pressure drop of 50 bar occurs in the pipeline, so that the hydrogen delivered to the fueling station is at 20 bar. In the second step, a five-stage centrifugal compressor is used at the fueling station to compress the hydrogen from 20 bar to 180 bar (2650 psia). In the third stage, also carried out at the fueling station, the hydrogen is compressed from 180 bar to 438 bar (6,440 psia) for the 350-bar tank and to 875 bar (12,860 psia) for the 700-bar tank. The analysis further assumed that the large compressors at the central production facility have 88% isentropic efficiency, 97% mechanical efficiency (i.e., 3% bearing loss) and 90% motor efficiency. At the fueling station, the smaller compressors are assumed to have a lower isentropic efficiency of 65% but the same mechanical and motor efficiencies.

Hydrogen storage at 350 bar requires 2.9 kWh/kg-H<sub>2</sub> electric energy for compression total for the three steps mentioned above. The electric energy requirement increases to 3.7 kWh/kg-H<sub>2</sub> for the 700-bar storage option.<sup>8</sup> Assuming that electricity is generated using the projected 2015 grid mix, the WTT efficiency is 56.5% for the 350-bar storage option and 54.2% for the 700-bar storage option. Both of these efficiencies are within a few percentage points of the 60% DOE target.

The estimated life cycle GHG emissions are 14.2 kg CO<sub>2</sub> equiv/kg-H<sub>2</sub> for the 350-bar hydrogen storage option. Hydrogen production by SMR accounts for 84% of this total, storage (i.e., compressors at the fueling station) contributes 12%, and the remaining 4% is due to pipeline delivery of gaseous hydrogen. The total GHG emissions increase to 14.8 kg CO<sub>2</sub> equiv /kg-H<sub>2</sub> (production 80%, storage 16%, and pipeline delivery 4%) for the 700-bar hydrogen storage option.

### Cost Results

The HDSAM result for the cost of hydrogen delivery via compressed gas pipeline is \$2.72/kg H<sub>2</sub> for refueling a 350-bar storage system and \$2.83/kg H<sub>2</sub> for refueling a 700 bar storage system. These costs assume 30% market penetration in a prototypical urban area (Indianapolis, IN) including geologic terminal storage and 1,000 kg H<sub>2</sub>/day fueling station capacity with cascade storage.<sup>9</sup> For consistency with the assessment of other hydrogen storage options, hydrogen production costs (i.e., central plant costs) were assumed to be \$1.50/kg H<sub>2</sub>, which is also consistent with H2A Production Model results for the lower-cost production options (e.g., central production from natural gas-based SMR) [DOE 2009b]. Therefore, the total refueling cost estimate for a 350-bar compressed hydrogen storage system was estimated to be \$4.22/kg H<sub>2</sub> (\$4.22/gallon gasoline equivalent [gge]), and \$4.33/kg H<sub>2</sub> (\$4.33/gge) for a 700-bar system.

Combining these off-board costs with the on-board system base case cost projections of \$15.4/kWh and \$18.7/kWh H<sub>2</sub>, and using the simplified economic assumptions presented in Table 5, resulted in a fuel system ownership cost estimate of \$0.13/mile for 350-bar and \$0.15/mile for 700-bar compressed hydrogen storage. About half of this cost is due to the purchased cost of the on-board storage system and half is due to the refueling or off-board cost. This compares to about \$0.10/mile for a conventional gasoline internal combustion engine vehicle (ICEV) when gasoline is \$3.00/gal (untaxed). The 350-bar fuel system ownership costs would be comparable to a gasoline ICEV with gasoline at \$4.00/gal and the 700-bar fuel system ownership costs would be comparable with those of gasoline at \$4.50/gal. An implicit assumption in this ownership cost comparison is that each fuel system/vehicle has the same operating lifetime, that the hydrogen FCV achieves two times the fuel economy of a similarly sized ICEV, and that the FCV performs at least as well as an ICEV in all other aspects of operation.

---

<sup>8</sup> These hydrogen storage electricity consumption results are comparable to the results in HDSAM version 2.06 (i.e., 2.9 and 3.8 kWh/kg-H<sub>2</sub> for 350 and 700-bar storage, respectively).

<sup>9</sup> Using boost compression instead of cascade storage results in slightly higher (\$3.17/kg H<sub>2</sub> for 700 bar) costs but may be more practical in near-term systems due to the lack of high-pressure, stationary tank availability.

**Table 5: Fuel system ownership cost assumptions and results**

Fuel System Ownership Cost	Gasoline ICEV	350-bar FCV <sup>10</sup>	700-bar FCV <sup>11</sup>	Basis/Comment
Annual Discount Factor on Capital	15%			Input assumption
Manufacturer + Dealer Markup	1.74			Assumed mark-up from factory cost estimates [DOT 2007]
Annual Mileage, mi/yr	12,000			H2A assumption
Vehicle Energy Efficiency Ratio	1.0	2.0		FCV: Based on ANL drive-cycle modeling
Fuel Economy, mpgge	31	62		ICEV: Car combined CAFE sales weighted FE estimate for 2007 [DOT 2007]
H <sub>2</sub> Storage Requirement, kg H <sub>2</sub>	NA	5.6		FCV: Design assumption based on ANL drive-cycle modeling
H <sub>2</sub> Storage System Factory Cost, \$/kWh	NA	15.4	18.7	FCV: H <sub>2</sub> storage cost from On-board Assessment Base Case
Fuel Price (untaxed), \$/gge	3.00	4.22	4.33	FCV: Equivalent H <sub>2</sub> price from Off-board Assessment Base Case
Ownership Cost Result, \$/mile	0.10	0.13	0.15	

### Summary and Conclusions

A technical assessment of compressed hydrogen storage tank systems for automotive applications has been conducted. The assessment criteria included the prospects of meeting the near-term and ultimate DOE targets for on-board hydrogen storage systems for light-duty vehicles with a Type IV tank design. We found that substantial carbon fiber composite material cost reductions and/or performance improvements (e.g., much higher translation strength efficiency) are needed in order to meet the DOE on-board cost and weight targets. Higher pressures, lower temperatures and/or sorbents are needed to meet volumetric targets. While fuel costs are projected to be much higher than the DOE target range, fuel system ownership costs are not projected to be significantly higher than those for a gasoline ICEV because of the factor of 2 higher fuel economy of the hydrogen FCV.

The main conclusions from this assessment are summarized Table 6 and discussed below. Additionally, the results for the Type III and Type IV single- and dual-tank systems are summarized in Table 7.

<sup>10</sup> Assumes 438 bar cascade storage and dispensing for 350-bar on-board storage system.

<sup>11</sup> Assumes 875 bar cascade storage and dispensing for 700-bar on-board storage system.

**Table 6: Summary results of the assessment for Type IV single-tank compressed hydrogen storage systems**

Performance and Cost Metric	Units	350-bar	700-bar	2010 Targets	2015 Targets	Ultimate Targets
Usable Storage Capacity (Nominal)	kg-H <sub>2</sub>	5.6	5.6	N/A	N/A	N/A
Total Storage Capacity (Maximum)	kg-H <sub>2</sub>	6.0	5.8	N/A	N/A	N/A
System Gravimetric Capacity	wt%	5.5	4.2	4.5	5.5	7.5
System Volumetric Capacity	kg-H <sub>2</sub> /m <sup>3</sup>	17.6	26.3	28	40	70
Storage System Cost	\$/kWh	15.4	18.7	4	2	TBD
Fuel Cost	\$/gge	4.22	4.33	2-3	2-3	2-3
Ownership Cost	\$/mile	0.13	0.15	N/A	N/A	N/A
WTT Efficiency	%	56.5	54.2	60	60	60
GHG Emissions (CO <sub>2</sub> eq)	kg/kg-H <sub>2</sub>	14.2	14.8	N/A	N/A	N/A

### *Gravimetric Capacity*

The 350-bar compressed tank system capable of storing 5.6 kg of recoverable hydrogen has a nominal usable gravimetric capacity of 5.5 wt%. The nominal capacity increases to 5.8 wt% if the “empty” pressure is reduced to 3 bar and 5.7 wt% if the CF translation strength efficiency improves to 90% with advances in filament winding technology. Thus, the 350-bar compressed option easily exceeds the 2010 target of 4.5 wt% and meets the 2015 target of 5.5 wt% without any changes. It is unlikely to meet the ultimate target of 7.5 wt% even if the CF translation strength efficiency reaches the theoretical value of 100% and the glass fiber and foam end caps are removed (i.e., 6.9 wt%).

The 700-bar compressed tank system capable of storing 5.6 kg of recoverable hydrogen has a nominal usable gravimetric capacity of 5.2 wt%. The nominal capacity increases to 5.3 wt% if the “empty” pressure is reduced to 3 bar (45 psi), and to 5.6 wt% if the CF translation strength efficiency improves to 90% with advances in filament winding technology. Thus, the 700-bar compressed option also exceeds the 2010 target of 4.5 wt%, but it can only meet the 2015 target of 5.5 wt% if the CF translation strength efficiency improves over the current state of the art. It is unlikely to meet the ultimate target of 7.5 wt% even if the CF translation strength efficiency reaches the theoretical value of 100% and the glass fiber and foam end caps are removed (i.e., 6.5 wt%).

Either system, 350- or 700-bar, could improve its gravimetric capacity by using a higher strength carbon fiber composite, but this would likely increase the system cost, because T700S has the

most attractive strength-to-cost ratio of the commercially available carbon fiber options currently being considered for this application.

### *Volumetric Capacity*

The 350-bar compressed tank system has a nominal volumetric capacity of 17.6 g-H<sub>2</sub>/L. The nominal capacity increases to 18.6 g-H<sub>2</sub>/L if the “empty” pressure is reduced to 3 bar. Increasing the CF translation strength efficiency to 90% has very little effect on the volumetric capacity (i.e., 17.7 g- H<sub>2</sub>/L). Thus, the 350-bar system falls far short of meeting even the 2010 target of 28 g-H<sub>2</sub>/L with the credits and modifications considered in this assessment.

The 700-bar compressed tank system has a nominal volumetric capacity of 26.3 g-H<sub>2</sub>/L. The nominal capacity increases to 27.2 g-H<sub>2</sub>/L if the “empty” pressure is reduced to 3 bar. Increasing the CF translation strength efficiency to 90% increases the volumetric capacity to 26.9 g- H<sub>2</sub>/L. Thus, the 700-bar system is close to meeting the 2010 target of 28 g-H<sub>2</sub>/L, but falls far short of meeting the 2015 target of 40 g-H<sub>2</sub>/L and the ultimate DOE target of 70 g-H<sub>2</sub>/L with the credits and modifications considered in this assessment.

### *Storage System and Fuel Cost*

The high-volume manufactured cost of the base case 350-bar single tank, Type IV compressed tank system is \$15.4/kWh, and \$18.7/kWh for the base case 700-bar single tank, Type IV system. These manufactured system costs, based on assumptions considered most likely to be applicable (i.e., base cases), are 4 - 5 times more than the current DOE 2010 cost target of \$4/kWh. According to the multi-variable sensitivity analysis results, the factory cost will likely range between \$10.6 and \$19.7/kWh for the 350-bar system and between \$13.5 and \$27.2/kWh for the 700-bar system.<sup>12</sup> Type III tanks are projected to add \$1.2 and \$2.2/kWh to the system cost of 350-bar and 700-bar systems, respectively, while dual tank systems are projected to add less than \$0.5/kWh to system costs. Substantial carbon fiber composite material cost reductions and/or performance improvements, and BOP cost reductions are needed in order to meet DOE cost targets. Balance of system costs (i.e., non-carbon fiber composite costs) alone, which make up a small fraction of the total system cost, are around 75% of the 2010 cost target (i.e., approximately \$3/kWh).

The fuel cost for the reference SMR production and compressed hydrogen delivery scenario is \$4.22 and \$4.33/gge for the 350-bar and 700-bar cases, respectively. This is approximately 40%-120% higher than the current DOE target of \$2-3/gge. When on-board and off-board costs are combined, the 350-bar compressed system has potential to have similar ownership costs as a gasoline ICEV, albeit about 20% (2 ¢/mi or \$240/yr) higher when gasoline is \$3.00/gal. The 700-bar system is projected to have 50% higher ownership cost compared to an ICEV when gasoline is \$3.00/gal.

### *Efficiency and Greenhouse Gas Emissions*

Whereas efficiency is not a specified DOE target, the systems are required to be energy efficient.

---

<sup>12</sup> Range is defined here as the 95% confidence interval based on the data fit for the sensitivity analysis.

A footnote in the DOE hydrogen target table requires the WTT efficiency for the off-board regenerable systems to be higher than 60%. The compressed tank options almost meet this target. WTT efficiencies are projected to be 56.5% and 54.2% for 350-bar and 700-bar refueling, respectively, assuming that electricity is generated using the projected 2015 grid mix. The corresponding estimated GHG emissions for hydrogen production by SMR and compressed hydrogen delivery are 14.2 kg/kg-H<sub>2</sub> and 14.8 kg/kg-H<sub>2</sub> for the 350-bar and 700-bar base cases, respectively.

**Table 7: Summary results of the assessment for Type III and Type IV single and dual tank compressed hydrogen storage systems**

Performance and Cost Metric	Units	cH2 350-T3	cH2 350-T3	cH2 350-T4	cH2 350-T4	cH2 700-T3	cH2 700-T3	cH2 700-T4	cH2 700-T4	2010 Targets	2015 Targets	Ultimate Targets
Tank		1-Tank	2-Tank	1-Tank	2-Tank	1-Tank	2-Tank	1-Tank	2-Tank			
Total Storage Capacity	kg-H <sub>2</sub>	6.0	6.0	6.0	6.0	5.8	5.8	5.8	5.8			
Usable Storage Capacity	kg-H <sub>2</sub>	5.6	5.6	5.6	5.6	5.6	5.6	5.6	5.6			
System Gravimetric Capacity	wt%	4.2	4.0	5.5	5.0	3.6	3.5	5.2	4.8	4.5	5.5	7.5
System Volumetric Capacity	kg-H <sub>2</sub> /m <sup>3</sup>	17.4	17.2	17.6	17.2	25.0	24.7	26.3	25.6	28	40	70
Storage System Cost	\$/kWh	16.8	16.9	15.4	15.8	21.2	21.4	18.7	19.2	4	2	TBD
Fuel Cost	\$/gge	4.2	4.2	4.2	4.2	4.3	4.3	4.3	4.3	2-3	2-3	2-3
Cycle Life (1/4 tank to Full)	Cycles	5500	5500	NA	NA	5500	5500	NA	NA	1000	1500	1500
Minimum Delivery Pressure, FC/ICE	atm	4	4	4	4	4	4	4	4	4/35	3/35	3/35
WTT Efficiency	%	56.5	56.5	56.5	56.5	54.2	54.2	54.2	54.2	60	60	60
GHG Emissions (CO <sub>2</sub> eq)	kg/kg-H <sub>2</sub>	14.2	14.2	14.2	14.2	14.8	14.8	14.8	14.8			
Ownership Cost	\$/mile	0.13	0.13	0.13	0.13	0.15	0.15	0.14	0.14			



## References

1. Abdallah, M., "Low Cost Carbon Fiber (LCCF) Development Program," Hexcel, Phase I Final Report to DOE ORNL, August 2004.
2. Ahluwalia, R. K., Hua, T. Q., and Peng, J. K., "Fuel Cycle Efficiencies of Different Automotive On-Board Hydrogen Storage Options," *International Journal of Hydrogen Energy*, 32(15), 3592-3602, 2007.
3. Ahluwalia, R. K., Wang, X., Rousseau, A., and Kumar, R., "Fuel Economy of Hybrid Fuel Cell Vehicles," *Journal of Power Sources*, 152, 233-244, 2005.
4. Ahluwalia, R. K., Wang, X., Rousseau, A., and Kumar, R., "Fuel Economy of Hydrogen Fuel Cell Vehicles," *Journal of Power Sources*, 130, 192-201, 2004.
5. Du Vall, F., "Cost Comparisons of Wet Filament Winding Versus Prepreg Filament Winding for Type II and Type-IV CNG Cylinders," *SAMPE Journal*, Vol. 37, No. 1, p. 39-42, January/February 2001.
6. Hua, T. Q., Peng, J. K., and Ahluwalia, R. K., "Performance Assessment of Compressed Hydrogen Storage Systems," Argonne National Laboratory, August 2010.
7. Kromer, M., Lasher, S., Mckenney, K., Law, K., and Sinha, J., "H<sub>2</sub> Storage using Compressed Gas: On-board System and Ownership Cost Update for 350 and 700-bar," TIAX LLC, Final Report to DOE, August 2010.
8. Lee, S., Ed., *Handbook of Composite Reinforcements*, Wiley-VCH, 1993.
9. Liu, C., Quantum, Personal Communication, 2009.
10. Newhouse, N. L., Lincoln Composites, Personal Communication, 2010.
11. NREL, 2009 Composite Data Products, [http://www.nrel.gov/hydrogen/proj\\_learning\\_demo.html](http://www.nrel.gov/hydrogen/proj_learning_demo.html)
12. SAE International, "Surface Vehicle Information Report," SAE J2579, 2009.
13. U.S. Department of Energy (DOE), 2009a: Hydrogen Delivery Scenario Analysis Model (HDSAM), [http://www.hydrogen.energy.gov/h2a\\_delivery.html](http://www.hydrogen.energy.gov/h2a_delivery.html)
14. U.S. Department of Energy (DOE), 2009b: Hydrogen Production Model (H2A), [http://www.hydrogen.energy.gov/h2a\\_production.html](http://www.hydrogen.energy.gov/h2a_production.html)
15. U.S. Department of Energy (DOE), "Effects of a Transition to a Hydrogen Economy on Employment in the United States," Report to Congress, July 2008.
16. U.S. Department of Transportation (DOT), NHTSA, "Summary of Fuel Economy Performance," Washington, DC, March 2007.
17. Vasiliev, V. V. and Morozov, E. V., *Mechanics and Analysis of Composite Materials*. New York, NY: Elsevier, 2001.
18. Wang, M. Q., "GREET 1.7 – Transportation Fuel-Cycle Model, Argonne National Laboratory," Argonne, IL, December 2005.
19. Vyas, A., Santini, D., and Cuenca, R., "Comparison of Indirect Cost Multipliers for Vehicle Manufacturing," Center for Transportation Research, Energy Systems Division, Argonne National Laboratory, April 2000.
20. Rogozhin, A., Gallaher, M., and McManus, W., "Automobile Industry Retail Price Equivalent and Indirect Cost Multipliers," report by RTI International for EPA, EPA-420-R-09-003, February 2009.

## **APPENDIX A**

### **Performance Assessment of Compressed Hydrogen Storage Systems**

# Performance Assessment of Compressed Hydrogen Storage Systems

T. Q. Hua, J-K Peng and R. K. Ahluwalia

August 30, 2010

Final Report

This presentation does not contain any proprietary, confidential, or  
otherwise restricted information

## Scope of Work

---

- Gravimetric and volumetric capacities for compressed H<sub>2</sub> storage options
  - Type III and Type IV Tanks
  - Single and dual tank designs
- Comparison with “Learning Demos” data
- Electricity requirement to compress H<sub>2</sub> for on-board storage at 350 and 700 bar
- Well-to-Tank efficiency and greenhouse gas emissions

## Carbon Fiber Netting Analysis

- Benedict-Webb-Rubin equation of state to calculate amount of stored H<sub>2</sub> for 5.6 kg recoverable H<sub>2</sub> and 20-bar minimum pressure
- Carbon fiber translation efficiency
  - 82.5% for 350 bar cH<sub>2</sub>
  - 80% for 700 bar
- 2.25 safety factor
- 5-mm HDPE liner, 1-mm glass fiber, and 10-mm foam end caps (Type IV tanks)
- Construct optimal dome shape with geodesic winding pattern (i.e., along isotensoids)
- Geodesic and hoop windings in straight cylindrical section
- Iterate for tank diameter, CF thickness (non-uniform in end domes), given L/D
- Commercial data for BOP components

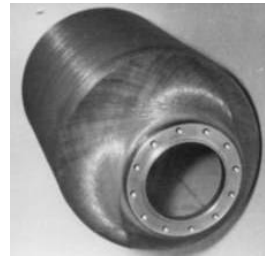

Ref: <http://www.adoptech.com/pressure-vessels/main.htm>

## Design Parameter Assumptions

Design Parameter	Nominal Value	Source/Comment
Recoverable H <sub>2</sub>	5.6 kg	ANL model for 350-mile range. Tank storage capacity 6.0 and 5.8 kg H <sub>2</sub> for 350 and 700 bar tanks, respectively
Internal tank volume	258 L (350 bar) 149 L (700 bar)	Benedict-Webb-Rubin equation of state to calculate amount and volume of H <sub>2</sub> stored
Max filling over pressure	438/875 bar	25% over nominal tank pressure for fast fills
"Empty" pressure	20 bar	Quantum
Safety factor	2.25	EIHP standard, factor applied to nominal pressure
Carbon fiber type	Toray T700S	Quantum
CF composite tensile strength	2550 MPa	Toray material data sheet
CF translation efficiency	82.5% (350 bar) 80% (700 bar)	Quantum
Dome shape	geodesic winding	Netting analysis algorithm (Vasiliev and Morozov, 2001)
Tank L/D	3	Quantum, L excludes end caps, D is internal diameter
Tank liner	5 mm HDPE	Quantum
Glass liner	1 mm glass fiber	Quantum, for logo imprint, no structural function
Protective end caps	10 mm foam	Quantum, for impact protection
Micellaneous weight	~ 19 kg	Commercial data for balance-of-plant components
Micellaneous volume	~ 6 L	Commercial data for balance-of-plant components

## System Weight and Volume (5.6 kg Usable H<sub>2</sub>)

Type-IV Tank	350 bar One-Tank		700 bar One-Tank	
	W (kg)	V (L)	W (kg)	V (L)
Hydrogen	6.0	257.7	5.8	148.7
Liner	11.4	11.8	8.0	8.3
Carbon Fiber	53.0	32.9	67.4	41.9
Glass Fiber	6.1	2.5	4.6	1.9
Foam	5.2	7.7	4.0	5.9
BOP				
Check Valves (2)	0.4	0.1	0.4	0.1
Manual Valve (1)	0.2	0.1	0.2	0.1
Excess Flow Valve (1)	0.2	0.1	0.2	0.1
Service Vent Valve (1)	0.2	0.1	0.2	0.1
Shutoff Valves (3)	1.8	1.3	1.8	1.3
Relief Valves (2)	0.6	0.2	0.6	0.2
Pressure Transducer (1)	0.1	0.0	0.1	0.0
Temperature Transducer (1)	0.1	0.0	0.1	0.0
Pressure Regulator (1)	2.1	0.7	2.1	0.7
Pressure Relief Devices (2)	1.0	0.6	1.0	0.6
Pipings/Fittings	4.0	1.0	4.0	1.0
Boss	0.4	0.1	0.9	0.1
Plug	0.2	0.1	0.1	0.1
Vehicle Interface Brackets	5.2	0.7	4.0	0.5
Fill System Control Module	1.0	1.0	1.0	1.0
Miscellaneous	2.0	0.5	2.0	0.5
BOP Subtotal	19.4	6.4	18.7	6.3
<b>System Total</b>	<b>101.1</b>	<b>319.0</b>	<b>108.6</b>	<b>212.9</b>
Gravimetric Capacity, wt%	5.5		5.2	
Volumetric Capacity, g H <sub>2</sub> /L		17.6		26.3

## Dome Shape and CF Thickness

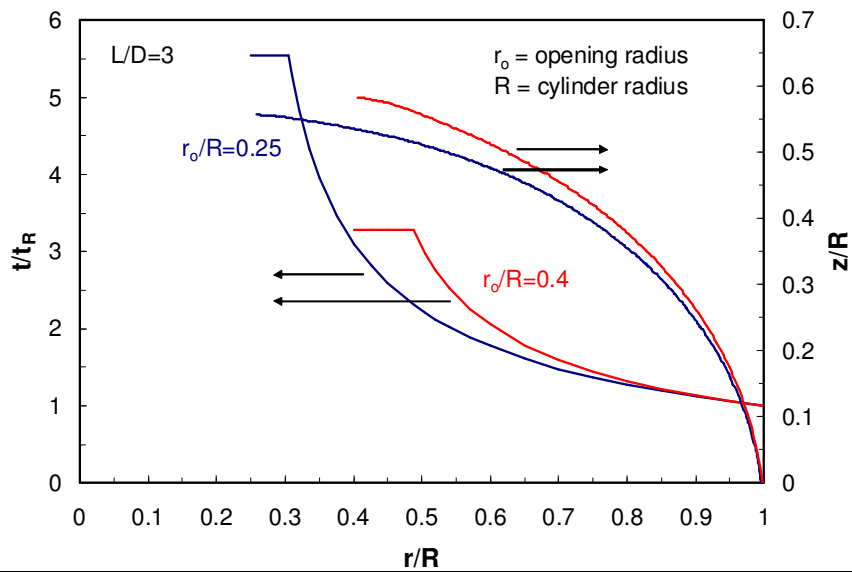

## On-board System Gravimetric Capacity

Weight Distribution (%)  
350 bar, 5.6 kg Usable H<sub>2</sub>

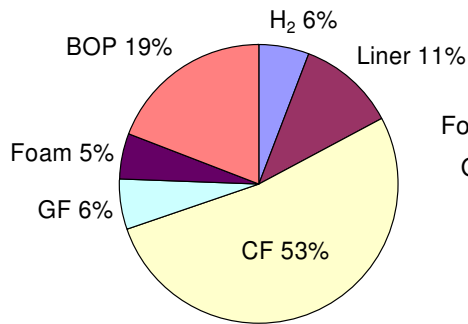

System Weight = 101 kg  
Gravimetric Capacity = 5.5 wt%

Weight Distribution (%)  
700 bar, 5.6 kg Usable H<sub>2</sub>

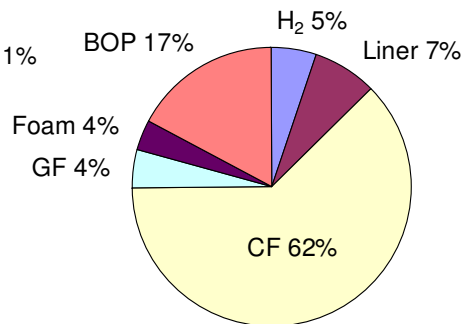

System Weight = 109 kg  
Gravimetric Capacity = 5.2 wt%



7

## On-board System Volumetric Capacity

Volume Distribution (%)  
350 bar, 5.6 kg Usable H<sub>2</sub>

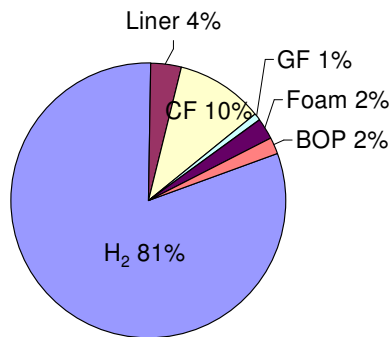

System Volume = 319 L  
Volumetric Capacity = 17.6 g H<sub>2</sub>/L

Volume Distribution (%)  
700 bar, 5.6 kg Usable H<sub>2</sub>

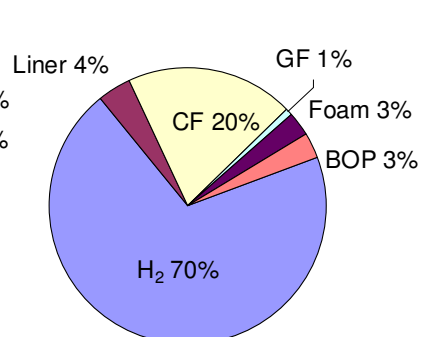

System Volume = 213 L  
Volumetric Capacity = 26.3 g H<sub>2</sub>/L



8

## Parametric Analysis of System Capacities

- Improvement in carbon fiber translation efficiency or reducing minimum delivery pressure increases system capacities

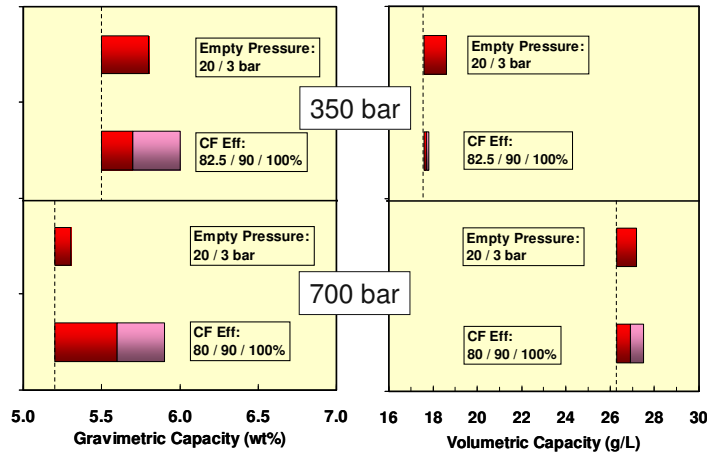

## H<sub>2</sub> Delivery by Pipeline

- Pipeline delivery for 50% market share scenario
- H<sub>2</sub> produced by SMR central plant at 20 bar, compressed to 70 bar for pipeline delivery to forecourt (50 bar pressure drop through pipeline)
- At the forecourt, H<sub>2</sub> is compressed to 180 bar in 5 stages, then to 438 bar in 2 stages or 875 bar in 4 stages

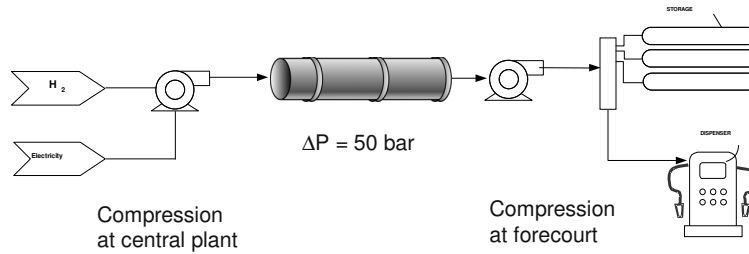

## Assessment of Type III Tank Systems

- Al 6061-T6 liner subjected to autofrettage to improve liner fatigue life. Autofrettage process produces residual compressive stress in liner and residual tensile stress in CF
- Liner supports 10-15% of pressure load, thereby reducing the amount of CF requirement
- Liner thickness determined to meet 5500 pressure cycles at 125% nominal working pressure (SAE J2579)
- SN curve for Al 6061-T6

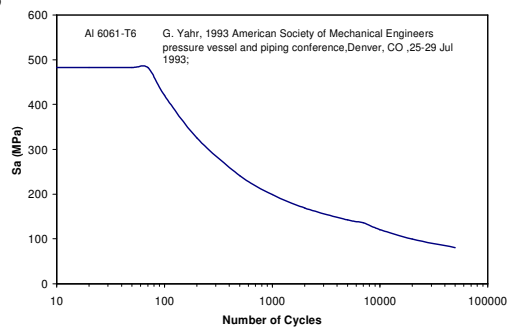

## Assessment of Dual Tank Systems

- Dual tank system offers additional packaging flexibility compared to single tank system
- Assume dual tank system design utilizes a single balance-of-plant (redundant BOPs are typically employed in current CNG buses)

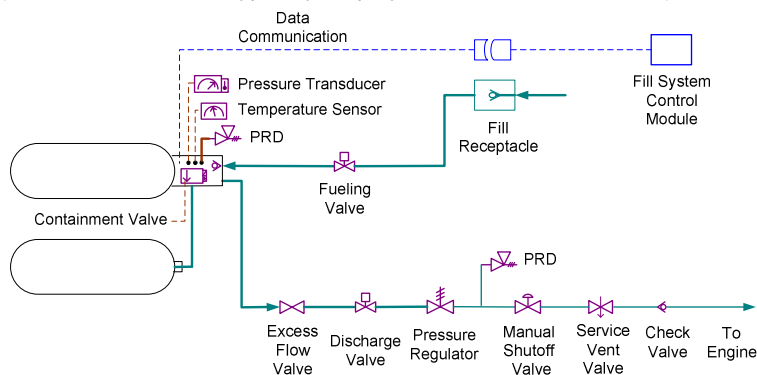



## Comparison of Type III, Type IV, Single and Dual Tank 350-bar Systems

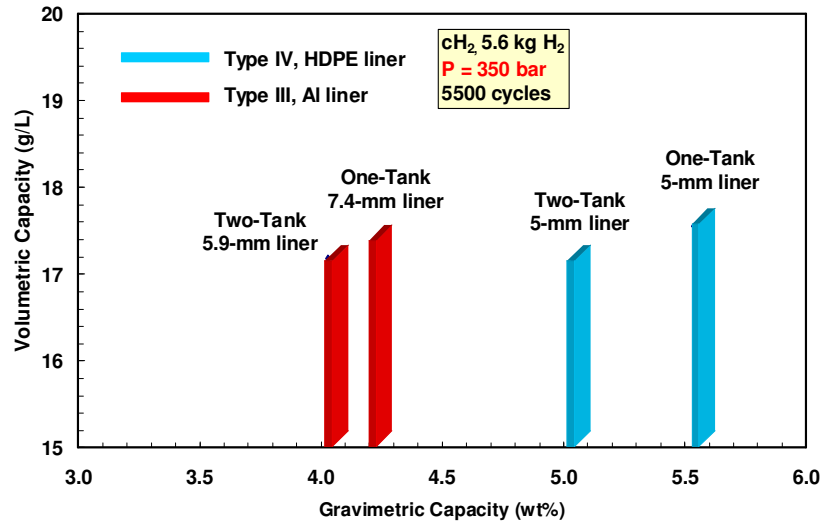

## Comparison of Type III, Type IV, Single and Dual Tank 700-bar Systems

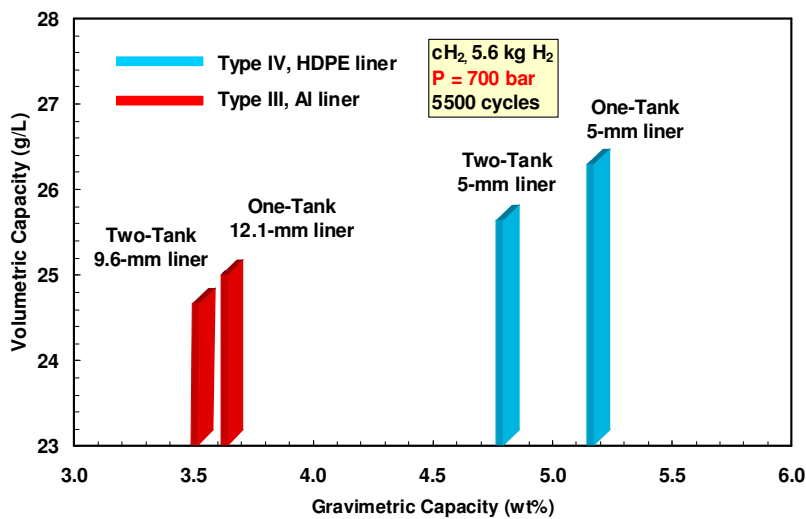

## Comparison of ANL Analysis with “Learning Demos”

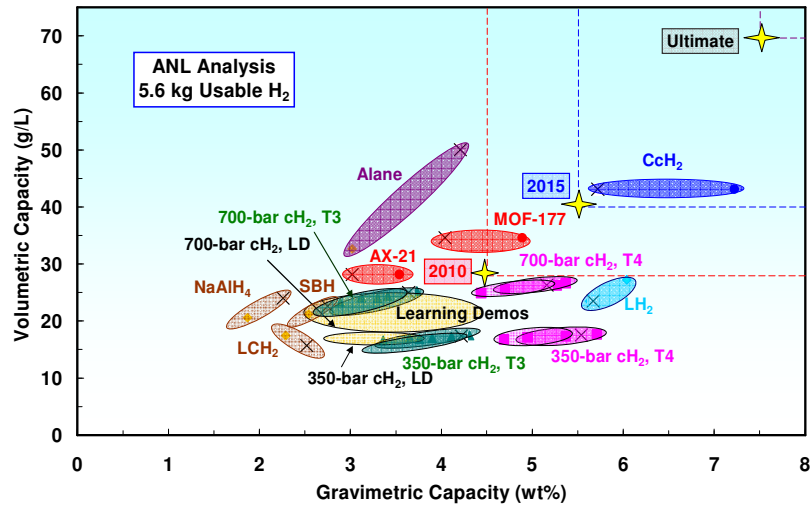

## Life Cycle Assumptions for Pipeline Delivery Scenario

Process/Process Fuels	Nominal Value	Source/Comment
Electricity production	32.2% thermal efficiency	EIA projected U.S. grid for 2015, inclusive of 8% transmission loss from power plant to user site
North American natural gas production	93.5% efficiency	GREET data
H <sub>2</sub> production by SMR	71% efficiency	Data for industrial SMR
Thermal energy by NG	85% heat transfer efficiency	FCHtool model, consistent with large scale boilers
H <sub>2</sub> delivery by pipeline	50 bar pressure drop	H2A 50% market share scenario
H <sub>2</sub> compression isentropic efficiency	88% (central plant) 65% (forecourt)	HDSAM data
Precooling for fast fills	25°C to -40°C	Only for 700 bar tanks, no precooling assumed for 350 bar tanks
Greenhouse gas emissions	range	Emission factors data from GREET

\* R. K. Ahluwalia, T. Q. Hua, and J-K Peng, International Journal of Hydrogen Energy 32 (2007)

## Electricity Consumption and WTT Efficiency

Compression <sup>(a)</sup>		# of Stages	Isentropic efficiency	Electricity (kWh/kg)	WTT efficiency <sup>(b)</sup>	Comments
P <sub>i</sub> (bar)	P <sub>f</sub> (bar)					
20	70	3	88%	0.6		Central plant, P = 50 bar
20	180	5	65%	1.6	-	Forecourt
180	438	2	65%	0.7	-	Forecourt
180	875	4	65%	1.3	-	Forecourt
20	438	7	65 - 88%	2.9	<b>56.5%</b>	350 bar on-board storage
20	875	9	65 - 88%	3.7 <sup>(c)</sup>	<b>54.2%</b>	700 bar on-board storage

Notes:

- a) Compressor mechanical efficiency = 97%, motor efficiency = 90%
- b) H<sub>2</sub> produced by SMR central plant, electricity source from U.S. grid 2015, inclusive of 8% transmission loss
- c) Includes 0.14 kWh/kg for precooling from 25°C to -40°C

## Life Cycle Greenhouse Gas Emissions (g/kg H<sub>2</sub>)

### ■ 350-bar on-board storage

	VOC	CO	NO <sub>x</sub>	PM <sub>10</sub>	SO <sub>x</sub>	CH <sub>4</sub>	N <sub>2</sub> O	CO <sub>2</sub>	GHGs
H <sub>2</sub> Production	1.25	2.93	5.90	1.71	2.07	24.23	0.05	11,370	11,941
H <sub>2</sub> Storage	0.15	0.45	1.75	2.10	3.83	2.31	0.02	1,653	1,714
H <sub>2</sub> Distribution	0.04	0.13	0.51	0.62	1.12	0.68	0.01	484	502
<b>Total:</b>	<b>1.45</b>	<b>3.52</b>	<b>8.16</b>	<b>4.43</b>	<b>7.01</b>	<b>27.22</b>	<b>0.08</b>	<b>13,507</b>	<b>14,157</b>

### ■ 700-bar on-board storage

	VOC	CO	NO <sub>x</sub>	PM <sub>10</sub>	SO <sub>x</sub>	CH <sub>4</sub>	N <sub>2</sub> O	CO <sub>2</sub>	GHGs
H <sub>2</sub> Production	1.25	2.93	5.90	1.71	2.07	24.23	0.05	11,370	11,941
H <sub>2</sub> Storage	0.20	0.59	2.26	2.73	4.97	3.00	0.03	2,145	2,223
H <sub>2</sub> Distribution	0.05	0.16	0.62	0.75	1.36	0.82	0.01	588	610
<b>Total:</b>	<b>1.50</b>	<b>3.68</b>	<b>8.79</b>	<b>5.19</b>	<b>8.39</b>	<b>28.05</b>	<b>0.09</b>	<b>14,103</b>	<b>14,774</b>

## Summary

- Dome shape and carbon fiber thickness were determined by netting analysis
- Minimum tank pressure affects system gravimetric and volumetric capacities while tank geometry (L/D) affects only gravimetric capacity
- WTT efficiency is within six percentage points of DOE target of 60%
- For 5.6 kg recoverable H<sub>2</sub> in Type IV single tank system, and L/D = 3

H <sub>2</sub> Tank Pressure (bar)	Minimum Pressure (bar)	Gravimetric Capacity (wt%)	Volumetric Capacity (g/L)	Electricity (kWh/kg)	WTT Efficiency (%)	GHG (kg/kg-H <sub>2</sub> )
350	20	5.5	17.6	2.9	56.5	14.2
350	3	5.8	18.6	2.9	56.5	14.2
700	20	5.2	26.3	3.7	54.2	14.8
700	3	5.3	27.2	3.7	54.2	14.8

## Summary

- For 5.6 kg recoverable H<sub>2</sub> in Type III, Type IV single and dual tank systems, and L/D = 3

Performance and Cost Metric	Units	cH <sub>2</sub> 350-T3		cH <sub>2</sub> 350-T4		cH <sub>2</sub> 700-T3		cH <sub>2</sub> 700-T4		2010 Targets	2015 Targets	Ultimate Targets
		1-Tank	2-Tank	1-Tank	2-Tank	1-Tank	2-Tank	1-Tank	2-Tank			
Tank												
Total Storage Capacity	kg-H <sub>2</sub>	6.0	6.0	6.0	6.0	5.8	5.8	5.8	5.8			
Usable Storage Capacity	kg-H <sub>2</sub>	5.6	5.6	5.6	5.6	5.6	5.6	5.6	5.6			
System Gravimetric Capacity	wt%	4.2	4.0	5.5	5.0	3.6	3.5	5.2	4.8	4.5	5.5	7.5
System Volumetric Capacity	kg-H <sub>2</sub> /m <sup>3</sup>	17.4	17.2	17.6	17.2	25.0	24.7	26.3	25.6	28	40	70
Storage System Cost	\$/kWh	16.8	16.9	15.4	15.8	21.2	21.4	18.7	19.2	4	2	TBD
Fuel Cost	\$/gge	4.2	4.2	4.2	4.2	4.3	4.3	4.3	4.3	2-3	2-3	2-3
Cycle Life (1/4 tank to Full)	Cycles	5500	5500	NA	NA	5500	5500	NA	NA	1000	1500	1500
Minimum Delivery Pressure, FC/ICE	atm	4	4	4	4	4	4	4	4	4/35	3/35	3/35
WTT Efficiency	%	56.5	56.5	56.5	56.5	54.2	54.2	54.2	54.2	60	60	60
GHG Emissions (CO <sub>2</sub> eq)	kg/kg-H <sub>2</sub>	14.2	14.2	14.2	14.2	14.8	14.8	14.8	14.8			
Ownership Cost	\$/mile	0.13	0.13	0.13	0.13	0.15	0.15	0.14	0.14			

## **APPENDIX B**

### **Cost Assessment of Compressed Hydrogen Storage Systems**



# Analyses of Hydrogen Storage Materials and On-Board Systems

H<sub>2</sub> Storage using Compressed Gas:  
On-board System and Ownership Cost  
Update for 350 and 700-bar

Final Report  
August 27, 2010

**Matt Kromer**  
Stephen Lasher  
Kurtis Mckenney  
Karen Law  
Jayanti Sinha

**TIAX LLC**  
35 Hartwell Ave  
Concord, MA  
02421-3102

Tel. 781-879-1708  
Fax 781-879-1201  
[www.TIAXLLC.com](http://www.TIAXLLC.com)  
Reference: D0268

© 2010 TIAX LLC

## Sections

1	Executive Summary
2	On-board Assessment
3	Off-board Assessment
4	Conclusions
A	Appendix



Summary

**We have evaluated characteristics of on-board and off-board hydrogen storage systems for 11 storage technologies.**

Analysis To Date		cH <sub>2</sub>	Alanate	MgH <sub>2</sub>	SBH	LCH <sub>2</sub>	CcH <sub>2</sub>	LH <sub>2</sub>	AC	MOF-177	Cold Gas	AB
On-Board	Review developer estimates	√	√		√	√	√	√	√	√		
	Develop process flow diagrams/system energy balances (ANL lead)	√	√		√	√	√	√		√		
	Performance assessment (ANL lead)	√	√		√	√	√	√*		√*		
	Independent cost assessment	√	√		√	√	√	√*	WIP	√*		
Off-Board	Review developer estimates	√		√	√	√	√	√			√	√
	Develop process flow diagrams/system energy balances	√		√	√	√					√	√
	Performance assessment (energy, GHG) <sup>a</sup>	√			√	√					√	
	Independent cost assessment <sup>a</sup>	√			√	√		√			√	
Overall	Ownership cost projection <sup>a</sup>	√			√	√		√		√	√*	
	Solicit input on TIAX analysis	√	√		√	√	√	√*	WIP	√*		
	Analysis update	√			√		√	WIP		WIP		

\* Preliminary results under review.

<sup>a</sup> Work with SSAWG, ANL and SSAWG participants on WTT analysis.

☐ = Not part of current SOW

WIP = Work in progress



Executive Summary Background Timeline

**This report summarizes our updated compressed hydrogen storage assessment for 350 and 700-bar tanks.**

Technology Focus	2004-2007	2008-2010
<b>On-Board Storage System Assessment</b>	<ul style="list-style-type: none"> <li>Compressed Hydrogen                             <ul style="list-style-type: none"> <li>350-bar</li> <li>700-bar</li> </ul> </li> <li>Metal Hydride                             <ul style="list-style-type: none"> <li>Sodium Alanate</li> </ul> </li> <li>Chemical Hydride                             <ul style="list-style-type: none"> <li>Sodium Borohydride (SBH)</li> <li>Magnesium Hydride (MgH<sub>2</sub>)</li> </ul> </li> <li>Cryogenic Hydrogen                             <ul style="list-style-type: none"> <li>Cryo-compressed</li> </ul> </li> </ul>	<ul style="list-style-type: none"> <li>Compressed Hydrogen                             <ul style="list-style-type: none"> <li>350-bar – update</li> <li>700-bar – update</li> </ul> </li> <li>Chemical Hydride                             <ul style="list-style-type: none"> <li>Liquid Hydrogen Carrier (LCH<sub>2</sub>)</li> </ul> </li> <li>Cryogenic Hydrogen                             <ul style="list-style-type: none"> <li>Cryo-compressed – update</li> <li>Liquid Hydrogen (LH<sub>2</sub>) – WIP</li> <li>Activated Carbon – WIP</li> <li>MOF-177</li> </ul> </li> </ul>
<b>Off-Board Fuel Cycle Assessment</b>	<ul style="list-style-type: none"> <li>Compressed Hydrogen                             <ul style="list-style-type: none"> <li>350-bar</li> <li>700-bar</li> </ul> </li> <li>Chemical Hydride                             <ul style="list-style-type: none"> <li>Sodium Borohydride (SBH)</li> </ul> </li> </ul>	<ul style="list-style-type: none"> <li>Compressed Hydrogen                             <ul style="list-style-type: none"> <li>350-bar – update</li> <li>700-bar – update</li> </ul> </li> <li>Chemical Hydride                             <ul style="list-style-type: none"> <li>Liquid Hydrogen Carrier (LCH<sub>2</sub>)</li> <li>Ammonia Borane</li> </ul> </li> <li>Cryogenic Hydrogen                             <ul style="list-style-type: none"> <li>Cryo-compressed</li> <li>Liquid Hydrogen (LH<sub>2</sub>) – WIP</li> </ul> </li> </ul>

Note: Previously analyzed systems will continually be updated based on feedback and new information.



Since completing initial analysis of compressed hydrogen storage systems in 2006, TIAX has periodically updated results to reflect revised assumptions and conduct additional analysis.

In total, TIAX conducted analyses of eight different compressed tank configurations by varying the pressure, number of tanks, and liner type:

Case	Pressure (Bar)	# of tanks	Liner Type
1 – 350-Bar base case	350	1	HDPE (Type IV)
2 – 700-Bar base case	700	1	HDPE (Type IV)
3	350	2	HDPE (Type IV)
4	700	2	HDPE (Type IV)
5	350	1	Aluminum (Type III)
6	700	1	Aluminum (Type III)
7	350	2	Aluminum (Type III)
8	700	2	Aluminum (Type III)

→ The base cases refer to Type IV (HDPE lined) single tank systems at pressures of 350 and 700 bar.

→ The other six cases are discussed as sensitivity cases throughout this report.



Our assessment is based primarily on Quantum’s Type IV compressed hydrogen storage tanks, which they manufacture in low volumes today.

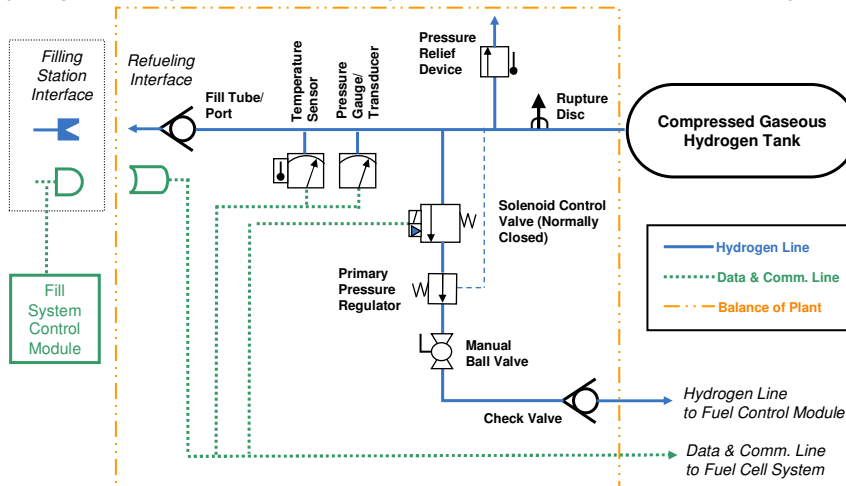

\* Schematic based on the requirements defined in the draft European regulation "Hydrogen Vehicles: On-board Storage Systems" and US Patent 6,041,762.  
 † Secondary Pressure Regulator located in Fuel Control Module of the Fuel Cell System.





The base case Type IV compressed systems' high-volume costs are projected to be 4-5 times higher than the current DOE 2010 cost target of \$4/kWh.

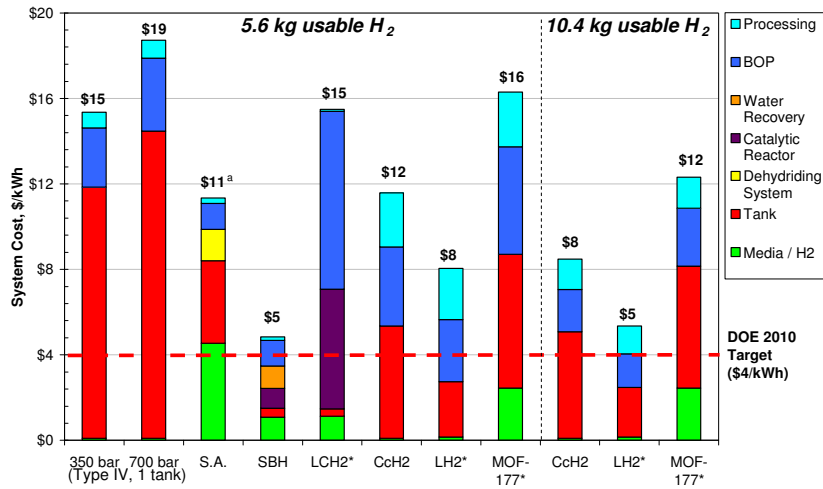

Note: not all hydrogen storage systems shown are at the same stage of development, and each would have different on-board performance characteristics.  
<sup>a</sup> The sodium alanate system requires high temp. waste heat for hydrogen desorption, otherwise the usable hydrogen capacity would be reduced.  
 \* Indicates a preliminary cost assessment, to be reviewed prior to contract completion.



Cost estimates for Type III tanks and dual tank systems project a modest cost increase compared to the Type IV, single tank baseline.

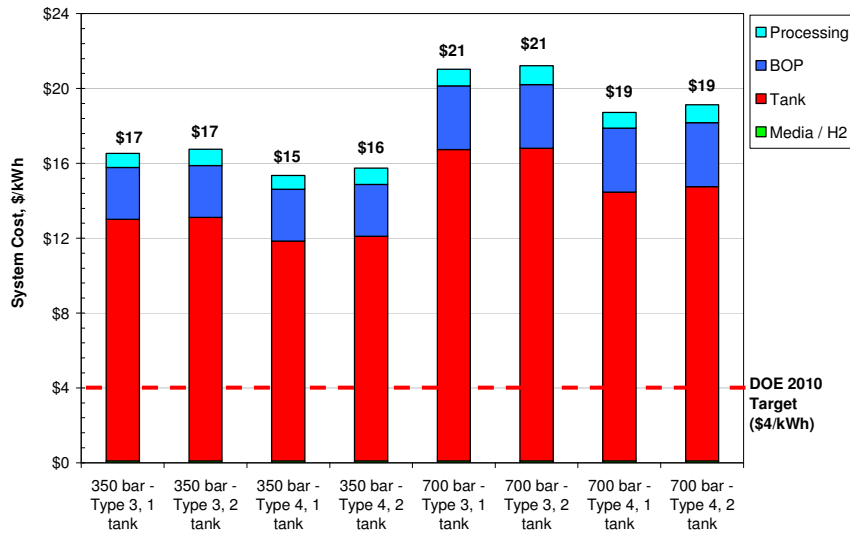

The compressed system refueling costs are projected to be 1.5-2 times more expensive than the current DOE target range of \$2-3/kg.

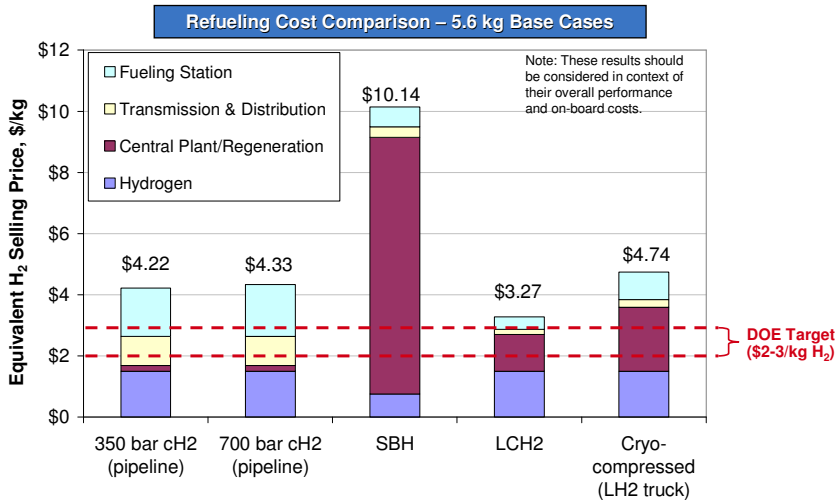

Note: 350-bar, 700-bar and cryo-compressed results were calculated using the base case delivery scenarios in HDSAM v2.06. SBH and LCH<sub>2</sub> results were calculated using a modified H2A Delivery Components Carrier Model v34. All fuel costs exclude fuel taxes.



Fuel system ownership cost for the base case compressed systems are projected to be 30-50% more expensive than gasoline at \$3.00/gal.

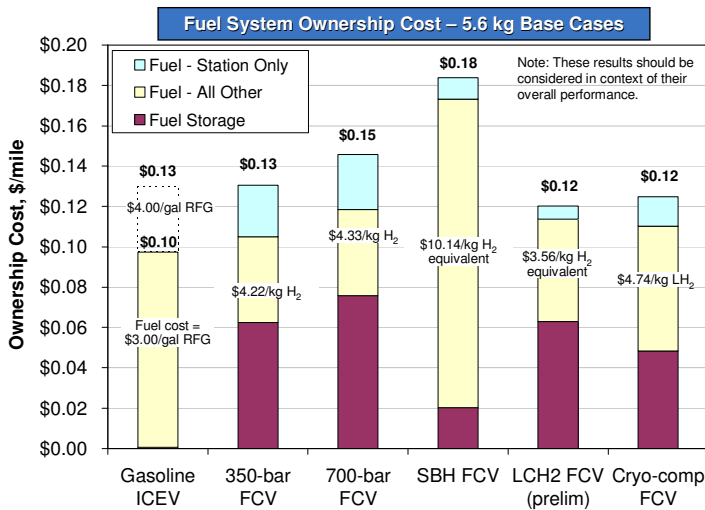

Note: All fuel costs exclude fuel taxes.



**System costs are significantly higher than the current targets and do not have a clear path to achieve the DOE's long-term goals**

- ◆ The high-volume manufactured cost projections of the on-board storage systems are 4-5 times the current DOE 2010 cost target
  - 350-bar and 700-bar Type IV systems are projected to cost \$15/kWh and \$19/kWh
  - Type III tanks add \$1.2/kWh (350-bar) to \$2.2/kWh (700-bar) to the cost of Type IV tanks
  - Dual tank systems add <\$0.5/kWh to the cost of hydrogen storage systems.
- ◆ Factory costs will likely range (95% confidence) between \$10.6 and \$19.7/kWh for the 350-bar system and between \$13.5 and \$27.2/kWh for the 700-bar system
- ◆ Refueling costs based on H<sub>2</sub> pipeline delivery and high-pressure H<sub>2</sub> dispensing, are projected to be 1.5-2 times more expensive than the DOE cost target of \$2-3/kg
- ◆ Compressed fuel system ownership costs will likely be about 30-50% (3-5 ¢/mi or \$250-600/yr) higher than a conventional gasoline ICEV when gasoline is \$3.00/gal
  - 350-bar fuel system ownership costs would be comparable to gasoline at \$4.00/gal
  - 700-bar fuel system ownership costs would be comparable to gasoline at \$4.50/gal

**When on-board and off-board costs are combined, the 350-bar compressed system has potential to have similar ownership costs as a gasoline ICEV.**



Note: All fuel costs exclude fuel taxes.

Sections

1	Executive Summary
2	On-board Assessment
	Approach
	Analysis
	Results
3	Off-board Assessment
4	Conclusions
A	Appendix



In 2004-2006, under a previous DOE contract<sup>1</sup>, TIAX evaluated the cost of compressed hydrogen (CH<sub>2</sub>) storage systems.

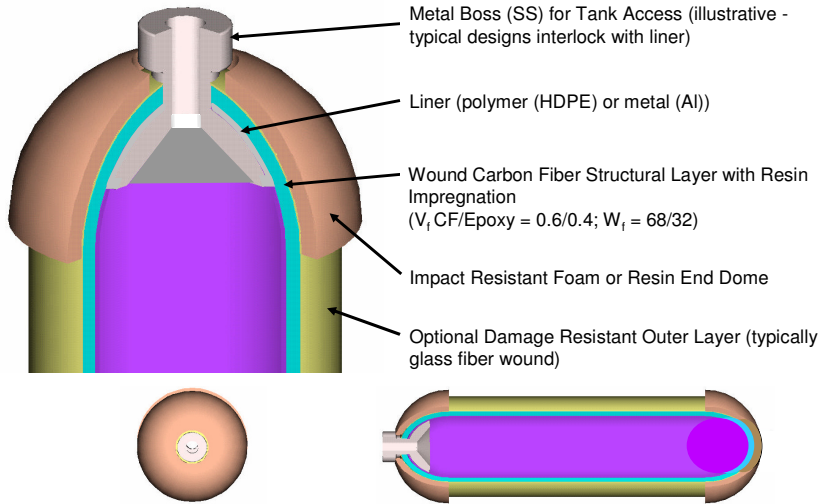

<sup>1</sup> Carlson, E. et al; "Cost Assessment of PEM Fuel Cells for Transportation Application"; DOE Annual Merit Review, May 2004, Washington DC



Since 2006, TIAX has periodically updated results to reflect revised assumptions and conduct additional analysis.

In total, TIAX conducted analysis of eight different compressed tank configurations by varying the following parameters:

- ◆ **Pressure:** Pressures of 350 and 700 bar
- ◆ **Number of tanks:** Single- and dual-tank systems
- ◆ **Tank liner:** Type III (Aluminum lined) and Type IV (HDPE lined) pressure vessels

Case	Pressure (Bar)	# of tanks	Liner Type
1 – 350-Bar base case	350	1	HDPE (Type IV)
2 – 700-Bar base case	700	1	HDPE (Type IV)
3	350	2	HDPE (Type IV)
4	700	2	HDPE (Type IV)
5	350	1	Aluminum (Type III)
6	700	1	Aluminum (Type III)
7	350	2	Aluminum (Type III)
8	700	2	Aluminum (Type III)



The system schematic<sup>1</sup> and bill of materials for the compressed systems were generated through discussions with tank developers. Each of the system design configurations evaluated employs a similar system architecture.

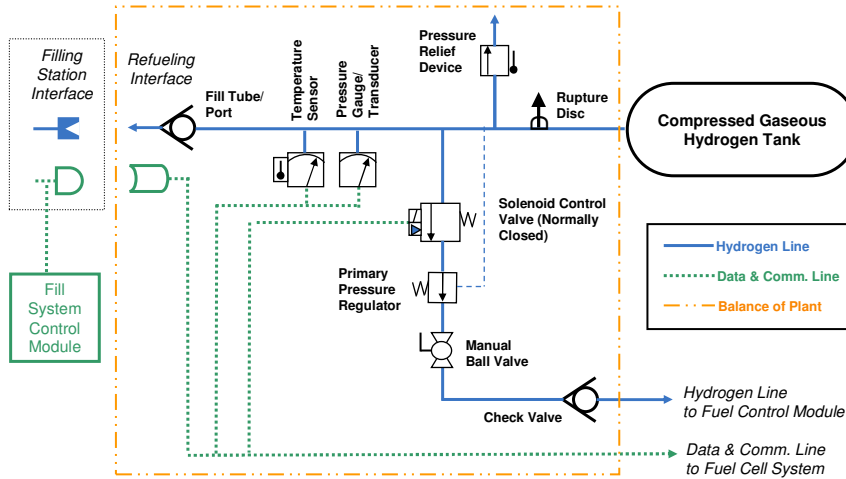

<sup>1</sup> Schematic based on the requirements defined in the draft European regulation "Hydrogen Vehicles: On-board Storage Systems" and US Patent 6,041,762.  
<sup>2</sup> Secondary Pressure Regulator located in Fuel Control Module of the Fuel Cell System.



The high volume (500,000 units/year) manufactured cost for all H<sub>2</sub> storage systems is estimated from raw material prices, capital equipment, labor, and other operating costs.

**BOP Bottom-up Costing Methodology**

- Develop Bill of Materials (BOM)
- Obtain raw material prices from potential suppliers
- Develop manufacturing process map for key subsystems and components
- Estimate manufacturing costs using TIAX cost models (capital equipment, raw material price, labor rates)

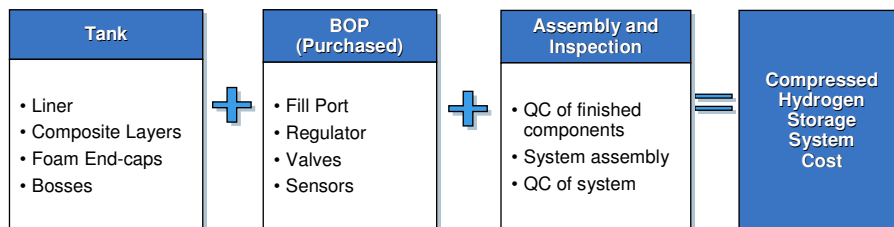

We modeled material and manufacturing process costs for the compressed tanks, while assuming that the BOP is purchased.



The Type IV tanks require composite winding steps that are well established and mature technologies within the Compressed Natural Gas Industry.

**Type IV Carbon Fiber Tank Manufacturing Process Map**

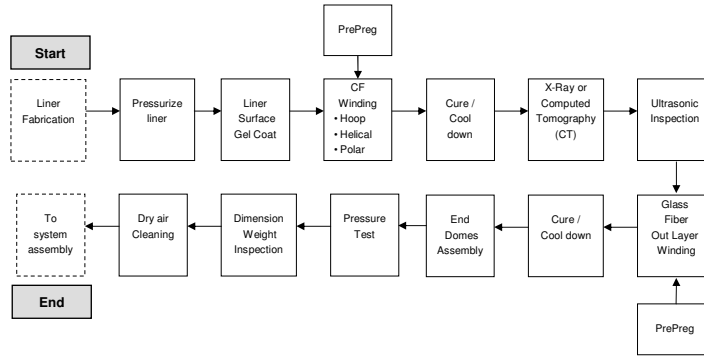

We also assume the system manufacturer purchases pre-impregnated (i.e., “prepreg”) carbon fiber composite as apposed to raw carbon fiber.<sup>1</sup>

Note: About 60 winding machines would be required for 500,000 350-bar tanks per year; about 100 machines would be required for 700-bar tanks.  
<sup>1</sup> See Appendix for details.



Type III aluminum lined tanks use a similar process to Type IV tanks, but include an additional step for autofrettage, a method that reduces the mean stress on the pressurized tank.<sup>1</sup>

**Type III Carbon Fiber Tank Manufacturing Process Map**

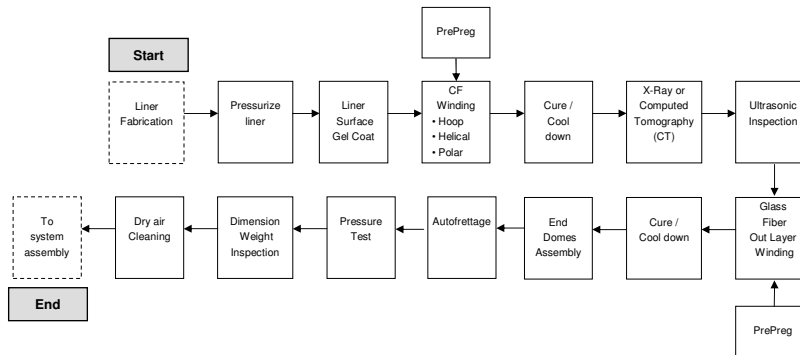

<sup>1</sup>Autofrettage entails pressurizing the liner past its yields point to induce a residual compressive stress in the liner. The vessel’s pressurized contents act in opposition to this compressive stress, thereby reducing the mean stress.  
 Note: About 60 winding machines would be required for 500,000 350-bar tanks per year; about 100 machines would be required for 700-bar tanks.



**We developed BOP cost projections for high-volume production using the Delphi method with validation from Top-down and Bottom-up estimates.**

- ◆ We obtained input from developers on their cost projections for BOP components
  - Tank developers are considering the issue of automotive scale production
  - But, they do not produce tanks at such large scales today
- ◆ Feedback from some Automotive OEMs suggested that these projections did not account for process or technology changes that would be required for automotive scale production
  - High pressure components are often built-to-order or produced in low volumes, so “processing costs” are typically high
  - Vendor quotes contain unspecified markups, which can be substantial in the industry these devices are currently used (unlike the automotive industry, purchasing power of individual buyers is not very strong)
  - Low-volume quotes are sometimes based on laboratory and/or custom components that often exceed the base case system requirements
- ◆ Therefore, we developed BOP cost projections that were more in-line with OEM estimates for high-volume production using the Delphi method with validation from:
  - Top-down estimates - high-volume discounts applied to low-volume vendor quotes using progress ratios
  - Bottom-up estimates - cost modeling using DFMA® software plus mark-ups

**BOP costs were reduced significantly this year based on industry feedback.**



**Key Design Assumptions: Compressed Gaseous Tanks**

Design Parameter	Base Case Value	Basis/Comment
Nominal pressure	350 and 700 bar	Design assumptions based on DOE and industry input
Number of tanks	Single and dual	Design assumptions based on DOE and industry input – base case results reflect single tank systems
Tank liner	Type III (Aluminum) Type IV (HDPE)	Design assumptions based on DOE and industry input – base case results reflect Type IV tanks
Maximum (filling) pressure <sup>1</sup>	350-bar: 438 bar 700-bar: 875 bar	125% of nominal design pressure is assumed required for fast fills to prevent under-filling
Minimum (empty) pressure	20 bar	Discussions with Quantum, 2008
Usable H <sub>2</sub> storage capacity	5.6 kg	Design assumption based on ANL drive-cycle modeling for FCV 350 mile range for a midsized vehicle
Recoverable hydrogen (fraction of stored H <sub>2</sub> )	350 bar: 93% 700 bar: 98%	ANL calculation based on hydrogen storage density at maximum and minimum pressure and temperature conditions
Tank size (water capacity)	350-bar: 258 L 700-bar: 149 L	ANL calculation for 5.6 kg useable H <sub>2</sub> capacity (6.0 and 5.8 kg total H <sub>2</sub> capacity for 350 and 700-bar tanks, respectively)
Safety factor	2.25	Industry standard specification (e.g., ISO/TS 15869) <sup>1</sup>
L/D ratio	3.0	Discussions with Quantum, 2008; based on the outside of the CF wrapped tank



<sup>1</sup> Tank design based on nominal pressure not maximum pressure.

**Key Design Assumptions (continued): Compressed Gaseous Tanks**

Design Parameter	Base Case Value	Basis/Comment
Carbon fiber type	Toray T700S	Discussions with Quantum and other developers, 2008; assumed to have a composite strength of 2,550 MPa for 60% fiber by volume
Translation strength factors	350-bar: 82.5% 700-bar: 80.0%	ANL assumption based on data from Quantum, 2004-09
Composite tensile strength	2,550 MPa	Toray material data sheet for 60% fiber by volume
Adjustment for CF quality	10%	Reduction in average tensile strength to account for variance in CF quality, based on discussion with Quantum and other developers, 2010
Tank liner thickness	5 mm HDPE (Type IV) 7.4 mm Al (Type III)	HDPE: Discussions with Quantum, 2008; typical for Type IV tanks Al: ANL assumption, typical for Type III tanks
Overwrap	1 mm glass fiber	Discussions with Quantum, 2008; common but not functionally required
Protective end caps	10 mm foam	Discussions with Quantum, 2008; for impact protection



<sup>1</sup> Tank design based on nominal pressure not maximum pressure.

**In 2009, we updated our previous compressed tank design analysis based on collaboration with DOE, Quantum, SCI, Toray and ANL.**

- ◆ Tank safety factor was applied to the *nominal* tank pressure (i.e., 350 and 700 bar) rather than *max. filling* over pressure (i.e., 438 and 875 bar) based on new information from industry
- ◆ Tank end dome shape and carbon fiber thicknesses were modified based on ANL's latest performance analysis, which uses a composite pressure vessel algorithm<sup>1</sup>
  - Combination of geodesic and hoop windings assumed, with only geodesic windings on the end domes
  - Non-uniform end dome thickness; thickest at dome peak (exit hole)
  - Model yields carbon fiber weight calculations consistent with Quantum's models
- ◆ Carbon fiber composite tensile strength decreased from 2,940 to 2,550 MPa to be consistent with ANL's latest performance analysis
- ◆ Most BOP component costs were reduced significantly based on industry feedback<sup>2</sup>
- ◆ Other less significant changes were made based on the latest industry feedback or to match the latest ANL assumptions
  - Nominal tank design pressure increased to 350 and 700 bar rather than 5,000 psi (345 bar) and 10,000 psi (689 bar)
  - Minimum tank design pressure changed from 28 bar (400 psi) for 350-bar tanks and 14 bar (200 psi) for 700-bar tanks to 20 bar (290 psi) for both
  - Tank geometry: L/D ratio of 3/1 based on the outside of the composite tank



<sup>1</sup> "Mechanics and Analysis of Composite Materials", Vasiliev and Morozov, New York: Elsevier Science, 2001

<sup>2</sup> See the appendix for details



**In 2010, we expanded our analysis to include alternate tank configurations and continued to revise key assumptions based on feedback from industry.**

- ◆ Type III (Aluminum lined tank) and two-tank system designs were evaluated based on ANL's performance assessment
  - The two-tank system design uses two identical pressure vessels that each hold half of the fuel. However, the two tank system's balance-of-plant is identical to that used for the one tank system (i.e., a single set of component regulates operation for both tanks).
  - The Type III tank's aluminum liner is designed to support a portion of the tank's pressure load, thereby reducing the total carbon fiber requirement.
- ◆ The average carbon fiber composite strength was reduced by 10% to account for variability in carbon fiber quality based on DOE discussions with industry
- ◆ Translation strength factor was increased for the 700 bar tank from 63% to 80% based on ANL discussions with Quantum
- ◆ Additional BOP components were added based on ANL feedback from industry
  - Additional manual service vent valve, check valve, pressure release device, and rupture disks
  - Additional solenoid shutoff valves

**On balance, the 2009 and 2010 updates increased the cost of the 350 bar systems by ~\$2/kWh and decreased the cost of the 700 bar system by ~\$1/kWh**



**We used sensitivity analysis to account for design assumptions that are either not very well established or could change significantly in the near future.**

Design Parameter	Low	Base	High	High/Low Basis/Comment
Safety factor	1.80	2.25	3.00	Based on discussions with Quantum and Dynatek (2005)
Composite tensile strength, MPa	2,295	2,550	2,940	Low 10% below base case; high assumes 60% of fiber strength based on fiber volume fraction
Translation strength factor (350 / 700-bar)	0.78 / 0.55	0.825 / 0.80	0.90 / 0.82	Based on ANL discussions with Quantum and other developers (2009)
Type IV Tank liner thickness, mm	4.0	5.0	6.5	Based on discussions with developers
Type III Tank liner thickness, mm (350 / 700-bar)	5.9/9.7	7.4/12.1	9.6/15.7	Low 80% below base case; high 30% above the base case
Balance of plant part count (Dual tank only)	1X	1X	2X	Base and low case assumes that both tanks in the dual tank system use a single balance of plant; high case assumes that the part count is doubled.



The base case cost projections for the major BOP components were estimated assuming high-volume (i.e., 500,000 units/yr) production.

Purchased Component Cost Est. (\$ per unit)	350-bar Base Case	700-bar Base Case	Comments/Basis
Pressure regulator	\$160	\$200	Industry feedback validated with discussion with Emerson Process Management/Tescom/Northeast Engineering (2009) and DFMA® cost modeling software
Solenoid Control valves (3)	\$186	\$233	Industry feedback validated with quotes and discussion with Pearse-Bertram for Circle Seal solenoid control valve (2009)
Fill tube/port	\$50	\$63	Industry feedback; quick connect capable of high pressures without leaks and accepting signals from the nozzle at the fueling station to open or close
Pressure transducer	\$30	\$38	Industry feedback validated with quotes and discussion with Taber Industries (2009)
Pressure gauge	\$17	\$17	Based on quotes from Emerson Process Management/ Tescom/ Northeast Engineering (2009)
Boss and plug (in tank)	\$15	\$19	Based on price estimate from tank developers (2009), validated with AI raw material price marked up for processing
Other BOP	\$58	\$68	Includes manual service vent valves (2), check valves (2), rupture disks (2), pipe assembly, bracket assembly, pressure relief devices (2), and gas temperature sensor. <sup>1</sup>

<sup>1</sup>Note: Additional purchased component cost projections and a comparison to last year's assumptions are presented in the Appendix.



To account for the inherent uncertainty in the BOP cost projections, we developed “low” and “high” cost estimates as inputs to the sensitivity analysis.

Purchased Component Cost Est. (\$ per unit)	Low (350 / 700-bar)	Base Cases (350 / 700-bar)	High (350 / 700-bar)	High/Low Comments/Basis
Pressure regulator	\$80 / \$100	\$160 / \$200	\$360 / \$450	Low and high based on discussions with tank developers and vendors (2009)
Control valve	\$93 / \$117	\$186 / \$233	\$372 / \$466	Low and high are half and double the base cases, respectively
Fill tube/port	\$25 / \$32	\$50 / \$63	\$100 / \$125	Low and high are half and double the base cases, respectively
Pressure transducer	\$15 / \$19	\$30 / \$38	\$60 / \$76	Low and high are half and double the base cases, respectively
Pressure gauge	\$9 / \$9	\$17 / \$17	\$34 / \$34	Low and high are half and double the base cases, respectively
Boss and plug (in tank)	\$12 / \$15	\$15 / \$19	\$100 / \$125	Low is 75% of base case; high assumes more complex processing requirement



We based the cost of purchased raw materials on raw material databases and discussions with suppliers and adjusted to 2005\$.

Raw Material Cost Estimates, 2005\$/kg	Base Cases	Comment/Basis
Hydrogen	3.0	Consistent with DOE H <sub>2</sub> delivery target
HDPE liner	1.6	Plastics Technology (2008), deflated to 2005\$
Aluminum (6061-T6)	9.6	Bulk price from Alcoa (2009), deflated to 2005\$
Carbon fiber (T700S) prepreg	36.6	Discussion w/ Toray (2007) re: T700S fiber (\$10-\$16/lb, \$13/lb base case in 2005\$); 1.27 prepreg/fiber ratio (Du Vall 2001)
Glass fiber prepreg	4.7	Discussions with AGY (2007) for non-structural fiber glass, deflated to 2005\$
Foam end caps	6.4	Plastics Technology (2008), deflated to 2005\$
Stainless steel (304)	4.7	Average monthly costs from Sep '06 – Aug '07 (MEPS International 2007) deflated to 2005\$ by ~6%/yr
Standard steel	1.0	Estimate based on monthly cost range for 2008-2009 (MEPS International 2009), , deflated to 2005\$

Note: All prices reflect material costs in constant 2005\$



We also developed low and high estimates for the cost of purchased raw materials as inputs to the sensitivity analysis.

Raw Material Cost Estimates, \$/kg	Low	Base Cases	High	High/Low Comments/Basis
Hydrogen	1.5	3.0	6.0	Low and high are half and double the base cases
HDPE liner	0.8	1.6	3.2	Low and high are half and double the base cases
Aluminum (6061-T6)	4.8	9.6	19.2	Low and high are half and double the base cases
Carbon fiber (T700S) prepreg	18.5	36.6	44.9	Low assumes 68% fiber (wt.) at \$10/lb and 32% epoxy at \$5/lb; <sup>a</sup> High is based on discussion w/ Toray (2007) re: T700S fiber at \$16/lb and 1.27 prepreg/fiber ratio (Du Vall 2001)
Glass fiber prepreg	2.9	4.7	9.4	Low and high are 60% and double the base cases
Foam end caps	3.5	6.4	14	Low and high are half and double the base cases
Stainless steel (304)	2.4	4.7	9.4	Low and high are half and double the base cases
Standard steel	0.5	1.0	2.0	Low and high are half and double the base cases

Carbon fiber is already produced at very high-volumes for the Aerospace industry, so it isn't expected to become significantly cheaper in the near term.<sup>1</sup>

<sup>a</sup> Weighted raw material costs would be more relevant for a wet winding process, which may also alter fiber winding processing costs.  
<sup>1</sup> However, there are DOE programs that are looking at ways to significantly reduce carbon fiber costs (e.g., Abdallah 2004).



The costs of key processing steps are estimated from capital equipment, labor, and other operating costs assuming a high level of automation.

Key Processing Steps – Compressed Gas Tanks	350-bar Type IV Single Tank System	700-bar Type IV Single Tank System
Liner Fabrication	\$11	\$10
Carbon Fiber Winding Process	\$83	\$102
Glass Fiber Winding Process	\$7	\$6
Foam End Caps	\$2	\$1
Assembly and Inspection	\$36	\$36
<b>Total</b>	<b>\$138</b>	<b>\$156</b>

- ◆ The processing costs for dual tank Type IV systems are \$162 and \$180 for 350 and 700-bar systems, respectively. This includes a small increase in carbon fiber and larger increases in liner fabrication and glass winding costs.<sup>1</sup>
- ◆ The processing costs for single tank Type III systems are \$141 and \$165 for 350 and 700-bar systems, respectively – a small increase compared to Type IV systems<sup>1</sup>

The higher, 700 bar pressure requirement, primarily increases the cost of the carbon fiber winding process.

<sup>1</sup> A detailed breakdown of dual tank and Type III processing costs is included in the appendix



Processing cost makes up only 5% of the total Type IV system cost due to the assumed high production volumes and large number of purchased components.

On-board System Cost Breakout – Compressed Gas	Type IV 350-bar Base Case			Type IV 700-bar Base Case		
	Material, \$	Processing, \$	Processing Fraction	Material, \$	Processing, \$	Processing Fraction
Hydrogen	\$18	(purchased)	-	\$18	(purchased)	-
Compressed Vessel	\$2,193	\$102	4%	\$2,681	\$119	4%
Liner & Fittings	\$20	\$11	34%	\$14	\$10	43%
Carbon Fiber Layer	\$2,111	\$83	4%	\$2,619	\$102	4%
Glass Fiber Layer	\$30	\$7	18%	\$23	\$6	21%
Foam	\$32	\$2	5%	\$25	\$1	5%
Regulator	\$160	(purchased)	-	\$200	(purchased)	-
Valves	\$226	(purchased)	-	\$282	(purchased)	-
Other BOP	\$130	(purchased)	-	\$155	(purchased)	-
Final Assembly & Inspection	-	\$36	-	-	\$36	-
<b>Total Factory Cost</b>	<b>\$2,727</b>	<b>\$138</b>	<b>5%</b>	<b>\$3,334</b>	<b>\$156</b>	<b>4%</b>

A similar ratio of material to processing cost is seen for Type III and dual tank systems.



The carbon fiber composite layer accounts for about 75% and 80% of the single tank Type IV 350-bar and 700-bar system costs, respectively.

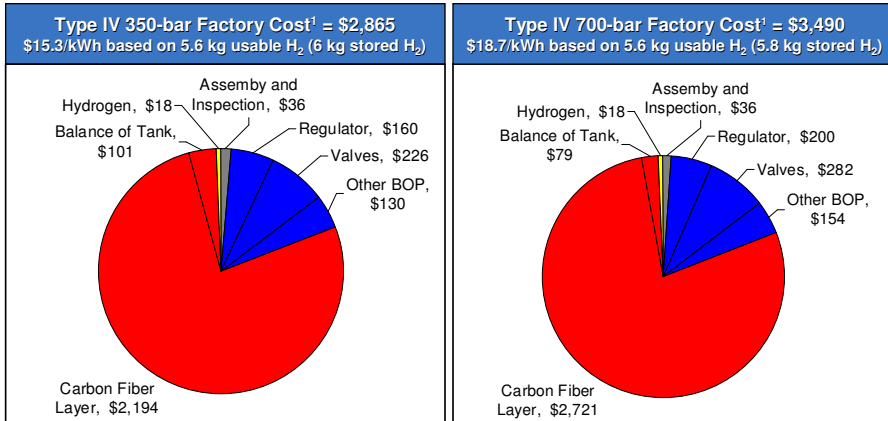

<sup>1</sup> Cost estimate in 2005 USD. Includes processing costs.

These costs, adjusted for progress ratios of 85 to 90%, are consistent with industry factory cost projections for similar tanks at lower production volumes. Details are presented in the Appendix



Single variable sensitivity analysis shows that carbon fiber cost and safety factor assumptions have the biggest impact on our system cost projections.

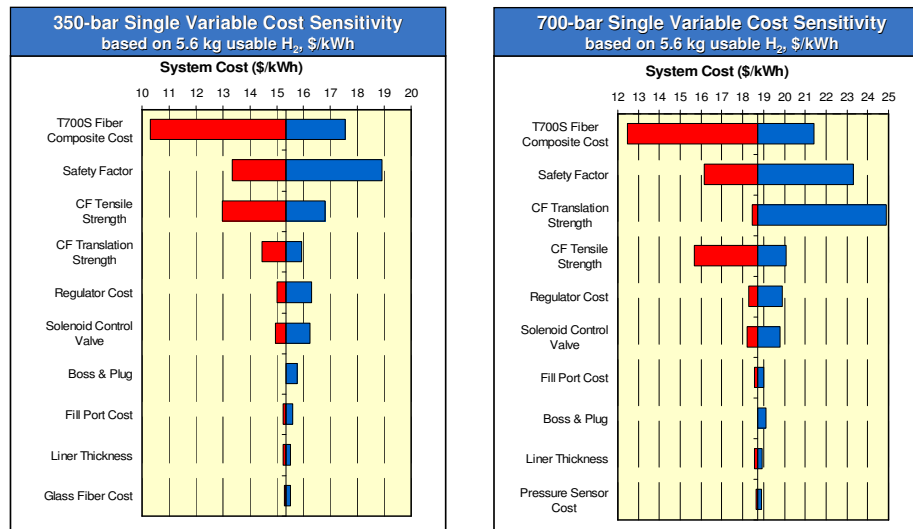

Monte Carlo simulations project that the factory cost is likely to be between \$10.6-19.7/kWh for 350-bar and \$13.5-27.2/kWh for 700-bar tank systems.<sup>1</sup>

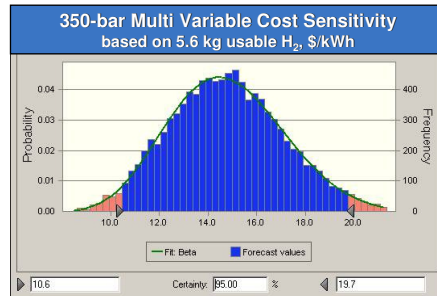

Base Case	15.4
Mean	14.8
Standard Deviation	2.3
"Low" Case <sup>1</sup>	10.60
"High" Case <sup>1</sup>	19.7

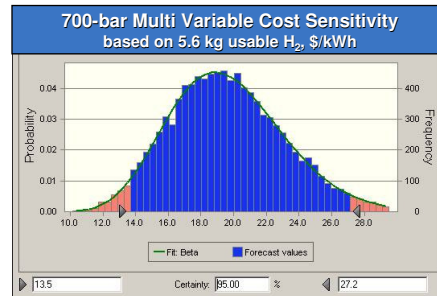

Base Case	18.7
Mean	19.7
Standard Deviation	3.5
"Low" Case <sup>1</sup>	13.5
"High" Case <sup>1</sup>	27.2

<sup>1</sup> The ranges shown here reflect the 95% confidence interval based on the probability distribution.



350 and 700-bar system cost, weight and volume decreased (grav. and vol. capacities increased) due to revised assumptions compared to 2008.

- ◆ The tank safety factor was applied to the *nominal* tank pressure rather than *max. filling* over pressure and most BOP costs were reduced based on industry feedback
- ◆ Changing the tank end dome shape based on ANL's latest performance analysis and increasing the translation strength of the 700 bar system also resulted in decreases to cost, weight, and volume
- ◆ Reducing the carbon fiber composite tensile strength partially offset the above adjustments
- ◆ Reduced balance of plant unit costs, but increased BOP part count resulted in net cost reductions.
- ◆ Other changes to the tank design had a modest impact on the results (e.g., increasing safety factor, decreasing diameter, changing minimum pressure)

2010 Updated Results Compared to 2008 AMR Results	350-bar Base Case		700-bar Base Case	
	2010 / 2008	% Change	2010 / 2008	% Change
Gravimetric Capacity, wt%	5.5 / 5.3	+4%	5.0 / 4.0	+25%
Volumetric Capacity, g H <sub>2</sub> /L	17.5 / 17.0	+3%	26.2 / 23.0	+14%
System Cost, \$/kWh	15.4 / 17.1	-14%	18.7 / 26.7	-30%



**Type III and dual tank systems both show a small increase in system weight and cost relative to single tank, type IV systems.**

Case	Cost (\$/kWh)	Volume (L)	Weight (kg)
350-Bar base, type IV, 1 tank	15.3	320	102
700-Bar base, type IV, 1 tank	18.7	213	112
350-Bar base, type IV, 2 tank	15.7	326	110
700-Bar base, type IV, 2 tank	19.1	219	118
350-Bar base, type III, 1 tank	16.5	321	134
700-Bar base, type III, 1 tank	21.0	224	158
350-Bar base, type III, 2 tank	16.8	324	137
700-Bar base, type III, 2 tank	21.2	226	161

- ◆ Type III designs are projected to increase factory costs by \$200 to \$400 and weight by 35-45 kg.
  - The reduction in carbon fiber enabled by the load-bearing qualities of a Type III aluminum liner is more than offset by its higher cost, weight, and thickness compared to the Type IV HDPE liner.
- ◆ Two-tank systems are projected to increase factory costs by less than \$100
  - The pressure vessel for the single tank system has a lower surface area-to-volume ratio than the dual tank system, but this advantage is largely offset by the fact that the single tank pressure vessel requires thicker vessel walls.
  - We have assumed that the dual tank system's balance of plant is similar to that of the single tank system. Sensitivity analysis is used to assess the cost impact of doubling the BOP part count.



**For each configuration examined, carbon fiber material cost dominates the total system cost.**

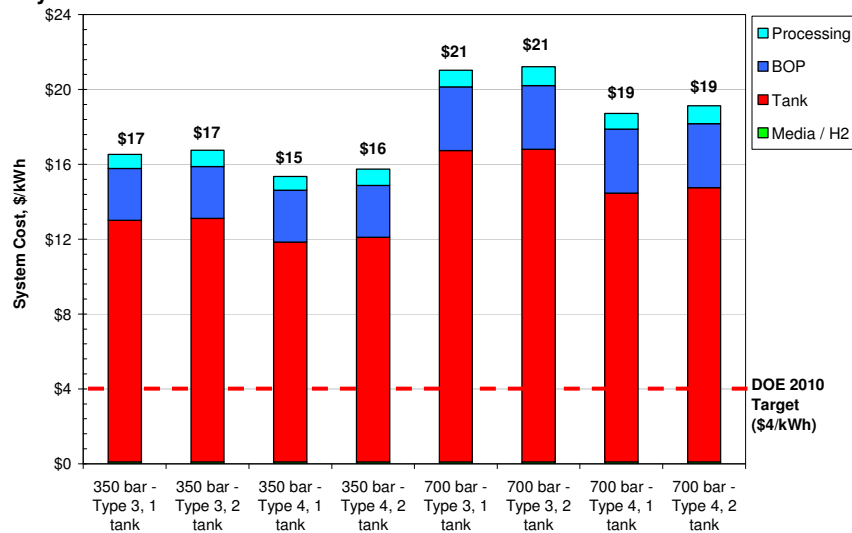

The dual tank systems have a slightly higher cost than single tank systems due to increases in the cost of the pressure vessel.

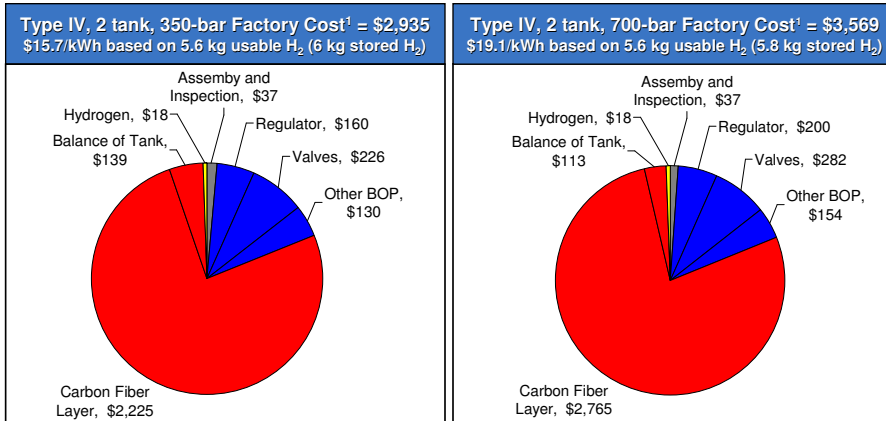

<sup>1</sup> Cost estimate in 2005 USD. Includes processing costs.  
Note: For reference, the Type IV 350-bar single tank system costs \$2,865; the Type IV 700-bar single tank systems costs \$3,490.

The pressure vessel cost increase includes <5% increase in material cost and a 20-25% increase in the tank processing cost.



The carbon fiber composite layer accounts for a smaller fraction of the Type III system cost compared to the Type IV system, but the Type III aluminum liner adds significant additional expense.

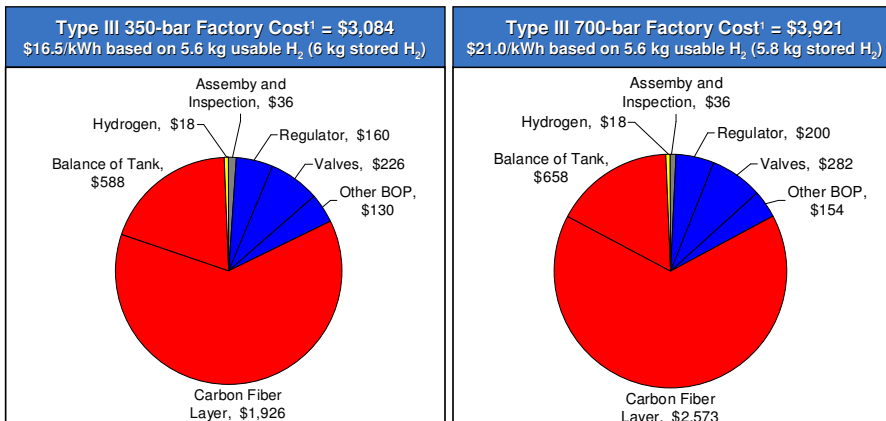

<sup>1</sup> Cost estimate in 2005 USD. Includes processing costs.  
Note: For reference, the Type IV 350-bar single tank system costs \$2,865; the Type IV 700-bar single tank systems costs \$3,490.





For dual tank systems, single-variable sensitivity analysis was used to characterize the cost impact of doubling the balance-of-plant part count

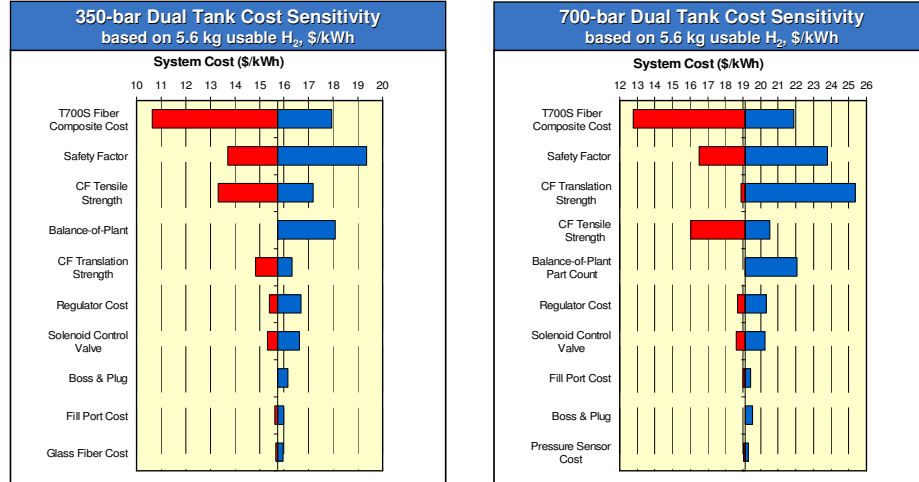

As shown, a second BOP system increases the cost of a dual tank system by \$2.4 and \$3.0/kWh for 350-bar and 700-bar systems, respectively



Monte Carlo simulations of dual tank systems project that the factory cost is likely to be between \$11.6-21.4/kWh for 350-bar and \$14.9-29.6/kWh for 700-bar tank systems.<sup>1</sup>

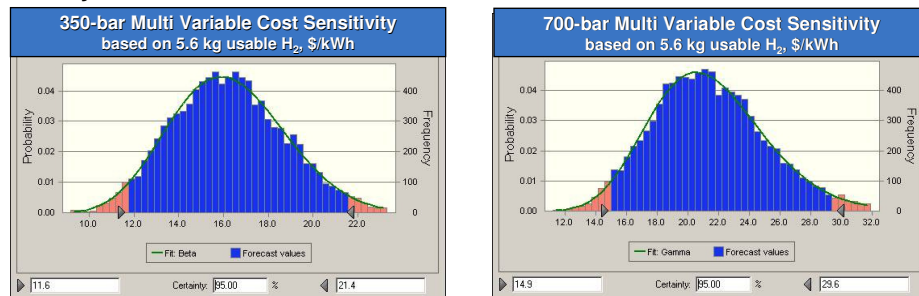

Base Case	15.7
Mean	16.2
Standard Deviation	2.5
"Low" Case <sup>1</sup>	11.6
"High" Case <sup>1</sup>	21.4

Base Case	19.1
Mean	21.2
Standard Deviation	3.8
"Low" Case <sup>1</sup>	14.9
"High" Case <sup>1</sup>	29.6

Due to uncertainty over the BOP design, the 95% confidence interval is shifted higher relative to the base case than that projected for the single tank system.

<sup>1</sup> The ranges shown here reflect the 95% confidence interval based on the probability distribution.



**For Type III systems, the cost and thickness of the aluminum liner have a strong effect on system cost**

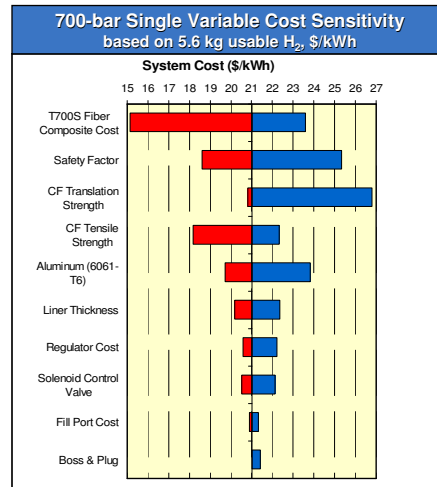
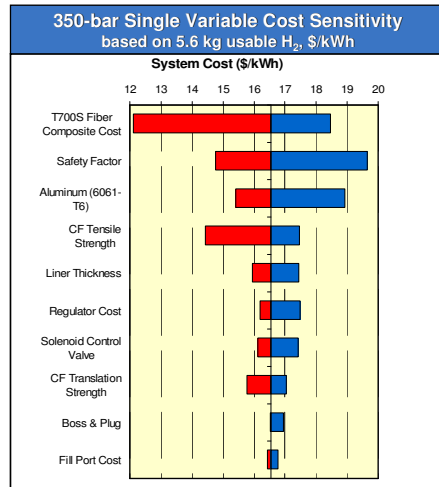

**Monte Carlo simulations project that the factory cost of Type III systems is likely to be between \$12.5-21.2/kWh for 350-bar and \$16.5-30.3/kWh for 700-bar tank systems.<sup>1</sup>**

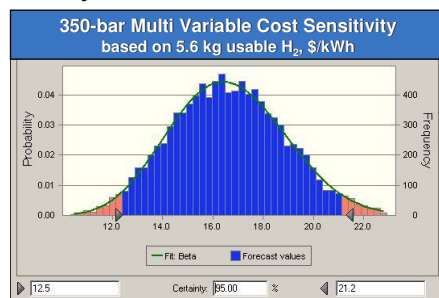

Base Case	15.7
Mean	16.6
Standard Deviation	2.2
"Low" Case <sup>1</sup>	12.5
"High" Case <sup>1</sup>	21.1

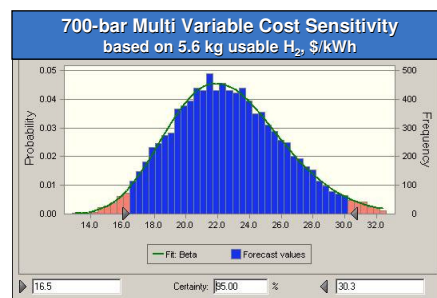

Base Case	21.0
Mean	22.7
Standard Deviation	3.6
"Low" Case <sup>1</sup>	16.5
"High" Case <sup>1</sup>	30.3

<sup>1</sup> The ranges shown here reflect the 95% confidence interval based on the probability distribution.



**Conclusions – Dual Tank and Type III Systems**

- ◆ Cost and performance projections indicate that Type III tanks will be more expensive and heavier than Type IV tanks:
  - Type III tanks require less carbon fiber than Type IV tanks, but the cost and weight of the aluminum liner are significantly higher than those of the HDPE liner.
  - Carbon fiber costs account for 60 to 70% of the cost of Type III tanks, compared to 75 to 80% of the cost of Type IV tanks
- ◆ Dual tank systems come at a small cost increment (\$0.3 to \$0.5/kWh) to single tank systems, and have very little effect on system size and weight.
  - Projections show a slight (<5%) increase in material costs: Single tank pressure vessels have a lower total surface area, but require thicker walls
  - Processing costs are 20 to 25% higher, but these represent less than 5% of the total system cost
  - If dual tank systems are designed to use a separate set of balance-of-plant components for each tank, the cost increase of a dual tank system is \$2.7 to \$3.4/kWh compared to a single tank system.



**The base case Type IV compressed systems' high-volume costs are projected to be 4-5 times higher than the current DOE 2010 cost target of \$4/kWh.**

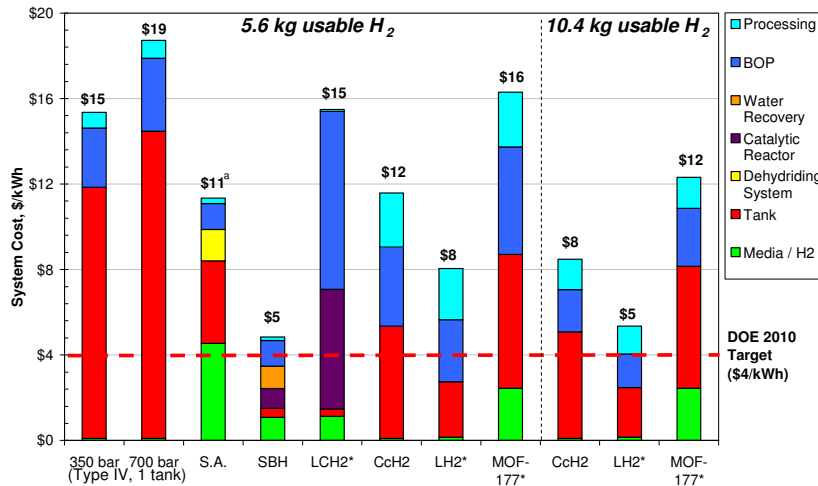

Note: not all hydrogen storage systems shown are at the same stage of development, and each would have different on-board performance characteristics.  
<sup>a</sup> The sodium alanate system requires high temp. waste heat for hydrogen desorption, otherwise the usable hydrogen capacity would be reduced.  
 \* Indicates a preliminary cost assessment, to be reviewed prior to contract completion.



Sections

1	Executive Summary
2	On-board Assessment
3	Off-board Assessment
	Approach
	Analysis
	Results
4	Conclusions
A	Appendix



Off-board Assessment Approach Models/Methods

The off-board assessment makes use of existing models to calculate cost and performance for each technology on a consistent basis.

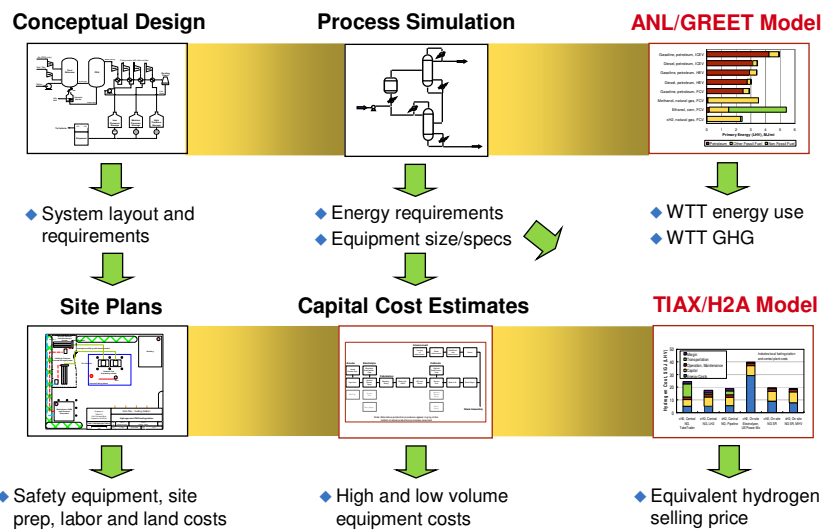

**Cryo-compressed and compressed (350- and 700-bar) hydrogen off-board cost results were calculated using the base case delivery scenarios in HDSAM v2.06.**

HDSAM Delivery Scenario Assumptions	350 and 700-bar Base Cases	Cryo-compressed Base Cases
Hydrogen Market	Urban	Urban
Market Penetration	30%	30%
City Selection	Indianapolis, IN (~1.2M people)	Indianapolis, IN (~1.2M people)
Central Plant $H_2$ Production Cost	\$1.50/kg $H_2$	\$1.50/kg $H_2$
Plant Outage/Summer Peak Storage	Geologic	Cryogenic liquid tanks
Transmission/Distribution Mode	Compressed gas pipeline	$LH_2$ tanker trucks (284 km round trip)
Transmission/Distribution Capacity	NA	4,100 kg $LH_2$
Refueling Station Size	1,000 kg $H_2$ /day	1,000 kg $H_2$ /day
Dispensing Temperature	350-bar = ambient (25°C) 700-bar = -40°C for fast fill	-253°C
Dispensing Pressure	25% over-pressure for fast fill (up to 438 and 875 bar $cH_2$ )	25% over-pressure for fast fill (up to 340 bar $LH_2$ )
Hydrogen Losses	<1%	7.5% (0.5% each from liquefaction, storage and loading; 6% from unloading)
On-board Storage System	350-bar and 700-bar compressed gas	Cryogenic liquid and 272 bar compressed gas



**The chemical hydride (i.e., SBH,  $LCH_2$ ) off-board cost results were calculated using a modified version of the Delivery Components Carrier Model v34.**

- ◆ Most financial assumptions are retained from the original H2A Delivery Components Model
- ◆ New calculation tabs were added as part of the DOE Delivery Project for novel carriers, resulting in the H2A Delivery Components Carrier Model v34
  - Regeneration – calculates material regeneration costs based on capital and operating costs of a central plant and the storage capacity of the material
  - Storage Terminal – calculates offsite storage for fresh and spent materials
  - Trucking – calculates trucking costs for all novel carriers
  - Fueling Station – calculates fueling station costs for onsite novel carrier storage and vehicle fueling
- ◆ These new calculation tabs were populated with inputs based on industry and developer feedback specifically for SBH (MCell, R&H) and  $LCH_2$  (APCI)
  - TIAX made initial estimates consistent with H2A methodology
  - Model and estimates were reviewed with technology developers
  - Model inputs and results were updated



**“Ownership cost” provides a useful metric for comparing storage technologies on an equal footing, accounting for both on- and off-board (i.e., refueling) costs.**

Simple Ownership Cost (OC) Calculation:

$$OC = \frac{C \times DF \times \text{Markup}}{\text{Annual Mileage}} + \frac{FC}{FE}$$

C = Factory Cost of the On-board Storage System  
 DF = Discount Factor (e.g., 15%)  
 FC = Fuel Cost of the Off-board Refueling System  
 FE = Fuel Economy (e.g., 62 mi/kg)

Ownership Cost Assumptions	Gasoline ICEV	Hydrogen FCV	Basis/Comment
Annual Discount Factor on Capital	15%	15%	Input assumption
Manufacturer + Dealer Markup	1.74	1.74	Assumed mark-up from factory cost estimates <sup>1</sup>
Annual Mileage (mi/yr)	12,000	12,000	H2A Assumption
Vehicle Energy Efficiency Ratio	1.0	2.0	Based on ANL drive-cycle modeling for mid-sized sedan
Fuel Economy (mpgge)	31	62	ICEV: Combined CAFE sales weighted FE estimate for MY 2007 passenger cars <sup>2</sup>
H <sub>2</sub> Storage Requirement (kg H <sub>2</sub> )	NA	5.6	Design assumption based on ANL drive-cycle modeling

<sup>1</sup> Source: DOE, "Effects of a Transition to a Hydrogen Economy on Employment in the United States", Report to Congress, July 2008  
<sup>2</sup> Source: U.S. Department of Transportation, NHTSA, "Summary of Fuel Economy Performance," Washington, DC, March 2007

**This ownership cost assessment implicitly assumes that each fuel system and vehicle has similar maintenance costs and operating lifetime.**



**The compressed system refueling costs are projected to be 1.5 to 2 times higher than the current DOE target range of \$2-3/kg.**

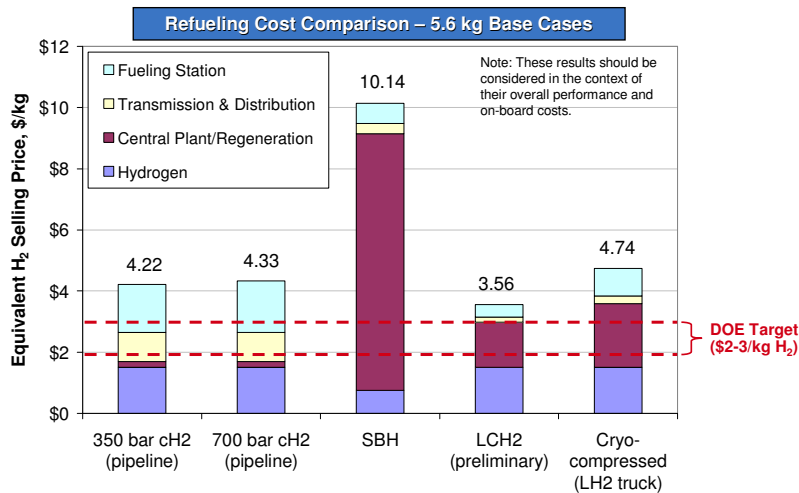

Note: 350-bar, 700-bar and cryo-compressed results were calculated using the base case delivery scenarios in HDSAM v2.06. SBH and LCH<sub>2</sub> results were calculated using a modified H2A Delivery Components Carrier Model v34. All fuel costs exclude fuel taxes.



Fuel system ownership cost for the base case compressed systems are projected to be 30-50% more expensive than gasoline at \$3.00/gal.

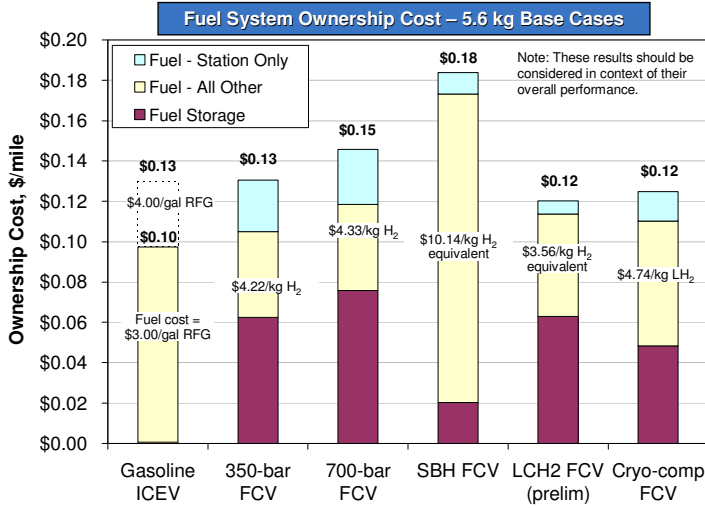

Note: All fuel costs exclude fuel taxes.



Sections

- 1 Executive Summary
- 2 On-board Assessment
- 3 Off-board Assessment
- 4 Conclusions**
- A Appendix



**System costs are significantly higher than the current targets and do not have a clear path to achieve the DOE's long-term goals**

- ◆ The high-volume manufactured cost projections of the on-board storage systems are 4-5 times the current DOE 2010 cost target
  - 350-bar and 700-bar Type IV systems are projected to cost \$15/kWh and \$19/kWh
  - Type III tanks add \$1.2/kWh (350-bar) to \$2.2/kWh (700-bar) to the cost of Type IV tanks
  - Dual tank systems add <\$0.5/kWh to the cost of hydrogen storage systems.
- ◆ Factory costs will likely range (95% confidence) between \$10.6 and \$19.7/kWh for the 350-bar system and between \$13.5 and \$27.2/kWh for the 700-bar system
- ◆ Refueling costs based on H<sub>2</sub> pipeline delivery and high-pressure H<sub>2</sub> dispensing, are projected to be 1.5-2 times more expensive than the DOE cost target of \$2-3/kg
- ◆ Compressed fuel system ownership costs will likely be about 30-50% (3-5 ¢/mi or \$250-600/yr) higher than a conventional gasoline ICEV when gasoline is \$3.00/gal
  - 350-bar fuel system ownership costs would be comparable to gasoline at \$4.00/gal
  - 700-bar fuel system ownership costs would be comparable to gasoline at \$4.50/gal

**When on-board and off-board costs are combined, the 350-bar compressed system has potential to have similar ownership costs as a gasoline ICEV.**



Note: All fuel costs exclude fuel taxes.

Sections

1	Executive Summary
2	On-board Assessment
3	Off-board Assessment
4	Conclusions
A	Appendix
	On-board Assessment
	Off-board Assessment





The on-board cost and performance analyses are based on detailed technology assessment and bottom-up cost modeling.

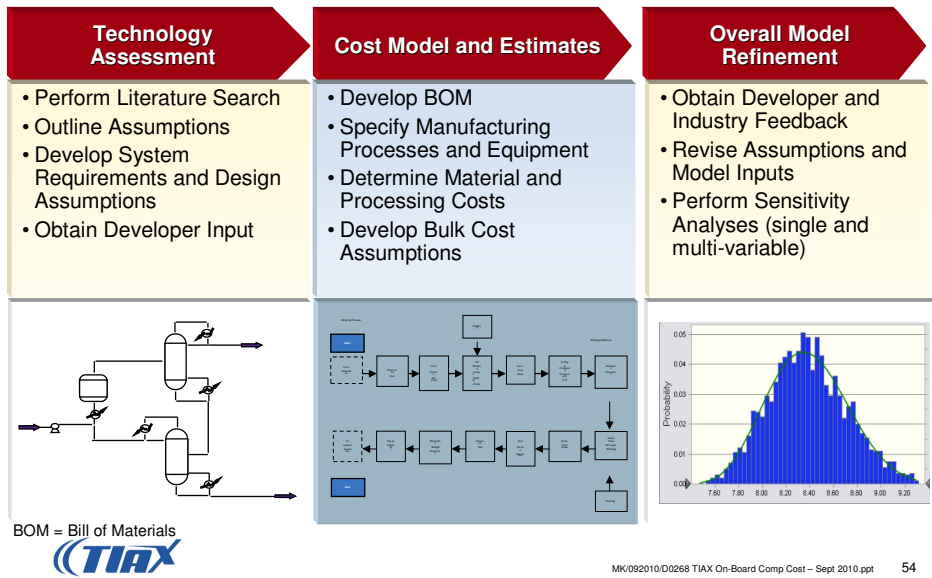

The cost of capital equipment, buildings, labor, and utilities are included in our processing cost assessments.

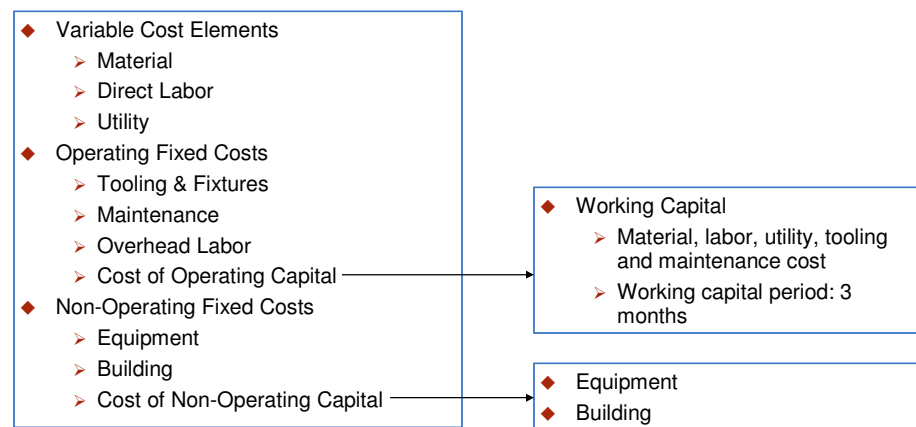

We assume 100% debt financed with an annual interest rate of 15%, 10-year equipment life, and 25-year building life.



The cost model estimates the high volume factory cost of the onboard fuel system.

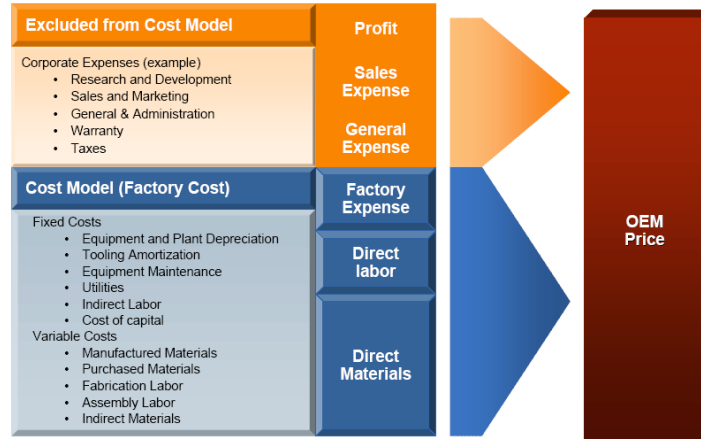

Profit, sales and general expenses are not included in the on-board system cost analysis, consistent with other TIAX cost analyses for DOE of, for example, PEMFC technology.



Tank end dome shape and carbon fiber thicknesses are based on ANL's latest performance analysis, which uses a composite pressure vessel algorithm.<sup>1,2</sup>

- ◆ Combination of geodesic and hoop windings assumed, with only geodesic windings on the end domes
- ◆ Non-uniform end dome thickness; thickest at dome peak (exit hole)
- ◆ Model yields carbon fiber weight calculations consistent with Quantum's models for compressed hydrogen (i.e., 350 and 700-bar) storage tanks
- ◆ Tank safety factor applied to the *nominal* tank pressure (i.e., 350 and 700 bar)
- ◆ Carbon fiber composite tensile strength assumed to be 2,550 MPa based on T700S Technical Data Sheet (Torayca® 2009).
  - Due to variance in carbon fiber quality, the *average* carbon fiber tensile strength was assumed to be 10% lower than the rated tensile strength.

<sup>1</sup> "Mechanics and Analysis of Composite Materials", Vasiliev and Morozov, New York: Elsevier Science, 2001

<sup>2</sup>Hua, T, Peng, J, and Ahluwalia, R. "Analysis of Compressed Hydrogen Systems." Argonne National Labs. December 1, 2009.



**Fiber filament winding time is determined by the actual winding time plus setup time. Filament winding is an inherently slow process.**

$$T_f = (M_f / \mu) / S / N_s / N_t + T_s$$

T<sub>f</sub>: Actual winding time (min)  
M<sub>f</sub>: Carbon fiber weight (g)  
μ: Carbon fiber mass per unit length (g/1000m)  
S: Winding speed (m/min)  
N<sub>s</sub>: Number of spindles  
N<sub>t</sub>: Number of tows  
T<sub>s</sub>: Setup time

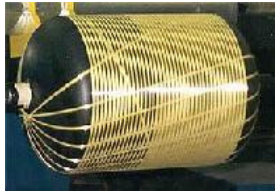

Winding Process



Winding Machine



**We assume the system manufacturer purchases pre-impregnated (i.e., “prepreg”) carbon fiber composite as apposed to raw carbon fiber.**

- ◆ We assume the system manufacturer purchases pre-impregnated (i.e., “prepreg”) carbon fiber composite at a price that is 1.27 (prepreg/fiber ratio) times higher than the raw carbon fiber material (Du Vall 2001)
- ◆ An alternative approach would be to assume a wet resin winding process that would allow the purchase of raw carbon fiber material instead of buying prepreg tow fiber
- ◆ We selected the prepreg winding process based on the assumption that it results in greater product throughput and reduced environmental hazards (including VOCs, ODCs, and GHG emissions) compared to a wet winding process
  - According to Du Vall (2001), greater throughput is typically achieved because prepreg tow allows for more precise control of resin content, yielding less variability in the cured part mechanical properties and ensuring a more consistent, repeatable, and controllable material compared to wet winding
  - In addition, wet winding delivery speeds are limited due to the time required to achieve good fiber/resin wet out
  - The downside is that the prepreg raw material costs are higher than for wet winding
- ◆ It might be possible to reduce the overall manufactured cost of the composite, perhaps closer to the cost per pound of the carbon fiber itself (\$13/lb) or even lower (since the resin is cheaper per pound), if the wet winding process is proven to be more effective
  - A detailed evaluation that is required to explore these cost trade-offs is beyond our scope of work
  - Instead, we address the potential for lower carbon fiber composite costs in the sensitivity analysis



**We projected the cost of the miscellaneous BOP components using a combination of industry feedback, top-down and bottom-up estimates.**

Purchased Component Cost Est. (\$ per unit)	350-bar Base Case	700-bar Base Case	Comments/Basis
<b>Fittings and pipe</b>	\$7	\$7	Based on estimate of weight and SS304 raw material price marked up for processing
<b>Check valve (2)</b>	\$14	\$17.50	Based on quotes from Bertram Controls for Circle Seal check valve (2009)
<b>Manual valve (2)</b>	\$14	\$17.50	Based on DFMA® software for a similar component
<b>Mounting bracket (2)</b>	\$6	\$6	Based on estimate of weight and standard steel raw material price of \$1/kg
<b>Pressure relief device (2)</b>	\$10	\$12.50	Based on similar component with markups for higher pressure; thermally activated fuse metal device
<b>Temperature sensor</b>	\$5	\$5	Based on whole sale price estimate for gas temperature probe
<b>Rupture disc</b>	\$2	\$2	Based on discussions with developers and vendors



**We developed low and high estimates for key processing cost assumptions as input to the sensitivity analysis.**

Processing Cost Assumptions	Low	Base Cases	High	Comments/Basis
<b># Tows in the CF Winding</b>	6	12	24	Discussions with tank developers (2007)
<b># Tows in the GF Winding</b>	12	16	14	Discussions with tank developers (2007)
<b>CF Filament Winding Speed (m/min)</b>	15	30	60	Discussions with tank developers (2007)
<b>GF Filament Winding Speed (m/min)</b>	15	30	60	Discussions with tank developers (2007)
<b>Filament Winding Machine Cost (\$1,000s)</b>	150	200	300	Discussions with tank developers (2007)



The processing costs for dual tank systems are 15 to 20% higher than for single tank systems. This includes a 2X increase in liner fabrication and glass winding costs.

Key Processing Steps – Compressed Gas Tanks	350-bar Type IV Dual Tank	700-bar Type IV Dual Tank
Liner Fabrication	\$21	\$21
Carbon Fiber Winding Process	\$90	\$109
Glass Fiber Winding Process	\$12	\$11
Foam End Caps	\$3	\$2
Assembly and Inspection	\$37	\$37
<b>Total</b>	<b>\$162</b>	<b>\$180</b>

For reference, the processing costs of 350-bar and 700-bar single tank systems are \$138 and \$156, respectively



The processing costs for Type III systems are 2 to 6% higher than Type IV systems. This includes a large increase in liner fabrication cost and a small decrease in the carbon fiber winding cost

Key Processing Steps – Compressed Gas Tanks	350-bar Type III Single Tank	700-bar Type III Single Tank
Liner Fabrication	\$23	\$25
Carbon Fiber Winding Process	\$74	\$96
Glass Fiber Winding Process	\$7	\$6
Foam End Caps	\$2	\$1
Assembly and Inspection	\$36	\$36
<b>Total</b>	<b>\$141</b>	<b>\$165</b>

For reference, the processing costs of 350-bar and 700-bar single tank systems are \$138 and \$156, respectively



**Since the initial 2004 assessment, we have continually updated our compressed system models based on new information from developers and industry.**

- ◆ Key 2006 Adjustments
  - Carbon fiber translation efficiencies of 81.5% for 350-bar and 63% for 700-bar tanks were used based on published information from Quantum<sup>1</sup>
  - Safety factor changed from 2.25 to 2.35 based on industry feedback
- ◆ Key 2008 Updates
  - Safety factor applied to max filling over pressure (i.e., 438 and 875 bar) rather than nominal tank pressure (i.e., 350 and 700 bar) based on industry feedback
  - Raw carbon fiber material cost updated from \$10/lb to \$13/lb for fiber based on feedback from manufacturer (30% increase)
  - Safety factor changed from 2.35 back to 2.25 based on new industry feedback
  - 350-bar translation efficiency adjusted to 82.5% based on ANL assumption
- ◆ Key 2009 Updates
  - Safety factor applied to nominal tank pressure (i.e., 350 and 700 bar) rather than max filling over pressure (i.e., 438 and 875 bar) based on new industry feedback
  - Carbon fiber composite tensile strength decreased from 2,940 MPa to 2,550 MPa based on ANL assumption
  - Tank end dome shape and carbon fiber thicknesses were modified based on ANL's latest performance analysis
  - Other less significant changes were made based on industry feedback or to match ANL assumptions
  - BOP costs reduced based on industry feedback



<sup>1</sup> Previously assumed 100% translation efficiency due to lack of published information.

**Compressed system models updates (Cont'd)**

- ◆ Key 2010 Adjustments
  - Type III (Aluminum lined tank) and two-tank system designs were evaluated based on ANL's performance assessment
  - The average carbon fiber composite strength was reduced by 10% to account for variability in carbon fiber quality based on DOE discussions with industry
  - Translation strength factor was increased for the 700 bar tank from 63% to 80% based on ANL discussions with Quantum
  - Additional manual service vent valve, check valve, pressure release device, and rupture disks, and solenoid shutoff valves were added to the balance of plant



<sup>1</sup> Previously assumed 100% translation efficiency due to lack of published information.

**Cost projections for the BOP components were reduced significantly in 2009-2010 based on industry feedback and additional analysis.**

Purchased Component Cost Est. (\$ per unit)	350-bar Base Cases			700-bar Base Cases		
	2010	2008 AMR	% Change	2010	2008 AMR	%Change
Pressure regulator	\$160	\$250	-36%	\$200	\$350	-43%
Solenoid Control valve (3)*	\$186	\$40	365%	\$232.5	\$50	365%
Fill tube/port	\$50	\$80	-38%	\$62.5	\$100	-38%
Pressure transducer	\$30	\$20	50%	\$37.5	\$30	25%
Pressure gauge	\$17	NA	100%	\$17	NA	100%
Boss and plug (in tank)	\$15	\$100	-85%	\$19	\$120	-84%
Fittings and pipe	\$7	\$30	-77%	\$7	\$40	-83%
Check valve (2)*	\$14	\$40	-65%	\$17.50	\$50	-65%
Manual valve (2)*	\$14	\$40	-65%	\$17.50	\$50	-65%
Mounting bracket	\$6	\$10	-40%	\$6	\$10	-40%
Pressure relief device (2)*	\$10	\$40	-75%	\$12.50	\$50	-75%
Temperature sensor	\$5	\$20	-75%	\$5	\$20	-75%
Rupture disc (2)*	\$2	\$40	-95%	\$2	\$50	-96%
<b>Total BOP</b>	<b>\$516</b>	<b>\$710</b>	<b>-27%</b>	<b>\$636</b>	<b>\$910</b>	<b>-30%</b>

**Additional quantities of several components were included in the revised cost estimates (marked with a \*)**



**Our system cost estimates, adjusted for progress ratios of 85 to 90%, are consistent with industry factory cost projections for similar tanks at lower production volumes.**

- ◆ Industry factory cost projections for low volume manufacturing (i.e., 1,000 units per year) range from \$45-55/kWh for 350-bar tank systems and \$55-65/kWh for 700-bar tank systems
  - Excludes valves and regulators
  - Industry projections are for 100-120 liter water capacity tanks versus 149-258 liter water capacity tank designs evaluated by TIAX
- ◆ Removing valve and regulator costs from the TIAX base case cost projections results in a high-volume (500,000 units per year) factory cost of \$13/kWh and \$16/kWh for 350-bar and 700-bar tank systems, respectively
- ◆ These results compare well to the low volume industry projections assuming progress ratios of 85-90%
  - The progress ratio (pr) is defined by speed of learning (e.g., how much costs decline for every doubling of capacity)
  - While 85-90% progress ratio is typically on the high end of what would be expected (progress ratios of 70-90% are typical), this is likely due to carbon fiber representing such a large fraction of the overall system cost
  - Unlike other system components, carbon fiber is already produced at very high-volumes for the aerospace industry, so it isn't expected to become significantly cheaper due to the typical learning curves assumed by a projection based on progress ratios<sup>1</sup>

<sup>1</sup> However, there are DOE programs that are looking at ways to significantly reduce carbon fiber costs (e.g., Abdallah 2004).



In addition to fuel system ownership cost, we can also look at the overall vehicle ownership cost, where the vehicle purchased cost is included.

Vehicle Cost Assumptions <sup>1</sup>	Gasoline ICEV	Hydrogen FCV	Basis/Comment
Glider	\$7,148	\$7,148	Group of components (e.g., body, chassis, suspension) that will not undergo radical change
IC Engine/Fuel Cell Subsystem	\$2,107	\$2,549	Includes engine cooling radiator
Transmission, Traction Motor, Power Electronics	\$1,085	\$1,264	Includes electronics cooling radiator
Exhaust, Accessories	\$500	\$500	Assumes exhaust and accessories are \$250 each
Energy Storage	\$110	\$1,755	Includes battery hardware, acc battery and energy storage cooling radiator
Fuel Storage	\$51	\$4,997 <sup>a</sup>	H <sub>2</sub> storage cost from On-board Cost Assessment
Manufacturing/ Assembly Markup	\$5,500	\$7,045	OEM manufacturing cost is marked up by a factor of 1.5 and a dealer mark-up of 1.16
Dealer Markup	\$2,690	\$3,445	
<b>Total Retail Price</b>	<b>\$19,191</b>	<b>\$28,034</b>	

<sup>a</sup> Fuel Storage cost for the Hydrogen FCV option assumes 350 bar compressed hydrogen on-board storage system at \$15.4/kWh.  
<sup>1</sup> Source: DOE, "Effects of a Transition to a Hydrogen Economy on Employment in the United States", Report to Congress, July 2008. All costs, except for the FCV Fuel Storage costs, are based on estimates for the Mid-sized Passenger Car case. See report for details.

Vehicle cost estimates assume that all FCV components, except the fuel storage system, meet DOE's cost goals for 2015 and beyond.<sup>1</sup>



When the whole vehicle is included, and using an O&M cost of \$0.043/gge for all cases, the compressed FCV ownership cost is projected to be 10 to 15% higher than a conventional gasoline ICEV when gasoline is \$3/gal.

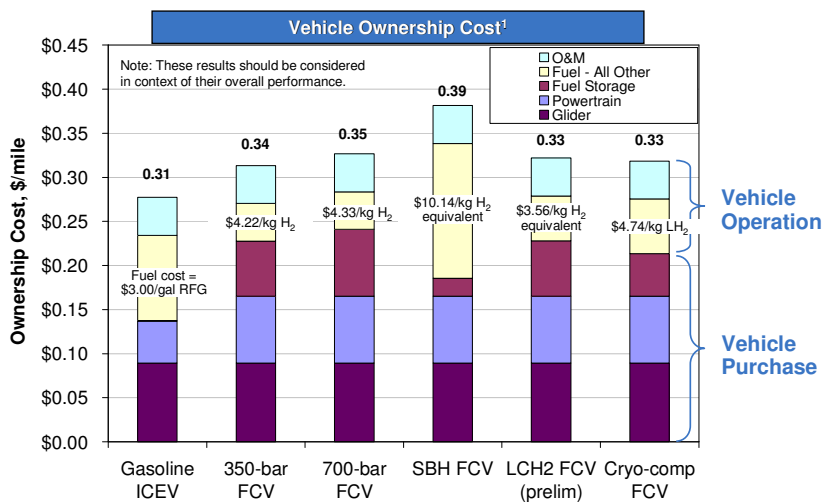

Note: All fuel costs exclude fuel taxes.  
 O&M: Operating & Maintenance  
<sup>2</sup> 5.6 kg usable hydrogen base cases for FCVs





**Nuclear Engineering Division**

Argonne National Laboratory  
9700 South Cass Avenue, Bldg. 208  
Argonne, IL 60439-4842

[www.anl.gov](http://www.anl.gov)



U.S. DEPARTMENT OF  
**ENERGY**

Argonne National Laboratory is a U.S. Department of Energy  
laboratory managed by UChicago Argonne, LLC