

# Byggmeister Test Home: Cold Climate Multifamily Masonry Building Condition Assessment and Retrofit Analysis

H. Wytrykowska, K. Ueno, and R. Van Straaten  
*Building Science Corporation*

September 2012

## NOTICE

This report was prepared as an account of work sponsored by an agency of the United States government. Neither the United States government nor any agency thereof, nor any of their employees, subcontractors, or affiliated partners makes any warranty, express or implied, or assumes any legal liability or responsibility for the accuracy, completeness, or usefulness of any information, apparatus, product, or process disclosed, or represents that its use would not infringe privately owned rights. Reference herein to any specific commercial product, process, or service by trade name, trademark, manufacturer, or otherwise does not necessarily constitute or imply its endorsement, recommendation, or favoring by the United States government or any agency thereof. The views and opinions of authors expressed herein do not necessarily state or reflect those of the United States government or any agency thereof.

Available electronically at <http://www.osti.gov/bridge>

Available for a processing fee to U.S. Department of Energy  
and its contractors, in paper, from:

U.S. Department of Energy  
Office of Scientific and Technical Information  
P.O. Box 62  
Oak Ridge, TN 37831-0062  
phone: 865.576.8401  
fax: 865.576.5728

email: <mailto:reports@adonis.osti.gov>

Available for sale to the public, in paper, from:

U.S. Department of Commerce  
National Technical Information Service  
5285 Port Royal Road  
Springfield, VA 22161  
phone: 800.553.6847  
fax: 703.605.6900

email: [orders@ntis.fedworld.gov](mailto:orders@ntis.fedworld.gov)

online ordering: <http://www.ntis.gov/ordering.htm>



## **Byggmeister Test Home: Cold Climate Multifamily Masonry Building Condition Assessment and Retrofit Analysis**

Prepared for:

The National Renewable Energy Laboratory  
through the U.S. Department of Energy's Building America Program  
15013 Denver West Parkway  
Golden, CO 80401

Prepared by:

H. Wytrykowska, K. Ueno, R. Van Straaten,  
Building Science Corporation  
30 Forest Street  
Somerville, MA 02143

NREL Technical Monitor: Cheryn Engebrecht

Prepared under Subcontract No. KNDJ-0-40337-00

September 2012

**[This page left blank]**

## Contents

List of Figures .....	vi
List of Tables .....	viii
Definitions.....	ix
Executive Summary .....	x
<b>1 Introduction.....</b>	<b>1</b>
1.1 Context and Relevance to Other Homes .....	1
<b>2 Site Assessment for Jamaica Plain Three-Family.....</b>	<b>2</b>
2.1 Exterior Masonry Condition Assessment .....	2
2.2 Basement Condition Assessment .....	8
2.3 Roof Assessment.....	11
2.4 Windows Assessment .....	13
2.5 Airtightness Testing.....	13
2.6 Mechanical System and Domestic Hot Water Assessment.....	15
<b>3 Energy Use and Modeling of Upgrade Options for Jamaica Plain Three-Family .....</b>	<b>17</b>
3.1 Actual Energy Use (Utility Bills) .....	17
3.2 Energy Modeling of Upgrade Options (EnergyGauge USA Parametric).....	19
3.3 Cost Effectiveness of the Retrofit Measures.....	22
<b>4 Retrofit Measure Discussion for Jamaica Plain Three-Family.....</b>	<b>25</b>
4.1 Enclosure System Upgrades .....	25
4.1.1 Exterior Brick Bulk Water Control.....	25
4.1.2 Foundation Wall Insulation.....	26
4.1.3 Basement Slab Retrofit .....	28
4.1.4 Hallway Conditions and Skylight .....	30
4.2 Mechanical System Upgrades.....	31
4.2.2 Mini-Split Space Conditioning .....	31
4.2.3 Domestic Hot Water Equipment.....	34
<b>5 Masonry Insulation THERM Modeling for Jamaica Plain Three-Family.....</b>	<b>35</b>
5.1 Interior Insulation of Tee (Party) Wall .....	35
5.2 Exterior Insulation of Tee (Party) Wall .....	40
<b>6 Brick Freeze-Thaw Analysis for Jamaica Plain Three-Family.....</b>	<b>44</b>
6.1 Material Property Test Results.....	44
6.1.1 Dry Density.....	44
6.1.2 Water Absorption Coefficient (A-value) .....	45
6.1.3 Free Water Saturation .....	45
6.1.4 Vacuum Saturation .....	45
6.1.5 Critical Degree of Saturation .....	46
6.2 Hygrothermal Simulations .....	46
6.2.1 Air Leakage.....	46
6.2.2 Climate Data .....	47
6.2.3 Material Properties.....	47
6.2.4 Assessing Freeze-Thaw Performance .....	47
6.2.5 Simulation Model .....	49
6.2.6 Other Considerations .....	50
6.3 Results and Interpretation .....	50
6.3.1 Freeze-Thaw Risk Conclusions .....	52
<b>7 Conclusions .....</b>	<b>53</b>
References.....	55
Appendix: Jamaica Plain Three-Family Heating and Cooling Manual J Results .....	57

## List of Figures

Figure 1. Preretrofit Jamaica Plain Three-Family in Boston, Massachusetts.....	1
Figure 2. Exterior front and overhead view of masonry townhome project .....	2
Figure 3. Front window sill and head details, showing end dams on solid stone sill .....	2
Figure 4. Exterior 1-in. mortar/air space and interior wall (strapping and wood lath with plaster)....	3
Figure 5. Front face brick/side brick transition (left) and brick termination at grade (right) .....	3
Figure 6. Efflorescence pattern under window sills (left); lack of drip edge at window sill band detail (right).....	4
Figure 7. Adjacent building, showing severe mortar erosion under window sills.....	4
Figure 8. Front parapet brick condition (left) and interior side of parapet showing height (right) ....	5
Figure 9. Brick condition adjacent to front steps (left) and evidence of splashback (right).....	5
Figure 10. Minor freeze-thaw damage visible adjacent to front doorway .....	6
Figure 11. Freeze-thaw damage at front party wall (left) and doorway arch details above (right) .....	6
Figure 12. Freeze-thaw damage and mortar erosion next to front steps at two adjacent buildings..	7
Figure 13. Rear building elevation (left), window detail (center), and light well area (right).....	7
Figure 14. Residual paint at rear of building (left) and scarification of brick due to abrasive cleaning (right).....	8
Figure 15. Brick condition at parapet near light well (left), and chimney condition (right).....	8
Figure 16. Evidence of capillary rise on north party wall (laundry area) .....	9
Figure 17. Capillary rise on south party wall (near furnaces). Left image shows front of building. ..	9
Figure 18. Severe subfluorescence at window at light well; stone shelf below grade.....	10
Figure 19. Rear wall near subfluorescence damage visible in basement.....	10
Figure 20. Front entryway wood support structure, with embedment in masonry.....	11
Figure 21. Joists supported at sides of building in brick masonry .....	11
Figure 22. Rubber single-ply membrane roof and interior view of the third floor ceiling .....	12
Figure 23. Roof drain (left) and stairway skylight (right) .....	12
Figure 24. 10–12-in. parapet at front of building (left) and party walls (right) .....	13
Figure 25. Interior view of the windows and visual inspection of the glass .....	13
Figure 26. Airtightness testing; leakage at doors to hallway .....	14
Figure 27. Air leakage was evident at electrical receptacles and ductwork registers.....	14
Figure 28. Multipoint air leakage testing of Unit 2.....	15
Figure 29. Gas furnaces (left) and DHW tanks (right) .....	16
Figure 30. 25 months’ gas usage and HDD base 65°F for Apartment 3 .....	17
Figure 31. Monthly gas use (therms) versus heating degree days (HDD 65°F).....	18
Figure 32. EgUSA parametric energy model, by end use, millions Btu/year source energy .....	19
Figure 33. J.P. Three-Family: BEopt optimization results—cost versus energy savings .....	23
Figure 34. J.P. Three-Family: BEopt optimization results—source energy use.....	24
Figure 35. Drip edges and sloped window sills are critical deflection elements (Straube 2011) .....	26
Figure 36. Parging and mortar erosion due to capillarity (Lstiburek 2007b).....	27
Figure 37. Reglet details to protect embedded beam ends (Lstiburek 2007) .....	28
Figure 38. Storage use basement slab insulation/moisture control retrofit (left); cement board surface (right).....	29
Figure 39. Use of air gap membrane and insulation as a “wet slab” retrofit (Lstiburek 2008) .....	30
Figure 40. Front door vestibule, showing double doors and glazing.....	31
Figure 41. Mini-split wall-mounted unit (left) and recessed compact air handler (right) .....	32
Figure 42. Transformations, Inc. floor plan (2 <sup>nd</sup> floor) and J.P. Three-Family floor plan (Unit 3) .....	33
Figure 43. Tee wall with 2-in. spray foam depicting materials, temperature, and heat flux .....	36
Figure 44. Tee wall with 2-in. spray foam and foam at corner depicting materials, temperature, and heat flux .....	37
Figure 45. Tee wall with 2-in. spray foam and 1-ft. foam at corner depicting materials, temperature, and heat flux.....	38
Figure 46. Tee wall with 4-in. spray foam depicting materials, temperature, and heat flux .....	39
Figure 47. Tee wall with exterior insulation (base case) depicting materials, temperature, and heat flux .....	41

---

Figure 48. Tee wall with extended exterior insulation depicting materials, temperature, and heat flux` .....	42
Figure 49. Capped party wall at J.P. Three-Family, and roof “wrap” over an exposed party wall ...	43
Figure 50. Confirming existing wall assembly and collecting front (east) face brick sample .....	44
Figure 51. Confirming existing wall assembly and collecting rear (west) face brick sample .....	44
Figure 52. Freeze-thaw damage potential assessment procedure .....	49
Figure 53. WUFI 4.1 Pro model of existing wall system.....	50
Figure 54. Predicted winter conditions at back of rear face brick .....	51
Figure 55. Predicted winter conditions at back of front face brick.....	52

*Unless otherwise noted, all figures were created by Building Science Corporation.*

## List of Tables

<b>Table 1. Air Leakage Testing Results for Unit 2 .....</b>	<b>15</b>
<b>Table 2. Enclosure and Mechanical Characteristics: Existing Building and Deep Energy Retrofit .</b>	<b>20</b>
<b>Table 3. Manual J Design Heating and Cooling Loads per Unit.....</b>	<b>32</b>
<b>Table 4. Mitsubishi Hyper-Heat Mini-Split Capacity and Rating Tables .....</b>	<b>32</b>
<b>Table 5. Composite R-Values for 1-in. Cavity with Various Levels of Mortar Fill.....</b>	<b>35</b>
<b>Table 6. Material Properties for Selected Brick .....</b>	<b>47</b>

*Unless otherwise noted, all tables were created by Building Science Corporation.*



## Definitions

ACH	Air changes per hour
ACH50	Air changes per hour at 50 Pascal test pressure
AFUE	Annual fuel utilization efficiency
ASHP	Air source heat pump
ASHRAE	American Society of Heating, Refrigerating and Air-Conditioning Engineers
BA	Building America program
BEopt	Building Energy Optimization (software)
BSC	Building Science Corporation
ccSPF	Closed-cell spray polyurethane foam
CFM	Cubic feet per minute
CFM50	Cubic feet per minute at 50 Pascal test pressure
CSA	Canadian Standards Association
DER	Deep energy retrofit
DOE	U.S. Department of Energy
DHW	Domestic hot water
EgUSA	EnergyGauge USA
ERV	Energy recovery ventilator
FT	Freeze-thaw
HERS	Home Energy Rating System developed by the Residential Energy Services Network (RESNET).
HRV	Heat recovery ventilator
HVAC	Heat, ventilation, and air conditioning
ICC	International Code Council, Inc.
IRC	International Residential Code for One- and Two-Family Dwellings
NREL	National Renewable Energy Laboratory
PV	Photovoltaic
$S_{crit}$	Critical degree of saturation for freeze-thaw damage to masonry (expressed as a decimal, e.g., 0.8)
SHGC	Solar heat gain coefficient
THC	Thousand Home Challenge
WUFI	Wärme- und Feuchtetransport instationär

## Executive Summary

Building Science Corporation (BSC) seeks to further the energy efficiency market for New England area retrofit projects by supporting projects that are based on solid building science fundamentals and verified implementation. BSC has been working with Byggmeister, a partner on the Building America (BA) team, on retrofit projects under the BA program. Byggmeister is a local design-build firm that specializes in energy efficient retrofits and new construction. The Duclos, Eldrenkamp and Panish Energy Group (DEEP Energy Group), which is associated with Byggmeister, conducts design-phase energy analysis and monitors completed projects.

The Byggmeister multifamily test home located in Jamaica Plain, Massachusetts (Jamaica Plain or J.P. Three-Family) is a three-story brick row house. The test home is examined with the goal of producing a case study that could be applied to similar New England homes. This report will contribute to basic areas of research, including finding the combination of measures that are feasible, affordable, and suitable for this type of construction and acceptable to homeowners.

For the J.P. Three-Family retrofit, BSC weighed options for insulating load-bearing masonry buildings on the interior while considering unique conditions such as the appearance of the exterior, walls and roof shared between multiple housing units, bulk water management, and the building's susceptibility to freeze-thaw (FT) damage.

Energy modeling was performed with BEopt (Christensen and Anderson 2006) and EnergyGauge USA (Parker et al. 1999) software packages to determine energy impacts and cost effectiveness of various measures. While BEopt calculates estimated cost effectiveness of the retrofit measures, several limitations of the software prevent it from accurately modeling certain aspects of the building's energy use. The EgUSA results are shown in a step-by-step parametric model to evaluate the impact of individual measures. In addition, utility bill/energy use data were examined for trends and to "tune" the energy models to some degree.

Heat flow simulations were run using THERM 5.2 (LBNL 2003) Two-Dimensional Building Heat-Transfer Modeling Software to examine thermal bridging at the masonry walls. Due to the existing geometries of the walls, such as the tee or party walls between the units, several scenarios were examined for the interior and exterior insulation of the tee party walls.

In order to assess the FT risk to the bricks, material property tests were performed with the Wärme- und Feuchtetransport instationär (WUFI) 4.1 Pro hygrothermal simulation program. Simulations were conducted for both the west-facing rear wall and east-facing front wall to assess the impact of solar radiation and rain on different orientations and to determine the effects of adding thermal insulation to the inside of the walls.

# 1 Introduction

Building Science Corporation (BSC) seeks to further the energy efficiency market for New England area retrofit projects by supporting projects based on solid building science fundamentals and verified implementation. BSC has been working with Building America (BA) partner, Byggmeister, a local design-build firm that specializes in energy efficient retrofits and new construction. The Duclos, Eldrenkamp and Panish Energy Group (DEAP Energy Group), which is associated with Byggmeister, provides design-phase energy analysis and conducts monitoring of completed projects.

The Byggmeister multifamily test home located in the Jamaica Plain neighborhood of Boston, Massachusetts (J.P. Three-Family), is a three-story brick row house. BSC examined the home with the goal of producing a case study that could be applied to similar New England homes.

This study contributes to several basic areas of research that include finding the combination of measures that are feasible, affordable, and suitable for this type of construction and that are acceptable to homeowners. This report also examines the package of measures considered, initial energy use results, material properties test results of the brick, and heat flow simulation results for the party walls.

This test home is a candidate to participate in the National Grid Deep Energy Retrofit Pilot Program (National Grid 2009), which provides financial incentives and technical support to participants. The program’s goal is to achieve at least 50% better energy performance than a code-built home. BSC has partnered with National Grid, providing technical guidance and support for the program. Through this partnership, BSC began working with the owner of the J.P. Three-Family to provide recommendations for retrofitting the building.

## 1.1 Context and Relevance to Other Homes

The J.P. Three-Family test home is a three-story row house with load-bearing mass masonry (brick) walls located in the Jamaica Plain neighborhood of Boston. The building and the adjacent properties were built circa 1906–1918. The test home is divided into three apartments: a one-bedroom first floor unit and two-bedroom units on the second and third floors. All units are typically occupied with vacancies between rental terms that provide an opportunity to perform retrofit upgrades.



Figure 1. Preretrofit Jamaica Plain Three-Family in Boston, Massachusetts

## 2 Site Assessment for Jamaica Plain Three-Family

### 2.1 Exterior Masonry Condition Assessment

The front and rear of the building are predominantly east and west exposures, respectively, although there is some shielded south-facing wall, due to the narrow light well at the side of the building.



**Figure 2. Exterior front and overhead view of masonry townhome project**

The test building was cleaned and repointed more recently than identical buildings on the street were, as depicted in the exterior photos (Figure 2).



**Figure 3. Front window sill and head details, showing end dams on solid stone sill**

The front face brick is a smooth finish brick (likely chosen for appearance), with fine mortar joints; the transition between the front face brick and side/rear utility brick is shown in Figure 5.

The brick wall at the front and rear of the building is two wythes thick, with a 1-in. space between the wythes that is filled with mortar droppings and air space. The interior is finished

with wood strapping (with an approximately 1-in. air space cavity) and wood lath with horsehair plaster.



**Figure 4. Exterior 1-in. mortar/air space and interior wall (strapping and wood lath with plaster)**

The front façade has water shedding details such as stone band courses at the window sills and above some window heads. At grade, the brick terminates to a stone (likely granite) base course. This base course reduces brick capillary water uptake.



**Figure 5. Front face brick/side brick transition (left) and brick termination at grade (right)**

End dams carved into the stone sills (Figure 3 and Figure 7) direct water accumulation from the window face out from the surface of the masonry. However, efflorescence and signs of water runoff were noticeable below the windows at most floors. The lack of a drip edge detail at the window sill band was noted (Figure 6).



**Figure 6. Efflorescence pattern under window sills (left); lack of drip edge at window sill band detail (right)**

At first, the team suspected that the efflorescence might be caused by the window sill planter boxes; however, adjacent identical buildings without planter boxes also showed a pattern of water runoff and mortar joint erosion concentrated under window sills (Figure 7).



**Figure 7. Adjacent building, showing severe mortar erosion under window sills**

An initial assessment of a building for freeze-thaw (FT) vulnerability starts with an examination of the most exposed areas, in terms of rainfall deposition and concentration, and cold temperatures. Typically, the most exposed and unheated area is a building's parapet: rainfall accumulates at top corners, and flow of heat from the interior is reduced due to the greater surface area. The parapet at J.P. Three-Family showed no signs of FT damage (Figure 8). A metal cap detail is installed over the parapet, and the brick is detailed to enhance water shedding and reduce accumulation on the wall below. This detail tends to reduce risks of wetting, and therefore, FT damage.



**Figure 8. Front parapet brick condition (left) and interior side of parapet showing height (right)**

However, further assessment of the building showed some FT damage to the brick. For instance, there was some minor damage near the front porch, as noted in Figure 9 and Figure 10.



**Figure 9. Brick condition adjacent to front steps (left) and evidence of splashback (right)**

This damage did not have a clear cause; potential causes might include water concentrations in the past, snow accumulation (and therefore melting) against the brick exterior, or interior versus exterior geometries (reduced heat flow at exterior corners). The damage at the front doorway (Figure 10) shows the classic face delamination issues typical of FT damage.



**Figure 10. Minor freeze-thaw damage visible adjacent to front doorway**

More severe FT damage was noted at the pillar at the front face of the party wall (Figure 11). Again, an obvious single cause was not noted, but suspected causes include rainfall splashback at the front porch, snow accumulation against the front porch, rainwater concentration from the two archway details above, and exposure to extreme temperatures (the brick “fin” receives little thermal energy from the unheated entryways).



**Figure 11. Freeze-thaw damage at front party wall (left) and doorway arch details above (right)**

Finally, the adjacent buildings were examined, and a consistent pattern of severe FT damage was noted next to the front porch at the basement wall level. Potential causes noted previously might also apply to the FT damage in this area.





**Figure 12. Freeze-thaw damage and mortar erosion next to front steps at two adjacent buildings**

The rear of the J.P. Three-Family building (Figure 13) is constructed similarly to the façade although it has substantially less detailing and is constructed of utility-grade brick. Rear-facing windows are capped with segmental arches and solid stone sills are used. Most of the rear elevation, except for the light well section, is shielded by an attached porch.



**Figure 13. Rear building elevation (left), window detail (center), and light well area (right)**

The light well area shows signs of residual exterior whitewash or paint that was at least partially removed in the past. The exposed brick shows signs of abrasive cleaning, such as “swirl” marks on the face of the brick (see Figure 14). This cleaning might have detrimental effects on the durability of this brick (NPS 1979).



**Figure 14. Residual paint at rear of building (left) and scarification of brick due to abrasive cleaning (right)**

No FT damage was visible on the exterior condition survey, including at the parapet. However, one of the two rear chimneys tilts noticeably inward (toward the north). Both chimneys are uncapped and exposed to rainfall.



**Figure 15. Brick condition at parapet near light well (left), and chimney condition (right)**

## **2.2 Basement Condition Assessment**

The building is on a full basement foundation; the underground space is used for laundry, mechanical equipment, and tenant storage. The side walls of the basement (party walls to adjacent units) are full-height brick having an interior cementitious parge coat. The parge coat is delaminating, revealing mortar erosion and underlying brick with subfluorescence damage. The damage (Figure 16) is in the classic pattern of the damage caused by capillary rise from damp soils, as discussed by Lstiburek (2007a).



**Figure 16. Evidence of capillary rise on north party wall (laundry area)**

The capillary rise is relatively even around the perimeter of the building, and it is anywhere from 8 to 12 courses in height. Interior brick columns also show similar patterns of mortar and brick erosion due to capillary rise.



**Figure 17. Capillary rise on south party wall (near furnaces). Left image shows front of building.**

On the exposed portions of the foundation (front, rear, and side light well), the foundation is rubble stone (likely granite) below grade and brick above grade (Figure 17). Some interior brick spalling was visible on the front elevation of the basement wall.

At the side of the basement, at the light well, severe subfluorescence and delamination was seen near the window (Figure 18). This area had the stone-and-brick foundation noted above.



**Figure 18. Severe subfluorescence at window at light well; stone shelf below grade**

The cause of this damage was apparent on the exterior of the building (Figure 19); the exterior grade is higher than the stone courses, resulting in buried brick courses. Moisture from the soil is drawn into the brickwork by capillary uptake and, interior spalling results.



**Figure 19. Rear wall near subfluorescence damage visible in basement**

These water conditions should be addressed before considering the retrofit of interior insulation in the basement walls. Recommended solutions include exterior excavation of the basement wall, and possibly adding an air gap membrane at the buried portion of the brick and/or adding damp proofing materials to the brick exterior.

There are several locations where wood members are embedded in the brick masonry. One case is at the front of the house, where a wooden beam supports the platform of the front entry of the building (Figure 20). Some evidence of water seepage was seen on these wood elements; however, when tested with a handheld moisture content meter (Delmhorst BD-10), dry conditions were detected (moisture content of approximately 11%).



**Figure 20. Front entryway wood support structure, with embedment in masonry**

Similarly, the floor joists run laterally across the structure and are resting on masonry at the sides (most rest on party walls but some rest on exterior walls) of the building (Figure 21).



**Figure 21. Joists supported at sides of building in brick masonry**

Embedded wood members in the masonry should be addressed before applying impermeable interior insulation. Measures should be implemented that reduce the impact of bulk and capillary water at the joists ends.

### **2.3 Roof Assessment**

The building's flat roof was reroofed roughly 10 years ago with black, single-ply membrane. After reroofing, the roof leaked on multiple occasions. Leaks were primarily due to improper termination of the membrane at the parapet and penetration locations. The owner hired another company to fix the construction defects.



**Figure 22. Rubber single-ply membrane roof and interior view of the third floor ceiling**

Water accumulates at several low spots in the roof. The drain, located near the chimney, is often clogged with leaves and other debris. During the field assessment, the team noticed that the roof cover board under the membrane (fiberboard or similar) was “spongy,” providing evidence of water leakage into the assembly.

The skylight, which provides light to the building stairway, is original to the building and shows substantial weathering. However, it does not show signs of leakage.



**Figure 23. Roof drain (left) and stairway skylight (right)**

The height of the roof parapet varies. At the front of the building, it is about 12 in. high, and the demising wall parapet is about 11 in. The parapet near the rear of the building is much lower, measuring roughly 4 in. If the owner chooses to insulate the roof on the exterior, the parapet at the rear of the building may need to be raised to allow for the desired amount of insulation.



**Figure 24. 10–12-in. parapet at front of building (left) and party walls (right)**

The ceiling cavity underneath the roof deck is roughly 12 in. deep; extensive intrusive disassembly was not done, so it is not clear if this cavity is a single joist height (12 in.) or if it is two separate framing systems.

## **2.4 Windows Assessment**

The windows, which are less than 10 years old, appear to be in good condition. Windows are double-glass, vinyl-framed, with either a low-e coating or clear glazing (it is unclear from initial inspections). The owner is considering replacing the windows or installing storm windows to improve the overall thermal performance.



**Figure 25. Interior view of the windows and visual inspection of the glass**

## **2.5 Airtightness Testing**

The second-floor unit (middle unit) was tested for airtightness with a blower door and duct blaster.



**Figure 26. Airtightness testing; leakage at doors to hallway**

Air leakage was evident at the hallway doors, which was expected given the lack of gaskets around the doors. In addition, air leakage was observed at electrical receptacles and from the ductwork grilles. This was not a guarded or nulled test, so results include leakage to the exterior and to other units.



**Figure 27. Air leakage was evident at electrical receptacles and ductwork registers**

Therefore, multipoint air leakage testing was conducted with the grilles open and sealed with duct mask (i.e., subtraction method duct leakage test). The results are shown in Figure 28; note that the maximum pressure achieved was 27 Pa, so cubic feet per minute at 50 pascal test pressure (cfm50) results are extrapolated using the  $Q = C \times \Delta P^n$  relationship.



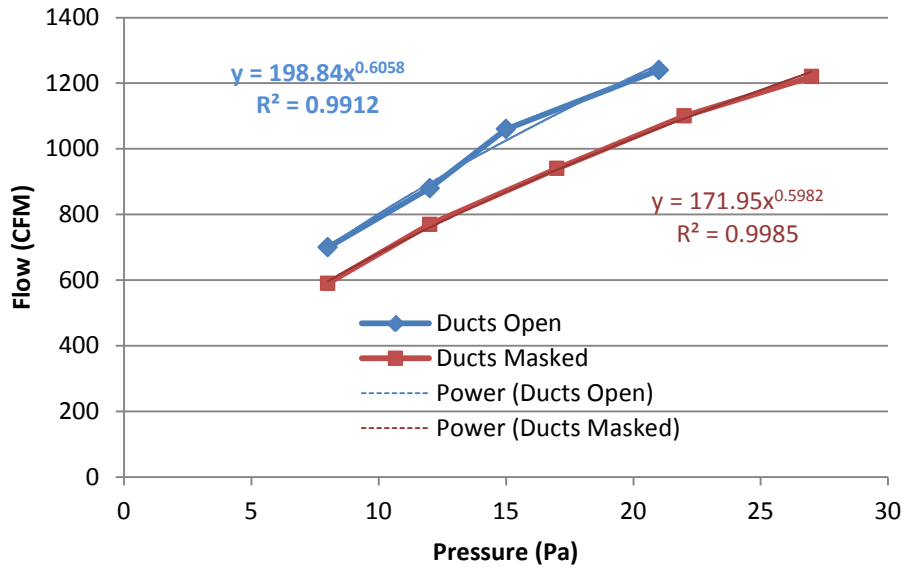

Figure 28. Multipoint air leakage testing of Unit 2

Table 1. Air Leakage Testing Results for Unit 2

	cfm50	ACH50	cfm50/ft <sup>2</sup> enclosure
Unmasked	2,127	13.3	0.62
Masked	1,785	11.2	0.52

Results indicate a large total enclosure air leakage; however, results do not indicate separate air leakage to the exterior (which would have impact on energy consumption). However, with conservative estimates of two-thirds of the total leakage to the exterior, this is still equivalent to 9 ACH at 50 pascal test pressure. In addition, 342 cfm50 is attributed to the ductwork system by the subtraction test. Assuming an exponent (n) value of 0.65 (in  $Q = C \times \Delta P^n$ ), this leakage is equivalent to 218 cfm25. Note that leakage to the exterior via the ductwork system represents a large portion (16%) of total enclosure leakage. However, direct testing of the duct system leakage was not conducted due to time constraints; only a subtraction test was done.

Additional testing, such as guarded/nulled tests to separate interior and exterior leakage and whole-building (single zone) test to determine aggregate exterior air leakage, would be useful.

## 2.6 Mechanical System and Domestic Hot Water Assessment

The building’s mechanical system consists of three atmospherically vented natural gas furnaces, one serving each housing unit. Each 80,000 Btu/h input furnace has a standing pilot light. The building owner has reported that the pilot lights require periodic relighting, indicating end of service life issues.

Heat is distributed through the uninsulated sheet metal ductwork that is located in the basement and also runs through conditioned space. The ductwork was marginally sealed with cloth/rubber duct tape. The ductwork system has not yet been tested for leakage.

Domestic hot water (DHW) is generated for each unit by a gas-fired 40-gal tank of relatively recent vintage. Each heater is vented atmospherically through the chimney.



**Figure 29. Gas furnaces (left) and DHW tanks (right)**

### 3 Energy Use and Modeling of Upgrade Options for Jamaica Plain Three-Family

#### 3.1 Actual Energy Use (Utility Bills)

The building owner provided energy use data for the three apartment units. Unfortunately, electrical use data was limited to average monthly use for the three units. Average usage was similar for the three units, at 300, 400, and 370 kWh/month.

Natural gas data, plotted in Figure 30, was available for 25 months for all apartments. The owner noted that the residents of Apartment 3 were from a warm climate and, hence, used an exceptionally high setpoint which resulted in the high gas usage for Apartment 3.

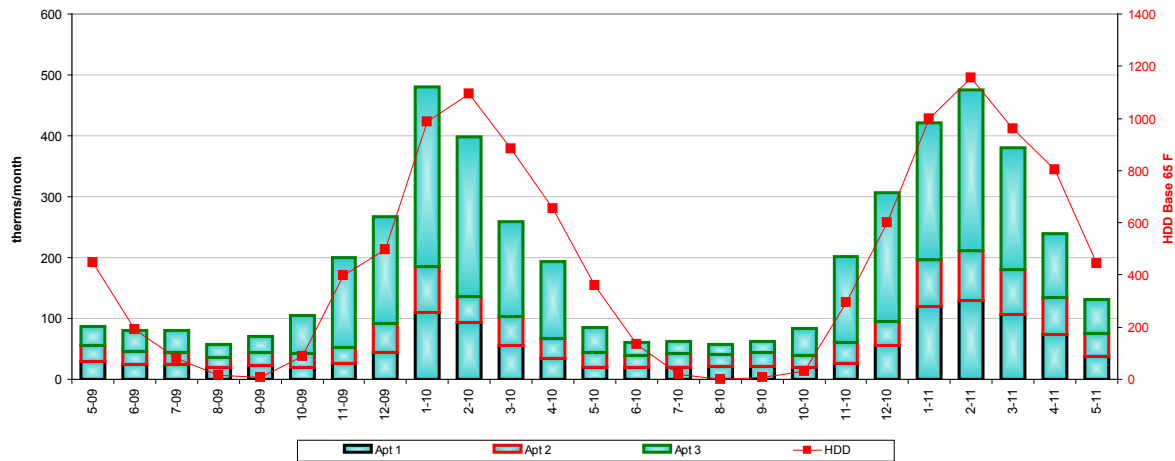
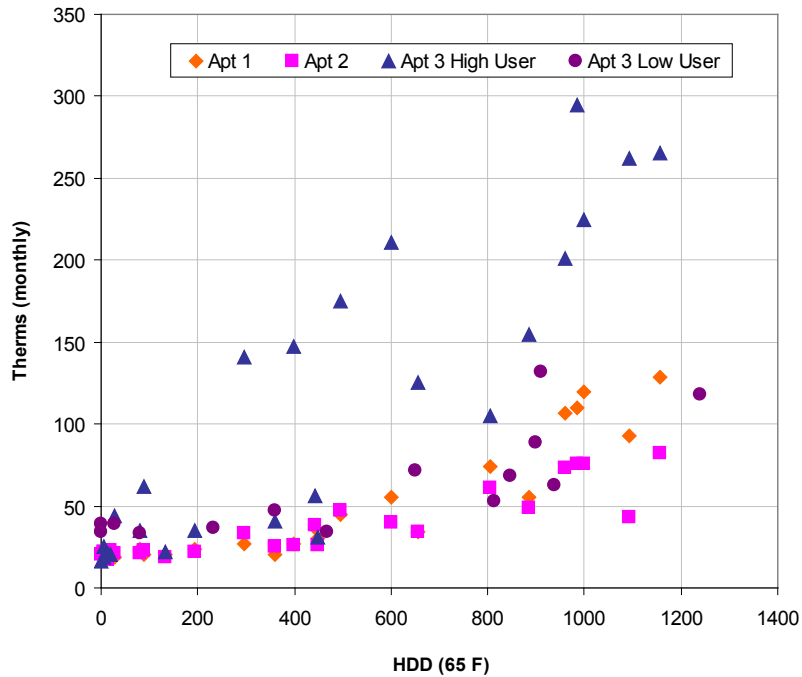

Figure 30. 25 months' gas usage and HDD base 65°F for all three apartments

Because of the abnormally high usage for Apartment 3, the owner provided gas use data for Apartment 3 from 2008 when it was occupied by previous tenants. Instead of plotting this data separately, BSC generated an x-y plot of gas use (therms/month) against monthly heating degree days for all apartment data, as shown in Figure 31.



**Figure 31. Monthly gas use (therms) versus heating degree days (HDD 65°F)**

Comparing the data points for Apartment 3 in Figure 31 clearly shows the effect of occupant behavior on natural gas consumption. Except for the high-user in Apartment 3, all data follow similar patterns, with wintertime peaks in the 100–150 therms per month range and baseline (gas cooking plus DHW) use of approximately 20 to 25 therms per month. Given the potential effects of occupancy and setpoint, it is difficult to draw any conclusions on energy use due to exposure (i.e., Apartment 2 lower due to less exposed surface area).

Energy use data was used to roughly calibrate the EnergyGauge USA (EgUSA) model discussed below. Note that the model was not extensively tuned due to the lack of knowledge of which input should be modified. (For instance, should infiltration, duct leakage, or insulation levels be changed when calibrating heating energy use?)

### 3.2 Energy Modeling of Upgrade Options (EnergyGauge USA Parametric)

BSC ran a set of parametric energy simulations for the prototype row house using EgUSA (Parker et al. 1999). EgUSA is an hourly energy modeling software package running on the U.S. Department of Energy’s DOE-2 engine. BSC prefers EgUSA over the Building Energy Optimization tool (BEopt, Christensen and Anderson 2006) for its ability to capture attributes such as party walls and multifamily features not currently available in BEopt. The impact of various upgrade options on end use loads are depicted in Figure 32.

Characteristics of the preretrofit and postretrofit house are outlined in Table 2.

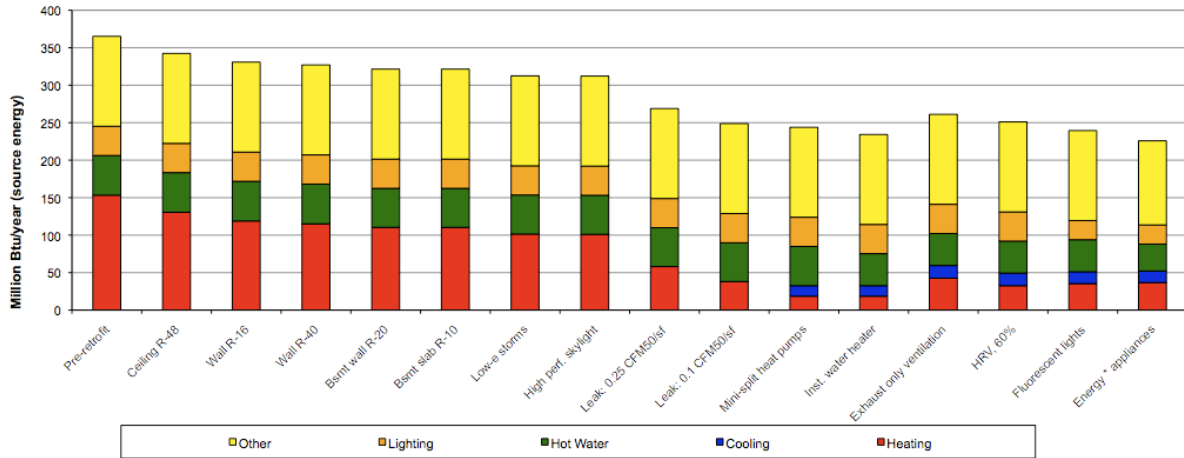

Figure 32. EgUSA parametric energy model, by end use, millions Btu/year source energy

Each modeled upgrade is described below. Simulations were cumulative (i.e., non-branching simulations) such that each subsequent upgrade is in addition to all of the previous upgrades. In parentheses following the upgrade name is the incremental savings in percent of the base case and the estimated annual cost savings in dollars, assuming electricity rates of \$0.16/kWh and natural gas cost of \$1.25/therm.

**R-48 ceiling insulation (6.2%/\$265):** Upgrade from an uninsulated joist space to R-48 insulation. Note that for moisture-safe performance, the requirements of International Residential Code for One- and Two-Family Dwellings R806.4 (International Code Council 2009) must be met by using minimum R-20 insulation (this could be accomplished by tapered polyisocyanurate to provide drainage, 3.5 in. thick, above the roof deck and under the membrane). The remaining R-28 insulation could be added by installing cavity fill insulation in the joist space. In reality, some air sealing must be done during the roof retrofit step (e.g., perimeter air seal, removing roof sheathing boards), but sealing is modeled as a separate step.

**Wall insulation to R-16 (3.2%/\$135):** Upgrade from an uninsulated assembly to a minimal, code-compliant opaque wall insulation level, of roughly 2-in-thick closed-cell spray polyurethane foam (ccSPF) (or equivalent) against the interior or exterior of the masonry. Interior insulation will require the demolition of interior wall finishes, and reconstruction. The moisture impacts of interior masonry insulation are discussed in detail in sections 5 and 6. Again, this upgrade would improve airtightness, which is modeled as a separate step.

**Table 2. Enclosure and Mechanical Characteristics: Existing Building and Deep Energy Retrofit**

Existing Building		Proposed Deep Energy Retrofit
<b>Building envelope</b>		
Ceiling	No ceiling insulation observed in roof joist space: no venting visible at membrane roof	R-20 continuous insulation (tapered polyisocyanurate; R806.4 requirement) + dense pack cellulose (or similar) cavity insulation (~8" estimate; R-28), R-48 total nominal
Walls	Uninsulated: 2 wythe masonry with 1" mortar/air space between wythes. 1" wood strapping on interior, with wood lath & plaster finish (~1" thick)	Front: R-40 wall insulation: ~6.5" closed cell spray foam on interior of masonry wall Rear: R-40 wall insulation: ~6.5" closed cell spray foam on exterior of masonry wall, or 10" EPS EIFS. Code reports typically call out 4" maximum for EIFS
Demising Walls	Uninsulated stud frame walls to hallway	Retrofit dense pack cellulose insulation into 2x4 walls to hallway (estimated full 4"; ~R-14)
Foundation (Walls)	Rubble stone (below grade) and brick (above grade) basement walls; no insulation.	R-20 wall insulation: ~3" closed cell spray foam on interior of basement wall
Foundation (Slab)	Uninsulated slab; varying between earth and poor quality concrete observed	R-10 slab insulation; current plan Utica-style retrofit of dimple mat, 2" XPS, and loose-laid cement board
Windows	Vinyl frame double glazed with low-E coating (verify if possible) U~0.35, SHGC~0.30	Add low-E storm windows to existing double low E windows; U~0.24, SHGC~0.35
Skylight	Single glazed, metal frame (assumed) steel	High performance option: Wasco triple glazed skylight U~0.27, SHGC~0.22
Infiltration	10 ACH 50 assumed value (not tested) 7.4 sq in leakage area per 100 sf of envelope area (0.7 CFM 50 per sf enclosure area)	1.3 ACH 50 target value (tight range) 1.0 sq in leakage area per 100 sf of envelope area (0.1 CFM 50 per sf enclosure area)
<b>Mechanical systems</b>		
Heat	Atmospheric gas furnace located in basement; standing pilot light. Assume ~75% AFUE	Mitsubishi Inverter-driven mini splits; two heads (?) per unit; MSZ-FE**NA heat pump units
Cooling	None	See above
DHW	40 or 50 gallon atmospheric gas tank water heaters (one per unit); assume ~0.55 EF	0.82 EF instantaneous gas water heater in basement; one per unit
Ducts	Uninsulated sheet metal in basement and through conditioned space (to various units). Assume very high leakage (~30% of airflow?)	None
Ventilation	None	Fantech SH704 Heat Recovery Ventilator (HRV) 70 CFM, ~60% effective, acting as bathroom exhaust (with Ventech VT20M controller), supply to hall or bedroom
Return Pathways	None (door undercuts)	n/a
<b>Appliances, Lighting, MELs</b>		
Appliances	n/a	Replace refrigerators and clothes washer (basement)
Lighting	Assumed 14% fluorescent lighting	100% fluorescent lighting package

**Wall insulation to R-40 (1.0%/\$43):** Raise the wall insulation level to that required for the National Grid Deep Energy Retrofit (DER) program. The incremental savings represent the change from R-16 to R-40 walls; in the interior insulation example, this would require 4 in. of ccSPF.

**Foundation wall insulation to R-20 (1.5%/\$65):** Add ccSPF insulation to the uninsulated brick and rubble stone walls. There are some secondary moisture issues that need to be addressed before this retrofit is undertaken. However, as a general solution, this recommended upgrade will resolve minor bulk moisture issues and any capillary or vapor drive issues from the soil.

**Foundation slab insulation to R-10 (0%/\$0):** Add R-10 insulation to the foundation slab. Although no energy savings are associated with this upgrade, it is a useful step for mitigating the risk of condensation on the basement slab and for allowing storage of porous materials without damage. In addition, the existing slab is a low-quality concrete with no vapor retarder. Because basement leakage is being reduced and will be part of the conditioned space, BSC recommends installing a measure to reduce evaporation due to capillarity. One example would be a slab insulation system (described later), which would solve this problem very effectively. Alternately, a vapor control layer applied to the slab (e.g., epoxy paint) could be used.

**Windows to U 0.24, solar heat gain coefficient 0.22 (2.4%/\$104):** Add low e storm windows to the exterior of the existing low e double-glazed windows to raise window performance to be on par with a triple-glazed window (per National Grid DER program requirements). However, recent research suggests that this may be a problematic upgrade: LBNL research (Melton and Yost 2011) indicates that in direct sunlight and hot weather, this combination can result in very high temperatures (185°F) in the cavity between the glazing and the storm window. Therefore, because of the risk of premature deterioration of the existing window, BSC does not recommend adding low-e storm windows.

**High performance skylight U 0.27, solar heat gain coefficient 0.22 (0.1%/\$4):** Replace existing skylight with a high performance, triple-glazed, low-solar heat gain coefficient (SHGC) unit. The existing skylight is over the stairwell, which accesses the three units. Energy savings are minimal in simulations connecting the skylight to the conditioned space. Actual savings will likely be lower than modeled because the hallway is not intentionally conditioned. Actual savings may be higher, however, due to reduced air leakage through the improved skylight.

**Air leakage reduced to 0.25 cfm50/ft<sup>2</sup> enclosure (11.8%/\$502):** Conduct air sealing to improve air leakage to 0.25 cfm50/ft<sup>2</sup> of building enclosure (equivalent to improving leakage to 3.4 ACH50 from 10 ACH50). If the full set of deep energy retrofit measures is undertaken, it is likely (but not certain) that this airtightness level can be achieved. One issue is that the masonry party walls are likely to be left untouched; unparged masonry is not an air barrier, although it typically has low air leakage. For reference, concrete block is 0.3 l/s·m<sup>2</sup> at 75 Pa, versus the 0.02 l/s·m<sup>2</sup> at 75 Pa requirement for an air barrier material (i.e., concrete block is an order of magnitude leakier than the requirement). Air barrier connections between various enclosure elements (roof-to-wall, wall-to-foundation, wall-to-window) are critical to successfully improving air leakage.

**Infiltration reduced to 0.1 cfm50/ft<sup>2</sup> enclosure (5.5%/\$232):** Conduct further air sealing to tighten the building to the equivalent of 1.3 ACH50 (from 3.4 ACH50). Achieving this performance level may be difficult, especially in a multifamily retrofit case.

**Switch to Mitsubishi mini-split heat pump for heating and cooling (5.2%/\$176 without cooling):** Replace existing gas-fired atmospheric furnace with a 23 SEER/10 HSPF mini-split heat pump. Savings were realized when examining heating alone; however, assuming that cooling is operated (in lieu of ventilation cooling), savings drop to 1.4%. This step includes eliminating duct losses to the basement (both leakage and conductive). As expected, gas usage decreases while electricity usage increases. Utility costs happen to result in a net reduction of source energy but a net increase in cost.

**0.82 EF instantaneous gas water heater (2.6%/\$110):** This replaces each atmospheric gas hot water tank with an instantaneous gas-fired water heater. The savings above reflect the total for the three units (whole building).

**Exhaust only ventilation, 210 cfm (-7.4%/- \$375):** With the air tightening measures being undertaken, it is necessary to add controlled mechanical ventilation to maintain acceptable indoor air quality. A basic exhaust-only ventilation system was simulated, at the flow rate above, 150 W power draw (1.4 cfm/W), 50% run time, and no heat recovery. The American Society of Heating, Refrigerating and Air-Conditioning Engineers (ASHRAE) 62.2 rate for a given unit is 32 cfm (at 2 bedrooms); the 50% duty cycle is intended to match this rate. As can be seen, ventilation without heat recovery adds a substantial penalty to energy consumption.

**Heat recovery, 60% effective (2.8%/\$141):** Add small, individual unit heat recovery ventilators at 70 cfm per unit (Fantech SH704 or equivalent). These systems run at 120 W, 210 cfm (total), and 50% run time. There are notable savings associated with reducing the thermal impact of controlled mechanical ventilation.

**14% fluorescent to 100% fluorescent lights (3.2%/\$161):** Replace the default level of fluorescent lighting with an all-fluorescent package to substantially reduce energy use. Persistent savings may be difficult to achieve because occupants may change light bulbs to non-fluorescent lamps.

**ENERGY STAR<sup>®</sup> refrigerator and washing machine (2.3%/\$101):** Replace refrigerators (in all three units) and washing machine (central laundry in basement) with ENERGY STAR-rated appliances. Savings include the effect of reducing domestic water heating energy use.

Overall, the proposed package of improvements achieves energy savings of 38.2% (\$1,540 per year) relative to the base case.

However, further analysis of the pattern of energy use (Figure 30) reveals other interesting results. Multifamily housing (e.g. J.P. Three-Family) has a different energy use profile compared to single-family housing. Occupant-related loads (miscellaneous end use loads, DHW) are higher, per square foot, than in single-family homes. At the same time, enclosure loads are lower due to minimal exposed wall surface area, party walls which are effectively R-∞ (adiabatic conditions), and a relatively low glazing-to-floor area ratio. In the base case, heating represented 42% of the total source energy use; with all upgrades incorporated, only 22% of the total source energy use is attributed to heating and cooling. Miscellaneous end use loads, which are controlled by the occupant, are greater than space conditioning loads (comprising one-third of the total in the benchmark case). Therefore, the effect of enclosure upgrades on energy use is limited in typical multifamily housing.

### 3.3 Cost Effectiveness of the Retrofit Measures

The cost effectiveness of the retrofit measures considered for this project was performed with BEopt, the Building America performance analysis tool. BEopt takes user-supplied cost data and energy use information for a set of energy-saving measures and optimizes combinations of measures for cost effectiveness. On a plot of average source energy savings per year against the annualized energy related costs, optimal combinations of measures form the lower bound of the data points.

While BEopt calculates estimated cost effectiveness of the retrofit measures, several limitations of the software prevent it from accurately modeling certain aspects of the building's energy use. The primary BEopt limitations relevant to this project are:

- BEopt cannot model party walls (adiabatic surfaces) or more than one wall construction in the same building. For the BEopt model, the estimated preretrofit and postretrofit wall insulation values (R-4 and R-40, respectively) were applied to all four walls when heat transfer at this R-value would only occur at two of the four walls. As a result, BEopt overestimates energy use in the preretrofit building and energy savings due to increasing the R-value. See “common wall” indications in Figure 42.
- BEopt lacks the capability to include multifamily building assumptions. Although it allows the number of occupants to be specified, it does not factor the increased



miscellaneous loads of a multifamily home, such as the use of three refrigerators instead of one. This inaccuracy is likely to calculate the postretrofit model energy use as less than it would be in reality.

- BEopt cannot model different values for basement wall and slab insulation; only basement wall insulation could be modified. This appears to be a software bug.
- BEopt does not allow modification of heat pump or air conditioner performance ratings. While a SEER 23 heat pump is specified for the project, the highest SEER available in BEopt is 18.

The default cost values for the Chicago Retrofit Cost Selection option were used for most of the inputs with the exception of wall insulation cost. Those values represent Boston area costs that were obtained from RS Means Reed Construction Data, a cost estimating tool that provides the cost of materials, installation, overhead, and profit.

The BEopt optimization of the enclosure compared different amounts of ccSPF insulation applied to the interior of the above-grade walls. The two options compared were 2 in. of closed cell spray foam with 2 × 4 framing and ½-in. drywall (R-16) or 6 in. of ccSPF with 2 × 4 framing and ½-in. drywall (R-40).

For mechanical ventilation, two options were evaluated in the optimization: exhaust-only ventilation at the ASHRAE Standard 62.2 rate; and whole-house ventilation at the ASHRAE Standard 62.2 rate with a 60% effective heat recovery ventilator. Other preretrofit and postretrofit building attribute details included in the BEopt model are outlined in Table 2, with the exception of attributes that could not be modeled precisely due to BEopt limitations.

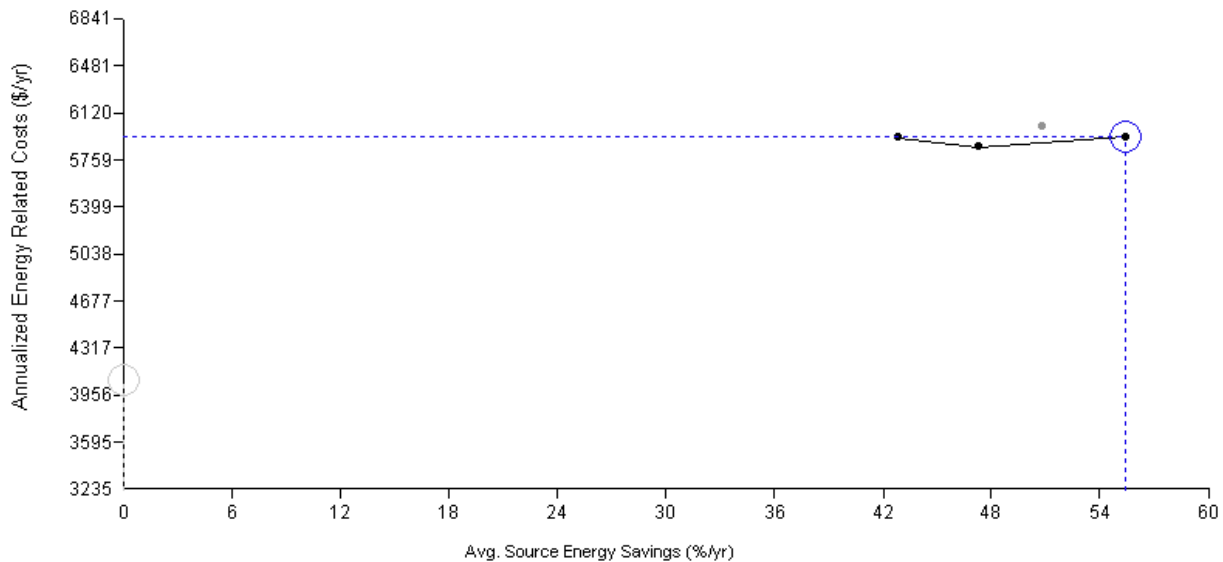

**Figure 33. J.P. Three-Family: BEopt optimization results—cost versus energy savings**

BEopt simulated combinations of options and found optimal results with R-40 walls and whole-house ventilation without the Heat Recovery Ventilator. Maximum savings projected by BEopt was 55.4%.

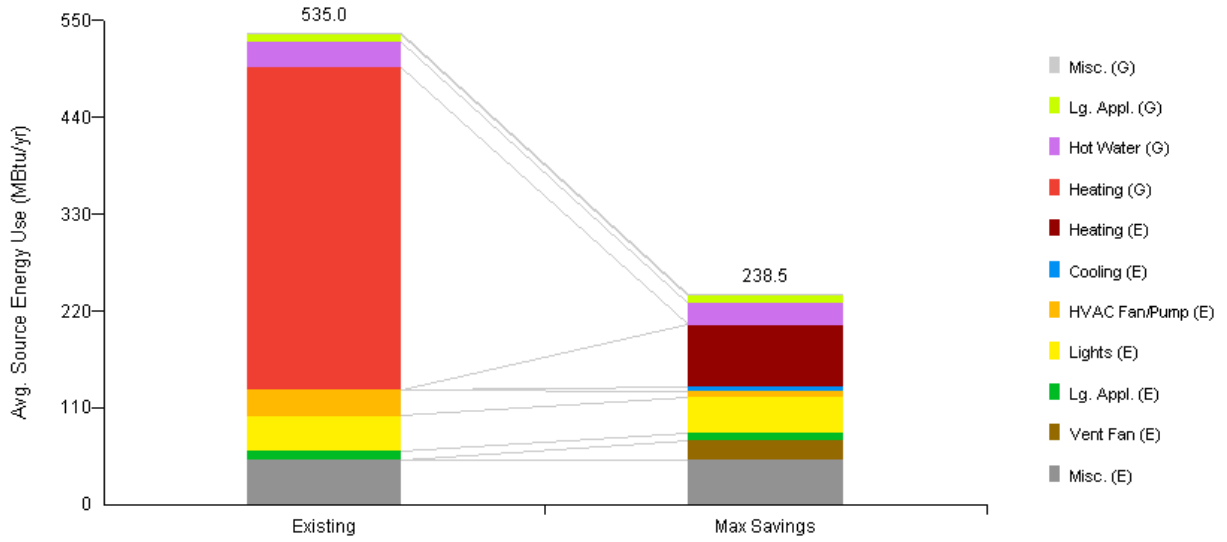

**Figure 34. J.P. Three-Family: BEopt optimization results—source energy use**

## 4 Retrofit Measure Discussion for Jamaica Plain Three-Family

There are several obstacles and implementation issues for the proposed changes to the J.P. Three-Family building. Minor issues, discussed in the EgUSA energy analysis section, are summarized below. A discussion of the major issues, categorized by enclosure and mechanical upgrades in section 4.1, follows the brief summary of minor issues in this section.

**Ceiling insulation to R-48:** Requires foam above roof deck for condensation control; roof-to-wall air barrier connections might require opening roof assembly from top or bottom. In addition, there may be knob and tube wiring in the ceiling cavities, which would require replacement with modern wiring. Field inspectors found non-metallic (NM) cable and metallic-sheathed cable (BX) in the ceiling.

**Wall insulation to R-16/R-40:** Masonry FT risks (see section 6), and recommendations for remedial bulk water control measures (see section 4.1.1).

**Foundation wall insulation to R-20:** Refer to section 4.1.2.

**Foundation slab insulation to R-10:** Refer to section 4.1.3.

**Windows to U 0.24, SHGC 0.22:** Risks of elevated temperatures and durability risks

**High performance skylight U=0.27, SHGC=0.22:** Value of high performance skylight in unconditioned stairwell

**Switch to mini-split for heating and cooling (23 SEER/10HSPF):** Refer to section 4.2.2.

**0.82 EF instantaneous gas water heater:** Refer to section 4.2.3.

### 4.1 Enclosure System Upgrades

Several enclosure measures require special detailing to control moisture risks associated with adding insulation and increasing airtightness.

#### 4.1.1 Exterior Brick Bulk Water Control

The exterior mass masonry shows signs of water accumulation under the windows due to the lack of a drip edge. As shown in Figure 35, a lacking or inadequate drip edge can cause bulk water to deposit onto the wall below a window (which is a water concentration detail due to the non-porous surface of the glass).

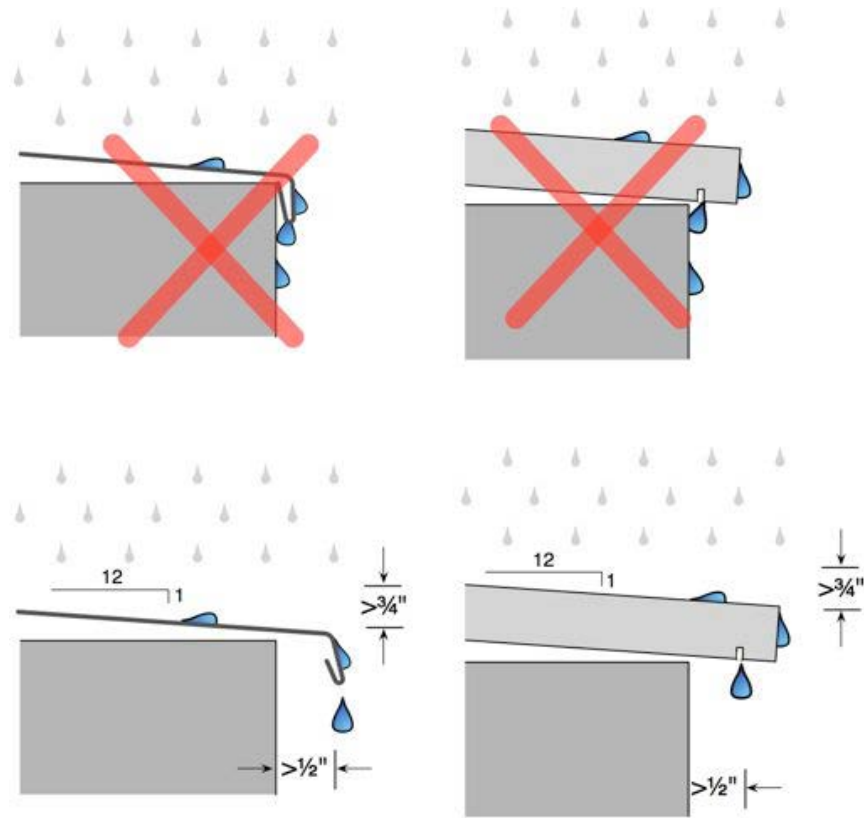
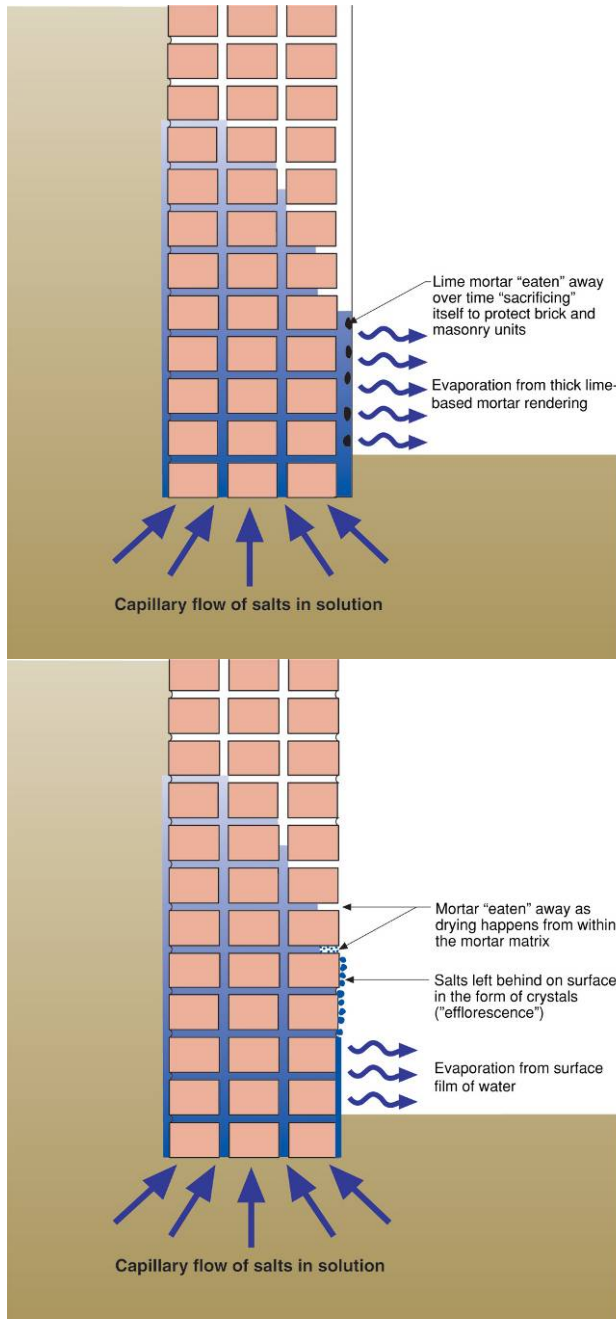

**Figure 35. Drip edges and sloped window sills are critical deflection elements (Straube 2011)**

Therefore, in conjunction with the interior wall insulation, drip edge detailing is required at the window sill stone bands. Due to the geometry, the retrofit of a “notch” drip edge is not possible; therefore, BSC recommends using a regletted metal drip edge (cut into the masonry).

#### **4.1.2 Foundation Wall Insulation**

The foundation wall shows evidence of capillary rise (a.k.a. “rising damp”) as moisture from the ground is drawn into the porous brick foundation. This rising moisture results in loss of the surface parging, erosion of mortar joints, and damage to exposed brick surfaces, as discussed by Lstiburek (2007b). This process is shown graphically in Figure 36.

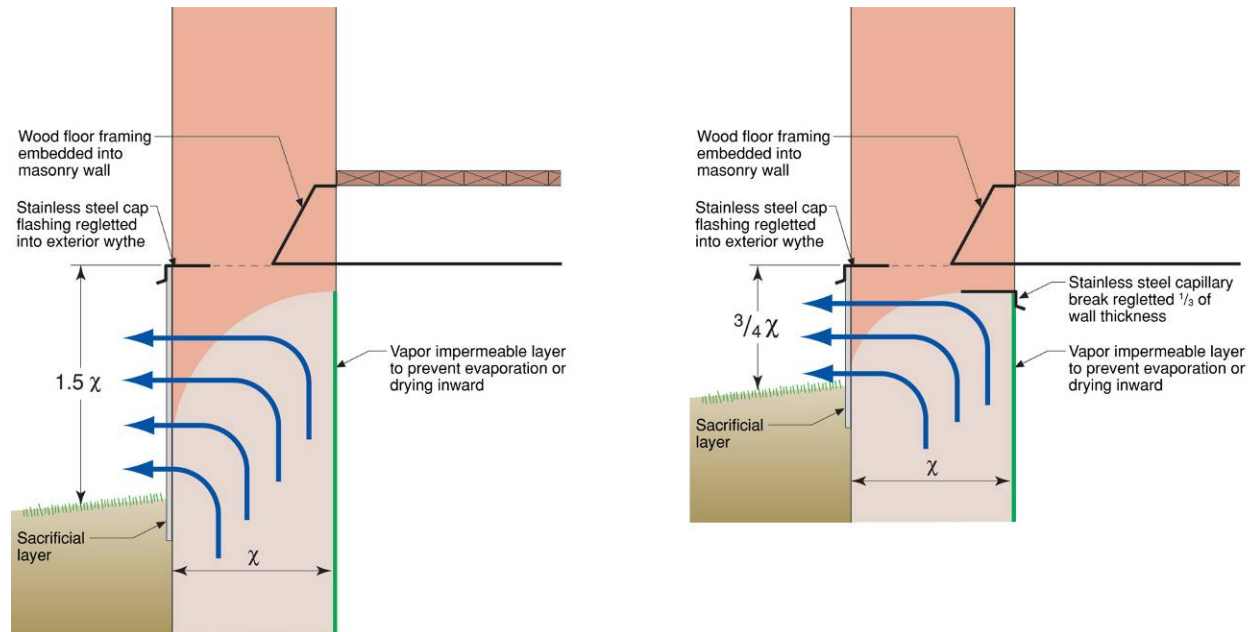

**Figure 36. Parging and mortar erosion due to capillarity (Lstiburek 2007b)**

Adding interior insulation will reduce drying potential to the interior, which will reduce the rate of efflorescence, subfluorescence, and mortar erosion. However, it is unknown if this might result in subfluorescence damage to the brick. BSC will study this in a future project, Hybrid Foundation Insulation Retrofits.

Another potential risk of adding interior insulation is that moisture from the ground will no longer dry to the interior of the basement; it is possible that the moisture might continue to rise upward, resulting in moisture damage to the ends of the structural wood member embedded in the masonry. Regletted metal details to prevent capillary transport are shown in Figure 37. Note

that the figures show rough guidelines based on the area of exposed above-grade wall; the interior is shown with a vapor-impermeable layer (such as spray foam).



**Figure 37. Reglet details to protect embedded beam ends (Lstiburek 2007)**

Another potential solution is “injectable damp proofing courses” that appear to be commonly available in the United Kingdom and Europe. Their installation involves drilling a horizontal series of holes in the mortar joint, and injecting a silane/siloxane-based cream into the holes. The cream is reported by manufacturers to migrate laterally, resulting in reduced capillary uptake at this mortar joint as silanes and siloxanes change surface tension (and therefore capillary transport) in porous materials. The holes are then plugged for appearance.

This product is of interest due to the simplicity of the retrofit and may be worth further study. However, one caution is that most commercial literature on silanes and siloxanes shows a migration distance in the millimeter range, as opposed to inches (the spacing of the holes shown), which brings into question the ability of this product to form a complete barrier to capillarity.

As mentioned previously, the portion of the basement wall that goes below grade must be addressed through excavation and moisture protection of the exterior.

#### **4.1.3 Basement Slab Retrofit**

If the basement is used only for storage, mechanical equipment, and secondary services (e.g., laundry), a possible basement retrofit assembly is shown below in Figure 38. The assembly is composed of:

- Existing basement slab: add leveling if required or desired.
- Air gap membrane (Cosella-Dörken Delta-FL or equivalent): provides air barrier (all seams must be sealed; material must be terminated in an airtight manner at perimeter) and vapor control from slab/ground. It is critical that this seal is airtight; the air space under

the membrane will often be at 100% relative humidity (Figure 39) and have poor air quality.

- Rigid foam insulation: Extruded polystyrene (XPS) typical; R-10 (2-in. XPS) required for National Grid DER program.
- Cement tile backer board (USG Durock or equivalent) as a walking surface, loosely laid onto assembly, and cut around obstructions. This material is an improvement over plywood or OSB subflooring for several reasons. It is non-moisture sensitive, given the likelihood of flooring and moisture problems in basements. It also does not have the rigidity of plywood, and it therefore mostly conforms to the surface below. Based on our experience to date, adhesion of the cement board is not necessary to prevent shifting. In addition, leaving the cement board loose-laid allows removal in case of bulk water events, or for inspection of conditions under the insulation.



**Figure 38. Storage use basement slab insulation/moisture control retrofit (left); cement board surface (right)**

As noted above, there were no significant energy savings associated with insulation of the basement slab, but it is recommended for moisture control. If National Grid DER program requirements are not being followed, it may be permissible to omit the rigid foam insulation. This will likely increase the risk of storage of moisture-sensitive materials (e.g., boxes) on the surface. However, there is some minimal R-value associated with the air gap membrane, even though it is bridged by dimples (roughly R-1), thus providing some thermal break from the concrete slab.

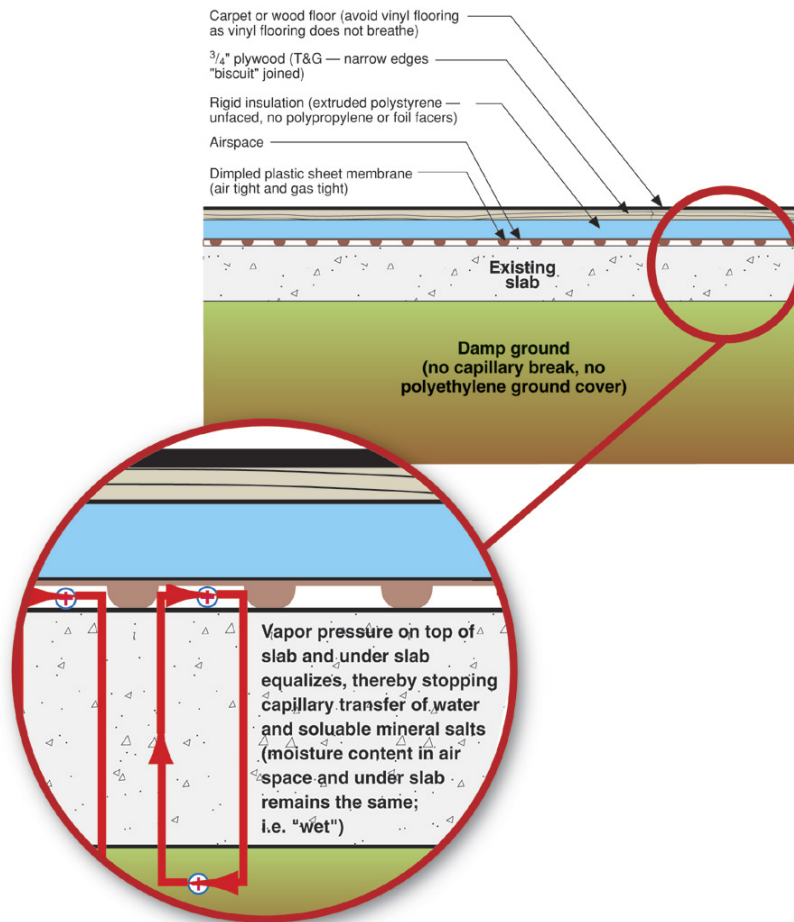

Figure 39. Use of air gap membrane and insulation as a “wet slab” retrofit (Lstiburek 2008)

#### 4.1.4 Hallway Conditions and Skylight

The hallway of the building (highlighted in blue in Figure 42) is not an intentionally conditioned space. It has limited exposure to the exterior, the front entryway door (double door with vestibule; see Figure 38), and the roof and skylight areas. The hallway is currently well connected to the basement, in terms of air leakage.

Overall, this presents a conundrum in terms of strategies for this space in a deep energy retrofit. It will be costly to add a high-performance skylight to this space, which is not being conditioned to interior setpoint. In addition, the exterior front door will be costly to retrofit as a triple glazed/high performance system with low air leakage, for instance, due to the arch-top transom. However, if the interior door is upgraded to form the thermal boundary of the apartment, the ceiling and wall of the vestibule, which are adjacent to conditioned space, need to be insulated.

Furthermore, this raises the question of whether it might be worthwhile to add insulation to the walls between the hallway and the units. There will be a temperature difference across this wall; however, an air barrier would be very difficult to retrofit (likely connected through floor cavities). Separating the hallway from the units would also include weatherstripping (and possibly insulation) of the unit doors to the hallway.



Overall, the issue might be studied with a more involved multizone energy model that would include the effect of air leakage between these multiple spaces.



**Figure 40. Front door vestibule, showing double doors and glazing**

## **4.2 Mechanical System Upgrades**

Two of the mechanical system options that require further explanation are the use of mini-split heat pumps to provide space heating and cooling, and the DHW systems.

### **4.2.2 Mini-Split Space Conditioning**

Instead of retaining and upgrading the ducted, gas-fired furnaces in the basement, the option of conditioning the apartment units using non-ducted (or minimally ducted) air source mini-split heat pumps was examined. Given the target of a deep energy retrofit, this approach holds some promise. Eliminating ductwork also eliminates duct leakage and conduction losses to the basement, not to mention the uncontrolled air exchange (infiltration/exfiltration) induced by duct leakage. Duct registers and grilles would be capped within the unit to disconnect them from the system and reduce air leakage. An additional benefit is that the chimneys could be capped or removed entirely if combined with the upgrade to direct vent appliances with sidewall vents. This eliminates a potential location for roof water leakage and reduces air leakage through the chimney from the basement.

Previous work with Transformations, Inc. (BSC 2011) used mini-split heat pumps in single-family housing (one per floor) in Massachusetts. This work demonstrated that these units could maintain interior setpoint using one distribution point per floor, even in a cold climate. During winter, the bedrooms were 0°–7°F colder than the hallway (where the mini-split head was located; see Figure 42). Results were strongly affected by whether the bedroom door was opened or closed. Overall, the consensus among practitioners of low-energy house design indicates that single-point (or limited) distribution should only be attempted in a cold climate in houses that are highly insulated (i.e., deep energy retrofit levels, with triple-glazed (or better) windows, have exceptional airtightness (of approximately 1 ACH50 or less).

Choices for interior mini-split units include ductless wall-mounted units or minimally ducted recessed ceiling units (see Figure 41). The recessed units (i.e., compact air handlers) have the benefit of being able to distribute conditioned air directly to more rooms (with closed doors), but with the downside of having a much higher installed cost per unit. In addition, these recessed

units are not currently available in combination with the low-temperature mini-split heat pumps on the market.



**Figure 41. Mini-split wall-mounted unit (left) and recessed compact air handler (right)**

The design loads for heating and cooling were calculated with ACCA Manual J version 8 (using Elitesoft/Rhvac), with results shown below.

**Table 3. Manual J Design Heating and Cooling Loads per Unit**

Unit	Heating Load (kBtu/h)	Sensible Load (kBtu/h)	Latent Load (kBtu/h)	Total Load (kBtu/h)
Basement	2,988	1,282	0	1,282
Hallway	171	98	0	98
First (1 BR)	7,307	5,656	1,478	7,134
Second (2 BR)	8,489	6,101	1,678	7,779
Third (2 BR)	9,472	6,383	1,678	8,061
<b>Total Building</b>	<b>28,427</b>	<b>19,520</b>	<b>4,834</b>	<b>24,354</b>

**Table 4. Mitsubishi Hyper-Heat Mini-Split Capacity and Rating Tables**

	MSZ-FE09NA (0.75 ton nominal)	MSZ-FE12NA (1.0 ton nominal)
Rated	9,000 Btu/h	12,000 Btu/h
Capacity Range	2,800–9,000 Btu/h	2,800–12,000 Btu/h
Cooling Efficiency	26.0 SEER	23.0 SEER
47°F HSPF (Region IV)	10.0 Btu/h/W	10.6 Btu/h/W
47°F Rated Capacity	10,900 Btu/h	13,600 Btu/h
17°F Rated Capacity	6,700 Btu/h	8,300 Btu/h
17°F Maximum Capacity	12,500 (10,900 at 5°F) Btu/h	13,600 (12,500 at 5°F) Btu/h

These loads can be compared to equipment capacities for the low-temperature mini-split heat pumps used at the Transformations, Inc. work. The 99.6% heating design dry bulb temperature

for Boston, Massachusetts is 7.4°F. Therefore, using the mini-split unit’s maximum capacity at 5°F (see the “Maximum Capacity” row), it appears that a single 1- ton unit would provide sufficient capacity at design conditions for a given floor.

The question remains of whether a single point of distribution can be used in these floor plans. A comparison between the Transformation, Inc. floor plan (second floor) and the Jamaica Plain Three-Family (third floor unit) is shown in Figure 42 below. They are shown roughly at the same scale; the sizes can be compared as follows:

- Transformations, Inc. plan: 959 ft<sup>2</sup> (including bump out)
- Jamaica Plain Three-Family: 1,063 ft<sup>2</sup> (including hallway; 970 ft<sup>2</sup> without).

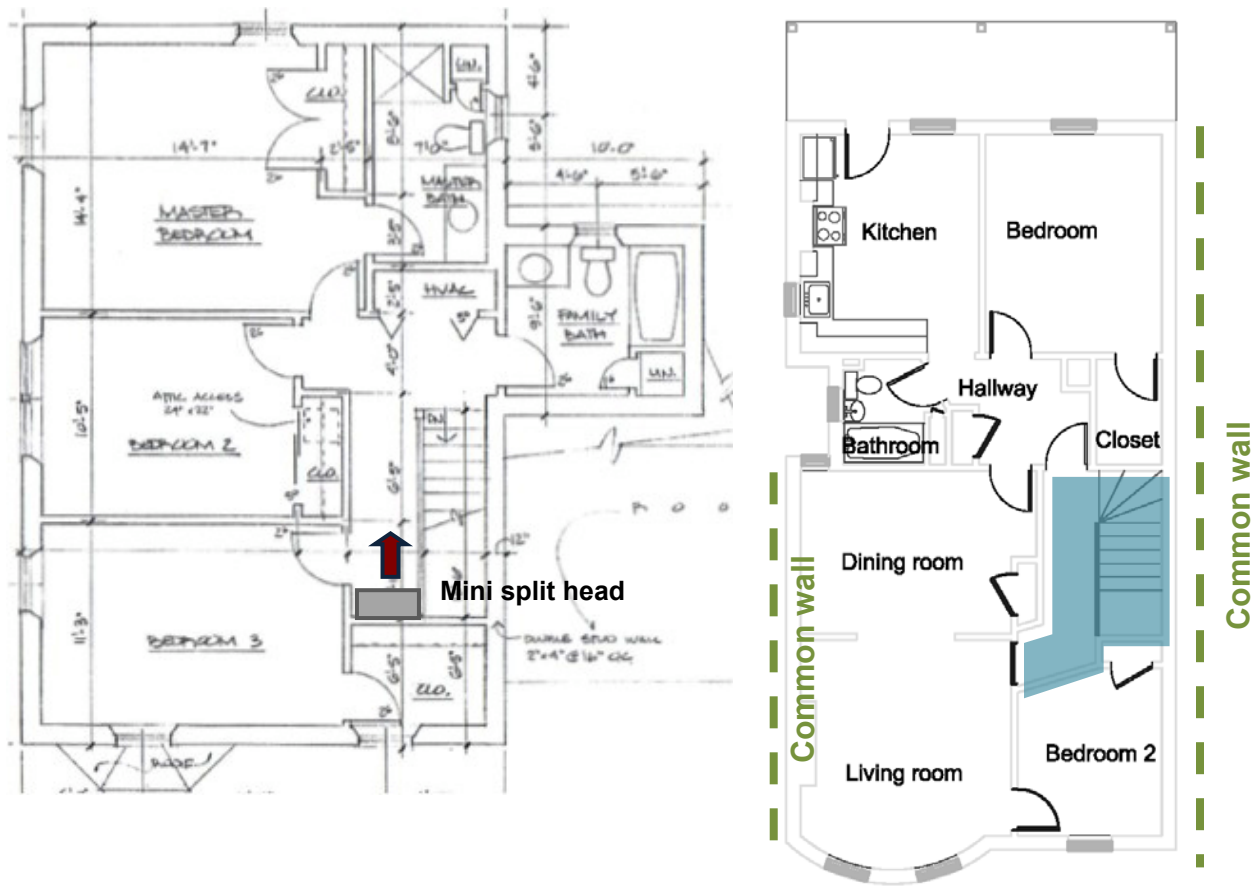

**Figure 42. Transformations, Inc. floor plan (2<sup>nd</sup> floor) and J.P. Three-Family floor plan (Unit 3)**

The J.P. Three-Family building has a more elongated floor plan than the Transformations plan, and the heating and cooling loads are concentrated at the front and back (at the exposed wall surfaces). Another potential risk is that the party walls may not be completely adiabatic, as assumed in the load calculations. Finally, the City of Boston has legal requirements for minimum temperature allowed in occupied rental units, per 105 - Code of Massachusetts Regulations 410.000: Minimum Standards of Fitness for Human Habitation (State Sanitary Code, Chapter II):

*“410.201: Temperature Requirements. The owner shall provide heat in every habitable room and every room containing a toilet, shower, or bathtub to at least 68°F (20° C) between 7:00 a.m. and 11:00 p.m. and at least 64°F (17°C) between 11:01 p.m. and 6:59 a.m. every day other than during the period from June 15th to September 15th, both inclusive, in each year except and to the extent the occupant is required to provide the fuel under a written letting agreement. The temperature shall at no time exceed 78°F (25°C) during the heating season. The temperature may be read and the requirement shall be met at a height of five feet above floor level on a wall any point more than five feet from the exterior wall. The number of days per year during which heat must be provided in accordance with 105 CMR 410.000 may be increased or decreased through a variance granted in accordance with the provisions of 105 CMR 410.840 notwithstanding the prohibitions of the first clause of the first sentence of 105 CMR 410.840(A).”*

For reference, CMR 410.840 covers a request for a variance. Therefore, the system design might require one or more of these options:

- The use of two smaller (3/4-ton) mini-split heads, front and rear, to match the distribution of the heating and cooling loads. However, this will increase the price of the mini-split heat pump option significantly.
- The installation of electric panel radiators (electric resistance heat) in some rooms. This was a solution used in some other single-point distribution systems as a backup; the use of electric resistance heat varied widely, based on occupant behavior differences.

#### **4.2.3 Domestic Hot Water Equipment**

BSC recommends replacing the atmospheric tank water heaters with gas-fired condensing, tankless water heaters (one per unit). These units draw combustion air from and exhaust flue gases directly to the exterior. However, this raises the issue of cost; retail price for these units is in the range of \$800 to \$1200 each (material cost) plus installation; estimated annual hot water savings are \$110/yr at current energy prices.

One option to consider, to lower the cost of this upgrade, is to install a high-output gas-fired condensing tank water heater, such as an American Water Heater Polaris Commercial unit (130,000 to 199,000 Btu/h input; approximately 95% thermal efficiency). The cost of this unit is higher than a single tankless water heater, but likely lower than three tankless units installed (especially considering that only one set of plumbing connections is required). The unit would need to be sized to match the expected DHW draw loads. One caveat is that this system requires shared billing of DHW energy use, which may or may not be a feasible option.

## 5 Masonry Insulation THERM Modeling for Jamaica Plain Three-Family

When retrofitting insulation to mass masonry walls, another factor to address is various thermal bridges, which occur due to existing geometries of masonry. One example is a tee wall or party wall between two units; commonly, only one side would be insulated, so the party wall has the potential to become a thermal bridge.

Therefore, heat flow simulations were run using THERM 5.2 (LBNL 2003) Two-Dimensional Building Heat-Transfer Modeling Software. Note that this is a steady-state software package, so it does not capture dynamic effects, thermal mass, or any solar gain effects. The masonry material used in this simulation had a conductivity of 0.347 Btu/h·ft·°F (R-0.24 per in.), or at the 8-in. thickness of the exterior wall, R-1.9 (not including R-value of interior air spaces and plaster).

Note that these simulations were set up as if the space between the two brick wythes is completely filled with masonry; as discussed in the condition survey, in reality, some air spaces exist in this gap. The true R-value of the masonry wall is likely to be slightly higher than the values used in these simulations. This can be demonstrated with a parallel paths calculation, as shown in Table 5.

**Table 5. Composite R-Values for 1-in. Cavity with Various Levels of Mortar Fill**

<b>% Cavity Fill</b>	<b>Composite R-Value</b>
<b>0% (air only)</b>	R-1.1
<b>25%</b>	R-0.58
<b>50%</b>	R-0.39
<b>75%</b>	R-0.30
<b>100% (fully grouted)</b>	R-0.25

An interior temperature of 68°F was modeled; the exterior temperature was a matter of further consideration. The 99.6% heating design dry bulb temperature of Boston could be used (7°F); however, this might be too extreme, given the thermal mass properties of the masonry. Another thought was to use the lowest monthly average temperature, of 29°F; this was considered too loose of a boundary condition. Therefore, an exterior temperature of 20°F was chosen for this work as an estimate of relatively cold (but not extreme) conditions which accounts for some thermal mass effects.

### 5.1 Interior Insulation of Tee (Party) Wall

BSC examined several scenarios for insulating the interior of the tee party wall. First, a 2-in. layer of spray foam was modeled on the exterior wall, while the adjacent unit retained its original wood strapping and plaster. The party wall was left undisturbed.

The resulting temperature distributions (Figure 43) show the expected colder temperatures through the insulated wall. In comparison, the uninsulated wall has a temperature gradient across the entire wall section. There is a gradual transition between the two conditions at the tee intersection.

One common concern in interior retrofits has been the possibility of condensation on uninsulated interior surfaces adjacent to the insulation; it is likely that the surfaces will be colder than their original condition, increasing condensation risks. However, the temperature distribution on the tee wall seems to indicate that temperatures of exposed surfaces (at the corner) are roughly the same as they are in the uninsulated case, indicating no increased condensation risk.

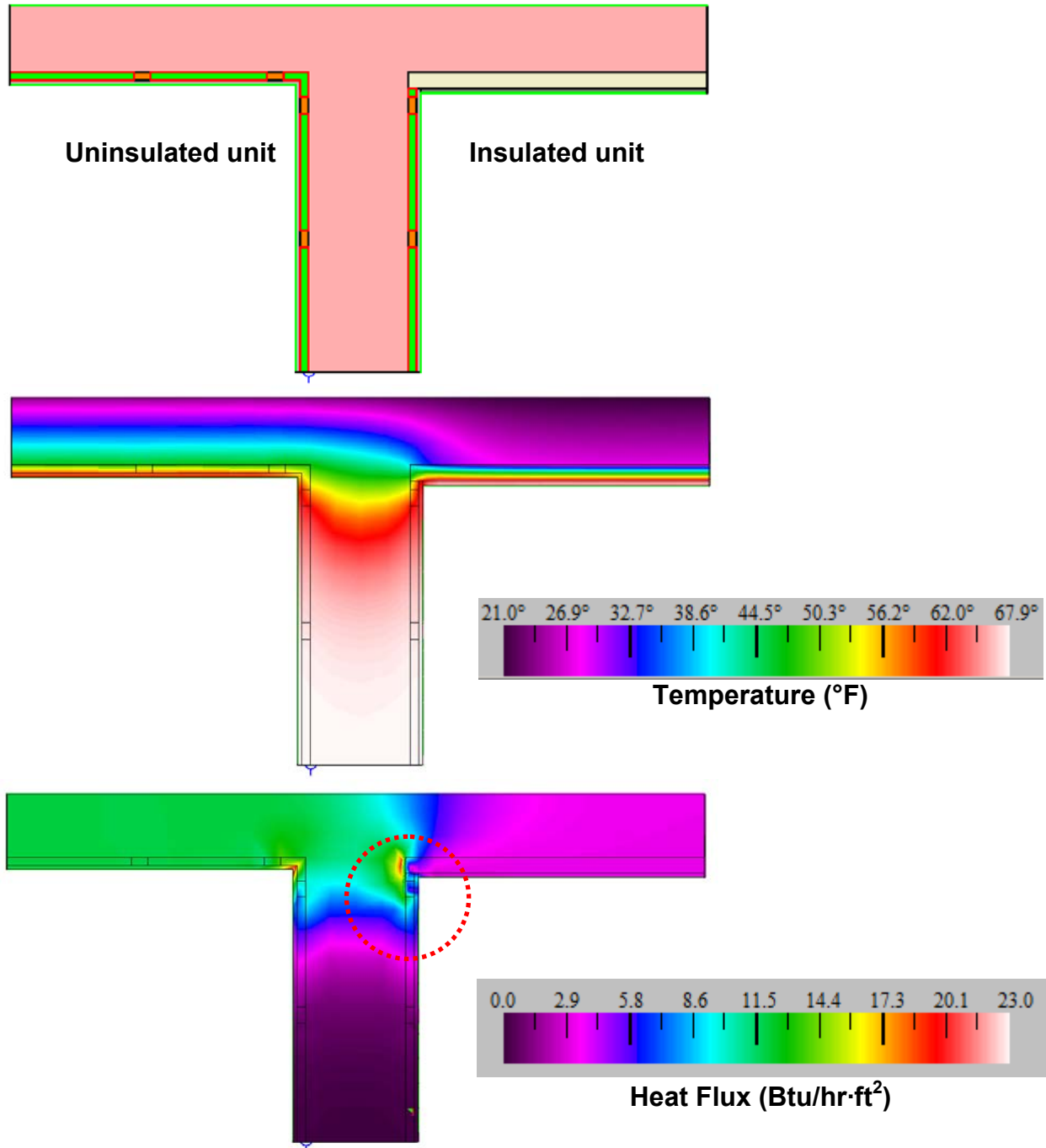

**Figure 43. Tee wall with 2-in. spray foam depicting materials, temperature, and heat flux**

Heat flux measurements show that adding insulation greatly reduces heat flux through the insulated wall, as would be expected. The greatest heat flux occurs at the interior corners (area

circled in red). Note that in the insulated case, the high heat flux is “pushed” past the insulated corner. Due to this heat flux issue, BSC ran another simulation adding a minimal amount of insulation past the corner, as shown in Figure 44.

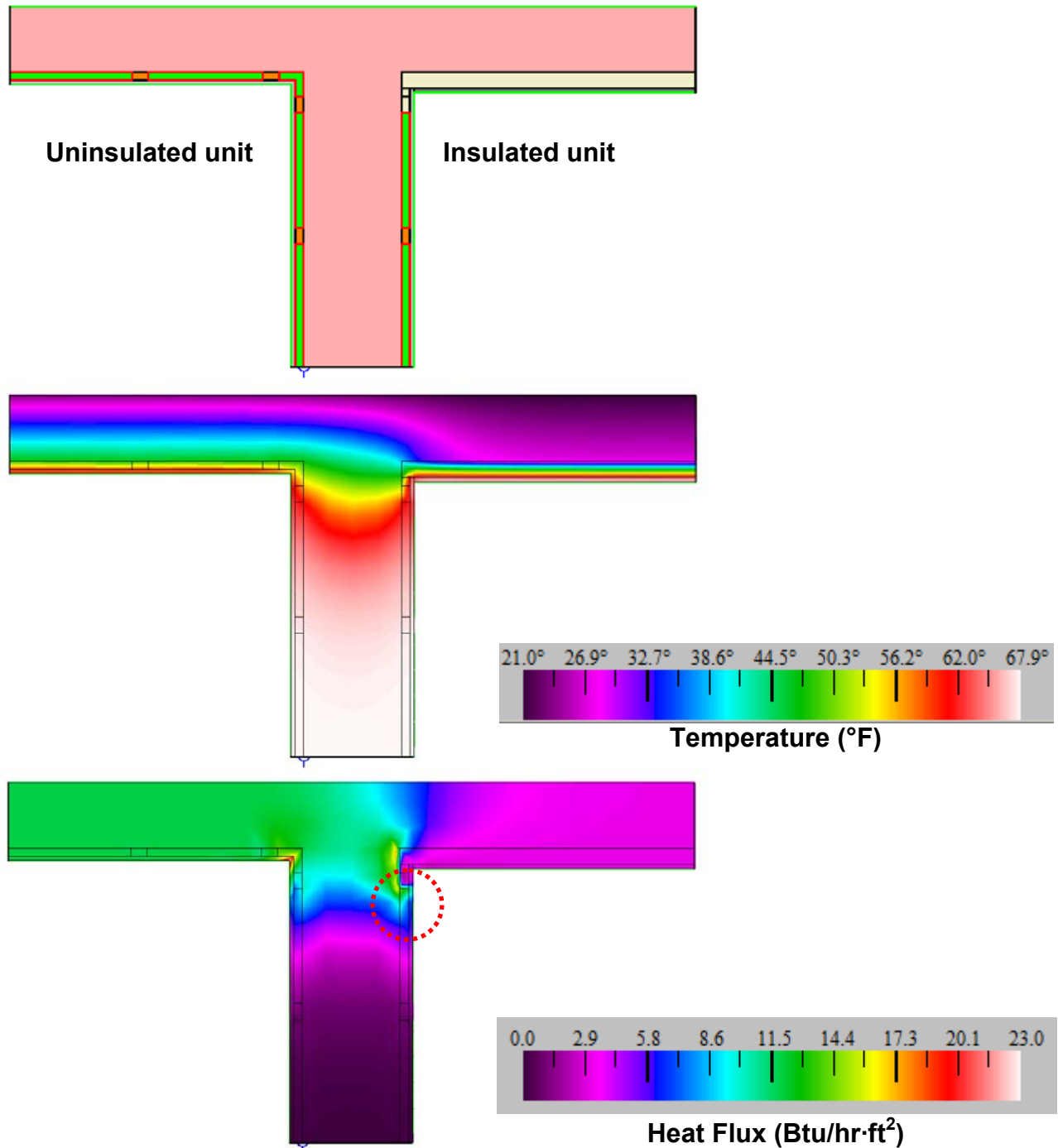

**Figure 44. Tee wall with 2-in. spray foam and foam at corner depicting materials, temperature, and heat flux**

In these simulations, the highest heat flux is reduced, and interstitial condensation risks are minimal—in fact, there is less risk than in the base, uninsulated case. However, there are still

“corner effects” at the interior insulated corner. Additional simulations were conducted with the length of the party wall insulation increased to 1 ft. (0.3 m) (see Figure 45).

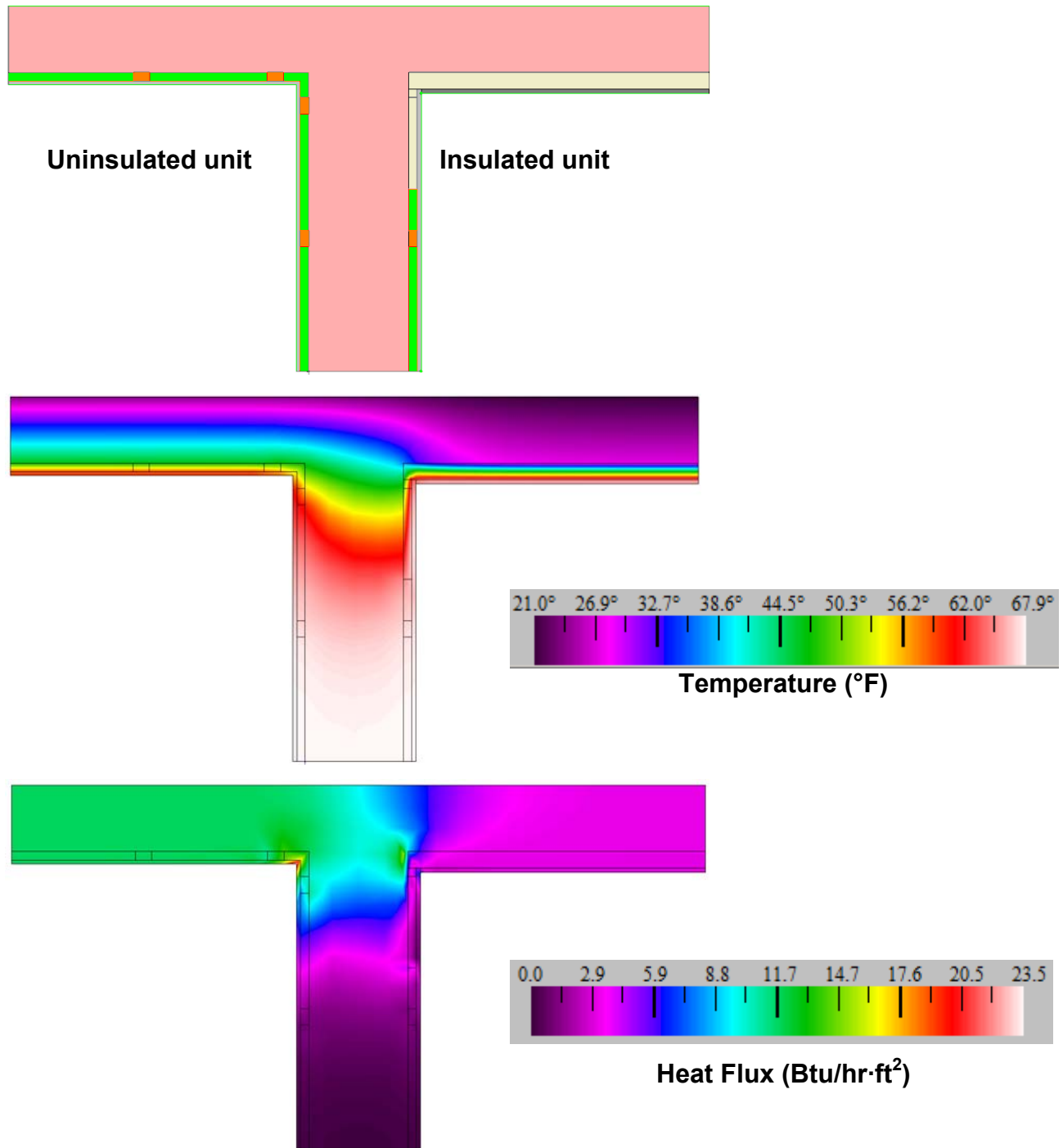

**Figure 45. Tee wall with 2-in. spray foam and 1-ft. foam at corner depicting materials, temperature, and heat flux**

These simulations show that the overall heat flux due to corner effects is strongly reduced by extending the tee wall insulation by a ft. However, it is vital to remember that these results are specific to the geometry of the building, and the relative thermal characteristics of the masonry



and the insulation material. However, this is likely a reasonable field guideline to use in these situations.

Finally, simulations were run with the 4 in. of interior spray foam being considered for a deep energy retrofit (approximately R-40 nominal), as shown in Figure 47.

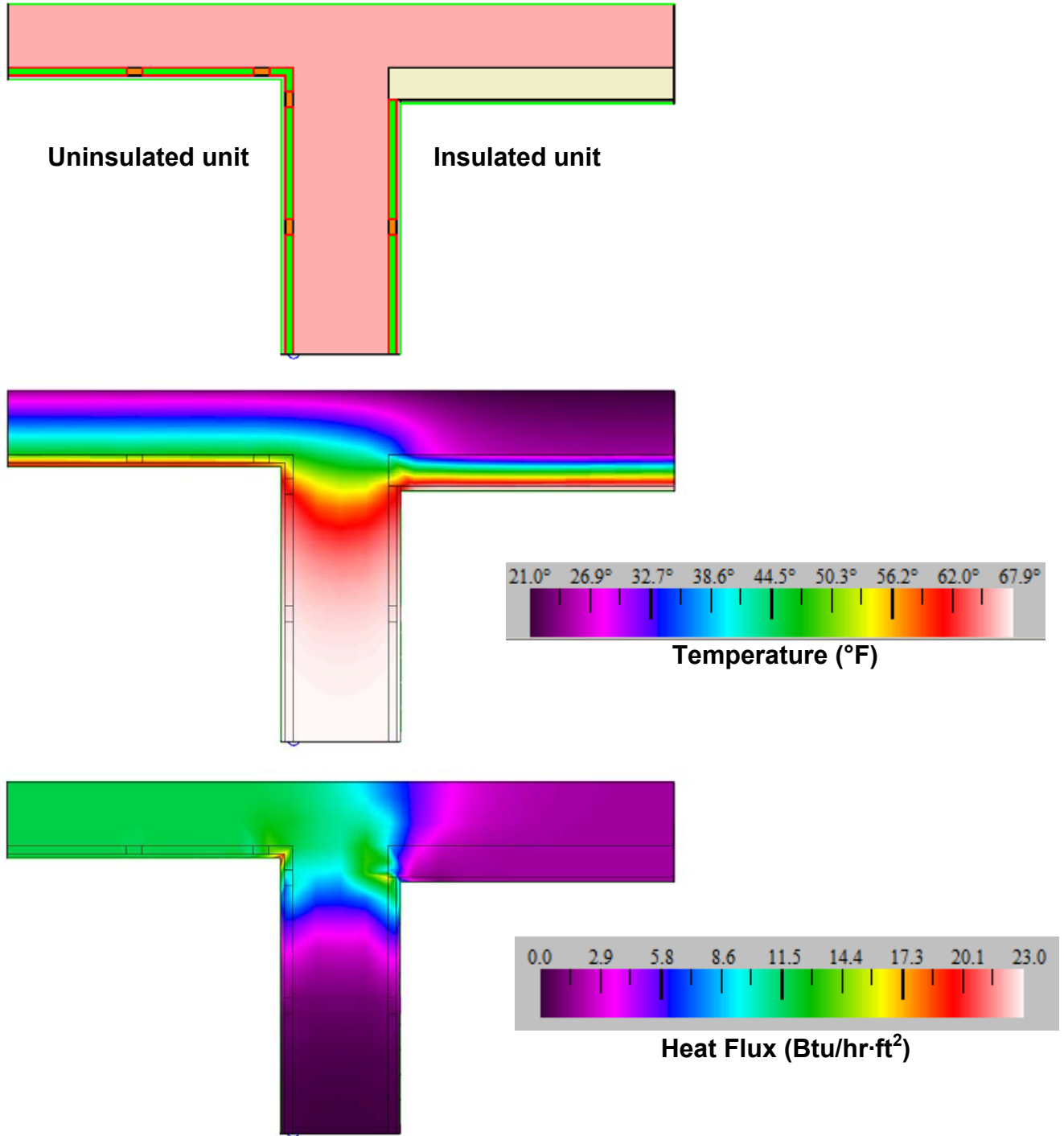

Figure 46. Tee wall with 4-in. spray foam depicting materials, temperature, and heat flux

Similar to previous cases, Figure 46 shows that heat flux through the party wall does occur. However, surface temperatures do not appear to pose a condensation risk in the postretrofit unit. Overall, if the deep energy retrofit insulation option is considered, extending this insulation onto the party wall is a reasonable step to limit heat flux.

## **5.2 Exterior Insulation of Tee (Party) Wall**

Another solution being considered for the rear of the building (which has less detailing and aesthetic impact) is to insulate on the exterior of the structure; the results for adding 2 in. of insulation are shown in Figure 47. The insulation was terminated at the mid-thickness of the party wall likely because legal restrictions prevent the retrofit from extending beyond the property line between the two buildings.

One immediately obvious effect is that the wall becomes warmer, which is intrinsic to an exterior insulation retrofit. Of course, an exterior retrofit protects the substrate inboard of the insulation (both from seasonal temperature extremes and bulk water exposure) resulting in greater durability of the structure (Hutcheon 1964; Lstiburek 2007a). The typical objection to an exterior retrofit, however, is aesthetics—particularly when the exterior has significant aesthetic value, such as a well-detailed mass masonry building does.

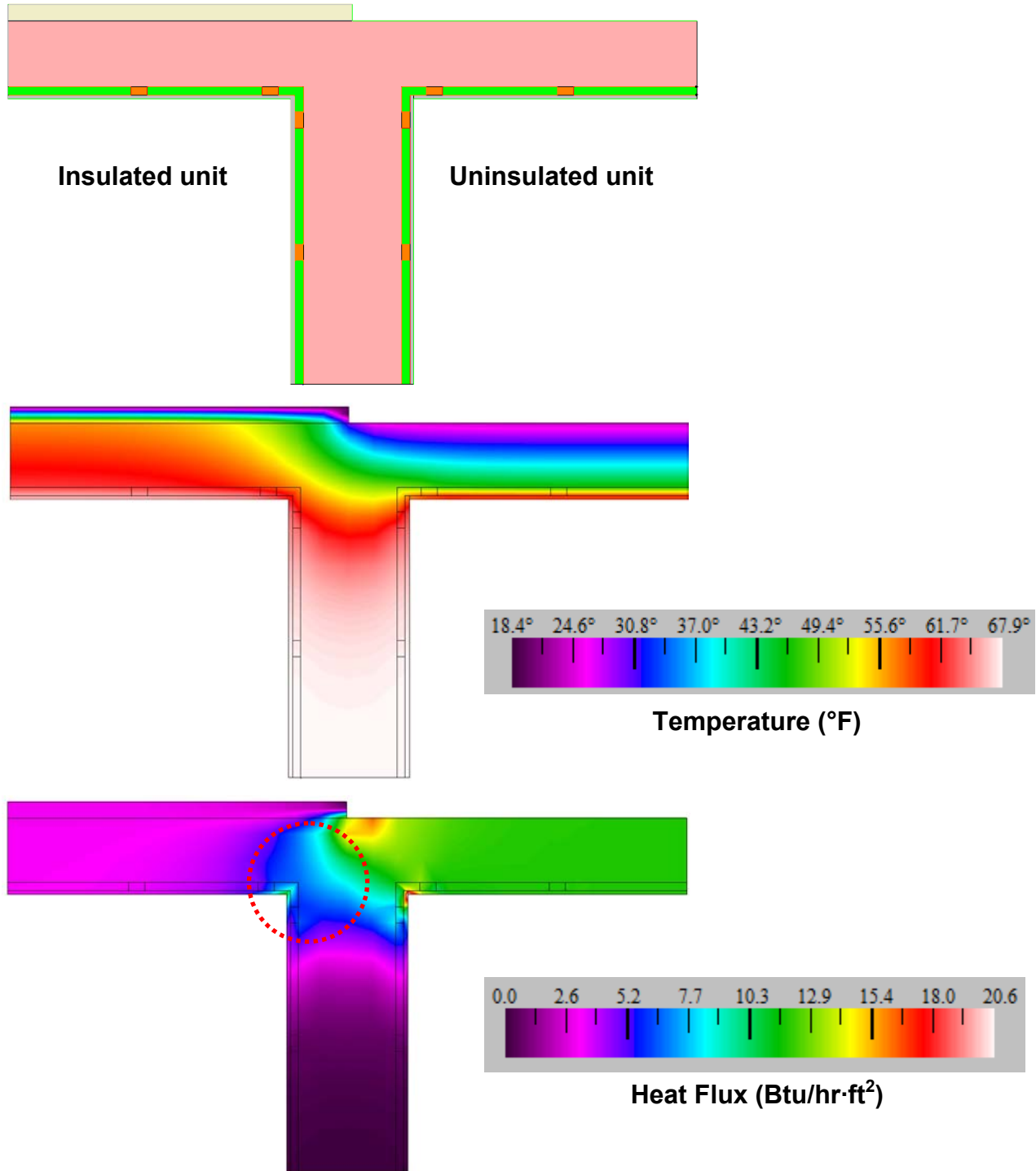

**Figure 47. Tee wall with exterior insulation (base case) depicting materials, temperature, and heat flux**

However, Figure 47 shows noticeable heat flux from thermal bridging through the masonry at the tee wall, even with exterior insulation. Therefore, simulations were run extending the exterior insulation past the midpoint of the party wall, to the far side of the masonry wall (Figure 48).

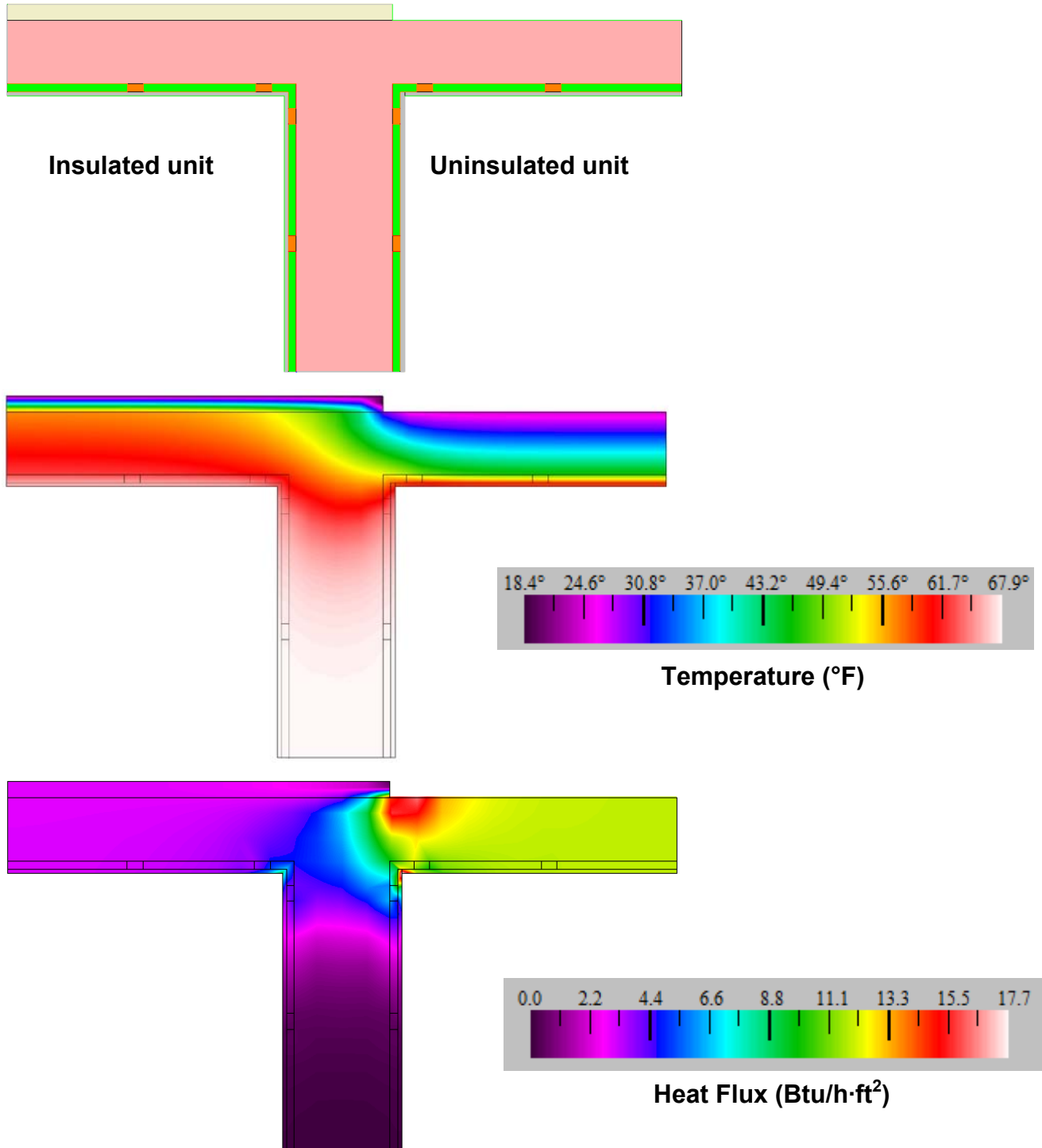

**Figure 48. Tee wall with extended exterior insulation depicting materials, temperature, and heat flux**

This change significantly reduces the heat flux from the insulated corner. Note that the color key in Figure 48 differs from previous runs, so the images should not be compared directly. Specifically, the heat flux in the corner is close to 7 Btu/h·ft<sup>2</sup>, while in the previous case (non-extended insulation), it was closer to 9 Btu/h·ft<sup>2</sup> or higher. If this additional insulation is a

measure that can be executed without causing property boundary issues, it is highly recommended.

It should be noted that exterior insulation does not address interior air barrier issues, so details to transition the air barrier to the exterior will be required.

Another item of interest is the party wall where it penetrates the roof, as shown in Figure 49. The effect of this thermal bridge could be simulated to determine the effect of using an exterior insulation “cap” over the exposed wall.



**Figure 49. Capped party wall at J.P. Three-Family, and roof “wrap” over an exposed party wall**

## 6 Brick Freeze-Thaw Analysis for Jamaica Plain Three-Family

### 6.1 Material Property Test Results

Sample face bricks were collected from the front (east facing, Figure 50) and rear (west facing, Figure 51) facades of the Jamaica Plain Three-Family building.



Figure 50. Confirming existing wall assembly and collecting front (east) face brick sample



Figure 51. Confirming existing wall assembly and collecting rear (west) face brick sample

The researchers conducted material property tests on the sample bricks to facilitate the hygrothermal simulations and inform the assessment of FT risk. The test method, material properties, and results are summarized in the sections that follow.

#### 6.1.1 Dry Density

Dry density is a basic characteristic that describes brick. It is used as an input to the Wärme- Und Feuchttransport Instationär (WUFI) 4.1 Pro hygrothermal simulation program. The program uses dry density when predicting how much heat and moisture is stored in a material over a given time period.

To determine dry density, brick samples are dried in a gravity oven and periodically weighed using a precision scale. Drying continues until there is no longer any change in mass. The

volume of each brick sample is then determined using a liquid displacement method. The dry mass is simply divided by the volume to calculate the dry density.

The dry density of front brick was 120 lb/ft<sup>3</sup> and the rear brick was 130 lb/ft<sup>3</sup>.

### **6.1.2 Water Absorption Coefficient (A-value)**

The water absorption coefficient ( $A_w$  or A-value) characterizes the capillary uptake of a brick. It is used in WUFI 4.1 Pro to predict the movement of liquid water under capillary suction and redistribution.

To obtain A-value, oven-dried bricks are placed so that their exposed face (i.e., the outside face of the brick) is just in contact with a pool of distilled water. The samples are periodically removed from the water, weighed using a precision scale, and placed back in contact with the water surface. The measured mass is plotted against the square root of the time of the measurements and normalized for cross-sectional area. The A-value is determined from the slope of this graph and has the rather unusual units of lb./in<sup>2</sup> √s.

The A-value was 0.000157 lb./in<sup>2</sup> √s for the front brick and 0.000115 lb./in.<sup>2</sup> √s for the rear brick.

### **6.1.3 Free Water Saturation**

Free water saturation occurs when a material is in contact with a water surface on its bottom face and surrounded by air at 100% relative humidity (RH) so that evaporation cannot occur and the material reaches an equilibrium moisture content (i.e., its weight will no longer change no matter how long it remains in contact with the water surface and is surrounded by 100% RH). Free water saturation moisture content is used in WUFI 4.1 Pro to predict the movement and storage of moisture in materials.

Free water saturation can quickly be estimated by placing brick samples in boiling water for 5 hours. The brick samples are then allowed to cool to room temperature while in the water bath. The free water saturation mass of each brick sample is determined using a precision scale and the free water saturation moisture content is calculated by subtracting each sample's previously determined dry weight and dividing by the volume.

The free water saturation moisture content of the brick samples was found to be 18.4 lb/ft<sup>3</sup> or 15.3% for front brick and 12.6 lb/ft<sup>3</sup> or 9.7% for rear brick.

### **6.1.4 Vacuum Saturation**

The vacuum saturation moisture content is used to estimate the amount of moisture that can be held in the brick when all of its pores are filled with water. This characteristic value is used to determine the degree of saturation when assessing resistance to FT action.

To determine vacuum saturation, carefully cut brick "slices" (approximately 3/8-in. thick) are placed in a desiccator and a vacuum pump is used to remove 99.9% of the air. The vacuum pump is shut off and water is supplied to the desiccator. Because nearly 100% of the pores of the brick slices are filled with water in this process, the brick slices are called "vacuum saturated." The vacuum saturation moisture content is determined by weighing each vacuum saturated slice using a precision scale and subtracting its previously determined oven dry weight and dividing by the volume.

The average vacuum saturation moisture content of the prepared brick 'slices' was 19.5 lb/ft<sup>3</sup> or 16.3% moisture content for front brick and 14.8 lb/ft<sup>3</sup> or 11.4% moisture content for rear brick.

### **6.1.5 Critical Degree of Saturation**

The critical degree of saturation ( $S_{crit}$ ) is used to predict the severity of FT events when assessing FT risk. The degree of saturation is the fraction of saturation relative to complete vacuum saturation. For example, at 0.5 degrees of saturation, the brick contains 50% of the moisture that it would at vacuum saturation. Fagerlund (1977) showed that below some  $S_{crit}$ , no FT damage is possible, regardless of the number of temperature excursions below freezing. Similarly, very few freezing cycles are needed to cause damage if the moisture content is above  $S_{crit}$ .

Carefully prepared brick slices are outfitted with measurement targets and the pretest length is measured using a precision micrometer. The slices are then brought to various degrees of saturation (e.g., 0.2, 0.4, 0.6, etc.) and sealed in packaging so that the moisture does not escape. The sealed slices are allowed to rest for several days so that internal moisture can distribute uniformly throughout each slice. The slices are then immersed in a controlled temperature bath and subjected to six FT cycles. The slices are then brought back to room temperature, removed from the bath, and the post-test length measured. The change in dimension is used to assess the resistance to FT action and estimate the  $S_{crit}$  at which the material becomes susceptible to FT damage.

The estimated  $S_{crit}$  for the brick slices tested was between 0.4 and 0.7 for both samples.

## **6.2 Hygrothermal Simulations**

The WUFI 4.1 Pro computer model was used to simulate the effects of insulating the walls on the moisture and temperature conditions of the masonry walls. WUFI is one of the most advanced commercially available hygrothermal moisture programs in use today. Its accuracy has been verified (by the Fraunhofer-Institut für Bauphysik in Germany) against numerous full-scale field studies of enclosure performance (roofs, walls, foundations, parking garage decks, etc.) over a number of years. Much of the field verification work supporting the model has been solid masonry and stone wall systems.

WUFI is one of the few models in the public domain that can properly account for rain absorption and different water absorption/redistribution for arbitrary material data and boundary conditions. Given the appropriate material data, WUFI calculates heat and moisture flow every hour under the influence of sun, rain, temperature, and humidity (for more information, see <http://www.wufi.de>). The analysis is, however, only as accurate as the assembly data, the material properties, and the interior and exterior conditions input.

### **6.2.1 Air Leakage**

The WUFI 4.1 Pro computer model has the capacity to predict air-leakage-induced wetting and drying; however, we have not made use of this feature because the leakage path and driving forces are unknown, and are generally unique. The time scale of wind-induced air leakage is also much shorter than 1 hour.

In all of the cases studied in this project it has been assumed that air leakage across the enclosure has been substantially controlled by standard air sealing techniques. It is not reasonable to attempt to design a retrofit with a significant amount of air leakage. However, experience has shown that air barrier systems formed by careful taping, caulking, use of spray polyurethane products and fully adhered membranes are quite likely to achieve high levels of airtightness when properly installed using standard quality control measures. Before and after blower door air leakage testing can be carried out to identify air leakage paths and to subsequently confirm if air sealing was successful.



### 6.2.2 Climate Data

Climate data for Boston, Massachusetts, available in the WUFI 4.1 Pro database, was used for this analysis.

The building is currently not air conditioned; however, the owner is considering air conditioning as part of the retrofit. Our analysis assumes that the building will be air conditioned after retrofit.

### 6.2.3 Material Properties

Because it is often not convenient (or even possible) to determine the many material properties necessary for hygrothermal simulations, WUFI 4.1 Pro includes a database of several hundred common materials. However, hygrothermal computer models are only as reliable as their input data, and it is advisable to measure and use key material properties whenever this can easily be done.

Table 6 presents several important material properties for selected brick from our WUFI materials database. For the purposes of our simulations, BSC has chosen to use a modified version of the Solid Historical brick for the brick wythes. The modifications reflect the material properties measured in the BSC laboratory.

**Table 6. Material Properties for Selected Brick**

Name	Source*	Density lb/ft <sup>3</sup>	Conductivity BTU/(hr ft <sup>2</sup> °F)	VDRF -	A <sub>w</sub> lb./in <sup>2</sup> √s	Free Saturation lb/ft <sup>3</sup>	%
Brick (old)	ASHRA E 1018	104.3	0.23	16	-	12.2	12%
Dunning Red Fill Brick	BSI	114.6	-	-	0.00023	17.4	15%
Red Matt Clay brick	MEWS	120.8	0.29	137.8	0.00004	3.5	3%
Solid Brick Masonry	IBP	118.6	0.35	10	0.00016	11.9	10%
Solid Brick Extruded	IBP	103.0	0.35	9.5	0.00057	23.1	22%
Solid Brick Hand Formed	IBP	107.7	0.40	17	0.00043	12.5	12%
Solid Brick Historical (front façade)	IBP	120.1	0.35	15	0.000157	18.4	15.3%
Solid Brick Historical (rear façade)	IBP	129.6	0.35	15	0.000116	12.5	9.7%

\*All values taken from WUFI material database

### 6.2.4 Assessing Freeze-Thaw Performance

Although FT damage is an age-old problem, it still cannot be accurately predicted. For example, physical testing of individual bricks is commonly considered to be the best measure, despite the fact that the ASTM and CSA standards often reject bricks found from experience to be durable

and sometimes accept bricks that fail in the field (Vickers 1993; Arnott and Maurenbrecher 1990; Robinson et al. 1995).

Different materials, such as clay brick, calcium silicate, concrete, and natural stones exhibit different susceptibility to FT damage. Hence, the approach taken in this report has been to assess the potential for FT damage based on the microclimatic conditions experienced by the material in question.

It is well accepted that two factors have the most importance to FT damage: the moisture content during freezing and the number of FT cycles. BSC has defined a freeze cycle as occurring when the temperature within the material drops below 23°F and a thaw cycle to occur when the temperature rises above 32°F. This is based on the observation (Litvan 1988) that FT is not a problem at temperatures just below freezing—damage tends to require temperatures much colder than 23°F and most test standards require the material to be cooled below 5°F.

The process by which BSC calculates the number of potentially damaging FT cycles from hourly data is shown in Figure 52. The critical moisture content for FT damage is defined as the moisture content above which FT damage can occur. From BSC's testing on the brick samples collected during our visit to the Jamaica Plain Three-Family building, it has been determined that the critical moisture content is between 40% and 70% of the saturation moisture content ( $0.4 < S_{crit} < 0.7$ ).

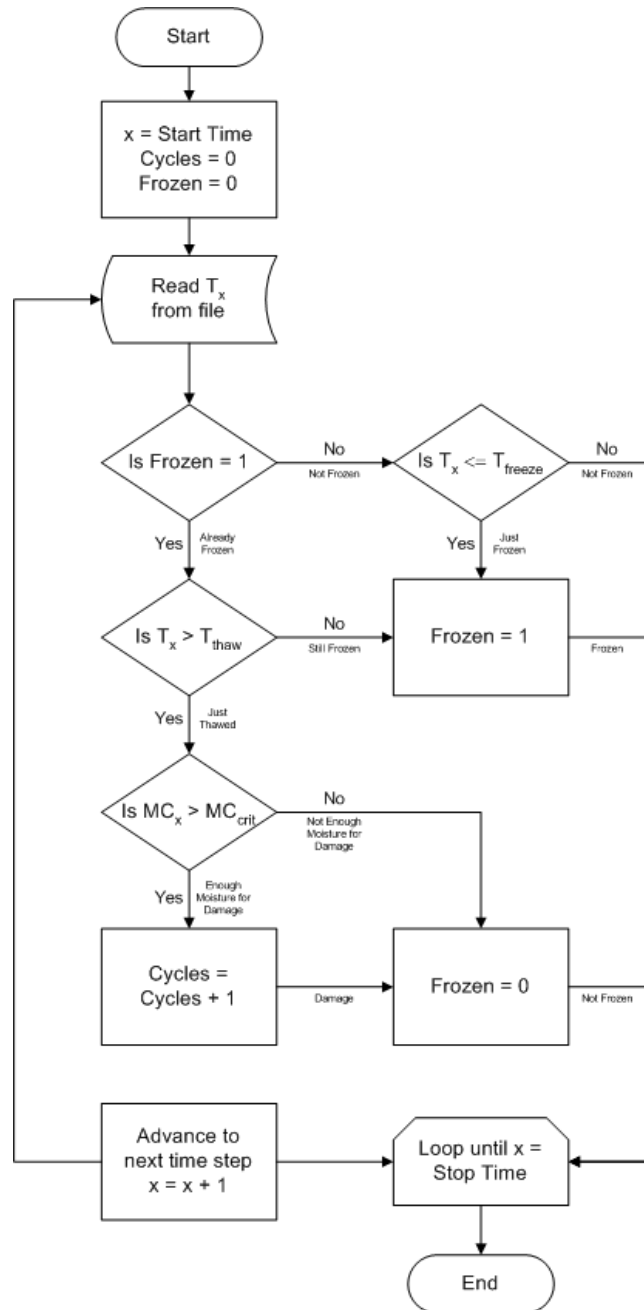
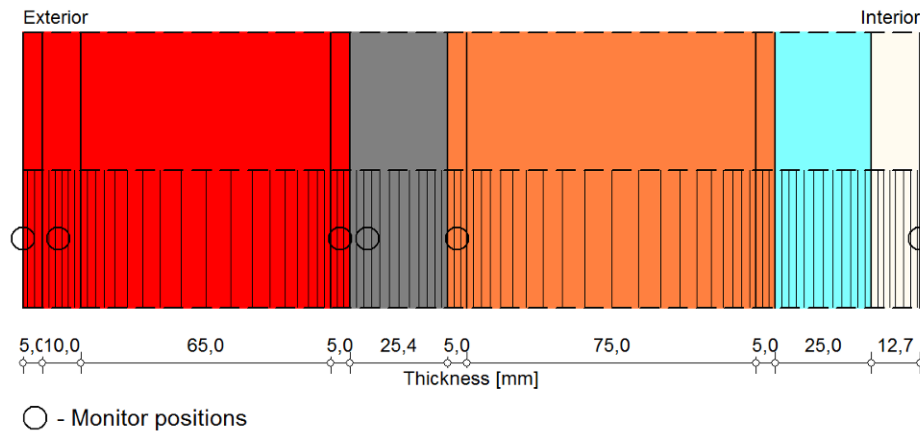

Figure 52. Freeze-thaw damage potential assessment procedure

### 6.2.5 Simulation Model

Figure 53 shows the WUFI 4.1 Pro model for the existing wall system. The various materials used in the wall assembly are represented by different colors. This image depicts the red face brick (represented by the four red rectangles on the far left), followed by a layer of air/mortar (light grey), the inner brick (orange), an air/wood strapping layer (light blue), and the interior lath and plaster (white rectangle on the far right). The existing wall was modeled to have a number of layers of oil-based paint on the interior plaster (dashed line at the interior surface).

BSC created similar models for the proposed insulation retrofit options by adding insulation and gypsum board layers to the interior of the existing wall system model. Options analyzed include 2 in. of 2 lb/ft<sup>3</sup> ccSPF, 6 in. of 2 lb/ft<sup>3</sup> ccSPF, and 6 in. of 1 lb/ft<sup>3</sup> SPF.



**Figure 53. WUFI 4.1 Pro model of existing wall system**

Previous simulations or similar constructions have found that a subsurface layer on the exterior of the face brick and a layer on interior of the face brick experienced the highest moisture concentrations and largest and most frequent temperature swings. BSC has modeled these as a 10-mm (approximately 3/8-in.) thick volume, which lies 5 mm (approximately 1/4 in.) inside the exterior face, and a 5-mm (approximately 1/4-in.) thick volume at the interior face. These two layers were used in assessing the potential for damaging FT cycles.

### 6.2.6 Other Considerations

Simulations were conducted for both the west-facing rear wall and east-facing front wall to assess the impact of solar radiation and rain on different orientations. Low, medium, and high rain exposures were all considered because a building’s geometry and architectural detailing can act to concentrate or minimize the amount of rainwater incident on its wall surfaces.

### 6.3 Results and Interpretation

Three key variables need to be considered when interpreting the results. One variable is the uncertainty in the brick properties, most importantly, the  $S_{crit}$ . Another variable is that buildings often have localized areas of rainwater concentration caused by architectural details. Finally, the weather data used is from Boston airport which likely has a considerably greater rain exposure than the building does.

Postprocessing is used to analyze the hourly predicted temperature and moisture content values produced by the hygrothermal simulations. The assessment of damaging FT cycles can also be carried out graphically by plotting the predicted temperature and moisture content at any layer and checking for instances when the temperature is below 23°F while the moisture content is over the critical saturation moisture content.

It is evident that the temperature frequently travels below the 23°F threshold for FT cycling on east and west façades. The moisture content spikes correspond to wetting caused by rain events. The simulation shows a low FT risk for the existing building as evident by the good condition of

the current façade. The simulation and the existing conditions of the building suggest that  $S_{crit}$  is close to 0.7 and that the building has a low rain exposure.

The addition of thermal insulation to the inside of the wall reduces the temperature of the brickwork. The insulation also limits the ability of the wall to dry to the inside of the building and limits outward heat flow which assists outward drying.

On the rear west façade, simulations (see Figure 54) show a low FT risk similar to that of the existing enclosure with any of the insulation retrofits modeled where rainwater concentrations are avoided. If the actual  $S_{crit}$  of the brick is close to 0.7, FT risk remains low even at locations of relatively high rain exposures. If the actual  $S_{crit}$  of the brick is close to 0.4, freeze-thaw risk is high at locations of relatively high rain exposures.

The east façade rain exposure was higher in the model, and the brick had a greater liquid water uptake rate. If the actual  $S_{crit}$  of the brick is close to 0.4, the model (see Figure 55) shows significant increases for FT degradation risk due to any of the retrofit strategies. If the actual  $S_{crit}$  of the brick is close to 0.7, the model shows that only the retrofit option of adding 3 in. of 1 lb/ft<sup>3</sup> spray foam results in a similarly low FT degradation risk where rainwater concentrations are avoided.

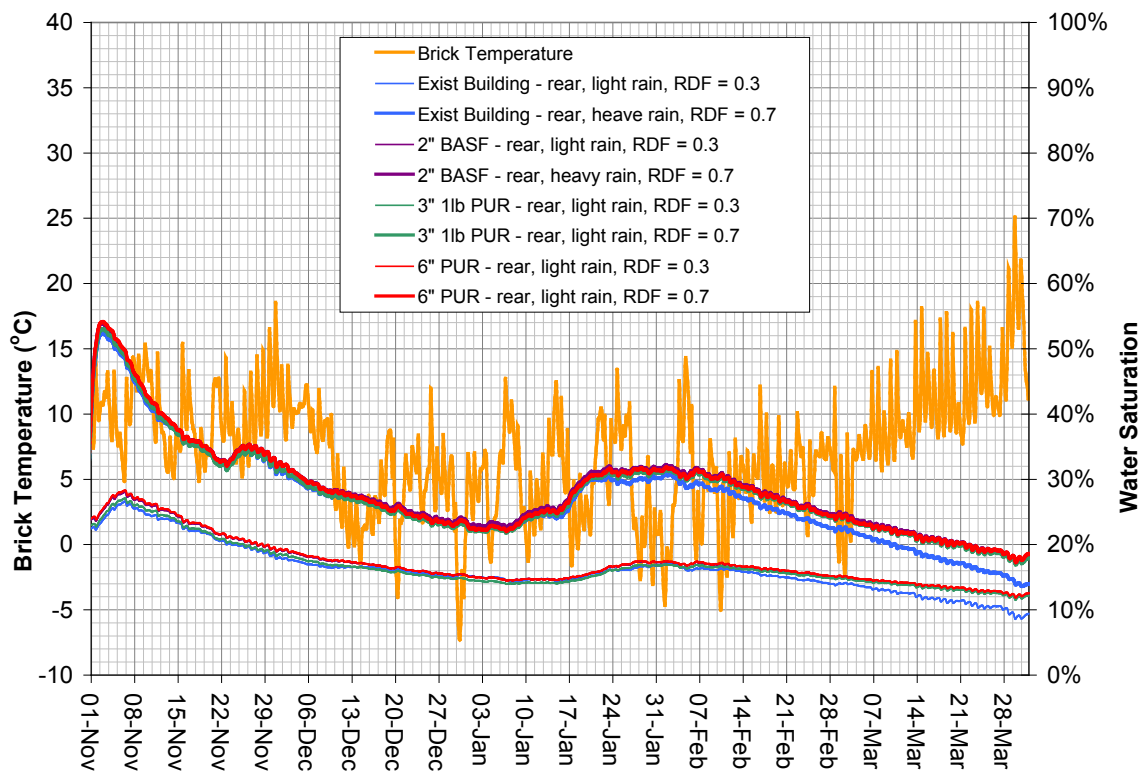
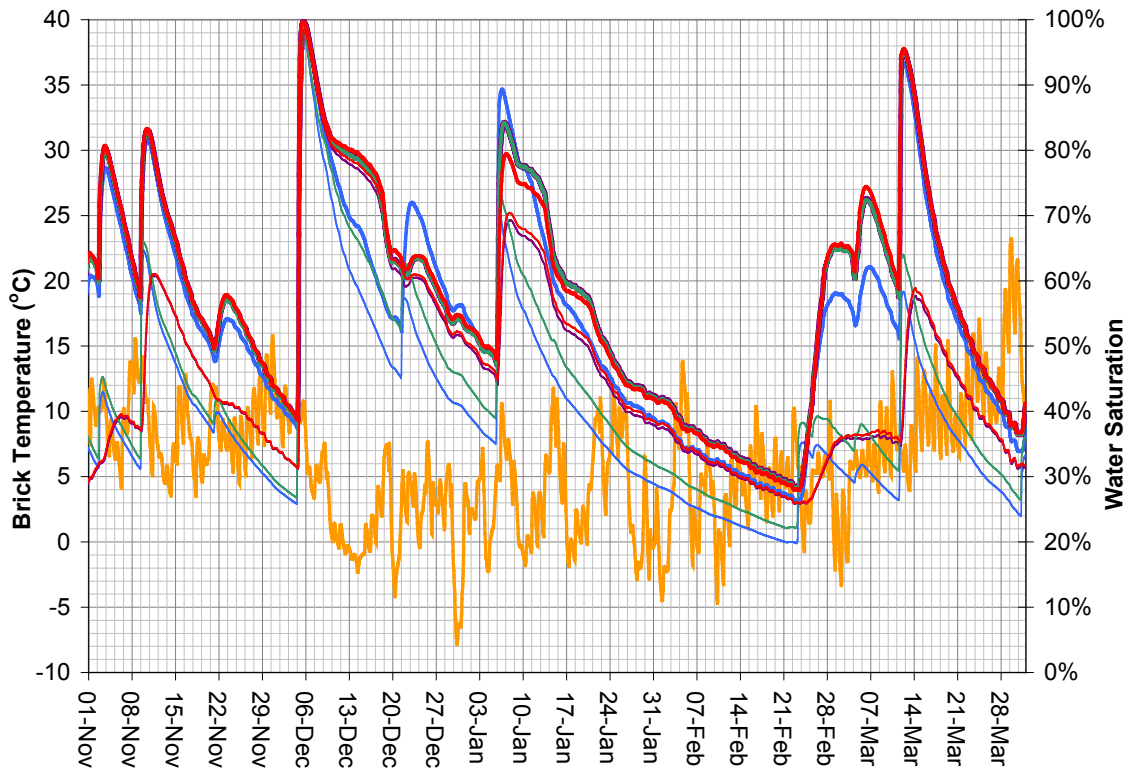

Figure 54. Predicted winter conditions at back of rear face brick



**Figure 55. Predicted winter conditions at back of front face brick**

### 6.3.1 Freeze-Thaw Risk Conclusions

Further testing is recommended to more accurately determine the  $S_{crit}$  value of the brick. This can be completed with the remaining portion of the brick sample that is available. Testing of more sample brick would further reduce the uncertainty of the material properties and the conclusion drawn from the work.

Site monitoring of driving rain is also recommended to more accurately determine driving rain loading on the façade.

The analysis shows a low risk of FT degradation of the brickwork on the rear west façade with any of the proposed insulation retrofits given that rainwater concentrations can be avoided.

The analysis shows a significantly increased risk of FT degradation at the rear of the face bricks on the front east façade with the various insulation retrofits assuming that the  $S_{crit}$  value of the brick is actually at the lower end of the range found in our testing. If the  $S_{crit}$  value is at the higher end of the range found in our testing, then the analysis suggests that the 2 in. of 2 lb/ft<sup>3</sup> ccSPF and 6 in. of 1 lb/ft<sup>3</sup> SPF retrofits result in a significant increase in FT risk, while the retrofit option using 3 in. of 1 lb/ft<sup>3</sup> SPF did not significantly raise the FT risk.

Considering the importance of the  $S_{crit}$  value, BSC recommends awaiting further testing results before making a decision on insulation retrofit. If a greater amount of insulation than 3 in. of 1 lb/ft<sup>3</sup> SPF is desired, BSC suggests onsite driving rain monitoring and reanalysis to ensure FT degradation risk at the front east of the building is minimal. In any case, BSC recommends addressing rainwater concentration problems which are causing currently degradation problems and may become more problematic with insulation retrofit.

## 7 Conclusions

BSC assessed the Jamaica Plain Three-Family building for exterior masonry conditions (for evidence of FT damage), basement conditions (examining efflorescence and capillary action), roof conditions, window conditions, airtightness, and mechanical systems. Simulations were performed with BEopt and EgUSA software packages to determine energy impacts and cost-effectiveness of various retrofit measures. The EgUSA results are shown in a step-by-step parametric model, providing impact of individual measures. In addition, utility bill energy use data was examined for trends and to “tune” the energy models to some degree.

Enclosure measures under consideration include superinsulation of the masonry walls (either interior or exterior), roof retrofit (including air impermeable insulation for condensation control and air leakage control), basement wall and slab insulation (with complications due to capillary transport and embedded wood members), window upgrades (possibly with low e storm windows on the exterior of existing double glazed windows), and air leakage reductions (to various tightness levels). Some of the recommended upgrades have issues to their implementation as a retrofit strategy, such as moisture-related durability issues (e.g., exterior brick wall interior insulation, or capillary rise issues at basement walls).

Mechanical system upgrades under consideration include the use of mini-split heat pumps for space conditioning (abandoning the existing gas furnace and ductwork system), instantaneous water heaters, and lighting and appliance upgrades. The mini-split heat pump retrofit is an excellent solution to the small heating loads that result from a deep energy retrofit; however, there are some concerns about whether single point heating will be sufficient given the concentrated loads in the front and back of each apartment unit. In addition, there may be restrictions due to Massachusetts rental law requirements. The recommended upgrade for the domestic water heating system was a single central high-efficiency water heater (e.g., condensing tank), which would likely have a lower installed costs than three instantaneous condensing gas water heaters. However, a single water heater would eliminate the ability to easily submeter hot water gas use (individual appliances allow for submetering at the gas meter level).

One issue that was examined in detail is the effect of thermal bypass or thermal bridging with various masonry wall insulation retrofit details. Specifically, BSC modeled a tee wall or party wall between two units to determine the effect of the common practice of insulating only one side of the party wall. Two-dimensional heat flow simulations showed that the party wall provides a thermal bridge; however, adding interior insulation to the party wall roughly 1 ft from the exterior wall substantially reduces this effect. In addition, if an exterior insulation approach is chosen, insulating only to the property line (mid-thickness of the party wall) results in thermal bridging issues; extending this insulation at least to the far side of the party wall reduces the heat flux through this system.

The final issue examined in detail was a FT assessment of the building to determine its suitability to interior insulation retrofit. Brick samples were collected from the building, and material property tests were performed. These results were used as inputs to one-dimensional hygrothermal simulations, with various orientations, degrees of rain exposure, and insulation thicknesses/materials. The material property testing had a wide range of  $S_{crit}$  values, leaving high uncertainty; therefore, additional testing is necessary before making final recommendations. In fact, if the lower range of  $S_{crit}$  values is the “true” value, interior insulation is not recommended.

If the  $S_{crit}$  value is at the higher end, moderate levels of insulation (3 in. of 1 lb/ft<sup>3</sup> open cell urethane spray foam) will not significantly raise FT risks. However, greater insulation and/or less vapor permeability to the interior, as would occur with 2 in. of 2 lb/ft<sup>3</sup> closed cell urethane spray foam, or 6 in. of 1 lb/ft<sup>3</sup> open cell foam, results in a significant increase in FT damage at the exposure levels modeled.

After the preliminary brick testing was completed, the owner decided not to insulate the exterior walls at this time. A retrofit including demolition of interior finishes was considered to be too intrusive and not feasible. Given the limited exposure of the exterior walls, retrofitting this component is lower on the priority list for the owner. However, other retrofit measures that will improve the performance of the building are being pursued, such as the installation of insulation at the roof and the replacement of the mechanical systems. Retrofit measures at the basement walls and slab are next on the priority list for the owner.

Given that the exterior walls will not be receiving any insulation at this time, the project no longer qualifies for the comprehensive or full deep energy retrofit through the National Grid DER Pilot Program. However, the owner may qualify for the partial or staged deep energy retrofit.



## References

- Arnott, M.R; Maurenbrecher, A.H.P. (1990), An alternative test for determining the frost resistance of bricks. *The Masonry Society Journal* (9:1) p. 105.
- ASHRAE (2010). *ASHRAE Standard 62.2-2010: Ventilation and Acceptable Indoor Air Quality in Low-Rise Residential Buildings*. Atlanta, GA: American Society of Heating, Refrigerating, and Air-Conditioning Engineers.
- BSC (2011). “Initial New Construction Pilot Community Evaluations – Transformations, Inc., Massachusetts – Cold Climate “.
- Christensen, C.; Anderson, R. (2006). *BEopt™ Software for Building Energy Optimization: Features and Capabilities*. NREL/TP-550-39929. Golden, CO: National Renewable Energy Laboratory. Accessed June 23, 2011: <http://www.nrel.gov/buildings/pdfs/39929.pdf>.
- ENERGY STAR Performance Ratings Methodology for Incorporating Source Energy Use*, Accessed May 16, 2011: [http://www.energystar.gov/ia/business/evaluate\\_performance/site\\_source.pdf](http://www.energystar.gov/ia/business/evaluate_performance/site_source.pdf).
- Fagerlund, G. (1977). “The critical degree of saturation method of assessing the freeze/thaw resistance of concrete.” *Materials and Structures* (10:58), pp. 217-230.
- Hutcheon, N.B. (1964). NRC-IRC (National Research Council of Canada-Institute for Research in Construction) Canadian Building Digest CBD-50. *Principles Applied to an Insulated Masonry Wall*, Ottawa, ON: National Research Council of Canada.
- International Code Council (2009), *International Residential Code for One- and Two-family Dwellings*. Country Club Hills, IL: International Code Council.
- THERM 5.2: A PC Program for Analyzing Two-Dimensional Heat Transfer through Building Products*. (2003). Berkeley, CA: Lawrence Berkeley National Laboratory.
- Litvan, G. (1988). “The Mechanism of Frost Action in Concrete – Theory and Practical Implications.” *Proceedings of Workshop on Low Temperature Effects on Concrete*. September 5-9, 1988, Sapporo, Hokkaido, Japan. Ottawa, Ontario: IRC/NRCC; pp. 116-127.
- Lstiburek, J.W. (2005). “Understanding Air Barriers.” *ASHRAE Journal* (47); pp. 24–30. Atlanta, GA: American Society of Heating, Refrigeration, and Air-Conditioning Engineers, Inc.
- Lstiburek, J.W. (2007a). “Building Sciences: The Perfect Wall.” *ASHRAE Journal* (50); pp. 74–78. Atlanta, GA: American Society of Heating, Refrigeration, and Air-Conditioning Engineers, Inc.
- Lstiburek, J.W. (2007b). “Building Sciences: Capillarity-Small Sacrifices.” *ASHRAE Journal* (49); pp. 58–61. Atlanta, GA: American Society of Heating, Refrigeration, and Air-Conditioning Engineers, Inc.

Lstiburek, J.W. (2008). “Building Sciences: Concrete Floor Problems.” *ASHRAE Journal* (50); pp. 28–32. Atlanta, GA: American Society of Heating, Refrigeration, and Air-Conditioning Engineers, Inc.

Lstiburek, J.W. (2010). *Attic Air Sealing Guide and Details*. Westford, MA: Building Science Corporation, Accessed January 7, 2011: <http://www.buildingscience.com/documents/guides-and-manuals/gm-attic-air-sealing-guide/view>.

Melton, P.; Yost, P. (2011). “Making Windows Work Better.” *Environmental Building News*, (20:6).

National Grid (2009). “Deep Energy Retrofit Multifamily and Single-family Pilot Guidelines,” National Grid, Accessed May 16, 2011: [http://www.powerofaction.com/media/der\\_desc.pdf](http://www.powerofaction.com/media/der_desc.pdf).

National Park Service (1979). *Preservation Brief 6: Dangers of Abrasive Cleaning to Historic Buildings*, Washington, DC: National Park Service.

Parker, D., Broman, P.; Grant, J.; Gu L.; Anello, M.; Vieira R.; Henderson, H. (1999). “EnergyGauge USA: A Residential Building Energy Design Tool.” *Proceedings of Building Simulation '99*, September 1999, Kyoto, Japan. College Station, TX: Texas A&M University.

Perry, R.H; Chilton, C.H. (1973). *Chemical Engineer's Handbook*. 5th edition. New York: McGraw Hill. pp. 6-14.

Robinson, G.C.; Butler, D.; Smalley, A., (1995), “Predicting Brick Frost-Resistance Part 1.” *Proc. of American Ceramic Society Bulletin*. (74:8), pp. 57-61.

Straube, J. (2011). *Rain Penetration Control for Institutional, Commercial and Industrial Buildings*. Westford, MA: Building Science Press.

Vickers, M.A. (1993). “Comparison of Laboratory Freeze-Thaw Procedures,” J.M. Melander and L.R. Lauersdorf, Eds., *Masonry: Design and Construction, Problems and Repair*, ASTM STP 1180, Philadelphia, PA: American Society for Testing and Materials.

## **Appendix A**

### **Jamaica Plain Three-Family Heating and Cooling Manual J Results**



## Project Report

### General Project Information

Project Title: Buhs II  
 Designed By: BSC  
 Project Date: Thursday, June 16, 2011

### Design Data

Reference City: Boston, Massachusetts  
 Building Orientation: Front door faces Northeast  
 Daily Temperature Range: Medium  
 Latitude: 42 Degrees  
 Elevation: 15 ft.  
 Altitude Factor: 0.999  
 Elevation Sensible Adj. Factor: 1.000  
 Elevation Total Adj. Factor: 1.000  
 Elevation Heating Adj. Factor: 1.000  
 Elevation Heating Adj. Factor: 1.000

	Outdoor Dry Bulb	Outdoor Wet Bulb	Outdoor Rel.Hum	Indoor Rel.Hum	Indoor Dry Bulb	Grains Difference
Winter:	7.4	6.5	80%	n/a	70	n/a
Summer:	91	73	43%	50%	75	28

### Check Figures

Total Building Supply CFM:	791	CFM Per Square ft.:	0.244
Square ft. of Room Area:	3,248	Square ft. Per Ton:	1,519
Volume (ft <sup>3</sup> ) of Cond. Space:	27,156		

### Building Loads

Total Heating Required Including Ventilation Air:	28,426 Btuh	28.426 MBH
Total Sensible Gain:	19,241 Btuh	80 %
Total Latent Gain:	4,834 Btuh	20 %
Total Cooling Required Including Ventilation Air:	24,075 Btuh	2.01 Tons (Based On Sensible + Latent)
		2.14 Tons (Based On 75% Sensible Capacity)

### Notes

Rhvac is an ACCA approved Manual J and Manual D computer program.  
 Calculations are performed per ACCA Manual J 8th Edition, Version 2, and ACCA Manual D.  
 All computed results are estimates as building use and weather may vary.  
 Be sure to select a unit that meets both sensible and latent loads according to the manufacturer's performance data at your design conditions.



## Load Preview Report

Scope	Net Ton	ft. <sup>2</sup> /Ton	Area	Sen Gain	Lat Gain	Net Gain	Sen Loss	Sys Htg CFM	Sys Clg CFM	Sys Act CFM	Duct Size
Building	2.01	1,619	3,248	19,241	4,834	24,075	28,426	275	791	791	
System 1	0.69	2,550	1,750	6,758	1,478	8,236	10,466	105	279	279	0*
Ventilation				616	678	1,294	2,409				
Zone 1			657	5,040	800	5,840	4,898	64	229	229	
3-1st_Floor_Bed_1			171	1,204	400	1,604	1,014	13	55	55	1-4
4-1st_Floor_Kitchen			146	2,010	0	2,010	1,548	20	91	91	1-6
5-1st_Floor_Dining_Room			143	266	0	266	307	4	12	12	1-4
6-1st_Floor_Living			167	1,348	400	1,748	1,637	21	61	61	1-4
7-1st_Floor_Bathroom			30	212	0	212	392	5	10	10	1-4
Zone 2			934	1,282	0	1,282	2,988	39	58	58	
1-Basement			934	1,282	0	1,282	2,988	39	58	58	1-4
Zone 3			159	98	0	98	171	2	4	4	
2-1st_floor_hall			53	26	0	26	34	0	1	1	1-4
8-2nd_floor_hall			53	26	0	26	34	0	1	1	1-4
15-3rd_floor_hall			53	46	0	46	103	1	2	2	1-4
System 2	0.65	1,155	749	6,101	1,678	7,779	8,489	79	249	249	0*
Ventilation				616	678	1,294	2,409				
Zone 1			749	5,485	1,000	6,485	6,080	79	249	249	
9-2nd_floor_Bed2			92	629	200	829	849	11	29	29	1-4
10-2nd_Floor_Bed_1			171	1,025	400	1,425	1,086	14	47	47	1-4
11-2nd_Floor_Kitchen			146	1,822	0	1,822	1,709	22	83	83	1-5
12-2nd_Floor_Dining_Room			143	257	0	257	319	4	12	12	1-4
13-2nd_Floor_Living			167	1,549	400	1,949	1,689	22	70	70	1-5
14-2nd_Floor_Bathroom			30	203	0	203	428	6	9	9	1-4
System 3	0.67	1,115	749	6,383	1,678	8,061	9,472	92	262	262	0*
Ventilation				616	678	1,294	2,409				
Zone 1			749	5,767	1,000	6,767	7,063	92	262	262	
16-3rd_Floor_Bed_1			171	1,089	400	1,489	1,310	17	50	50	1-4
17-3rd_Floor_Kitchen			146	1,877	0	1,877	1,900	25	85	85	1-5
18-3rd_Floor_Dining_Room			143	311	0	311	507	7	14	14	1-4
19-3rd_Floor_Living			167	1,612	400	2,012	1,908	25	73	73	1-5
20-3rd_Floor_Bathroom			30	214	0	214	468	6	10	10	1-4
21-3rd_floor_Bed2			92	664	200	864	970	13	30	30	1-4
Sum of room airflows may be greater than system airflow because system has multiple zones.											



## Duct Size Preview

Room or Duct Name	Source	Minimum Velocity	Maximum Velocity	Rough. Factor	Design L/100	SP Loss	Duct Velocity	Duct Length	Htg Flow	Clg Flow	Act. Flow	Duct Size
System 1												
<b>Supply Runouts</b>												
Zone 1												
3-1st_Floor_Bed_1	Built-In	450	750	0	0.1		627.5		13	55	55	1-4
4-1st_Floor_Kitchen	Built-In	450	750	0	0.1		465.6		20	91	91	1-6
5-1st_Floor_Dining_Room	Built-In	450	750	0	0.1		138.6		4	12	12	1-4
6-1st_Floor_Living	Built-In	450	750	0	0.1		702.5		21	61	61	1-4
7-1st_Floor_Bathroom	Built-In	450	750	0	0.1		110.5		5	10	10	1-4
Zone 2												
1-Basement	Built-In	450	750	0	0.1		668.1		39	58	58	1-4
Zone 3												
2-1st_floor_hall	Built-In	450	750	0	0.1		13.6		0	1	1	1-4
8-2nd_floor_hall	Built-In	450	750	0	0.1		13.6		0	1	1	1-4
15-3rd_floor_hall	Built-In	450	750	0	0.1		24		1	2	2	1-4
<b>Other Ducts in System 1</b>												
Supply Main Trunk	Built-In	650	900	0	0.1		0		105	279	279	0
System 2												
<b>Supply Runouts</b>												
Zone 1												
9-2nd_floor_Bed2	Built-In	450	750	0	0.1		327.8		11	29	29	1-4
10-2nd_Floor_Bed_1	Built-In	450	750	0	0.1		534.2		14	47	47	1-4
11-2nd_Floor_Kitchen	Built-In	450	750	0	0.1		607.7		22	83	83	1-5
12-2nd_Floor_Dining_Room	Built-In	450	750	0	0.1		133.9		4	12	12	1-4
13-2nd_Floor_Living	Built-In	450	750	0	0.1		516.7		22	70	70	1-5
14-2nd_Floor_Bathroom	Built-In	450	750	0	0.1		105.8		6	9	9	1-4
<b>Other Ducts in System 2</b>												
Supply Main Trunk	Built-In	650	900	0	0.1		0		79	249	249	0
System 3												
<b>Supply Runouts</b>												
Zone 1												
16-3rd_Floor_Bed_1	Built-In	450	750	0	0.1		567.5		17	50	50	1-4
17-3rd_Floor_Kitchen	Built-In	450	750	0	0.1		626.1		25	85	85	1-5
18-3rd_Floor_Dining_Room	Built-In	450	750	0	0.1		162.1		7	14	14	1-4
19-3rd_Floor_Living	Built-In	450	750	0	0.1		537.7		25	73	73	1-5
20-3rd_Floor_Bathroom	Built-In	450	750	0	0.1		111.5		6	10	10	1-4
21-3rd_floor_Bed2	Built-In	450	750	0	0.1		346.1		13	30	30	1-4
<b>Other Ducts in System 3</b>												
Supply Main Trunk	Built-In	650	900	0	0.1		0		92	262	262	0

### Summary

System 1	
Heating Flow:	105
Cooling Flow:	279
System 2	
Heating Flow:	79
Cooling Flow:	249
System 3	
Heating Flow:	92
Cooling Flow:	262



**System 1 - Buhs II Minisplit Apt 1 - Adequate Exposure Diversity Test**

## Test For Adequate Exposure Diversity

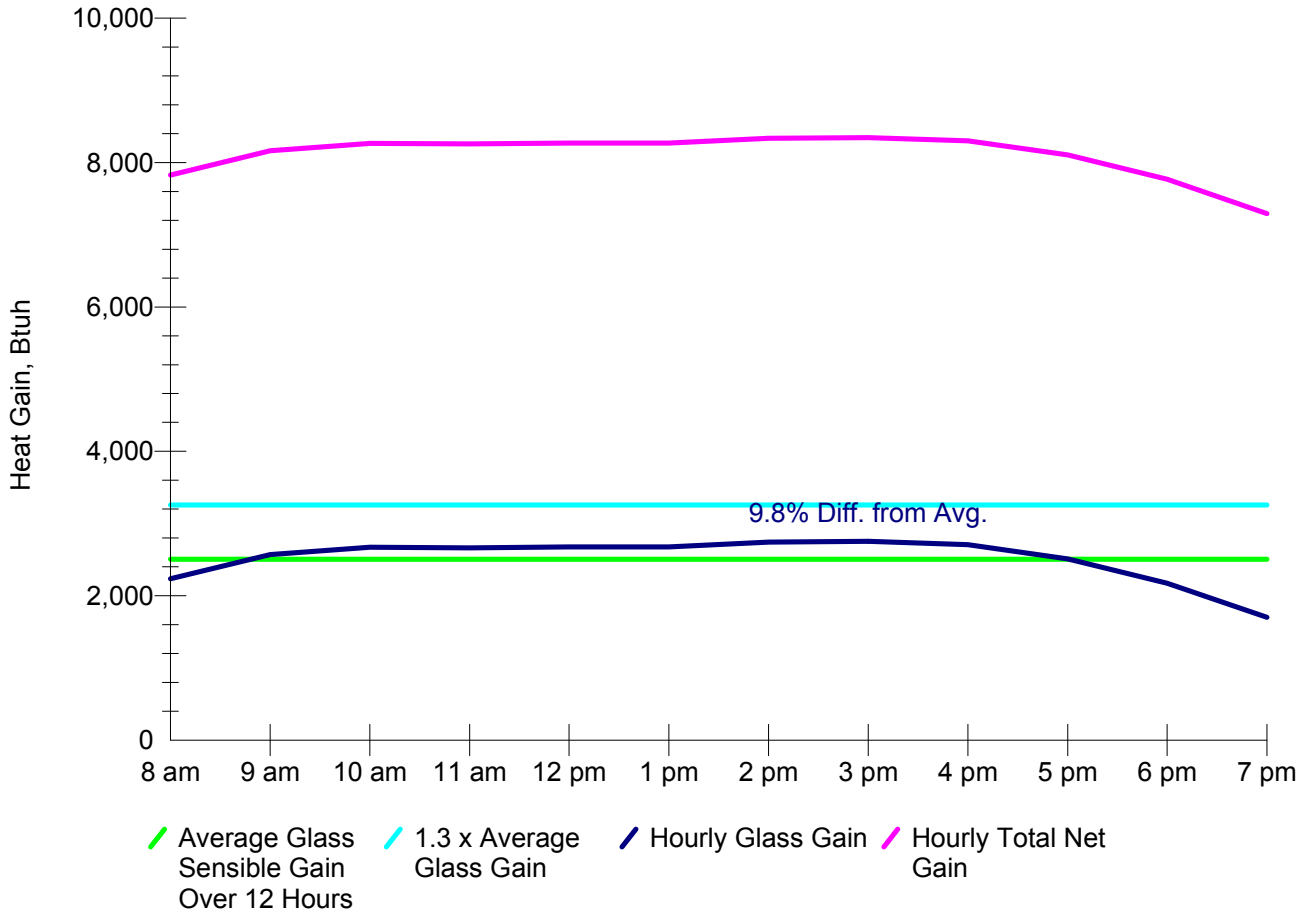

### AED Calculation Summary

--- SYSTEM HAS ADEQUATE EXPOSURE DIVERSITY. ---

System is on NE, SE, SW, NW rosette.

Peak load exceeds 12-hour average load by 9.8%.

AED Excursion (amount by which peak exceeds 1.3 x average): 0 Btuh

Definition: A system has adequate exposure diversity if the peak-hour glass load for the entire conditioned space does not exceed the average glass load for the entire conditioned space by more than 30 percent.



## System 2 - Buhs II Minisplit Apt 2 - Adequate Exposure Diversity Test

### Test For Adequate Exposure Diversity

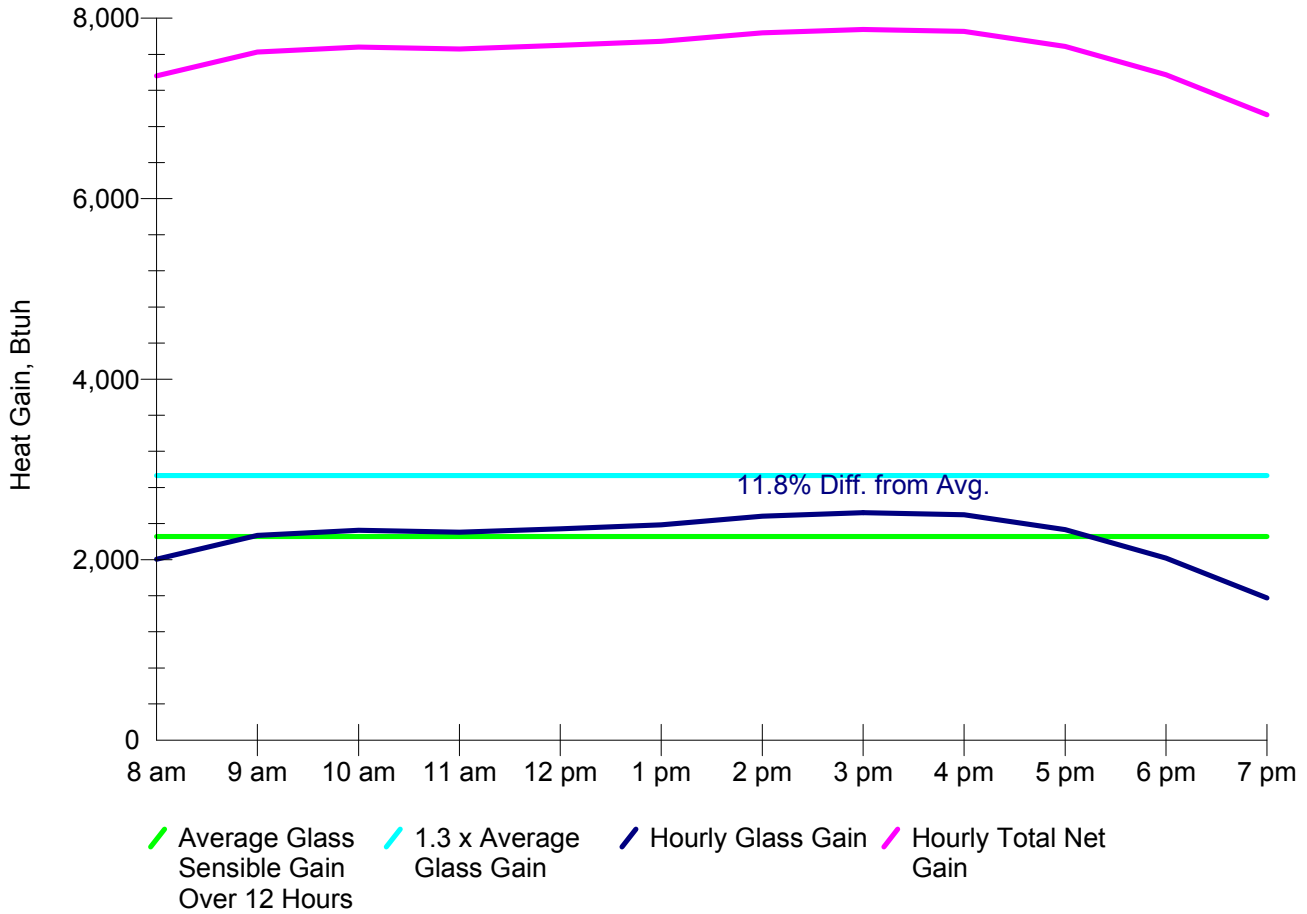

#### AED Calculation Summary

--- SYSTEM HAS ADEQUATE EXPOSURE DIVERSITY. ---

System is on NE, SE, SW, NW rosette.

Peak load exceeds 12-hour average load by 11.8%.

AED Excursion (amount by which peak exceeds 1.3 x average): 0 Btuh

Definition: A system has adequate exposure diversity if the peak-hour glass load for the entire conditioned space does not exceed the average glass load for the entire conditioned space by more than 30 percent.





## System 3 - Buhs II Minisplit Apt 3 - Adequate Exposure Diversity Test

### Test For Adequate Exposure Diversity

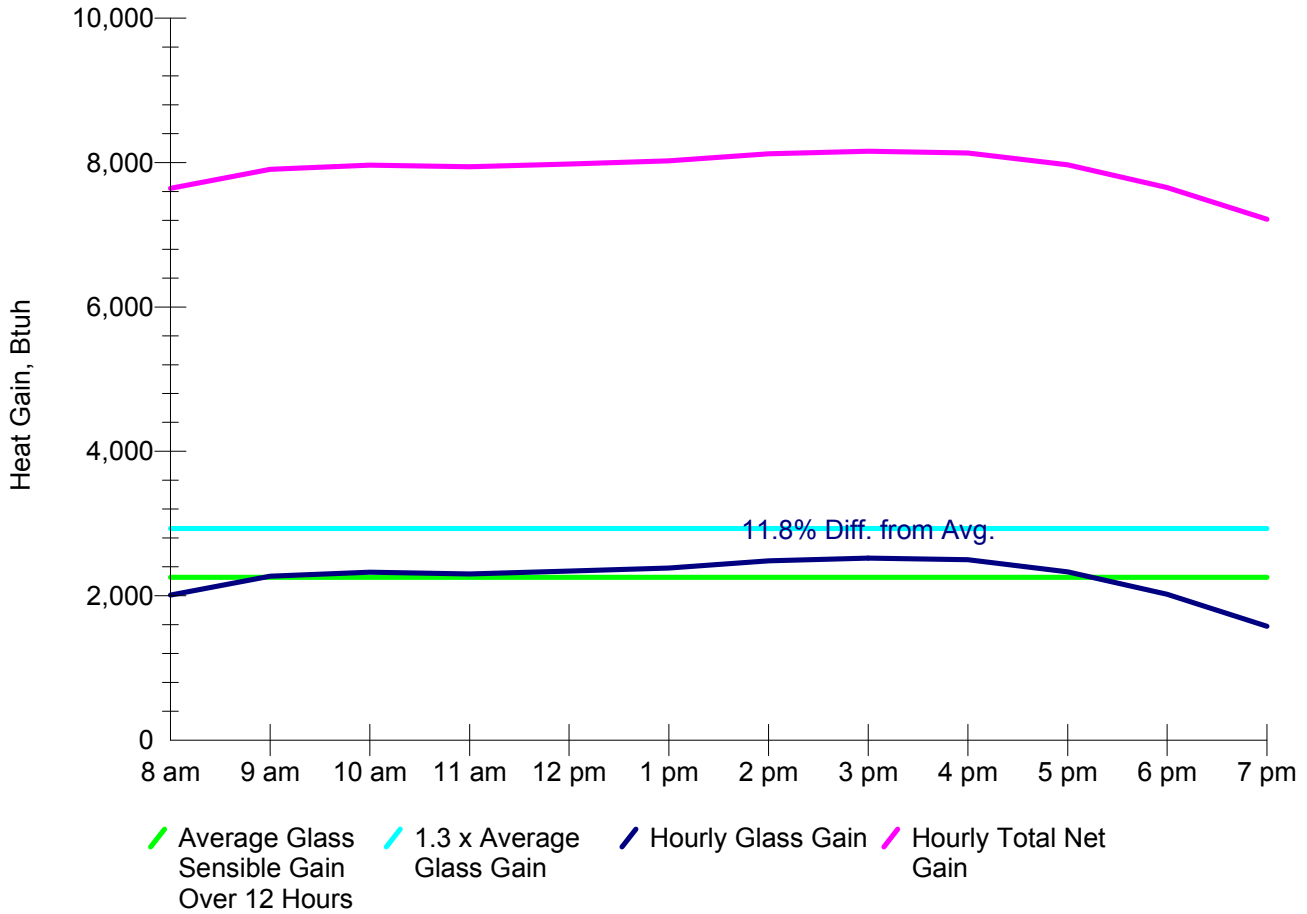

#### AED Calculation Summary

--- SYSTEM HAS ADEQUATE EXPOSURE DIVERSITY. ---

System is on NE, SE, SW, NW rosette.

Peak load exceeds 12-hour average load by 11.8%.

AED Excursion (amount by which peak exceeds 1.3 x average): 0 Btuh

Definition: A system has adequate exposure diversity if the peak-hour glass load for the entire conditioned space does not exceed the average glass load for the entire conditioned space by more than 30 percent.



## Total Building Summary Loads

Component Description	Area Quan	Sen Loss	Lat Gain	Sen Gain	Total Gain
Buhs II glass: Glazing-	357.4	6,041	0	7,013	7,013
basement: Glazing-	17.7	387	0	471	471
R-40: Wall-	1310.7	2,055	0	903	903
Demising: Part-	1121.5	1,594	0	1,197	1,197
15B0-20sf-4: Wall-Basement, , R-20 board insulation to floor, no interior finish, 4' floor depth	440.3	1,038	0	88	88
Buhs II R-48: Roof/Ceiling-	801.3	1,052	0	302	302
21B-32: Floor-Basement, Concrete slab, any thickness, 2 or more feet below grade, R-3 or higher insulation installed below floor, any floor cover, shortest side of floor slab is 32' wide	933.9	819	0	0	0
Subtotals for structure:		12,986	0	9,974	9,974
People:	14		2,800	3,220	6,020
Equipment:			0	4,200	4,200
Lighting:	0			0	0
Ductwork:		0	0	0	0
Infiltration: Winter CFM: 119, Summer CFM: 0		8,214	0	0	0
Ventilation: Winter CFM: 105, Summer CFM: 105		7,226	2,034	1,847	3,881
<b>Total Building Load Totals:</b>		<b>28,426</b>	<b>4,834</b>	<b>19,241</b>	<b>24,075</b>

### Check Figures

Total Building Supply CFM:	791	CFM Per Square ft.:	0.244
Square ft. of Room Area:	3,248	Square ft. Per Ton:	1,519
Volume (ft <sup>3</sup> ) of Cond. Space:	27,156		

### Building Loads

Total Heating Required Including Ventilation Air:	28,426 Btuh	28.426 MBH
Total Sensible Gain:	19,241 Btuh	80 %
Total Latent Gain:	4,834 Btuh	20 %
Total Cooling Required Including Ventilation Air:	24,075 Btuh	2.01 Tons (Based On Sensible + Latent)
		2.14 Tons (Based On 75% Sensible Capacity)

### Notes

Rhvac is an ACCA approved Manual J and Manual D computer program. Calculations are performed per ACCA Manual J 8th Edition, Version 2, and ACCA Manual D. All computed results are estimates as building use and weather may vary. Be sure to select a unit that meets both sensible and latent loads according to the manufacturer's performance data at your design conditions.



### System 1 Buhs II Minisplit Apt 1 Summary Loads

Component Description	Area Quan	Sen Loss	Lat Gain	Sen Gain	Total Gain
Buhs II glass: Glazing-	109.6	1,853	0	2,169	2,169
basement: Glazing-	17.7	387	0	471	471
R-40: Wall-	393.6	617	0	271	271
Demising: Part-	377.2	536	0	403	403
15B0-20sf-4: Wall-Basement, , R-20 board insulation to floor, no interior finish, 4' floor depth	440.3	1,038	0	88	88
Buhs II R-48: Roof/Ceiling-	52.8	69	0	20	20
21B-32: Floor-Basement, Concrete slab, any thickness, 2 or more feet below grade, R-3 or higher insulation installed below floor, any floor cover, shortest side of floor slab is 32' wide	933.9	819	0	0	0
Subtotals for structure:		5,319	0	3,422	3,422
People:	4		800	920	1,720
Equipment:			0	1,800	1,800
Lighting:	0			0	0
Ductwork:		0	0	0	0
Infiltration: Winter CFM: 40, Summer CFM: 0		2,738	0	0	0
Ventilation: Winter CFM: 35, Summer CFM: 35		2,409	678	616	1,294
<b>System 1 Buhs II Minisplit Apt 1 Load Totals:</b>		<b>10,466</b>	<b>1,478</b>	<b>6,758</b>	<b>8,236</b>

#### Check Figures

Supply CFM:	279	CFM Per Square ft.:	0.160
Square ft. of Room Area:	1,750	Square ft. Per Ton:	2,331
Volume (ft <sup>3</sup> ) of Cond. Space:	13,682		

#### System Loads

Total Heating Required Including Ventilation Air:	10,466 Btuh	10.466 MBH
Total Sensible Gain:	6,758 Btuh	82 %
Total Latent Gain:	1,478 Btuh	18 %
Total Cooling Required Including Ventilation Air:	8,236 Btuh	0.69 Tons (Based On Sensible + Latent)
		0.75 Tons (Based On 75% Sensible Capacity)

#### Notes

Rhvac is an ACCA approved Manual J and Manual D computer program. Calculations are performed per ACCA Manual J 8th Edition, Version 2, and ACCA Manual D. All computed results are estimates as building use and weather may vary. Be sure to select a unit that meets both sensible and latent loads according to the manufacturer's performance data at your design conditions.



### System 2 Buhs II Minisplit Apt 2 Summary Loads

Component Description	Area Quan	Sen Loss	Lat Gain	Sen Gain	Total Gain
Buhs II glass: Glazing-	123.9	2,094	0	2,422	2,422
R-40: Wall-	458.5	719	0	316	316
Demising: Part-	372.1	529	0	397	397
Subtotals for structure:		3,342	0	3,135	3,135
People:	5		1,000	1,150	2,150
Equipment:			0	1,200	1,200
Lighting:	0			0	0
Ductwork:		0	0	0	0
Infiltration: Winter CFM: 40, Summer CFM: 0		2,738	0	0	0
Ventilation: Winter CFM: 35, Summer CFM: 35		2,409	678	616	1,294
<b>System 2 Buhs II Minisplit Apt 2 Load Totals:</b>		<b>8,489</b>	<b>1,678</b>	<b>6,101</b>	<b>7,779</b>

#### Check Figures

Supply CFM:	249	CFM Per Square ft.:	0.333
Square ft. of Room Area:	749	Square ft. Per Ton:	1,105
Volume (ft <sup>3</sup> ) of Cond. Space:	6,737		

#### System Loads

Total Heating Required Including Ventilation Air:	8,489 Btuh	8.489 MBH
Total Sensible Gain:	6,101 Btuh	78 %
Total Latent Gain:	1,678 Btuh	22 %
Total Cooling Required Including Ventilation Air:	7,779 Btuh	0.65 Tons (Based On Sensible + Latent)
		0.68 Tons (Based On 75% Sensible Capacity)

#### Notes

Rhvac is an ACCA approved Manual J and Manual D computer program.  
 Calculations are performed per ACCA Manual J 8th Edition, Version 2, and ACCA Manual D.  
 All computed results are estimates as building use and weather may vary.  
 Be sure to select a unit that meets both sensible and latent loads according to the manufacturer's performance data at your design conditions.



### System 3 Buhs II Minisplit Apt 3 Summary Loads

Component Description	Area Quan	Sen Loss	Lat Gain	Sen Gain	Total Gain
Buhs II glass: Glazing-	123.9	2,094	0	2,422	2,422
R-40: Wall-	458.5	719	0	316	316
Demising: Part-	372.1	529	0	397	397
Buhs II R-48: Roof/Ceiling-	748.5	983	0	282	282
Subtotals for structure:		4,325	0	3,417	3,417
People:	5		1,000	1,150	2,150
Equipment:			0	1,200	1,200
Lighting:	0			0	0
Ductwork:		0	0	0	0
Infiltration: Winter CFM: 40, Summer CFM: 0		2,738	0	0	0
Ventilation: Winter CFM: 35, Summer CFM: 35		2,409	678	616	1,294
<b>System 3 Buhs II Minisplit Apt 3 Load Totals:</b>		<b>9,472</b>	<b>1,678</b>	<b>6,383</b>	<b>8,061</b>

#### Check Figures

Supply CFM:	262	CFM Per Square ft.:	0.350
Square ft. of Room Area:	749	Square ft. Per Ton:	1,056
Volume (ft <sup>3</sup> ) of Cond. Space:	6,737		

#### System Loads

Total Heating Required Including Ventilation Air:	9,472 Btuh	9.472 MBH
Total Sensible Gain:	6,383 Btuh	79 %
Total Latent Gain:	1,678 Btuh	21 %
Total Cooling Required Including Ventilation Air:	8,061 Btuh	0.67 Tons (Based On Sensible + Latent)
		0.71 Tons (Based On 75% Sensible Capacity)

#### Notes

Rhvac is an ACCA approved Manual J and Manual D computer program.  
 Calculations are performed per ACCA Manual J 8th Edition, Version 2, and ACCA Manual D.  
 All computed results are estimates as building use and weather may vary.  
 Be sure to select a unit that meets both sensible and latent loads according to the manufacturer's performance data at your design conditions.



### System 1, Zone 1 Summary Loads (Peak Load Procedure for Rooms)

Component Description	Area Quan	Sen Loss	Lat Gain	Sen Gain	Total Gain
Buhs II glass: Glazing-	109.6	1,853	0	2,169	2,169
R-40: Wall-	393.6	617	0	271	271
Demising: Part-	305.1	434	0	325	325
Subtotals for structure:		2,904	0	2,920	2,920
People:	4		800	920	1,720
Equipment:			0	1,200	1,200
Lighting:	0			0	0
Ductwork:		0	0	0	0
Infiltration: Winter CFM: 29, Summer CFM: 0		1,994	0	0	0
System 1, Zone 1 Load Totals:		4,898	800	5,040	5,840

#### Check Figures

Supply CFM:	229	CFM Per Square ft.:	0.349
Square ft. of Room Area:	657	Square ft. Per Ton:	1,250
Volume (ft <sup>3</sup> ) of Cond. Space:	5,906		

#### Zone Loads

Total Heating Required:	4,898 Btuh	4.898 MBH
Total Sensible Gain:	5,040 Btuh	86 %
Total Latent Gain:	800 Btuh	14 %
Total Cooling Required:	5,840 Btuh	0.49 Tons (Based On Sensible + Latent)
		0.53 Tons (Based On 75% Sensible Capacity)

#### Notes

Rhvac is an ACCA approved Manual J and Manual D computer program.  
 Calculations are performed per ACCA Manual J 8th Edition, Version 2, and ACCA Manual D.  
 All computed results are estimates as building use and weather may vary.  
 Be sure to select a unit that meets both sensible and latent loads according to the manufacturer's performance data at your design conditions.



### System 1, Zone 2 Summary Loads (Peak Load Procedure for Rooms)

Component Description	Area Quan	Sen Loss	Lat Gain	Sen Gain	Total Gain
basement: Glazing-	17.7	387	0	471	471
15B0-20sf-4: Wall-Basement, , R-20 board insulation to floor, no interior finish, 4' floor depth	440.3	1,038	0	88	88
21B-32: Floor-Basement, Concrete slab, any thickness, 2 or more feet below grade, R-3 or higher insulation installed below floor, any floor cover, shortest side of floor slab is 32' wide	933.9	819	0	0	0
Subtotals for structure:		2,244	0	682	682
People:	0		0	0	0
Equipment:			0	600	600
Lighting:	0			0	0
Ductwork:		0	0	0	0
Infiltration: Winter CFM: 11, Summer CFM: 0		744	0	0	0
System 1, Zone 2 Load Totals:		2,988	0	1,282	1,282

#### Check Figures

Supply CFM:	58	CFM Per Square ft.:	0.062
Square ft. of Room Area:	934	Square ft. Per Ton:	8,743
Volume (ft <sup>3</sup> ) of Cond. Space:	6,351		

#### Zone Loads

Total Heating Required:	2,988 Btuh	2.988 MBH
Total Sensible Gain:	1,282 Btuh	100 %
Total Latent Gain:	0 Btuh	0 %
Total Cooling Required:	1,282 Btuh	0.11 Tons (Based On Sensible + Latent)
		0.11 Tons (Based On 75% Sensible Capacity)

#### Notes

Rhvac is an ACCA approved Manual J and Manual D computer program.  
 Calculations are performed per ACCA Manual J 8th Edition, Version 2, and ACCA Manual D.  
 All computed results are estimates as building use and weather may vary.  
 Be sure to select a unit that meets both sensible and latent loads according to the manufacturer's performance data at your design conditions.



### System 1, Zone 3 Summary Loads (Peak Load Procedure for Rooms)

Component Description	Area Quan	Sen Loss	Lat Gain	Sen Gain	Total Gain
Demising: Part-	72.1	102	0	78	78
Buhs II R-48: Roof/Ceiling-	52.8	69	0	20	20
Subtotals for structure:		171	0	98	98
People:	0		0	0	0
Equipment:			0	0	0
Lighting:	0			0	0
Ductwork:		0	0	0	0
Infiltration: Winter CFM: 0, Summer CFM: 0		0	0	0	0
System 1, Zone 3 Load Totals:		171	0	98	98

#### Check Figures

Supply CFM:	4	CFM Per Square ft.:	0.028
Square ft. of Room Area:	159	Square ft. Per Ton:	19,469
Volume (ft³) of Cond. Space:	1,425		

#### Zone Loads

Total Heating Required:	171 Btuh	0.171 MBH
Total Sensible Gain:	98 Btuh	100 %
Total Latent Gain:	0 Btuh	0 %
Total Cooling Required:	98 Btuh	0.01 Tons (Based On Sensible + Latent)
		0.01 Tons (Based On 75% Sensible Capacity)

#### Notes

Rhvac is an ACCA approved Manual J and Manual D computer program.  
 Calculations are performed per ACCA Manual J 8th Edition, Version 2, and ACCA Manual D.  
 All computed results are estimates as building use and weather may vary.  
 Be sure to select a unit that meets both sensible and latent loads according to the manufacturer's performance data at your design conditions.





**System 2, Zone 1 Summary Loads (Average Load Procedure for Rooms)**

Component Description	Area Quan	Sen Loss	Lat Gain	Sen Gain	Total Gain
Buhs II glass: Glazing-	123.9	2,094	0	2,422	2,422
R-40: Wall-	458.5	719	0	316	316
Demising: Part-	372.1	529	0	397	397
Subtotals for structure:		3,342	0	3,135	3,135
People:	5		1,000	1,150	2,150
Equipment:			0	1,200	1,200
Lighting:	0			0	0
Ductwork:		0	0	0	0
Infiltration: Winter CFM: 40, Summer CFM: 0		2,738	0	0	0
System 2, Zone 1 Load Totals:		6,080	1,000	5,485	6,485

**Check Figures**

Supply CFM:	249	CFM Per Square ft.:	0.333
Square ft. of Room Area:	749	Square ft. Per Ton:	1,342
Volume (ft <sup>3</sup> ) of Cond. Space:	6,737		

**Zone Loads**

Total Heating Required:	6,080 Btuh	6.080 MBH
Total Sensible Gain:	5,485 Btuh	85 %
Total Latent Gain:	1,000 Btuh	15 %
Total Cooling Required:	6,485 Btuh	0.54 Tons (Based On Sensible + Latent)
		0.56 Tons (Based On 75% Sensible Capacity)

**Notes**

Rhvac is an ACCA approved Manual J and Manual D computer program.  
 Calculations are performed per ACCA Manual J 8th Edition, Version 2, and ACCA Manual D.  
 All computed results are estimates as building use and weather may vary.  
 Be sure to select a unit that meets both sensible and latent loads according to the manufacturer's performance data at your design conditions.



### System 3, Zone 1 Summary Loads (Average Load Procedure for Rooms)

Component Description	Area Quan	Sen Loss	Lat Gain	Sen Gain	Total Gain
Buhs II glass: Glazing-	123.9	2,094	0	2,422	2,422
R-40: Wall-	458.5	719	0	316	316
Demising: Part-	372.1	529	0	397	397
Buhs II R-48: Roof/Ceiling-	748.5	983	0	282	282
Subtotals for structure:		4,325	0	3,417	3,417
People:	5		1,000	1,150	2,150
Equipment:			0	1,200	1,200
Lighting:	0			0	0
Ductwork:		0	0	0	0
Infiltration: Winter CFM: 40, Summer CFM: 0		2,738	0	0	0
System 3, Zone 1 Load Totals:		7,063	1,000	5,767	6,767

#### Check Figures

Supply CFM:	262	CFM Per Square ft.:	0.350
Square ft. of Room Area:	749	Square ft. Per Ton:	1,278
Volume (ft <sup>3</sup> ) of Cond. Space:	6,737		

#### Zone Loads

Total Heating Required:	7,063 Btuh	7.063 MBH
Total Sensible Gain:	5,767 Btuh	85 %
Total Latent Gain:	1,000 Btuh	15 %
Total Cooling Required:	6,767 Btuh	0.56 Tons (Based On Sensible + Latent)
		0.59 Tons (Based On 75% Sensible Capacity)

#### Notes

Rhvac is an ACCA approved Manual J and Manual D computer program.  
 Calculations are performed per ACCA Manual J 8th Edition, Version 2, and ACCA Manual D.  
 All computed results are estimates as building use and weather may vary.  
 Be sure to select a unit that meets both sensible and latent loads according to the manufacturer's performance data at your design conditions.



### System 1, Zone 1 Pie Chart

System  
1, Zone  
1  
Loss  
4,898  
Btuh

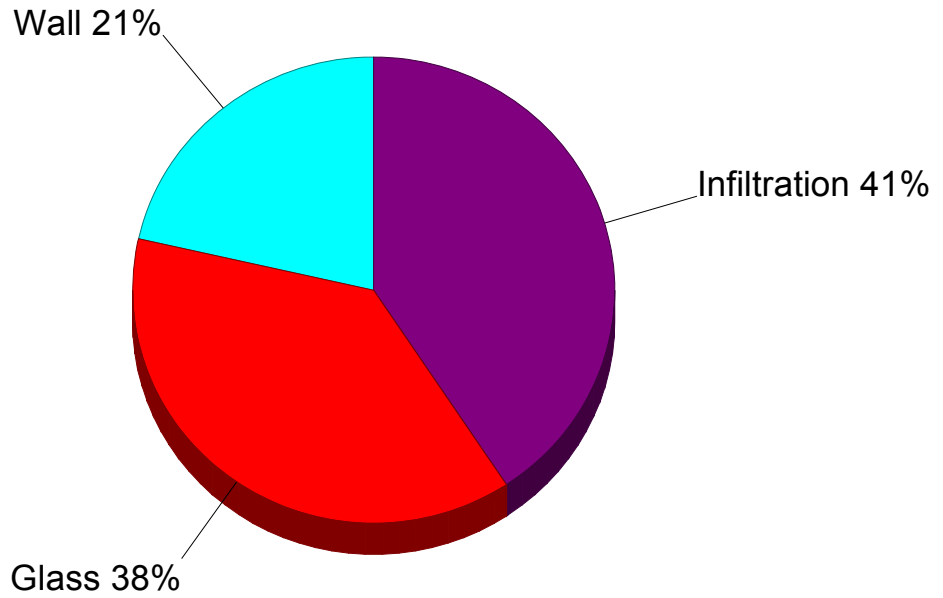

System  
1, Zone  
1  
Gain  
5,840  
Btuh

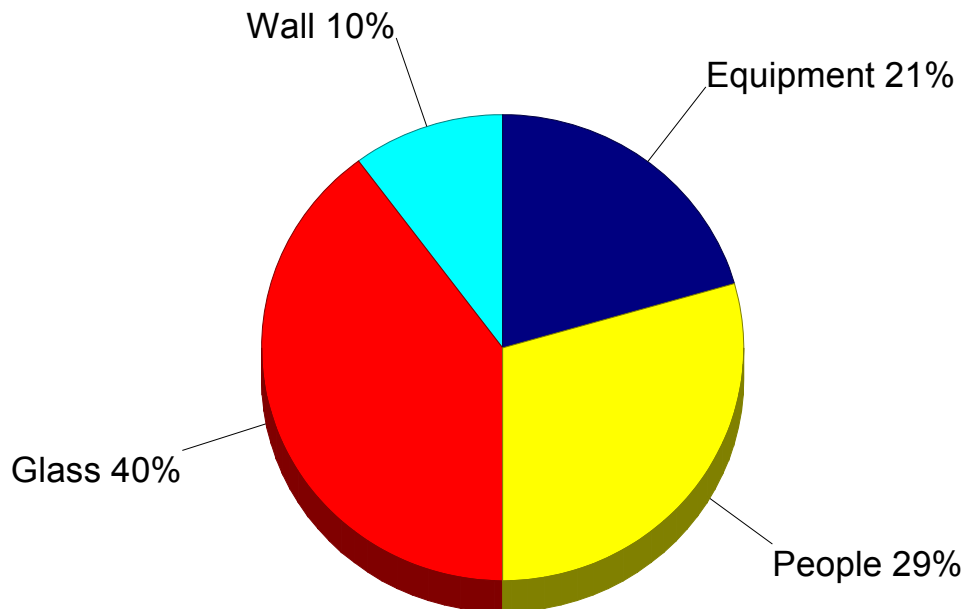



### System 1, Zone 2 Pie Chart

System  
1, Zone  
2  
Loss  
2,988  
Btuh

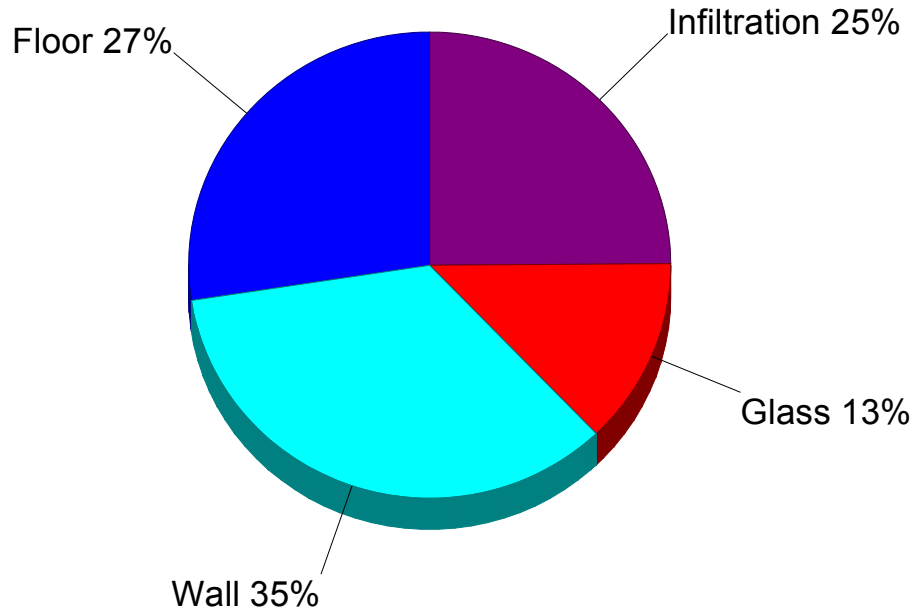

System  
1, Zone  
2  
Gain  
1,282  
Btuh

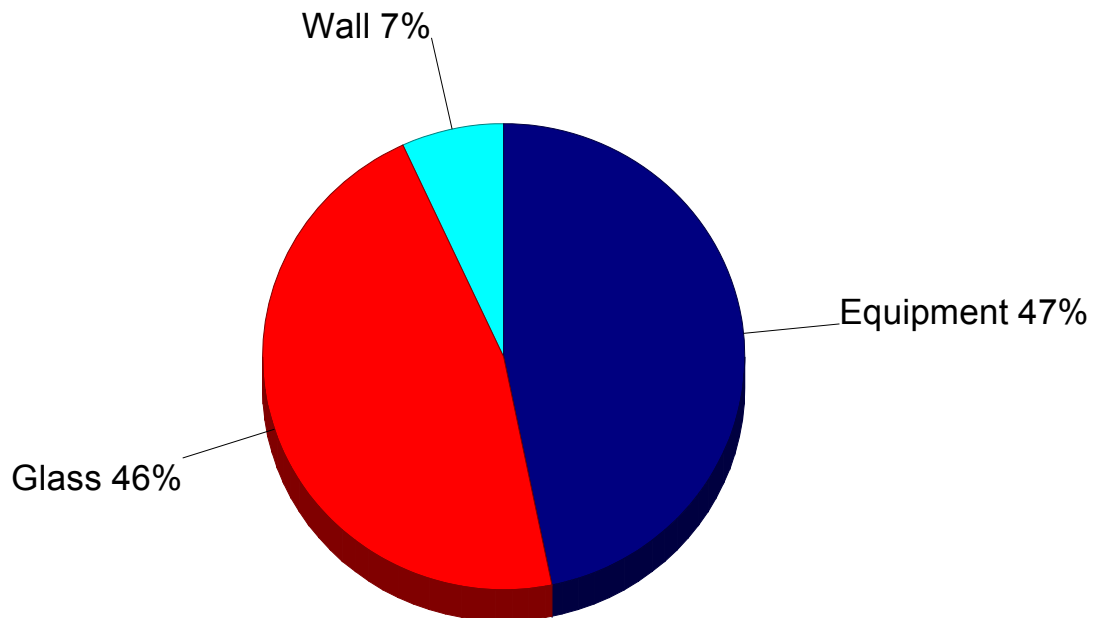



### System 1, Zone 3 Pie Chart

System  
1, Zone  
3  
Loss  
171  
Btuh

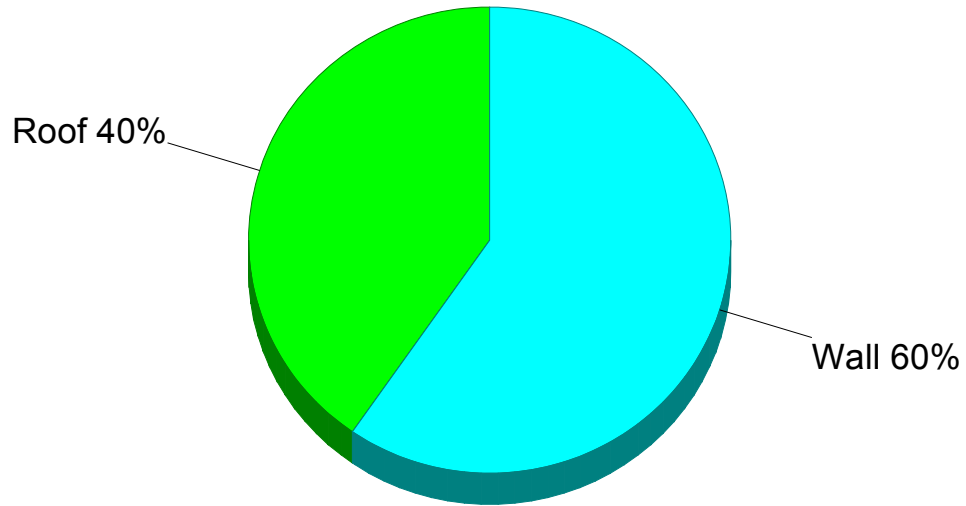

System  
1, Zone  
3  
Gain  
98  
Btuh

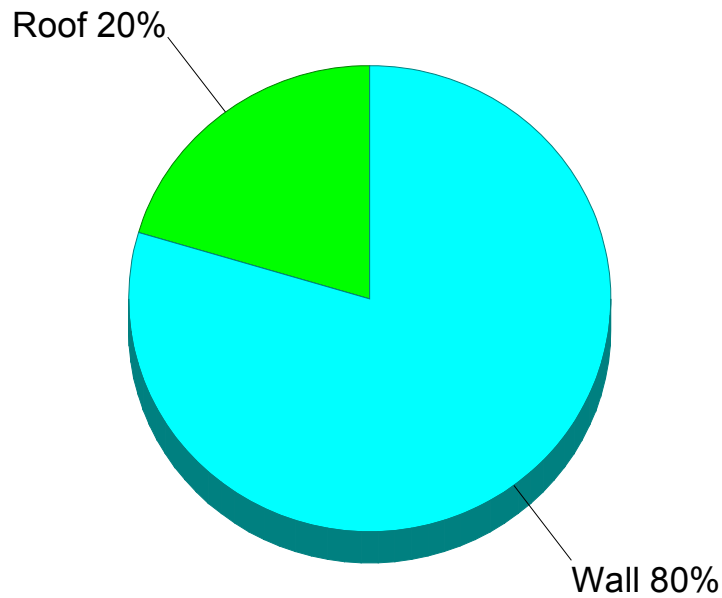



### System 2, Zone 1 Pie Chart

System  
2, Zone  
1  
Loss  
6,080  
Btuh

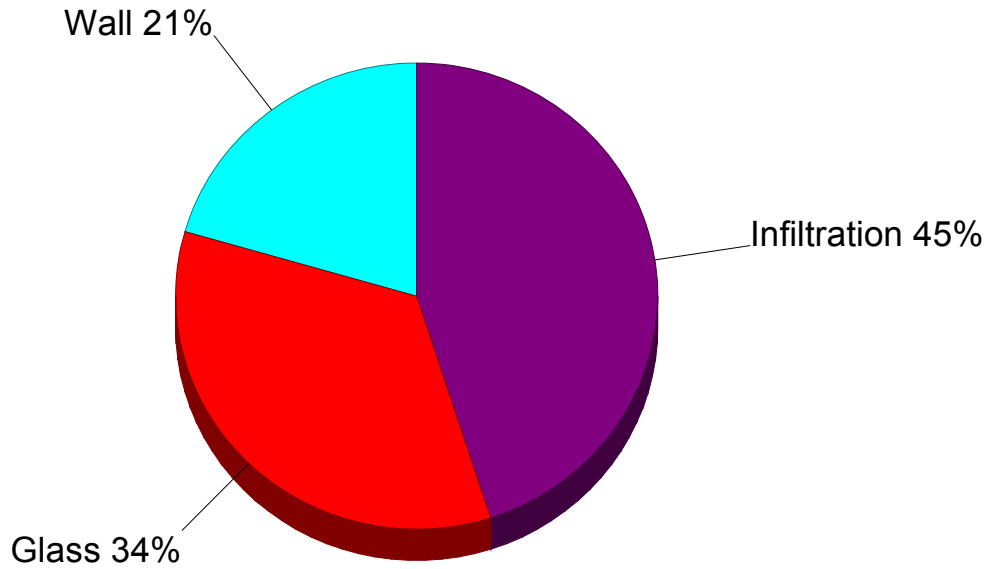

System  
2, Zone  
1  
Gain  
6,485  
Btuh

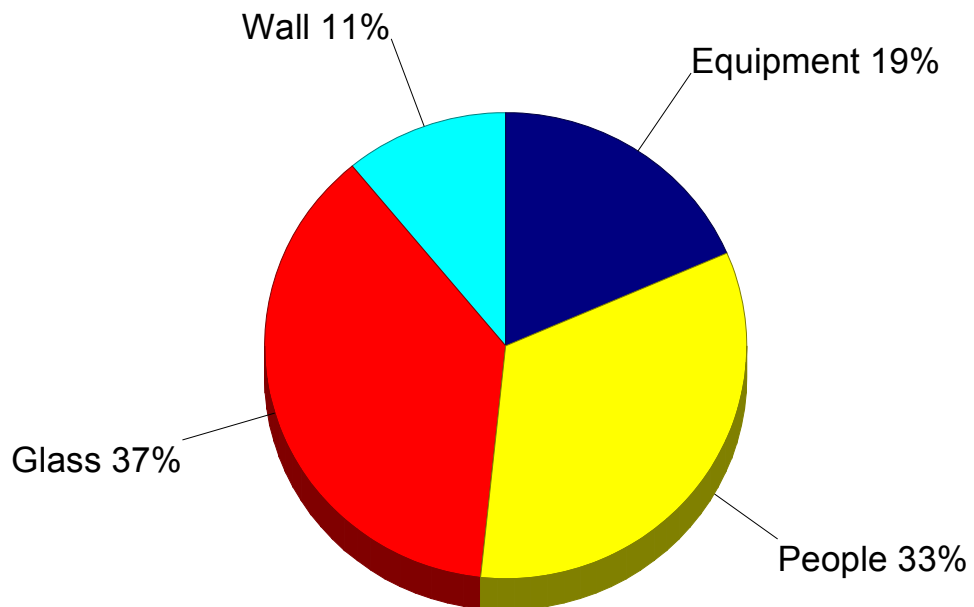



### System 3, Zone 1 Pie Chart

System  
3, Zone  
1  
Loss  
7,063  
Btuh

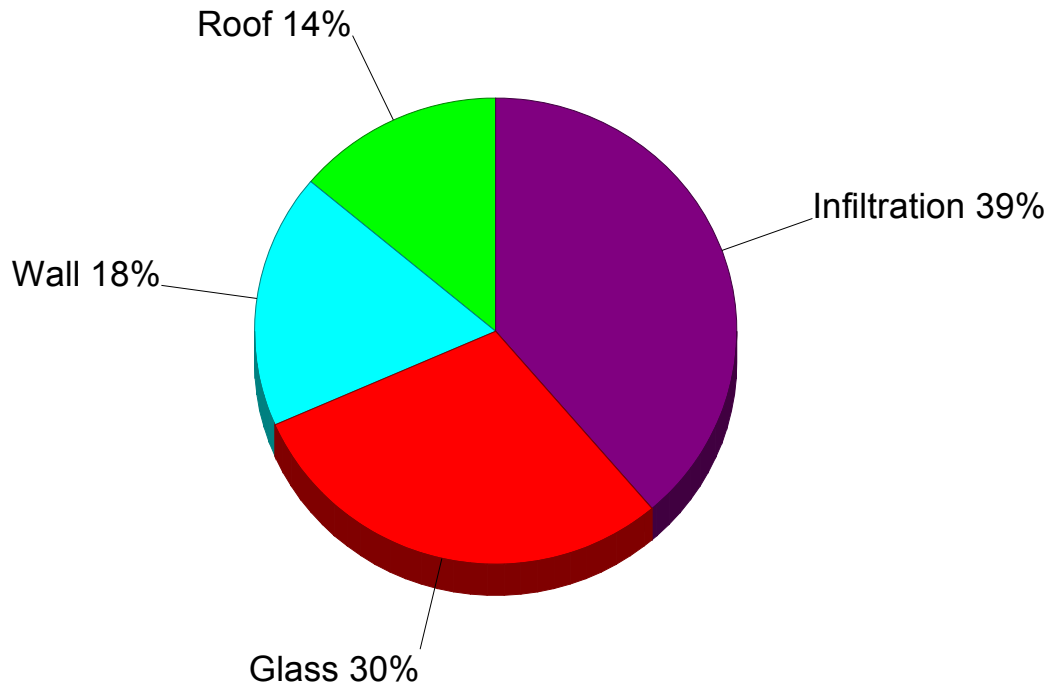

System  
3, Zone  
1  
Gain  
6,767  
Btuh

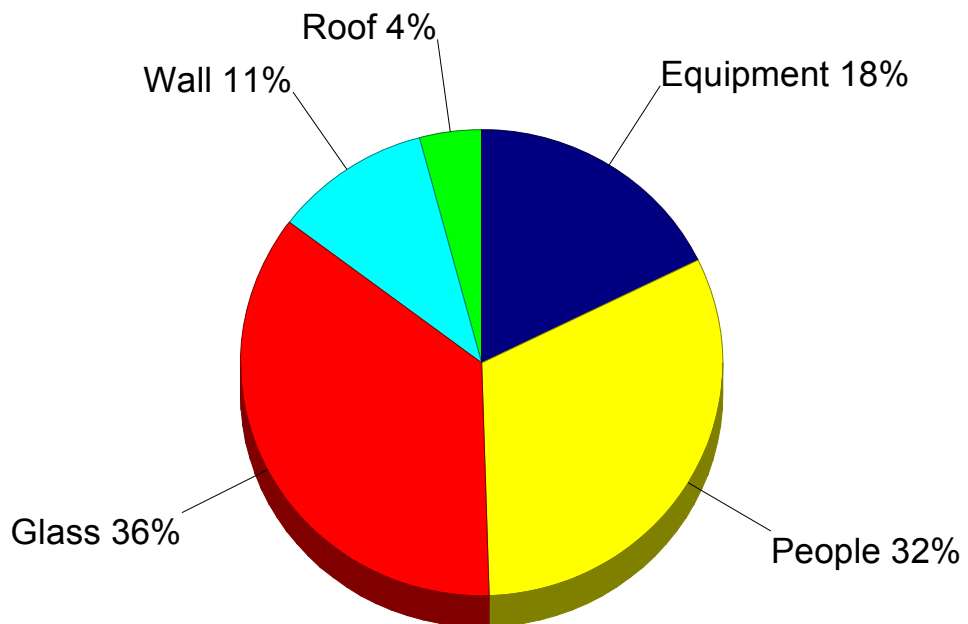



**Detailed Room Loads - Room 3 - 1st\_Floor\_Bed\_1 (Peak Fenestration Gain Procedure)**

**General**

Room is in zone 1, which peaks at 3 pm

Calculation Mode:	Htg. & clg.	Occurrences:	1
Room Length:	15.9 ft.	System Number:	1
Room Width:	10.8 ft.	Zone Number:	1
Area:	171.0 sq.ft.	Supply Air:	55 CFM
Ceiling Height:	9.0 ft.	Supply Air Changes:	2.1 AC/hr
Volume:	1,535.0 cu.ft.	Req. Vent. Clg:	0 CFM
Number of Registers:	1	Actual Winter Vent.:	4 CFM
Runout Air:	55 CFM	Percent of Supply.:	8 %
Runout Duct Size:	4 in.	Actual Summer Vent.:	7 CFM
Runout Air Velocity:	627 ft./min.	Percent of Supply:	12 %
Runout Air Velocity:	627 ft./min.	Actual Winter Infil.:	6 CFM
Actual Loss:	0.443 in.wg./100 ft.	Actual Summer Infil.:	0 CFM

Item Description	Area Quantity	-U- Value	Htg HTM	Sen Loss	Clg HTM	Lat Gain	Sen Gain
SW-Wall-R-40 10.8 X 9	82.5	0.025	1.6	129	0.7	0	57
N -Part-15°/20°-Demising 20.4 X 9	183.6	0.071	1.4	261	1.1	0	196
SW-Gls-Buhs II glass shgc-0.22 0%S	14.2	0.270	16.9	241	34.5	0	491
Subtotals for Structure:				631		0	744
Infil.: Win.: 5.6, Sum.: 0.0	97		3.959	383	0.000	0	0
People: 200 lat/per, 230 sen/per:	2					400	460
Room Totals:				1,014		400	1,204





**Detailed Room Loads - Room 4 - 1st\_Floor\_Kitchen (Peak Fenestration Gain Procedure)**

**General**

Room is in zone 1, which peaks at 3 pm

Calculation Mode:	Htg. & clg.	Occurrences:	1
Room Length:	13.3 ft.	System Number:	1
Room Width:	10.9 ft.	Zone Number:	1
Area:	146.0 sq.ft.	Supply Air:	91 CFM
Ceiling Height:	9.0 ft.	Supply Air Changes:	4.2 AC/hr
Volume:	1,310.0 cu.ft.	Req. Vent. Clg:	0 CFM
Number of Registers:	1	Actual Winter Vent.:	7 CFM
Runout Air:	91 CFM	Percent of Supply.:	7 %
Runout Duct Size:	6 in.	Actual Summer Vent.:	11 CFM
Runout Air Velocity:	466 ft./min.	Percent of Supply:	12 %
Runout Air Velocity:	466 ft./min.	Actual Winter Infil.:	13 CFM
Actual Loss:	0.139 in.wg./100 ft.	Actual Summer Infil.:	0 CFM

Item Description	Area Quantity	-U- Value	Htg HTM	Sen Loss	Clg HTM	Lat Gain	Sen Gain
SW-Wall-R-40 10.9 X 9	84	0.025	1.6	132	0.7	0	58
SE-Wall-R-40 13.3 X 9	112	0.025	1.6	175	0.7	0	77
SW-Gls-Buhs II glass shgc-0.22 0%S	14.2	0.270	16.9	241	34.5	0	491
SE-Gls-Buhs II glass shgc-0.22 0%S	8	0.270	16.9	135	23.0	0	184
Subtotals for Structure:				683		0	810
Infil.: Win.: 12.6, Sum.: 0.0	218		3.963	865	0.000	0	0
Equipment:						0	1,200
Room Totals:				1,548		0	2,010



**Detailed Room Loads - Room 5 - 1st\_Floor\_Dining\_Room (Peak Fenestration Gain Procedure)**

**General**

Room is in zone 1, which peaks at 3 pm

Calculation Mode:	Htg. & clg.	Occurrences:	1
Room Length:	10.0 ft.	System Number:	1
Room Width:	14.4 ft.	Zone Number:	1
Area:	143.0 sq.ft.	Supply Air:	12 CFM
Ceiling Height:	9.0 ft.	Supply Air Changes:	0.6 AC/hr
Volume:	1,286.0 cu.ft.	Req. Vent. Clg:	0 CFM
Number of Registers:	1	Actual Winter Vent.:	1 CFM
Runout Air:	12 CFM	Percent of Supply.:	11 %
Runout Duct Size:	4 in.	Actual Summer Vent.:	1 CFM
Runout Air Velocity:	139 ft./min.	Percent of Supply:	12 %
Runout Air Velocity:	139 ft./min.	Actual Winter Infil.:	1 CFM
Actual Loss:	0.023 in.wg./100 ft.	Actual Summer Infil.:	0 CFM

Item Description	Area Quantity	-U- Value	Htg HTM	Sen Loss	Clg HTM	Lat Gain	Sen Gain
SE-Wall-R-40 1.8 X 9	7.4	0.025	1.6	12	0.7	0	5
N -Part-15°/20°-Demising 7.2 X 9	64.8	0.071	1.4	92	1.1	0	69
SE-Gls-Buhs II glass shgc-0.22 0%S	8.3	0.270	16.9	141	23.0	0	192
Subtotals for Structure:				245		0	266
Infil.: Win.: 0.9, Sum.: 0.0	16		3.937	62	0.000	0	0
Room Totals:				307		0	266



## Detailed Room Loads - Room 6 - 1st\_Floor\_Living (Peak Fenestration Gain Procedure)

### General

Room is in zone 1, which peaks at 3 pm

Calculation Mode:	Htg. & clg.	Occurrences:	1
Room Length:	13.9 ft.	System Number:	1
Room Width:	12.0 ft.	Zone Number:	1
Area:	167.0 sq.ft.	Supply Air:	61 CFM
Ceiling Height:	9.0 ft.	Supply Air Changes:	2.5 AC/hr
Volume:	1,501.0 cu.ft.	Req. Vent. Clg:	0 CFM
Number of Registers:	1	Actual Winter Vent.:	7 CFM
Runout Air:	61 CFM	Percent of Supply.:	12 %
Runout Duct Size:	4 in.	Actual Summer Vent.:	7 CFM
Runout Air Velocity:	703 ft./min.	Percent of Supply:	12 %
Runout Air Velocity:	703 ft./min.	Actual Winter Infil.:	7 CFM
Actual Loss:	0.554 in.wg./100 ft.	Actual Summer Infil.:	0 CFM

Item Description	Area Quantity	-U- Value	Htg HTM	Sen Loss	Clg HTM	Lat Gain	Sen Gain
NE-Wall-R-40 13.8 X 9	66.9	0.025	1.6	105	0.7	0	46
N -Part-15°/20°-Demising 6.3 X 9	56.7	0.071	1.4	81	1.1	0	60
NE-Gls-Buhs II glass shgc-0.22 0%S (2)	56.8	0.270	16.9	960	13.8	0	782
Subtotals for Structure:				1,146		0	888
Infil.: Win.: 7.1, Sum.: 0.0	124		3.968	491	0.000	0	0
People: 200 lat/per, 230 sen/per:	2					400	460
Room Totals:				1,637		400	1,348



**Detailed Room Loads - Room 7 - 1st\_Floor\_Bathroom (Peak Fenestration Gain Procedure)**

**General**

Room is in zone 1, which peaks at 3 pm

Calculation Mode:	Htg. & clg.	Occurrences:	1
Room Length:	5.6 ft.	System Number:	1
Room Width:	5.4 ft.	Zone Number:	1
Area:	30.0 sq.ft.	Supply Air:	10 CFM
Ceiling Height:	9.0 ft.	Supply Air Changes:	2.1 AC/hr
Volume:	274.0 cu.ft.	Req. Vent. Clg:	0 CFM
Number of Registers:	1	Actual Winter Vent.:	2 CFM
Runout Air:	10 CFM	Percent of Supply.:	18 %
Runout Duct Size:	4 in.	Actual Summer Vent.:	1 CFM
Runout Air Velocity:	110 ft./min.	Percent of Supply:	12 %
Runout Air Velocity:	110 ft./min.	Actual Winter Infil.:	3 CFM
Actual Loss:	0.015 in.wg./100 ft.	Actual Summer Infil.:	0 CFM

Item Description	Area Quantity	-U- Value	Htg HTM	Sen Loss	Clg HTM	Lat Gain	Sen Gain
SE-Wall-R-40 5.4 X 9	40.8	0.025	1.6	64	0.7	0	28
SE-Gls-Buhs II glass shgc-0.22 0%S	8	0.270	16.9	135	23.0	0	184
Subtotals for Structure:				199		0	212
Infil.: Win.: 2.8, Sum.: 0.0	49		3.957	193	0.000	0	0
Room Totals:				392		0	212



**Detailed Room Loads - Room 1 - Basement (Peak Fenestration Gain Procedure)**

**General**

Room is in zone 2, which peaks at 10 am

Calculation Mode:	Htg. & clg.	Occurrences:	1
Room Length:	42.3 ft.	System Number:	1
Room Width:	22.1 ft.	Zone Number:	2
Area:	934.0 sq.ft.	Supply Air:	58 CFM
Ceiling Height:	6.8 ft.	Supply Air Changes:	0.6 AC/hr
Volume:	6,351.0 cu.ft.	Req. Vent. Clg:	0 CFM
Number of Registers:	1	Actual Winter Vent.:	13 CFM
Runout Air:	58 CFM	Percent of Supply.:	22 %
Runout Duct Size:	4 in.	Actual Summer Vent.:	7 CFM
Runout Air Velocity:	668 ft./min.	Percent of Supply:	12 %
Runout Air Velocity:	668 ft./min.	Actual Winter Infil.:	11 CFM
Actual Loss:	0.501 in.wg./100 ft.	Actual Summer Infil.:	0 CFM

Item Description	Area Quantity	-U- Value	Htg HTM	Sen Loss	Clg HTM	Lat Gain	Sen Gain
SW-Wall-15B0-20sf-4 22.1 X 6.8	150.3	0.033	2.4	357	0.2	0	32
NE-Wall-15B0-20sf-4 23 X 6.8	146.7	0.033	2.3	344	0.2	0	28
SE-Wall-15B0-20sf-4 22.2 X 6.8	143.3	0.033	2.3	337	0.2	0	28
NE-Gls-basement shgc-0.3 0%S (2)	9.7	0.350	21.9	212	23.7	0	230
SE-Gls-basement shgc-0.3 0%S	8	0.350	21.9	175	45.5	0	364
Floor-21B-32 22.1 X 42.3	933.9	0.014	0.9	819	0.0	0	0
Subtotals for Structure:				2,244		0	682
Infil.: Win.: 10.8, Sum.: 0.0	188		3.962	744	0.000	0	0
Equipment:						0	600
Room Totals:				2,988		0	1,282



**Detailed Room Loads - Room 2 - 1st\_floor\_hall (Peak Fenestration Gain Procedure)**

**General**

Room is in zone 3, which peaks at 7 pm

Calculation Mode:	Htg. & clg.	Occurrences:	1
Room Length:	8.1 ft.	System Number:	1
Room Width:	6.5 ft.	Zone Number:	3
Area:	53.0 sq.ft.	Supply Air:	1 CFM
Ceiling Height:	9.0 ft.	Supply Air Changes:	0.1 AC/hr
Volume:	475.0 cu.ft.	Req. Vent. Clg:	0 CFM
Number of Registers:	1	Actual Winter Vent.:	0 CFM
Runout Air:	1 CFM	Percent of Supply.:	12 %
Runout Duct Size:	4 in.	Actual Summer Vent.:	0 CFM
Runout Air Velocity:	14 ft./min.	Percent of Supply:	12 %
Runout Air Velocity:	14 ft./min.	Actual Winter Infil.:	0 CFM
Actual Loss:	0.000 in.wg./100 ft.	Actual Summer Infil.:	0 CFM

Item Description	Area Quantity	-U- Value	Htg HTM	Sen Loss	Clg HTM	Lat Gain	Sen Gain
N -Part-15°/20°-Demising 2.7 X 9	24	0.071	1.4	34	1.1	0	26
Subtotals for Structure:				34		0	26
Infil.: Win.: 0.0, Sum.: 0.0	0		0	0	0	0	0
Room Totals:				34		0	26



## Detailed Room Loads - Room 8 - 2nd\_floor\_hall (Peak Fenestration Gain Procedure)

### General

Room is in zone 3, which peaks at 7 pm

Calculation Mode:	Htg. & clg.	Occurrences:	1
Room Length:	8.1 ft.	System Number:	1
Room Width:	6.5 ft.	Zone Number:	3
Area:	53.0 sq.ft.	Supply Air:	1 CFM
Ceiling Height:	9.0 ft.	Supply Air Changes:	0.1 AC/hr
Volume:	475.0 cu.ft.	Req. Vent. Clg:	0 CFM
Number of Registers:	1	Actual Winter Vent.:	0 CFM
Runout Air:	1 CFM	Percent of Supply.:	12 %
Runout Duct Size:	4 in.	Actual Summer Vent.:	0 CFM
Runout Air Velocity:	14 ft./min.	Percent of Supply:	12 %
Runout Air Velocity:	14 ft./min.	Actual Winter Infil.:	0 CFM
Actual Loss:	0.000 in.wg./100 ft.	Actual Summer Infil.:	0 CFM

Item Description	Area Quantity	-U- Value	Htg HTM	Sen Loss	Clg HTM	Lat Gain	Sen Gain
N -Part-15°/20°-Demising 2.7 X 9	24	0.071	1.4	34	1.1	0	26
Subtotals for Structure:				34		0	26
Infil.: Win.: 0.0, Sum.: 0.0	0		0	0	0	0	0
Room Totals:				34		0	26



## Detailed Room Loads - Room 15 - 3rd\_floor\_hall (Peak Fenestration Gain Procedure)

### General

Room is in zone 3, which peaks at 7 pm

Calculation Mode:	Htg. & clg.	Occurrences:	1
Room Length:	8.1 ft.	System Number:	1
Room Width:	6.5 ft.	Zone Number:	3
Area:	53.0 sq.ft.	Supply Air:	2 CFM
Ceiling Height:	9.0 ft.	Supply Air Changes:	0.3 AC/hr
Volume:	475.0 cu.ft.	Req. Vent. Clg:	0 CFM
Number of Registers:	1	Actual Winter Vent.:	0 CFM
Runout Air:	2 CFM	Percent of Supply.:	21 %
Runout Duct Size:	4 in.	Actual Summer Vent.:	0 CFM
Runout Air Velocity:	24 ft./min.	Percent of Supply:	12 %
Runout Air Velocity:	24 ft./min.	Actual Winter Infil.:	0 CFM
Actual Loss:	0.001 in.wg./100 ft.	Actual Summer Infil.:	0 CFM

Item Description	Area Quantity	-U- Value	Htg HTM	Sen Loss	Clg HTM	Lat Gain	Sen Gain
N -Part-15°/20°-Demising 2.7 X 9	24	0.071	1.4	34	1.1	0	26
UP-Roof-Buhs II R-48 8.1 X 6.5	52.8	0.021	1.3	69	0.4	0	20
Subtotals for Structure:				103		0	46
Infil.: Win.: 0.0, Sum.: 0.0	0		0	0	0	0	0
Room Totals:				103		0	46





**Detailed Room Loads - Room 9 - 2nd\_floor\_Bed2 (Average Load Procedure)**

**General**

Calculation Mode:	Htg. & clg.	Occurrences:	1
Room Length:	10.5 ft.	System Number:	2
Room Width:	8.8 ft.	Zone Number:	1
Area:	92.0 sq.ft.	Supply Air:	29 CFM
Ceiling Height:	9.0 ft.	Supply Air Changes:	2.1 AC/hr
Volume:	831.0 cu.ft.	Req. Vent. Clg:	0 CFM
Number of Registers:	1	Actual Winter Vent.:	5 CFM
Runout Air:	29 CFM	Percent of Supply.:	17 %
Runout Duct Size:	4 in.	Actual Summer Vent.:	4 CFM
Runout Air Velocity:	328 ft./min.	Percent of Supply:	14 %
Runout Air Velocity:	328 ft./min.	Actual Winter Infil.:	5 CFM
Actual Loss:	0.123 in.wg./100 ft.	Actual Summer Infil.:	0 CFM

Item Description	Area Quantity	-U- Value	Htg HTM	Sen Loss	Clg HTM	Lat Gain	Sen Gain
NE-Wall-R-40 8.8 X 9	64.9	0.025	1.6	102	0.7	0	45
N -Part-15°/20°-Demising 10.5 X 9	94.5	0.071	1.4	134	1.1	0	101
NE-Gls-Buhs II glass shgc-0.22 0%S	14.2	0.270	16.9	241	17.8	0	253
Subtotals for Structure:				477		0	399
Infil.: Win.: 5.4, Sum.: 0.0	79		4.702	372	0.000	0	0
People: 200 lat/per, 230 sen/per:	1					200	230
<b>Room Totals:</b>				<b>849</b>		<b>200</b>	<b>629</b>



**Detailed Room Loads - Room 10 - 2nd\_Floor\_Bed\_1 (Average Load Procedure)**

**General**

Calculation Mode:	Htg. & clg.	Occurrences:	1
Room Length:	15.9 ft.	System Number:	2
Room Width:	10.8 ft.	Zone Number:	1
Area:	171.0 sq.ft.	Supply Air:	47 CFM
Ceiling Height:	9.0 ft.	Supply Air Changes:	1.8 AC/hr
Volume:	1,535.0 cu.ft.	Req. Vent. Clg:	0 CFM
Number of Registers:	1	Actual Winter Vent.:	6 CFM
Runout Air:	47 CFM	Percent of Supply.:	13 %
Runout Duct Size:	4 in.	Actual Summer Vent.:	7 CFM
Runout Air Velocity:	534 ft./min.	Percent of Supply:	14 %
Runout Air Velocity:	534 ft./min.	Actual Winter Infil.:	7 CFM
Actual Loss:	0.322 in.wg./100 ft.	Actual Summer Infil.:	0 CFM

Item Description	Area Quantity	-U- Value	Htg HTM	Sen Loss	Clg HTM	Lat Gain	Sen Gain
SW-Wall-R-40 10.8 X 9	82.5	0.025	1.6	129	0.7	0	57
N -Part-15°/20°-Demising 20.4 X 9	183.6	0.071	1.4	261	1.1	0	196
SW-Gls-Buhs II glass shgc-0.22 0%S	14.2	0.270	16.9	241	21.9	0	312
Subtotals for Structure:				631		0	565
Infil.: Win.: 6.6, Sum.: 0.0	97		4.703	455	0.000	0	0
People: 200 lat/per, 230 sen/per:	2					400	460
Room Totals:				1,086		400	1,025



**Detailed Room Loads - Room 11 - 2nd\_Floor\_Kitchen (Average Load Procedure)**

**General**

Calculation Mode:	Htg. & clg.	Occurrences:	1
Room Length:	13.3 ft.	System Number:	2
Room Width:	10.9 ft.	Zone Number:	1
Area:	146.0 sq.ft.	Supply Air:	83 CFM
Ceiling Height:	9.0 ft.	Supply Air Changes:	3.8 AC/hr
Volume:	1,310.0 cu.ft.	Req. Vent. Clg:	0 CFM
Number of Registers:	1	Actual Winter Vent.:	10 CFM
Runout Air:	83 CFM	Percent of Supply.:	12 %
Runout Duct Size:	5 in.	Actual Summer Vent.:	12 CFM
Runout Air Velocity:	608 ft./min.	Percent of Supply:	14 %
Runout Air Velocity:	608 ft./min.	Actual Winter Infil.:	15 CFM
Actual Loss:	0.304 in.wg./100 ft.	Actual Summer Infil.:	0 CFM

Item Description	Area Quantity	-U- Value	Htg HTM	Sen Loss	Clg HTM	Lat Gain	Sen Gain
SW-Wall-R-40 10.9 X 9	84	0.025	1.6	132	0.7	0	58
SE-Wall-R-40 13.3 X 9	112	0.025	1.6	175	0.7	0	77
SW-Gls-Buhs II glass shgc-0.22 0%S	14.2	0.270	16.9	241	21.9	0	312
SE-Gls-Buhs II glass shgc-0.22 0%S	8	0.270	16.9	135	21.9	0	175
Subtotals for Structure:				683		0	622
Infil.: Win.: 14.9, Sum.: 0.0	218		4.701	1,026	0.000	0	0
Equipment:						0	1,200
Room Totals:				1,709		0	1,822



**Detailed Room Loads - Room 12 - 2nd\_Floor\_Dining\_Room (Average Load Procedure)**

**General**

Calculation Mode:	Htg. & clg.	Occurrences:	1
Room Length:	10.0 ft.	System Number:	2
Room Width:	14.4 ft.	Zone Number:	1
Area:	143.0 sq.ft.	Supply Air:	12 CFM
Ceiling Height:	9.0 ft.	Supply Air Changes:	0.5 AC/hr
Volume:	1,286.0 cu.ft.	Req. Vent. Clg:	0 CFM
Number of Registers:	1	Actual Winter Vent.:	2 CFM
Runout Air:	12 CFM	Percent of Supply.:	16 %
Runout Duct Size:	4 in.	Actual Summer Vent.:	2 CFM
Runout Air Velocity:	134 ft./min.	Percent of Supply:	14 %
Runout Air Velocity:	134 ft./min.	Actual Winter Infil.:	1 CFM
Actual Loss:	0.022 in.wg./100 ft.	Actual Summer Infil.:	0 CFM

Item Description	Area Quantity	-U- Value	Htg HTM	Sen Loss	Clg HTM	Lat Gain	Sen Gain
SE-Wall-R-40 1.8 X 9	7.4	0.025	1.6	12	0.7	0	5
N -Part-15°/20°-Demising 7.2 X 9	64.8	0.071	1.4	92	1.1	0	69
SE-Gls-Buhs II glass shgc-0.22 0%S	8.3	0.270	16.9	141	21.9	0	183
Subtotals for Structure:				245		0	257
Infil.: Win.: 1.1, Sum.: 0.0	16		4.698	74	0.000	0	0
Room Totals:				319		0	257



**Detailed Room Loads - Room 13 - 2nd\_Floor\_Living (Average Load Procedure)**

**General**

Calculation Mode:	Htg. & clg.	Occurrences:	1
Room Length:	13.9 ft.	System Number:	2
Room Width:	12.0 ft.	Zone Number:	1
Area:	167.0 sq.ft.	Supply Air:	70 CFM
Ceiling Height:	9.0 ft.	Supply Air Changes:	2.8 AC/hr
Volume:	1,501.0 cu.ft.	Req. Vent. Clg:	0 CFM
Number of Registers:	1	Actual Winter Vent.:	10 CFM
Runout Air:	70 CFM	Percent of Supply.:	14 %
Runout Duct Size:	5 in.	Actual Summer Vent.:	10 CFM
Runout Air Velocity:	517 ft./min.	Percent of Supply:	14 %
Runout Air Velocity:	517 ft./min.	Actual Winter Infil.:	8 CFM
Actual Loss:	0.220 in.wg./100 ft.	Actual Summer Infil.:	0 CFM

Item Description	Area Quantity	-U- Value	Htg HTM	Sen Loss	Clg HTM	Lat Gain	Sen Gain
NE-Wall-R-40 13.8 X 9	66.9	0.025	1.6	105	0.7	0	46
N -Part-15°/20°-Demising 3.2 X 9	29.2	0.071	1.4	42	1.1	0	31
NE-Gls-Buhs II glass shgc-0.22 0%S (2)	56.8	0.270	16.9	960	17.8	0	1,012
Subtotals for Structure:				1,107		0	1,089
Infil.: Win.: 8.5, Sum.: 0.0	124		4.703	582	0.000	0	0
People: 200 lat/per, 230 sen/per:	2					400	460
<b>Room Totals:</b>				<b>1,689</b>		<b>400</b>	<b>1,549</b>



**Detailed Room Loads - Room 14 - 2nd\_Floor\_Bathroom (Average Load Procedure)**

**General**

Calculation Mode:	Htg. & clg.	Occurrences:	1
Room Length:	5.6 ft.	System Number:	2
Room Width:	5.4 ft.	Zone Number:	1
Area:	30.0 sq.ft.	Supply Air:	9 CFM
Ceiling Height:	9.0 ft.	Supply Air Changes:	2.0 AC/hr
Volume:	274.0 cu.ft.	Req. Vent. Clg:	0 CFM
Number of Registers:	1	Actual Winter Vent.:	2 CFM
Runout Air:	9 CFM	Percent of Supply.:	27 %
Runout Duct Size:	4 in.	Actual Summer Vent.:	1 CFM
Runout Air Velocity:	106 ft./min.	Percent of Supply:	14 %
Runout Air Velocity:	106 ft./min.	Actual Winter Infil.:	3 CFM
Actual Loss:	0.014 in.wg./100 ft.	Actual Summer Infil.:	0 CFM

Item Description	Area Quantity	-U- Value	Htg HTM	Sen Loss	Clg HTM	Lat Gain	Sen Gain
SE-Wall-R-40 5.4 X 9	40.8	0.025	1.6	64	0.7	0	28
SE-Gls-Buhs II glass shgc-0.22 0%S	8	0.270	16.9	135	21.9	0	175
Subtotals for Structure:				199		0	203
Infil.: Win.: 3.3, Sum.: 0.0	49		4.695	229	0.000	0	0
Room Totals:				428		0	203



**Detailed Room Loads - Room 16 - 3rd\_Floor\_Bed\_1 (Average Load Procedure)**

**General**

Calculation Mode:	Htg. & clg.	Occurrences:	1
Room Length:	15.9 ft.	System Number:	3
Room Width:	10.8 ft.	Zone Number:	1
Area:	171.0 sq.ft.	Supply Air:	50 CFM
Ceiling Height:	9.0 ft.	Supply Air Changes:	1.9 AC/hr
Volume:	1,535.0 cu.ft.	Req. Vent. Clg:	0 CFM
Number of Registers:	1	Actual Winter Vent.:	6 CFM
Runout Air:	50 CFM	Percent of Supply.:	13 %
Runout Duct Size:	4 in.	Actual Summer Vent.:	7 CFM
Runout Air Velocity:	568 ft./min.	Percent of Supply:	13 %
Runout Air Velocity:	568 ft./min.	Actual Winter Infil.:	7 CFM
Actual Loss:	0.363 in.wg./100 ft.	Actual Summer Infil.:	0 CFM

Item Description	Area Quantity	-U- Value	Htg HTM	Sen Loss	Clg HTM	Lat Gain	Sen Gain
SW-Wall-R-40 10.8 X 9	82.5	0.025	1.6	129	0.7	0	57
N -Part-15°/20°-Demising 20.4 X 9	183.6	0.071	1.4	261	1.1	0	196
SW-Gls-Buhs II glass shgc-0.22 0%S	14.2	0.270	16.9	241	21.9	0	312
UP-Roof-Buhs II R-48 15.9 X 10.8	170.6	0.021	1.3	224	0.4	0	64
Subtotals for Structure:				855		0	629
Infil.: Win.: 6.6, Sum.: 0.0	97		4.703	455	0.000	0	0
People: 200 lat/per, 230 sen/per:	2					400	460
Room Totals:				1,310		400	1,089



**Detailed Room Loads - Room 17 - 3rd\_Floor\_Kitchen (Average Load Procedure)**

**General**

Calculation Mode:	Htg. & clg.	Occurrences:	1
Room Length:	13.3 ft.	System Number:	3
Room Width:	10.9 ft.	Zone Number:	1
Area:	146.0 sq.ft.	Supply Air:	85 CFM
Ceiling Height:	9.0 ft.	Supply Air Changes:	3.9 AC/hr
Volume:	1,310.0 cu.ft.	Req. Vent. Clg:	0 CFM
Number of Registers:	1	Actual Winter Vent.:	9 CFM
Runout Air:	85 CFM	Percent of Supply.:	11 %
Runout Duct Size:	5 in.	Actual Summer Vent.:	11 CFM
Runout Air Velocity:	626 ft./min.	Percent of Supply:	13 %
Runout Air Velocity:	626 ft./min.	Actual Winter Infil.:	15 CFM
Actual Loss:	0.322 in.wg./100 ft.	Actual Summer Infil.:	0 CFM

Item Description	Area Quantity	-U- Value	Htg HTM	Sen Loss	Clg HTM	Lat Gain	Sen Gain
SW-Wall-R-40 10.9 X 9	84	0.025	1.6	132	0.7	0	58
SE-Wall-R-40 13.3 X 9	112	0.025	1.6	175	0.7	0	77
SW-Gls-Buhs II glass shgc-0.22 0%S	14.2	0.270	16.9	241	21.9	0	312
SE-Gls-Buhs II glass shgc-0.22 0%S	8	0.270	16.9	135	21.9	0	175
UP-Roof-Buhs II R-48 13.3 X 10.9	145.6	0.021	1.3	191	0.4	0	55
Subtotals for Structure:				874		0	677
Infil.: Win.: 14.9, Sum.: 0.0	218		4.701	1,026	0.000	0	0
Equipment:						0	1,200
Room Totals:				1,900		0	1,877





**Detailed Room Loads - Room 18 - 3rd\_Floor\_Dining\_Room (Average Load Procedure)**

**General**

Calculation Mode:	Htg. & clg.	Occurrences:	1
Room Length:	10.0 ft.	System Number:	3
Room Width:	14.4 ft.	Zone Number:	1
Area:	143.0 sq.ft.	Supply Air:	14 CFM
Ceiling Height:	9.0 ft.	Supply Air Changes:	0.7 AC/hr
Volume:	1,286.0 cu.ft.	Req. Vent. Clg:	0 CFM
Number of Registers:	1	Actual Winter Vent.:	3 CFM
Runout Air:	14 CFM	Percent of Supply.:	18 %
Runout Duct Size:	4 in.	Actual Summer Vent.:	2 CFM
Runout Air Velocity:	162 ft./min.	Percent of Supply:	13 %
Runout Air Velocity:	162 ft./min.	Actual Winter Infil.:	1 CFM
Actual Loss:	0.031 in.wg./100 ft.	Actual Summer Infil.:	0 CFM

Item Description	Area Quantity	-U- Value	Htg HTM	Sen Loss	Clg HTM	Lat Gain	Sen Gain
SE-Wall-R-40 1.8 X 9	7.4	0.025	1.6	12	0.7	0	5
N -Part-15°/20°-Demising 7.2 X 9	64.8	0.071	1.4	92	1.1	0	69
SE-Gls-Buhs II glass shgc-0.22 0%S	8.3	0.270	16.9	141	21.9	0	183
UP-Roof-Buhs II R-48 10 X 14.4	142.9	0.021	1.3	188	0.4	0	54
Subtotals for Structure:				433		0	311
Infil.: Win.: 1.1, Sum.: 0.0	16		4.698	74	0.000	0	0
Room Totals:				507		0	311



**Detailed Room Loads - Room 19 - 3rd\_Floor\_Living (Average Load Procedure)**

**General**

Calculation Mode:	Htg. & clg.	Occurrences:	1
Room Length:	13.9 ft.	System Number:	3
Room Width:	12.0 ft.	Zone Number:	1
Area:	167.0 sq.ft.	Supply Air:	73 CFM
Ceiling Height:	9.0 ft.	Supply Air Changes:	2.9 AC/hr
Volume:	1,501.0 cu.ft.	Req. Vent. Clg:	0 CFM
Number of Registers:	1	Actual Winter Vent.:	9 CFM
Runout Air:	73 CFM	Percent of Supply.:	13 %
Runout Duct Size:	5 in.	Actual Summer Vent.:	10 CFM
Runout Air Velocity:	538 ft./min.	Percent of Supply:	13 %
Runout Air Velocity:	538 ft./min.	Actual Winter Infil.:	8 CFM
Actual Loss:	0.238 in.wg./100 ft.	Actual Summer Infil.:	0 CFM

Item Description	Area Quantity	-U- Value	Htg HTM	Sen Loss	Clg HTM	Lat Gain	Sen Gain
NE-Wall-R-40 13.8 X 9	66.9	0.025	1.6	105	0.7	0	46
N -Part-15°/20°-Demising 3.2 X 9	29.2	0.071	1.4	42	1.1	0	31
NE-Gls-Buhs II glass shgc-0.22 0%S (2)	56.8	0.270	16.9	960	17.8	0	1,012
UP-Roof-Buhs II R-48 13.9 X 12	166.7	0.021	1.3	219	0.4	0	63
Subtotals for Structure:				1,326		0	1,152
Infil.: Win.: 8.5, Sum.: 0.0	124		4.703	582	0.000	0	0
People: 200 lat/per, 230 sen/per:	2					400	460
Room Totals:				1,908		400	1,612



**Detailed Room Loads - Room 20 - 3rd\_Floor\_Bathroom (Average Load Procedure)**

**General**

Calculation Mode:	Htg. & clg.	Occurrences:	1
Room Length:	5.6 ft.	System Number:	3
Room Width:	5.4 ft.	Zone Number:	1
Area:	30.0 sq.ft.	Supply Air:	10 CFM
Ceiling Height:	9.0 ft.	Supply Air Changes:	2.1 AC/hr
Volume:	274.0 cu.ft.	Req. Vent. Clg:	0 CFM
Number of Registers:	1	Actual Winter Vent.:	2 CFM
Runout Air:	10 CFM	Percent of Supply.:	24 %
Runout Duct Size:	4 in.	Actual Summer Vent.:	1 CFM
Runout Air Velocity:	112 ft./min.	Percent of Supply:	13 %
Runout Air Velocity:	112 ft./min.	Actual Winter Infil.:	3 CFM
Actual Loss:	0.015 in.wg./100 ft.	Actual Summer Infil.:	0 CFM

Item Description	Area Quantity	-U- Value	Htg HTM	Sen Loss	Clg HTM	Lat Gain	Sen Gain
SE-Wall-R-40 5.4 X 9	40.8	0.025	1.6	64	0.7	0	28
SE-Gls-Buhs II glass shgc-0.22 0%S	8	0.270	16.9	135	21.9	0	175
UP-Roof-Buhs II R-48 5.6 X 5.4	30.4	0.021	1.3	40	0.4	0	11
Subtotals for Structure:				239		0	214
Infil.: Win.: 3.3, Sum.: 0.0	49		4.695	229	0.000	0	0
Room Totals:				468		0	214



**Detailed Room Loads - Room 21 - 3rd\_floor\_Bed2 (Average Load Procedure)**

**General**

Calculation Mode:	Htg. & clg.	Occurrences:	1
Room Length:	10.5 ft.	System Number:	3
Room Width:	8.8 ft.	Zone Number:	1
Area:	92.0 sq.ft.	Supply Air:	30 CFM
Ceiling Height:	9.0 ft.	Supply Air Changes:	2.2 AC/hr
Volume:	831.0 cu.ft.	Req. Vent. Clg:	0 CFM
Number of Registers:	1	Actual Winter Vent.:	5 CFM
Runout Air:	30 CFM	Percent of Supply.:	16 %
Runout Duct Size:	4 in.	Actual Summer Vent.:	4 CFM
Runout Air Velocity:	346 ft./min.	Percent of Supply:	13 %
Runout Air Velocity:	346 ft./min.	Actual Winter Infil.:	5 CFM
Actual Loss:	0.137 in.wg./100 ft.	Actual Summer Infil.:	0 CFM

Item Description	Area Quantity	-U- Value	Htg HTM	Sen Loss	Clg HTM	Lat Gain	Sen Gain
NE-Wall-R-40 8.8 X 9	64.9	0.025	1.6	102	0.7	0	45
N -Part-15°/20°-Demising 10.5 X 9	94.5	0.071	1.4	134	1.1	0	101
NE-Gls-Buhs II glass shgc-0.22 0%S	14.2	0.270	16.9	241	17.8	0	253
UP-Roof-Buhs II R-48 10.5 X 8.8	92.3	0.021	1.3	121	0.4	0	35
Subtotals for Structure:				598		0	434
Infil.: Win.: 5.4, Sum.: 0.0	79		4.702	372	0.000	0	0
People: 200 lat/per, 230 sen/per:	1					200	230
Room Totals:				970		200	664



## Room Cooling and Heating Loads Bar Graphs

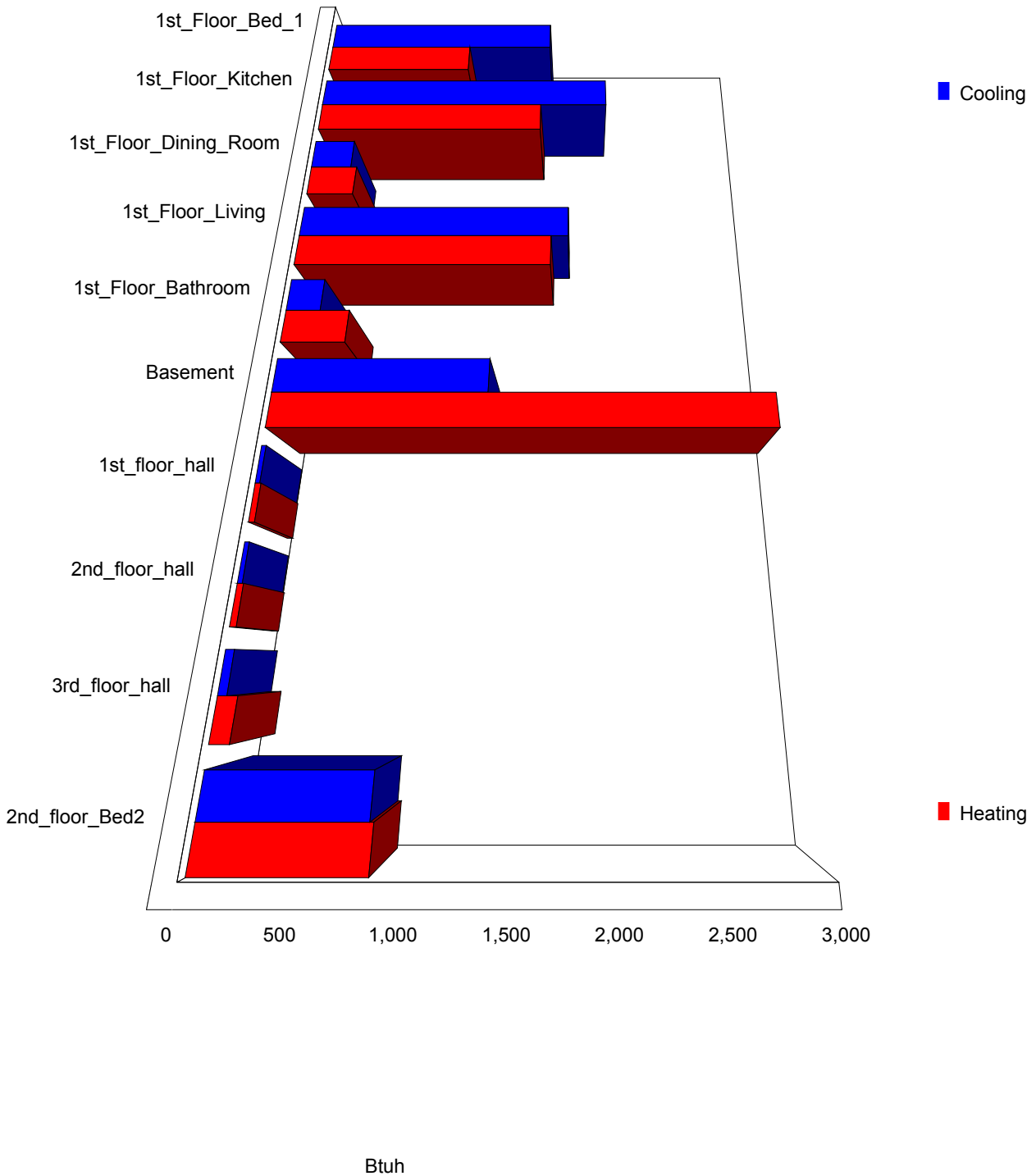



### Room Cooling and Heating Loads Bar Graphs

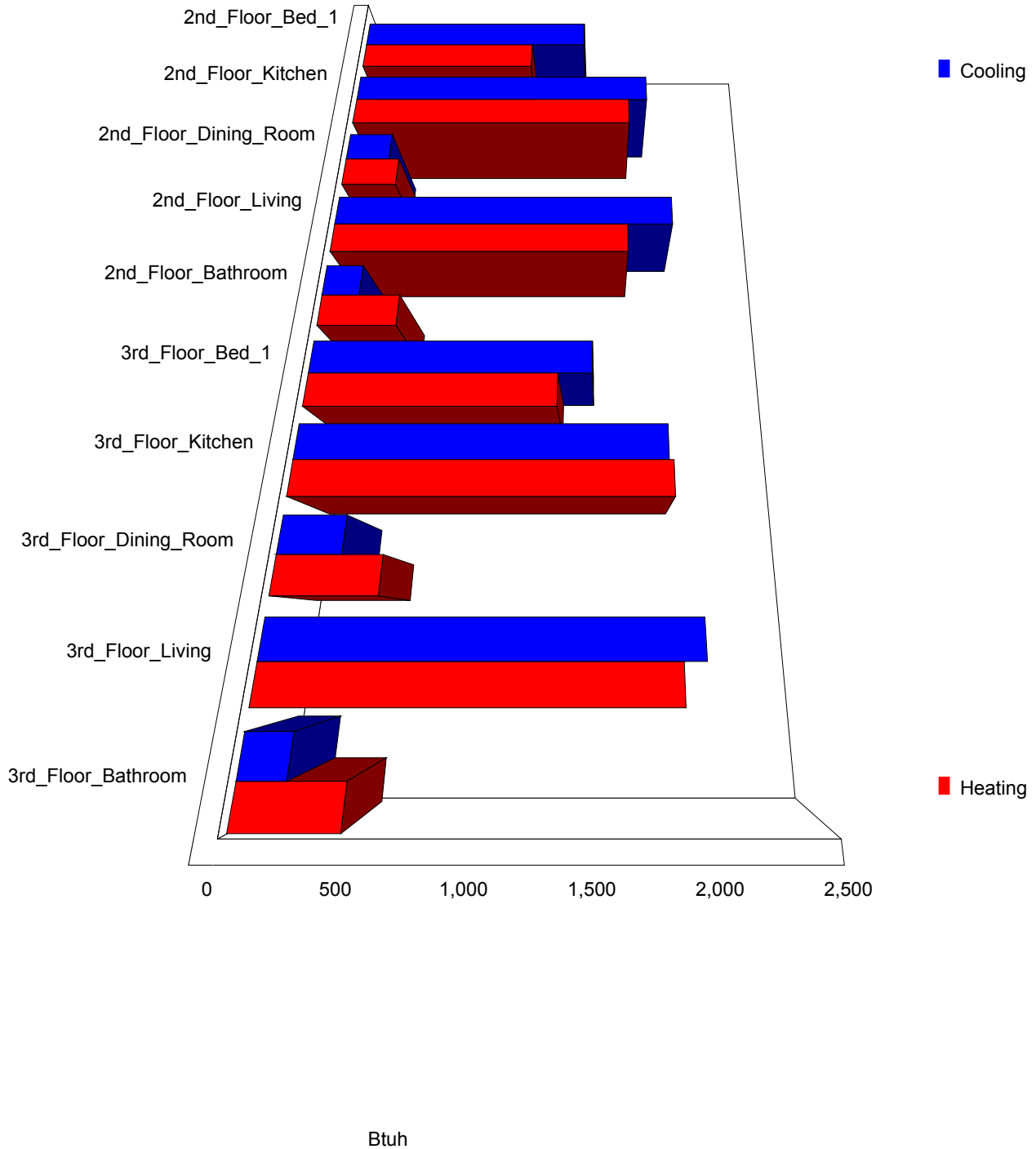



### Room Cooling and Heating Loads Bar Graphs

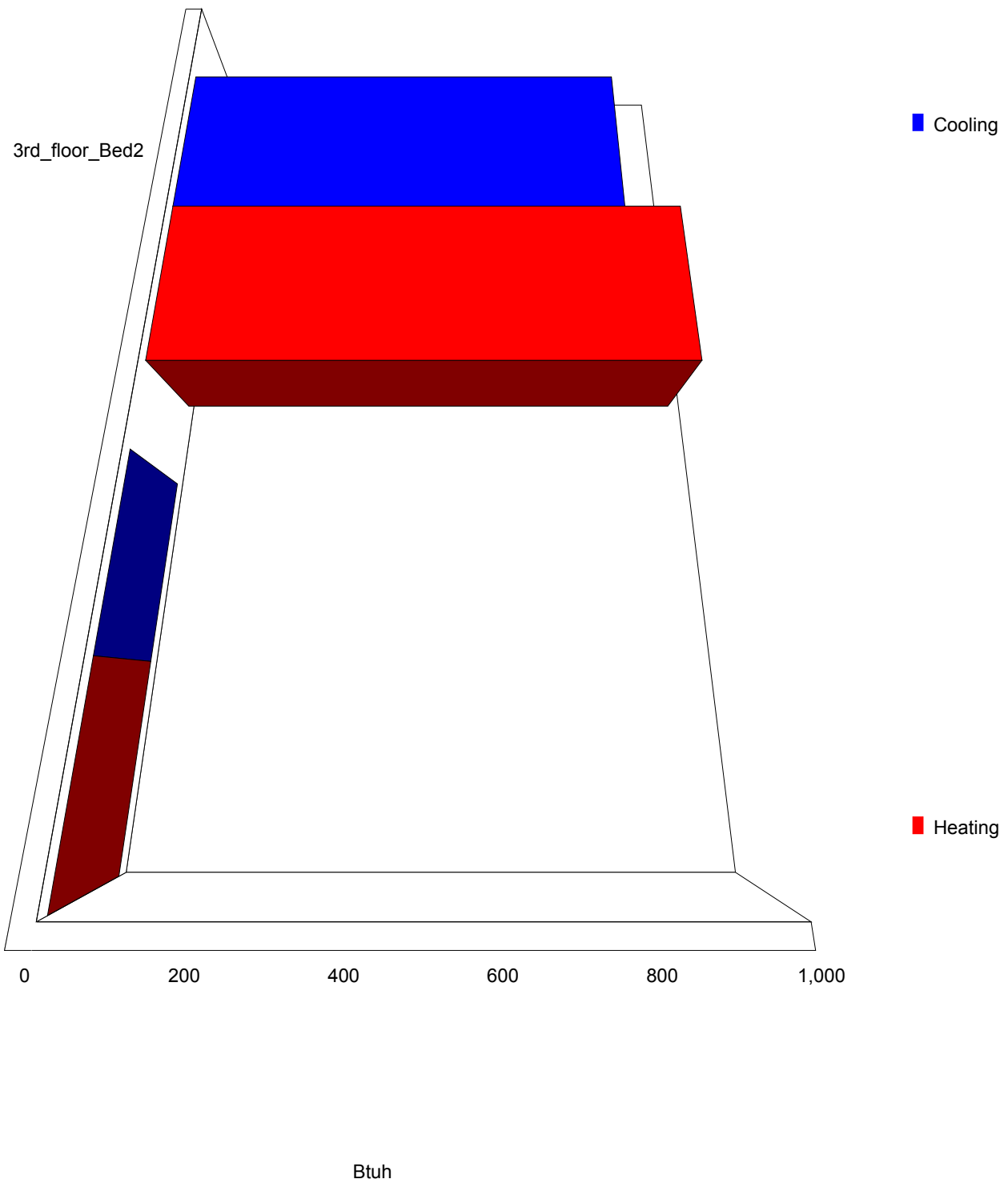



### Room Cooling Loads Bar Graphs

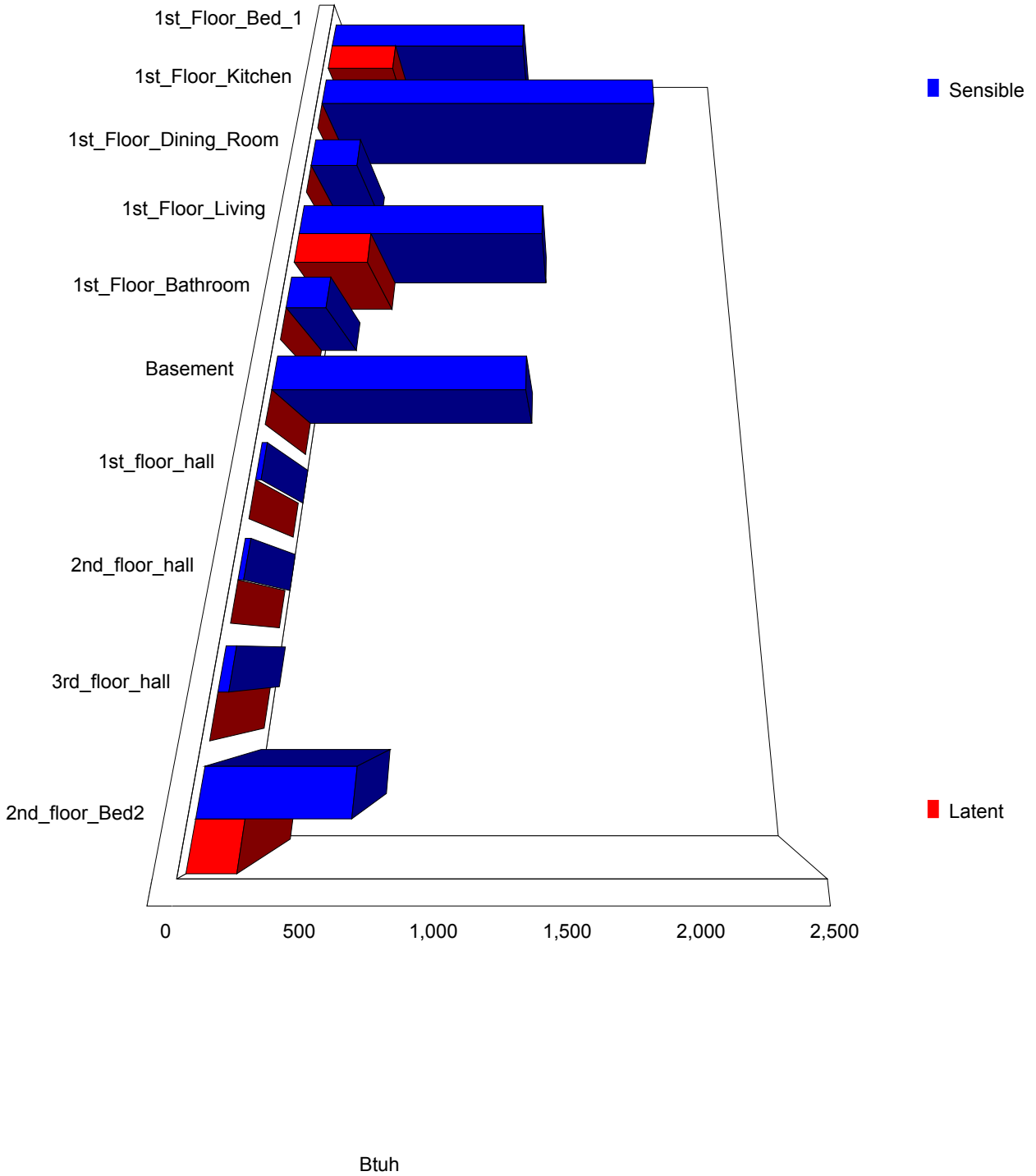





### Room Cooling Loads Bar Graphs

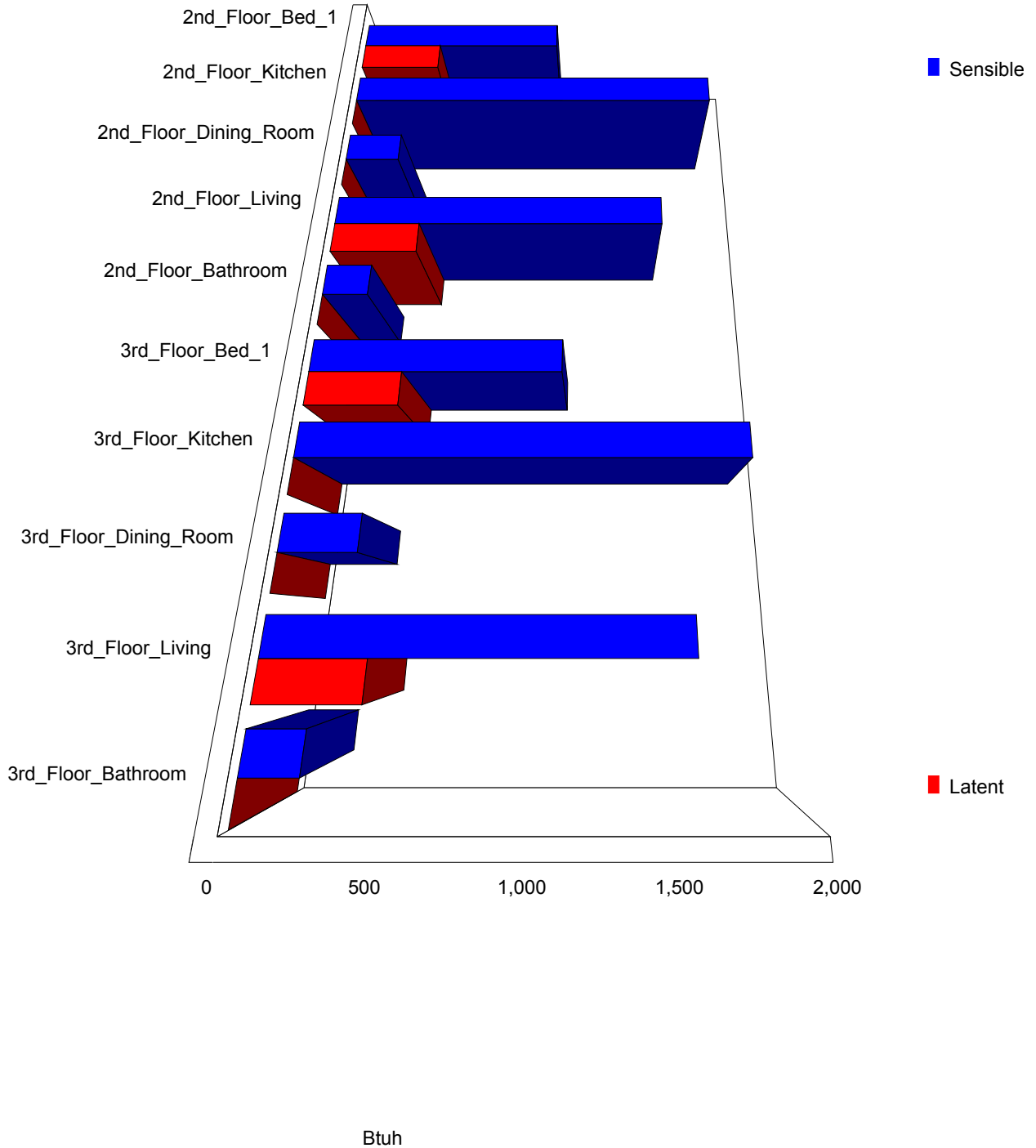



## Room Cooling Loads Bar Graphs

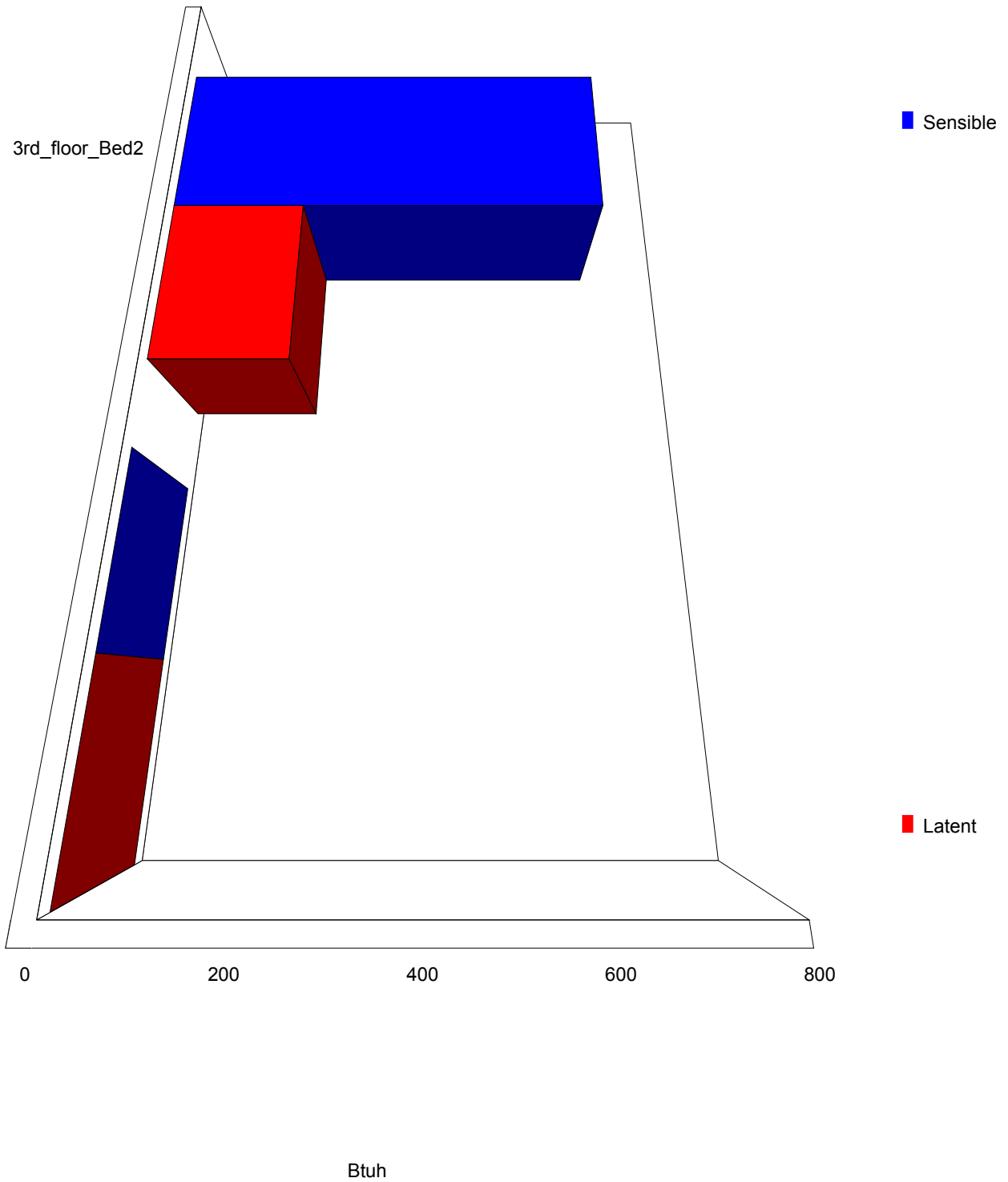



### System 1 Room Load Summary

Room No	Room Name	Area SF	Htg Sens Btuh	Min Htg CFM	Run Duct Size	Run Duct Vel	Clg Sens Btuh	Clg Lat Btuh	Min Clg CFM	Act Sys CFM
---Zone 1---										
3	1st_Floor_Bed_1	171	1,014	13	1-4	627	1,204	400	55	55
4	1st_Floor_Kitchen	146	1,548	20	1-6	466	2,010	0	91	91
5	1st_Floor_Dining_Room	143	307	4	1-4	139	266	0	12	12
6	1st_Floor_Living	167	1,637	21	1-4	703	1,348	400	61	61
7	1st_Floor_Bathroom	30	392	5	1-4	110	212	0	10	10
Zone 1 subtotal		657	4,898	64			5,040	800	229	229
---Zone 2---										
1	Basement	934	2,988	39	1-4	668	1,282	0	58	58
Zone 2 subtotal		934	2,988	39			1,282	0	58	58
---Zone 3---										
2	1st_floor_hall	53	34	0	1-4	14	26	0	1	1
8	2nd_floor_hall	53	34	0	1-4	14	26	0	1	1
15	3rd_floor_hall	53	103	1	1-4	24	46	0	2	2
Zone 3 subtotal		159	171	2			98	0	4	4
Ventilation			2,409				616	678		
System 1 total		1,750	10,466	105			6,758	1,478	279	279

Note: Since the system is multizone, the Peak Fenestration Gain Procedure was used to determine glass sensible gains at the room and zone levels, so the sums of the zone sensible gains and airflows for cooling shown above are not intended to equal the totals at the system level. Room and zone sensible gains and cooling CFM values are for the hour in which the glass sensible gain for the zone is at its peak. Sensible gains at the system level are based on the "Average Load Procedure + Excursion" method.

### Cooling System Summary

	Cooling Tons	Sensible/Latent Split	Sensible Btuh	Latent Btuh	Total Btuh
Net Required:	0.69	82% / 18%	6,758	1,478	8,236
Recommended:	0.75	75% / 25%	6,758	2,253	9,010



### System 2 Room Load Summary

Room No	Room Name	Area SF	Htg Sens Btuh	Min Htg CFM	Run Duct Size	Run Duct Vel	Clg Sens Btuh	Clg Lat Btuh	Min Clg CFM	Act Sys CFM
---Zone 1---										
9	2nd_floor_Bed2	92	849	11	1-4	328	629	200	29	29
10	2nd_Floor_Bed_1	171	1,086	14	1-4	534	1,025	400	47	47
11	2nd_Floor_Kitchen	146	1,709	22	1-5	608	1,822	0	83	83
12	2nd_Floor_Dining_Room	143	319	4	1-4	134	257	0	12	12
13	2nd_Floor_Living	167	1,689	22	1-5	517	1,549	400	70	70
14	2nd_Floor_Bathroom	30	428	6	1-4	106	203	0	9	9
Ventilation			2,409				616	678		
System 2 total		749	8,489	79			6,101	1,678	249	249

### Cooling System Summary

	Cooling Tons	Sensible/Latent Split	Sensible Btuh	Latent Btuh	Total Btuh
Net Required:	0.65	78% / 22%	6,101	1,678	7,779
Recommended:	0.68	75% / 25%	6,101	2,034	8,134

### Equipment Data

	Heating System	Cooling System
Type:	Electric Resistance	Standard Air Conditioner
Model:		
Indoor Model:		
Brand:		
Efficiency:	0%	0 SEER
Sound:		
Capacity:	0	0
Sensible Capacity:	n/a	0 Btuh
Latent Capacity:	n/a	0 Btuh



### System 3 Room Load Summary

Room No	Room Name	Area SF	Htg Sens Btuh	Min Htg CFM	Run Duct Size	Run Duct Vel	Clg Sens Btuh	Clg Lat Btuh	Min Clg CFM	Act Sys CFM
---Zone 1---										
16	3rd_Floor_Bed_1	171	1,310	17	1-4	568	1,089	400	50	50
17	3rd_Floor_Kitchen	146	1,900	25	1-5	626	1,877	0	85	85
18	3rd_Floor_Dining_Room	143	507	7	1-4	162	311	0	14	14
19	3rd_Floor_Living	167	1,908	25	1-5	538	1,612	400	73	73
20	3rd_Floor_Bathroom	30	468	6	1-4	112	214	0	10	10
21	3rd_floor_Bed2	92	970	13	1-4	346	664	200	30	30
Ventilation			2,409				616	678		
System 3 total		749	9,472	92			6,383	1,678	262	262

### Cooling System Summary

	Cooling Tons	Sensible/Latent Split	Sensible Btuh	Latent Btuh	Total Btuh
Net Required:	0.67	79% / 21%	6,383	1,678	8,061
Recommended:	0.71	75% / 25%	6,383	2,128	8,510

### Equipment Data

	Heating System	Cooling System
Type:	Electric Resistance	Standard Air Conditioner
Model:		
Indoor Model:		
Brand:		
Efficiency:	0%	0 SEER
Sound:		
Capacity:	0	0
Sensible Capacity:	n/a	0 Btuh
Latent Capacity:	n/a	0 Btuh

*buildingamerica.gov*

U.S. DEPARTMENT OF  
**ENERGY** | Energy Efficiency &  
Renewable Energy

DOE/GO-102012-3469 • September 2012

Printed with a renewable-source ink on paper containing at least 50% wastepaper, including 10% post-consumer waste.