

CHROMATE INHIBITION OF THE LOCALIZED CORROSION OF ALUMINUM: MEASUREMENTS OF ELECTROCHEMICAL TRANSIENTS

K. Sasaki^a, H.S. Isaacs^b

^a The Fontana Corrosion Center, The Ohio State University
Columbus, Ohio 43210, USA

^b Department of Materials Science, Brookhaven National Laboratory
Upton, New York 11973, USA

ABSTRACT

We investigated the inhibition by chromate ions of the localized corrosion of aluminum by electrochemical transient measurements. In agreement with other work, the measurements demonstrated that chromate is a cathodic inhibitor for aluminum in open circuit. The reduction of hexavalent chromium to trivalent chromium is assumed to take place on catalyzed sites of the surface. The resulting products inhibit oxygen reduction reactions at these sites, thereby retarding pitting corrosion.

INTRODUCTION

Chromate compounds in aqueous solutions improve the resistance to corrosion of many metals and alloys (1,2). However, the hazards to health and environment from exposure to hexavalent chromium have been increasingly recognized, and, consequently, much research world-wide has focused on finding environmentally-friendly alternatives (3-5). However, no suitable replacement has yet been identified because the mechanism of chromate inhibition still is unclear and there is no methodology to develop new alternatives. A deeper understanding of the protective mechanism of chromate is of the utmost importance in replacing it.

Fluctuations in current or potential due to electrochemical processes generally are termed electrochemical noise (6-8). One basic configuration for measuring electrochemical noise comprises two identical working electrodes and a reference electrode; the current flowing between these two electrodes and the potential of the working electrodes relative to the reference electrode are recorded simultaneously. Measurements of electrochemical noise have been extensively analyzed to detect and characterize various types of corrosion, although there have been few studies of the effect of inhibitors on corrosion. In the present communication we introduce a new technique that measures the current and potential transients from two electrodes held in separate vessels. Our objective is to clarify the origins of chromate inhibition of localized corrosion of aluminum by measuring these electrochemical transients.

EXPERIMENTAL

The specimens used were 0.76 mm diameter wires of 99.9 % purity Al and Al-4wt-% Cu. The fabrication of the two identical electrodes and the experimental setup were described in elsewhere (9,10). The distance between the centers of the electrodes was 1.2 mm. We also used a second electrochemical cell consisting of two separate electrolyte vessels linked with a salt bridge (Figure 1). Each vessel held 50 ml of a solution. The wires were coated with a layer of lacquer except for an 1 cm long area (0.24 cm^2), that was exposed to the electrolyte. The surfaces of the specimens were wet-ground on a 600 grit silicon carbide abrasive paper and washed in distilled water just before the measurements were taken. Solutions were made with analytical grade reagents and distilled water ($18 \text{ M}\Omega$).

We recorded the open-circuit potential of the two short-circuited electrodes against a saturated calomel reference electrode (SCE) using a high impedance ($10^{13} \Omega$) electrometer (Keithley, model 614). The current passing the two electrodes also was measured by a second Keithley electrometer with the current mode. The outputs from these electrometers were fed to a 12-bit digital oscilloscope (Tektronix, TDS 420A) at an acquisition rate of 10 Hz. All measurements were made at room temperature.

RESULTS AND DISCUSSION

Figure 2 shows a 1200 s trace of the current and open-circuit transients from two identical Al electrodes (0.76 mm diameter) in 60 ml of 0.05 M NaCl. The current transient shows intermittent positive and negative spikes while the potential transient displays the accompanying events, such as a sharp drop, followed by a relatively slower rise. These events are attributed to the initiation, propagation, and repassivation of metastable pits. When 5 ml of 0.05 M NaCl and 0.05 M K_2CrO_4 solution was added to the cell at 610 s, most events disappeared from both transients, indicating that CrO_4^{2-} hampers the pit initiation. Another marked feature in Figure 2 is that the open-circuit potential falls from -0.69 V(SCE) to a minimum value of -1.05 V(SCE) at about 250s after adding chromate.

Figure 3 shows the potentiodynamic polarization curves of Al measured in 0.05 M NaCl + 0.05 M K_2CrO_4 and 0.05 M NaCl at a sweep rate of 1 mV s^{-1} . Chromate had a twofold effect. First, the open-circuit potential decreased from -0.70 V(SCE) to -1.09 V(SCE) . Second, the pitting potential increased from -0.63 V(SCE) to -0.39 V(SCE) , thereby leading to a much wider passive region compared with that in chloride alone. The decrease in open-circuit potential is likely to reflect the retardation of the cathodic reaction, *i.e.*, the oxygen reduction reaction. Thus, we rationalize that chromate inhibits the cathodic reaction of oxygen on the aluminum surface, thereby suppressing anodic dissolution. This observation agrees with those recently reported by others (11-13).

Figure 4 shows a 400 s trace of the potentiostatic current transient for an Al electrode in 50 ml of 0.05 M NaCl at a potential of -660 mV(SCE) . A sequence of anodic spikes due to metastable pitting is seen on the current trace 10 s after the starting the measurement. Five ml of 0.05 M NaCl + 0.05 M K_2CrO_4 was added to the cell at 200

s, and these events disappeared shortly thereafter. The result suggests that chromate also retards the propagation of metastable pitting under potentiostatic control. The higher pitting potential in the presence of chromate ions (Figure 3) can be explained by their impeding the formation of pits.

Figure 5(a) illustrates current and potential transients at open circuit measured with two connected Al electrodes held in separate vessels linked with a salt bridge (Figure 1). The specimens were 1 cm long wires, 0.75 mm in diameter. Both vessels contained 50 ml of a 0.05 M NaCl solution. We designate the vessel containing the electrode connected to the (+) terminal of the electrometer as "vessel (+)" and the vessel containing the electrode connected to the (-) terminal of the electrometer as "vessel (-)". A change in current in the positive direction indicates that the specimen in vessel (-) is anodic and the specimen in vessel (+) is cathodic, and *vice versa*. After the onset of measurements, the current transient showed several events in both positive and negative directions that are associated with drops in potential; they indicate that pitting occurs almost evenly on the surface of both electrodes. The positive background on the current transient (which slowly declined from 150 nA to 100 nA) is primarily due to the slight difference in areas of two specimens. At 1200 s, 5 ml of a 0.05 M NaCl and 0.05 M K_2CrO_4 solution was added to vessel (+), changing its concentration to 0.0045 M K_2CrO_4 . Immediately afterwards, the current dropped significantly to a negative value of -180 nA. Then, the number of spikes in the current transient fell, and most of them became oriented in the positive direction, as presented in Figure 5(b). The potential decreased on adding chromate. At 2200 s, 5 ml of 0.05 M NaCl and 0.05 M K_2CrO_4 was added to the vessel (-). The current increased toward a steady-state value near zero and few intermittent events were observed on the trace. The potential decreased again on the second addition of chromate.

We can interpret the behavior of the current trace in Figure 4 as follows: by adding chromate to vessel (+), the current became negative, reflecting that the specimen in vessel (-) had become more cathodic. The oxygen reduction reaction on the specimen surface in vessel (+) must be impeded by the presence of chromate. Consequently, the cathodic reaction occurs predominantly in vessel (-) and the corresponding anodic reaction (oxidation of aluminum) takes place predominantly in vessel (+). The overall frequency of occurrence of metastable pitting decreases due to the presence of chromate ions in vessel (+) and the concomitant drop in potential. Most spikes on the current trace in this regime sharply rose in the positive direction, indicating that pitting occurs mainly in vessel (-). Such pitting then was hampered by the subsequent addition of chromate to this vessel and the further fall in potential.

Figure 6 shows current and potential transients measured for two Al electrodes in separate vessels, each containing 50 ml of a 5 M NaCl solution. Five ml of a 5 M NaCl and 5 M K_2CrO_4 solution was added to vessel (+) and vessel (-) at 956 s and 1250 s, respectively. The following features can be drawn from comparing Figure 6 with Figure 5:

- (i) A sharp rise toward the positive direction appeared in the current trace before it plunged to negative values when the chromate solution was added to vessel(+).
- (ii) Conversely, a sharp fall to the negative direction appeared in the current trace before reaching a steady-state value near zero when the chromate solution was added to vessel (-).

(iii) The potential transient showed a sharp rise before decreasing toward a constant value whenever the chromate solution was added to either vessel (+) or vessel (-).

As the change in current to the positive direction indicates that the specimen in vessel (+) is cathodic, the sharp rise in current described in (i) must be caused by an enhancement of cathodic reactions on the electrode surface in vessel (+) after adding chromate. Likewise, the sharp fall described in (ii) also is due to an increase in cathodic reactions on the electrode surface in vessel (-). The sharp increases in the potential trace described in (iii) also are explained by an enhancement of cathodic reactions on the surface of either specimen.

Two possible cathodic reactions might be enhanced by adding a chromate-containing solution. One is the reduction of hexavalent chromium Cr(VI) to trivalent chromium Cr(III). The other is the oxygen reduction reaction; adding the solution to the vessel generates convection in the cell solution. Therefore, the oxygen reduction reaction is increased due to an enhanced rate of mass transport. Figure 7 shows the effect of these two reactions on current transients. Two separate vessels each contained 50 ml of a 5 M NaCl solution. Broken arrows denote that 5 ml of 5 M NaCl was added to vessel (+) (upward arrow) or to vessel (-) (downward arrow). Solid arrows denote that 5 ml of 5 M NaCl and 0.05 M K_2CrO_4 was added to vessel (+) (upward arrow) or to vessel (-) (downward arrow). The amplitude of current changes following the first addition of chloride and chromate to the vessel is far greater than that caused by the addition of solution with only chloride. (It is interesting to note that a second addition of a chromate-containing solution to the vessel at 920 s did not change the current.) This is clearly illustrated in Figure 8. This figure presents the mean values of the changes in the amplitude of the current after adding 5 ml solutions containing (a) 5 M NaCl + 1 M K_2CrO_4 , (b) 5 M NaCl + 0.05 M K_2CrO_4 , and (c) 5 M NaCl. The error bars show the standard deviation of seven to nine readings. Apparently, after adding chromate, the amplitude is higher than after adding a chromate-free solution. Thus, we confirm that the reduction of Cr(VI) to Cr(III) is engendered immediately in the presence of the chromate solution. The resultant deposition of Cr(III) then inhibits the oxygen reduction reaction, consequently lowering the electrode potential and hampering pitting. Another interesting point drawn from Figure 8 is that the amplitude is very similar after the additions of solutions containing 1 M K_2CrO_4 and those with 0.05 M K_2CrO_4 . This independence from chromate concentration suggests that a finite number of chromate ions may be expended for the cathodic reaction.

We note that these sharp rises/falls in current that followed by the addition of electrolyte were sometimes difficult to observe in the system with 0.05 M NaCl solution (Figure 5(a)). Five ml of 0.05 M NaCl also was added at 740 s and 1000 s, yet changes in the current were hardly discernible (Figure 5(a)). It is known that the solubility of oxygen decreases with increasing NaCl concentration (14). A dilute NaCl solution, such as 0.05 M, contains more oxygen than a concentrated one, thereby masking the effects of an enhanced mass-transport rate, and presumably, also the reduction of chromate due to adding a solution containing chromate. The reason that we used a concentrated solution is to enable us to identify these cathodic reactions.

The results described above clearly demonstrate the mechanism whereby chromate in solution inhibits localized corrosion on the metal surface; the reduction of Cr(VI) to Cr(III) occurs on the surface, and the resultant deposition of Cr(III), possibly as

Cr_2O_3 or $\text{Cr}(\text{OH})_3$, stifles the oxygen reduction reaction. As a result, the open-circuit potential decreases and pitting corrosion is inhibited. Another suggested mechanism of inhibition is that chromate ions (CrO_4^{2-}) are adsorbed on the metal surface, thereby hindering the oxygen cathodic reaction (15). However, adsorption of CrO_4^{2-} at the surface cannot give the positive change in current when chromate solution is added to vessel (+) as depicted in Figures 6 and 7, and therefore, we consider that this notion is erroneous.

The charge density q required for Cr(III) deposition can be determined by integrating the change in current on adding chromate. The q from the rise in current at 500 s in Figure 7 was $12 \mu\text{C cm}^{-2}$. Because the formation of monolayer usually requires a charge density of *ca* 0.5 mC cm^{-2} , the calculated q seems very small, showing only 2.4 % coverage by the monolayer deposited on the electrode surface. One plausible reason for the low charge density is that the increase in current caused by the reduction reaction of Cr(VI) to Cr(III) is masked significantly by the rapid drop in current attendant upon the retardation of the oxygen reduction reaction. Another possibility is that Cr(III) deposition takes place only on preferential reaction sites. This is discussed below.

Figure 9(a) shows current and potential transients measured for Al and Al-4%Cu electrodes in separate vessels containing 50 ml of 0.05 M NaCl solution. The Al electrode was connected to the (+) terminal of the electrometer (vessel (+)) and the Al-4%Cu electrode was connected to the (-) terminal (vessel (-)). After the start of measurements, the background current continued to decrease, approaching *ca* -500 nA at 960 s, indicating that a galvanic coupling is formed between the Al and Al-4% Cu electrodes. The oxygen reduction reaction takes place predominantly on the Al-4%Cu specimen surface while the Al electrode acts as the dominant anode. (Several measurements were performed to confirm that this negative background current was not caused by the variation in the areas of two electrodes.) Several pitting events in the negative direction are superimposed on the background current. These are ascribed to the evolution of metastable pitting on the Al electrode surface. Five ml of a 0.05 M NaCl and 0.05 M K_2CrO_4 solution was added to vessel (+) with the Al-4%Cu specimen at 960 s. Although the current and the potential decreased initially due to retardation of oxygen reduction reaction on the Al electrode, the effect did not last long. By 1200 s the potential had rebounded to its value before the chromate solution was added and continued to increase further with time. Then, current spikes in the negative direction began to reappear, implying that propagation of metastable pitting had recurred on the Al electrode. After 5 ml of 0.05 M NaCl and 0.05 M K_2CrO_4 solution was added to vessel (-) with the Al electrode at 1950 s, the potential decreased markedly; the current trace shows that metastable pitting on the Al electrode was effectively inhibited. Figure 9(b) also shows current and potential traces for Al and Al-4%Cu electrodes in separate vessels containing 50 ml of 0.05 M NaCl solution. In this experiment, 5 ml of 0.05 M NaCl and 0.05 M K_2CrO_4 solution was first added to vessel (-) with the Al-Cu specimen at 1000 s, and then added to vessel (+) with the Al specimen at 2000 s. Pitting on the Al electrode surface was effectively impeded by the addition of chromate to the Al-4%Cu electrode side, associated with a drop in potential.

There are three plausible reaction sites for chromate reduction on the surface: (a) the Al_2O_3 film, (b) flaws in the oxide film (including pitting sites), and (c) catalyzed sites. The low charge density calculated from the results in Figure 6 might deny the possibility

of the Al_2O_3 film: the specimen surface is covered with a poorly catalytic air-borne oxide film. If the reduction reaction occurs on the whole oxide film, the charge density must be much higher than, or at least be comparable to, that for the monolayer formation as described above. As shown in Figure 4, the presence of chromate hampers the propagation of metastable pitting under potentiostatic control. Thus, we consider that the reaction can occur at anodic sites, such as pits or flaws in the passive film, leading to repassivation of pits or repair of such flaws (16). It is well known that copper-rich intermetallics act as local catalyzed sites for cathodic reactions (17-19). The results presented in Figures 9(a) and 9(b) demonstrated that adding chromate to the cathodic side (Al-4%Cu electrode) is much more beneficial than adding it to the anodic side (Al electrode) in inhibiting pitting corrosion in open circuit. Most likely, the chromate reduction reaction occurs preferentially on catalyzed sites, such as the copper-rich sites in open circuit. Then, the resulting deposition of Cr(III) stifles the oxygen reduction reaction on these sites. This is regarded the primary effect for inhibiting the localized corrosion of aluminum. Since the catalyzed sites on the surface seem to be fairly finite, the effective amount of chromate ions needed for such inhibition is expected to be small, although the exact quantity is unknown.

CONCLUSIONS

Chromate was found to act as a cathodic inhibitor for aluminum in open circuit. The reduction reaction of Cr(VI) to Cr(III) is assumed to take place on catalyzed sites of the surface, and the resultant deposition of Cr(III) inhibits oxygen reduction reaction on the sites. This effect causes a significant decrease in open-circuit potential, thereby reducing pitting corrosion.

ACKNOWLEDGMENT

This work was performed under the auspices of the U.S. Department of Energy, Division of Materials Science, Office of Basic Energy Sciences under Contract No. DE-AC02-76CH00016. KS was supported by the Air Force Office of Scientific Research, contract number F49620-96-1-0479.

REFERENCES

1. H. Böhni, H.H. Uhlig, *J. Electrochem. Soc.*, **116**, 906 (1969).
2. M.A. Heine, M.J. Pryor, *J. Electrochem. Soc.*, **114**, 1001 (1967).
3. 1990 Clean Air Act Amendments, Title III, Hazardous Air Pollutants, Section 112 in Title I.
4. D.R. Arnott, B.R.W. Hinton, N.E. Ryan, *Corrosion*, **45**, 12 (1989).
5. F. Mansfeld, S. Lin, K. Kim, H. Shih, *Corros. Sci.*, **27**, 997 (1987).
6. K. Hladky, J.L. Dawson, *Corros. Sci.*, **22**, 231 (1987).
7. P.C. Searson, J.L. Dawson, *J. Electrochem. Soc.*, **135**, 1908 (1988).
8. R.A. Cottis, *Corrosion*, **57**, 265 (2001).
9. K. Sasaki, H.S. Isaacs, P.W. Levy, in *Mechanism of Al Alloy Corrosion and the Role of Chromate Inhibitors: Fourth Annual Report* (Ed. G.S. Frankel), p.99, Air Force Office of Scientific Research, Contract No. F49620-96-1-0479, (2000).

10. K. Sasaki, H.S. Isaacs, P.W. Levy, in this volume.
11. A. Sehgal, G.S. Frankel, B. Zoofan, S. Rokhlin, *J. Electrochem. Soc.*, **147**, 140 (2000).
12. M. Kendig, S. Jeanjaquet, Abstract 228, The Electrochemical Society Meeting Abstracts, Vol. 98-2, Boston, MA, Nov 1-6 1998.
13. G.O. Ilevbare, J.R. Scully, *J. Electrochem. Soc.*, **148**, B196 (2001).
14. H.H. Uhlig, R.W. Revie, *Corrosion and Corrosion Control*, Third Edition, p.108, John Wiley & Son, New York, (1984).
15. S.T. Pride, J.R. Scully, J.L. Hudson, *J. Electrochem. Soc.*, **141**, 3028 (1994).
16. C. Edeleanu, U.R. Evans, *Trans. Faraday Soc.*, **47**, 1121, (1951).
17. J.R. Galvele, S.M. de De Micheli, *Corros. Sci.*, **17**, 795 (1970).
18. M. Yasuda, F. Weinberg, D. Tromans, *J. Electrochem. Soc.*, **137**, 3708 (1990).
19. A.J. Griffin Jr., F.R. Brontzen, C.F. Dunn, *J. Electrochem. Soc.*, **139**, 699 (1992).

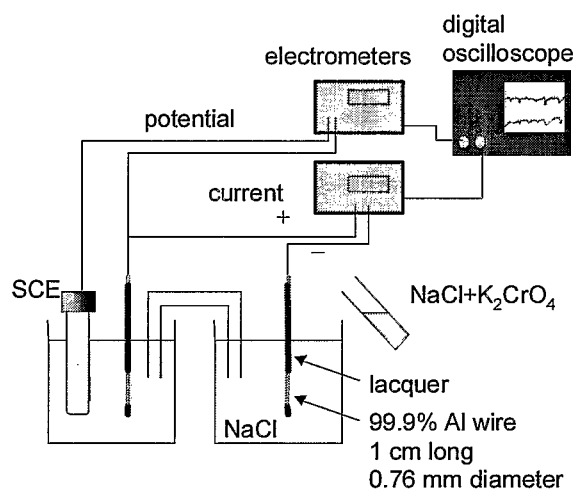

Figure 1. Schematic diagram of the electrochemical cell comprising two separate electrolyte vessels linked with a salt bridge.

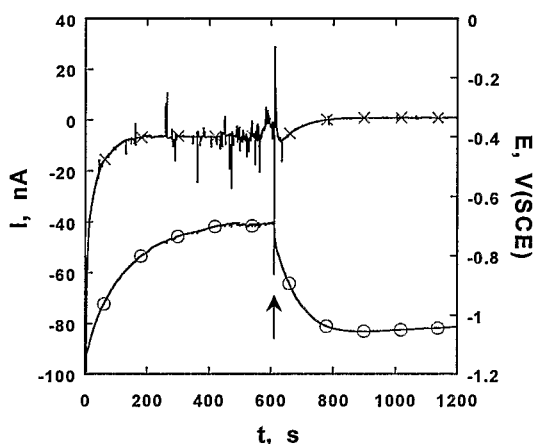

Figure 2. Current (x) and open-circuit (o) transients from coupled Al electrodes in 60 ml of a 0.05 M NaCl solution. Five ml of 0.05 M NaCl + 0.05 M K_2CrO_4 was added at 610 s. Specimen diameter: 0.76 mm. Distance between electrodes: 1.2 mm.

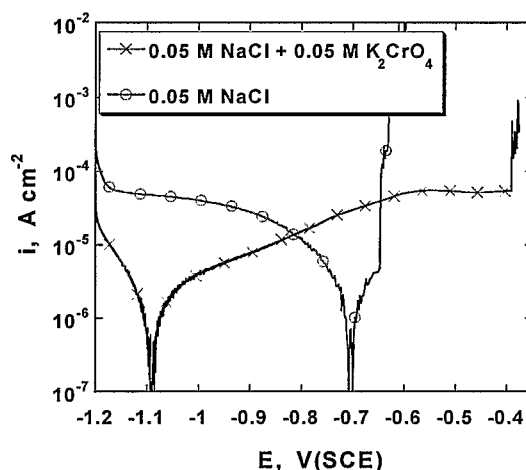

Figure 3. Potentiodynamic polarization of Al in 0.05 M NaCl + 0.05 M K_2CrO_4 (x) and 0.05 M NaCl (o) at a sweep rate of 1 mV s^{-1} .

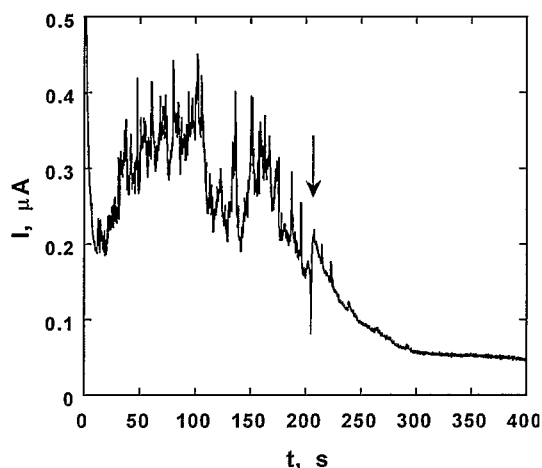

Figure 4. Potentiostatic current transient for Al electrode in 50 ml of 0.05 M NaCl at -660 mV(SCE) . At 200 s 5 ml of 0.05 M NaCl + 0.05 M K_2CrO_4 was added to the cell. Specimen diameter: 0.76 mm. Sampling rate: 10 Hz

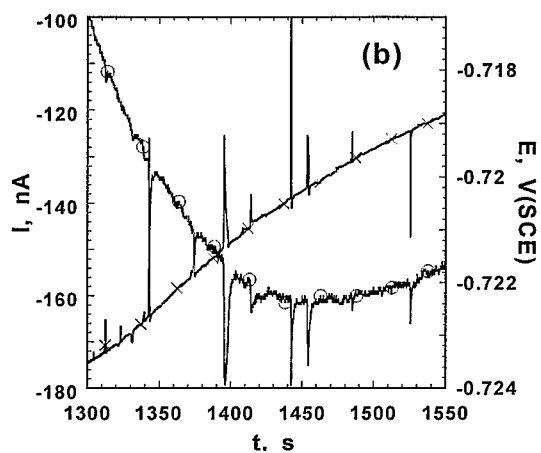
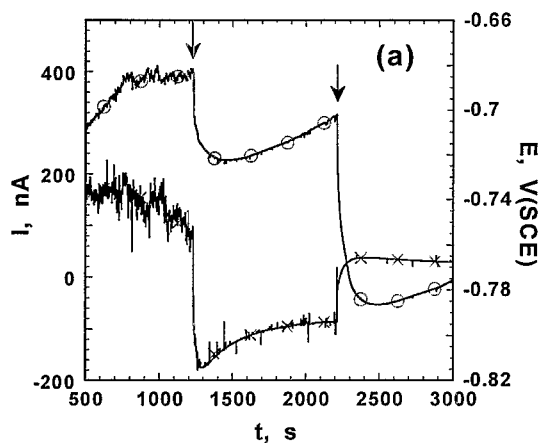

Figure 5. (a) Current (\times) and potential (\circ) transients at open circuit for two Al electrodes held in separate vessels linked with a salt bridge. Each vessel contained 50 ml of 0.05 M NaCl solution. Five ml of 0.05 M NaCl and 0.05 M K_2CrO_4 solution was added to vessel (+) and vessel (-) at 1200 s and 2200 s, respectively (designated by the arrows). Note that 5 ml of 0.05 M NaCl was also added at 740 s and 1000 s. (b) Details of current and potential after the first chromate addition at 1200 s. Specimen length and diameter: 10 mm and 0.76 mm.

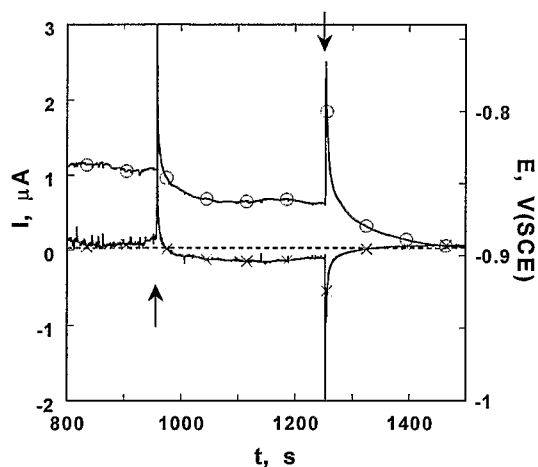

Figure 6. Current (\times) and potential (\circ) transients for two Al electrodes in separate vessels, containing 50 ml of 5 M NaCl solution. Five ml of 5 M NaCl and 5 M K_2CrO_4 solution was added to vessel (+) and vessel (-) at 956 s and 1250 s, respectively (designated by the arrows).

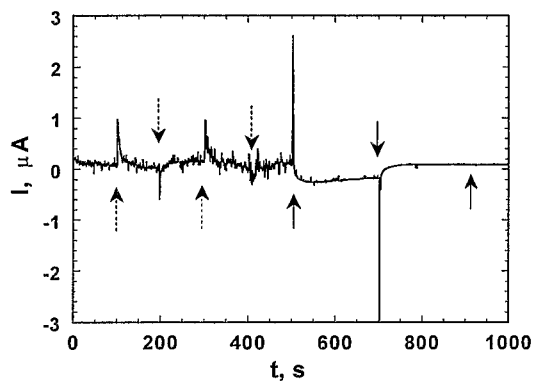

Figure 7. Current between two Al electrodes in separate vessels containing 50 ml of 5 M NaCl solution. Broken arrows denote when 5 ml of 5 M NaCl was added to vessel (+) (upward arrow) or to vessel (-) (downward arrow). Solid arrows denote when 5 ml of 5 M NaCl + 0.05 M K_2CrO_4 was added to vessel (+) (upward arrow) or to vessel (-) (downward arrow).