

21CT-001

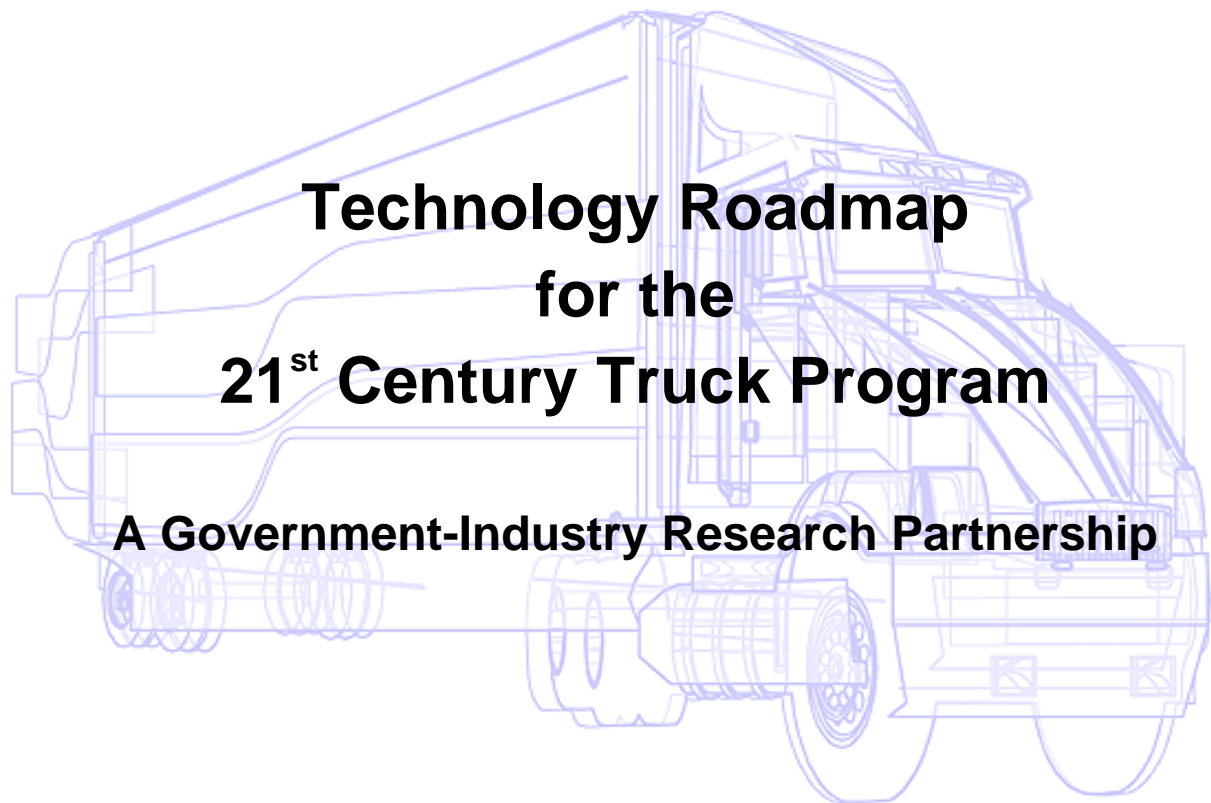

**Technology Roadmap
for the
21st Century Truck Program**

A Government-Industry Research Partnership

December 2000

This report is available via the DOE Information Bridge.
Web site <http://www.doe.gov/bridge>

This report was prepared as an account of work sponsored by an agency of the United States government. Neither the United States government nor any agency thereof, nor any of their employees, makes any warranty, express or implied, or assumes any legal liability or responsibility for the accuracy, completeness, or usefulness of any information, apparatus, product, or process disclosed, or represents that its use would not infringe privately owned rights. Reference herein to any specific commercial product, process, or service by trade name, trademark, manufacturer, or otherwise, does not necessarily constitute or imply its endorsement, recommendation, or favoring by the United States government or any agency thereof. The views and opinions of authors expressed herein do not necessarily state or reflect those of the United States government or any agency thereof.

TECHNOLOGY ROADMAP FOR THE 21st CENTURY TRUCK PROGRAM

December 2000

CONTENTS

FIGURES.....	v
TABLES	vii
ACRONYMS AND ABBREVIATIONS	ix
ACKNOWLEDGMENTS	xiii
EXECUTIVE SUMMARY	xv
1. INTRODUCTION.....	1-1
1.1 The 21 st Century Truck Program.....	1-1
1.2 Program Goals and Research Objectives	1-1
1.3 Participants in the Technical Program and Roadmap.....	1-2
2. STRATEGIC IMPORTANCE OF THE 21 st CENTURY TRUCK PROGRAM	2-1
2.1 Program Strategy.....	2-2
2.2 Benefits of a Successful Program.....	2-3
3. SELECTION OF VEHICLE PLATFORMS	3-1
3.1 Fuel Consumption by Truck Class and Truck Use Patterns.....	3-1
3.2 Representative Driving Cycles.....	3-4
4. TECHNICAL PLAN.....	4-1
4.1 Large Truck—Tractor-Trailer	4-1
4.1.1 Vehicle Efficiency	4-2
4.1.2 Emissions.....	4-13
4.1.3 Truck-Related Safety (Truck-Trailer Systems)	4-16
4.2 Transit Bus	4-20
4.2.1 Vehicle Efficiency	4-22
4.2.2 Emissions.....	4-25
4.2.3 Bus-Related Safety	4-26
4.3 Medium Truck—Enclosed, Single-Axle Delivery Truck	4-26
4.3.1 Vehicle Efficiency	4-27
4.3.2 Emissions.....	4-33
4.3.3 Truck-Related Safety (Medium Trucks).....	4-33
4.3.4 Summary of Potential Efficiency Benefits	4-34
4.4 Small Truck—“Working” Pickup (>8500 lb GVW).....	4-35
4.4.1 Vehicle Efficiency	4-35
4.4.2 Emissions.....	4-38
4.4.3 Truck Safety	4-39
4.5 Military Vehicles.....	4-39
4.5.1 The Systems Analysis Process	4-39
4.5.2 Deriving System Requirements	4-40
4.5.3 Analysis of Selected Current Military Vehicle Fuel Efficiencies.....	4-40
4.5.4 Impact of Aggressive Improvements on Military Truck Efficiencies	4-41
4.6 Crosscutting Technologies	4-45
4.6.1 Alternative Fuels	4-45
4.6.2 Internal Combustion Engine Technology.....	4-49

4.6.3	Aftertreatment.....	4-52
4.6.4	Hybrid Electric Propulsion Technologies.....	4-58
4.6.5	Mechanical Hybrid Truck Technology.....	4-71
4.6.6	Fuel Cells.....	4-77
4.6.7	Auxiliary Power.....	4-82
4.6.8	Thermal Management.....	4-86
4.6.9	Materials.....	4-87
4.6.10	More-Efficient and/or Lower-Emission Engine Systems.....	4-91
4.6.11	Vehicle Intelligence.....	4-96
4.6.12	Innovative, High-Payoff Technologies.....	4-102
5.	PROGRAM SUMMARY	5-1
5.1	Schedule and Milestones.....	5-1
6.	REFERENCES.....	6-1
APPENDIX A. CONTRIBUTORS TO THE 21 st CENTURY TRUCK PROGRAM TECHNOLOGY ROADMAP		A-1
APPENDIX B. 21 st CENTURY TRUCK PROGRAM SUBTEAMS.....		B-1
APPENDIX C. PARTICIPANTS IN THE OCTOBER 25, 2000, MEETING OF THE 21 st CENTURY TRUCK PROGRAM PARTNERSHIP COORDINATING COMMITTEE		C-1
APPENDIX D. INTERNAL COMBUSTION ENGINE TECHNOLOGY		D-1
APPENDIX E. AFTERTREATMENT/EMISSION CONTROL.....		E-1
APPENDIX F. HYBRID ELECTRIC PROPULSION TECHNOLOGIES		F-1
APPENDIX G. MECHANICAL HYBRID SYSTEMS FOR 21 st CENTURY TRUCKS.....		G-1
APPENDIX H. MORE-EFFICIENT AND/OR LOWER-EMISSION ENGINE SYSTEMS		H-1

FIGURES

2.1	The nation’s economy is linked to truck transport	2-1
2.2	Trucks account for increasing highway transportation energy use.....	2-2
2.3	1997 inventory of commercial and military trucks covered by the 21 st Century Truck Program.....	2-3
3.1	Truck types by gross vehicle weight (GVW)	3-1
3.2	Annual fuel use by commercial trucks (based on VIUS data).....	3-2
3.3	Fuel use (usual trips 100 miles or less vs greater than 100 miles)	3-3
4.1	Class 8 truck energy audit	4-2
4.2	Horsepower required to overcome aerodynamic drag and rolling friction/accessories as a function of travel speed for a typical Class 8 tractor-trailer	4-6
4.3	40-foot transit bus energy audit.....	4-20
4.4	Pathway for improving transit bus fuel economy.....	4-21
4.5	Common dry van	4-27
4.6	Typical medium truck—Class 6 enclosed van; distribution of energy requirements at 40 mph for a 26,000-lb (11,791 kg) vehicle	4-29
4.7	Friction power requirements of typical medium truck engine as a function of rpm.....	4-31
4.8	Energy balance for the HMMWV	4-41
4.9	Energy balance for the FMTV.....	4-42
4.10	Energy balance for M916A2	4-43
4.11	System-level model for efficient engine design	4-50
4.12	“Wired” integrated engine systems optimization	4-51
4.13	The combination of engine-out emissions and emission control device performance required to satisfy proposed EPA emission standards.....	4-53
4.14	Schematics for conventional and parallel mechanical hybrid vehicle designs.....	4-72
4.15	Various ways that mechanical and electrical hybrid vehicles can process and store energy	4-73
4.16	Classic and advanced diesel ideal cycles compared.....	4-92
4.17	Process for conducting vehicle research as borrowed from the Intelligent Vehicle Initiative (IVI)	4-96
4.18	Vehicle intelligence R&D plan for the 21 st Century Truck Program	4-98
F.1	Motor power for heavy-duty hybrid electric vehicles	F-3
F.2	Battery pack capacity for heavy-duty hybrid electric vehicles.....	F-5
H.1	Schematic of free-piston-powered linear alternator	H-3
H.2	Schematic of free-piston hydraulic motor	H-4
H.3	Cylinder cycle for stationary-regenerator two-stroke sleeve-valve engine	H-4

TABLES

3.1	Representative truck models.....	3-3
4.1	Energy audit and potential fuel efficiency improvements for line-haul trucks	4-3
4.2	Engine efficiency projections	4-4
4.3	Energy audit and potential fuel efficiency improvements for 40-ft transit bus	4-21
4.4	Preliminary performance requirements for the 21 st Century Truck Program (Class 7) transit bus	4-23
4.5	Summary of technical targets and barriers for transit bus emissions	4-26
4.6	Mission information for typical Class 6 vehicles	4-28
4.7	Typical medium truck—Class 6 enclosed van distribution of energy requirements for a fully loaded 26,000 lb (11,791 kg) enclosed van at 40 mph	4-30
4.8	Medium truck power requirements [Class 6, 26,000 lb (11,791 kg) max GVW]	4-32
4.9	Design metrics for current and improved Class 6 medium trucks.....	4-34
4.10	Potential for fuel-efficiency improvements for medium trucks	4-34
4.11	Distribution of energy requirements (kWh) for a typical small truck (Class 2b commercial pickup), EPA combined driving cycle.....	4-36
4.12	Summary of technical targets and barriers for Class 2b truck emissions	4-39
4.13	HMMWV M1097 A2 specifications	4-40
4.14	2.5-ton FMTV M1078 specifications	4-42
4.15	M916A2 specifications.....	4-43
4.16	Summary of technical targets and barriers for natural gas transit buses	4-47
4.17	Comparison of energy-storage options.....	4-62
4.18	Summary of current performance and technical targets for batteries.....	4-63
4.19	Efficiencies of diesel mechanical hybrid Class 2b trucks (small)	4-74
4.20	Efficiencies of diesel mechanical hybrid Class 6 trucks (medium).....	4-75
4.21	Truck auxiliary power requirements.....	4-83
4.22	Air brake compressor power requirements.....	4-84
4.23	Estimates of air-conditioning compressor power requirements	4-84
4.24	Alternator power requirements for day and night constant-load operation	4-84
5.1	21 st Century Truck schedule and milestones	5-1
F.1	Type of energy storage used in heavy-duty hybrid electric vehicle projects.....	F-5
F.2	Hazard risk categories	F-8

ACRONYMS AND ABBREVIATIONS

A/C	air conditioning
ABS	anti-lock brake system
AC	alternating current
ADVISOR	Advanced Vehicle Simulator
AFC	alkaline fuel cell
ANL	Argonne National Laboratory
ANOVA	analysis of variance
APTA	American Public Transportation Association
APU	auxiliary power unit
BBW	brake-by-wire
BEA	boundary element analysis
BMEP	brake mean effective pressure
BOI	beginning of injection
BSFC	brake-specific fuel consumption
CAN	Communication Area Network
CARAT	Cooperative Automotive Research for Advanced Technologies
CARB	California Air Resource Board
CB-DPF	catalyst-based diesel particle filters
CBD	central business district
CDPF	catalytic diesel particle filter
CFD	computational fluid dynamics
CI	compression ignition
CNG	compressed natural gas
CR-DPF	continuously regenerating-diesel particle filter
CVT	continuously variable transmission
Cyl	cylinder
DARPA	Defense Advanced Research Projects Agency
DC	direct current
DECSE	Diesel Emission Control Sulfur Effects
DOC	diesel oxidation catalyst
DOC	U.S. Department of Commerce
DOD	U.S. Department of Defense
DOE	U.S. Department of Energy
DOT	U.S. Department of Transportation
DPF	diesel particle filter
DVECSE	Diesel Vehicle Emission Control Sulfur Effects
EGR	exhaust gas recirculation
EMA	Engine Manufacturers Association
EMI	electromagnetic interference
EPA	U.S. Environmental Protection Agency
ESR	equivalent series resistance
EV	electric vehicle
FHWA	Federal Highway Administration
FTA	Federal Transit Administration
FUDS	Federal Urban Driving Schedule
GDP	gross domestic product
GM	General Motors Corporation
GPS	global positioning system
GTO	gate-turnoff thyristor
GVW	gross vehicle weight

GVWR	gross vehicle weight rating
HC	hydrocarbon
HC SCR	hydrocarbon selective catalytic reduction
HCCI	homogenous charge compression ignition
HDE	heavy-duty engine
HEV	hybrid electric vehicle
HVAC	heating, ventilation, and air conditioning
HWFET	Highway Fuel Economy Test
IC	internal combustion
IFC	International Fuel Cells
IGBT	insulated-gate bipolar transistor
IITRI	IIT Research Institute
ISE	ISE Research Corporation
IVI	Intelligent Vehicle Initiative
LE55	Low Emission, 55% Efficient
LNG	liquefied natural gas
MCFC	molten carbonate fuel cell
MCT	MOS-controlled thyristor
MECA	Manufacturers of Emission Controls Association
MOS	metal-oxide semiconductor
MOSFET	metal-oxide semiconductor field effect transistor
NASA	National Aeronautics and Space Administration
NFESC	Naval Facilities Engineering Service Center
NG	natural gas
NiCad	nickel cadmium
NiMH	nickel-metal hydride
NIST	National Institute of Standards and Technology
NMHC	non-methane hydrocarbons
NREL	National Renewable Energy Laboratory
NVH	noise-vibration-harshness
OBD	on-board diagnostics
OHVT	Office of Heavy Vehicle Technologies
OMB	Office of Management and Budget
ORNL	Oak Ridge National Laboratory
OSTP	Office of Science and Technology Policy
PACCAR	PACCAR, Inc., formerly Pacific Car and Foundry
PAFC	phosphoric acid fuel cell
PCC	Partnership Coordinating Committee
PEBB	power electronics building block
PEM	proton exchange membrane
PEMFC	proton exchange membrane fuel cell
PM	particulate matter
PNGV	Partnership for a New Generation of Vehicles
PNNL	Pacific Northwest National Laboratory
PSAP	Public Safety Answering Point
PWM	pulse-width modulation
R&D	research and development
SAE	Society of Automotive Engineers
SCCI	stratified charge compression ignition
SCR	selective catalytic reduction
SEA	statistical energy analysis
SI	spark ignition
SNL	Sandia National Laboratories

SOC	state of charge
SOFC	solid oxide fuel cells
SOP	statement of principles
STICK	Stimulate Trucking Innovative Concepts and Knowledge
SUV	sport utility vehicle
SwRI	Southwest Research Institute
TACOM	Tank-Automotive and Armaments Command
TBD	to be determined
TMA	Truck Manufacturers Association
TWC	three-way catalytic
U.S.	United States
VDC	vehicle dynamic control
VGT	variable geometry turbocharger
VIUS	Vehicle Inventory and Use Survey
VVA	variable valve actuation

Chemical compounds

CO	carbon monoxide	NO	nitric oxide
CO ₂	carbon dioxide	NO ₂	nitrogen dioxide
CO(NH ₂) ₂	urea	NO _x	nitrogen oxide
H ₂	hydrogen		

Units of measure

A _f	frontal area	kWh	kilowatt hour
°C	degrees celsius	l	liter
°F	degrees fahrenheit	lb	pound
A	ampere	m	meter
avg	average	m ²	square meter
bhp	brake horse power	max	maximum
Btu	British thermal unit	min	minimum, minute
C _d	drag coefficient	MPa	megapascals
C _{rr}	rolling resistance coefficient	mph	miles per hour
fhp	frictional horsepower	ms	millisecond
ft	foot	Nm	newton-meter
g	gram	Pa	pascal
g/bhp-h	grams per brake-horsepower hour	ppm	parts per million
g/mi	grams per mile	psi	pounds per square inch
gal	gallon	rms	root mean square
h	hour	rpm	revolutions per minute
hp	horsepower	s	second
hph	horsepower hour	V	volt
I ² R	watt	VAC	volts alternating current
kg	kilogram	VDC	volts direct current
kHz	kilohertz	W/kg	watts per kilogram
km	kilometer	W/l	watts per liter
kW	kilowatt	Wh/l	watt-hour per liter
		Wh/kg	watt-hour per kilogram

ACKNOWLEDGMENTS

This *Technology Roadmap for the 21st Century Truck Program* is the product of the tireless effort of many people during the past six months. If I were to attempt to mention the names of all those who contributed to the Roadmap through participation in meetings or teleconferences, by writing or contributing text to its various sections, or by reviewing and providing constructive comments on its successive drafts, I would violate one of the rules that we established when we began—to keep it short. I would be remiss, however, if I did not express my personal appreciation to all the members of the Roadmap Team, whose names are provided in Appendix A, for their cooperation, support, and enlightening comments during meetings and for their individual contributions to this report.

Special thanks go to the following team members, who chaired the Roadmap subteams and/or who served as principal authors of the section(s) for which their subteam was responsible:

John Woodrooffe, *consultant to TMA*
Bill Siegel, *U.S. DOT*
Tom Biro, *International Truck and Engine Co.*
Charles Roehm, *ANL*
Ron York, *GM*
Steve Zimmer, *DaimlerChrysler*
Scott McBroom, *SwRI*
Pat Dessert, *Oakland University*
Nabil Hakim, *Detroit Diesel*
Ron Graves, *ORNL*
Keith Vertin, *NREL*
John Kargul, *U.S. EPA*
Shang Hsiung, *U.S. DOT*
Jud Virden, *PNNL*
John Hull, *ANL*
Bill Corwin, *ORNL*
John Clarke, *Caterpillar*
Ray Resendes, *U.S. DOT*

Each subteam chair was supported by subteams members, whose names are provided in Appendix B, and by numerous colleagues in their own organizations, who, unfortunately, are not named here.

The Roadmap Team is indebted to Dan Santini and his colleagues from ANL, who worked nights and weekends in the early stages of the Roadmap process to provide the analyses of fuel use by truck categories that led to the selection of the truck platforms to be addressed in the 21st Century Truck Program. I particularly want to thank René Abarcar, of Energetics, Inc., for his major contribution in writing Sections 1 through 3, and Pat Flaherty, of DaimlerChrysler and SAE Fellow at DOE, for her insightful comments at many junctures of the roadmapping process.

Several of my colleagues at ORNL played visible or invisible roles in the preparation of this Roadmap. David O’Kain, Bill Corwin, Ron Graves, and Bill Knee were members of the Roadmap Team; they also served as a sounding board and kept me headed in the right direction. Dick Ziegler, Ray Johnson, Phil Sklad, and Arvid Pasto helped behind the scenes by reviewing early drafts and by pointing out where additional work was needed. My secretary, Pam Wenzel, made a major contribution to the entire Roadmap process through her organizational skills in arranging meetings, her persistence in working with team members to obtain the text of this document, and her tireless efforts in reviewing the several drafts of the report for completeness, consistency, and accuracy. The ORNL Creative Media Solutions group

provided editing, electronic publishing, graphics, library, and reproduction services and worked whenever needed to keep this report on schedule.

Finally, I want to thank the senior executives of the companies and of the federal agencies that have supported the preparation of this Roadmap. Many of these, but I'm sure not all, are listed in Appendix C. I particularly want to thank Dr. James Eberhardt and Mr. Thomas Gross for giving me the opportunity to lead the development of the *Technology Roadmap for the 21st Century Truck Program* and for their support throughout this process.

Ron Bradley
Oak Ridge, Tennessee
December 2000

EXECUTIVE SUMMARY

The 21st Century Truck Program will support the development and implementation of commercially viable technologies that will dramatically cut fuel use and emissions of commercial trucks and buses while enhancing their safety and affordability as well as maintaining or enhancing performance. The innovations resulting from this program will reduce dependence on foreign oil, improve our nation's air quality, provide advanced technology for military vehicles, and enhance the competitiveness of the U.S. truck and bus industry while ensuring safe and affordable freight and bus transportation for the nation's economy.

The 21st Century Truck Program was announced on April 21, 2000, in Romulus, Michigan, at a gathering of U.S. truck and supporting industries, concerned environmentalists, and federal agency representatives. The program's goals and research objectives are to

- improve fuel efficiency,
- reduce emissions,
- enhance safety,
- reduce total owning and operating costs, and
- maintain or enhance performance.

Making progress in each of these goals simultaneously is a major challenge. The federal government and the trucking and supporting industries will work actively together to develop a balanced portfolio of research aimed at achieving all these goals, coordinate their research activities as appropriate, and make effective use of the nation's research universities and national laboratories. Proprietary research agreements between individual companies and federal agencies, which cannot be shared with industrial competitors, will continue to be appropriately funded.

This research partnership will support research aimed at developing production prototype vehicles that achieve all of the following objectives:

- Improve fuel efficiency of heavy-duty trucks and buses, specifically, by 2010
 - double the Class 8 line-haul truck fuel efficiency on a ton-miles-per-gallon basis,
 - triple the Class 2b and 6 truck (delivery van) fuel efficiency on a ton-miles-per-gallon basis, and
 - triple the fuel efficiency of heavy-duty transit buses on a miles-per-gallon basis.
- Reduce emissions:
 - throughout the Program, meet prevailing standards for oxides of nitrogen, particulate matter, carbon monoxide, and hydrocarbons.
- Enhance safety:
 - In 1998, truck-related crashes resulted in 5,374 fatalities and 127,000 injuries. The U.S. Department of Transportation is committed to reducing truck-related fatalities by 50% by 2010. The 21st Century Truck program will contribute to the goal of improving truck and bus safety by fostering advancements in vehicle design and performance.
- Enhance affordability:
 - maintain or enhance performance.

A central goal of this initiative is to develop cost-effective, heavy-duty vehicles for truck operators that are fully competitive in prevailing markets.

A strong partnership between the United States truck and bus industry and their supporting industries and the federal government has been formed to conduct the 21st Century Truck Program. The government and industry partners are committed to cooperatively coordinate the needed research and development and share its costs.

The partnership's federal component is led by the U.S. Department of Energy in cooperation with the Office of Science and Technology Policy and the Office of Management and Budget. Other participating federal agencies are the U.S. Department of Transportation, the U.S. Department of Defense (represented by the Army), and the U.S. Environmental Protection Agency. The federal government brings to the table its resources for research and development, including the capabilities resident in government laboratories.

The industrial participants of the partnership are truck and bus manufacturers, their suppliers, and their trade associations, including

Allison Transmission	Eaton	NovaBus
BAE SYSTEMS Controls	Freightliner	Oshkosh Trucks
Caterpillar	General Motors	PACCAR
Cummins Engine	Honeywell International	Volvo Trucks North America
DaimlerChrysler	International Truck & Engine	Engine Manufacturers Association
Detroit Diesel	Mack Trucks	Truck Manufacturers Association

In addition to their contributions to the research and development required to meet the program's goals, the industrial participants will ensure that the technology developed will be pertinent to the needs of the trucking industry and its customers, thereby guaranteeing its widespread incorporation into the marketplace.

On October 25, 2000, the first meeting of the government-industry Partnership Coordinating Committee (PCC) was held. At that meeting, agreements were reached concerning the PCC's membership and operating approach. This meeting cemented the partners' relationship and established the overall technical direction of the program.

To guide the development of the technical advancements that will enable needed improvements in commercial truck fuel economy, emissions, and safety, the current *Technology Roadmap for the 21st Century Truck Program* has been drafted. The three types of trucks that use the greatest portion of fuel were identified and, along with transit buses and military vehicles, were examined to define the greatest needs and opportunities for the improvements needed to meet the goals of the program. Based on the analysis of those vehicles, the program goals and technical targets were established.

Vehicle	Fuel efficiency multiplier	
	Technical target	Program goal
Large truck	1.6	2
Transit bus	2.6	3
Medium truck	2.4	3
Small truck, >8500 lb	1.5–1.75	3

The technical targets represent aggressive development and implementation of technologies currently being considered but not yet commercially viable. The technical target shown in the table for the large truck does not yet include gains believed to be available from vehicle weight reduction and information technologies.

The goals described are long-term stretch goals for which technology breakthroughs will be required.

These program goals and research objectives are aggressive, and there is no certainty that they can be achieved. Fully aware of the magnitude of the challenge and the importance of meeting the partnership's objectives, the parties commit their best efforts to the achievement of the goals.

Accordingly, the PCC endorsed the approach described within this Roadmap and agreed to jointly undertake such actions as are needed to meet the goals of the 21st Century Truck Program.

1. INTRODUCTION

1.1 THE 21st CENTURY TRUCK PROGRAM

The 21st Century Truck Program is a partnership between the U.S. truck and bus industry and its supporting industries and the federal government for research and development (R&D) of commercially viable technologies that will dramatically cut the fuel use and emissions of commercial trucks and buses while enhancing their safety and affordability and maintaining or enhancing performance. The innovations resulting from this partnership will reduce U.S. dependence on foreign oil, improve our nation's air quality, provide advanced technology for military vehicles, and enhance the competitiveness of the U.S. truck and bus industry while ensuring safe and affordable freight and bus transportation to benefit the nation's economy.

The Program was announced on April 21, 2000, in Romulus, Michigan, at a gathering of the U.S. trucking and supporting industries, concerned environmentalists, and federal agency representatives.

1.2 PROGRAM GOALS AND RESEARCH OBJECTIVES

The program goals and research objectives of the 21st Century Truck Program are to develop and demonstrate commercially viable technologies to

- improve fuel efficiency,
- reduce emissions,
- enhance safety,
- reduce total owning and operating costs, and
- maintain or enhance performance.

Making progress in each of these goals simultaneously is a major challenge. The federal government and the trucking and supporting industries will work actively together to develop a balanced portfolio of research aimed at achieving all these goals, coordinate their research activities as appropriate, and make effective use of the nation's research universities and national laboratories. Proprietary research agreements between individual companies and federal agencies, which cannot be shared with industrial competitors, will continue to be appropriately funded.

This research partnership will support research aimed at developing production prototype vehicles that achieve all of the following objectives:

- Improve fuel efficiency of heavy-duty trucks and buses, specifically, by 2010
 - double the Class 8 line-haul truck fuel efficiency on a ton-miles-per-gallon basis,
 - triple the Class 2b and 6 truck (delivery van) fuel efficiency on a ton-miles-per-gallon basis, and
 - triple the fuel efficiency of heavy-duty transit buses on a miles-per-gallon basis.
- Reduce emissions:
 - throughout the Program, meet prevailing standards for oxides of nitrogen, particulate matter, carbon monoxide, and hydrocarbons.
- Enhance safety:
 - In 1998, truck-related crashes resulted in 5,374 fatalities and 127,000 injuries. The U.S. Department of Transportation (DOT) is committed to reducing truck-related fatalities by 50% by 2010. The 21st Century Truck program will contribute to the goal of improving truck and bus safety by fostering advancements in vehicle design and performance.
- Enhance affordability:
 - maintain or enhance performance.

A central goal of this initiative is to develop cost-effective, heavy-duty vehicles for truck operators that are fully competitive in prevailing markets.

These program goals and research objectives are aggressive, and there is no certainty that they can be achieved. Fully aware of the magnitude of the challenge and the importance of meeting the partnership's objectives, the parties commit their best efforts to the achievement of the goals.

The federal government will promote the introduction of innovative truck technologies developed in the initiative through its own purchases of these trucks and buses and encourage state government and other purchasers to take similar actions.

1.3 PARTICIPANTS IN THE TECHNICAL PROGRAM AND ROADMAP

Development of the advanced technology needed to achieve the ambitious goals of the 21st Century Truck Program will require a "teaming" effort among truck and bus manufacturers, their suppliers, federal and private research laboratories, and universities.

The partnership's federal component is led by the U.S. Department of Energy (DOE) in coordination with the Office of Science and Technology Policy (OSTP) and the Office of Management and Budget (OMB). Other federal agencies involved are DOT; the U.S. Department of Defense (DOD), represented by the Army; and the U.S. Environmental Protection Agency (EPA). The federal government brings to the table R&D resources, including the capabilities resident in government laboratories. Government and industry will coordinate R&D and share the costs. University participation also will be encouraged.

This *21st Century Truck Program Technology Roadmap* describes the R&D needed to achieve the vision of tomorrow's cleaner, safer, and more efficient trucks and buses. The Technology Roadmap was prepared by a team of government and industry engineers and scientists who met in Chicago, Seattle, San Diego, and Washington D.C., during the period from July through October 2000. The members of the Roadmap Team are shown in Appendix A.

The Technology Roadmap is organized by vehicle platform (large, medium, and small trucks, transit buses, and military vehicles) and by crosscutting technologies that are expected to be applicable to more than one vehicle platform. Subteams of engineers and scientists conferred by telephone and e-mail to establish the goals and technical targets for each vehicle platform and crosscutting technology and to prepare the written text for the Technology Roadmap. Members of the subteams are shown in Appendix B. Those who participated in, or were invited to, the October 25, 2000, meeting of the 21st Century Truck Partnership Coordinating Committee are shown in Appendix C. The Technology Roadmap was reviewed and discussed at this meeting and those in attendance endorsed its direction.

Two drafts of the Technology Roadmap were distributed to the Roadmap Team and other representatives of the industry and government participants in the 21st Century Truck Program for their review and comment, the first in early October 2000 and the second in early November 2000. Comments received on both those drafts have been addressed in this current version of the Roadmap. It is expected that the Technology Roadmap is a "living document" and will be revised as new technologies evolve and programmatic imperatives change.

2. STRATEGIC IMPORTANCE OF THE 21st CENTURY TRUCK PROGRAM

The vision of the 21st Century Truck Program as shared by industry and government the as follows:

A productive, innovative U.S. trucking and supporting industry is essential for the economic prosperity of every American business. Innovation is also needed to ensure that truck and bus manufacturers and suppliers located in the U.S. remain competitive in world markets and continue to provide rewarding employment opportunities for large numbers of Americans. U.S. manufacturing facilities face stiff worldwide competition. New truck and bus technologies will help truck and bus owners and operators and their customers cut fuel and operating costs and increase safety. The Department of Defense, a major owner and operator of trucks, would share these gains and also benefit from reduced logistics costs associated with transporting fuel during operations. The truck and bus manufacturing and supporting industries face a range of new challenges: increasingly stringent emissions standards, new concerns about the threat of global warming, concerns about U.S. fuel supplies, increased expectations about safety, and more. The truck and bus industry's future depends on its ability to produce affordable, high-quality, safe, environmentally sensitive products.

The new challenges can be met best if government, industry, and universities work together to develop an improved generation of commercial trucks and buses for our nation's commercial and military truck fleet.

Trucks are the mainstay for trade, commerce, and economic growth in the United States. The gross domestic product (GDP) of the United States, and hence the country's economic activity, is strongly related to freight transport (see Fig. 2.1). It is estimated that currently as much as 80% of the total quantity of goods is transported by trucks; therefore, meeting truck transport energy demands for movement of goods and for services is critical to the economy.

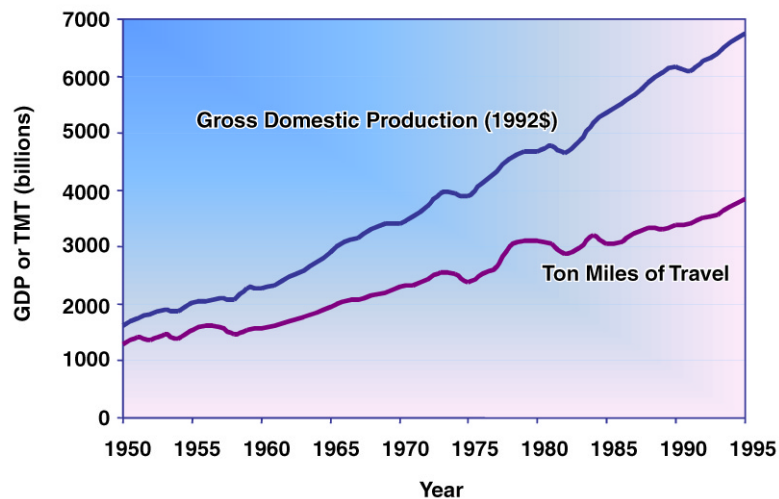

Fig. 2.1. The nation's economy is linked to truck transport.
Source: Argonne National Laboratory.

Within the U.S. transportation sector, truck energy use has been increasing at a faster rate than that of automobiles. Since the 1973 oil embargo, all of the increase in highway transportation fuel use has been due to trucks (see Fig. 2.2), mainly because of their extensive use in trade and commerce and in providing essential services. In recent years, another contributor to the increasing highway transportation energy use has been the popularity for personal use of low-fuel-economy pickup trucks, vans, and sport utility

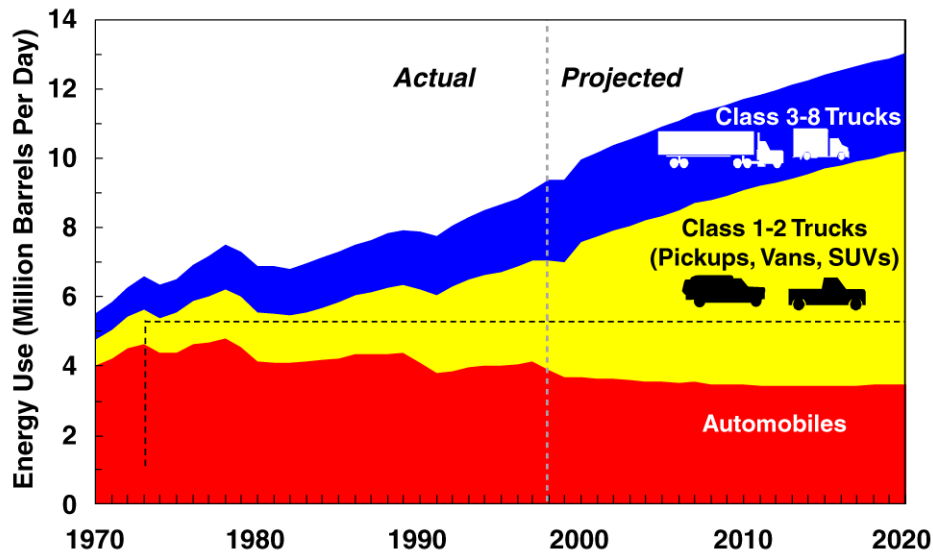

Fig. 2.2. Trucks account for increasing highway transportation energy use.
 Sources: EIA. 1999. *EIA Annual Energy Outlook 2000*, DOE/EIA-0383 (2000), December 1999. Davis, Stacy C. 1999. *Transportation Energy Data Book: Edition 19*, DOE/ORNL-6958, September 1999.

vehicles (SUVs). Only the light trucks with gross vehicle weight (GVW) of greater than 8500 lb (Class 2b) used for commercial purposes are included within the scope of the 21st Century Truck Program.

The 1997 *Vehicle Inventory and Use Survey* (DOC 1999) reports that there are as many as 68 million light trucks [Class 1 and 2 trucks up to 10,000 lb (4,535 kg) in GVW], almost 3 million medium trucks [Class 3–6 trucks between 10,001 and 26,000 lb (11,791 kg) GVW], and about 2.5 million heavy trucks [Class 7–8 trucks between 26,001 and 130,000 lb (56,550 kg) GVW] registered in the United States. About 21 million of these trucks are registered for commercial use. There are about 9 million Class 2b trucks [8,501 to 10,000 lb (4,535 kg) GVW] included in this 21st Century Truck Program, as well as the 5.5 million Class 3–8 trucks. Also included are the 246,000 tactical wheeled military trucks [DOD/Army Tank Automotive and Armament Command (TACOM)] that constitute the logistical backbone of the Army. The truck populations covered by the 21st Century Truck Program and their respective levels of energy consumption are shown in Fig. 2.3.

Wartime operation is expected to increase military truck energy demands to sustain a military force on the battlefield. It is estimated that military operation at the same level experienced during World War II could potentially contribute as much as 6% to total commercial and military truck energy use. The 21st Century Truck program will strengthen our national security by dramatically reducing operational support costs and increasing combat effectiveness through a lighter, more mobile military force resulting from rapid integration of advanced, commercially viable technologies into military trucks.

2.1 PROGRAM STRATEGY

Government and industry will coordinate R&D efforts and will share costs. The federal agencies will build on existing research and will assign high priority to major new research identified in this technology roadmap. DOE has been assigned to lead the federal R&D component of this program because of the close alignment of the stated 21st Century Truck Program goals and research objectives with DOE's mission "to foster a secure and reliable energy system that is environmentally and economically sustainable...." Since early 1996, DOE's Office of Transportation Technologies, in collaboration with

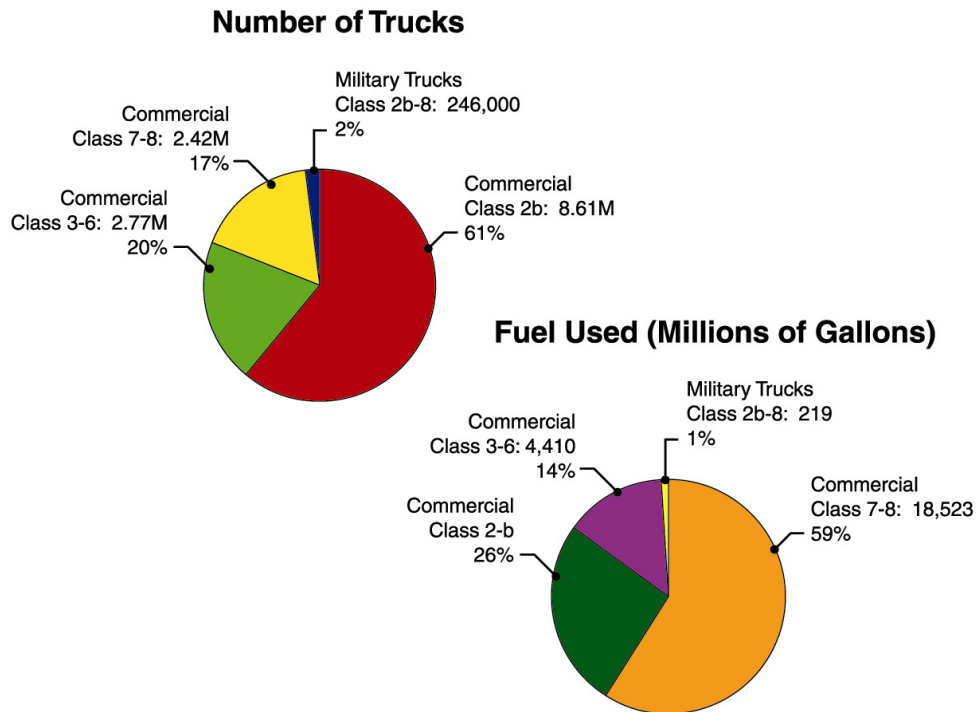

Fig. 2.3. 1997 inventory of commercial and military trucks covered by the 21st Century Truck Program. *Source:* Commercial Trucks: U.S. DOC, Bureau of Census, 1997 *Vehicle Inventory and Use Survey*, January 2000. Military Trucks: DOD/TACOM.

trucking industry partners and their suppliers, has been funding and conducting a customer-focused program to research and develop technologies that will enable trucks and other heavy vehicles to be more energy-efficient and able to use alternative fuels while simultaneously reducing emissions. DOT brings to this program its mission-oriented intelligent transportation systems and highway transportation safety programs. DOD, as a major owner and operator of trucks, will define the military mission performance requirements and will fund appropriate dual-use and military-specific technologies so that national security will benefit by innovations resulting from this Program. R&D will be closely coordinated with EPA so that critical vehicle emissions control breakthroughs cost-effectively address the increasingly stringent future EPA standards needed to improve the nation's air quality.

Industry will move research achievements into production vehicles rapidly when their commercial viability has been demonstrated. The partnership will work closely with fuel producers to accelerate the development and production of new fuels required by new engine designs to meet the program goals.

2.2 BENEFITS OF A SUCCESSFUL PROGRAM

A successful 21st Century Truck Program will enable the trucking and bus industry and its supporting industries to face new challenges, specifically, increasingly stringent emissions standards, concerns about the threat of global climate change, concerns about U.S. fuel supplies, and increased expectations regarding highway safety. These new challenges will be addressed as government and industry R&D teams work together to develop improved technology for our nation's commercial and military truck fleet. Major advances and breakthroughs are expected toward achievement of the goals set to achieve cleaner, safer, and more efficient trucks and buses.

Over the past 8 to 10 years, typically about 10 to 12% of the total fatalities from vehicle crashes have involved medium and heavy trucks. In 1998, truck-related crashes resulted in 5,374 fatalities and 127,000 injuries. The majority of those killed were occupants of other motor vehicles. Most fatal crashes occurred on rural roads and involved tractor-trailers, the most common large truck configuration. DOT is committed to reducing truck-related fatalities by 50% by 2010. It is expected that the technology developed through the 21st Century Truck Program will contribute significantly to meeting this goal.

The Program will also strengthen U.S. national security by dramatically reducing operational support costs and increasing the combat effectiveness of military vehicles. Fuel cost for the Army, as a major owner and operator of military trucks, is more than 20% of the cost of operating and maintaining its truck fleet. In addition, more than 70% of the bulk tonnage needed to sustain the Army during a conflict is fuel. As the Army transforms itself into a lighter, more mobile force, the rapid introduction of advanced, commercially viable technologies into military trucks is vital in reducing the logistics cost associated with transporting fuels during wartime operation.

3. SELECTION OF VEHICLE PLATFORMS

One of the expected outcomes of the 21st Century Truck Program is a reduction in U.S. dependence on imported oil. Focusing the R&D on technologies applicable to those trucks that use most of the fuel will have the biggest impact on oil imports. To identify the trucks that use most of the fuel, the Vehicle Inventory and Use Survey (VIUS) data collected in the 1997 economic census were examined (DOC 1999, DOC 2000).

Trucks are classified by GVW into the eight truck classes shown in Fig. 3.1.

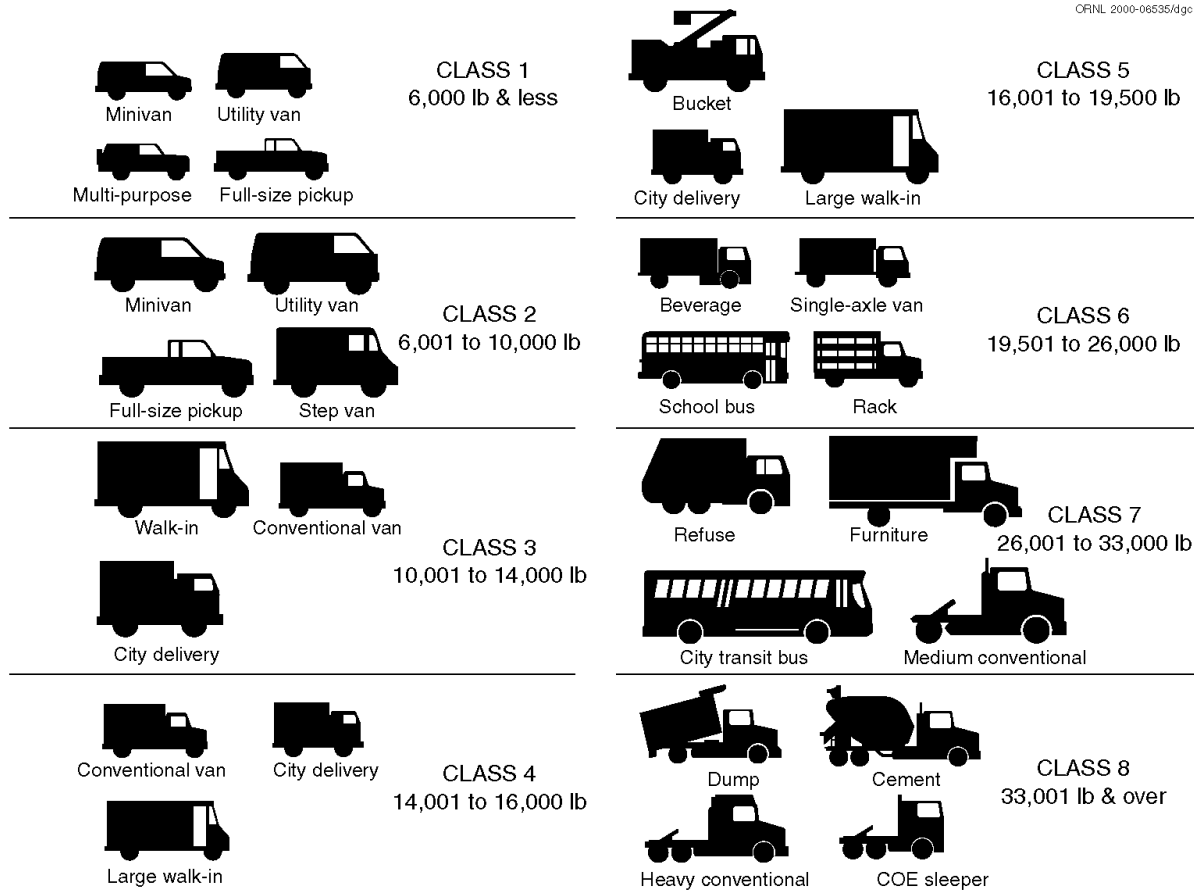

Fig. 3.1. Truck types by gross vehicle weight (GVW). Source: *Commercial Carrier Journal* (<http://www.ccmagazine.com>).

3.1 FUEL CONSUMPTION BY TRUCK CLASS AND TRUCK USE PATTERNS

Estimates of fuel use by commercial trucks, by GVW class, as determined from the VIUS data base, are shown in Fig. 3.2. These estimates have been cross-checked against U.S. DOT estimates (FHWA 1998). The truck weight class is based on the owner’s registered GVW, which for a small minority of owners could be higher than the manufacturer’s GVW rating. Of the Class 2 trucks, only those with GVW greater than 8500 lb (Class 2b) are included in the 21st Century Truck Program. Because the VIUS data base does not separate Class 2b trucks from other Class 2 trucks, the engine size was used to estimate the number of Class 2b trucks and their fuel use. Based on Truck Index data (Truck Index 1994–1997), all Class 2 trucks

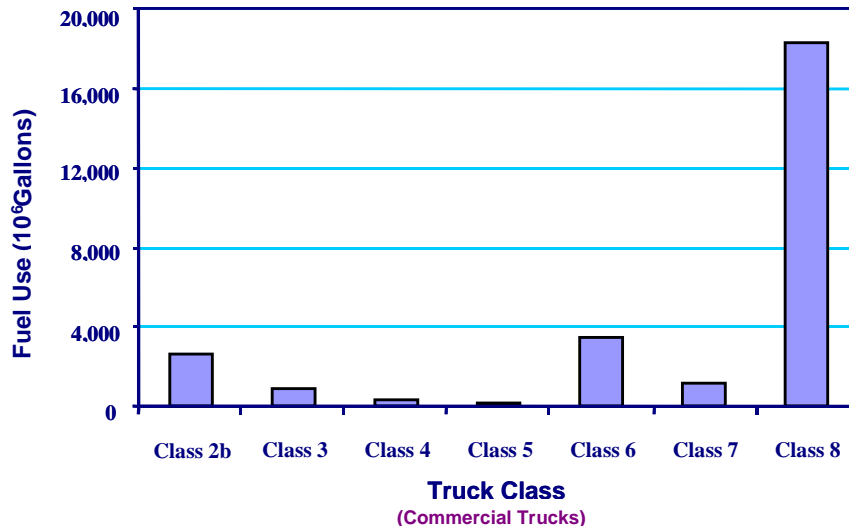

Fig. 3.2. Annual fuel use by commercial trucks (based on VIUS data).

with gasoline engines larger than 5.9 liters and all commercial-use Class 2 diesel trucks are assumed to be Class 2b.

Figure 3.2 shows that the fuel used by Class 8 trucks, 18 billion gallons per year, far exceeds that used by commercial trucks in any other weight class. Class 6 and Class 2b have the next largest fuel consumption. These three classes, 2b, 6, and 8, were selected as the focus for technology development to meet fuel efficiency goals of the 21st Century Truck Program and are referred to as small (Class 2b), medium (Class 6), and large (Class 8) trucks in this roadmap.

The VIUS data base provides data on the percentage of time that respondents' trucks are used for trips in the following categories:

- off-road (minimal use of public roads),
- less than 51 miles,
- 51–100 miles,
- 101–200 miles,
- 201–500 miles, and
- greater than 500 miles.

Trips of greater than 100 miles are very likely to be trips that involve interstate driving outside of major metropolitan areas. Trips of less than 51 miles are likely to be in urban driving, while trips from 51 to 100 miles may sometimes involve both interstate and intrastate travel, but would often involve extensive driving within urban areas.

Figure 3.3 shows a comparison of fuel use among Class 2b, Class 6, and Class 8 trucks, with the latter subdivided into those with trips of less than 100 miles and those with trips of greater than 100 miles. Of the Class 8 trucks, those with trips of greater than 100 miles use the most fuel. Most of the Class 8 trucks used for trips of 100 miles or less are vocational and urban trucks. Medium and light trucks are used mostly for trips of less than 100 miles and mostly in urban and suburban areas.

Further analysis of VIUS data showed that of the Class 2b vehicles, pickup trucks consume by far the most fuel. The next largest fuel consumers of Class 2b trucks are the panel, multi-stop, and step vans, at

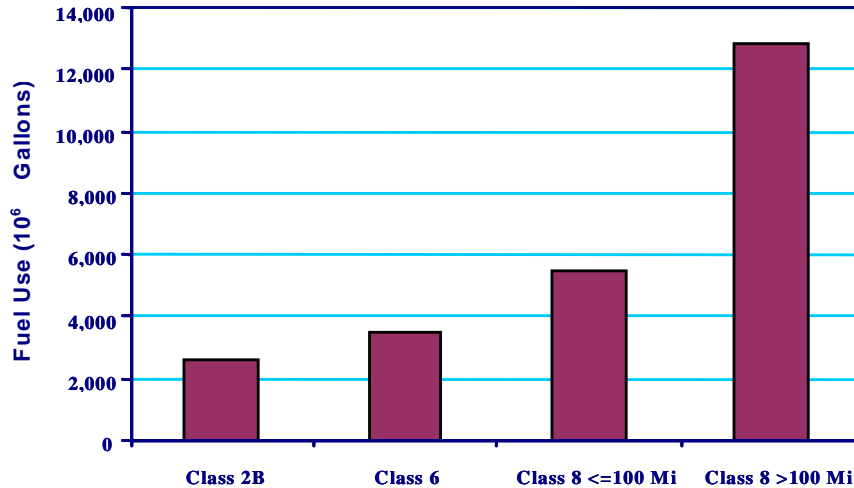

Fig. 3.3. Fuel use (usual trips 100 miles or less vs greater than 100 miles).

about one-fourth the fuel consumption of pickup trucks. The pickup truck is, therefore, selected as representative of Class 2b trucks.

Of the Class 6 trucks, the single-unit trucks (local delivery trucks) in urban (less than 100 miles) driving are the most typical. They account for well over half of the fuel consumption in Class 6.

Of the Class 8 trucks, combination trucks such as the semitrailer and the truck trailer units consume the most fuel. These trucks are operated by private businesses (i.e., department stores, grocery chains, utilities, and others) and for-hire operators. Most are for-hire combination trucks with usual trips of more than 100 miles. The 40-foot transit bus is representative of most of the Class 7 and 8 buses.

The specific truck models that account for the largest sales volume for the different truck manufacturers were selected to be the representative platforms and are shown in Table 3.1.

Table 3.1. Representative truck models

Platform	Model
Large—Class 8 line-haul	Freightliner FLD120 International 9200/9400 Kenworth T800 Mack CH613 Peterbilt 379 Volvo WC
Transit bus	40-ft Transit Bus
Medium—Class 6 delivery van	International 4000 Series GM “C” Series
Small—Class 2b pickup	Dodge 250 (8,600 GVW) GM 2500 (8,600 GVW)

3.2 REPRESENTATIVE DRIVING CYCLES

Appropriate representative driving cycles are necessary in analyzing, on a common basis, fuel efficiency and productivity improvements between the baseline (current) truck and the “advanced” 21st Century Truck vehicle. Several existing driving cycles for the “urban” portion of commercial truck use are candidates for use in this program. Three “chase” cycles developed for DOE by West Virginia University were evaluated in detail (Clark et al. 1999). These driving cycles were developed by following (chasing) trucks and recording speed. The faster two of the three cycles, when used in National Renewable Energy Laboratory’s (NREL’s) Advanced Vehicle Simulator (ADVISOR) model (Wipke et al. 1998) to estimate fuel consumption, gave most reasonable results. The faster of the two cycles, which averaged 34 mph, included driving on an urban interstate during a significant portion of the cycle. This cycle is termed the “Urban High-Speed” cycle. The slower of the two, which averaged 14 mph, did not include any urban interstate driving. This was termed a “Suburban” cycle. The Urban High-Speed cycle has a top speed of 61 mph. Only 9% of the time of the cycle is idling, and only 12% can be regarded as steady speed. The remainder is acceleration and deceleration. For the Suburban cycle, top speed is 45 mph, time idling is 25%, and time at steady speed is only 7%. The Urban High-Speed and Suburban driving cycles are considered as “City” driving for heavy trucks. Further studies will be done early in the program to establish an appropriate driving cycle to determine the baseline fuel efficiency for like-haul trucks.

The transit bus will use a representative urban driving cycle that focuses on operation in the central business district (CBD). This operation is stop and go to a top speed of 20 mph. The CBD consists of four segments: (1) a 10-second acceleration phase from 0 to 20 mph, (2) an 18.5-second cruise phase at 20 mph, (3) a 4.5-second deceleration phase from 20 to 0 mph, and (4) a 7-second phase at idle. This cycle is repeated seven times per mile traveled with a total for fourteen repetitions for a 600-second test, making a CBD-14 drive cycle. The CBD cycle was first used to define vehicle operation expectations in the late 70s. It has been part of the bus specification guidelines used by transit authorities in defining vehicle performance for all of the transit buses (more than 70,000) in operation today.

4. TECHNICAL PLAN

Commercial trucks and tractors cover a wide spectrum of applications and vocations, and range by size from the smaller pickup truck and van to the large, over-the-road, line-haul tractor trailer. Loosely categorized by actual physical size, the entire spectrum can be broken down to simply small, medium, and large vehicle types.

4.1 LARGE TRUCK—TRACTOR-TRAILER

Class 8 trucks consume approximately 68% of all commercial truck fuel used. The Class 8 trucks (mostly tractor semitrailers) operating on the open road (trip lengths greater than 100 miles) consume about 70% of this fuel. Therefore, the line-haul tractor-trailer offers the best benefit for any technology that will improve fuel efficiency. Nonetheless, the use of Class 8 trucks for trips of less than 100 miles (vocational and urban delivery trucks) still consumes more fuel than all Class 6 and 2b trucks combined; therefore, technology to improve fuel efficiency for Class 8 vocational and urban delivery trucks should be addressed. Most of the vocational vehicles operate in the vicinity of urban areas. Their operational characteristics are significantly different from those of most tractor semitrailers. The principal variables defining difference are operating speed, number of brake applications and acceleration cycles per unit time, and idling time. The power-train technology for this application is expected to be similar to that for Class 6 trucks; therefore, it is addressed in the section on medium trucks.

The goal of the 21st Century Truck Program with respect to Class 8 trucks is to develop, by 2010, enabling technology for line-haul trucks that (1) will have a fuel efficiency of 2× ton-mpg at 65 mph, fully loaded on a level road, and (2) will meet prevailing emission standards using petroleum-based diesel fuel. An additional goal is to improve the safety of heavy trucks through the implementation of truck-based technology.

Maximum benefit will be achieved if some of the technology is also adaptable to retrofit/rebuild processes. Adaptable technologies may include emissions aftertreatment, fuel processors, auxiliary power unit (APU) additions, vehicle intelligence, engine rebuilding technologies, brakes, and replacement of body/cab panels with lighter and more aerodynamic components/assemblies. This strategy will ensure, to the extent possible, that the benefits will accrue to the existing fleet, thereby ensuring an early and widely based implementation of the 21st Century Truck Program.

Analysis of the truck as a system will allow a comprehensive evaluation of how the various components and subsystems relate and interact with each other, and how improvements in the efficiency of various components lead to overall efficiency improvement of the whole system. Synergisms among the various subsystems can be exploited so that the overall improvement can potentially be larger than the product of the improvements of the individual subsystems. Systems analysis will be used to investigate various technology pathways to achieving the aggressive goals of the 21st Century Truck Program and to provide guidance in the direction of R&D. The following criteria will be used for the analysis of the vehicle platforms that have been identified: (a) vehicle functional requirements; (b) duty, driving, or operational cycles; and (c) performance requirements and expectations. Objective evaluation of performance, cost, benefit, and risk for the various technology pathways will be facilitated by systems analysis.

Modeling and simulation software that includes a wide number of vehicle subsystem and system configurations will be used in vehicle systems analysis for preliminary design studies as well as for performance trade-offs and cost comparisons for alternative vehicle configurations. Vehicle systems analysis will also provide the technical engineering teams with performance targets and reasonable trade-off parameters.

4.1.1 Vehicle Efficiency

Heavy truck fuel efficiency is influenced by several factors, including basic vehicle design, zone of operation, driver technique, and weather factors. Extending the definition of fuel efficiency to include the productivity measure “ton-mile of payload transported” presents a more meaningful measure. Some of the new technologies, such as aerodynamic treatments, will require flexibility in the application of size and weight regulations, as will some of the operational strategies that benefit fuel efficiency.

The nature of heavy-truck energy use can be better appreciated if it is summarized in an energy audit. Figure 4.1 and Table 4.1 contain an energy audit of a typical Class 8 vehicle operating on a level road at a constant speed of 65 mph with a GVW of 80,000 lb (36,280 kg).

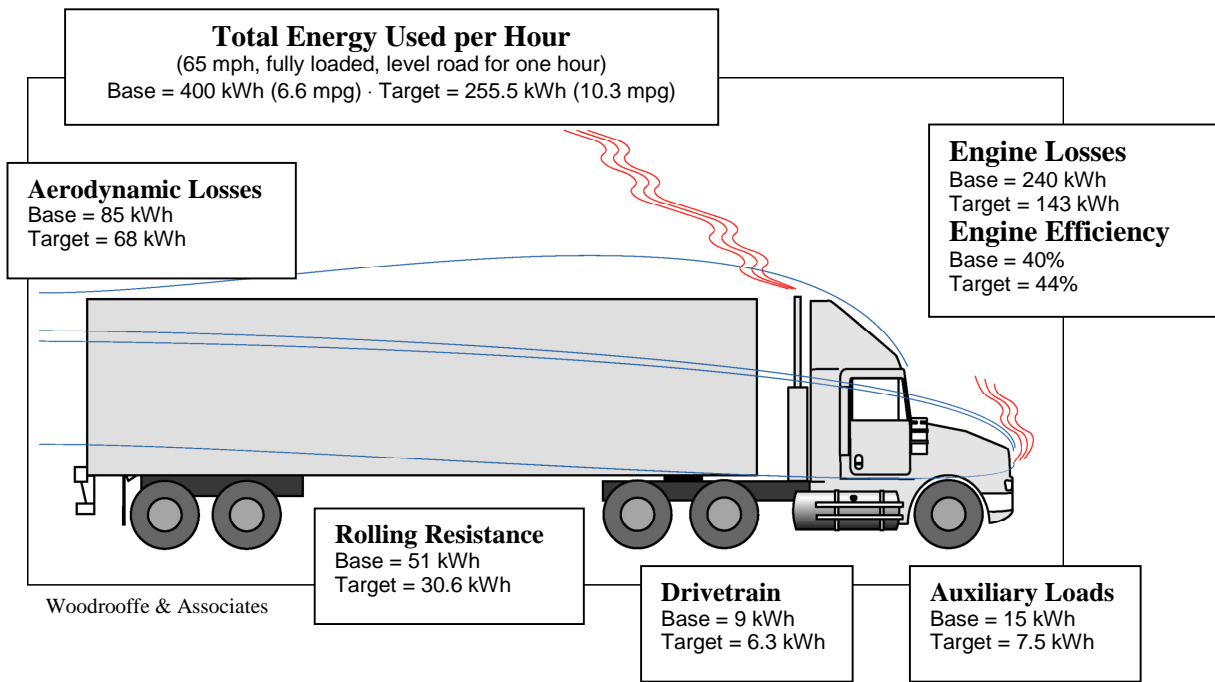

Fig. 4.1. Class 8 truck energy audit.

Engine losses, aerodynamic losses, and tire-rolling resistance account for approximately 94% of the energy used to sustain vehicle speed at 65 mph. Because these factors are all dependent on vehicle speed, terrain, traffic conditions, etc., the expected benefits to fuel economy will be highly dependent on zone of operation. Driveline friction and engine-based accessories, such as compressors and alternators, account for the remaining 6%. It follows, therefore, that improvements in engine efficiency, aerodynamic drag, and tire-rolling resistance will have a significant impact on fuel efficiency; improvements in driveline and accessory efficiency will have a small influence on fuel efficiency. Nevertheless, any improvement in efficiency should be actively pursued if the cost-benefit relationship is favorable.

Vehicle systems analysis software such as the ADVISOR or PSAT models will be used to investigate technology pathways to meeting the 21st Century Truck vehicle fuel efficiency and productivity improvement targets defined in this roadmap. The ADVISOR model, with the input assumptions developed for this analysis, estimated 4.3 mpg for a typical Class 8 truck on the “Suburban” cycle and 6.3 mpg on the “Urban High-Speed” cycle (see Sect. 3.2). For the analysis done to date for the tractor

Table 4.1. Energy audit and potential fuel efficiency improvements for line-haul trucks^a

Energy loss sources	Baseline	Improvement (%)	Target
Engine losses per hour (kWh)	240	10 ^b 30 ^c	144.0
Auxiliary loads (kWh)	15	50	7.5
Drivetrain losses (kWh)	9	30	6.3
Aerodynamic losses (kWh)	85	20	68.0
Rolling resistance losses (kWh)	51	40	30.6
Total energy used per hour (kWh)	400		256
Fuel consumption at constant 65 mph (mpg)	6.6	56	10.3
Fuel economy multiplier	1.0		1.56
Vehicle tare weight reduction		15–20	
Total fuel economy (ton-miles/gal) multiplier	1.0	71	

^aFully loaded on level road at 65 mph for 1 h.

^b10% net engine efficiency improvement after losses in efficiency due to emissions requirements.

^cDue to reduced power needs.

trailer truck used as the base for large trucks for this roadmap, “Highway” driving has been approximated as steady-speed interstate driving at 65 and 70 mph. Grades and speed variations due to traffic have been ignored. The ADVISOR model estimated 6.7 mpg for a typical Class 8 heavy truck at a steady 65 mph and 6.1 mpg at a steady 70 mph, illustrating the importance of aerodynamic drag at highway speeds.

Heavy truck fuel economy from ADVISOR simulations agreed reasonably well with VIUS estimates of fuel economy for Class 8 heavy duty trucks. This was done using a combination of the Suburban ($\approx 11\%$) and Urban High-Speed ($\approx 21\%$) “city” cycles, steady 65 ($\approx 24\%$) and 70 mph ($\approx 41\%$) “highway” cycles, with some overnight idling fuel consumption ($\approx 3\%$) added in the longest trips. The resulting estimated mpg for a “typical” Class 8 truck was 5.8 mpg.

4.1.1.1 Power-Train Efficiency

Status of Technology

The power train includes the engine and associated components such as the alternator, air compressor, and hydraulic pump. Engine losses in the form of waste heat contained in the exhaust and rejected from the engine and radiator account for 60% of the energy content of the fuel burned. These losses are associated with the thermodynamic engine cycle, and reductions in this loss through engine design changes are possible within the reciprocating diesel engine platform.

To date, new engine technologies capable of replacing reciprocating diesel engines for use in Class 8 trucks have not been forthcoming. However, we expect that the results of the 21st Century Truck Program activities will lead to breakthrough technologies that would significantly improve overall power-train efficiencies (see Sects. 4.6.4, 4.6.5, and 4.6.10). Some new power source technologies, such as fuel cell systems, may be capable of providing efficient auxiliary power to Class 8 trucks to sustain the cab environment during stationary periods (see Sects. 4.6.6 and 4.6.7).

Peak thermal efficiencies of the best current production diesel engines typically used in the Class 8 line-haul trucks are in the 45 to 46% range. Thermal efficiency of 46% translates to 0.30 lb/hph brake-specific fuel consumption. On a typical Class 8 line-haul cycle, the overall fuel efficiency would run closer to about 40% (0.35 lb/hph brake-specific fuel consumption). This corresponds to the energy audit illustrated

in Fig. 4.1, with the engine at 40% thermal efficiency and, therefore, the remaining 60% of the fuel energy lost as heat.

Technical Targets

Several areas of the engine system provide fertile ground for improvements in fuel efficiency. Table 4.2 contains a summary of engine R&D areas and rough estimates of realistic targets for a 10-year leveraged program.

Table 4.2. Engine efficiency projections

Development activity	Efficiency gain (%)
Exhaust heat recuperation and improved thermal management	7
More electric accessories and system optimization	6
Peak cylinder pressure	4
Reduced engine friction	1
More efficient combustion	2
New engine concepts	25

Given the technical potential, a 10 to 20% improvement target in engine efficiency, building on the traditional diesel engine reciprocator platform, is reasonable for a 10-year leveraged program. This increase in thermal efficiency, nominally from 45% to the range of 50 to 54% and would build on much R&D groundwork conducted in the DOE Office of Heavy Vehicle Technologies (OHVT) Low Emission, 55% (LE55) program. For more detail on potential improvements in diesel engines, see Sect. 4.6.2.

New engine concepts involving significant departures from the traditional diesel engine platform hold even greater potential benefit. A target of 25% improvement (45–56%) in thermal efficiency would not be unreasonable in this category.

For more detail on potential improvements in advanced engine technology, see Sect. 4.6.10.

Barriers

The barriers to improved diesel engine fuel efficiency fall into several general classes:

- poor cost-effectiveness of known exhaust-heat-recovery devices;
- NO_x reduction in-cylinder and aftertreatment;
- material limits (temperature capability and strength);
- tribological limits of current materials and lubricants;
- cost of advanced materials and their processing;
- lack of adequate combustion understanding and simulation capability;
- lack of full electronic management (i.e., smart motors in place of belts and gears to drive accessories, flywheel starter motor/generator, etc.);
- lack of investment in the traditional reciprocator platform and in advanced engine concepts; and
- limitations of air-handling components and systems.

Diesel engine efficiency is limited by the peak combustion temperatures and cylinder pressures that the engine materials can withstand. Commercially viable advanced materials for the combustion chamber exhaust valves, for example, limit the cycle efficiency. Friction, wear, and lubrication (tribology) limit engine efficiency. Higher in-cylinder temperatures necessary for higher efficiency require significant advances in tribology (e.g., piston ring and cylinder liner wear life, exhaust valve life). The industry's

understanding of the fundamentals involved in the diesel combustion process is impressive but still limited. An accurate simulation capability (from first principles) with predictive capability for emissions is lacking.

Technical Approach

The 21st Century Truck Program presents an opportunity to address the key barriers to cleaner, higher-efficiency diesel engines. The facilities and expertise found in the government laboratories and universities are well suited to participation in collaborative projects with industry. The following R&D to improve engine efficiency should be performed:

- Optimize mechanical design and combustion system for increased peak firing pressure and EGR.
- Develop and integrate auxiliary drives (electric, variable speed, for example) that have less parasitic load on the engine.
- Develop and integrate cost-effective exhaust-heat-recovery technologies into the engine system.
- Develop commercially viable advanced high-temperature, high-strength materials for combustion components.
- Develop a better understanding of frictional effects, and develop materials and lubricants with enhanced tribological properties to extend the life of piston rings/liners, exhaust valves, and cam shafts.
- Develop accurate simulation capability for combustion processes with predictive capability for emissions.
- Develop materials and technologies for improved thermal management.
- Develop improved sensors for control systems.

For additional details, see Sects. 4.6.2, 4.6.3, 4.6.7, 4.6.8, 4.6.9, and 4.6.10.

4.1.1.2 Vehicle-Related Losses

Vehicle-related losses include aerodynamic resistance, rolling resistance, and driveline and accessory losses.

Aerodynamic Resistance

At highway speeds, the fraction of fuel expended to overcome aerodynamic drag is approximately half of the fuel not expended in engine losses. Reducing aerodynamic drag by 25% results in savings in fuel consumption for steady highway travel in the range of 10 to 15%.

All vehicles will benefit from aerodynamic drag reduction, and the higher the operating speed and the longer the drive duration, the greater the benefit will be. Figure 4.2 illustrates the estimated horsepower associated with aerodynamic drag compared with the power required to overcome rolling resistance and to supply needed auxiliary power, plotted as a function of speed for a modern Class 8 tractor-trailer truck weighing 80,000 lb (36,280 kg) and possessing a wind-average drag coefficient of $C_d = 0.6$.

To reduce aerodynamic drag, the vehicle design should be optimized for minimum forebody and base drag. For Class 8 trucks, the trailer and tractor should have an integrated design with an optimum gap distance, and the height and width mismatch between tractor and trailer should be eliminated. Under-trailer turbulence should also be minimized. The external turbulent flow can also be controlled with body shaping and/or active flow devices. It is also important to improve internal (under-hood) airflow to provide the flexibility needed in tractor front-end and hood design to minimize aerodynamic drag while providing the required engine and accessory cooling. However, large reductions in aerodynamic wake turbulence may put increased demands on brake systems, with resultant safety implications.

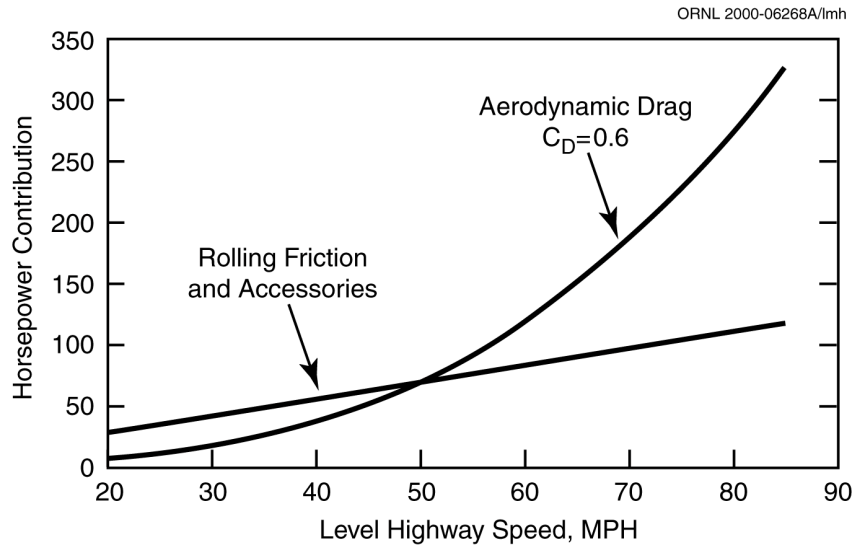

Fig. 4.2. Horsepower required to overcome aerodynamic drag and rolling friction/accessories as a function of travel speed for a typical Class 8 tractor-trailer.

Status of technology. Industry currently determines the aerodynamic characteristics of a truck design by using several techniques, including wind tunnel testing on reduced-scale models, full-scale trucks, and vehicle components (e.g., mirrors). Experience is critical to help guide the designs. Modeling with experimental validation to evaluate design changes is also important. Several generic resources are critical to the execution of any applied aerodynamic project:

- Experience—Involving highly experienced individuals with a strong empirical data base early in the process is the key to the successful planning and execution of any technical project, particularly in the complex and elusive world of aerodynamics.
- Empirical data—Using empirical data is the most cost-effective means of directing the first-order improvements in design. It is also useful for the prioritization of tasks that warrant more complex analysis techniques.
- Computational fluid dynamics (CFD)—This technique produces a continuum of data at exact conditions allowing for the exploration of unexpected issues at reasonable cost. This method is limited by assumptions and approximations, and the boundary conditions must be known to the same degree of accuracy as is desired from the solution.
- Wind tunnel testing—This method is the next natural step following CFD analysis. The results of wind tunnel tests reflect “real physics,” and once a model is built, many data points can be generated quickly. Wind tunnel testing is expensive, and the resulting data are largely limited to those which are anticipated and instrumented in advance.
- Field testing—The ultimate means of proving a design. Field test results are real and reflect the operating environment. Field testing is not normally a cost-effective means to guide design optimization; rather, it is most effective as the final step in the development process.

The DOE OHVT Aerodynamic Design of Heavy Vehicles Project Team has an R&D program under way to evaluate truck aerodynamic designs through advanced CFD development, experimentation, and application with industry partners. The DOE team is a multi-laboratory, multi-university collaboration. In addition to the national laboratory consortium, commercial performers experienced in the development of improved Class 8 truck aerodynamic designs will be an important component of the final development team.

Technical targets. Reducing fuel consumption hinges upon the availability of trucks having greater aerodynamic efficiency. It is estimated that the drag coefficient (C_d) for a typical tractor semitrailer (assuming a conventional tractor) is in the range of 0.65–0.70.

It is estimated that an aggressive program could result in a 20% reduction in the drag coefficient. This would have a very significant effect on the fuel efficiency of line-haul highway trucks.

Barriers. Perhaps the greatest barrier to reducing aerodynamic drag is the fact that trailers are fully interchangeable (i.e., a tractor does not always pull the same trailer); therefore, tractor-trailer aerodynamic optimization must include compatibility among the fleet as opposed to optimization of particular vehicles. In addition, it is difficult to change prevailing attitudes regarding cab or trailer shape, or add-on control devices. DOT regulations prohibit the use of some control devices, such as boat tails, that have demonstrated positive enhancements.

Technical approach. To foster rapid deployment of emerging technologies resulting from the 21st Century Truck Program, the early construction of prototype tractor semitrailer platforms is seen as an important strategic initiative. The construction of such vehicles could be initiated shortly, and the prototypes would serve as a platform for the new technologies. Aerodynamic drag and tire-rolling resistance have been identified as the two dominant factors influencing fuel economy. First-generation prototype tires could be available early in the program, and early prototype aerodynamic treatments could be implemented to demonstrate their effectiveness and operational practicality. It is clear that a successful 21st Century Truck technology option must be “practical” in order for it to be accepted. An early prototype vehicle will provide the ability to investigate new concepts, help guide their development, and ensure that they can be successfully incorporated into the heavy truck “system.” New concepts for safety improvements would be ideal candidates for the prototype vehicles because their effectiveness could be clearly demonstrated.

The early prototypes will also provide concrete evidence of progress and will serve as continuity platforms for the life of the project. This will allow accurate and fair reference comparisons of incremental design improvements and new technologies that emerge during the life of the program.

The challenge of reducing Class 8 truck aerodynamic drag will require a highly directed systems approach to the engineering task. The tractor-trailer is the vehicle that will gain the most benefit from aerodynamic improvement; thus it is imperative that trailer manufacturers be part of this program. Vocational vehicles will not benefit as much from aerodynamic improvements given their zone of operation (lower speed) and comparatively smaller number of operating units; however, some of the benefits that are expected to arise out of the tractor-trailer effort will be transferable to vocational vehicles.

The areas in which improvement in aerodynamic drag of Class 8 trucks can be realized are

- Front-end development;
- tractor-trailer interface;
- underbody drag and skirt; and
- trailer treatments such as boat tailing, collapsible roof lines, and active control.

The goal of reducing aerodynamic drag must be considered in light of other vehicle requirements. In particular, the addition of exhaust gas recirculation (EGR) systems will put additional requirements on cooling systems, including pumps, fans and radiators. These components impact the underhood space requirements and work in opposition to the need to reshape the front-end of the vehicle for drag reduction. In addition, the competition for space between cooling systems and front end shaping may also affect the need for improved front-end energy-absorption systems. These seemingly contradictory requirements

underscore the need for a systems approach. (For more discussion of thermal management see Sect. 4.6.8; for more discussion of safety-related issues, see Sect. 4.1.3.)

Rolling Resistance

A truck tire is largely a pneumatic load-carrying device that fulfills many functions including load support, transmission of acceleration and braking forces, transmission of guiding forces, and absorption of vertical dynamic shock loads. The truck tire generates energy losses as it performs these functions.

Typical loss origins and their magnitude relative to total rolling resistance loss are as follows:

- hysteresis losses, 85–90%;
- tire/ground friction, 5–10%;
- aerodynamic losses, 3–5%; and
- tire/wheel friction, less than 1%.

The largest energy losses are created by hysteretic material losses within the tire structure as it operates, and for practical purposes, it equates to “tire-rolling resistance.” All of these energy-related concerns must be balanced against safety imperatives for greater longitudinal and lateral traction in braking, and the possibility that smaller diameter tires would reduce cargo center-of-gravity heights, thereby providing a substantial enhancement of roll stability.

Status of technology. For a line-haul Class 8 type vehicle, tire-rolling resistance can account for a significant fraction of the total fuel consumed. At a given tread depth, a truck tire’s total energy losses will vary as the operational conditions change (speed, loading, and duration). However, this variation will be of secondary importance compared with the total vehicle fuel consumption, which will vary greatly, depending upon operating conditions (stop-and-go delivery vs interstate line-haul transport). Typical ratios of tire-rolling resistance to total vehicle fuel consumption are as follows:

- line-haul Class 8 trucks, 1: 3 to 4;
- regional usage Class 8 trucks, 1: 5 to 6; and
- urban bus usage, 1: 8.

Industry experience indicates that for a typical Class 8 tractor-trailer combination running on an interstate circuit, a 30% decrease in total vehicle tire-rolling resistance would improve fuel consumption by approximately 10%.

The total tire-rolling resistance contribution is equal to the sum of the individual tires’ rolling resistance (steer, drive, and trailer axle) at their given load. An approximation of the losses for a tractor semitrailer, assuming new tires on a fully loaded typical Class 8 vehicle, would be about 15% of the total tire energy loss on the steer axle [12,000 lb (5,442 kg) max load], about 50% on the drive axles [34,000 lb (15,470 kg) max load] and about 35% on the trailer axles [34,000 lb (15,470 kg) max load]. As a tire wears, tire-rolling resistance will normally decrease relative to the change in tread depth. A well-worn drive tire may approach the rolling resistance value of an unworn trailer tire. A loaded tire dissipates more energy than an unloaded tire; however, energy dissipated per ton of transported cargo will be lower for more heavily loaded vehicles.

Tire optimization vs customer expectations. The tire-rolling resistance is only one of several key performance criteria that affect tire selection. Other important performance criteria include tread wear life, traction, noise, durability and retreadability, and cost.

The tire must meet the customer’s performance and cost expectations. Each market segment values the various performance criteria differently. A single performance parameter can easily be enhanced, but an

optimal balance of all the criteria must be maintained. In particular, this balance requires simultaneous reduction in rolling resistance and increased tire traction available for braking and cornering. Unlike passenger car tires, truck tires are most often axle-specific in relation to these different performance criteria. For example, a low-tread-depth, rib-type tire may be desirable for a trailer axle application; however, the same tire would be commercially unacceptable for a drive axle application because of traction and tread wear life performance.

Technical targets. Total tire energy losses can be reduced primarily through rolling resistance reduction. Improvements in total tire aerodynamic losses can offer second-order improvements. The proposed target for reducing the tire's contribution to energy loss is

- Decrease “best in class” tire-rolling resistance values for steer tires to 4.5 kg/1,000 kg, for drive tires to 4.5–5.0 kg/1,000 kg range, and for trailer tires to 4.0 kg/1,000 kg while simultaneously increasing longitudinal and lateral tire traction to support a 30% reduction in stopping distance and improved handling. These values represent an approximate additional 15% reduction in tire-rolling resistance values vs today's best-in-class standards. This would translate to an additional 4 to 5% fuel savings for a line-haul Class 8 vehicle configuration.

Much more ambitious tire-rolling resistance targets below 4.0 kg/1,000 kg will not be reached across a wide range of tires before 2010 unless there are major breakthroughs in material dissipation properties and types of construction, or breakthroughs in the optimization for wear, traction, and tire-rolling resistance.

Barriers. There is great variation in tire-rolling resistance values; however, the ability to reduce this variation will be limited by the commercial acceptance of “optimized” low-rolling-resistance tires if other performance criteria are compromised. Reducing recapped tire-rolling resistance values to approximate new tire-rolling resistance values is desirable, given that there are more recapped tires on the road than new tires. The use of wide-based single tires can reduce rolling resistance by 10 to 30%. However, pavement loading at the tire/roadway interface is an important consideration for highway infrastructure protection (as measured by axle loads and tire/pavement surface area loads) and must be taken into account as design options are considered.

Lower-hysteresis rubber compounds for internal components and the tread area will reduce rolling resistance; however, a significant development effort will be required.

Technical approach. Apart from overcoming the barriers listed, other development activities leading to reduced tire-rolling resistance include the following:

- Optimize tread design to reduce energy losses while maintaining or improving tire traction. Lower-tread-void-volume designs offer improved rolling resistance values but generally reduce wet traction. This reduction would have to be offset by innovations in tread pattern design and tread rubber characteristics.
- Use alternative tire configurations to reduce aerodynamic drag. Single tire fitments on drive and trailer positions offer slight aerodynamic reductions. These gains will probably be second order.
- Optimize tire construction to reduce losses in load-bearing areas such as the bead and shoulder area.
- Increase tire inflation pressure to reduce tire-rolling resistance. Research is required to ensure that higher pressures do not negatively impact other criteria such as ride comfort or pavement damage.
- Develop simple tire/vehicle total life energy models to calculate the “energy balance” for different tire system proposals. This total life model would need to include the three essential components of total tire energy: energy to produce (and recap) the tire, energy consumed in the form of rolling resistance and other losses throughout its entire life, and energy recovered or expended during recycling/disposal.
- Develop and use analytical models to study tire-related vehicle fuel efficiency.

- Conduct tire-related aerodynamic drag studies to quantify the benefits of tire shape and configuration optimization.
- Research tire materials that offer the same advantages as current rubber compounds while reducing energy dissipation. This has been an area of ongoing research within tire companies and material suppliers for many years. Achievements in this area will be difficult and will require considerable effort; however, this area has the greatest potential benefit since the material dissipative losses are by far the dominant contributor to rolling resistance.
- Continue the ongoing work related to the impact of tire alignment on vehicle fuel efficiency.
- Continue to emphasize the need to maintain tire pressure to reduce energy loss. This is a real area of improvement because few fleets maintain tire pressures at recommended levels for optimal rolling resistance performance.

Driveline Losses

The driveline includes the transmission, drive shaft, differential, and wheel bearings. The driveline system is a mature system achieving better than 95% efficiency at high-torque applications. At highway speeds, the driveline efficiency approaches 98%. The efficiency drops under low-torque conditions because of constant drag torque and viscous losses. The three areas of technical development that may lead to improvements in efficiency include gear meshing, lubrication, and continuously variable transmissions (CVTs).

Gear tooth profiles have evolved to a point where little benefit is anticipated from further research activity. However, gear contact friction is an area where improvements are possible. Improvements would include the reduction of surface roughness and the use of low-friction coatings, new gear materials, and lubricants.

The second area of potential benefit is in the development of improved lubricants. Viscosity has long been the key to reducing gear-tooth sliding friction and increasing durability, but viscosity is also a contributor to reduced efficiency through viscous churning and damping.

The third area of potential benefit is the development of CVTs. To date, CVT technology has not been widely accepted by the heavy truck industry because it has not been demonstrated that CVT design concepts are practical in terms of cost or durability. However, newly emerging technologies are causing manufacturers of heavy transmissions to rethink the possibility of offering CVT functionality to line-haul trucks. This capability makes it possible for engines to operate at more nearly optimized speed/load conditions as a means of improving efficiency. In addition, CVT functionality may represent an enabling technology with respect to certain diesel aftertreatment technologies required to meet EPA regulations beginning in 2007.

Technical targets. It is anticipated that improvements in transmission driveline efficiency may be as high as 30%, which would yield a 1.5% improvement in fuel efficiency. The benefits associated with CVTs are more difficult to quantify because of the interaction with the driver and the engine. It is anticipated that the benefits of the CVT would lead to significant reductions in emissions and fuel consumption.

Barriers. The ability to develop additives and chemical formulations that can produce low friction and wear characteristics as well as low viscous losses at the full range of operating temperatures is the most significant barrier. New lubricants must be compatible with friction materials in clutches and brakes. The creation of improved lubricants would have universal benefit for all vehicles. Treatments developed to reduce gear tooth and bearing friction are not yet practical or cost-effective. The principal barrier preventing the successful introduction of a CVT for the heavy truck industry has been the availability of suitable technology that can withstand the high torque loads over extended operating periods at a reasonable price. However, recent encouraging developments in this area have raised the probability of a commercially viable CVT.

Technical approach. Driveline efficiency improvement work has the advantage of being highly focused on three primary objectives. The implications of successful development in this research domain are clear and compelling and have enormous crosscutting potential that extends well beyond motor vehicles. For this reason, industry is highly motivated to find a solution. Any projects under consideration for deployment will require a high level of industry involvement and a very critical analysis of the cost-benefit profile of the proposed research effort.

To foster the development of CVTs, vehicle systems-level modeling should be conducted to simulate the effect of CVT functionality and potential synergies that are created in other subsystems, such as exhaust aftertreatment.

Accessory Loads

Accessory loads common to Class 8 trucks include engine-based components such as the alternator, air compressor, air-conditioning compressor, hydraulic pump, and engine oil and fuel pumps; cab-related accessories including heating and cooling fans, lighting, windows, and mirror heaters; and living accessories such as refrigerators, microwaves, coffee pots, and entertainment devices. The power requirements for Class 8 trucks vary between 3 and 30 kW, depending on the truck drive cycle and the type of work function. At highway speed, it is estimated that the accessory load for a tractor semitrailer accounts for about 4% of the fuel consumed by the vehicle. The technologies that might be considered to reduce accessory loads are described in Sect. 4.6.7. It is expected that development of these technologies could result in a 50% reduction in auxiliary loads.

4.1.1.3 Mass Reduction

Reduction of the tare weight mass of heavy vehicles translates into a direct efficiency gain on the basis of increased payload productivity potential. However, the maximum benefit of increased payload efficiency is not realized for loads that occupy the maximum volumetric capacity of the vehicle unless the maximum allowable weight is reached. Given that a significant portion of freight transported by heavy trucks is volume-limited, particularly back-haul freight, estimates of the benefits of reduced tare weight need to reflect this reality. Items such as white goods and furniture are examples of volumetrically sensitive freight. Load-sensitive freight that would benefit fully from reduced tare weight includes bulk commodities such as petrochemicals, forest products, and structural steel. However, mass reduction can also benefit volume-limited trucks. It has been estimated that a 4,000-lb (1,814 kg) reduction in tare weight will reduce rolling resistance by a minimum of 5% and will enhance braking efficiency as well.

Status of Technology

The Class 8 truck industry has a history of being sensitive to vehicle tare weight because of its relationship to productivity. Some truck purchasers aggressively select vehicles on the basis of tare weight; others are less sensitive to this issue. Heavy truck manufacturers have addressed this need by considering mass when selecting components and by balancing tare weight, vehicle durability, and performance. To take this effort to the next level will require a systems approach that optimizes subcomponents to minimize mass. Heavy truck frame structures can be improved to reduce tare weight through high-level engineering, materials selection, and technology development. Trailers are completely independent of the tractor; therefore, they will require unique approaches to weight reduction.

Technical Targets

It is anticipated that the mass of tractor-trailer assemblies can be reduced by about 15 to 20%. Some of this benefit may be lost as a result of the additional mass requirements of anticipated 21st Century Truck technologies such as aftertreatment emission devices, hybrid power trains, fuel cells, and regenerative braking units.

Assuming that the tare weight of a typical tractor-trailer is approximately 27,000 lb (12,245 kg), and the GVW is limited to 80,000 lb (36,280 kg) by regulation, then the payload component would be approximately 53,000 lb (24,036 kg). A 15 to 20% reduction in tare weight will translate into a 7.6 to 10% improvement in productivity efficiency, assuming that the vehicle is operating at the fully loaded state. Factoring in the net benefits that would accrue to the entire fleet, assuming that 30 to 50% of vehicle miles traveled are at maximum allowable loads, the net improvement in efficiency would be approximately 2 to 5%. Of course, any changes in materials and/or structures to reduce tare weight must not sacrifice vehicle durability or crash survivability and must not compromise cargo containment.

Barriers

The barriers limiting progress in tare weight reduction include

- the sensitivity of the marketplace to minimum capital cost for vehicles,
- the need to ensure that durability will not be compromised,
- the arms-length relationship with component suppliers,
- lack of experience in joining new lightweight materials,
- lack of an appropriate data base on lightweight materials for use by design engineers,
- lack of experience in repairability and maintenance, and
- the design flexibility requirements that define the largely custom-built truck market.

Technical Approach

To accomplish meaningful reduction in tare weight will require a concerted effort from both the vehicle manufacturer and the trailer manufacturer along with technologists in advanced materials and manufacturing processes. A systems approach will be required to improve component design, with an emphasis on reduced mass and system integration. A number of projects are under way within the DOE OHVT High Strength Weight Reduction Materials Program. Close collaboration between national laboratories, universities, truck manufacturers, and component and materials suppliers must be maintained. Development of lighter frame structures is a practical goal, but attention must be given to ensuring continued durability and vertical dynamic response. Goals may be achieved by a near-term use of better design and use of high-strength steel, followed by increased use of aluminum and incorporation of carbon fiber polymer matrix composites as technology to manufacture cost-effective components becomes available. See Sect. 4.6.9 for more details.

The following specific R&D projects should be included:

- Develop low-cost processes for manufacturing large components in order to reduce part count and assembly steps.
- Develop a materials design methodology and manufacturing technologies to reduce the weight of structural components of trailers. Components must exhibit strength, stiffness, and durability to meet the duty cycle and maintain crash energy management capabilities.
- Develop manufacturing processes to take advantage of the high specific strength of magnesium and titanium alloys. Develop cost-effective forming processes for aluminum and high-strength steels.
- Develop reliable joining techniques for lightweight materials.
- Develop predictive analytical computer models for dimensional management of full assemblies.
- Assess the potential of lightweight, high-strength polymer matrix composite materials to meet performance and cost targets for structural applications.

4.1.2 Emissions

4.1.2.1 Status of Technology

Emission reduction in large tractor-trailer combination trucks must focus on the diesel engine. The diesel engine presently dominates this sector of commercial trucks because of its efficiency, durability, and torque/speed characteristics. In the foreseeable future, no other type of power plant is expected to be ready for this application in spite of years of research on alternatives.

Over the past 20 years, diesel-engine manufacturers have achieved remarkable reductions in nitrogen oxide (NO_x) and particulate matter (PM) emissions in response to regulations. When the EPA first began regulating diesel emissions in the mid- to late 1970s, trucks typically had emission values of 10 to 15 g/bhp-h of NO_x and 1 g/bhp-h of PM. Emissions reductions have been achieved by optimizing electronic control, retarding fuel-injection timing, increasing injection pressures, improving air-handling systems, using oxidation catalysts, and implementing EPA's mandate for low-sulfur diesel fuel (no greater than 0.05% sulfur content) for on-highway vehicles in the early 1990s. Today's heavy-duty diesel engines are regulated to 4.0 g/bhp-h of NO_x and 0.10 g/bhp-h of PM (less than 0.05 g/bhp-h for transit buses), and substantially lower emissions have been achieved in research engines.

In 1996, the EPA, the state of California, and major engine manufacturers prepared a Statement of Principles (SOP) that requires further reduction to 2.4 g/bhp-h of NO_x plus non-methane hydrocarbons (NMHC) or 2.5 g/bhp-h of NO_x plus NMHC with a maximum of 0.5 g/bhp-h of NMHC by 2004. An action by the EPA and the U.S. Department of Justice resulted in a consent decree with the diesel-engine manufacturers that moves the SOP requirements to October 2002 and places caps on emissions at all operating conditions. The requirement for the diesel-engine manufacturers to meet these lower emissions standards will likely be met with implementation of cooled EGR, resulting in reduced engine efficiency and perhaps less durability. Numerous preproduction engines have achieved the SOP emissions levels.

The SOP and various state programs are spurring the use of emission control technologies in retrofit. In particular, diesel particle filters (DPFs) and oxidation catalysts are applicable to older engines in the fleet.

In May 2000, EPA unveiled proposed emissions regulations for heavy-duty engines to begin in 2007. EPA is proposing a PM emission standard for new heavy-duty engines of 0.01 g/bhp-h, to take full effect in the 2007 heavy-duty engine model year. The proposed standards for NO_x and NMHC are 0.20 g/bhp-h and 0.14 g/bhp-h, respectively. These NO_x and NMHC standards for diesel engines would be phased in together between 2007 and 2010.

It is widely held that the emissions levels in these proposed rules could be met only with the integration of robust NO_x and PM exhaust emission control devices with the engine. The lower limit of engine-out emissions for direct-injection diesels is estimated to be about 1.5 g/bhp-h NO_x. Only the realization of high-risk technologies such as homogenous charge compression ignition (HCCI) engines would change this perspective. The mature and highly effective three-way catalyst (TWC) systems in today's gasoline-fueled automobiles are not applicable to diesel or other lean-burn engines. In TWC systems, both reduction of NO_x and oxidation of carbon monoxide (CO) and hydrocarbon (HC) gases can be accomplished in a single catalyst bed; sufficient reducing gases are present to reduce NO_x, and enough oxygen is available to oxidize the CO and hydrocarbons through precise control of air-fuel ratio near stoichiometry. However, because diesel engines operate under lean-fuel conditions (i.e., excess oxygen), conventional catalysts are not effective; therefore new approaches to NO_x control are required.

The most promising NO_x emission control technologies include the following:

- NO_x adsorber-catalysts,
- selective catalytic reduction (SCR) systems using urea,

- SCR systems using hydrocarbon reductants, and
- plasma-assisted SCR with hydrocarbon reductants.

Development and optimization work with NO_x adsorber technology is progressing. In programs utilizing very-low-sulfur fuel, NO_x reduction levels of more than 90% have been achieved for fresh devices in both engine test cells and experimental vehicle systems. However, on representative heavy-duty cycles, the experience has been 60 to 70% conversion; and in the presence of even low amounts of sulfur, performance degrades dramatically within tens of hours. To improve transient performance, extensive R&D work is still needed in the areas of optimizing the NO_x adsorption/desorption and conversion functions, defining and optimizing sulfur removal (“desulfurization”) techniques and strategies, and examining the use of sulfur traps upstream of the catalyst.

SCR technology is being developed for commercial application and will be available for some motor vehicles in the very near future. The urea-based SCR technology is achieving NO_x reductions on the order of 80 to 90% and is also capable of reducing hydrocarbon emissions and PM.

Plasma devices are being explored in conjunction with hydrocarbon SCR systems to convert NO_x to NO₂ and to modify the hydrocarbons used as reductants. They are generally in the early prototype scale.

Control technologies for PM have seen significant progress in recent years to the point of limited commercial application. Catalyst-based DPFs used on engines operated on low-sulfur diesel fuel can achieve PM and toxic hydrocarbon reductions well in excess of 90%. Indeed, when very-low-sulfur diesel fuel is used, the level of particulate emissions is almost undetectable. Where diesel fuel containing less than 10 ppm sulfur has been used, filter technology has demonstrated impressive durability, in some applications continuing to provide excellent particulate removal at 600,000 km of vehicle operation.

Diesel oxidation catalysts (DOCs) are often utilized in complete NO_x and PM control systems. Their functions can include oxidizing NO to NO₂, eliminating ammonia slip in SCR systems, and generating heat. DOCs are a mature technology and have been widely used commercially.

Certain fuel characteristics are critical to achieving emissions targets. In the early 1990s EPA mandated an approximate 90% reduction in diesel fuel sulfur (on-highway use) to assist with PM control. It is now evident from rigorous test programs, many of which have been jointly conducted by DOE and industry, that fuel sulfur will need to be substantially lowered again for the emission control devices and systems to be effective and durable. Therefore, EPA has proposed a sulfur cap of 15 ppm in diesel fuel beginning in 2006 (typical levels today are 200–300 ppm). Performance enhancement of emission control systems may be achievable through tailoring other fuel properties or through additives. Engine-out emissions can also be reduced by a reasonable degree through fuel reformulation.

Emission control technologies, their challenges, and recommended R&D are described in more detail in Sect. 4.6.10.

4.1.2.2 Technical Targets

The emissions targets are as follows: 0.1 g/bhp-h PM and 2.4 g/bhp-h of NO_x plus NMHC, or 0.1 g/bhp-h PM plus 2.5 g/bhp-h of NO_x plus NMHC with a maximum of 0.5 g/bhp-h of NMHC or less by October 2002, while achieving the efficiency goals. (Test cycles are defined in the Consent Decree.) The target for 2007 is compliance with emissions regulations at that time. The final EPA rulemaking is expected to be in December 2000. Proposed rules are 0.20 g/bhp-h NO_x and 0.01 g/bhp-h PM and a maximum 5% fuel economy penalty from the emission control system.

4.1.2.3 Barriers

The following are key barriers to achieving the technical targets for emissions from diesel engines for tractor-trailer trucks:

- NO_x/PM trade-off—that is, maintaining efficiency and low NO_x while keeping PM down:
 - limitations of air-handling system,
 - limitations of fuel-injection technology,
 - incomplete optimization of cooled EGR and its durability issues, and
 - limited effectiveness of cost-effective fuel additives and reformulation;
- unproven durability and transient performance of NO_x aftertreatment technology:
 - degradation from sulfur in fuel,
 - temperature extremes, and
 - Inadequate methods of introducing reductants;
- undeveloped infrastructure for urea SCR; and
- immature systems integration and optimization of PM and NO_x control devices because of inadequate simulation capability for aftertreatment devices.

4.1.2.4 Technical Approach

Meeting the technical targets for emissions will require a three-pronged diesel engine emission-control strategy:

1. understanding and optimizing in-cylinder combustion processes,
2. optimizing fuel formulation, and
3. further developing exhaust aftertreatment technologies such as improved catalysts.

The following are recommended R&D paths (additional details can be found in Sect. 4.6.10):

- Apply advanced diagnostics to describe and quantify (when possible) the in-cylinder formation of NO_x and PM.
- Further develop advanced, highly flexible fuel-injection systems and engine control strategies to apply the knowledge gained from the preceding path.
- Reduce or eliminate particulate and sulfur contributions from lube oil by development of improved liquid lubricants and advanced solid lubrication technology where applicable.
- Optimize cooled EGR for maximum NO_x reduction without PM increase, and mitigate durability concerns through materials engineering and operational controls.
- Improve the scientific foundation of NO_x control absorber and catalyst performance and degradation mechanisms. Similarly, expand the foundation of understanding of plasma processes as they pertain to NO_x and PM control.
- Identify and exploit fuel properties that reduce overall tailpipe emissions through lower engine-out emissions and/or enhancement of aftertreatment system performance.
- Utilize the preceding accomplishments to improve the materials, components, and system designs for emission controls. Improve and apply emission control simulation tools for system design and optimization.
- Develop better methods for generating and introducing effective reducing species to NO_x catalysts
- Develop desulfurization processes or sulfur sequestration technology for emission control devices.
- Devise suitable technologies and procedures for urea supply for SCR.
- Develop and apply sensors in controls and diagnostics of engine and emission control processes.
- In development of emission control aftertreatment devices, include the necessary features to make the devices suitable for retrofit of the existing fleet.

4.1.3 Truck-Related Safety (Truck-Trailer Systems)

Medium/heavy trucks account for approximately 3% of vehicles in use on the nation's highways and accumulate 7% of all the vehicle miles traveled, while being involved in 8% of all fatal crashes and 3% of all crashes. The relative proportional involvement of medium/heavy trucks in fatal crashes has decreased over the past 8 to 10 years; they typically accounted for 10 to 12% of the total 10 years ago.

Each year, more than 4,000 people die in crashes involving combination trucks (defined as tractor-trailers, bobtail tractors, and single-unit trucks towing trailers). This number represents about 74% of the fatalities resulting from crashes involving all types of medium/heavy trucks. Over 80% of these fatal crashes are multiple-vehicle crashes, and the vast majority of the fatalities (about 80%) are occupants of other vehicles. About 13% are truck occupants, and 7% are not vehicle occupants (pedestrians, bicyclists, etc.). In about two-thirds of two-vehicle crashes involving combination trucks, the point of impact on the truck is the front. Nearly half of these involve the front portion of the truck being struck or striking some portion of another (typically smaller) vehicle. The second most prevalent crash type is the front of the truck impacting the side of another vehicle.

DOT has established a long-term goal of a 50% reduction in fatalities resulting from medium/heavy truck crashes by 2010. That number stood at 5,374 in 1998 (the benchmark year); thus the goal is to experience no more than 2,687 fatalities in 2010. This is a daunting challenge that will require simultaneous action on many fronts. Technologies developed in the 21st Century Truck Program will contribute to meeting this challenge.

In developing programs to improve vehicle safety, it is essential to consider the multiple factors contributing to the cause or enabling of truck crashes. These include

- motor carrier management commitment to safety and their safety management practices;
- driver skill, performance, and behavior;
- driver distraction and driver fatigue;
- roadway design and condition;
- traffic volumes and density;
- vehicle design, performance, and condition; and
- institutional issues such as motor carrier regulations and enforcement.

Vehicle design, performance, and condition obviously represent only one of these factors. Nevertheless, it is the focus of this program, and improvements made in this area can yield significant crash prevention/mitigation improvements.

4.1.3.1 Crash Avoidance

Safety Issues and Status of Technology

Among the many factors leading to truck crashes, vehicle design and performance characteristics play a critical, if somewhat unrecognized and underreported, role. In many cases, these attributes, if they do not directly cause a crash to occur, make it more difficult for a truck driver to recover from an error or avoid an unforeseen conflict. Once a crash occurs, the way trucks are designed can affect the severity of trauma sustained by the occupants of all the vehicles involved. Significant components of the basic vehicle design, such as overall dimensions, weight, and axle location, are controlled by government size and weight regulations. These regulations are primarily focused on infrastructure preservation and not necessarily on vehicle safety. Issues aimed at improving commercial vehicle safety through vehicle design and/or configuration change will most certainly require cooperation from the policy sector.

It is widely recognized that other factors, principally the roadway type on which the truck is operated and the behavior/performance of both truck drivers and other vehicle drivers, have a large influence on crash causation. Nevertheless, vehicle design and performance attributes are important concerns that, if optimized, can enhance large truck safety and help reduce truck crash-related fatalities. However, it is important to balance optimization efforts. For example, design enhancements that reduce aerodynamic drag may adversely affect braking capability. On the other hand, such design enhancements might be used to reduce the severity of car-truck impacts.

With this information as background, it is essential that measurable safety goals be established for the 21st Century truck platforms. In many cases, it will be beyond the scope of this program to link performance improvements to estimates of fatalities/injuries that might be prevented as a result of incorporating the improvement; therefore, reasonable surrogate goals will be used—namely, direct engineering measurements of various safety-relevant vehicle performance attributes.

The safety goals will relate to the crash avoidance and crash protection performance characteristics of each vehicle platform and will include, but not be limited to, the following:

- straight-line, controlled stopping performance (stopping distance);
- retention of braking capacity during grade descents, or other situations involving sustained brake applications (brake thermal capacity);
- roll stability in a steady-state turning maneuver (static roll stability threshold);
- roll and directional stability in crash-avoidance steering maneuvers (load transfer ratio, and, in the case of multi-trailer combinations, rearward amplification of steering-induced lateral acceleration);
- low-speed offtracking in a 90° turn;
- enhancement of driver capability to avoid collisions (various measures of advanced technology collision avoidance system performance, e.g., roll stability warning, side and rear blind spot elimination, forward collision avoidance systems, run-off road warning systems);
- truck occupant protection [as measured by existing Society of Automotive Engineers (SAE) Recommended Practices]; and
- reduction of truck frontal and side structural aggressivity in multi-vehicle collisions (vehicle/vehicle dimensional compatibility and truck structural kinetic energy absorption/deflection performance).

Each of these performance measures needs to be gauged comparatively with the most prevalent in-use truck represented by each platform.

The 21st Century Truck Program will include only those aspects of truck safety that can be addressed through on-board truck technologies.

Technical Targets

Several high-technology tractor-trailer demonstrators have already been built that have shown a reduction on the order of 30% in stopping distance compared with current production designs. This has been accomplished by a combination of air disc brakes throughout the tractor-trailer combination, much more powerful front axle brakes, and electronic control. Electronic control of braking offers better brake control and balance because the braking action can be modulated at each individual wheel of the combination. It also offers reduced application times, which is especially important in multiple-trailer combinations. A performance target of a 30% reduction in stopping distances is reasonable for this program. To achieve this goal, the frictional characteristics of tires will also have to be improved from current production designs. This may have a significant impact on the ability to reduce rolling resistance for tires because increasing braking traction typically also increases rolling resistance.

The use of disc brakes on both tractors and trailers will also improve the thermal capacity (fade resistance) for new Class 8 foundation brake systems. The biggest challenge will be to provide disc brake

designs that are economically feasible and not at odds with energy-saving goals because current disc brake designs are both much heavier and much more expensive than drum brakes. The size of currently available disc brakes inhibits their adoption in North America. New, lightweight friction materials will have to be developed for both rotors and brake pads. In order to obtain sufficient stopping power with smaller-diameter wheels, designs employing multiple discs will be necessary. Incompatibility of brakes between old trailers and new tractors, or vice-versa, will present a major problem during phase-in, which may be, at best, addressed through the use of electronically controlled brake systems.

Engine braking can be a significant additional factor. Today, with the use of variable-geometry turbochargers, the power absorption capability of engine brakes may exceed the power rating. With the use of electrically assisted turbochargers, additional braking capability is possible.

Vehicle stability characteristics such as static roll stability and load transfer ratio can be improved by reducing the center-of-mass height of the vehicle and by such vehicle design improvements as increasing the tractor to 102 inches in overall vehicle width.

Advanced technology collision avoidance systems—measures and performance targets—are also areas of activity where improvements can be expected.

Barriers

Size and weight regulations, both state and federal, can have a constraining effect on vehicle design and configuration choices. For the purposes of this program, however, they need not be absolute barriers to exploring new technological approaches if it can be demonstrated that employing them will enhance all the program's goals simultaneously and that the resulting vehicle will be reasonably sized for the highway and traffic environments in which it will operate. Other barriers include brake compatibility issues, tractor-trailer compatibility, material limitations, tire friction characteristics, systems reliability constraints, and prohibitions on the use of engine brakes because of noise considerations.

Technical Approach

It will be necessary to examine the effectiveness of various safety-related initiatives with respect to such matters as vehicle system effects and infrastructure impact. For example, smaller wheels and tires may also improve stability by reducing the center-of-mass height and may decrease aerodynamic drag, but they may cause a disproportionate increase in pavement wear. Such an initiative would also require fundamental changes in foundation brake design.

- Disc brakes hold great promise in terms of brake torque and thermal capacity performance, but they could be significantly enhanced by using technologically advanced materials in the discs and friction-pad materials.
- Electronically controlled brakes represent an essential enabling technology for monitoring brake condition/status and for advanced systems to augment control of directional stability.
- Tire longitudinal traction performance must be improved if stopping performance is to be improved, but it needs to be optimized relative to rolling resistance and wear.
- Static roll stability, load transfer ratio, and low-speed offtracking would all be substantially enhanced by the use of an articulated trailer with axles at mid-length. Work would be needed to design such a trailer to be capable of backing without jackknifing. Vehicle stability characteristics such as static roll stability and load transfer ratio can be improved by focusing on reducing the center-of-mass height of the vehicle and by such vehicle design improvements as increasing the tractor to 102 inches in overall vehicle width and developing steerable trailer wheels to improve low-speed offtracking.
- On-board vehicle system status/condition monitoring, as well as driver performance monitoring and warning systems, offer significant potential for reducing maintenance and operational costs and for enhancing safety performance.

- An electrically assisted turbocharger could deliver more air to the engine, causing it to become a more rigorous air pump and increase brake power absorption capability more than a variable-geometry turbocharger can.

4.1.3.2 Crash Protection

Safety Issues and Status of Technology

Work to improve crash protection for truck occupants has been under way within the truck manufacturing industry for approximately the last 10 years. That work includes improvements to occupant restraint systems, rollover protection, and cab structural integrity. Progress in that area can be incorporated and expanded upon in this program.

Until recently, activities to reduce the structural aggressivity of trucks in collisions with other vehicles have been limited to the rear structures of trailers. The incorporation of aerodynamic shapes/designs in tractor-trailers offers the possibility of making truck frontal and side structures complementary and compatible with the increasingly advanced crash protection features/capabilities of passenger cars, light trucks, and SUVs, thereby improving the likelihood that occupants of vehicles involved in collisions with trucks will survive.

Technical Targets

Due to the subjective and complex nature of road vehicle safety, it is difficult to quantify anticipated benefits in terms of percentage improvements. Professional opinion strongly supports systems approach initiatives for improved safety. It is expected that an industry/government initiative in crash protection will lead to substantial gains in safety for passenger car/truck conflicts.

Barriers

In addition to cost and operational practicability/durability considerations, the proposed technology must not significantly increase vehicle tare weight and should not significantly increase vehicle length.

Technical Approach

Fundamental research will be required to fully understand the dynamics of collisions between smaller vehicles and large trucks. Research to achieve improvements in protection and survivability would consider various options for vehicle redirection and crash energy management:

- Development of advanced technology and materials for cab, frontal, and side structures.
- Development of computer methods to verify energy absorption capabilities for heavy-duty vehicles.
- Reduction of side collision aggressivity—performance similar to that of roadside guard rails; that is, the ability to successfully redirect a 3,000-lb (1,365 kg) passenger car when it impacts the side of a trailer at a 10 to 15° angle from the longitudinal centerline of the truck at 60 mph.
- Studies on front structure aggressivity—the ability to manage the kinetic energy of a 3,000-lb (1,365 kg) passenger car impacting the front structure of the truck in a 50% offset collision, at a closing speed of 60 mph, without exceeding existing car-occupant-trauma thresholds.
- Finite element and occupant kinematic analyses of candidate structural designs to identify optimized designs quickly and inexpensively.
- Determination of the capacity of sandwich, cored, and foam materials for energy absorption applications.

No safety performance measure would be reduced as a result of design changes related to energy savings.

4.2 TRANSIT BUS

Another segment of vehicles to be evaluated is the 40-ft transit bus used in most urban areas for public transportation. These vehicles are predominately purchased by public or quasi-public agencies or authorities. Public funds from either special taxes or general revenue taxes are used to support operation of these services. The public nature of this transportation and the highly visible service it provides result in a great demand for innovation in reducing emissions and improving passenger service. The capital cost for new transit buses is predominantly funded (80%) by the federal government, which greatly encourages new technology that can reduce operating costs, reduce emissions, or provide better customer service. The number of transit buses is small (fewer than 100,000) compared with the number of Class 8 tractor-trailer vehicles; however, this segment by its nature works in very close proximity to the public. A new transit bus may be in service 20 hours a day. The stop-and-go operation prevalent in many urban passenger services leads to comparatively low fuel economy in operation.

The goal for 40-ft transit buses is to achieve a 3× improvement in fuel economy measured in miles per gallon. Achieving this goal will require significant improvements in several technology areas, including improved power-train efficiency, reduction in parasitic losses, and reduction in vehicle mass. Many variables affect the fuel economy of transit buses. Factors such as traffic congestion, hilly terrain, and the number of passengers have a major impact on fuel economy; therefore, it is difficult to describe a “typical” drive cycle for a transit bus. One cycle that is frequently used is the central business district (CBD) cycle. The CBD cycle consists of four segments: (1) a 10-second acceleration phase from 0 to 20 mph, (2) an 18.5-second cruise phase at 20 mph, (3) a 4.5-second deceleration phase from 20 to 0 mph, and (4) a 7-second phase at idle. This cycle is repeated seven times per mile traveled with a total of fourteen repetitions for a 600 second test. The estimated distribution of energy loss in typical operation of a transit bus over the CBD cycle is shown in Fig. 4.3.

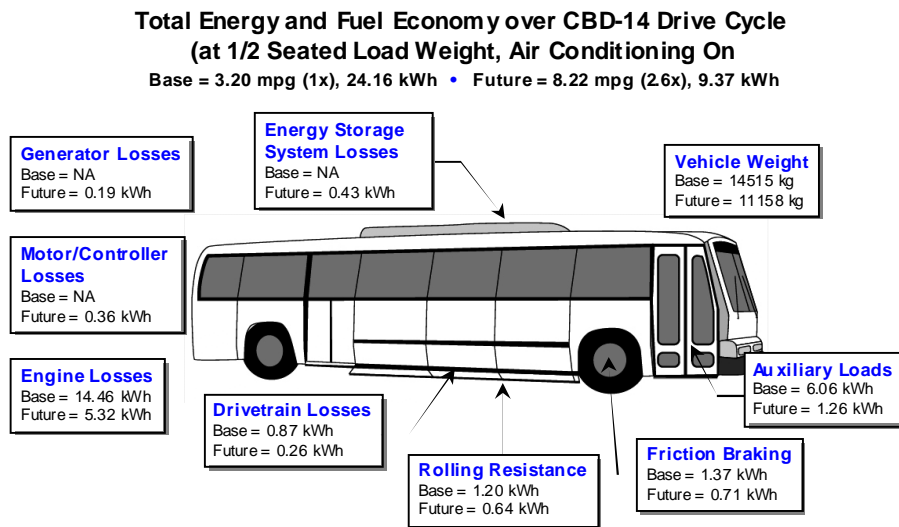

Fig 4.3. 40-foot transit bus energy audit.

The specific goals are to achieve an increase in fuel economy from 3 mpg to 6 mpg by 2004 and to lay the foundation to achieve 9 mpg by 2010. Transit bus models were developed to use test data and industry experience to estimate energy use over the CBD-14 driving schedule (see Table 4.3). An ADVISOR systems analysis was subsequently performed to investigate pathways to reach the 3× fuel economy goal. A preliminary ADVISOR analysis indicates that a 2.6× improvement in fuel economy can be realized mainly through transit bus hybridization, weight reduction, and auxiliary load reduction (see Fig. 4.4).

Table 4.3. Energy audit and potential fuel efficiency improvements for 40-ft transit bus^a

Energy loss sources	Baseline ^b	Target ^c
Engine losses (kWh)	14.46	5.32
Auxiliary loads (kWh)	6.06	1.26
Drivetrain losses (kWh)	0.87	0.26
Generator losses (kWh)	<i>d</i>	0.19
Energy storage system losses (kWh)	<i>d</i>	0.43
Motor/controller losses (kWh)	<i>d</i>	0.36
Friction braking (kWh)	1.37	0.71
Aerodynamic losses (kWh)	0.22	0.22
Rolling resistance losses (kWh)	1.20	0.64
Transit bus weight (kg)	14,515	11,158
Total energy used over CBD-14 (kWh)	24.16	9.37
Fuel consumption over CBD-14 (mpg)	3.20	8.22
Total fuel economy multiplier	1.0	2.6

^aOver the CBD-14 drive cycle, operating at 1/2 seated load weight with A/C on.

^bConventional power train.

^cFuture series hybrid.

^dNot applicable.

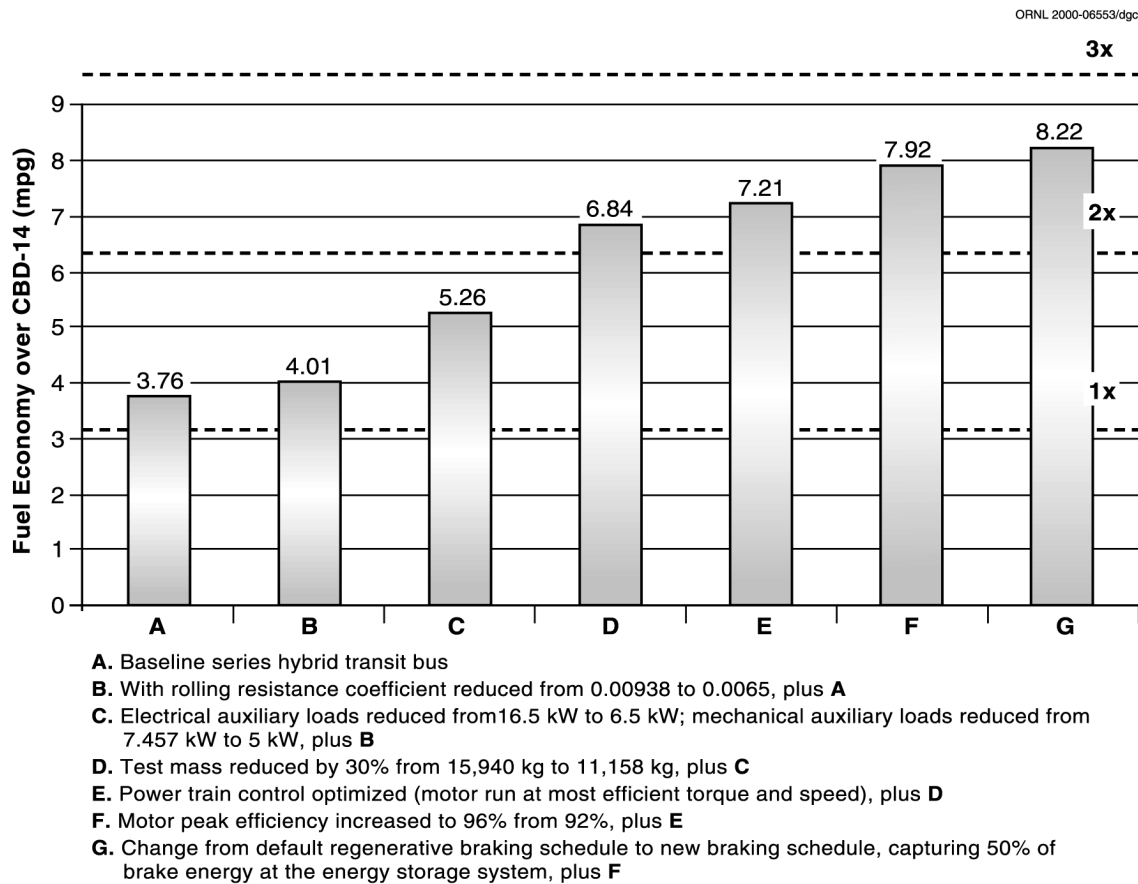

Fig. 4.4. Pathway for improving transit bus fuel economy.

Many other pathways are possible, and more analysis is needed to study design options, controls, and complex system trade-offs.

As discussed in Sect. 4.1 for large trucks, systems analysis will be used to guide the R&D for transit buses.

4.2.1 Vehicle Efficiency

Transit bus power requirements can be broken into four categories: power required to accelerate the vehicle to speed (a function of weight), power required to operate auxiliary systems (“hotel load”), power required to overcome aerodynamic drag, and power required to overcome rolling resistance (a function of weight) and drivetrain losses. Meeting the efficiency-improvement goals will require optimized vehicle, auxiliary, and energy-storage systems that are advanced beyond those currently employed on today’s hybrid electric vehicles (HEVs). Consequently, the twin pillars of lightweight vehicle structure and hybrid electric propulsion will form the foundation on which to build the technology base for transit buses of the future. An opportunity exists to improve the efficiency of transit buses because little improvement in power-train design or efficiency has occurred in the past decade. To increase overall propulsion efficiency and reduce emissions, engine transient operating conditions must be minimized. To accomplish this, engine speed and load must be independent of drive-wheel speed and required tractive effort. By optimizing vehicle design, together with power-train efficiency improvements, the transit bus can be significantly improved in overall operational efficiency. Hybrid electric or mechanical hybrid propulsion provide a practical means of decoupling engine power demand from the drive wheel power required. For a detailed discussion of hybrid technology, see Sects. 4.6.4 and 4.6.5.

4.2.1.1 Power-Train Efficiency

Hybrid electric propulsion functions comprise a critical path to achieve major improvements in efficiency and systems operation. Within a series configuration, in addition to decoupling the engine from the drive wheels, auxiliary systems can also be decoupled from the engine, adding to overall efficiency. Within a parallel configuration, the electric motor supplements the engine to provide a broader, high-efficiency operating zone and to provide the possibility to optimize the system globally. Power-split configurations similar to the Toyota Prius system should also be taken into account. The electric traction motor is also designed to function as a generator during deceleration, converting the vehicle’s kinetic energy into electrical energy and slowing the vehicle without using friction brakes. Hybrid electric power trains also make it possible to use other energy-conversion devices, such as gas turbines or fuel cells.

The data in Table 4.4 are preliminary performance requirements that can in turn can be used to identify the propulsion system power, torque, and energy-storage requirements for the 21st Century Truck Program transit bus. Many of the requirements were either taken directly from the APTA guidelines (APTA 2000b) (environment, acceleration, and braking) or are modified APTA requirements (top speed and gradeability). Others were derived from existing 21st Century Truck Program simulation data/goals and/or reasonable estimates of performance conditions.

4.2.1.2 Parasitic Losses

Parasitic losses include all power requirements on the bus, including aerodynamic resistance, rolling resistance, driveline losses, and accessory loads.

Aerodynamic Resistance

The urban driving cycle consists of stop-and-go operation with a maximum vehicle speed of 20 mph. This reality, as well as the need to maintain interior space, is reflected in the boxy shape of conventional transit buses. Although aerodynamic losses may be minimal in the project driving cycle, the thermal loads of

Table 4.4. Preliminary performance requirements for the 21st Century Truck Program (Class 7) transit bus

Environment, normal operation ^a	
Ambient temperature range, °F	-10 to 115
Relative humidity, %	5 to 100
Altitude, ft above sea level	Up to 3,000
Weights	
Max estimated GVWR, lb (kg)	33,000 (14,966)
Min capacity, lb (kg)	11,000 to 12,000 (4,989 to 5,442)
Max estimated CW, lb (kg)	20,000 to 22,000 (9,070 to 9,977)
Top Speed @ GVWR, 0 % grade, full accessories ^{b,c}	
Intermittent, mph	65 for 600 seconds (10.8 miles)
Continuous, mph	55
Acceleration @ GVWR, 0% grade, full accessories ^{b,c}	
mph	0-10
5 seconds	0-20
10.8 seconds	0-30
20 seconds	0-40
31 seconds	
Gradeability @ GVWR, full accessories ^{b,c}	
	Intermittent
	40 mph on 2.5% grade for 270 seconds (3.0 miles)
	7 mph on 16% grade for 260 seconds (0.5 miles)
	Continuous
	35 mph on 2.5% grade
	7 mph on 16% grade
Startability @ GVWR, full accessories ^{b,c}	
	20% grade
Estimated accessory load, kW	
Max	35-40
Min	2-3
High avg	10-18
Low avg	3-10
Braking	
	16% stops at 3 ft/second ²
	50% stops at 6 ft/second ²
	26% stops at 9 ft/second ²
	8% stops at 12 ft/second ²

^aSpeed, gradeability, and acceleration performance will be met at, or corrected to, 77°F, 29.31 in. Hg, dry air.

^bComponents included in the “full accessories” condition need to be determined for each operating scenario.

^cInitial condition. Performance assumes energy storage @ 75% of useable energy.

new technology are becoming an increasing concern. Some aerodynamic modeling to improve airflow and air quality to the cooling systems will improve the commercial viability of these technologies.

Rolling Resistance

Rolling resistance is a function of axle, wheel, tire and drive shaft mass, together with sealing and lubricating these components. Special attention must be paid to the force necessary to make the bus move. For example, this may require research on complete brake shoe release after releasing the brake pedal. Developing seals that are durable but do not leak and do not contribute to the bearing torque would also be desirable. Power requirements attributable to rolling resistance can also be further reduced by the use of radial tires and “super-single” tires in place of the rear duals. There has already been a major shift toward use of radial tires instead of bias-ply tires in transit buses and trucks. The super single offers less rolling resistance than duals. It is an available technology offering fuel savings of a few percent. Among the concerns with the super single is the lack of redundancy in the event of a failure. The super singles are

also taller than other radials, thus reducing the interior volume of the bus and passenger capacity. They were first used on experimental buses.

Driveline Losses

Driveline losses in a series hybrid configuration are mostly electrical and result in component heating. Many of the new engine emission reduction strategies such as EGR will require more heat rejection. Typically, the overall heat rejection through the radiator and the charge air cooler is about 10,000 Btu/min. The engine manufacturers are forecasting a 25 to 30% increase in heat rejection to the coolant and a 10 to 13% increase in the charge air cooler.

Accessory Loads

Accessory power requirements contribute significantly to overall energy usage of buses. The actual power requirement is in the 30- to 40-kW range for a heavy-duty, 40-ft transit bus, depending on which auxiliaries are in use; however, it is a constant draw on the propulsion system, consuming substantial total energy. In some urban duty operations, energy for accessory load can surpass energy required for propulsion over the course of a day. One analysis indicated that for a Class 7 vehicle, an additional 5-kW accessory load is equivalent to a 20% decrease in propulsion efficiency. This accessory load may increase when engine-driven pumps and fans are electrically driven.

On conventional transit vehicles the engine directly drives all major vehicle auxiliary systems, generally through mechanical belt drives or through a power take-off. Consequently, the functionality, design, sizing, and efficiency of the auxiliary systems are directly dependent on the operating speed of the engine. Auxiliary systems must be able to operate over the relative speed range of the engine, from idle to redline. The widely variable speed of operation means that auxiliary systems (pumps, compressors, alternators, and fans) must be designed to perform adequately at all operating speeds with the common design point being engine idle. This demand has created an operating mode of high engine idle that is used by drivers when in heavy traffic or idling at the curb for extended periods. This mode improves bus compartment cooling and heating and may be necessary to meet the air pressure recovery times in the brake system. Low engine speed operation forces designers to make compromises, resulting in larger, heavier, and less efficient components compared to operation at optimum speed, discrete speeds, or zero speed if they are not needed.

Engine-driven accessories have remained essentially unchanged for several decades. Air compressors and refrigerant compressors, which are of a reciprocating type, are large and heavy, and have poor noise and vibration characteristics. None of these attributes is considered desirable by the public transit community. Power steering is provided by an engine-driven hydraulic pump with the pressurized fluid routed to the power steering unit in the front of the vehicle and then returned to the pump. Hydraulic systems are generally inefficient and prone to leakage.

Technical targets. To consider achieving the efficiency goal of 3× current fuel economy, a hybrid propulsion system must be used. Both mechanical and electrical hybrids are being considered, the electric hybrid being the predominant choice. With an electric hybrid, all accessories can be driven electrically—power steering pump, air compressor, battery cooling fans, electronic cooling pumps and fans, and traction motor cooling pumps and fans. All are constantly energized and operating, with the exception of the air-conditioning system, which is demand-responsive.

Electric-accessory drives afford designers the capability to develop optimally efficient designs for auxiliary components and the flexibility to mount and package the systems away from the engine, in less hostile environments, and in locations that provide easy access for maintenance. Electric drive also provides the capability to operate the accessories independently of the engine in a demand-responsive mode, which saves considerable energy. Typical accessory technical targets are discussed below. In

addition, a typical target would be to reduce hotel energy load by 25% through the use of optimized electrically driven auxiliaries.

Fans and pumps. The propulsion system already monitors temperatures in traction batteries, power controls for traction, the auxiliary power system, and the traction motor. These temperature data would be used to provide control inputs to solid-state relays that would switch fans “on” or “off” as cooling demand increases or decreases, saving approximately 2 kW of power and lowering noise emissions. Demand-responsive variable-speed control of the electronics-coolant pump would save an additional 1 kW.

Air compressor. The existing constant-operation, cast-iron reciprocating air compressor would be replaced with a lightweight, quiet, low-vibration rotary-vane air compressor that is 25% more efficient when working. The compressor would also be operated with a demand-responsive on/off control, saving an additional 0.75 kW over the reciprocating device when not working.

Power steering. The existing constant-operation power-steering pump would be replaced with an electric-assist demand-responsive unit. This type of unit is available for light automotive applications, but no such unit currently exists for heavy-duty vehicles. This could be due to the fact that the electrical power requirements for such a device cannot be met by conventional vehicle electrical systems. Two companies currently produce automotive electric-assist steering and would be likely candidates for the development of heavy-duty units. The working power savings of this electric-assist unit are unknown at this time. However, when the unit is performing no work (i.e., no steering input when the vehicle is driving straight or at idle), the power savings is in excess of 0.90 kW.

Accessory drive motors. Individual direct-drive motors sized for each accessory’s power requirement would mitigate low-load efficiency effects experienced with the large single motors currently used.

4.2.1.3 Mass Reduction

Power required to accelerate a vehicle and overcome rolling resistance is directly proportional to vehicle weight. The power required for acceleration and gradeability decreases commensurately with decreasing weight, thus reducing fuel consumption and emissions. This relationship between weight and propulsion power is of major significance in increasing fuel efficiency from the current 3 mpg to 6 mpg. However, in the past, far too little emphasis has been placed on vehicle weight control for such reasons as policies and regulations, available funding and incentives, institutional reluctance, a risk-averse industry, and the heavy vehicle industry’s limited knowledge and experience in alternative construction and materials. The goal is to reduce the gross vehicle weight rating (GVWR) of an existing 40-ft urban transit bus by about 20% from 32,000 lb (14,512 kg) to the target weight of 24,600 lb (11,156 kg). This weight reduction alone will result in at least a 20% improvement in fuel efficiency at gross weight.

4.2.2 Emissions

Emission requirements for automobiles are determined on a gram per mile (g/mi) or “vehicle” basis while transit bus and truck emissions are determined on a gram per brake horsepower-hour (g/bhp-h) or “component” basis. See Sect. 4.1.2 for more detailed information on engine emissions regulations.

The currently used component protocol does not account for significant emission benefits that are achievable through the implementation of advanced vehicle systems such as hybrid electric propulsion and lightweight vehicle structures and components. To ensure credit for the real-world emission reductions provided by advanced vehicle systems, an administrative change in the EPA certification procedure may be required to permit the emissions measurements to be vehicle-based, rather than engine-based. Technical targets for transit bus emissions are provided in Table 4.5. DOT, under its Advanced Vehicle Program and in conjunction with the Northeast Advanced Vehicle Consortium, has initiated an effort to address the issue of certification of hybrid electric transit buses. A working group comprising

Table 4.5. Summary of technical targets and barriers for transit bus emissions

Goals	Technical targets	Barriers
Establish EPA hybrid emissions protocol	Develop hybrid engine duty cycle for EPA emissions certification of hybrid vehicle engines.	Consensus among the industry and EPA on duty-cycle. Institutional bureaucracy
Demonstrate NO _x and PM aftertreatment w/ fuel reformulation	EPA proposal: max of 0.2 g/bhp-h NO _x and 0.01 g/bhp-h particulate matter in 2007 CARB Public Transit Bus Fleet Rule and Emissions Standards for New Urban Buses	Cost, durability, of lean combustion NO _x catalyst/ PM filter. Cost, lubricity, availability of reformulated fuels

government regulators, including EPA and the California Air Resource Board (CARB), and industry participants, has agreed on an interim engine test cycle for engines used for hybrid transit buses. The working group will continue to address the issue of a specific hybrid engine test cycle for certification and a chassis test procedure as well.

4.2.3 Bus-Related Safety

The greatest risk involved with the operation of transit buses is hitting pedestrians. Technology to assist the driver in avoiding pedestrians will be considered in the program. Fatality rates and injury rates for drivers and passengers are extremely low for transit buses because buses normally travel at low speeds. Efforts to improve crash avoidance and crash protection will likely be given low priority.

Safety issues concerning the use of alternative fuels, particularly those related to pressure vessels for compressed natural gas, must be considered.

The introduction of new technology, such as hybrid electric power trains, brings new hazards that must be addressed. Safety issues related to hybrid electric power trains are discussed in Sect. 4.6.4.4.

4.3 MEDIUM TRUCK—ENCLOSED, SINGLE-AXLE DELIVERY TRUCK

The medium truck category consists of vehicles whose size is larger than a pickup truck but significantly smaller than a tractor-trailer type rig. With load-carrying capability roughly proportional to size and number of axles, the medium class has more capability than a pickup truck but considerably less capability than a tractor-trailer.

As the large tractor-trailer class is the prime choice in the interstate movement of product, the medium truck class vehicle is the best fit for the pickup and delivery of goods in the urban areas. Its medium size makes it maneuverable in congested areas, and it has significantly more load-carrying capacity than a pickup truck or van. In addition to pickup and delivery service, the medium truck also serves as the prime building platform for vocational trucks such as utility and crane trucks, beverage trucks, fuel haulers, oil field rigs, dump and refuse trucks, and even school buses. Also, the medium truck is usually the base platform for military truck applications of the 2.5-ton and select 5-ton classifications.

For the 21st Century Truck Program, the specific vocation being considered for the medium truck is the common dry van as pictured in Fig. 4.5. Truck classification terminology defines this specific product as a Class 6 vehicle with gross weight carrying capability of 19,000 to 26,000 lb (8,617 to 11,791 kg). The rationale for selecting this group of vehicles for the 21st Century Truck Program is discussed in Sect. 3.1.



Fig. 4.5. Common dry van.

The goals of the 21st Century Truck Program with respect to medium trucks are to develop by 2010, enabling technology for medium-size delivery trucks that will result in an increased fuel efficiency approaching a factor of three over a typical drive cycle, meet prevailing emission standards while using petroleum-based diesel fuel, and simultaneously improve their safety. Achieving these goals will require significant improvements in several technology areas, including improvement of power-train efficiency, reduction in parasitic losses, and reduction in vehicle mass. As discussed for large trucks (see Sect. 4.1), systems analyses will be conducted to guide the R&D for medium trucks.

Many variables affect the fuel economy of delivery trucks. For example, factors such as traffic congestion, hilly terrain, and variations in loads (both among vehicles and for a given vehicle during the course of the day) have a major impact on fuel economy; therefore, it is difficult to describe a “typical” drive cycle for a delivery van. However, for establishing a baseline fuel economy for medium trucks, a driving and use cycle often used by manufactures and operators of medium-sized trucks was used. The estimated distribution of energy losses for such operations is discussed in Sect. 4.3.1.

4.3.1 Vehicle Efficiency

4.3.1.1 Truck Description

Medium Truck Fuel Usage

The Class 6 medium truck group is the second largest consumer of diesel fuel in the United States according to the VIUS data base, behind only the Class 8 group. It is for this reason that the Class 6 vehicle was chosen as one of the target groups for the 21st Century Truck Program.

Bureau of Census VIUS information shows that 1.75 million Class 6 medium type trucks were registered in the United States as of 1997; this number is conservative with respect to today, considering that the truck business has seen close to record sales for the last 3 years in a growing national economy. Given the popularity of these medium models and the recent growth trends, total registrations for Class 6 medium trucks are estimated currently to be more than 2 million units. Total quantity of diesel fuel consumed in 1997 for the Class 6 national fleet was approximately 3.5 billion gallons. Factoring in growth trends, the fuel usage figures as of this writing are even higher.

The VIUS data base shows the average fuel consumption for the entire national Class 6 fleet to be 7.2 mpg. The range of data is broad and extends from 6.6 mpg for the off-highway segment to 12.8 mpg for the very light load segment. For the purpose of this analysis, the baseline figure is 7.2 mpg; this value agrees closely with computer model results for vehicles with typical medium truck missions and specifications.

Typical Mission of the Medium Truck

Understanding the mission of the typical medium truck is important in determining the key parameters for setting the roadmap to the future. To accomplish this, a computer model was used to simulate the mission of a typical medium truck; experience has shown this model to be very accurate because the mission profiles in the system are based on real-world data from actual truck users. All truck and engine manufacturers regularly use these types of models; they are considered state-of-the-art analysis tools for designers and engineers. Analysis of the model information, combined with the wealth of practical experience and expertise that truck manufacturers have with this vehicle segment, provides an accurate picture of the operation of the typical Class 6 medium truck in urban pickup and delivery service.

Mission information from the computer model for a typical Class 6 vehicle under different driving cycles is shown in Table 4.6.

Table 4.6. Mission information for typical Class 6 vehicles

	City	Suburb	Highway
Mission time (min)	30	52	173
Fuel use (mpg)	6.7	8.7	8.5
Average speed (mph)	18.6	39.5	54.6
Load factor on engine (%)	24.2	39.8	56.3
Average hp for mission	47	78	110

Specifications of the Typical Medium Truck

The hardware specifications for medium trucks vary considerably and depend on the specific vocation, geographic location, and customer preferences. Generally speaking, all or most Class 6 vehicles are diesel-engine powered, with horsepower ratings ranging from 175 to 250 hp. Transmission usage is equally split between manual and automatic, but the clear market trend is toward the automatic. Empty weight for the Class 6 medium truck is typically 12,000 lb (5,442 kg), which means that the maximum payload for this class is 14,000 lb (6,349 kg). Middle-of-the-road specifications for the Class 6 dry van target application is given in the following list:

- Class 6 dry van with 19,000 to 26,000 lb (8,617 to 11,791 kg) GVW;
- power train typically includes six- to eight-cylinder diesel engine;
- both manual and automatic transmissions are common; automatic usage is rising;
- single rear axle;
- city pickup and delivery, stop and go driving;
- transient engine operation;
- typical 25 mph average speed; 30,000 miles/year;
- empty weight ~12,000 lb (5,442 kg); and
- average mpg = 7.2 (from 1997 VIUS).

Energy Usage for Medium Trucks

Medium truck fuel efficiency is influenced by several factors, including basic vehicle design, mode of operation, driver technique, and weather factors. Figure 4.6 and Table 4.7 contain an energy audit, a breakdown of energy requirements, of a typical Class 6 delivery truck. For first-order considerations, the vehicle is operating at a steady speed of 40 mph, typical of the average speed in a suburban environment, with a GVW of 26,000 lb (11,791 kg). A comparison of baseline fuel economy for a steady 40 mph (10 mpg) with the VIUS data (7.2 mpg) representing actual usage shows that the stop-and-go driving typical of the medium truck's normal pickup-and-delivery cycle is much less fuel efficient.

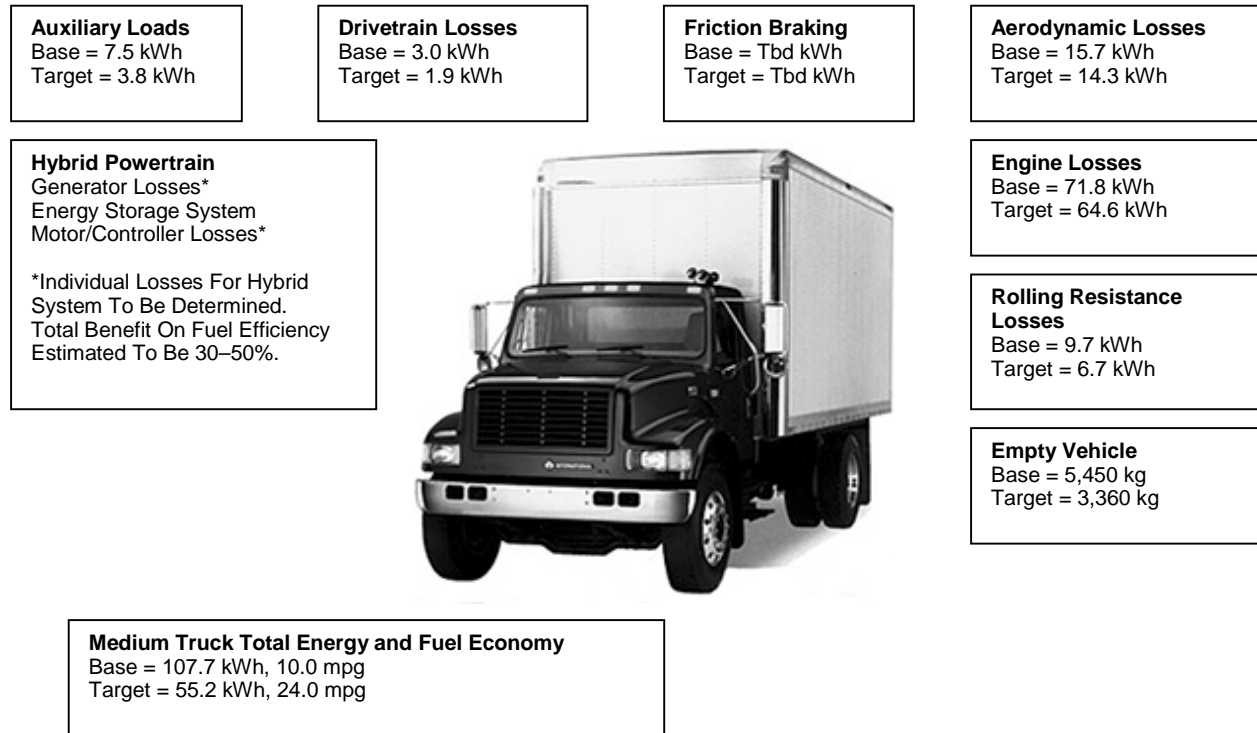

Fig. 4.6. Typical medium truck—Class 6 enclosed van; distribution of energy requirements at 40 mph for a 26,000 lb (11,791 kg) vehicle.

The medium delivery truck presents an opportunity for significant improvement in efficiency. To increase overall propulsion efficiency and reduce emissions, engine transient operating conditions must be minimized. To accomplish this, engine speed and load must be independent of drive-wheel speed and required tractive effort. By optimizing vehicle design, together with improvements in power-train efficiency, the delivery truck can be significantly improved in overall operational efficiency. Given the duty cycle typical for these vehicles, hybrid electric or mechanical hybrid propulsion is a practical means of decoupling engine power demand from the drive-wheel power required and should yield significant increases in vehicle efficiency. For a detailed discussion of hybrid technology, see Sects. 4.6.4 and 4.6.5.

Engine losses, inertial resistance, and tire-rolling resistance, have significant effects on vehicle efficiency, whereas drivetrain friction is less significant. Aerodynamics, a major factor for line-haul trucks, plays only a minor role for delivery trucks because they have much slower operating speeds. However, relative energy usage for engine-based accessories, such as compressors and alternators, can be a major factor for medium truck operations. For low-power operations, such as the city missions (see Table 4.6), the auxiliary loads (ranging up to 15 hp) can represent a fairly large percentage of overall mission

Table 4.7. Typical medium truck—Class 6 enclosed van distribution of energy requirements for a fully loaded 26,000 lb (11,791 kg) enclosed van at 40 mph

	Baseline	Improvement (%)	Target
Engine losses (kWh)	71.7	10	64.6
Auxiliary loads (kWh)	7.5	50	3.8
Drivetrain losses (kWh)	3.0	37	1.9
Aerodynamic losses (kWh)	15.7	9	14.3
Rolling resistance losses (kWh)	9.7	31	6.7
Hybrid power train ^a	TBD	TBD	TBD
Total energy used (kWh)	107.7	48.7	55.2
Fuel consumption at 40 mph (mpg)	10.0		19.5
Fuel economy multiplier	1.0		1.95
Empty vehicle weight (kg)	5,450.0	28	3,600.0
Effect of weight reduction on fuel economy	1.0		1.22
Total fuel economy multiplier	1.0		2.4

^aIndividual losses for hybrid system to be determined; benefit of hybrid power train on fuel efficiency estimated to be 30 to 50%.

requirements. It follows, therefore, that improvements in engine efficiency, weight reduction, tire-rolling resistance, and accessory efficiency can have a significant impact on medium truck fuel efficiency while improvements in its drivetrain and aerodynamics will have a smaller influence. Nevertheless, any improvement in efficiency should be actively pursued if the cost-to-benefit relationship is favorable.

4.3.1.2 Power-Train Efficiency

Analysis of Operation, Typical Class 6 Medium Truck

Mission information for the typical urban/suburban cycle for the Class 6 medium truck shows that only 50 to 80 hp, on the average, is required from the engine for the vehicle to perform the mission. Actually, more horsepower is required to cover the peak demands of the vehicle, such as when accelerating or passing, but on the average, the power requirements are quite low relative to what is required to sustain speed for continuous highway operation.

A comparison of the average power requirements for the city cycle to the friction horsepower for the typical medium truck diesel engine (Fig. 4.7) shows that roughly the same horsepower is required to perform its mission (47 hp) as is required to overcome the engine's friction at 2,000 to 2,500 rpm (typical for city driving). This means that half the fuel burned in a typical city duty cycle is used simply to overcome the engine's friction. This suggests that from a fuel economy standpoint, the engines in today's current medium trucks, which are sized to provide the maximum power required only occasionally, are too large relative to their typical mission, thereby wasting a lot of fuel just in overcoming the engine's friction during normal operation.

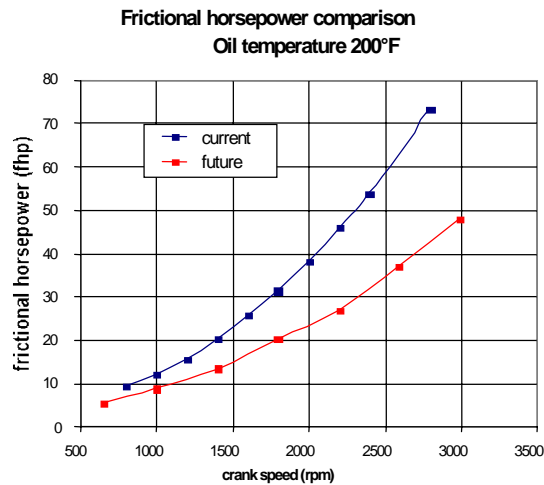

Fig. 4.7. Friction power requirements of typical medium truck engine as a function of rpm.

For a delivery truck on an urban cycle, torque—not horsepower—is what is really required to accelerate the mass of the vehicle to perform the mission. Today, this torque is produced primarily by the engine; in the future, to save fuel by downsizing the engine, the torque must come from something other than a large engine.

It is anticipated that a hybrid power system will be required to simultaneously reduce fuel economy and provide high power and torque when needed. Some of these needs may be met by using a CVT to maximize torque with either an optimized diesel engine or full hybrid power system. The engine can then be optimized to operate at a very specific speed and load point for best fuel economy and emissions. Given the typical mission for the medium delivery truck, it is anticipated that a 3- to 4-L diesel will be sufficient as a source of primary power in a hybrid system. It may be possible to reduce the size and weight of the engine even further while boosting its torque and overall efficiency by advanced turbocharging that utilizes electrically assisted, high-pressure ratio, wide-flow-range systems.

The engine can be decoupled from the drive wheels in hybrid systems; in addition, auxiliary systems can be decoupled from the engine, permitting only on-demand usage and adding to overall efficiency. Moreover, the electric traction motor in a hybrid system is also designed to function as a generator during deceleration, thus converting a portion of the vehicle’s kinetic energy back into electrical energy, and slowing the vehicle in conjunction with downsized friction brakes. Typical propulsion power requirements that any new power train would have to provide for a medium truck under varying conditions are shown in Table 4.8.

Further information on barriers to and technical approaches for optimization of the engine, hybrid drive trains, and auxiliary power sections can be found in sections on internal combustion engine (Sect. 4.6.2), hybrid electric power trains (Sect. 4.6.4), mechanical hybrids (Sect. 4.6.5), and auxiliary power (Sect. 4.6.7).

4.3.1.3 Vehicle-Related Losses

Vehicle-related losses include aerodynamic resistance losses, rolling resistance losses, driveline losses, and accessory losses.

**Table 4.8. Medium truck power requirements
[Class 6, 26,000 lb (11,791 kg) max GVW]**

Speed (mph)	Power requirement (hp)	
	100% load	80% load
<i>Steady speed</i>		
30	28	25
40	51	47
50	85	80
60	133	127
<i>Maximum horsepower for reserve, passing, grades, etc.</i>		
	185	175

Aerodynamic Resistance

Mission analysis also tells us that for urban pickup and delivery, the average vehicle speed is less than 20 mph. This suggests that improvements to aerodynamics (drag) will not improve fuel economy much as compared to the Class 8 highway application that operates at high vehicle speeds for long periods of time. Instead, improvements should focus on reduction of rolling resistance (tires).

Rolling Resistance

Because rolling resistance is a major contributor to parasitic truck losses even at low speeds, it is an important factor to address for medium trucks. Further information on barriers to and technical approaches for minimizing rolling resistance are described in Sects. 4.1.1.2 for large trucks and 4.2.1.2 for buses. The technology developed to reduce rolling resistance in large trucks and buses will be applicable to the medium trucks.

Driveline Losses

The issues concerning driveline losses for the medium truck are very similar to those for the large tractor trailer as modified by concerns for inclusion of hybrid power systems. These issues are described for the line-haul and bus platforms in Sects. 4.1.1.2 and 4.2.1.2 and in the hybrid electric power-train technology crosscutting section (Sect. 4.6.4).

Accessory Loads

Accessory loads common to medium trucks include primarily engine-based components such as the alternator, air compressor, air-conditioning compressor, hydraulic pump, engine-oil and fuel pumps, and cab-related loads for heating and cooling. The maximum accessory power requirements for medium trucks typically range from 12 to 15 hp. At highway speeds, the accessory load for a medium delivery-type truck accounts for about 7% of fuel consumed by the vehicle, but in typical in-city use, consumption can climb beyond 30%.

Approaches to reducing these accessory loads involve decoupling accessories from dependence on direct engine speed and driving them electrically at variable speeds most conducive to energy-use reduction. The approaches described for the line-haul trucks (Sect. 4.1.1.2) and buses (Sect. 4.2.1.2) and in the auxiliary power technology crosscutting section (Sect. 4.6.7), will be applicable to medium trucks.

Mass Reduction

Overall weight reduction is a must for medium trucks, but neither structural integrity nor vehicle affordability can be compromised. Reduction of weight will improve fuel economy by increasing payload capability and by improving both ton-miles and mpg under empty and part-load conditions. The benefit of increased payload efficiency does not occur for loads that occupy maximum volumetric capacity of the vehicle before the maximum allowable weight is reached. In this case, only supplementary benefits are realized. Given that a significant portion of payload transported by medium trucks is limited by volume, particularly during multiple-stop delivery runs, estimates of the benefits of reduced tare weight need to reflect this reality. The goal is to reduce the unloaded weight of a typical medium truck delivery van by 33% from 12,000 lb (5,442 kg), to the target weight of 8,000 lb (3,628 kg). This weight reduction alone will result in approximately a 30% improvement in fuel efficiency.

The approaches to reducing vehicle mass along with their barriers and potential solutions, described for the line-haul trucks (Sect. 4.1.1.3) and buses (Sect. 4.2.1.3), and in the materials technology crosscutting section (Sect. 4.6.9), will be applicable to reducing vehicle mass in medium trucks.

4.3.2 Emissions

Emission reduction concerns, requirements, and approaches for solutions in medium trucks are very similar to those for line-haul trucks. See Sects. 4.1.2 and 4.6.3 for discussion of this topic.

4.3.3 Truck-Related Safety (Medium Trucks)

Compared to the number for Class 8 heavy-duty trucks, the number of people killed each year in crashes involving medium-duty single-unit trucks is fairly small (about 300 for Classes 5 and 6 combined). This is primarily due to the fact that these trucks typically operate in a lower-speed urban, daylight setting. About 20% of those fatalities are occupants of the truck, 70% are occupants of other vehicles involved in the same crashes, and 10% are nonoccupants. Even though the operational use patterns of this platform differ from that of the tractor-trailer platform, the crash avoidance safety issues are similar. The primary focus should be on braking, visibility, and rollover. This sector of the market is usually not large enough to support the development of separate safety technologies; however, the improvements made in light vehicles and heavy trucks will also benefit medium-duty trucks. In braking, this category of trucks uses mostly hydraulic brakes, but some of the heavier ones use air or air-over-hydraulic brakes. Although disc-brake technologies exist for this platform, they are seldom used because of their cost. Usage for these trucks is more urban and at slower speeds than for tractor-trailers, so aerodynamic braking would probably not be worthwhile. However, electric and hybrid power plants will allow regenerative braking to decrease the burden on the foundation brakes. The potential for additional electrical hazards associated with hybrid electric power trains will exist for those medium trucks with such systems. A discussion of the electrical safety issues associated with hybrid electric power trains can be found in Sect. 4.6.4.4.

As discussed in Sect. 4.1.3 for large trucks, the primary crash survivability emphasis will be to improve the likelihood that occupants of other vehicles involved in collisions with the trucks will survive. Many of the same technologies and approaches used for heavier trucks could also be applied. Because the mass ratio between the truck and other smaller vehicles will not be quite as great, there is a better chance of success. Although truck occupant fatalities for this type of truck are very low, truck occupant crashworthiness improvements achieved on the tractor trailer platform could be applied here because the chassis and cabs are often the same or similar. In addition to cost and operational practicability/durability considerations, weight as well as vehicle length increases need to be either minimized or counterbalanced to offset cargo capacity losses.

4.3.4 Summary of Potential Efficiency Benefits

To meet the aggressive 21st Century Truck Program fuel economy targets set forth by the Committee, major changes are required in the Class 6 medium truck as we know it today. To make these changes possible, the industry must commit to significant paradigm changes in the major systems of the vehicle, and then implement these changes via new and breakthrough technologies. By system, these high-level changes are as follows:

- The current power train must be replaced by a hybrid system employing a smaller engine supplemented by an electric motor and/or a new type of transmission with continuously variable ratio.
- Empty chassis weight must be reduced significantly to improve payload and reduce power requirements during part-load and empty operation; system structural integrity cannot be compromised.
- Vehicle rolling resistance must be improved to reduce system power requirements; this requires breakthroughs in tire technology.
- Engine emissions must be reduced using aftertreatment and very low sulfur content fuel. Engine brake-specific fuel consumption (BSFC) and emissions must be optimized at or near constant speed consistent with hybrid drive.

Baseline values and targets for improvements of aspects of medium trucks related to fuel efficiency and emissions for medium trucks on realistic operating cycles are summarized in Table 4.9. The effects of those target changes on vehicle fuel efficiency are shown in Table 4.10.

Table 4.9. Design metrics for current and improved Class 6 medium trucks

	Current	Future target
Fuel consumption (mpg)	7.2 typical	17.0 (corrected to 21.6 with payload)
Weight, unloaded, lb (kg)	12,000 (5,442)	8,000 (3,628)
Engine displacement (l)	6.0 to 8.0	3.0 to 4.0 with hybrid drive
Engine weight, lb (kg)	1,000–1,300 (454–590)	600 max (272)
Aero drag coefficient (C_d)	0.6	0.5 or better
Rolling resistance, lb (kg)	4.9/1,000 (2.2/454) avg	3.0/1,000 (1.4/454)
Overall driveline eff (%)	90	95
BSFC, minimum	0.340	<0.300
Engine emissions (g/hp-h)		
NO _x	<4.0	2.0 g max engine out w/90% aftertreat
PM	<0.1	95% aftertreat filtration; <15 ppm sulfur fuel
HC	<1.3	

Table 4.10. Potential for fuel-efficiency improvements for medium trucks

Change	Reduction in energy usage (%)	Fuel efficiency multiplier
Engine improvements	10	1.10
Reductions in aerodynamic, rolling resistance, drivetrain, and auxiliary load losses	26	1.26
Hybrid power train	30–50	1.40
Mass reduction and payload improvements	28	1.22
Total		2.4

4.4 SMALL TRUCK—“WORKING” PICKUP (>8500 lb GVW)

For the purposes of the 21st Century Truck Program the Small Truck platform is defined as Class 2b vehicles used in commercial applications and does not include personal-use vehicles. In this vehicle class, the predominantly produced vehicle is the common gasoline-powered pickup truck that is utilized as a small business work truck. Also included in this class are trucks (e.g., panel vans, pickup truck cab-chassis, cutaways) that would have third-party, task-specific bodies installed. Although diesel engines are available, they represent less than one-quarter of total production.

The original stated goal for the small truck platform is to achieve a 3× improvement in fuel economy by the year 2010. The ability to achieve this aggressive goal based upon available or known technology has not been demonstrated. It is important to note that overall vehicle performance requirements must not be sacrificed because doing so would adversely affect the vehicle’s marketability. To meet this aggressive goal in a cost-effective way will require major scientific breakthroughs in several technology areas, including improved power-train efficiency, reduction in parasitic losses, and reduction in vehicle mass that are not known at this time. The proposed 21st Century Truck small truck research program may bring about the necessary breakthrough technologies.

Many variables can affect the fuel economy of small trucks. Factors such as overall basic vehicle performance requirements, trailer-towing capability, and off-road capability have major impacts on basic vehicle design and therefore significantly influence the vehicle’s overall potential fuel economy. Currently, no fuel-economy requirements are mandated for Class 2b vehicles, and emissions certification is done by engine dynamometer test utilizing the Federal Heavy Duty cycle. This emissions certification requirement is expected to stay the same for Class 2b diesel-powered trucks within the 21st Century Truck time frame. For the purpose of this roadmap, the Federal Urban Driving Schedule (FUDS) and the Highway Fuel Economy Test (HWFET) on a chassis dynamometer were used to compute fuel economy. When subjected to this test regimen via modeling, today’s typical gasoline-powered Class 2b truck would achieve approximately 12.1 mpg city, 15.4 mpg highway, and 13.6 mpg combined.

The specific technical targets for the small truck platform are expected to achieve an increase in combined fuel economy from 13.6 mpg to 20.4 mpg by 2007 (1.5×), to achieve an increase in fuel economy to 26.0 mpg by 2010 (1.9×) and to lay the foundation to achieve a long-term-stretch goal of 30.0 mpg. Based on a parallel hybrid power train, the projected aggressive improvements in the various technology areas required to approach the 2010 (1.9×) fuel economy goal are listed in Table 4.11. (All individual improvements are not necessarily cumulative.)

As discussed in Sect. 4.1 for large trucks, systems analyses will be conducted to guide the R&D for small trucks.

4.4.1 Vehicle Efficiency

The small truck platform has seen continuing improvement in fuel efficiency in the past decade as a spin-off of that achieved in Class 1/2a trucks. To increase overall propulsion efficiency and reduce emissions, transient engine operating conditions must be minimized. To accomplish this, engine speed and load must be independent of drive-wheel speed and required tractive effort. By optimizing vehicle design, together with improving power-train efficiency, the small truck can be improved significantly in overall operational efficiency. Hybrid propulsion is a practical means of decoupling engine power demand from the required drive wheel power. For a detailed discussion of hybrid technology, see Sects. 4.6.4 and 4.6.5.

4.4.1.1 Power-Train Efficiency

Significant gains in fuel efficiency can be made by switching from gasoline engines to diesel engines in Class 2b vehicles. Coupled with hybrid propulsion, the diesel engine is considered to be the technology

Table 4.11. Distribution of energy requirements (kWh) for a typical small truck (Class 2b commercial pickup), EPA combined driving cycle

	Base line (SI)	Improvement (%)	Target
Engine losses (kWh)	16.76	56.2	7.35
Auxiliary load losses (kWh)	0.25	57.4	0.10
Drivetrain losses (kWh)	2.66	13.1	2.31
Aerodynamic losses (kWh)	1.08	22.4	0.84
Rolling resistance losses (kWh)	0.69	31.8	0.47
Friction braking (kWh)	0.43	96.3	0.02
Hybrid power train (parallel)			
Generator losses (kWh)			
ESS losses (kWh)			0.09
Motor/controller losses (kWh)			0.54
Total energy used (kWh)	15.81	46.4	11.71
Vehicle weight (empty) (kg)	2,650 (2,514+136)		2,147 (2,011+136)
mpg over EPA combined drive cycle	13.4155	91.4	25.6823
Fuel economy multiplier	1.0		1.9 ^a

^aIncludes 5% improvement in fuel economy resulting in 20% reduction in vehicle weight.

that will yield the most cost-effective solution to achieving the vehicle fuel efficiency targets in the 2010 time frame. Hybrid propulsion is a critical-path technology, providing for other major improvements in efficiency and systems operation in the small truck. In addition to the engine's being decoupled from the drive wheels, auxiliary systems can also be decoupled from the engine, adding to overall efficiency.

4.4.1.2 Regenerative Braking

The hybrid motors are also designed to function as regenerators during deceleration, thus recovering the vehicle's kinetic energy into stored energy, slowing the vehicle without using friction brakes. There is, however, a practical deceleration limit in normal driving situations to which the driver and passengers can be subjected without discomfort or adversely affecting vehicle safety. In city driving, braking can waste up to 50% of the useful energy that the engine is able to provide to the wheels. Efficient regenerative braking can recover a significant portion of this energy for storage and later use.

4.4.1.3 Parasitic Losses

Parasitic losses include all power requirements on the small truck, including aerodynamic resistance, rolling resistance, driveline losses, and accessory loads.

Aerodynamic Resistance

Aerodynamics is important when considering the overall power requirements of the small truck platform. Also, the small truck will be subjected to FUDS and HWFET. These chassis dynamometer tests require coastdown testing to determine the road load horsepower of the vehicle at 50 mph in order to properly set the absorber. At this speed aerodynamics plays a significant role. Additionally, the thermal loads of new technology are becoming an increasing concern, especially the power electronics portion of an electrical hybrid drivetrain. Some aerodynamic modeling to improve airflow and air quality to the cooling systems will also improve the commercial viability of these technologies. The current pickup truck that is typical

of the many models available has a C_d of approximately 0.47. Because the basic nature of pickup truck design does not allow for very clean aerodynamic shapes, it is felt that an achievable stretch goal would be to reduce the C_d to 0.375, or a 20% reduction, in the 2010 time frame. It is felt that a longer-term stretch goal could be as much as a 30% reduction.

Rolling Resistance

Rolling resistance is a function of the interaction of the tire with the road surface and the characteristics of the tire itself that impact overall vehicle fuel efficiency. Tires that are used on current pickup trucks have a typical C_{rr} of 0.0069. Tire manufacturers are continually improving their product, and a reduction in tire C_{rr} to 0.0055, or 20% is considered an achievable stretch goal without impacting vehicle safety in the 2010 timeframe. It is felt that a longer-term stretch goal could be as much as a 40% reduction.

Driveline Losses

Driveline losses are a summation of clutch or torque converter, transmission, drive shaft, axle, and brake drag losses. Developing seals that are durable but do not leak and do not contribute to the bearing torque would also be desirable. More efficient transmissions such as CVTs are very desirable. Research on complete brake-shoe release after releasing the brake pedal is needed. For four-wheel-drive-configured vehicles the need for two-speed transfer cases requires evaluation because this feature, which is rarely used by most consumers, needlessly contributes to upsizing of drive shafts and drive axles and increases its own internal losses. Improved lubrication is also an area that can contribute to significant reduction in driveline losses. A 20% reduction in driveline losses is considered a realistic target for the 2010 timeframe.

Accessory Loads

The power requirement for accessories is a significant contributor to overall energy usage of vehicles. Although the actual power requirement is in the 1.5- to 25-kW range for a pickup truck, depending on which auxiliaries are in use, it is a constant draw on the propulsion system, consuming substantial total energy. On conventional vehicles the engine directly drives all major vehicle auxiliary systems, generally through mechanical belt drives. Consequently, the functionality, design, sizing, and efficiency of the auxiliary systems are directly dependent on the operating speed of the engine. Auxiliary systems must be able to operate over the relative speed range of the engine, from idle to redline. The widely variable speed of operation means that auxiliary systems (e.g., pumps, air-conditioning compressors, alternators, and cooling fans) must be designed to perform adequately at all operating speeds with the common design point being engine idle. This demand has created an operating mode of higher engine idle, which also aids in improving passenger compartment cooling and heating. The operation at engine idle forces designers to make compromises, resulting in larger, heavier, and less-efficient components compared to operation at optimum speed, discrete speeds, or zero speed if they are not needed. The use of hybrid power-train technologies creates the opportunity to shut the engine off when its power is not required. This feature would require accessories to be driven from the hybrid's alternative electrical or mechanical power source.

To minimize power requirements and to optimize component designs, all accessories (power-steering pump, cooling fans, cooling pump, and air-conditioning compressors) could be independently driven. The accessories themselves are simply electrically or mechanically driven versions of common engine-driven components with some reduction in size to reflect the higher operating speed. Independent accessory drives afford designers the capability to develop optimally efficient designs for auxiliary components and the flexibility to mount and package the systems away from the engine, in less-hostile environments and in easier-to-maintain locations. Independently driven accessories also provides the capability to operate the accessories independently of the engine in a "demand-responsive" mode, which saves considerable energy. Incorporating a 42-VDC vehicle electrical system instead of today's 12-VDC system will provide

additional efficiency improvements. A typical target would be to reduce engine accessory energy load by 35% through the use of optimized electrically or mechanically driven auxiliaries. The following are typical accessory technical targets.

Fans and pumps. The power-train system already monitors the temperatures of engine coolant and transmission oil. These temperature data would be used to provide control inputs to solid-state relays that switch fans “on” or “off” as cooling demand increases or decreases, saving approximately 2 kW of power and lowering noise emissions. For electric hybrids, demand-responsive variable-speed control of the hybrid electronics coolant pump would save an additional 1 kW.

Power steering. The existing constant-operation power-steering pump would be replaced with an electric-assist demand-responsive unit. This type of unit is available for light automotive applications today. The total working power savings of this electric assist unit is unknown at this time. However, when the unit is performing no work (i.e., no steering input when the vehicle is driving straight or at idle), the power saving is in excess of 0.90 kW.

4.4.1.4 High-Performance Thermal Management

High-performance thermal management focuses on minimizing the auxiliary load requirements for heating, ventilation, and air-conditioning (HVAC) systems while maintaining the thermal comfort of the vehicle occupants. Additional benefits in fuel efficiency can be achieved through the development of high-performance heat exchangers and cooling media (fluids), which will reduce the need for high-output engine water pumps. Numerous technologies have been identified, including direct heating and cooling of the vehicle occupants, eliminating in-dash venting systems, reducing vehicle peak and steady-state thermal loads, and employing heat-generated cooling techniques. Technologies for reducing the vehicle thermal (solar) loads include advanced window glazings, thermal insulation, and ambient cooling and ventilation systems. Additionally, heat generated in the vehicle cabin can be used in various cooling techniques, including metal hydride systems, absorption, desiccant systems, and exhaust-heat waste-recovery systems.

4.4.1.5 Mass Reduction

Vehicle acceleration and rolling resistance are linked through the common physical property of mass, or weight. The power required to accelerate the vehicle and overcome rolling resistance is directly proportional to vehicle weight. By decreasing weight, the power required for acceleration and gradeability decreases commensurately, thus reducing fuel consumption and emissions. This relationship between weight and propulsion power is of major significance in increasing fuel efficiency. However, in the past, far too little emphasis has been placed on vehicle weight control for such reasons as policies and regulations, available funding and incentives, institutional reluctance, a risk-averse industry, and the industry’s limited knowledge and experience in alternate construction and materials. The goal is to reduce the curb weight of typical Class 2b pickup trucks by 20%, from 5,540 lb (2,512 kg) to the target weight of 4,430 lb (2,009 kg). This weight reduction alone will result in at least a 15% improvement in fuel efficiency.

4.4.2 Emissions

Emission requirements for automobiles and light-duty trucks are determined on a gram per mile (g/mi) or “system” basis while emission requirements from medium- and heavy-duty trucks and buses are determined on a gram-per-brake-horsepower-hour (g/bhp-h) or “component” basis. This component protocol does not account for significant emission benefits that are achievable through the implementation of advanced vehicle systems such as hybrid propulsion and lightweight vehicle structure and components. To ensure credit for the real-world emission reductions provided by advanced vehicle systems, an administrative change in the EPA certification procedure would be required to permit the emissions

measurements to be vehicle-based, rather than engine-based. It is contemplated that the emissions test protocol for Class 2b vehicles will change within the program time frame to a vehicle basis. Issues associated with hybrid vehicle testing and fuel composition still need to be addressed (see Table 4.12).

Table 4.12. Summary of technical targets and barriers for Class 2b truck emissions

Goals	Technical targets	Barriers
Establish EPA hybrid emissions protocol	Develop hybrid vehicle duty cycle for EPA emissions certification of hybrid vehicles engines	Consensus among the industry and EPA on duty-cycle. Institutional bureaucracy
Demonstrate NO _x and PM aftertreatment w/fuel reformulation	EPA proposal: max of 0.2 g/bhp-h NO _x and 0.01 g/bhp-h particulate matter in 2007 CARB diesel engine emissions standards	Cost, durability, of lean combustion NO _x catalyst/PM filter Cost, lubricity, availability of reformulated fuels

4.4.3 Truck Safety

4.4.3.1 Vehicle Design

The greatest improvement in vehicle safety for Class 2b vehicles will result from vehicle design that, where practical, incorporates all safety features required of passenger cars and light-duty vehicles. Additionally, to make the Class 2b vehicle more crash-friendly with passenger cars and other vehicles on the road, bumper heights should be required to be compatible.

4.4.3.2 Electrical Safety

The introduction of new technology, such as hybrid electric power trains, brings new hazards that must be addressed. Safety issues related to hybrid electric power trains are discussed in Sect. 4.6.4.4.

4.5 MILITARY VEHICLES

This section provides additional information regarding military requirements for the light, medium, and heavy truck platforms. These vehicles represent significant portions of the U.S. Army tactical truck fleet. The representative military light truck is the HMMWV M1097A2. For the medium truck, the representative military version is the 2-ton FMTV M1078. The military equivalent for the heavy truck is the M916A2 tractor-trailer. Preliminary analysis indicates that the military vehicles will derive benefits in fuel economy similar to those that commercial cousins would derive.

4.5.1 The Systems Analysis Process

The systems analysis process should encompass the following:

- deriving system requirements,
- using system requirements to set subsystem requirements,
- requirements review and prioritization, and
- requirements validation/verification.

This process is described in the sections that follow.

4.5.2 Deriving System Requirements

The process of deriving system requirements begins with the “voice of the customer.” The end user of any product from this initiative will essentially stipulate the criteria for purchasing the product upon the completion of the program. The user’s needs must be identified at the beginning of the process for it to be effective. A user might be willing to make a higher capital investment for truck having higher fuel economy, for example, if the return on investment is faster than a “standard” truck purchase. Typical user requirements might focus on vehicle performance, such as the use of a standard slack-adjusting hitch or the capability of hauling a 20,000-lb (9,070 kg) load up a 4% grade while maintaining a speed of 65 mph.

4.5.3 Analysis of Selected Current Military Vehicle Fuel Efficiencies

4.5.3.1 Driving Schedule

In the absence of any military dynamometer driving cycles other than the Munson Standard Fuel Course, FUDS was chosen for a preliminary analysis of the military vehicles. The Army provided data for the purpose of validating the vehicle models. After validation the models were used to predict fuel economy of the military trucks on the FUDS.

4.5.3.2 Light Truck

The military vehicle chosen to represent the Class 2b light trucks for this analysis is the HMMWV. The baseline characteristics of the HMMWV are listed in Table 4.13.

Table 4.13. HMMWV M1097 A2 specifications

Configuration	4×4 cargo/shelter/troop carrier
Engine manufacturer	GM IDI Diesel
Aspiration	Natural
Engine displacement (L)	6.5
Engine peak power (kW)	119 @3,400 rpm
Transmission	GMPT automatic
Number of gears	4
1st gear	2.48
2nd gear	1.48
3rd gear	1
4th gear	0.75
Final drive ratio	1.92 h 2.73 d 1.01 tc 5.29 overall
Empty vehicle weight (curb) (kg)	2,676
Gross vehicle weight (kg)	4,672
Frontal area (m ²)	3.58
Coefficient of drag	0.5
Wheel base (m)	3.3
Tire type	Goodyear radial 37×12.5 R16.5
Rolling radius (m)	0.4558
Coefficient of rolling resistance	0.013 paved/0.045 off road
Acceleration 0–30 mph (second)	10
Acceleration 0–50 mph (second)	29
Idle speed (rpm)	700

On the basis of using validated models, a simulated weight of curb plus 2/3 maximum cargo, and the FUDS drive cycle, the resulting fuel economy in ton mpg was 13.4 (9.1 mpg). Figure 4.8 shows an energy balance/distribution of the simulation. Simulated accessory loads were only to those required to run the engine.

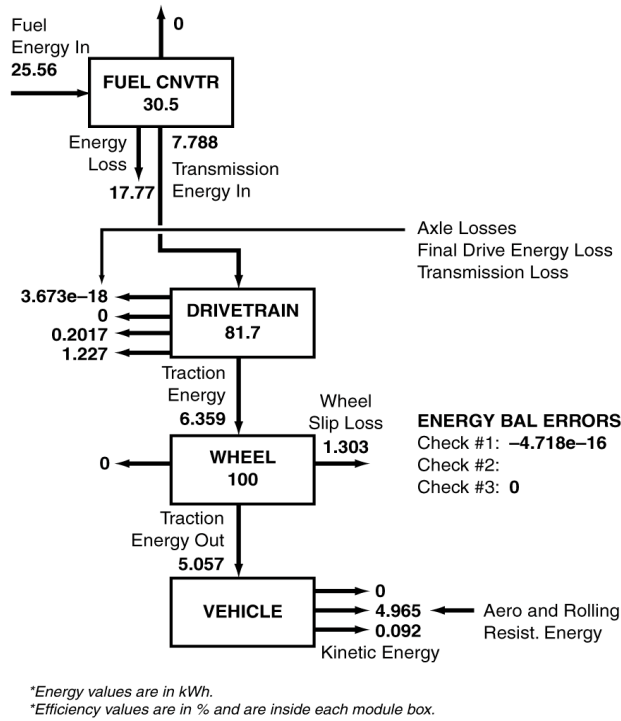

Fig. 4.8. Energy balance for the HMMWV.

4.5.3.3 Medium Truck

The military vehicle chosen to represent the Class 6 medium trucks for this analysis is the FMTV 2.5 ton. The baseline characteristics of the FMTV are listed in Table 4.14.

Based on validated models, a simulated weight of curb plus 2/3 maximum cargo and the FUDS drive cycle, the resulting fuel economy in ton mpg was 9.8 (5.9 mpg). Figure 4.9 shows an energy balance of the simulation. Simulated accessory loads were only those required to run the engine.

4.5.3.4 Heavy Truck

The military vehicle chosen to represent the Class 8 heavy trucks for this analysis is the M916A2. The baseline characteristics of the M916A2 are listed in Table 4.15.

On the basis of using validated models, a simulated weight of curb plus 2/3 maximum cargo, and the FUDS drive cycle, the resulting fuel economy in ton mpg was 66 ton mpg (3.3 mpg). Figure 4.10 shows an energy balance of the simulation. Simulated accessory loads were limited to those required to run the engine.

4.5.4 Impact of Aggressive Improvements on Military Truck Efficiencies

As a preliminary approach to achieving the fuel economy goals for the year 2010, the models for the three military vehicles were simulated with aggressive improvements assumed to be available in the future. This is a preliminary analysis because the candidate technologies are yet to be determined through the systems engineering process. The technologies discussed below are to provide the 21st Century Truck Program Technology Roadmap with some direction for military vehicles.

Table 4.14. 2.5-ton FMTV M1078 specifications

Configuration	Standard cargo
Engine type	CAT 3116 6-cyl diesel
Aspiration	Turbocharged, aftercooled
Engine (L)	6.6
Engine peak power (kW)	220 @2600 rpm
Transmission	Allison MD-D7
Number of gears	7
1st gear	5.64
2nd gear	3.45
3rd gear	1.84
4th gear	1.39
5th gear	1
6th gear	0.76
7th gear	0.66
Final drive ratio	7.8
Empty vehicle weight (curb) (kg)	7484
Gross vehicle weight (kg)	9752
Frontal area (m ²)	5.46
Coefficient of drag	0.75
Wheel base (m)	3.9
Tire type	395 × 85 R20 XML
Rolling radius (m)	0.5738
Coefficient of rolling resistance	0.008 paved/0.045 off road
Acceleration 0–30 mph (second)	8.2
Acceleration 0–50 mph (second)	20
Acceleration 0–58.5 mph (second)	33.4
Idle speed (rpm)	600

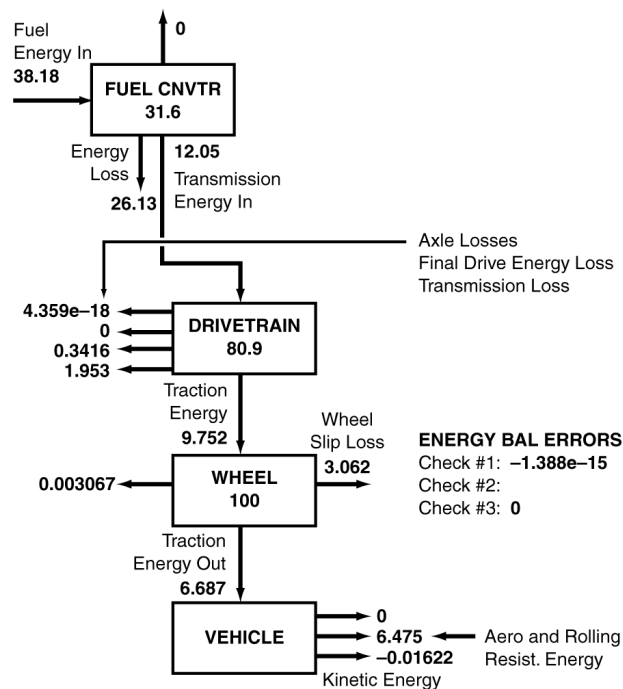

*Energy values are in kWh.
*Efficiency values are in % and are inside each module box.

Fig. 4.9. Energy balance for the FMTV.

Table 4.15. M916A2 specifications

Configuration	14 ton tractor truck 6×6
Engine type	DDC Series 60 6-cyl diesel
Aspiration	Turbocharged, aftercooled
Engine (L)	12.7
Engine peak power (kW)	298 @2100 rpm
Transmission	Allison HT-740
Number of gears	4
1st gear	3.692
2nd gear	2.021
3rd gear	1.383
4th gear	1
Final drive ratio	4.9 diff, 0.98tc, 4.8 overall
Empty vehicle weight (curb) (kg)	12583
Gross vehicle weight (kg)	30844
Gross combination weight (GCW)	58967
Frontal area (m ²)	9.87
Coefficient of drag	0.75
Wheel base (m)	4.445
Tire type	315/80 R 22.5 tubeless radial
Rolling radius (m)	0.5238
Coefficient of rolling resistance	3.5 static, 0.0495 dynamic
Acceleration 0–30 mph (second)	30 at GCW
Acceleration 0–50 mph (second)	99 at GCW
Idle speed (rpm)	600

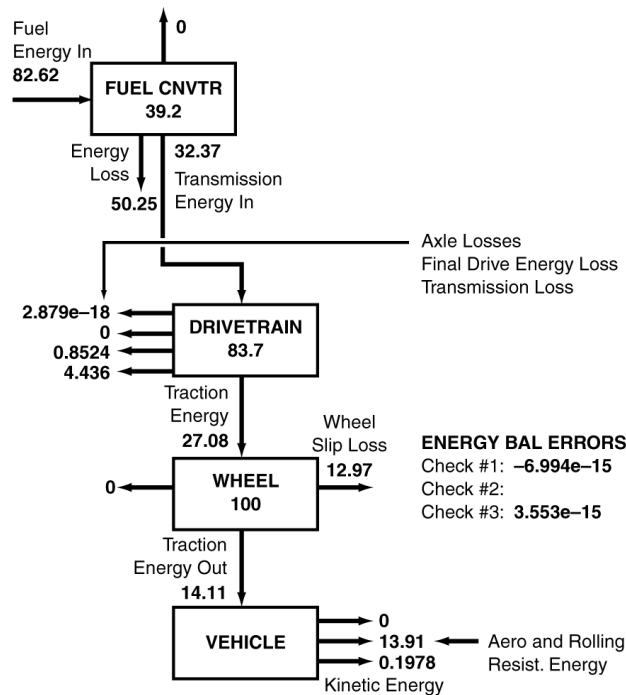

*Energy values are in kWh.
 *Efficiency values are in % and are inside each module box.

Fig. 4.10. Energy balance for M916A2.

First, improvements were made in the engines, including reduced friction, reduced heat loss, addition of EGR, advance injection timing, turbocompounding for the FMTV and M916A2, and better aftertreatment. Second, a continuously variable transmission (CVT) replaced the automatic transmissions, and a parallel hybrid power train was implemented. Third, aerodynamics, rolling resistance, and vehicle weight improvements were evaluated.

These improvements were targeted for peacetime operations of the three classes of military vehicles. However, during wartime, meeting emissions requirements may be less important than fuel savings. Engine improvements that hinder engine efficiency but improve emissions, such as SCR, lean NO_x traps,

or retarded injection timing, may not be necessary during wartime. Without such improvements, the fuel economy in wartime would be measurably higher than the results have shown. Features that can be “turned off” in wartime, such as SCR, are of great interest to the military.

An analysis of variance (ANOVA) was performed on the three vehicles by means of the FUDS cycle. All possible combinations of the baseline values and improvements were simulated to determine the effect of each improvement, as well as the combined effect of various improvements. The ANOVA shows that, although a vehicle improvement may have little impact on fuel economy alone, the effect is enhanced when combined with other improvements.

4.5.4.1 Future Class 2 Light Truck

Improvements were applied to the GM 6.5-L engine (see Table 4.13). With the hybrid power train, however, the engine was scaled down to 75% of its original power. The aerodynamic coefficient of drag was reduced by 20% on the basis of predictions from the 21st Century Truck working group meetings. According to the Parasitic Losses team, rolling resistance was reduced by about 31%. The vehicle curb weight was reduced by 30%. The cargo weight was increased by 2/3 of the difference in curb weights. With all the improvements applied to the vehicle, the FUDS simulation resulted in a fuel economy of 2.8 times the baseline value, or 38 ton mpg. Simulated accessory loads were limited to those required to run the engine.

In the ANOVA, which was based on the average fuel economy from the simulations, the hybrid power train had the most significant effect on fuel economy, increasing it by 48%. The next most effective changes were the reduced rolling resistance and improved engine. Reduced weight and improved aerodynamics had smaller positive effects. The addition of the CVT showed no improvement, unlike in the results of the commercial truck analysis. Further calibration of the CVT model for the HMMWV is to be examined.

The two-factor ANOVA reveals the combined effect that various pairs of improvements have on fuel economy. The pairing of hybrid drivetrain and reduced rolling resistance show the greatest effect, followed by improved engine paired with hybrid drivetrain, hybrid drivetrain paired with reduced weight, and hybrid drivetrain paired with improved aerodynamics. Although improved aerodynamics alone adds only a minor advantage, the hybrid drivetrain combined with the improved aerodynamics has a significant effect.

The three-factor ANOVA revealed that the three improvements that work best as a combination are the hybrid drivetrain, improved aerodynamics, and reduced rolling resistance.

4.5.4.2 Future Class 6 Medium Truck

Improvements were applied to the CAT 3116 engine (see Table 4.14). With the hybrid power train, however, the engine was scaled down to 75% of its original power. The aerodynamic coefficient of drag was reduced by 15%, and the rolling resistance was reduced by about 19%. The vehicle curb weight was reduced by 25%. The cargo weight was increased by 2/3 of the difference in curb weights. With all the

improvements applied to the vehicle, the FUDS simulation resulted in a fuel economy of 3.4 times the baseline value, or 33.5 ton mpg. Again, simulated accessory loads were limited to those required to run the engine.

An ANOVA was performed on the FMTV FUDS simulations with the average fuel economy taken from the simulations. The hybrid power train most significantly improved fuel economy, followed by the improved engine and reduced rolling resistance. Reduced weight and improved aerodynamics had smaller positive effects. The addition of the CVT showed no improvement, unlike in the results of the commercial truck analysis. As with the HMMWV, further calibration of the CVT model for the FMTV may be necessary.

In the two-factor ANOVA, the pairing of a hybrid drivetrain with reduced rolling resistance show the most improvement, followed by the reduced weight paired with hybrid drivetrain, followed by the hybrid drivetrain paired with improved aerodynamics. The improved engine had less of a two-factor impact on fuel economy for the FMTV. However, in the three-factor ANOVA, the three improvements that work best as a combination are the hybrid drivetrain, improved engine, and reduced rolling resistance.

4.5.4.3 Future Class 8 Heavy Truck

Improvements were applied to the DDC Series 60 engine (see Table 4.15). With the hybrid power train, however, the engine was scaled down to 75% of its original power. The aerodynamic coefficient of drag was reduced by 25%, and the rolling resistance was decreased by about 19%. The vehicle curb weight was reduced by 20%. The cargo weight was increased by 2/3 of the difference in curb weights. With all the improvements applied to the vehicle, the FUDS simulation resulted in a fuel economy of 1.9 times the baseline value, or 125 ton mpg. Again, simulated accessory loads were limited to those required to run the engine.

An ANOVA was also performed on the M916A2 FUDS simulations, with the average fuel economy taken from the simulations. The hybrid power train most significantly improved fuel economy, followed by the improved engine and reduced rolling resistance. Reduced weight and improved aerodynamics had smaller positive effects. The addition of the CVT showed no improvement, unlike in the results of the commercial truck analysis. As with the HMMWV and FMTV, further calibration of the CVT model for the M916A2 may be necessary.

In the two-factor ANOVA, as with both the FMTV and the HMMWV, the hybrid drivetrain paired with reduced rolling resistance show the most improvement. The next most successful improvements were from the hybrid drivetrain paired with improved aerodynamics and reduced weight paired with hybrid drivetrain. The improved engine had less of a two-factor impact on fuel economy for the M916A2. However, in the three-factor ANOVA, the three improvements that work best as a combination are the hybrid drivetrain, improved engine, and improved aerodynamics.

4.6 CROSSCUTTING TECHNOLOGIES

4.6.1 Alternative Fuels

4.6.1.1 Status of Technology

The use of alternative fuels in future commercial trucks and buses will facilitate achievement of national goals related to fuel diversity, use of domestic energy resources, energy efficiency, and lowering of exhaust emissions.

DOE and DOT have established programs to promote research, development, and deployment of alternative-fuel vehicle technology. Although alternative fuels are most readily used by fleets having central refueling and maintenance facilities, renewable fuel such as ethanol and biodiesel may find

application in large vocational trucks as well. Refueling station corridors are being established in some U.S. cities to promote the use of alternative fuels on a broader scale

Fleet studies have been conducted to compare the performance of transit buses operating on natural gas, ethanol, methanol, and biodiesel with buses operating on conventional diesel fuel (NREL 1996, NREL 2000a). These fleet studies have shown that alternative-fuel buses generally have higher operating and maintenance costs than conventional diesel-powered vehicles have. The operating costs can vary widely because the fuel price is strongly dependent on the location of the fleet operation. Maintenance costs are generally higher for alternative-fuel bus fleets since the technology is less mature than the mass-produced diesel engine technology.

Natural gas has emerged as the most widely used alternative fuel for transit buses in the United States. Buses powered by natural gas accounted for 22% of the 4,225 transit buses built in 1998 (Inform 2000). In 1999, about 92.5% of the nation's transit bus fleet were diesel buses and 6.2% were natural gas buses (APTA 2000a). The remaining 1.3% of buses were electric, hybrid electric, or fueled by alcohol, gasoline, propane, or other alternative fuel.

Natural gas buses have penetrated the marketplace in part due to legislative incentives and mandates, but also due to their lower NO_x and PM emissions and favorable environmental image. Transit agencies and commuters perceive natural gas buses to be less polluting than diesel buses due to their quieter operation and absence of diesel odor and smoke. Natural gas transit buses typically cost 15 to 25% more than diesel transit buses due to the higher cost of the engine and fuel storage and delivery systems. Refueling and maintenance facility costs may significantly limit market penetration of natural gas vehicles. The cost of typical natural gas fueling stations can range from \$600,000 to \$1.5 million for a fleet of 80 to 160 natural gas buses (NYC 2000). In addition to this cost, facility modification for some existing garages in dense urban areas has been reported to cost more than \$18 million.

Substantial progress has been made to develop natural gas technology for commercial trucks and buses: Cummins, Detroit Diesel, Deere, and Mack offer factory-built, spark-ignited, lean-burn natural gas engines for commercial vehicles. A wide range of engine displacements and power ratings are now available. The engine manufacturers have cited the need for larger production volumes to justify their continued investment in natural gas engine development and production. MVE, Lincoln Composites, and other firms have developed fuel storage and delivery systems to safely handle compressed natural gas (CNG) and liquefied natural gas (LNG) on-board vehicles.

Natural gas engines have been certified to meet the California Optional Low-NO_x Standard of 2.5 g/bhp-h NO_x. Moreover, engine-out NO_x emissions of 1.0 g/bhp-h have been demonstrated on a production-feasible, lean-burn natural gas engine in the engine laboratory (NREL 2000b). Emissions tests conducted on the chassis dynamometer have confirmed that natural gas vehicles emit substantially lower NO_x and PM compared with closely matched diesel vehicles (NREL 1996, NREL 2000a, Inform 2000). Natural gas engines will require advancements in emissions control technologies to comply with future stringent emissions standards such as the CARB Public Transit Bus Fleet Rule and Emissions Standards for New Urban Buses, and the proposed 2007 EPA emissions standards for heavy-duty engines.

Experiments and field tests are under way with blended alternative fuels such as vegetable oils (biodiesel) and ethanol (oxydiesel). Both types of fuels are typically blended 10 to 20% in conventional petroleum diesel fuel, although biodiesel can be used in neat form. The blended fuels offer a displacement of petroleum and modest emissions benefits, especially reduction of PM. Diesel fuels produced from natural gas feedstocks, such as Fischer-Tropsch fuel, are attractive because they are free of sulfur and aromatics. Numerous engine experiments have shown substantial reductions in PM emissions when Fischer-Tropsch diesel is used in unmodified engines.

Alternative-fuel vehicle research and development is being directed toward next generation natural gas vehicles, “gas-to-liquid” fuels that can be used in unmodified diesel-powered vehicles, and hydrogen technology. These fuels may also be used in combination with HEV technology.

4.6.1.2 Technical Targets

The technical targets for alternative-fuel vehicles are outlined in Table 4.16. The technical targets emphasize gaseous-fueled vehicle technology because they are currently the most widely used alternative fuels in the transit bus market.

Table 4.16. Summary of technical targets and barriers for natural gas transit buses

Engine parameter	Current practice	Target	Barrier
Cost	The capital cost of a natural gas bus is 15 to 25% higher than costs for a comparable diesel bus. Operating costs and facility costs are generally higher than those for diesel vehicles	No more than 20% higher cost than comparable diesel vehicle by 2010	Current production volumes are low. Fuel storage system costs are high. Added components and complexity add cost. Fuel economy is usually lower than that for diesel. Additional facility costs
Efficiency	Dedicated natural gas buses average about 3.2 miles per diesel equivalent gallon over CBD cycle [40,000 lb (18,140 kg) GVW, 40-ft bus]. Part-load efficiency of SI engines poorer than diesel	Dedicated gaseous-fueled bus: match current diesel fuel economy of 3.75 mpg over the CBD cycle by 2010 Alternative-fuel hybrid bus: 3× efficiency goal from 21 st Century Truck by 2010	Same barriers as for a high-efficiency diesel engine, plus low cetane rating of fuel makes diesel cycle difficult. May need low-cost sensors for knock detection and ignition system improvements Chassis weight
Emissions	Current dedicated lean-burn NG spark-ignited engine: NO _x = 2.5 g/bhp-h NMHC = 0.5 g/bhp-h CO = 6.0 g/bhp-h PM < 0.05 g/bhp-h	Prevailing emissions standards: EPA proposal: max of 0.2 g/bhp-h NO _x and 0.01 g/bhp-h PM in 2007 CARB Public Transit Bus Fleet Rule and Emissions Standards for New Urban Buses	Maintaining low emissions while increasing efficiency Transit bus emissions standards are more stringent than truck standards and may force development of alternative power plants and fuels
Reliability	Variable. Poor reliability at some sites, while others have achieved parity with diesel reliability.	Same as diesel	Spark plug life (if SI), fuel delivery system reliability, valve/valve seat wear. New power plant technologies

The costs associated with alternative-fuel vehicles are significantly higher compared with costs for diesel vehicles. Operating and maintenance costs can be affected through product design and development. The incremental cost of the natural gas vehicles could also be improved if production volumes increased. Infrastructure, refueling and maintenance facilities costs will be difficult to change.

Spark-ignited engine efficiency is significantly lower than diesel engines due to pumping and throttling losses and lean air/fuel ratio limits needed to ensure ignition without misfire. Research is under way to improve the energy efficiency of the spark-ignited alternative-fuel engines to approach diesel engine efficiency.

The overall emissions target is to meet prevailing emissions certification standards. These standards are stringent for transit buses and may force significant changes to power train technology. Near-term development efforts are to focus on emissions controls for lean-burn gaseous engines, including active NO_x aftertreatment devices. Research efforts should focus on near-zero emission power plants, including the fuel cell.

The reliability of all alternative-fuel vehicles should be comparable to that of diesel vehicles to promote market penetration and customer acceptance. The storage and containment of alternative fuels in the event of a collision must present no greater hazard to vehicle occupants or the surrounding environment than those presented by current diesel-powered vehicles.

4.6.1.3 Barriers

The primary barriers for alternative-fuel vehicles are cost, market acceptance, and deployment because a variety of proven technologies are already commercially available. Because of their additional cost and complexity, alternative gaseous-fueled vehicles may be limited to vocational use and niche applications unless further incentives or legislative mandates are established. Safety issues related to on-board storage of CNG must be considered if CNG is to be used more widely.

The barrier to wider use of oxydiesel, biodiesel, and Fischer-Tropsch liquids is their higher cost. Compatibility of these fuels with existing engine materials and systems has generally been determined to be satisfactory.

Further emissions R&D will be critical if alternative-fuel power plants are to meet proposed emissions standards such as the CARB Public Transit Bus Fleet Rule and Emissions Standards for New Urban Buses and proposed 2007 EPA emissions standards for heavy-duty engines. The status, technical targets, and barriers for alternative fuels are summarized in Table 4.16.

4.6.1.4 Technical Approach

Natural gas transit buses are commercially available and have been proven in service. However, alternative-fuel buses are more costly and somewhat less reliable than comparable diesel-powered buses. The stringent emissions standards proposed for transit buses will significantly influence research directions and the development of alternative power trains.

Alternative fuels research in the 21st Century Truck Program will focus on three pathways to meet technical targets:

- Near-term engine development to improve lean-burn spark-ignited engines: Improve part-load thermal efficiency of the spark-ignited engines to reduce operating costs. Develop emission control devices for lean-burn gaseous engines to meet future emissions standards, including development of active NO_x aftertreatment devices.
- Promote small-fleet demonstration of diesel and natural gas hybrid electric or fuel-cell-powered vehicles to build experience in the new technology, making commercial viability possible.
- Mid-term development of gaseous-fueled engine systems for use in HEVs: Natural gas-hybrid or hydrogen-hybrid transit bus configurations offer opportunities to greatly improve fuel efficiency while simultaneously reducing exhaust emissions. Optimize the spark-ignited engine design for use in HEVs. In series hybrid applications, explore control strategies to operate the engine at high power, to

minimize the inefficiencies attributed to low-load operation. Explore other engine modifications, including the use of electrically driven accessories in place of mechanical drives. Investigate design, cost, and packaging of gaseous fuel storage and delivery systems for HEV applications in collaboration with the Materials Crosscut subteam.

- Long-term research of other high-efficiency, alternative-fuel power plants such as fuel cells.

4.6.2 Internal Combustion Engine Technology

4.6.2.1 Background and Status of Technology

The selection of engine type and optimization of its efficiency is the most critical element of the vehicle power train in meeting the aggressive Program targets. The engine is responsible for nearly 60% of the energy inefficiency we seek to minimize in the vehicle system. A 10% increase in engine thermal efficiency has a direct 1:1 impact on achieving the broader initiative goals. The diesel combustion cycle (i.e., direct-injection compression-ignition) is the engine system of choice for large trucks because of its inherent thermal efficiency, high power delivery, and advanced state of development. It is the most efficient transportation power plant available today. The engine is responsible for the production of exhaust emissions as well as the inlet conditions for aftertreatment devices thus affecting the overall efficiency of emission reduction. The engine is critical to the safety of the heavy vehicle by providing a burst of power to avoid traffic incidents, and also via braking power. Already a key safety ingredient, the importance of the engine brake will increase as aerodynamic and drivetrain enhancements reduce the parasitic drag in future vehicles. The diesel engine is a mature, state-of-the-art transportation technology, offering the lowest possible life cycle costs (see Appendix D).

4.6.2.2 Technical Targets

Fuel Economy

Diesel engines derive high efficiency by both emulating high-efficiency thermodynamic cycles and minimizing mechanical losses. Diesel high efficiency is due to high compression (expansion) ratio, high rate of combusting lean mixtures, and use of air-fuel ratio (instead of throttling) for load control, thus avoiding the part-load pumping losses associated with throttled engines. Turbocharging increases engine power density and recaptures some of the exhaust heat energy to improve net efficiency. Achieving high power density primarily through high brake mean effective pressure (BMEP), diesel engines operate at relatively low speeds, which helps to minimize mechanical friction losses. Other design features, such as strategic cooling, serve to minimize thermal energy losses and also augment overall power plant power density. Due to its fuel economy, reliability, and low life-cycle cost, the diesel engine is the power source for commercial surface transportation and buses in the United States and worldwide.

Modern highway truck diesel efficiency approaches 45%; production gasoline engines have an efficiency of 30%. This is approximately a 40% improvement relative to the late 1970s diesel engines. Thermal efficiency can be increased to 50% within the next few years in research designs but will not be sufficiently developed for commercial production. For example, turbocompounding is a proven technology for exhaust heat recovery, but is not utilized because it is not cost-effective. A brake thermal efficiency of 50% for the engine has been set as an aggressive but achievable objective. To achieve the thermal efficiency target while meeting proposed emission-reduction efficiencies of 90 to 95%+ presents a much more complex challenge.

The optimization of in-cylinder combustion and heat transfer characteristics to enhance thermal efficiency acts in opposition to recent developments intended to reduce in-cylinder emissions. Further increases in fuel efficiency will necessarily force emission controls technology toward the use of aftertreatment devices that will utilize chemical reactions and catalysts to convert criteria pollutants into less harmful constituents after the combustion event has concluded. This will lead to the design of an unprecedented

amount of engine-aftertreatment integration that may still elicit an associated potential of compromising engine performance to assist the achievement of ultra-low emissions.

Further advances in thermal efficiency will be achieved with improvements in components and operating characteristics of engines similar in overall architecture to those in use today. In addition, an effective exhaust heat recovery system is critical to meeting the 50% efficiency target. Traditional implementation of such energy recovery systems significantly reduces exhaust gas temperatures, a result that is inconsistent with aftertreatment that requires higher exhaust temperatures. The use of “low-heat-rejection” strategies and materials can increase the available exhaust temperature for both recovery and aftertreatment operation. Furthermore, less heat rejection to the engine coolant reduces demands on heat exchangers, permitting more flexibility in truck aerodynamics.

Exhaust Emissions

Reductions of diesel engine emissions must be achieved in addition to improvements in efficiency. Over the past 20 years, diesel engine manufacturers have achieved remarkable reductions in NO_x and PM emissions by modifying their engines. Today’s heavy-duty diesel engines are regulated to 4.0 g/bhp-h of NO_x and 0.10 g/bhp-h of PM (less than 0.05 g/bhp-h for transit buses), and substantially lower emissions have been achieved in research engines. To address these challenges one can consider three approaches: (1) minimizing engine-out emissions, (2) exhaust aftertreatment, and (3) fuel reformulation with or without additives.

Optimizing fuel combustion has led to significant reductions in emissions through strategies including injection rate control, increased injection pressure, and lower temperatures. However, further reductions are required to meet future standards. The key is an improved understanding of the process of diesel combustion and emissions formation and the development of design tools (i.e., models) that incorporate improved understanding and allow engine designers to rapidly explore alternative combustion system designs (see Fig. 4.11). The level of detailed understanding of the mechanisms controlling combustion and emissions that is needed by engine designers to make further improvements is not available. As new diagnostics advance the understanding of in-cylinder processes in diesel engines, more advanced concepts such as HCCI may emerge (see Sect. 4.6.10.4).

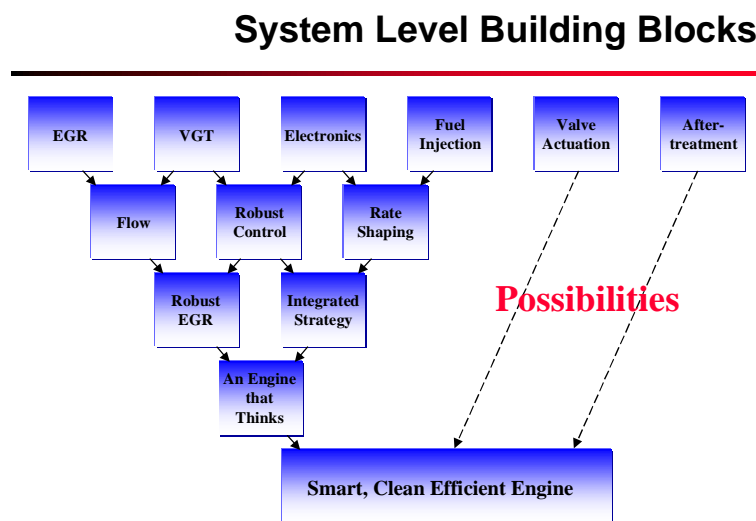

Courtesy of Detroit Diesel Corporation

Fig. 4.11. System-level model for efficient engine design.

4.6.2.3 Technical Approach

Elements of the diesel engine technology roadmap include the following (see Fig. 4.12):

- Define baseline engine designs in sufficient detail to delineate the areas of required technology advancement. This would be a guide for enabling technology projects. Conduct, on a continuing basis, analysis and supporting validation tests to assess progress toward goals. Develop advanced combustion-chamber components for high peak and brake mean effective pressures, utilizing new architectures for components, advanced materials, thermal barriers, and novel cooling strategies.
- Perform materials evaluation to support engine design targets, pre-component tests, performance and durability tests of new components, and tests of complete engine systems.
- Develop fuel-injection and combustion technologies that will provide better efficiency without increasing NO_x with modeling and simulation as an integral component of the system design strategy.
- Develop and integrate sensors, controls, diagnostics, and enabling experimental tools.
- Develop improved turbocharger and/or air-handling systems and controls, and trade-offs between efficiency and transient response. Develop new low-inertia materials and response-enhancing technologies.
- Pursue new exhaust heat-recovery technologies. Develop materials and designs for improved insulation of exhaust systems.
- Develop effective thermal-management systems to better protect the engine and to reduce losses. Refine analysis of benefits of cooling and thermal-barrier strategies and support with experiments. Continue development of thermal-barrier designs and enabling materials.
- Continue refinement of piston/cylinder designs, valve trains and other mechanical components for reduced friction losses. Carry out R&D of low-friction materials and lubricants.
- Optimize effectiveness of EGR for NO_x reduction.
- Exploit fuel reformulation for overall emissions reductions.

“Wired” Integrated Engine Systems Optimization

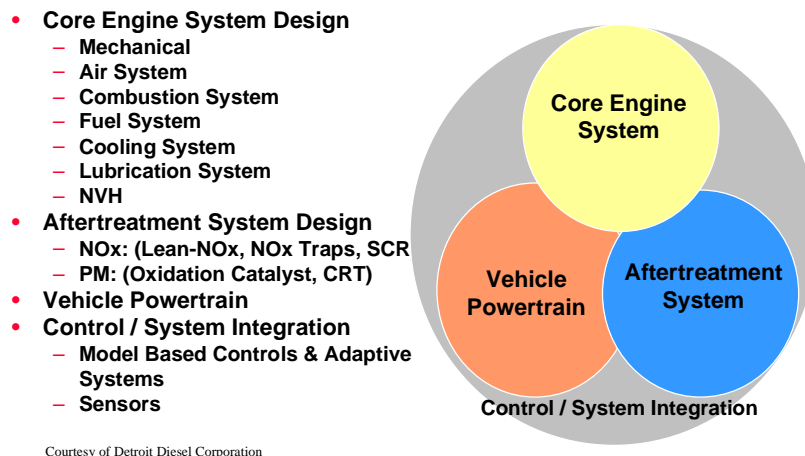

Fig. 4.12. “Wired” integrated engine systems optimization.

4.6.3 Aftertreatment

4.6.3.1 Requirements for Emission Control Devices

The requirements for exhaust-treatment emission controls are tied to upcoming emissions regulations currently in the proposal stage. The 21st Century Truck *Declaration of Intent* requires compliance with emissions regulations in force in 2010. Although not spelled out in 21st Century Truck Program goals, significant improvement in air quality in certain regions could be accelerated by retrofitting existing vehicles with emission control devices developed on this program, and this is certainly within the spirit of the Declaration of Intent.

Today's heavy-duty diesel engines are regulated to 4.0 g/bhp-h of NO_x and 0.10 g/bhp-h of PM (less than 0.05 g/bhp-h for transit buses). Only urban buses and some delivery-type vehicles use any aftertreatment device, and they use a diesel oxidation catalyst.

In 1996, the EPA, the state of California, and major engine manufacturers prepared a Statement of Principles (SOP) (National Archives 1996) that requires further reduction to 2.4 g/bhp-h of NO_x plus NMHCs or 2.5 g/bhp-h of NO_x plus NMHCs with a maximum of 0.5 g/bhp-h of NMHC by 2004. An action by the EPA and the U.S. Department of Justice resulted in a consent decree with the diesel-engine manufacturers that moved the SOP requirements to October 2002 and placed caps on emissions at all operating conditions. Diesel-engine manufacturers will likely approach meeting the consent decree requirements with implementation of cooled EGR, resulting in reduced engine efficiency and perhaps less durability. Pre-production engines using cooled EGR have achieved the SOP emissions levels without the use of aftertreatment devices.

In May 2000, the EPA issued proposed emissions regulations for heavy-duty engines to begin in 2007. The EPA is proposing a PM emission standard for new heavy-duty engines of 0.01 g/bhp-h, to take full effect in the 2007 heavy-duty engine model year. The proposed standards for NO_x and NMHC are 0.20 g/bhp-h and 0.14 g/bhp-h, respectively. These NO_x and NMHC standards would be phased in together between 2007 and 2010 for diesel engines and fully required for gasoline engines in 2007. (For complete details of the proposed rule see EPA 2000.)

It is widely held that the emissions levels in these proposed rules could be met only with a robust, integrated engine and aftertreatment system along with certain key fuel properties. The required combination of engine-out emissions and emission control device performance is illustrated in Fig. 4.13. The lower limit of engine-out emissions for direct-injection diesels is estimated as about 1.5 g/bhp-h NO_x, so the effectiveness of aftertreatment technology must be on the order of 90%. The addition of aftertreatment devices is expected to reduce fuel efficiency by at least 5%. Only the realization of high-risk technologies such as HCCI engines would change this perspective. The mature and highly effective TWC systems in today's gasoline-fueled automobiles are not applicable to diesel or other lean-burn engines.

Similarly, PM control by aftertreatment must function at 80 to 90% effectiveness if the proposed standards become law.

For the foreseeable future, engines used in commercial vehicles of over 8500 lb GVWR will be certified to federal standards according to the engine dynamometer test procedure for heavy-duty engines. California LEV II regulations require certification of all vehicles of 8,500 to 14,000 lb (3,855 to 6,349 kg) GVWR by chassis dynamometer procedures to a specific set of standards. The aftertreatment performance requirement (e.g., 90% removal) is essentially the same for both chassis and engine dynamometer certification, although the exhaust flows and temperatures over the certification cycles are quite different.

NO_x Aftertreatment/Control and Base Engine/Fuel Requirements: 172 g/bhp – h

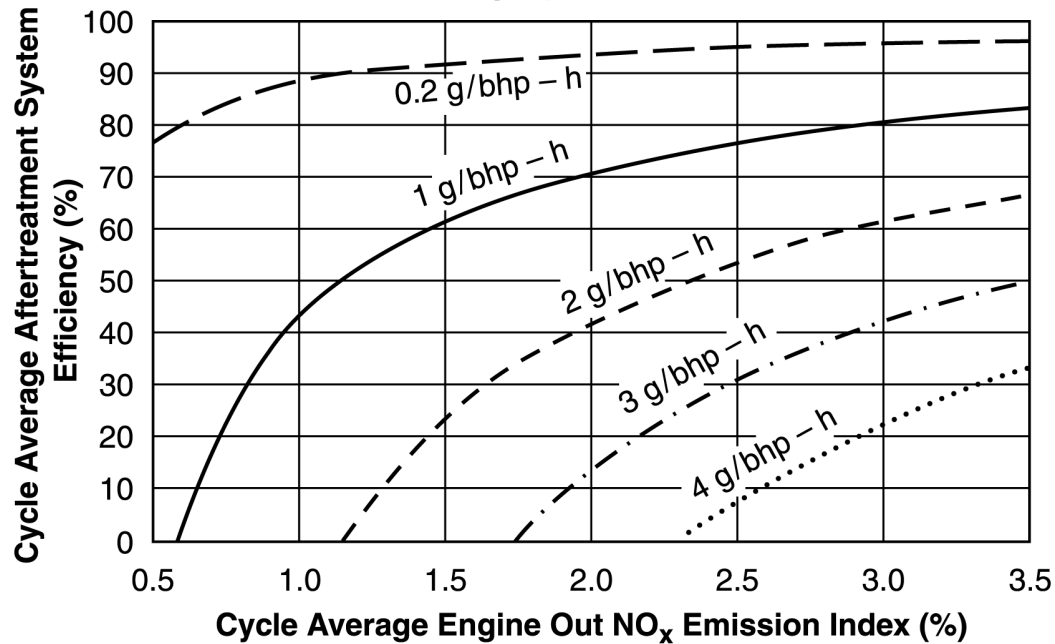

Fig. 4.13. The combination of engine-out emissions and emission control device performance required to satisfy proposed EPA emission standards.

4.6.3.2 Status of Emission Control Technology

NO_x Control

NO_x adsorber catalysts. A NO_x adsorber catalyst consists of two principal components: a NO_x adsorbent and a three-way conversion catalyst, both on the same substrate material. Periodically, NO_x stored by the adsorbent is released and reduced to N₂. This process requires a momentary exhaust gas composition that contains CO and HCs but is depleted in oxygen.

An engine management system must determine when the NO_x adsorbent is approaching saturation and then trigger the change in engine operation that results in generation of the rich condition required for release and reduction of the stored NO_x. The duration and “richness” are critical to avoid excessive fuel use and HC breakthrough while still accomplishing complete regeneration (DECSE 1999).

The NO_x adsorber-catalyst is very sensitive to sulfur, its effectiveness dropping quickly with fuels containing 16 ppm or more sulfur. In programs utilizing 3-ppm sulfur fuel, NO_x reduction levels of more than 90% have been achieved for fresh devices in both engine test cells and experimental vehicle systems, the latter over a transient cycle (DECSE 1999, DVECSE 2000). In heavy-duty engine transient tests, experience has shown conversion efficiencies of about 60%. Although these results provide encouragement, extensive R&D work is still needed on optimizing the NO_x adsorption/desorption and conversion functions, defining and optimizing sulfur removal (“desulfurization”) techniques and strategies, and examining the use of sulfur traps upstream of the catalyst. The interactions with DPFs in a full system are in the early stages of exploration. The NO_x adsorber-catalyst carries a substantial fuel economy penalty due to the frequent NO_x regeneration, although further optimization is expected to bring

this to a tolerable level (a few percentage points). Furthermore, durability of the adsorber-catalyst is far from established.

Urea SCR. SCR of NO_x using ammonia or urea has been used for many years in stationary diesel engine applications. In the SCR process, NO reacts with the ammonia, which is injected into the flue gas stream before the catalyst. Because of the toxicity and handling problems with ammonia, the most widely accepted and commercialized reductant is urea, CO(NH₂)₂ (Ecopoint 2000). Water solutions appear to be the preferred form of urea. SCR technology, which utilizes an oxidation catalyst to facilitate NO_x reduction to achieve high control efficiencies, requires the same low sulfur levels as the NO_x adsorber technology (MECA 2000). SCR systems would require an anti-defeat system to ensure that the vehicle is not operated without a urea supply.

Numerous SCR experiments and demonstrations are in progress. NO_x control efficiency has been recorded at 80 to 90%, with 70% being more representative in transient operation. Durability is being determined by the numerous field tests, primarily in Europe but now getting under way in the United States (Miller et al. 2000).

HC SCR. Also known as “lean NO_x catalysis,” HC SCR typically utilizes diesel fuel or an HC readily derived from fuel as the reducing agent for NO_x in the presence of a catalyst. Other HCs, ethanol for instance, have been used in commercial SCR systems for stationary power plants. After many years of experiments and tests of thousands of catalyst formulations, the probability of HC SCR achieving 90% NO_x conversion over a sufficiently wide temperature range is presently low. The keys to success appear to be getting the optimum HCs manufactured from on-board fuel, and greatly improving the understanding of the HC utilization/NO_x reduction mechanisms. Lean NO_x catalysts exhibit a moderate degree of sensitivity to sulfur compounds from fuel.

Plasma-assisted NO_x catalysis. Non-thermal plasma-assisted catalytic reduction of NO_x is a relatively new technology that has shown promise for enhanced NO_x reduction. Up to 80% NO_x reduction has been observed on simulated exhaust and up to 55% in real exhaust (SAE 1999).

The plasma is believed to enhance NO_x reduction over catalysts via a two-step process (Penetrante 1997). First, the plasma is a strongly oxidizing environment in which NO is converted to NO₂ with some partial oxidation of the HC reductants, if present. The second step is reduction of NO₂ to N₂ by the HC over a catalyst. Plasma-assisted catalyst NO_x control is unproved in transient test cycles. Limited testing on light-duty vehicles has been performed for PM removal. The energy penalty (from electrical energy and reductant addition) is possibly higher than for other NO_x reduction technologies (about 5% total). While both NO_x and particulate removal by plasmas have been demonstrated separately, a system with combined function for NO_x and PM removal has not been developed or tested.

Particulate Matter Emission Controls

Catalyst-based DPF. Control technologies for PM have seen significant progress in recent years to the point of limited commercial application. Catalyst-based DPFs used on engines operated on low-sulfur diesel fuel can achieve PM and toxic HC reductions well in excess of 90%. Where diesel fuel containing less than 10-ppm sulfur has been used, filter technology has demonstrated impressive durability, in some applications continuing to provide excellent particulate removal at 600,000 km of vehicle operation (Warren et al. 2000). The ability of catalyst-based DPFs to reduce HC emissions by more than 95% has also been clearly established (Letavec et al. 2000).

Two types of DPFs are well-developed and engaged in field trials—the continuously regenerating DPF (CR-DPF) and the catalytic DPF (CDPF). For both, PM is removed from the exhaust stream by collecting it on a ceramic wall-flow filter element.

The CR-DPF accomplishes regeneration by continuously converting engine-out NO to NO₂ over an oxidation catalyst placed upstream of a DPF (in this case, the DPF has no active catalyst on it). The NO₂ completes the regeneration. Sulfur in the exhaust, however, can be oxidized over the CR-DPF, forming sulfates, which are measured as PM. Sulfur oxides also compete for the critical NO and NO₂ reaction, making the regeneration characteristics less effective (Liang et al. 2000).

The CDPF regenerates by using a catalyst coating on the DPF element that uses oxygen available in the diesel exhaust to promote oxidation of the collected PM. Sulfur in the exhaust can be oxidized over the CDPF to form sulfates.

Exhaust-gas temperature and fuel-sulfur level are critical factors that affect the performance of both CR-DPFs and CDPFs. The poor regeneration at low temperatures, and filter plugging by ash (mostly from engine lubricating oil) over time, are among the few remaining shortcomings of the technology. The ash can be removed by backflushing with air, but the required frequency is not fully established.

The catalyst-based DPF is additionally attractive because it is a self-contained passive device that can be retrofitted to diesel-powered vehicles that exhibit sufficient exhaust heat to ensure regeneration.

Diesel oxidation catalysts. The DOC employs technology that dates back to the early stages of gasoline vehicle emission control in the early 1970s. When formulated for use in diesel vehicles, these catalysts are effective in removing HC, CO, and the soluble organic fraction of PM, which can be on the order of 30% or more of the total PM. They also diminish the usual pungent odor of diesel engine exhaust. DOCs are used on off-road vehicles, diesel-powered trucks, and cars worldwide.

Plasma reduction of PM. Plasma devices for PM removal have been the subject of numerous experiments, and full-scale prototypes are emerging in test programs. In laboratory experiments, they have been very effective in PM control (Fanick 1995).

Non-catalytic DPF. Numerous non-catalytic systems have been proposed for PM control that relied on a trapping process and then heating by external means. Typically, extra fuel was burned to raise the temperature of the trap to burn the stored carbon. The fuel economy penalty is rather prohibitive for most applications. Other systems use a fuel additive that deposits a material on the filter to lower the light-off temperature (Psaras and Summers 1995) and promote regeneration. Finally, a filter made of a ceramic paper has been developed whose material of construction couples efficiently with microwave energy. The filter can be regenerated on demand with externally supplied microwave energy. Prototypes of this device have been evaluated in engine test cells and on vehicles and have shown good filtering efficiency (over 80%) and the ability to regenerate as intended (Nixdorf 2000).

Enablers for Emissions Controls

Sulfur traps. A sulfur trapping system is attractive to protect the NO_x or PM control devices that exhibit high sensitivity. Even the EPA-proposed 15-ppm fuel sulfur cap may not be low enough to ensure the needed durability of devices such as NO_x adsorbers. Furthermore, sulfur compounds in lubricants also give rise to notable SO₂. Sulfur traps or “guard beds” are similarly used in fuel refining to protect the process catalysts. Sulfur traps for diesel emission control systems are being developed and at least in one case are being integrated with NO_x adsorbers (Parks et al. 1999).

Reductant generation and deposition systems. NO_x catalysts and adsorber-catalysts function with higher efficiency if the reducing agent is a prescribed compound other than diesel fuel. Mixtures of hydrogen, CO, and specific HCs have been found to be among the best reductants. Devices such as diesel fuel reformers could provide a higher level of NO_x control by generating reductants on the vehicle. Reformer technology is mature for some applications using natural gas but is not well developed for reforming diesel fuel. There has been little investigation of optimizing fuel constituents for this purpose. Experiments with in-cylinder late fuel injection have been conducted to achieve a similar effect; that is,

they produce a more tailored exhaust for NO_x reduction. These have shown trends in the right direction, yet not a large enough effect.

Sensors. NO_x and PM sensors are critical for emission and aftertreatment control. Either sensor, with an adequate response time, can aid in the control of engine-out emissions, depending on the control strategy of the engine manufacturer. Unfortunately, a PM sensor does not currently exist and NO_x sensors are inadequate in the current configuration.

Current electrochemical NO_x sensors have many shortfalls (e.g., slow response time ~500 ms, poor poison resistance, inadequate selectivity) but are based on a proven, robust technology. This type of sensor could be considerably faster and more dependable with continued research. However, the electrochemical NO_x sensor will not be able to meet the response times necessary to be used as a control sensor (less than 15 ms). For aftertreatment systems such as SCR, NO_x sensors are being integrated for control and diagnostics. Their durability remains less than desired.

For a more detailed discussion of the status of aftertreatment and emission control technology, see Appendix E.

4.6.3.3 Technical Barriers

The barriers to successful NO_x and PM control are described in two categories: technology deficiencies, and R&D process deficiencies.

Technology Deficiencies

- Unproven durability and transient performance of NO_x aftertreatment technology.
- Inadequate NO_x conversion efficiency in full-scale, integrated systems, especially in combination with DPFs.
- Current technology that is too sensitive to contaminants present in the exhaust (e.g., sulfur). The contaminants can reduce performance to well below the needed levels.
- Sulfur levels in fuel too high for certain emission control devices. Sulfur levels in lubricants are of concern as well.
- A temperature range within which catalyst performance is acceptable that is either too high for practical use or too narrow to perform effectively during all operating conditions (especially HC SCR), including cold-start.
- Incomplete understanding and optimization of catalysts for plasma-assisted systems.
- Regeneration temperature for DPF higher than desired for light-load applications.
- Incomplete proof of durability for DPFs—periodic de-ashing required.
- No demonstration of technologies that eliminate or neutralize contaminants such as sulfur.
- Device cost.
- Possible generation of unregulated toxic emissions.
- Reduction in fuel economy through several mechanisms.
- Inadequate methods for introducing effective reductants (e.g., reformers and related devices).
- Undeveloped infrastructure for urea SCR.
- Inadequate sensors for process control or diagnostics.
- Difficult packaging of aftertreatment devices in limited space of heavy truck applications.

Deficiencies in the R&D Process

Up to the present, development of new catalytic converter technology has relied almost totally on empirical, incremental developments. Catalysts and converter designs have been initially selected on the basis of educated guesses and long-term testing to scale up from laboratory scale to device scale.

However, it is expected that models of the dominant physical and chemical processes involved could greatly speed the development of new generations of catalytic converter technology. It may be possible to reach the stage of the so-called “designer catalysts,” in which totally new catalyst formulations are proposed on the basis of a detailed model relating catalyst composition and morphology to on-the-road performance. A summary list of process deficiencies include the following:

- Systems integration is immature. Optimization of PM and NO_x control devices is hindered by inadequate simulation capability for aftertreatment devices.
- The understanding and tools needed for predicting catalyst behavior are insufficient, limiting the ability to address technology shortfalls to a highly empirical procedure.
- Rapid-aging test methodologies are insufficient for research screening of new technologies.
- Rapid screening test methods are inadequate or unreliable, leading to slow, highly empirical catalyst development.
- Collaboration on precompetitive subjects is less than optimal among engine companies, emission control suppliers, and government scientific laboratories.

4.6.3.4 Technical Approach

To meet the challenges and deficiencies described, concurrent efforts at the system, component, and scientific foundation levels should proceed. System research is required to optimize the total emission control package while providing data on deficiencies in components as well as gaps in the technical understanding of phenomena in catalysts, adsorbers, filters, sensors, and controls. Systems optimization, and component performance, can be accelerated through the application of computer simulations; but for aftertreatment systems, these simulations must be substantially improved to be on a par with engine/combustion simulations. Finally, durability must be established and tested in real-world environments during the R&D process.

An unprecedented level of engine and aftertreatment integration will be required to achieve engine system durability simultaneously with future required emission-reduction and thermal-efficiency targets. There is a strong need to accurately model the flow, mass transport, and heat transport in the exhaust gases flowing to the converter from the engine, and to model the coupling between these macroscopic flow effects and the chemical processes occurring on the catalyst surface. This connection between the macroscopic flow field and chemistry is critical because either of these general regions can dominate the overall converter performance, depending on operating conditions.

Models for the surface chemistry and appropriate kinetics models that will accurately reflect the effects of individual exhaust-gas species and local variations in temperature require development. Integrating engine system thermal, chemical species, and flow effects with the aftertreatment device surface kinetics simultaneously in high detail should offer the most accurate predictions about the impact of design changes or changes to the catalyst properties. However, it will require teraflop levels of computational effort similar to those for detailed modeling of in-cylinder combustion. Low-order aftertreatment models offer another approach for situations where computational speed (as opposed to detail) is essential for modeling the complete engine and aftertreatment system over short transient events (such as for real-time diagnostics and control). In this second case, it would be advantageous to develop simplified versions of the detailed models that can still produce the correct overall system dynamic response.

A third major category of modeling needed for diesel emissions control is simulation of the mechanisms for catalyst regeneration, degradation, and poisoning by engine behavior. Specifically, if alternative methods are not found for reducing sulfur’s rapid inhibition of lean NO_x adsorber-catalysts, diesel fuels will have to be processed to extremely low sulfur levels, and potentially new approaches to ring/liner lubrication could be required. A detailed model for the physical and chemical processes involved in sulfur poisoning could potentially lead to improvements in catalyst design and/or operation that would

significantly increase the sulfur tolerance of catalysts and would lessen the need for expensive exhaust gas processing or complex catalyst regeneration or desulfurization processes.

The technologies of higher priority are NO_x adsorbers, urea SCR, and the related technologies that will support and optimize these systems while the development of DPFs for the complete system is completed. Certain features of plasma-assisted catalysis and HC SCR are highly attractive and also justify a viable program of R&D. The retrofit development of DPFs also should receive emphasis.

With regard to the R&D process, multi-industry and government collaboration will be expanded in precompetitive areas. These areas would include, in particular, development of simulation tools, fundamental mechanisms (degradation, for example), and experimental tools and methods. Federal laboratories will be partnered with industry and universities in these efforts.

In summary, the key components of the technical approach for aftertreatment emission control include the following:

- Identify and exploit fuel properties that reduce overall tailpipe emissions through lower engine-out emissions and/or enhancement of aftertreatment system performance (such as through a NO_x reducing agent).
- Improve the scientific foundation of NO_x control adsorber and catalyst performance and degradation mechanisms. Similarly, expand the foundation of understanding of plasma processes as they pertain to NO_x and PM control and to catalysts used specifically with plasmas.
- Utilize the above advancements in fundamental understanding to improve the materials, components, and system designs for emissions controls.
- Improve and apply emission control simulation tools for accelerating system design and optimization.
- Conduct continuing work at the system level to discover subtle interactions between NO_x and PM control devices and how to deal with them.
- Develop better methods and technologies for generating and introducing effective reducing species to NO_x catalysts and adsorbers, including fuel constituents.
- Develop desulfurization processes or sulfur sequestration technology for emission control devices. In parallel, develop and implement lubricants and fuels with the minimum feasible sulfur content.
- Devise suitable technologies and procedures for urea supply for SCR.
- Develop and apply sensors in controls and diagnostics of engine and emission control processes.
- Examine and exploit the advantages offered by hybrid drivetrains in NO_x adsorber operation and regeneration.
- In development of emission control aftertreatment devices, include the necessary features to make the devices suitable for retrofit to the existing fleet.

4.6.4 Hybrid Electric Propulsion Technologies

Hybrid electric propulsion systems may be needed to meet performance and efficiency goals for both commercial and military vehicles. Hybrid electric vehicles (HEVs) feature a power plant in combination with an electric motor(s) and electrical energy storage system. Many series, parallel, and power-split hybrid propulsion system configurations are possible. The optimum propulsion system configuration is dependent on the vehicle performance goals, efficiency goals, duty cycle, and other practical considerations, including manufacturing cost, serviceability, market differentiation, and customer acceptance of the technology.

Hybrid electric vehicles have the potential to have greater energy efficiency than vehicles with conventional power trains. In a HEV, the power plant can be utilized at its most efficient operating condition. Moreover, electric components can be used to brake the vehicle and to recover and store braking energy that can be used to propel the vehicle during subsequent accelerations. Hybrid electric

propulsion systems could replace engine retarders and hydraulic driveline retarders that dissipate braking energy as waste heat. Other mechanical energy storage devices could also be adopted, as discussed in Sect. 4.6.5.

Many of the heavy HEVs built to date have used components that are commercially available, but most of these components were not designed or optimized for use in on-road HEVs. Electric components can be costly because precision manufacturing tools are needed to produce the components and production volumes are low. There is tremendous potential to improve the performance and efficiency of these components through computer-aided redesign, systems optimization, and improved manufacturing techniques.

A new generation of components is needed for commercial and military HEVs. It is envisioned that the availability of improved components would promote the use of hybrid electric propulsion systems in a wider variety of vehicle applications.

A “crosscut” R&D effort is needed to develop enabling technologies for hybrid electric propulsion systems. Electric motors, electrical energy storage, power electronics, electrical safety, regenerative braking, and power-plant control optimization have been identified as the most critical technologies requiring further research to enable the development of higher efficiency hybrid electric propulsion systems. Development of improved electrical energy storage systems and power electronics is especially important due to the high cost and limited availability of new components and subsystems. Vehicle-specific optimization of the propulsion system will be performed as discussed in the vehicle platform sections of the roadmap.

4.6.4.1 Electric Motors and Generators

Status of Technology

Several types of motors and generators have been proposed for hybrid-electric drive systems, many of which merit further evaluation and development. Certain types of motors may work better for specific vehicle applications or performance requirements than others.

Motor generators can be configured before or after the transmission. Series HEVs typically have larger motors with higher power ratings because the motor alone propels the vehicle. In parallel hybrids, the power plant and the motor combine to propel the vehicle. Motor and engine torque blending is usually accomplished through couplings and planetary gear sets.

Motor subsystems such as gear-reductions and cooling systems must be considered when comparing the specific power, power density, and cost of the motor assemblies. Gear reductions may be needed for high-speed motors and can significantly increase weight. Air-cooled motors are simpler and generally less expensive than liquid-cooled motors. Liquid-cooled motors may also require more cooling-system maintenance than air-cooled versions. However, liquid-cooled motors are generally smaller and lighter for a given power rating. Various coolant options exist for liquid-cooled motors, including water, water-glycol, and oil.

The current status of electric motor technology is further discussed in Appendix F.

Technical Targets

To meet the performance requirements of the heaviest Class 8 trucks, the motive drive system must be capable of providing approximately 2,100 Nm of peak torque, with a peak power requirement of 300 to 400 kW and a continuous power requirement in the range of 150 to 200 kW. In series hybrid-electric drive systems, the main drive motor(s) must be sized to meet these torque and power requirements. In

parallel hybrid configurations, the motor(s) are assisted by a power plant (typically an internal combustion engine), so their peak power requirements are generally much lower.

The next generation of electric traction motors must have higher specific power and lower cost to achieve efficiency goals and customer expectations. Motors, gear reduction systems, and cooling systems must be improved through the use of advanced materials, improved cooling systems, novel packaging, and advanced assembly techniques. Motors with higher voltages and speeds may be needed to meet specific power and power density expectations.

Motor and generator subsystems, including gear reductions and cooling systems, should be designed for minimum cost, weight, and parasitic losses, and must have extremely high reliability for commercial and military vehicle applications. The motor itself should last the life of the vehicle without any major maintenance or servicing events, and the gear-reduction system should have reliability superior to that of conventional heavy-duty vehicle transmissions, which are inherently more complex.

Barriers

There are few, if any, inherent technical barriers to meeting the technical targets. Prototype heavy-duty hybrid vehicles have been successfully demonstrated with main drive motors with continuous power ratings ranging from as little as 37 kW to as much as 388 kW, an order of magnitude span. The main barriers relate to weight and cost reduction.

Most motors capable of powering a large Class 8 truck or transit bus [40,000 lb (18,140 kg) and greater] weigh more than 1,000 lb (454 kg). When gear reduction and cooling systems are included, total motor subsystem weight can approach 2,000 lb (908 kg). Lighter-weight motors have been demonstrated in commercial applications. Smaller, liquid-cooled motors with exotic designs are comparatively expensive and have not yet demonstrated durability in commercial vehicle applications.

Drive motors presently represent one of the most expensive components of heavy-duty HEVs, but also one of the greatest cost-reduction opportunities. Supplying the 300 to 400 kW of peak power required for large Class 8 vehicles requires the use of very large single motors with prices typically in the range of \$15,000 to \$50,000, or multiple smaller motors costing anywhere from \$10,000 to \$20,000. Hence, the total drive motor package for a large Class 8 truck or transit bus, including gear reduction, is unlikely to be procured at today's prices for less than \$30,000 to \$40,000 per vehicle. However, larger production volumes should lead to substantial reductions in parts costs. Achievement of the recent DOE cost target of \$4/kW (continuous) would require a reduction in motor production costs to less than \$1,000 per vehicle.

Historically, breakthroughs in the electrical motor design are rare.

Technical Approach

Several advanced technologies can be employed to improve the specific power and reduce the cost of electric traction motors. These include advanced winding methods, advanced assembly techniques, use of highly conductive or lightweight materials, development of optimized cooling systems, and novel packaging. Various motor-control methods can also be employed. (See Sect. 4.6.4.6.)

Systems analysis is needed in the early stages of the program to identify the best opportunities for cost and weight reduction. Results from the systems analysis will guide the R&D approach taken for each vehicle platform. In some cases the best design may include a combination of different motors and technologies.

A broad technical effort is recommended, focusing on traction motor systems and generators optimized for hybrid-electric drive systems. In the short term, emphasis should be placed on developing motors sized such that single or tandem motors can meet vehicle torque and power requirements.

Longer-term research should also consider the series wheel motor configurations. Means of reducing motor manufacturing costs should also be explored, including employment of automated production techniques.

Results from the systems studies will allow selection of available electric motor technology and will guide the specifications used for each truck application. In some cases the best design may include a combination of different motors and motor technology.

4.6.4.2 Electrical Energy Storage

An electrical energy storage system is needed to capture energy from the generator, to store energy captured during vehicle braking events, and to return energy when power is demanded by the driver. Whereas pure electric vehicles require a high-energy storage system, HEVs require high-power storage systems. Electrical energy storage systems currently consist of battery packs that have electrical, thermal, and safety control features.

The three major electrical energy storage systems that are being considered for hybrid electric propulsion systems are electrochemical batteries, ultra-capacitors, and electric flywheels. Over the past six years, the Partnership for a New Generation of Vehicles (PNGV) initiative has supported R&D of electrical energy storage systems for light-duty vehicles. PNGV has directed most of its resources to batteries because of the better potential for short-term commercialization. PNGV has established technical targets for the program's hybrid battery development efforts for power-assist and dual-mode HEVs. Ultra-capacitors and electric flywheels warrant further consideration in the 21st Century Truck Program because commercial vehicles have much different performance, cost, and service life requirements than light-duty vehicles.

A comparison of energy-storage options for heavy vehicles has been published by the Transportation Research Board (TCRP 2000) and is reproduced in Table 4.17.

Batteries

Status of technology. Although a few production HEVs with advanced batteries have been introduced into the market, improvements in life cycle economics, power, and energy efficiency are needed, especially for commercial and military vehicles that have longer service life requirements than light-duty vehicles.

Desirable attributes of high-power batteries for HEV applications are high-peak and pulse-specific power, high specific energy at pulse power, a high charge acceptance to maximize regenerative braking utilization, and long calendar and cycle life. Developing designs and methods to balance the packs electrically and thermally, developing accurate techniques to determine a battery's state of charge (SOC), developing abuse-tolerant batteries, and improving recyclability are additional technical challenges.

The heavy-duty hybrid system design offers a unique engineering opportunity to design the system so that batteries only assist at peak power demands or provide full power when the vehicle is used as an electric vehicle in urban areas with the internal combustion engine being a range extender. In the first application the depth of discharge may be only a few percent, 65% to 60% SOC, whereas in the second application the range of operation would be 65% to 20% SOC. Data on battery life are readily available for conventional electric vehicle applications but are far less certain for hybrid application.

Lead acid batteries are currently used in many electric vehicles and have been used in hybrid transit bus applications. Lead acid batteries can be designed for high power and are inexpensive, safe, and reliable. A recycling infrastructure is in place for them. But low specific energy, poor cold-temperature performance, and short calendar and cycle life are still impediments to their use. Advanced high-power lead acid batteries are being developed for HEV applications.

Table 4.17. Comparison of energy-storage options^a

	ElectroSource lead-acid ^b	Ovonics NiMH ^c	Saft advanced NiCad	Lithium ion ^d	3M Hydro Quebec lithium metal polymer	Maxwell Supercapacitor	Flywheel ^e
Model	H12N85	HEV 60 Ah	STX-600	<i>d</i>	119Ah	Pc2500	<i>e</i>
Specific power (W/kg)	240	500	350	300	315	3,305	600–5,600
Specific energy (Wh/kg)	42	70	35	90	155	248	15–132
Calendar life (months)	24	60 ^f		36 ^f		20–120 ^g	Lifetime of bus
Cycle life (full discharge cycle)	700	1,000	2,000	1,000	600	20–120 ^g	Lifetime of bus
Cost (\$/kWh)	295 ^h	200–2,000	833	1,000–3,000	10,526	N/A	150–2,000 (projected)
Maintenance	None	None	Distilled water	None	None	None	None
Recycling (%)	100	100	100	100	100	None	100

^aMain source: Transit Cooperative Research Program. (TCRP) 2000. *Hybrid Electric Transit Buses: Status, Issues, and Benefits*. Report No. 59. National Academy of Sciences, Washington, D.C.

^bBatteries currently used in Lockheed-Orion hybrid electric bus.

^cSpecifications for Ovonics 60-Ah battery model; cost range represents target (\$200/kWh) and current prototype costs (\$2,000/kWh).

^dVarious manufacturers and models. *Source*: California Air Resources Board (CARB). 1998. 1998 Zero-Emission Vehicle Biennial Program Review.

^eVarious manufacturers and models. *Source*: U.S. Department of Energy (DOE). 1996. *An Assessment of Flywheel Energy Storage Technology for Hybrid and Electric Vehicles*. U.S. Department of Energy, Washington, D.C.

^f*Source*: Transportation Research Board (TRB). 2000. *Review of the Research Program for a New Generation of Vehicles*. Sixth Report. Transportation Research Board, National Research Council, Washington, D.C.

^gLifetime of the supercapacitors depends on operating conditions such as temperature and operating voltage.

^hCost is based on purchases of single module; discounts are available for volume purchases.

Nickel-cadmium, nickel-metal hydride (NiMH), and lithium ion batteries have also been used in commercial and prototype HEVs. The current status of these batteries is further discussed in Appendix F. NiMH batteries are used in the Toyota Prius and Honda Insight.

Technical targets. Technical targets for energy storage systems depend on the type of hybrid configuration and type of vehicle. The technical targets in Table 4.18 are mostly drawn from the PNGV technical targets.

One of the most important targets is to achieve high power density while having adequate energy. Calendar life, cycle life, reliability, and safety are also very important issues that need to be addressed to enable successful commercialization.

Barriers. The primary barriers for electrical energy storage systems are achieving high power densities with high available energy, reliability, safety, and cycle life. Battery cost and life cycle costs are critical issues that could influence market acceptance for heavy vehicle applications. Many battery materials are currently too expensive. The chemicals used in many types of batteries need to be more stable to avoid self-discharge. Long, shallow discharges can cause chemical instability. Lithium ion batteries have potential safety issues. Other barriers are proper integration of batteries in a pack within the vehicle, thermal management, and proper control systems.

Table 4.18. Summary of current performance and technical targets for batteries^a

Parameter	Current performance		Technical targets	
	Li-Ion	NiMH	Power assist ^b	Dual mode ^c
Energy efficiency (%)	90	88	>90	>95
Calendar life (years)	3	5	6 ^d	6 ^d
Available specific energy (Wh/kg)	23	15	7.5	23.1
Specific power (18 s) (W/kg)	625	400	625	615
Cost/available energy (\$/kWh)	1,041	1,064	1,00	333
Available energy density (Wh/L)	29	23	9.4	37.5

^aSource: Transportation Research Board (TRB). 2000. *Review of the Research Program for a New Generation of Vehicles*. Sixth Report. Transportation Research Board, National Research Council, Washington, D.C.

^bPower assist is a type of parallel hybrid electric vehicle.

^cDual mode is a type of series hybrid electric vehicle.

^dAll technical targets are from PNGV except for the calendar life, which is for battery replacement at midlife of the vehicle (at 6 years for transient bus).

Technical approach. Research and development needs to meet the technical targets include the following:

- Near-term focus on battery development and demonstration of system performance is in the following tasks:
 - monitor battery electrochemistry research progress by PNGV and U.S. Advanced Battery Consortium;
 - use system simulation tools to develop system control strategies and charging algorithms;
 - battery electrochemistry research;
 - investigate a hybrid energy storage system that use either different types of batteries or a combination of ultra-capacitors, batteries and electric flywheels to determine the potential for load acceptance and system performance; and
 - integrate the energy storage system, including packaging, thermal management, and electrical management (monitoring, balancing, and control), using computer aided design tools, prototype fabrication and testing on bench scales, and limited heavy vehicle tests.
- Mid-term and long-term focus will be on development of advanced batteries and system validations via vehicle demonstrations. Safety, reliability, and cost issues will be the major focus.

Ultra-Capacitors

Ultra-capacitors are higher-specific-energy and higher-power versions of electrolytic capacitors—devices that store energy as an electrostatic charge. They are electrochemical systems that store energy in a polarized liquid layer at the interface between an ionically conducting electrolyte and a conducting electrode. Energy storage capacity increases by increasing the surface area of the interface. Ultra-capacitors have been developed as primary energy devices for power assist during acceleration and hill climbing as well as for recovery of braking energy. They are also potentially useful as secondary energy storage devices in HEVs, providing load-leveling power to chemical batteries. Current R&D aims to create ultra-capacitors with capabilities of 1,000 W/kg. Additional electronics are required to maintain a constant voltage because voltage drops as energy is discharged.

Maxwell Technologies has developed large ultra-capacitor cells up to 2700 Farads (10 Wh/l at 600 W/l). PowerStor has developed Aerogel cells with power of up to 4 kW/kg at 1 Wh/kg. JMK, Inc., has used ultra-capacitors for starting a transit bus and a truck with capacity of 1.6 Wh/kg at 1.3 kW/kg. Los

Alamos National Laboratory is conducting research on materials that can lead to capacitors with 0.9 Wh/kg at 3.2 kW/kg. Panasonic and Saft are also actively developing ultra-capacitors.

Further research is needed to investigate the potential for using ultra-capacitors in commercial and military vehicles. Ultra-capacitors may have better acceptance of regenerative braking energy than batteries and therefore could be a key enabling technology for improving energy efficiency. Ultra-capacitors may be used alone or in combination with battery systems. New ultra-capacitor concepts need to be developed and tested in the laboratory. Upon proof of concept, packaging, safety, energy management, and thermal management of ultra-capacitor banks must be further investigated for commercial and military vehicle applications.

Electric Flywheels

Modern high-performance flywheels offer several attractive features for use in hybrid vehicles. They have outstanding power handling capabilities, with low-to-moderate specific energy; therefore, flywheels are best fitted for applications that demand high power levels and relatively low energy storage, such as a “power assist” parallel hybrid vehicle. Flywheels provide significant advantages over batteries in the areas of calendar life, cycle life, efficiency, consistent performance at different temperatures and different ages, and ease of measurement of state of charge.

In an electric flywheel, the input and output energy is in the form of electrical energy. A motor/generator is installed inside with the high-speed flywheel rotor inside a vacuum housing. Operation of the rotor in vacuum greatly reduces the windage drag on the surface of the rotor. The motor rotor is attached to the flywheel rotor; permanent magnet motors are often chosen because they match well with the high operating speed of the flywheel (typically 40,000 to 70,000 rpm). Power electronics are necessary to provide the variable frequency input to the flywheel and to convert the variable frequency output to direct current.

A key design issue will be structural properties of the rotor to permit high-speed operation necessary for reasonable specific energy and minimization of risks associated with rotor failure. The rotor is normally fabricated with materials that have a high strength-to-density ratio, such as a carbon fiber/epoxy composite. Safety and containment are major issues being addressed by flywheel developers. Understanding of the safety issues (rotor stress design margin, rotor integrity, control of rotor failure modes, and containment system design) is a key barrier to the commercialization of flywheel technology.

Flywheels can be operated with ball bearings or magnetic bearings. Magnetic bearings provide the greatest efficiency, but their cost is higher.

Flywheels will use the same technical targets as batteries, with the understanding that the specific power target can be easily achieved, but the specific energy target is challenging. Due to their likely higher initial cost and longer life, flywheels will be most attractive when cost comparisons are made on a life cycle cost basis.

4.6.4.3 Power Electronics

Status of Technology

U.S. industries currently supply power electronic products for commercial and military HEV applications; however, no manufacturers in the United States can supply the high-power transistors required for such power electronic products. The power electronics system plays a crucial role in the conversion and distribution of power and energy in automotive applications. The selection of power semiconductor devices, converters/inverters, control and switching strategies, packaging of the individual units, and the system integration are very important for the development of an efficient and high-performance truck of the future. The current status of power electronics is further discussed in Appendix F.

Technical Targets

The power electronics system must meet the continuous operating requirements of the vehicle; therefore, it needs to be highly reliable and durable. The unit should be efficient to improve the fuel economy. Technical barriers relating to better power semiconductors, improved power management, reduced power loss, reduction of leakage currents, and packaging limitations must be overcome to achieve low cost, high reliability, and market-accepted systems. The power electronics and the rest of the system should be developed to reduce the operating costs of the vehicle. The system needs to be fault tolerant and needs to provide “limp-home” capability.

Several technical challenges need to be overcome, and new developments are needed from device level to system level. There is a strong need for a power device that combines the metal-oxide semiconductor (MOS) gate control characteristics with the current carrying capability and voltage drop characteristics of a thyristor-type structure. The device forward voltage drop, at even currents greater than 400 A, must be less than 2 V. The first device to meet these requirements was MCT, but it did not meet the expectations of the power electronics community. In addition to the switching device, there is a need for development of a new power diode with superior dynamic characteristics.

Wire bonding and device interconnections are barriers to development of high-current-density power units. Hence technologies related to device packaging need to be investigated for developing a power switch. Some of these technologies are topside power connection without wire bonds, minimizing wire bonds, topside probing for dynamic matching, heat-sinking both sides of the die, direct bond copper on alumina and aluminum-nitride substrates, interconnect solutions for large-scale manufacturing and reliable operation of power modules, and other related packaging technologies.

Capacitors with high-frequency and high-voltage operation, low ESR, and high ripple current capability need to be further developed. The technology of laminated bus bars with high isolation voltage and low inductance needs further work for use in truck-operating environments. To meet the packaging goals, the devices must be designed to operate over a much higher temperature range. The research needs to be focused on high-temperature capacitors, semiconductors, and sensors. The research on silicon carbide needs to be accelerated to enable its application to high-power switching devices. A novel way of cooling the entire unit should be examined to quickly transfer heat from the devices.

Although soft-switching inverters have the advantage of lower switching losses and low electromagnetic interference (EMI), they need more components compared with hard-switched inverters and may require higher operating device voltages and complicated control. Hence the soft-switched inverter application is limited to very special types of needs. There is a need to develop an inverter topology to achieve the performance of the soft-switched inverter with fewer components and simplified control. In the area of DC/DC converters, further development is needed to obtain 12 V from higher voltages (300 V and above), and manufacturing techniques need to be advanced to obtain reliable operation.

Methods to eliminate the motor speed/position sensors and inverter current sensors, have been under investigation for several years. These technologies have not yet proven to be practical for automotive applications. The technology development effort needs to be focused on sensorless operation of electric machines and reduction or elimination of current sensors in the inverters. The controllers need to be developed for robust operation of all vehicle subsystems.

The power electronics required for accessory loads must be individually evaluated to obtain the maximum efficiency under all operating conditions.

Barriers

The barriers for introducing improved power electronic systems for truck applications are the cost, complexity, reliability, and the operating environment. The PNGV cost target for the propulsion inverter

is \$7.00 per kW. This cost target is also applicable for commercial truck applications. For specialized civilian and military applications, the cost could be about \$9/kW.

The forward voltage drop of the power-switching device is a barrier to operating efficiency. The device forward voltage drop needs to be less than 2 V and at the same time needs to be able to be operated at switching frequencies higher than 10 kHz. Unavailability of low ESR, high-ripple-current capability, high-temperature, and high-voltage capacitors is a major barrier.

The other barriers are thermal system for fast removal of heat from the junction of the devices, control of EMI generated due to switching of the devices, and achieving a low-inductance package for the power inverter.

The cost of developing new manufacturing processes and packaging techniques are prohibitive for low production volumes.

All technical barriers can be overcome if sufficient resources are made available. The cost of developing new manufacturing processes and packaging techniques can be prohibitive for low production volumes.

Technical Approach

Power electronic components and subsystems need to be further developed to meet the reliability, service life and cost expectations for commercial and military vehicles.

In order to reduce the total system cost, the effort should be focused on the following:

- integration of the inverter and the motor as one system by using a design that can be tailored to meet specific vehicle requirements;
- low-cost manufacturing methods for the motor and inverter; and
- development of low-cost, high-temperature magnets. This would lead to widespread use of permanent magnet motors. Permanent magnet motors have higher efficiency and need less current to obtain the same torque as other motor types. This may also reduce the cost of related power devices.

The following technologies need to be investigated to develop an improved production-viable system for truck applications:

- Improved bus bar design with low inductance and high-voltage isolation capability. Methods to lower the bus bar resistance and integration of bus bar into the electronics packaging.
- Efficient cooling system.
- Improvement in connector technology.
- Capacitor technology needs to be significantly developed: high ripple current capability, low ESR, high voltage, and smaller size. Improved dielectric components need to be investigated.
- Inverters with very minimal use of capacitors.
- Power electronic building blocks.
- Topologies with two or more integrated functions such as inverter, charger, OTDC/DC converter.
- Integrated EMI filters.
- New soft-switching topologies with a reduced number of components, having simplicity similar to hard-switching converters.
- Lightweight enclosures that are waterproof and are immune to EMI.
- Reduction or elimination of speed/position, current, temperature, and voltage sensors.
- Fault-tolerant, fail-safe designs.

4.6.4.4 Electrical Safety

Status of Technology

Electrical safety requirements must encompass acceptable design practice, accessibility, durability of safety provisions, human factors and risk management. Electrical vehicle technology has led the way for development of hybrid vehicle safety technology to a substantial extent. However, the greater extent and complexity of high-voltage components and cabling in HEVs requires extension of safe practices. (For purposes herein “high voltage” shall be considered to be any voltage exceeding 50 volts DC or 50 volts rms AC.) Electrical safety can be considered in three subcategories: functional, personnel, and hazard identification and mitigation.

Functional safety includes establishing a product safety checklist and design practice, ensuring crash/rollover isolation, integrating of low-voltage accessories, and conducting failure effects and sneak-path effects analysis. Personnel safety includes consideration of emergency disconnects, access door/cover/power interlocks, high-voltage cable/harness routing, high voltage cable/harness unique identification, maintenance and emergency personnel training, and warning labels. Hazard analysis, tracking and mitigation is a formal process that has been used to define and improve functional and personnel safety objectives, and is further discussed in Appendix F.

Technical Targets

Technical targets include development of safety standards and codes for new hybrid electric propulsion systems and compliance with existing requirements and best practices:

- SAE Surface Vehicle Information Report J2344, Guideline for Electrical Vehicle Safety, June, 1998.
- SAE Surface Vehicle Recommended Practice J1766 – Recommended Practice for Electric and Hybrid Electric Vehicle Battery Systems Crash Integrity Testing, June, 1998.
- SAE Surface Vehicle Standard J1654, High Voltage Primary Cable, June, 1994.
- U.S. DOT Rules and Regulations.
- New York State DOT, Title 17, Official Compilation of Codes, Rules, and Regulations, State of New York, Part 720.9, Electric Powered Motor Vehicles, effective July 18, 1999.
- Underwriters Laboratory practices.

Barriers

Safety risks may be higher for prototype HEVs that have not been subjected to rigorous hazard analysis. Care must be taken to not overlook possible safety hazards.

Technical Approach

Participation in safety task forces and working groups will be essential to comply with existing safety standards, to comply with best practices, and to develop new safety standards if appropriate.

Special precautions must be taken to ensure the safe testing of prototype vehicles.

4.6.4.5 Regenerative Braking

Status of Technology

A conventional heavy vehicle relies on friction brakes at the wheels, in combination with an optional engine retarder or hydraulic transmission retarder to reduce vehicle speed. Kinetic energy is converted to heat primarily by the friction brakes. This conventional configuration has a large brake system, heavy

brake heat sinks, high infrared signature at the wheels, audible brake squeal, and consumable components requiring maintenance and replacement.

Hybrid electric propulsion systems recover some of the vehicle's kinetic energy through regenerative braking, where motive energy is captured and directed to an energy storage device. The remaining kinetic energy is dissipated through conventional wheel brakes or brake retarders. The regenerative braking system requires an air-pressure input from the friction brake system to function. Because the brake pedal is linked to the friction braking system, application of the brake pedal causes the friction brakes to engage. Consequently, there is always simultaneous operation of both the electric regenerative system and the friction system, allowing only some of the kinetic energy to be captured electrically. This type of hybrid braking system helps fuel economy, emissions, brake heat, and wear; however, further benefits may be realized by the development of an electric regenerative braking system decoupled from the wheel brake friction system.

Technical Targets

A brake-by-wire (BBW) braking system provides the ability to capture the maximum amount of the vehicle's kinetic energy during deceleration, thereby reducing fuel consumption, emissions, weight, noise, heat loss, and brake maintenance. In concept, the brake pedal would provide an electronic signal to a brake system processor, the pedal would not be directly connected to the braking system as in current practice air brake treadle. From the pedal signal the processor would determine the amount of braking torque requested by the operator. The processor would then command the propulsion control system to provide regenerative braking as required, up to the maximum capacity of the energy storage and propulsion system. The brake processor would command the pneumatic or hydraulic brakes to actuate and assist in slowing the vehicle only when the braking torque required were to exceed the regenerative capacity of the propulsion system.

Maximizing regenerative braking energy recovery has benefits in the areas of fuel economy, emissions, weight, heat, noise, and maintenance. Today, hybrid drive systems typically activate regenerative braking as the brake pedal is depressed to a maximum comparable to an aggressive transmission. As the brake pedal is further depressed, the mechanical brake pressure continues to rise until the brakes reach full brake pressure in a hard brake application [about 45 lb (20 kg) force]. Based on the capacity of a typical energy storage device the amount of regenerative braking can increase by as much as 75%. Currently the regenerative braking recovers 15% to 19% of the inertial energy during a CBD14 test cycle. This test cycle represents urban stop-and-go operation, from 0 to 20 to 0 mph 14 times, maintaining the 20 mph for 10 seconds and having a 7-second idle between cycles. The potential improvement from changes in the regenerative brake control algorithm translates into a 7 to 13% fuel economy and emissions savings. New electrical storage devices could raise this even further by allowing more power to be stored without causing the voltage to rise beyond existing limits. Because most of the braking can be accomplished electrically through the propulsion system the need for massive friction brakes is lessened, decreasing overall vehicle weight and particularly unsprung weight for improved ride quality. The friction brakes will not have to work as hard, thereby minimizing heat generation and reducing tire degradation and brake maintenance. Also, because they work less, the friction brakes will create less noise.

Barriers

Technical barriers can be overcome if sufficient resources are made available. The cost of designing, developing, and testing prototype regenerative braking systems could govern the rate of technology development.

Technical Approach

Development of improved regenerative braking systems will involve cooperation among key component suppliers and vehicle manufacturers to identify system requirements. Simulation will be performed to estimate possible energy-savings benefits that will be realized for candidate vehicle platforms. Improved energy storage systems will be needed. System design and prototype development will be carried out to prove the concept.

Resistance braking will also be examined as an approach to dissipate braking energy and extend wheel brake life.

4.6.4.6 Power Plant and Control System Optimization

Status of Technology

Most heavy-duty HEVs produced to date use commercially available internal combustion engines for on-board power generation. The engine's displacement and power rating is generally lower for HEVs because the energy storage system provides stored braking energy during accelerations or peak power demands. Diesel-electric and natural gas-electric hybrids have operated successfully in commercial fleets.

Engine operating conditions are substantially different for conventional vehicles and HEVs. There are opportunities to design a purpose-built engine for use in hybrid electric propulsion systems to improve fuel efficiency. For instance, electronic controls can be used to "switch on" the engine such that it generates electrical power near peak efficiency (at peak torque conditions), and does not operate at low-load and high-speed conditions, where efficiency is low.

Gas turbines and fuel cells have also been installed in prototype HEVs. High-speed gas turbines are well-suited to series hybrid vehicles because there is synergism with the electrical generators. These generators can be very small and efficient when designed for the turbine's high rotational speed. Reformer-equipped fuel cell engines, which may have limited response rates, can use the hybrid's energy storage system to augment acceleration power. Aside from such major departures in vehicle engines, large benefits are still envisioned from hardware changes which capitalize on specific operating zones and limited rates of change, which are the cornerstones of hybrid engine operation.

First-generation heavy-duty HEVs have met or exceeded expectations for fuel economy and emissions reductions. These vehicles were built with predominantly "off-the-shelf" commercial components, including the engine, battery, and generator. Although these components have worked in the new hybrid application, further energy-efficiency gains may be realized when components and controls are designed with the hybrid system in mind. Cost and efficiency gains may be realized if components can be combined into fewer, more integrated packages.

Technical Targets

Current series-hybrid transit buses operating in New York City have about 1.25 times greater fuel economy than conventional diesel buses. Further development of on-board power-generation systems and optimization of those systems is expected to improve the fuel economy of the vehicle by an additional 20%.

Barriers

Alternative power plants, such as fuel cells and gas turbines, are less mature than mass-produced internal combustion engine technology. These alternative power plants will require extensive R&D to match diesel engine efficiency, reliability, and operating cost.

Technical Approach

Power plant performance, emissions and efficiency may be improved by pursuing these research activities:

- Internal combustion engines further optimized for efficient operation in hybrid vehicle applications. This may also include reduction of parasitic loads by replacing gear-driven accessories with higher-efficiency electrically driven accessories.
- Novel internal combustion engine concepts that may be inappropriate for conventional drivetrains. HCCI, for example, has the potential to overcome the current-day NO_x, PM, and fuel-economy trade-offs without extensive exhaust aftertreatment systems. Other combustion concepts may be utilized to greater advantage in hybrid systems as well.
- Development of alternative power plants, such as fuel cells and gas turbines.
- Exhaust aftertreatment devices, which may have higher emission conversion efficiencies in a hybrid electric propulsion system with smart controls.

Several key areas of innovation are available for control hardware and software that can bring about further improvements in the safety, emissions and fuel economy of HEVs.

On-board diagnostics. Hybrid vehicles employ energy storage devices to reduce emissions. Some form of on-board diagnostics (OBD) can be used to monitor and flag conditions that could upset the emissions-saving effect of the energy storage system. Currently, industry uses OBD sensors on the engine alone. Research is required to invent monitors for energy storage devices.

Global positioning systems. Interface for Energy Storage Scheduling: Many have proposed that global-positioning systems (GPSs) will allow hybrid controls to take into account the road situation before it is encountered. Anticipating stops, starts, hills and dales will allow for gradual adjustment of the state of charge (SOC) of the energy storage system. In turn, the engine will be buffered from abrupt or large departures from optimum conditions.

Advanced control algorithms. Today's controls rely on predetermined truth tables and fixed or adaptive calibration tables for actuation of operations. Fixed logic is poor because it does not handle component aging or unexpected operating conditions. Adaptive controls alleviate these concerns but may not be sufficiently robust for hybrid systems. Researchers are considering "fuzzy logic" and neural networks as tools to capitalize on the control flexibility of hybrid propulsion. However, there is no clear path choice of this or any other alternative algorithm strategy.

Improved energy management strategies. Hybrid vehicles require operating and control strategies that coordinate the allocation of energy flow through a hybrid system. Energy allocation is the key to the emissions, fuel economy, and performance of the vehicle. Improved strategies are required to adapt to various driving cycles, driving patterns, and other requirements to optimize the overall system performance. These strategies will also be required to coordinate braking implementation from multiple sources such as regeneration, service brake, retarder, engine exhaust brake, and electrical grid. With all of the choices available to the controls engineer, simulation will be the key to good vehicle strategy.

Control feature development. Control algorithm development is required to define and implement features such as trap regeneration, hill-hold, anti-lock braking system (ABS) coordination, traction control, and other safety and driveability improvements.

High-speed communication networks. Current heavy-duty vehicles predominantly utilize the SAE J1939 Communication Area Network (CAN). This system has been adequate for conventional engine-transmission systems and current hybrid prototypes, but the number of distributed controls for safety, economy, and emission controls on future trucks will stress the data communication of CAN systems.

EPA requirements for on-board diagnostics must also be considered for future vehicle communication technology.

Hybrid tools and standards commonality. It would benefit the hybrid drive industry to have common diagnostic tools for service and data acquisition between various components such as engines, APUs, batteries, power electronics, and system controller.

System architecture optimization. Trade-off studies are required to develop and optimize the hybrid vehicle system architecture for both series and parallel configurations. This will include combining cooling systems to reduce weight and components, techniques for dissipating excess braking energy, evaluation of auxiliary power systems, integration of the power electronics and vehicle control functions, simplification of the overall system to improve reliability and reduce cost, and evaluation of the control impact of alternative energy storage systems.

4.6.5 Mechanical Hybrid Truck Technology

4.6.5.1 Status of Technology

Hybrid technology offers a new way to design and build trucks in order to double and triple the fuel economy under the 21st Century Truck Program. The basic components in the design of mechanical hybrid trucks are functionally similar to the components in electric hybrids; however, the detailed design and implementation varies substantially. There are at least two critical advantages that make mechanical hybrids worth considering along with electric hybrids as a technological solution to meet the Program goals. First, mechanical hybrids are likely to be able to capture significantly more of the regenerative braking energy because the mechanical storage system generally has higher specific power than a battery system. Second, mechanical hybrid storage components may last through several rebuilds of a truck, whereas batteries are likely to be replaced two to four times during the life of the truck.

Figure 4.14 illustrates simple schematics for conventional and “parallel” mechanical hybrid trucks. The defining characteristic of a mechanical hybrid, of course, is that it has two power sources. Here, the “advanced engine” is the primary power source. The mechanical and electric storage systems are analogous in concept. For example, a mechanical design could use a hydraulic pump for storing pneumatic energy in an accumulator or a flywheel; an electric design would use a generator to store energy in batteries or an ultra-capacitor. Finally, the pneumatic system would use a hydraulic motor to retrieve the mechanical stored energy; the electric system would use an electric motor to retrieve energy from batteries and deliver it to the drive shaft.

Hybrid propulsion systems provide a “buffer” between the power required to propel the truck and the power produced by the engine; this buffer moderates the variation of power demand experienced by the engine. The buffer also allows regenerative braking (recovering much of the energy otherwise lost in the brakes) because it can receive and store energy from both the engine and other sources as well. One of the significant benefits of mechanical hybrids over electrical hybrids is that mechanical systems have a much greater capacity to store the recovered energy. The overall effectiveness of a mechanical hybrid propulsion system depends on its ability to operate the engine at peak efficiencies and on the capacity and efficiency of the buffer medium.

Many mechanical hybrid designs are possible. Major contenders for the “primary” power source are piston engines and gas turbines. Major options for the “secondary” power source include flywheels, hydraulic accumulators, and heat batteries. By pairing up the various primary and secondary power sources, it is possible to identify a large number of potential mechanical hybrid truck designs.

Conventional Design

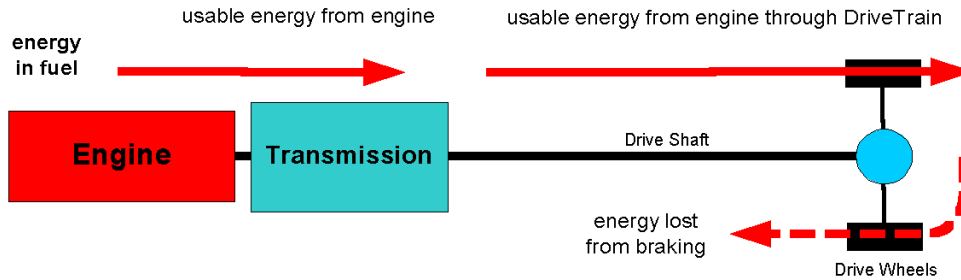

"Parallel" Mechanical Hybrid Design

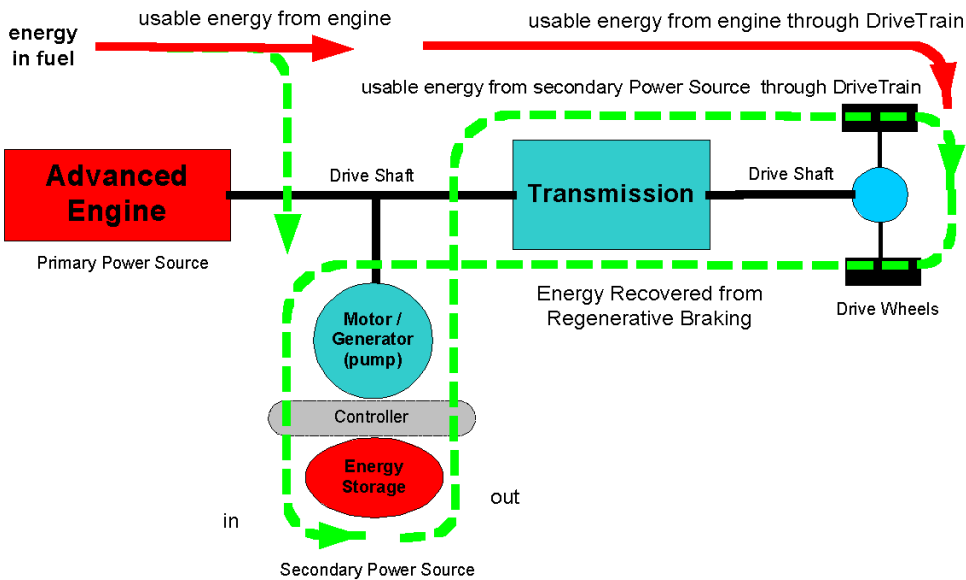

Fig. 4.14. Schematics for conventional and parallel mechanical hybrid vehicle designs.

Figure 4.15 illustrates the various ways that hybrid trucks can process and store energy. Energy stored chemically in a fuel can be “transformed” to heat energy on the mechanical side (e.g., through a combustion engine) or to electric energy on the electrical side (e.g., through a fuel cell). A heat engine could be used as the primary power source, either for mechanical hybrid storage or for electric hybrid storage. Likewise, a fuel cell could be used as a power source for either type of hybrid storage, but it is much more likely to be used in an electric hybrid.

4.6.5.2 Potential Efficiency of Mechanical Hybrid Trucks—Technical Targets

This discussion will focus on changes to three primary design areas to achieve the 3× fuel efficiency goal; engine efficiency, drivetrain efficiency, and regenerative braking efficiency.

The first key source of energy loss in a conventional truck is simply an inherent aspect of today’s internal combustion engine, and how the engine and its drivetrain are operated in the truck. The efficiency of an engine is limited by thermodynamics, but the best engines today only achieve peak efficiencies in the

Energy Transformation for Hybrid Vehicles

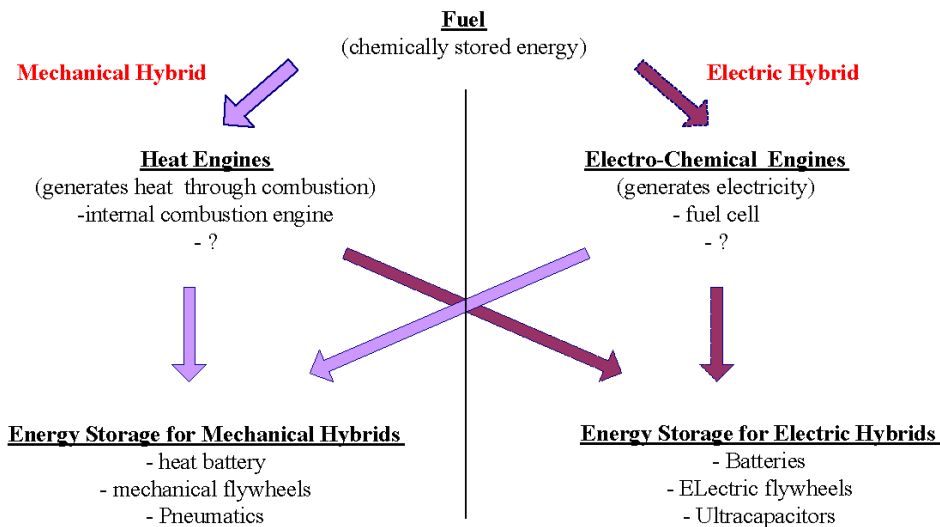

Fig. 4.15. Various ways that mechanical and electrical hybrid vehicles can process and store energy.

40 to 45% range, and their average efficiency is significantly lower. Average engine efficiency in current trucks is the result of a poor match between engine power capacity and average power demand. The peak efficiencies of an engine occur at high loads, yet many trucks operate much more frequently at low loads, where the engine efficiencies are much lower. When the engine is the only source of power on board a truck, it must be sized to meet the highest power requirements (such as when commanding maximum acceleration from 0 to 65 miles per hour or towing a load up an extended grade) even if those high power levels are needed only occasionally. However, the transient nature of truck operation, particularly in urban driving, results in very inefficient operation of the engine. The bottom line is that, based on these and other factors, an engine that might have a peak efficiency of over 40% might only average 15 to 20% efficiency in typical urban driving.

The second source of energy loss is inherent in the drivetrain used in conventional trucks, which have drivetrain efficiencies in the low 70% during urban driving. A mechanical hybrid drivetrain can have efficiency improvements near 10%.

A third critical source of energy loss in trucks is braking. In contrast to acceleration, which delivers energy to the wheels, braking removes energy from the wheels. Because an internal combustion engine can only produce and not reclaim energy, a conventional power train is a one-way energy path. Braking is achieved by a friction braking system, which renders useless the temporarily unneeded kinetic energy of the truck by converting it to heat. In city driving, braking can waste up to one-half of the useful energy that the engine is able to provide to the wheels.

Tables 4.19 and 4.20 illustrate what fuel efficiency could be achieved by utilizing mechanical hybrid components in a typical Class 2b or Class 6 truck. Case 1 shows the baseline efficiencies for a conventional diesel Class 2b or Class 6 truck. Cases 2, 3 and 4 reveal improvements that are directly related to the engine and mechanical hybrid systems. Cases 5 through 10 illustrate some of the additional efficiencies that are possible by reducing the energy demands resulting from aerodynamic drag, rolling resistance, and weight. Other cases could be added to illustrate designs that factor in improvements such as accessory power and exhaust heat recovery. All the modeling that was completed had assumed EPA's

Table 4.19. Efficiencies of diesel mechanical hybrid Class 2b trucks (small)

Configuration	Case	Configuration ^a				Efficiency (%)						Fuel economy (mpg)			Factor increase		
						Engine		Drivetrain		Regen brake							
		A _f	C _d	C _{rr}	lb	City	Hwy	City	Hwy	City	Hwy	City	Hwy	Comb	City	Comb	
Conventional gasoline ^b	0	3.7	0.47	0.01	9,000	20	28	70	79	0	0	10.3	18.0	12.8	0.7	0.7	<i>Baseline</i>
Conventional diesel ^c	1	3.7	0.47	0.01	9,000	29	33	70	79	0	0	15.0	21.2	17.2	1.0	1.0	
Diesel mech. hybrid ^d	2	3.7	0.47	0.01	9,000	37	39	76	76	67	66	30.2	25.9	28.1	2.0	1.6	<i>Hybrid related</i>
Diesel mech. hybrid ^e	3	3.7	0.47	0.01	9,000	42	42	76	76	67	66	34.3	27.8	31.0	2.3	1.8	
Diesel mech. hybrid ^f	4	3.7	0.47	0.01	9,000	42	42	85	85	80	80	41.6	31.8	36.5	2.8	2.1	
Diesel mech. hybrid ^g	5	3.7	0.38	0.01	9,000	42	42	85	85	80	80	44.1	35.6	39.8	2.9	2.3	<i>Energy demand Reductions</i>
Diesel mech. hybrid ^h	6	3.7	0.38	0.0075	9,000	42	42	85	85	80	80	51.1	40.2	45.5	3.4	2.6	
Diesel mech. hybrid ⁱ	7	3.7	0.38	0.0075	8,200	42	42	85	85	80	80	54.5	41.8	47.9	3.6	2.8	
Diesel mech. hybrid ^j	8	3.7	0.34	0.0075	8,200	42	42	85	85	80	80	56.4	44.5	50.3	3.8	2.9	<i>Energy demand Reductions</i>
Diesel mech. hybrid ^k	9	3.7	0.34	0.0075	7,400	42	42	85	85	80	80	60.6	46.5	53.3	4.0	3.1	
Diesel mech. hybrid ^l	10	3.7	0.34	0.006	7,400	42	42	85	85	80	80	66.7	50.2	58.1	4.5	3.4	

^aA_f = frontal area; C_d = drag coefficient; C_{rr} = rolling resistance coefficient.

^bGasoline baseline.

^cDiesel baseline.

^dEngine running at peak with secondary storage and regenerative braking.

^eAdding advanced high-efficiency engine.

^fImproving drivetrain and recovery from braking.

^gLowering C_d by 20%.

^hLowering C_{rr} by 25%.

ⁱLowering weight by 2,000 lb (10% of unloaded weight).

^jLowering C_d by an additional 10%.

^kLowering weight by 2,000 lb more (20% of unloaded weight).

^lLowering C_{rr} by an additional 20%.

Table 4.20. Efficiencies of diesel mechanical hybrid Class 6 trucks (medium)

Configuration	Case	Configuration ^a				Efficiency (%)						Fuel economy (mpg)			Factor increase		
						Engine		Drivetrain		Regen brake							
		A _f	C _d	C _{rr}	lb	City	Hwy	City	Hwy	City	Hwy	City	Hwy	Comb	City	Comb	
Conventional gasoline ^b	0	7.1	0.6	0.008	22,000	20	28	70	79	0	0	4.4	7.9	5.5	0.7	0.7	<i>Baseline</i>
Conventional diesel ^c	1	7.1	0.6	0.008	22,000	29	33	70	79	0	0	6.4	9.3	7.5	1.0	1.0	
Diesel mech. hybrid ^d	2	7.1	0.6	0.008	22,000	37	39	76	76	67	66	13.6	11.5	12.5	2.1	1.7	<i>Hybrid related</i>
Diesel mech. hybrid ^e	3	7.1	0.6	0.008	22,000	42	42	76	76	67	66	15.4	12.3	13.9	2.4	1.9	
Diesel mech. hybrid ^f	4	7.1	0.6	0.008	22,000	42	42	85	85	80	80	18.9	14.1	16.4	2.9	2.2	
Diesel mech. hybrid ^g	5	7.1	0.48	0.008	22,000	42	42	85	85	80	80	20.3	16.1	18.1	3.1	2.4	<i>Energy demand</i>
Diesel mech. hybrid ^h	6	7.1	0.48	0.006	22,000	42	42	85	85	80	80	23.1	17.9	20.4	3.6	2.7	
Diesel mech. hybrid ⁱ	7	7.1	0.48	0.006	20,000	42	42	85	85	80	80	24.6	18.5	21.5	3.8	2.9	
Diesel mech. hybrid ^j	8	7.1	0.43	0.006	20,000	42	42	85	85	80	80	25.6	19.8	22.6	4.0	3.0	<i>Reductions</i>
Diesel mech. hybrid ^k	9	7.1	0.43	0.006	18,000	42	42	85	85	80	80	27.4	20.7	23.9	4.3	3.2	

^aA_f = frontal area; C_d = drag coefficient; C_{rr} = rolling resistance coefficient.

^bGasoline baseline.

^cDiesel baseline.

^dEngine running at peak with secondary storage and regenerative braking.

^eAdding advanced high-efficiency engine.

^fImproving drivetrain and recovery from braking.

^gLowering C_d by 20%.

^hLowering C_{rr} by 25%.

ⁱLowering weight by 2,000 lb (17% of unloaded weight).

^jLowering C_d by an additional 10%.

^kLowering weight by 2,000 lb more (33% of unloaded weight).

standard transient driving cycle for light-duty vehicles. When used in an urban setting, comparable efficiencies are possible for a Class 8 transit bus, and a Class 8 mechanical hybrid truck.

4.6.5.3 Barriers to Implementation

This section summarizes the key implementation changes and potential barriers for mechanical hybrids to achieve the Program goals. Additional details of these challenges are described in the mechanical hybrid Appendix G.

Secondary Energy Storage/Release

Accumulators and flywheels perform a similar function to a battery in an electric hybrid. They are able to quickly absorb and release large amounts of energy (high specific power). A 95% efficiency is needed to meet the fuel economy improvement goal.

Important design parameters for accumulators include weight, specific energy (energy storage density), cycle efficiency (charge/discharge efficiency), cost, safety, and optimum storage pressure. A 30-gal accumulator (for a Class 6 truck) made of steel weighs approximately 600 lb (272 kg). The challenge is to reduce weight, most likely with high-technology materials, without increasing cost. Specific energy will be improved by reducing accumulator weight and by increasing system pressure. Cost reduction will be accomplished by utilizing advancements in compressed natural gas storage containers and by high production volumes. Safety will be enhanced by new materials, such as Kevlar and other strong light weight fibers, acting as a “blanket” allowing the release of gas pressure but inhibiting the release of high-pressure oil or vessel fragments. Trade-offs between weight, cost and specific energy will determine the optimum storage pressure.

The efficiency of flywheels may be improved by evacuation of the cage and air bearings. The trade-off between low speed/high mass and high speed/low mass will be investigated. Structural integrity will be a major design issue.

Power Management and Transformation

Power must be efficiently transferred from the source(s) to the road. Hydraulic hybrid designs include control valves, actuators and clutches. Flywheel hybrid designs use CVTs, clutches, and conventional transmissions. Overall, power management efficiency needs to be between 90 and 95%. Power transformers with an unlimited number of “gear” ratios (CVTs, pumps/motors) will allow the engine to operate at its most efficient point. Systems will be complicated to control, especially when regenerating energy.

Regenerative Braking

In urban driving, braking can waste one-half or more of the total energy to the wheels. In a hydraulic hybrid, the energy is recovered by using a hydraulic pump to store braking energy in the accumulator for reuse to power the truck or for other purposes. In a mechanical hybrid, the energy is recovered by using a CVT to spin up the flywheel. The CVT is then used in reverse fashion to transfer the energy back to the vehicle. Efficiency of energy recovery, safety, and cost are the most important issues. Based on hardware currently available, none of which has been optimized for automotive

applications, overall net efficiency is around 60%. The long-term goal is to increase it to 80%. Ultimately, regenerative braking will have to be fully integrated with anti-lock systems.

Control Technology

Hybrid systems will require more complex control systems. The control problem is complicated by the need to coordinate and optimize the utilization of two different power sources (the engine and the flywheel or hydraulic system) as well as the additional components associated with the regenerative braking. The challenge will be to minimize the added complexity.

Accessories

Today accessories are powered inefficiently. Because they are sized for low engine speeds, a lot of power is wasted at high engine speeds. In a mechanical hybrid, the energy for the accessories could come from the accumulator or the flywheel. This will allow the engine to be shut down when the power demand is low. The Program designs will consider the incremental fuel economy benefit against the cost of changing accessory components.

4.6.5.4 Technical Approach

- Develop designs and materials for safe, high-density-energy storage accumulators and flywheels for secondary energy storage.
- Develop very high-efficiency power transformer devices.
- Develop very high-efficiency (greater than 80%) regenerative braking systems that are safe and dependable.
- Develop hybrid control technology to optimize power management, including auxiliary devices.

4.6.6 Fuel Cells

A fuel cell is an electrochemical device that generates electricity by harnessing the reaction of hydrogen and oxygen. Because it converts the chemical energy of a fuel into electrical energy without combustion, the process is highly efficient and extremely clean. There are many types of fuel cells—proton exchange membrane (PEMFC), molten carbonate (MCFC), solid oxide (SOFC), phosphoric acid (PAFC), alkaline (AFC)—distinguished by the electrolytes that are used and the temperatures at which they operate (Appleby 1989, Larminie and Dicks 2000). All fuel cells can use pure hydrogen as a fuel or can use reformed hydrocarbon fuels such as gasoline, diesel, methanol, ethanol, or natural gas.

Three fuel cell types, PEMFC (Chalk 1999), SOFC (Solid State Workshop 2000), and AFCs, are applicable for use as prime power or auxiliary power units for vehicles. The PEMFC capitalizes on the simplicity of the cell. The electrolyte is a solid polymer in which protons are mobile. PEMFCs operate at low temperature (90 to 110°C) and use noble metal catalysts on the electrodes to provide acceptable reaction rates. All fuel cells are composed of the same core building block, a single cell, which when layered makes a stack. Each component of the single cell serves a unique purpose, without which it could not function properly. In the PEMFC, hydrogen gas ionizes at the anode, releasing electrons and creating protons. At the cathode, oxygen ionizes and reacts with protons to form water.

The SOFC operates at high temperature (600 to 1,000°C), which allows the electrochemical reactions to proceed without the need for noble metal catalysts (Minh and Takahashi 1995). The high operating temperature also allows certain fuels to be internally reformed in the fuel cell stack, eliminating the need for an external reformer. Although the SOFC is inherently simple, the ceramic materials and manufacturing methods can be expensive. The cathode is the electrode on the air side of the fuel cell that provides the electrocatalytic activity and the surface on which molecular oxygen is ionized. The electrolyte conducts the oxygen ions to the anode. The anode serves to catalyze the fuel to form H₂, and CO or CO₂ and serves as the place where oxygen ions, conducted through the electrolyte, react with hydrogen to form steam and electricity.

The AFC has two porous electrodes, which are separated by a circulating potassium hydroxide electrolyte operating at low temperature (70°C). Hydrogen is passed over the outside of one electrode, and air is passed over the other. AFC systems operate well at room temperature; they yield the highest voltage of all fuel cell systems, and cell and electrodes can be built from low-cost carbon and plastics.

Fuel cells may offer unique performance benefits that may be integrated into heavy-duty vehicles. Because fuel cells are electric power plants, there will be additional opportunities to more easily integrate electronic components such as GPS tracking, laptop access to the Internet, paging/fax devices, traffic information devices, climate-controlled seats, and more, into vehicles. Electrically driven accessories that can enhance the overall fuel efficiency of an electric vehicle will also enhance the overall efficiency of a fuel cell vehicle.

4.6.6.1 Status of Technology

A.D. Little recently completed a study for DOE to assess the current state of fuel cell development and the capability to meet the fuel cell technology goals established by PNGV (A. D. Little 2000). Although there are significant differences between the requirements for light-duty and heavy-duty vehicle applications, the wealth of information developed for fuel cells as part of the PNGV program and other automotive efforts provides a valuable starting point. The study assessed the cost of a 50-kW PEMFC system for transportation applications, including a multi-fuel-capable reformer, the fuel cell stack, and balance-of-plant components. The study concluded that, using currently available technology, the 50-kW fuel cell system (if it were factory produced, assuming volumes of 500,000 vehicles) would cost \$14,700, or \$294 per kilowatt.

It has been estimated that about \$1 billion a year is now being spent on fuel cell technology development, with transportation applications accounting for the lion's share of this support. DaimlerChrysler alone has stated that it will spend \$1.4 billion over the next four years to bring fuel cell vehicles to the marketplace. It is important to note that the automotive effort is focused on PEMFC technology.

While most of the attention has focused on fuel cell applications for passenger vehicles, the basic fuel cell power plant potentially can be used across a range of light- and heavy-duty vehicles. A significant difference between light-duty and heavy-duty applications is the current durability of automotive engines (gasoline) and truck engines (diesel). The useful life of an automotive engine is 5,000 hours/100,000 miles. In contrast, truck or bus engines have expected useful lives of 20,000 to 25,000+ hours/500,000 to 750,000 miles. It is anticipated that the useful mileage will grow to 1,000,000 miles in the future. Additionally, the current fuel of choice for heavy-duty vehicles is diesel, contrasted with gasoline for light-duty vehicles.

Whether the fuel cell technology being developed for the automotive market, PEMFC, will also satisfy the truck and bus market is not certain at this point. However, SOFCs have some characteristics that warrant their consideration for truck and bus applications. These include (1) high efficiencies (as high as 70% for a simple cycle); (2) lower electrode polarization/ohmic losses without use of catalysts; (3) ability to use fuels containing CO and inorganic impurities, such as sulfur; (4) fuel flexibility using direct and indirect reforming of logistic, common, and complex liquid fuels; and (5) operation over a wide range of temperatures from 600 to 1,000°C.

There are two major transportation applications for SOFCs: (1) auxiliary power and (2) prime power to replace diesel engines, particularly those that run at varied power levels and in continuous operation (idling).

A central issue in transportation applications is power density, or energy per unit volume, which determines how well a fuel cell plant will fit into vehicles. Preliminary calculations indicate that as fuel cell power densities approach three times the current state of the art, the size of a SOFC power unit would

equal the size of an internal combustion engine on a comparable power-out basis. However, the current SOFC would easily fit into a large diesel or locomotive without any changes. A transportation engine of nearly 70% efficiency would greatly reduce CO₂ emissions (by 36%) and reliance on imported petroleum. Relative to internal combustion engine technology, a multistage fuel cell engine may increase cruising ranges dramatically.

Fuel cell transit bus demonstrations are ongoing in the United States, Canada, and Germany. Running on fuels such as natural gas, hydrogen and methanol, these buses are much cleaner than even the most advanced diesels. For example, tests performed on Georgetown University's second-generation fuel cell bus—featuring a methanol-powered PAFC fuel cell power plant built by International Fuel Cells (IFC)—showed zero emissions of PM and hydrocarbons and near-zero emissions of CO and NO_x.

Ballard Power Systems has used fuel cells to power ten transit buses, six of which have been used in revenue service. Ballard has established an alliance with DaimlerChrysler and Ford to form EXCELLSiS Fuel Cell Engines, Inc., a company dedicated to developing and commercializing PEMFC systems for cars, buses and trucks. EXCELLSiS plans to begin commercial production of its Phase 5 fuel cell engine by the end of 2002. The company plans to produce transit bus fuel cell engines by 2007 that are cost-competitive with buses using CNG.

Thor Industries, IRISBUS, and NovaBus (Volvo) have received or are working with IFC to develop commercial vehicle fuel cell power plants for transit bus applications. IFC power plants used in these activities are fueled with hydrogen, California Reformulated Phase II Gasoline, or methanol. Delphi Automotive Systems also is developing PEMFC power plants for traction applications. In addition, IFC and Freightliner are developing PEMFCs for auxiliary power applications, and Delphi is focusing on SOFCs as auxiliary power units.

Several companies are working on fuel processing systems for fuel cell vehicle applications. Nuvera Fuel Cells announced plans to ship complete gasoline-powered fuel processing systems to four major automotive companies in the United States, Europe, and Japan for testing in demonstration vehicles. McDermott Technology and Catalytica Advanced Technologies are developing a compact catalytic fuel processor capable of processing multiple fuels into a hydrogen-rich gas. General Motors and Exxon have developed a gasoline fuel processor that puts 80% of the hydrogen it generates into the fuel cells. IFC has developed and is delivering to auto makers a fuel processor that generates hydrogen from California Phase II reformulated gasoline. IFC and Shell Hydrogen are establishing a company to develop and sell fuel processors for automobiles, buses, power generators and hydrogen filling stations.

Companies such as IMPCO Technologies are developing on-board storage tanks for hydrogen that can be fueled to 5,000 to 10,000 psi. Hydrogen Burner Technology has introduced a skid-mounted system designed for on-site hydrogen generation that can be coupled with compression, storage, and delivery systems to provide high-purity hydrogen as part of a hydrogen refueling station. The company was recently awarded a contract with the California Air Resources Board to build a hydrogen fueling station to serve fuel cell buses built by EXCELLSiS and operated under the California Fuel Cell Partnership.

Although much R&D is under way and tremendous progress has been made, a number of hurdles remain. Improvements are needed in a number of areas, including cost, durability and reliability, operating and maintenance performance, hydrogen carrier or fuel of choice, and related infrastructure.

4.6.6.2 Technical Targets

The 50-kW fuel cell power plants being developed for passenger vehicles will be adequate for many truck applications. For larger trucks and buses, two or more 50-kW fuel cell power plants can be modularly integrated for higher power output. Therefore, it is useful to consider the technology targets already developed for the PNGV program as applicable for the heavy-duty market. Currently, the light- and

heavy-duty markets are focusing on PEMFC technology because of system efficiencies and low operating temperatures. However, SOFCs can operate at higher temperatures and are much more compatible with a broader range of hydrocarbon fuels, including diesel; therefore, they might be applicable in the heavy-duty markets.

The PNGV year 2004 goal for fuel cell system cost is \$50 per kW or \$2,500 for the entire 50-kW system. The system cost can be broken into several sub-systems: fuel cell (60%), fuel processor (29%), balance-of-plant (3%), and assembly and indirect (8%). There are also several PNGV performance targets, including power density, 300 W/l; specific power, 300 W/kg; durability, 5,000 hours; energy efficiency, 48% at 25% of peak power; transient response, 10 seconds from 10 to 90% power; and start-up to full power, 30 seconds.

While these costs and performance targets may be applicable to most heavy-duty applications, there may be truck markets and duty cycles that require significant adjustments to these targets. For example, the durability target for PNGV vehicles may not be adequate for the heavy-duty market where transit buses may be sold with a 500,000-mile, 12-year warranty. On the other hand, fleet trucks may not be as demanding as personal transportation vehicles in requirements for start-up to full power.

The PNGV program also has required that fuel processors for fuel cell systems be capable of processing a number of potential fuels. While reforming gasoline has been a principal focus for light-duty applications, the heavy-duty market is likely to be more interested in the reforming of diesel. Further, the on-board storage of hydrogen may be more conducive to fleet applications, where vehicles operate on fixed routes and return to a central facility that could include a hydrogen fueling station.

4.6.6.3 Barriers

PEMFC

Many of the technical barriers that have been identified by the PNGV program are consistent with the challenges facing the application of fuel cells in trucks and buses. These barriers for PEMFC technology can be roughly divided into five areas: efficiency, thermal air/water management, fuel processing/storage, durability, and cost.

The A. D. Little study (A. D. Little 2000) found that current PEMFC technology produced energy efficiencies of 34% at 25% of peak power, significantly below the PNGV target of 48% energy efficiency. More recent results from IFC's ambient-pressure PEM power plants tested by OEMs are more promising: 48% efficiency at 100% power and 60% efficiency at 20% power. Preliminary results from IFC's 50-kW power plant are more promising, with 48% efficiency at 100% power and 60% efficiency at 20% power. Current production diesel engines have peak efficiencies of 42% and could potentially advance to 50%. This presents an even greater challenge.

To improve overall energy efficiency, higher cell voltage is required. Fuel cell stacks currently operate at about 0.6 to 0.7 volts and must attain voltages of approximately 0.9 volts to meet PNGV's target of 40% energy efficiency at 25% of peak power. There is a trade-off, however, between increased efficiency and power density. In obtaining higher operating voltages to increase efficiency, the fuel cell must operate at lower power densities. Consequently, the stack size (i.e., system size) will have to be increased to meet vehicle power demands. One limitation on raising the cell voltage is the polarization losses at the cathode. If the operating voltage is to be raised to improve efficiency, oxygen augmentation should be examined. A host of balance-of-plant issues also must be resolved. For example, the use of off-the-shelf compressors results in significant parasitic power losses that reduce overall system performance.

Water management is a significant issue for PEMFC systems, which must be hydrated to optimal levels using closed-loop control systems and pure (deionized) water. Compact, lightweight, and efficient water condensation and recovery systems must be devised to provide deionized water. For military and other

remote vehicle applications, this source of pure water could be used for logistics purposes. Since the overall power requirement for truck and buses is not greatly different from that of cars, but much more volume is available; therefore, thermal and water management problems in truck and bus applications are greatly reduced.

The technical and practical challenges of using hydrogen in a fuel cell system have largely been successfully overcome. However, the storage of hydrogen aboard the vehicles is a continuing barrier, given the molecular structure of hydrogen. As previously mentioned, storage tanks are being developed to accommodate hydrogen at 5,000 to 10,000 psi. New approaches for metal hydride storage are also very promising.

One of the principal challenges of developing fuel processors for hydrocarbon fuels (gasoline and diesel) is reducing sulfur levels in the output hydrogen. Up to now, sulfur removal has not been made a priority; however, sulfur can adversely impact the operation of a fuel cell. While companies like IFC and Nuvera have been successful in removing sulfur from gasoline, there has been much less effort to reduce the sulfur levels of diesel fuel in an on-board fuel processor. Being able to use logistic fuels is critical for military applications. The capability to use readily available fuels within local theaters of operations is essential for the military.

Additional barriers associated with the use of fuel processors include reducing their size and weight, cutting start-up times, improving transient response, improving catalyst durability, and improving CO cleanup. CO, which can degrade the performance of the fuel cell stack, is produced during fuel processing. Researchers are now developing gas cleanup systems that can reduce CO to levels that can be tolerated by the fuel cell stack.

Urban buses and trucks may operate in very harsh environments that could pose daunting challenges to the durability of advanced fuel cell systems. The electrochemical reaction performed by fuel cells is initiated by catalysts on both the cathode and anode. These catalysts are likely to degrade over time, as will the high-temperature catalysts found in fuel processors. Designing catalyst loadings that can withstand repeated operation over extended periods of time is a continuing challenge for fuel cell developers. The heavy-duty market will be much more demanding on durability than will light-duty applications.

Significant progress has been made in reducing the costs of PEMFC systems and their subcomponents, but much more remains to be done to reduce costs from today's \$300/kW to the 2004 target of \$50/kW. The fuel cell stack itself is made of catalyst-coated, solid graphite plates surrounding a thin, membrane film. Companies such as 3M, DuPont, and W. L. Gore are working to develop effective membranes that can be mass-produced at a low cost (the PNGV cost target is \$10/kW). Most PEMFC stacks use expensive platinum as the catalyst, accounting for 20% of the total system cost. Reducing platinum loading is a key challenge in the commercialization of PEMFC technologies.

SOFC

Several challenges and barriers must be overcome for SOFCs to be used for stationary and transportation power applications. The main barriers for use of SOFCs relate to integration of improved design, materials, and fabrication processes to increase performance and lower fabrication and manufacturing costs. Alternative configurations for SOFCs, such as advanced planar designs, are required to achieve high-power generation and lower fabrication costs. The materials issues that must be addressed include the development of low-temperature mixed conducting electrodes, metallic interconnects with a conductive coating, and seal technology. The largest barrier to SOFC technology is cost, which needs to be addressed by developing new fuel cell designs and carrying out in-depth costing at production levels approaching those required for heavy vehicles.

SOFC technology requires a change of emphasis from large SOFC power generation to small generators that can be scaled to larger size. Reduction in cold-start-up times and the ability of the device to cycle thermally may also be barriers. Fuel processing and reforming of the more complex liquid fuels, and stability in fuel impurities, must be addressed. One promising area for overcoming fuel reforming problems involves internal reforming of fuels in SOFCs, which offers the promise of minimizing size, mass, and complexity. This possibility is particularly attractive for military applications that require high-performance systems with long mean time between failures.

R&D must be directed toward solving these issues specifically as they relate to lower fabrication costs and high performance. The issues are challenging and will require an integrated approach.

AFC

The technical barriers that need to be addressed for AFCs are Pt catalyst loading in the anode, CO₂ contamination of the liquid electrolyte, and increasing the power density.

4.6.6.4 Technical Approach

Three critical areas of research have been identified for the heavy-duty vehicle market. One area would focus on the advancement of PEMFC technologies that would build upon the PNGV and other automotive fuel cell efforts. The focus of this path would be the issues of power requirement, durability, cost, fuel of choice, operating and maintenance performance requirements as applied to heavy-duty vehicles, water recovery, on-board sulfur trap development, and oxygen augmentation. For example, where the PNGV program is primarily focused on the development of gasoline reformers for passenger vehicles, this path would direct more attention to the reforming of diesel and Fischer-Tropsch diesel fuels or other alternative fuels that are compatible with truck and bus requirements.

The second critical research area focuses on fuel reformation, on-board storage of H₂, and infrastructure. The heavy-duty market already has seen the use of CNG advance in the transit bus market. This experience with compressed gaseous fuels can easily be translated into the use of hydrogen gas. The transit industry's experience with gaseous refueling stations and the on-board storage of gaseous fuels has not been matched in the passenger vehicle market. For certain fleet applications, on-board storage of hydrogen may be a viable option. Efforts to improve the on-board storage of hydrogen for these fleet vehicles should be addressed.

A third research area is other fuel cell technologies that are more compatible with diesel fuel. Efforts focused on SOFC technologies need to address lowering the operating temperatures, increasing power densities, reducing start-up times, reducing the volume and weight of such systems as well as reducing costs, developing or exploiting new SOFC designs that address these issues, and investigating internal reforming. Efforts on AFC need to address the development of a regenerable CO₂ scrubber for air and reformed fuels, removing the Pt from the anode, increasing power densities, and reducing the weight and volume of such systems.

4.6.7 Auxiliary Power

4.6.7.1 Status of Technology

“Auxiliary power” is a crosscutting technology that addresses the efficient and practical management of both electrical and thermal requirements for all classes of trucks and buses in the 21st Century Truck Program. Auxiliary power requirements are derived from many vehicle functions, including hotel loads, engine and fuel heating, HVAC, lighting, auxiliary components (e.g., pumps, starter, compressors fans), computers, entertainment systems, and on-board appliances (refrigerator, microwave, coffee pot, hot pad), as well as work function loads such as trailer refrigeration and the operation of power lifts and pumps for bulk fluid transfer.

Truck auxiliary power requirements by truck class are shown in Table 4.21. The range of power needs for each truck class represents both current and future auxiliary power requirements.

Table 4.21. Truck auxiliary power requirements

Type of truck	Potential load	Power required (kW)
Small truck	HVAC, coolant pump, water pump, starter, oil pump, compartment fans, catalyst heater, valve control, direct injection, electric suspension, computer, communications, electric power steering, heated windshield, lights. Power site equipment (compressor, lights).	1–5 5
Medium truck	HVAC, lights, coolant pump, starter, oil pump, water pump, compartment fans, computer, communications, lights, heated windshield.	1–5
Transit bus	HVAC, lights, coolant pumps, air compressor, hydraulic pump/power steering, doors, multiplex system, fuel pumps, starters, oil pump, water pump, compartment fans, computer, farebox, communications.	30–40
Vocational	Base electrical loads, lights, HVAC, battery charging, communications, computer. Power for task at idle (i.e., mixer, pumps, lifts).	1–5 TBD
Tractor trailer	Base electrical loads, lights, battery charging, communications, computer.	1–5
	Hotel loads: lighting, simple HVAC, computer, appliances.	3–5
	Full truck electrification: all of the above, plus water and oil pumps, starter, cooling fans, transmission and hydraulic system, brake compressors, and fuel and air-handling systems. Trailer refrigeration, other external power.	5–15 Up to 30

Although all classes of trucks share similar auxiliary power functions, such as powering lights and HVAC, the total required power load can differ significantly based on truck size and function. In general, trucks that fall in the small-to-medium truck category require auxiliary power in the range of 1 to 5 kW because of limited thermal loads (i.e., smaller passenger compartments lead to reduced HVAC requirements), no hotel loads, and limited power requirement for work functions. On the other hand, transit buses require large amounts of power, up to 40 kW, to drive auxiliaries that meet HVAC, braking, and other functional needs. Class 8 trucks exhibit a range of power requirements from 3 to 30 kW, depending on truck drive cycle and the type of work function considered.

The overwhelming majority of trucks on the road today derive auxiliary power from belt- or gear-driven systems. These systems convert fuel energy to mechanical and electrical energy. Mechanical energy is used to operate mechanical-based auxiliaries (such as pumps and compressors); electrical energy is used for lights, ignition, fans, radio, and other electrical components. Although they are reliable, durable, and commercially cost-competitive, belt- and gear-driven systems inefficiently convert fuel energy to electrical or mechanical energy and tend to have constant outputs rather than supplying power on demand. Estimates of current average power requirements for truck and bus air-brake and air-conditioning compressors are shown as a function of duty cycle in Tables 4.22 and 4.23, respectively (SAE 1988). The alternator power requirements for selected accessories for day and night constant-load operation are shown in Table 4.24 (SAE 1988). As seen in Tables 4.22, 4.23, and 4.24, estimates of component power requirements vary considerably based on truck function.

Table 4.22. Air brake compressor power requirements

Type of operation	Type of engine	Compressor intake	Duty cycle (%)	Average power (kW)
Line-haul	Gas	NA	10	1.3
	Diesel	NA	10	1.5
Short-haul	Diesel	Turbocharged	5	2.3
	Gas	NA	20	1.5
	Diesel	NA	20	1.8
Local-haul	Diesel	Turbocharged	10	2.8
	Gas	NA	60	2.2
	Diesel	NA	60	3.0
	Diesel	Turbocharged	30	3.5

Table 4.23. Estimates of air-conditioning compressor power requirements

	Duty cycle (%)	Power (kW)
Line-haul tractor and trucks	50	2.2
Short-haul tractor and trucks	50	2.2
Local-haul tractors and trucks	50	2.2
Long-haul buses	50	11.2
Short-haul buses	80	17.9
Local-haul buses	80	17.9

Table 4.24. Alternator power requirements for day and night constant-load operation

Includes headlights, high-beam indicators, taillights, clearance lights, identification lights, marker lights, license plate lights, instrument lights, instruments, ignition, field current alternator, and heater defroster fan with air conditioner

	Power required (kW)
Daytime constant load operation	1.2
Nighttime constant load operation	1.8

Auxiliary power needs and requirements are also strongly influenced by power requirements of line-haul Class 8 trucks. An estimated 458,000 Class 8 trucks travel farther than 500 miles from their home base each day and are likely to be idling during overnight stopovers (Stodolsky, Gaines, and Vyas 2000). Assuming an average of six hours of idle time per day, this represents 566 million truck-hours of idle time per year. Engine idling allows the driver to heat or cool his cab/sleeper, as well as operate appliances and communications, computer, and entertainment equipment. Idling also keeps the fuel and engine warm during cold weather, thus avoiding problematic engine cold starts. Idling to generate auxiliary power has a significant impact on overall vehicle fuel efficiencies and emissions. For example, an estimated 838 million gallons of fuel is consumed and 9.6 million tons of CO₂ is emitted annually for line-haul trucks idling overnight to heat or cool the cab/sleeper, operate electrical accessories, and keep the fuel and engine warm in the winter (Stodolsky, Gaines, and Vyas 2000). U.S. government hours-of-service regulations that are pending could require Class 8 line-haul drivers to decrease the number of hours on the road per day and increase frequency and length of rest periods. If enacted, proposed regulations could increase the amount of time that drivers spend stationary in their trucks with the engine idling to provide cabin heating or cooling and to operate accessories.

One technology being developed to reduce engine idle of Class 8 trucks during rest periods and to meet future truck electrical power requirements is the auxiliary power unit (APU) (Stodolsky, Gaines, and Vyas 2000). Auxiliary power units for Class 8 tractor-trailers are available today that are capable of generating electrical and mechanical energy, independently of the truck engine operation. Existing APUs are usually small internal combustion engines, equipped with a generator and heat recovery system to provide electricity and heat. These APUs, which are typically externally mounted on the truck cab or sleeper, supply upwards of 6 kW of power, weigh between 300 and 350 lb (136 to 159 kg) and occupy approximately 8 cubic feet. Existing APU units can be utilized to heat and cool the truck cab or sleeper as well as keep the battery charged and the engine coolant warm. Commercially available APUs have the advantage of integrating with current truck components and are based on reliable and proven technologies. Market penetration of APUs has been limited due to high initial cost (\$500–\$1,000 per kilowatt) and potential loss of payload because of weight of the APU unit. High market penetration of auxiliary power units, to reduce Class 8 truck engine idle during rest periods would have a dramatic effect on fuel usage and emissions. It has been estimated that APUs could reduce auxiliary fuel usage and emission by upwards of 80% (Stodolsky, Gaines, and Vyas 2000).

Fuel cells are also being developed as APUs for cars and trucks. The primary advantage of fuel cells is the potential of high system efficiencies (up to 50%) in converting fuel energy to electrical energy, as well as reduced emissions, weight, and noise. DOT has initiated under its Advanced Vehicle Program a project effort with WestStart-CALSTART and a project team of freightliner and EXCELLSiS to develop a PEM fuel cell APU system for Class 8 trucks. A demonstrator unit that uses on-board hydrogen has been completed, and work is under way to develop this unit to operate on reformat.

Truck electrification involves removing the thermal and electrical loads from the truck engine by transitioning from today's belt- or gear-driven technology to an electrical "power on demand" system. Managing where and when power is needed can provide many benefits, such as fuel savings, emissions reductions, and productivity enhancements. In addition, the overall system derives a number of benefits from the ability to provide flow, pressure, or power where needed for an engine function and from continuous adjustment to different operating modes. For example, varying speed control of both the fan and water pump during some operating conditions can result in improved net fuel efficiency as well as noise reduction. Controlling an accessory independently of engine speed can reduce accessory drag during engine cranking to enhance cold weather starting, or starting an electric engine oil pump just prior to engine cranking can provide bearing lubrication. Truck electrification involves the use of a generator to provide electrical power to drive auxiliaries independently of engine speed. Auxiliaries that will become electrically driven include engine water and oil pumps, starter, radiator cooling fans, transmission and hydraulic system pilot and scavenge pumps, air-conditioning and brake system compressors, and fuel and air systems. The transition from belt- or gear-driven auxiliaries will occur with those emerging electrically driven auxiliary components that yield the most benefit, reliability, and durability at a commercially competitive cost.

Another option to reduce truck idling is truck-stop electrification. Truck-stop electrification would enable trucks to plug into electrical outlets at truck stops during rest periods. This would allow truckers to power electrically driven engine block heaters, fuel heaters, cab and sleeper heaters and air conditioners, marker lights, entertainment equipment, communication equipment, and appliances. Truck-stop electrification would require modifying both the truck and the truck stops. (Trucks would have to be modified to operate on electrical inputs.)

Currently, only a limited number of truck stops supply plug-in power for trucks, although pilot tests are planned to evaluate this concept.

4.6.7.2 Barriers

There are several barriers to the development of auxiliary power technologies that will efficiently meet current power needs, address anti-idling issues, and meet future truck and bus power requirements. The trucking industry operates on small profit margins. Fuel costs and payload weights are important factors that directly affect profitability in the industry. Although many existing technologies have been demonstrated, the technology development process must focus on technology options that ultimately can be commercially viable. This includes the development of cost-competitive, safe, reliable, and durable technologies. Existing technologies, such as a small combustion-engine APU, can play a significant role in reducing fuel usage and emissions only if they are utilized by the trucking industry. Technologies must be developed to reduce fuel utilization, minimize weight, and meet all current codes and regulations. Complete electrification of the truck will require the development of energy-efficient and cost-competitive technologies as the industry transitions from belt- or gear-driven technologies to electrically driven components. This same technology is also directly applicable to and will benefit many other markets that utilize the same basic engines, such as buses, construction equipment, marine equipment, and military equipment.

4.6.7.3 Technical Approach

The technical approach to addressing current auxiliary power requirements will include the following steps:

- Conduct system analysis to evaluate potential technologies that support the electrification of auxiliaries and reduce electrical requirements.
- Develop and evaluate low-cost and reduced-weight APU systems that will reduce idle time and that can be integrated with current truck infrastructure.
- Develop and demonstrate cost-effective technologies that will enable the electrification of auxiliaries by means of stationary power sources.
- Support development of industry standards for electrical system designs for heavy-duty vehicles to assist in establishing criteria such as uniform voltage levels.
- Assist in establishing industry standards for uniform connector and power level for electrical power connections at truck stops.

4.6.8 Thermal Management

4.6.8.1 Background and Status of Technology

Thermal management, a crosscutting technology focused on managing heat rejection, can have an important impact on fuel economy and emissions, as well as the reliability and safety of all classes of trucks.

Many thermal-management issues are common between present-day vehicles and the advanced concepts under consideration. For example, on most vehicles, and especially on large trucks, the size of radiators and coolers dictates that the front-end design contributes significantly to the drag coefficient, and thus to fuel economy. Exhaust gas recirculation (EGR), which is the most probable near-term strategy for reducing NO_x emissions, is expected to add a 20 to 50% heat load to heat-rejection systems. Unfortunately, many conventional cooling-system components such as radiators, oil coolers, and air-conditioner condensers, are already at or are approaching their maximum practical size and functional limits.

The trend toward hybrid and fuel-celled vehicles is expected to further increase the demand on coolant heat-rejection systems. In fuel-cell vehicles, the exhaust of the fuel cell contains water vapor that needs to be recovered to reduce the amount of water inventory that is carried. Minimizing the size of the heat

exchanger to accomplish this is a challenge. In diesel hybrids, there may be up to five separate cooling systems (for engine, batteries, motors, electronics, and charge air), and optimization of this design is a complex task. Many thermal management issues are also specifically associated with advanced concepts or with military applications. For military operations, any increases in radiator size will not only affect aerodynamics and parasitic energy losses, but also limit any decrease in cab size, a decrease that is desirable for space savings in airlift operations. All of these demands have created a need for new and innovative thermal management technologies that will require long-term R&D.

4.6.8.2 Technical Approach

Several research areas identified by industry and government researchers can provide both near-term and long-term solutions to many of the next management problems. The research areas are identified as follows:

- Intelligent thermal management systems
 - Thermal management related to use of higher electrical bus voltage
 - Variable speed pumps and fans
 - Variable shrouding
 - Integration of thermal management components into vehicle structure
- Advanced heat exchangers and heat-transfer fluids
 - Innovative, enhanced airside heat-rejection concepts
 - New materials, such as carbon foams, for cooling-system components
 - Nanofluid technologies for improving heat transfer properties of coolants and engine oils
 - Fundamental understanding of fouling mechanisms and mitigation
- Advanced thermal management concept development
 - Heat pipes
 - Cooling by controlled nucleate-boiling
 - Waste-heat recovery technologies (e.g., thermo-electric generators)
- Simulation-code development
 - Comprehensive CFD module for airflow and temperatures to include power train, underhood aerodynamics and airflow, lubricant cooling, vehicle-load predictions, cooling systems, and control systems
 - Experimental data base
- Sensors and control components development
 - Accurate, reliable, robust, and real time
 - NO_x, engine temperatures, pressures, coolant flow, airflow
 - Combination with computer control
- Thermal signature management
 - Masking technologies to mask overall signature
 - Masking technologies to mask specific cargoes
- Electronics cooling
 - Power electronics in hybrids and fuel cells
 - Cooling for communications and battlefield integration equipment
 - Auxiliary military equipment

4.6.9 Materials

Materials needs for heavy vehicles fall into four categories: propulsion materials, lightweight materials, power transmission materials, and functional materials. In each case, materials development includes identifying the most appropriate material for the application in terms of both performance and price and then developing the materials processing, characterization, rig and engine/vehicle testing, and cost-effective manufacturing technology. In most cases both improved performance and lower cost are

expected. Cost effectiveness can be ensured by using economic cost modeling to predict the cost of the component at every stage in the manufacturing process and then as a guide in development of the material and process.

4.6.9.1 Propulsion Materials

Diesel Engines

The development of advanced diesel engines imposes greater mechanical, thermal, and tribological demands on materials. Higher-efficiency engines will require higher peak and brake mean effective pressures, higher stresses on components, higher temperatures, greater precision, and lighter weight. Requirements include materials for advanced combustion-chamber components, cylinder heads, engine blocks, and EGR and exhaust systems.

Future regulatory reductions in allowable exhaust emissions will require improved catalysts, better PM traps, alternative aftertreatment technologies, better lubricant control, and improved fuel-injection systems. Associated materials requirements include highly durable catalyst materials, catalyst supports, and wash coats for NO_x reduction; durable materials for effective, regenerating particulate traps; improved materials for lubricant control to reduce PM emissions, and high-strength wear- and fatigue-resistant materials and precision manufacturing for high-pressure fuel-injection systems (OHVT 1998).

Engines that incorporate alternative fuels (such as natural gas) require materials that are chemically compatible with the fuels and the altered combustion chemistry and are durable in the presence of low-lubricity fuels. Materials requirements include stable, corrosion-resistant materials for glow plugs and durable components such as wear- and corrosion-resistant intake valves, valve seats, and valve guides. Safer storage of gaseous fuels for longer driving range will also require materials that reduce storage pressures and permit conformable tank fabrication (OHVT 1997).

Materials R&D for propulsion systems will include materials for fuel and air-handling systems, exhaust aftertreatment, valve-train components, structures and insulation, friction and wear reduction, and thermal management. Candidate materials include high-temperature alloys, intermetallic alloys, ceramic-metal composites (cermets), structural ceramics, bulk amorphous alloys, ceramic and metal-matrix composites, thermal-barrier coatings, and wear coatings (OHVT 1999a).

Hybrid Propulsion

The major materials needs for hybrid propulsion systems fall into two principal categories: energy storage and power electronics, including electric motors. Energy storage needs include batteries, ultra-capacitors, flywheels, and/or hydraulic-pneumatic-mechanical storage systems. Reducing the cost and increasing the energy storage capacity, life, and reliability are the most significant challenges common to both batteries and ultra-capacitors. Challenges for flywheels are reduced cost, reduced complexity, and improved containment safety. Power electronics needs include improved electric motors, capacitors, inductors, power modules, and packaging. Improved motors must overcome limitations related to capacitive coupling, high-performance electrical insulation and corona resistance, magnet costs and performance, eddy current losses, and structural performance. Materials for capacitors and inductors must be developed to provide improved performance, better durability, longer life and higher temperature capabilities. High-volume manufacturing must be developed for silicon carbide or eventually diamond-based power devices to reduce cost and increase quality, durability, inspectability, and temperature capability. Power module packaging must be improved, including the development of materials for more affordable, robust, and efficient power and voltage sensors, improved high-temperature solders, and more durable and manufacturable interconnects (OHVT 1999b).

Fuel Cells

Fuel cells will likely play multiple roles in reducing the emissions and increasing the fuel economy of trucks and buses—as the prime source of motive power in a hybrid propulsion system and as a source of auxiliary power. The power levels for the various applications will be significantly different, but the materials challenges, similar. They can be broken down as follows: PEMFCs, SOFCs, and reformers.

The highest priority of the materials challenges that must be met in the near term for PEM fuel cells is to develop affordable catalysts. Affordable catalysts must be developed that have high activity at low loading levels and are durable and tolerant of both sulfur and CO. Other materials barriers that must be overcome include development of lower cost membranes that can operate at higher temperatures more efficiently; more durable and affordable bipolar plates that are lighter weight and higher strength; and improved packaging with better seals, clamping, and electrical connections.

A wide range of materials challenges will need to be met to realize the very high potential efficiencies of SOFCs. Anodes that are sulfur tolerant and that provide integral reforming must be developed, as must durable, mixed ionic conductive cathodes and fabrication methods to produce affordable, pore-free thin-film, solid electrolytes. All of the electrode and electrolyte materials must be made to operate efficiently at lower temperatures. Materials and fabrication methods for SOFC assembly and packaging must be developed to provide corrosion-resistant interconnects for bipolar plates as well as their high-strength, conductive oxide coatings. Insulating seals that are compatible with all components and gas streams as well as being durable over wide temperature ranges will be required, along with high-temperature bus bars and gas connections. High-temperature metallic housings will also need to be developed.

One of the greatest materials challenges to make PEMFCs and SOFCs commercially viable is to provide adequate reforming of the fuel on which they run. Different types of fuel cells and fuels require different amounts of reforming. PEMFCs that use diesel fuels require the greatest amount of reforming, SOFCs on gaseous fuels, such as natural gas, require the least. Nonetheless, a combination of barriers will need to be overcome for all systems to provide adequate materials for reformer components. Sulfur-tolerant, selective catalysts are needed in steam reformers, autothermal reactors, and CO scrubbers, as are durable, low-thermal-mass supports. Durable, corrosion-resistant materials with high surface areas and high thermal conductivity are needed to manage heat transfer in preheaters and radiators.

4.6.9.2 Lightweight Materials

The use of alternative, lightweight materials will reduce weight significantly and thus will yield substantial benefits in fuel efficiency and emissions reduction by both reducing the inertial loading and increasing the available payload of the vehicles. Lightweight materials must be developed that are cost-effective, stronger, more reliable, and safer. Affordable, efficient manufacturing processes to make the materials available to the ground transportation market must also be developed (Sklad 2000).

The principal barriers to overcome in reducing the weight of trucks and buses include the following:

- the inherently higher cost of alternative materials;
- the lack of understanding of medium- to high-volume manufacturing methods as applied to new materials;
- insufficient experience in joining and fastening;
- the lead time to bring new materials and processes into the manufacturing cycle;
- the lack of appropriate data bases and design tools for use by design engineers, particularly for composite structures;
- the lack of experience in repairability and maintenance; and
- a limited supplier base.

Lightweight materials R&D in the 21st Century Truck Program will focus on developing technologies that are aimed at addressing these barriers for lightweight materials to permit their accelerated development and introduction into the trucking industry. Materials development focused on weight reduction for trucks and buses will address three key elements:

- development of technologies for enhanced manufacturability of lightweight components for trucks and buses;
- development of design concepts and material data bases to provide design engineers the flexibility to consider lightweight materials in vehicle design; and
- development of technology in support of advanced materials, joining, maintenance, and repair.

The greatest weight reductions are foreseen through the use of high-strength steel, aluminum alloys, and polymer matrix composites in frames and bodies and, in lesser quantities, in wheels, cabs, transmission housing and shafts, and suspension components. Ultra large, thin-wall aluminum and steel castings will reduce part count and thereby weight. Other weight reduction opportunities include stainless steel in frames, reinforced aluminum blocks in light-duty engines; sandwich, cored, and foam materials for body panels; and metal matrix composites, titanium, and magnesium alloys for specialized components.

4.6.9.3 Power Transmission Materials

Up to 40% of the power generated by the engine is lost due to parasitic losses. When these are reduced, a corresponding increase is required in the performance of the braking system. Hence, improvements in power transmission materials—tires, drivetrain components, and brakes—are required for reduction in emissions and improvements in both vehicle efficiency and safety.

Several factors must be addressed to improve tire safety: tire reinforcement material strength and stiffness, temperature stability and damage tolerance, dynamic alignment materials and sensors that detect heat, pressure, and imbalance. Advanced materials will enable higher performance and longer-lived traditional drive trains. Development of improved understanding and modeling of friction and wear interactions and failure mechanisms will enable incorporation of the improved materials and surface treatments that are needed for more efficient, longer-life clutches, gears, bearings, and solid lubricants. Advanced braking systems will need improved thermal management materials and braking surfaces that are more heat tolerant, wear resistant, and corrosion resistant, and lighter weight. Improved lubricant control and imbedded sensors will be needed as well (Blau 1999, OHVT 1999c).

4.6.9.4 Functional Materials

Advanced sensors to improve engine and emission controls and safety devices, improved thermal management devices, and enhanced corrosion control are needed to meet the goals of the program. These applications all depend on development of durable, low-cost functional materials. R&D will be required to develop improved functional materials and low-cost manufacturing.

Improved smart materials, such as piezoelectric, electrostrictive, and magnetostrictive materials; high-temperature shape memory alloys; and active electro-optical glazing materials are needed as sensors and actuators for fuel-injection, valve actuation, intelligent braking, traction control, drag reduction, and HVAC load-reduction systems. Improved heat management materials will

- enable smaller, more efficient radiators, significantly reducing aerodynamic drag;
- enhance engine efficiency with improved recuperators in the air-handling and exhaust systems;
- improve durability and performance of electronic components essential for hybrid propulsion and regenerative braking systems; and
- provide super insulation needed for exhaust, HVAC, fuel cell, and reforming systems.

Reducing vehicle corrosion with improved modeling, sensors, and coatings will reduce required corrosion allowances and thereby reduce vehicle weight and maintenance costs.

4.6.10 More-Efficient and/or Lower-Emission Engine Systems

4.6.10.1 Introduction

Many people believe that the efficiency potential of the practical diesel engine has now been reached. This opinion, although wrong, influences debate. The following paragraphs argue first that the potential of the current reciprocating combustion engine for further efficiency improvement is seriously underestimated and then highlights the engine design areas that can be modified to approach the much higher ultimate potential of the reciprocating internal combustion engine. The discussion intentionally centers on technology stretch concepts. Emission reduction methods are then outlined in the areas of pretreatment, aftertreatment, and in-cylinder methods.

4.6.10.2 Current Efficiency—Practical and “Theoretical”

Diesel engines achieve on-the-road efficiency up to about 44%, which, although the highest among vehicle engines, has room for much improvement. The engines typically use a compression ratio of about 16. The classic ideal cycle formula for the efficiency of a diesel cycle with this compression ratio yields an “efficiency upper limit,” assuming perfect processes, of 60% even for lean (0.4 equivalence ratio) operation. Indeed, if the actual engine remains in its present form, its efficiency is not likely to exceed about 50% through a continuing process of refinement. Even if such refinement is achieved, it is unlikely to overcome the burden of additional constraints imposed by emission reduction measures. So, even to retain current efficiency levels, a review is needed of the opportunities for basic engine cycle improvement.

Better Use of Available Pressure Ratio

Current diesel engine performance is limited structurally to a maximum cylinder pressure of about 20 MPa. Ambient pressure is 0.1 MPa, so the available overall pressure ratio is 200. To take advantage of this available energy, a piston engine would need to have a volume expansion ratio of about 44, and would have a corresponding ideal efficiency of 78%. This is a 30% increase in ideal cycle efficiency. For various reasons this volume ratio cannot be achieved in practice in a single cylinder. However, by combining turbo compression and expansion (turbocharging) with in-cylinder compression and expansion, this ideal process can be approached today in experimental turbocompound engines. Using cylinders in series to provide the compression and/or expansion in more than one stage is also an option. Indeed several potentially efficient but untested designs, such as those of Assanis, Karvounis and Bell 1993 and Clarke and Berlinger 1999, feature gas exchange between cylinders.

Thermal Recycling

The engine thermodynamic cycles mentioned above do not use regenerative heat exchange. This is a new opportunity for reciprocating engines. Very significant additional gains are obtained in principle by thermal regeneration, as outlined by Clarke 1990 and Ferrenberg 1990. (This principle is already applied in recuperative gas turbines, where it lowers the compression pressure requirement and helps part load operation, but has only a second-order effect on efficiency because it does not overcome the fundamental turbine temperature limitation.) Extensive one-dimensional transient analysis by Ferrenberg et al. 1993 of in-cylinder regeneration has shown that temperature ratios across the regenerator can be as high as 1.6. With the same overall pressure limit and equivalence ratio, this raises the ideal cycle efficiency to 86%. This is a 43% improvement in ideal cycle performance. This improvement is due to increased combustion temperature and less net heat rejection. The heating in the regenerator is done without compression and this allows much higher temperature within the pressure limit. In other words, the pressure limit, a principal reciprocating engine efficiency constraint, becomes less restrictive. Finally, this very efficient

cycle still has hot exhaust and does not employ intercooling. An approach to extract all the available work from the exhaust is to use isothermal compression followed by a recuperation of exhaust heat. The cycle then has an ideal thermal efficiency of 89%. This is a 48% improvement in ideal cycle performance. (See Fig. 4.16.)

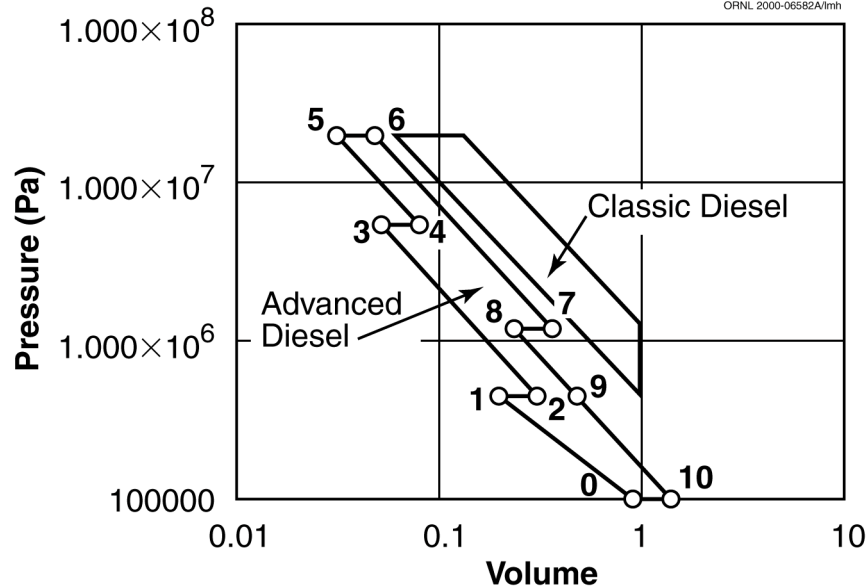

Fig. 4.16. Classic and advanced diesel ideal cycles compared.

This cycle satisfies the following “acceptable” thermal and mechanical properties:

- maximum cylinder pressure = 20 MPa,
- maximum regenerator temperature = 1500 K,
- maximum recuperator temperature = 462 K,
- maximum recuperator pressure difference = 0.36 MPa,
- boost pressure ratio = 4.6, and
- cylinder exhaust temperature = 711 K.

4.6.10.3 Practical Implementation

The advanced cycle applies the well established rules for increasing heat engine efficiency, namely, minimize internal irreversibilities, maximize heat-input temperature and minimize heat-rejection temperature. In practical terms it requires the following:

- Avoiding blow-down energy losses by compounding using either turbines or reciprocating units to achieve the necessary efficient extra expansion. (The technology of applying motor/generator units directly on turbomachine shafts is likely to help meet this need; see for instance Hofbauer 2000.) If turbocompounding is adopted as the best practical means to improve the overall expansion efficiency, then the use of high-speed electric motor/generators becomes a mechanically simple way to extract useful energy from the expansion. This approach has synergy with vehicles that have electrically driven auxiliary systems (see Sect. 4.6.7) and the need to add power to the compressor shaft (hence increase airflow) during transients. It also provides an option to optimize the share of power output between the crankshaft and the turboshaft.

- Adjusting compression ratio and scheduling fuel injection so that the combustion approaches constant pressure at the cylinder pressure limit (the technology of electronically scheduled fuel rates and the use of lean mixtures will help to meet this need).
- Applying efficient turbomachinery to improve mechanical efficiency by raising BMEP and to more nearly approach isentropic performance for the whole pressure ratio (modern CFD designs can help meet this need).
- Applying regenerative heat exchange as part of the cylinder processes (this is a novel feature of the compression ignition cycle and it is made possible only by the properties of newly developed porous foams of high melting point metals or ceramics (e.g., chemical vapor deposited silicon carbide as described by Sherman, Tuffias, and Kaplan 1991).
- Using intercooling to approach isothermal compression thus recovering exhaust energy and reducing the work required for the first stage of compression (there is technology from multi-stage intercooling of stationary engines and/or liquid vaporization during compression).
- Avoiding heat losses as much as practical by using low surface-to-volume ratios and allowing non-lubricated surfaces to approach their adiabatic temperature (there is technology from the low heat rejection programs of recent years).

There has never been a concerted effort to exploit all the above features, although they can all add to engine efficiency.

The extensive DOE-funded program for improved in-cylinder components and reduced heat rejection optimized the design by means of simulations restricted to relatively small changes from current engines. Even so, single cylinder tests (with simulated turbomachinery) exceeded 50% thermal efficiency, and 49% was achieved by the multi-cylinder version of this turbo-compound engine.

4.6.10.4 Exemplary Developments

Two near-term benefits are likely to come from the relatively conventional approaches that do not employ heat exchange to enhance the cycle: (1) going for an optimum combination of high pressure and controlled pressure (near constant pressure) combustion by using an optimized (ramp up) fuel-injection/combustion rate and (2) improving the compression and expansion efficiencies.

The longer term results stem from the opportunity to incorporate more thermal recycling (e.g., in-cylinder regeneration) or chemical recycling (e.g., endothermic fuel reforming).

Although not intended to be all-inclusive, the following four research areas illustrate some important emerging directions.

Homogeneous Charge Compression Ignition

Homogeneous charge compression ignition (HCCI) is an alternative engine combustion process that can provide high, diesel-like efficiencies, very low NO_x emissions, and very low particulate emissions.

In addition, HCCI could offer dividends in terms of reduced cost (less expensive fuel-injection equipment than a diesel) and fuel flexibility.

HCCI engines operate on the principle of having a dilute, premixed charge that reacts and burns volumetrically as it is compressed by the piston. The charge may be made dilute by being very lean, by mixing with EGR, or a combination of the two. Because the charge is very dilute, combustion temperatures are low, and little NO_x is produced. Particulate emissions are also very low because the premixed charge is lean, or at most, stoichiometric. The foremost barrier to HCCI is in controlling the ignition timing, heat-release rate, and amount of unburned hydrocarbons across the load-speed map of the engine. For a given fuel, the HCCI combustion process is controlled by three main parameters: time,

temperature, and mixture. Partial stratification of the charge temperature, charge mixture, or both has a strong potential to alter these parameters to control ignition timing and heat-release rate, and its potential has been largely unexplored. Controlled charge stratification also has the potential of increasing the power density to a level comparable with that of a diesel engine, whereas traditional fully homogeneous-charge HCCI engines have typically had lower power densities. Accordingly, investigation of the effects of partial charge stratification (stratified charge compression ignition, SCCI) should be included in the R&D efforts. Additionally, hybrid power train configurations that accommodate a limited engine operating range may assist HCCI application.

Experimental efforts will include additional mapping of the operating space and fuel-type effects, the investigation of potential control strategies, comparisons of engine performance with detailed kinetic-rate calculations. (t will also include detailed in-cylinder measurements using advanced laser diagnostics to determine such things as the nature of HCCI/SCCI combustion, the source of unburned hydrocarbon emissions (e.g., wall quench and crevices), the effects of fuel/air/residual mixture and partial stratification of this mixture, and the effect of charge-temperature stratification.

Numerical modeling efforts will include advancements in chemical-kinetics modeling (e.g., reduced mechanism for application in CFD codes), surrogate blends to simulate real fuels, efforts to develop and apply detailed CFD codes to HCCI processes, and algorithms for control strategies.

Free Piston Engine Configurations

Goldsborough and Van Blarigan 1999 and Goertz and Peng 2000 have simulated free piston engines that couple a reciprocating piston directly to a linear generator. (See Appendix H, Fig. H.1.) Such devices contain no crankshaft or camshaft. Freed from some of the kinematic and bearing load constraints of the slider-crank mechanism, they appear well suited for application to the HCCI combustion process. They are also well suited because they have more operating degrees of freedom, which may be vital for control of practical HCCI combustion. This design offers the attractive possibility that the mechanical simplicity will lead to cost-effective, efficient, clean, and more nearly direct conversion of combustion energy to electric power. Achten 1996 has built and tested a free piston engine in which the diesel 2-stroke working chamber is directly attached to a hydraulic pump. (See Appendix H, Fig. H.2.) This is also suitable for HCCI operation for the same reasons as described in the previous section. Applications would obviously focus on vehicles for which hydraulic transmissions are appropriate. It is not yet clear whether the transmission and energy storage required for hybrid vehicles should be based on electric or hydraulic technologies. Either way, the free piston engine with HCCI may be an attractive prime mover.

In-Cylinder Regeneration

Ferrenberg has simulated the thermodynamic performance of cylinders in which the working gas picks up heat prior to combustion by passing through a thin disc of porous material (Farrenberg 1990, Ferrenberg et al. 1993). (See Appendix H, Fig. H.3.) The disc is reheated when the expanded gas passes through it prior to exhaust. Simulated efficiency of such an engine is up to 58%. The reasons for this high efficiency are discussed in an earlier section.

Chemical Recovery of Exhaust Heat

When the fuel is preprocessed by an endothermic reaction with exhaust heat, the heating value of the fuel is increased and thermal efficiency can potentially be improved. Experiments with an exhaust-driven methanol dissociation system were conducted some time ago (Karpuk 1989), but the control of the overall process was very complex and hydrogen in the fuel gave rise to pre-ignition. Recently, Kawamura and Ishida 2000 reported on a concept to achieve a system thermal efficiency of 68% by using this technique among others for natural gas. They used ceramic insulation to increase the exhaust heating potential and

then drive a reaction that changes a mixture of methane and carbon dioxide into carbon monoxide and hydrogen. The products add about 30% more heating value to the original fuel.

4.6.10.5 Lower Emissions

Emission Reduction Through Pretreatment

Historically, fuel preparation has been very important to the fuel and engine symbiotic relationship, from raising octane to cutting lead in gasoline to lowering ash and sulfur in diesel fuel. Our current focus on liquid hydrocarbons for transport stems primarily from economy and convenience rather than the “ideal” nature of the fuels. It has been shown repeatedly, and recently by Nurun et al. 1999, that increased oxygen content (such as in alcohol or dimethyl ether) greatly improves the ability to avoid soot in compression ignition engines. With less in-cylinder soot production, the options for both aftertreatment and in-cylinder control of NO_x and PM are greatly increased. If biomass, which contains sufficient oxygen to reduce soot production emerges as a major long-term energy source (NREL 2000) and acidic or enzymatic hydrolysis can reduce cellulosic material economically, prospects for clean and efficient engines are much improved. Similarly, if natural gas emerges as a major long-term energy source, perhaps even from hydrates (Gornitz and Fung 1994), and economic conversion into oxygen rich liquid fuel is possible, then prospects for clean and efficient mobile engines are much improved. Exhaust gas recirculation reduces oxygen (gas) to fuel ratio and serves to greatly reduce NO_x production. Other ways to pretreat the air are also worth exploring. Fuel desulfurisation is aimed primarily at helping aftertreatment processes. But by reducing exhaust acidity, it also helps prospects for practical recovery of exhaust heat in heat exchangers.

Lower Emissions Through Current In-Cylinder Processes

Current measures reducing NO_x and soot include recirculation of cooled exhaust gas, and the use of high-pressure, electronically controlled fuel injection. Numerous unconventional fuel-injection systems such as air-blast atomizers, two-fluid injection, electric field enhancement, and piezoelectric atomization, have been attempted. These measures are at best neutral, but often negative on efficiency, and typically negative on cost, complexity and bulk. It is thought that these measures by themselves may not be sufficient for meeting projected emissions regulations. So either there needs to be an even more effective aftertreatment technology, or the problem must be handled at the source by a different mode of combustion, such as follows here. (See also Sect. 4.6.2.)

Lower NO_x and Particulates Through Homogeneous Charge Compression Ignition (HCCI)

It has become clear that it is the flame front that forms the NO_x as it propagates the combustion reaction. However, at sufficiently low fuel concentration there is insufficient energy to propagate a flame. So, using conventional combustion, there is a minimum to both flame temperature and associated NO_x as discussed by Flynn (Flynn et al. 2000). HCCI appears to be an attractive alternative worthy of consideration to meet the diesel emissions challenge (see also Sect. 4.6.10.4). Because of this, industry has a significant interest in developing a practical engine of this type. Both diesel-engine and automobile manufacturers have established, or are establishing, HCCI/SCCI engine development efforts. Further HCCI/SCCI development efforts are required, and to support these industrial engine development efforts, additional research is required on the fundamentals of HCCI/SCCI combustion and the advancement of HCCI/SCCI simulation models. Several researchers have shown NO_x below 10 ppm and zero smoke. Some production 2-stroke engines (see for example, Ishibashi and Asai 1996), use this combustion mode to improve light load performance. Research continues in this area and this may become the preferred combustion mode for efficient, clean, reciprocating engines. The potential of various HCCI concepts and approaches needs to be fully explored.

4.6.11 Vehicle Intelligence

4.6.11.1 Technical Approach Overall Plan

The vehicle intelligence activities will be advanced primarily through research but will also include program assessment and activities that may support the development of standards. To achieve the program objectives, vehicle intelligence R&D is focused in four areas: identification and definition of problem areas (services), selection of services for development, system design and development, and operational test and evaluation. This process will be carried out in each problem area. The work in each problem area is focused on solving specific problems. To have a cohesive process, each research area is tied to the vehicle intelligence crosscutting activities. The end result is envisioned to be market driven, deployable products that enhance roadway safety, overall mobility, and system efficiency.

Figure 4.17 illustrates the process for conducting research. This process was borrowed from the Intelligent Vehicle Initiative (IVI) (DOT 1997, DOT 2000). The progression of activities generally moves from left to right on the diagram. The level of cooperative involvement with the motor vehicle industry increases from left to right. At the current time, the majority of the work within the IVI program is in, and to the right of, the middle column. This represents a significant U.S. DOT effort to develop an understanding of the details of system performance that describe effective safety-enhancing systems. A more precise description of status for each problem area is provided in the next section. The status of various problem areas is also a function of the state of production-readiness of commercially available systems.

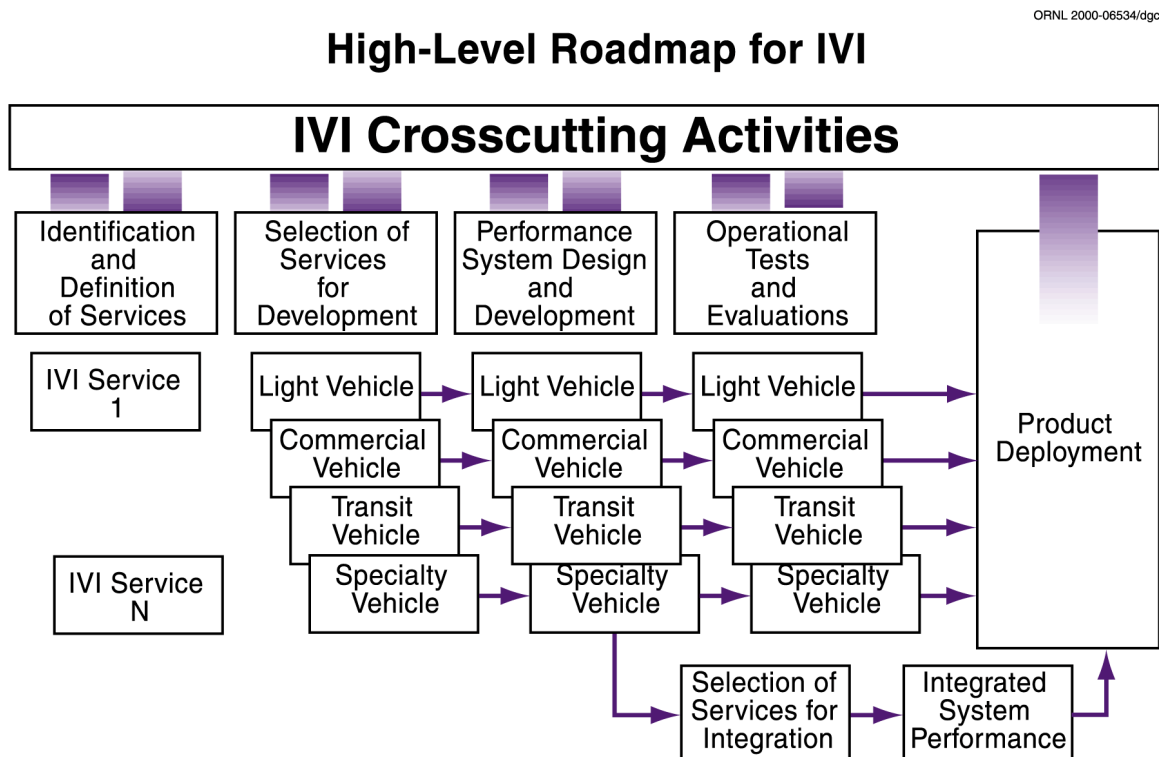

Fig. 4.17. Process for conducting vehicle research as borrowed from the Intelligent Vehicle Initiative (IVI).

The state of production readiness is generally described by the generation of the system in question. Generation 0 systems are expected to be ready for production planning by 2003, Generation 1 systems are expected to be ready for production planning by 2010, and Generation 2 systems are expected to be ready for production planning by 2015. For the purposes of the 21st Century Truck Program, only Generations 0 and 1 are included. The majority of the DOT-initiated work has focused on problem areas for which Generation 1 systems appear to be the most realistic solution. However, in some cases, for example crashes at intersections, Generation 2 systems may be the most realistic expectation for effective countermeasures. The planning of the program in each problem area began with a thorough analysis of crash data files. This work took place in the early 1990s and is reflected in the left column in Fig. 4.16. Subsequently, decisions were made on which problem areas should be emphasized in the U.S. DOT work.

This corresponds to the second column from the left in Fig. 4.16. The Generation concept illustrates the iterative nature of the IVI R&D process. If we use the rear-end collision problem area as an example, testing of a commercially available system for commercial vehicles is being conducted under Generation 0. Under Generation 1, performance specifications are being developed, and testing will be conducted of a more advanced system for light vehicles.

The problem areas that were selected are discussed in more detail later in this section. The work in some of these problem areas has progressed to the point that it is feasible to design and fabricate prototype systems that would be available for use in operational tests, most notably, rear-end crashes. As work progresses in other problem areas, additional operational tests of Generation 1 systems will be initiated. Deployment of effective intelligent vehicle systems is the domain of the motor vehicle industry, so the right column on Fig. 4.16 reflects design and production by vehicle manufacturers and suppliers. The concept of Generation 0 systems is a relatively new concept in the IVI program. The idea behind this concept is that safety-related systems nearing production could benefit from an evaluation based on results of an operational test. A Request for Application, published in December 1998, has resulted in operational tests of such systems. These projects enter the IV Program at the operational test level. Two other aspects of the program are significant. The crosscutting block on Fig. 4.17 represents those activities that cut across platforms (e.g., the development of general-purpose research tools and the assessment of institutional issues). Another perspective of consolidating activities is reflected in the integration box at the bottom of Fig. 4.17. Both of these activities are incorporated in the problem area lines of the GANT chart shown in Fig. 4.18. These activities are associated with combinations of two or more proven systems, usually within a single platform. A key question that comes up is whether the combination system, and especially the driver-vehicle interface for the combination, is more or less effective than the individual systems. Within this same box are studies of the impact on safety of combinations of systems that, by themselves, have little or no impact on safety.

Figure 4.18 illustrates the R&D plan that was specifically developed for the 21st Century Truck Program. Activities that are or will be funded by the IVI program are illustrated in black. Activities that are not funded are illustrated in red. This R&D plan stretches the IVI program goals, which are primarily safety focused, to cover mobility, efficiency, and productivity goals as well.

4.6.11.2 Program Objectives

- Accelerate product introduction of driving information, driver assistance, and control systems that will improve significantly the safety of motor vehicle operations.
- Develop and validate performance specifications and design guidelines for IVI systems that will be deployed in motor vehicles in the next 10 years.
- Recognizing the complexity of the driving task and issues such as risk compensation and workload, demonstrate systems and evaluate their impact on driving safety.
- Reach agreement on the basic functional requirements for driver-assistance features and target those functionalities for which industry investment has developed the basis for working prototypes.

	Pre 2001	2001	2002	2003	2004	2005	2006	2007	2008	2009	2010
Generation 0											
Research											
Transit Rear-end Collision Warning											
Transit Rear-impacting Collision Warning											
Transit Lane Change Collision Warning											
Operational Tests											
Mack											
Freightliner											
Volvo											
MN DOT											
Generation 1											
Research											
Driver Condition Monitoring											
Vehicle Stability/Rollover Warning Control											
Human Factors											
Benefits											
Safety Event Recorders											
Driving Baseline Data Collection											
Prognostics/Diagnostics											
Collision Warning Systems											
Rear-end											
Lane Change/Merge											
Road Departure											
Intersections											
Rollover											
Vision Enhancement											
Road Condition Monitoring											
Enhanced Digital Maps											
Transit Precision Docking											
Transit Automated Control											
Operational Tests											
System Integration Test											

Fig. 4.18. Vehicle intelligence R&D plan for the 21st Century Truck Program.

- Recognizing the need for balance between public benefit and private incentive, ensure that reasonably achievable safety benefits are identified.
- Identify refined, more-detailed estimates of benefits to assess which cooperative infrastructure deployment investments can be justified and to stimulate new safety products.
- Identify and conduct the R&D required to achieve increased levels of system capability and fuel efficiency on a ton-mile per gallon basis.

4.6.11.3 Safety-Related Problem Areas

The following problem areas are prime candidates for improvement through application of advanced in-vehicle or cooperative technology. The R&D plan (Fig. 4.18) is annotated to show which services are currently the subject of DOT-funded research under IVI.

Rear-End Collision Avoidance

This feature would sense the presence and speed of vehicles and objects in front of the equipped vehicle and would provide warnings and limited control of the vehicle speed (coasting, downshifting, or braking) to minimize risk of collisions with vehicles and objects in the vehicle's lane of travel. It is expected that the first implementation of this service would be through autonomous in-vehicle systems. These systems would monitor the motion and location of vehicles and other objects in front of the vehicle and would advise the driver, through an appropriate driver-vehicle interface, of imminent rear-end crashes. These systems may share some elements of adoptive cruise control systems and are expected to complement their performance. Adaptive cruise control systems are expected to precede collision avoidance systems as a commercial product. Later versions of these systems may include automatic braking in the event of an impending crash. The performance of these systems may be enhanced through future combination with other systems, such as other collision avoidance systems, route guidance-navigation systems with enhanced map data bases, and cooperative communication with the highway infrastructure to set adaptive cruise control systems at safe speeds.

Road Departure Collision Avoidance

This feature would provide warning and control assistance to the driver through lane or road edge tracking and by determining the safe speed for road geometry in front of the vehicle. It is expected that the first implementation of this service would be through autonomous in-vehicle systems. These systems would monitor the lane position, motion relative to the road edge, and vehicle speed relative to road geometry and road conditions and would advise the driver, through an appropriate driver-vehicle interface, of imminent unintentional road departure. Later versions of these systems may include cooperative communication with the highway infrastructure to automatically provide safe speeds for upcoming road geometry and conditions. The performance of these systems may be enhanced through future combination with other systems, such as other collision avoidance systems, drowsy driver advisory systems, and route guidance-navigation systems with enhanced map data bases.

Lane Change and Merge Collision Avoidance

It is expected that the first implementation of this service would be through in-vehicle systems that may be augmented with vehicle-to-vehicle communications. These systems would monitor the lane position, relative speed, and position of vehicles (including motorcycles) beside and to the rear of the vehicle and would advise the driver during the decision-phase of a lane-change maneuver, through an appropriate driver-vehicle interface, of the potential for a collision. Later versions of these systems may provide additional advice of an imminent crash to the driver during the action-phase of the lane change or entry-exit maneuver. The performance of these systems may be enhanced through future combination with other systems, such as other collision avoidance systems and roadside communication and sensing systems.

Intersection Collision Avoidance

The first implementation of this service is expected to be through in-vehicle systems that are augmented by information from enhanced map data bases or from cooperative communication with the highway infrastructure. These systems would monitor position relative to intersection geometry and relative speed and position of other vehicles in the vicinity of the intersection, and would advise the driver through an appropriate driver-vehicle interface of appropriate action to avoid a violation of right-of-way or to avoid

an impending collision. Complexities of providing this service include the need to sense the position and motion of vehicles and to determine the intent of these vehicles to turn, slow down, stop, or violate right-of-way. A fully autonomous in-vehicle system would probably not be capable of providing this service.

Vision Enhancement

The first implementation of this service is expected to be through autonomous in-vehicle systems. These systems would use infrared radiation from pedestrians and roadside features to provide the driver with an enhanced view of the road ahead. Later versions of these systems may include additional information from improvements in the highway infrastructure, such as infrared reflective lane edge markings.

Automatic Collision Notification

The first implementation of this service is expected to be through in-vehicle systems that are augmented by communication links to Public Safety Answering Points (PSAPs). These systems would monitor position of the vehicle and severity of the crash. This information would be transmitted automatically to the appropriate PSAP for the location of the crash. These systems may also be combined with manually activated systems for requesting roadside assistance. The research in this area is sufficiently mature such that no additional work is needed to ensure that this capability is available for the 21st Century Truck.

Vehicle Stability Warning and Assistance

An early version of this service would assist drivers in maintaining safe speeds on curves by measuring the rollover stability properties of a typical heavy vehicle as it is operated on the roadway and by providing the driver with a graphical depiction of the vehicle's loading condition relative to its rollover propensity. More advanced services would employ an active brake control system coupled with electronic brake system technology and infrastructure-provided information to selectively apply brakes to stabilize the vehicle and thus reduce the incidence of rear trailer rollover in double- and triple-trailer combination vehicles during crash avoidance or other emergency steering maneuvers.

Driver Condition Warning

This service would provide a driver monitoring and warning capability to alert the driver to problems, such as drowsiness or other types of impairments. The first implementation of this service is expected to be on commercial and transit vehicles.

Vehicle Diagnostics

The vehicle diagnostic information service would be an extension of current vehicle monitoring and self-diagnostic capabilities such as oil pressure and coolant temperature gauges. This service would monitor the vehicle's safety-related functions. Examples of conditions to be monitored include braking system integrity, tire pressure, sensor and actuator performance, and the communication system. This information is intended to be useful to the driver, as well as to assist and support fleet maintenance and management functions.

Safety Event Recorder

This feature would record selected driver and vehicle parameters to support the reconstruction of conditions leading to a critical safety event. Data from this recorder could provide input to the crash notification subsystem for transmission of collision data to the emergency service provider.

Road Condition Warning

This service would initially warn the driver of reduced traction, but in advanced configuration, would also provide control assist capabilities to assist the driver in regaining control of the vehicle. Sensors on-board the vehicle would detect when the tire-to-road surface coefficient of friction is reduced due to water, ice, or road surface condition.

Fleet Management and Automated Transactions

This feature would make use of such technology as transponders and “smart cards” to implement productivity-enhancing capabilities for electronic transactions (e.g., electronic toll collection, parking fee payment, and transit fare payment) and additional commercial vehicle-related functions (e.g., credentials and permit verification).

4.6.11.4 Fuel-Efficiency-Related Problem Areas

Significant technological achievements have been experienced over the past decade in the area of communications, electronics, and tracking technologies. Commonly referred to as “Telematics,” such technologies have been widely applied to highway and automotive safety. Such technologies also hold great promise for enhancing the productivity and efficiency of our nations automotive and trucking industries.

Through the innovative use of such technologies, trucking carriers can more effectively manage the whereabouts of vehicles in their fleet, providing more timely service and saving fuel in the process. Merging vehicle-location technologies with software for logistics will allow more timely delivery of goods with reduced fuel consumption.

Automotive e-business technologies are beginning to demonstrate how drivers can more effectively utilize their in-vehicle time. Such technologies, if designed and implemented in a way that does not negatively affect safety, can be just the edge that is needed to boost productivity.

Although it is expected that much of this technology will be implemented by the private sector without assistance from this government-industry partnership, the following specific tasks will be considered in the 21st Century Truck Program. Other tasks to improve fuel efficiency on a ton-mile per gallon basis will be considered in the future.

Tight Maneuver/Precision Docking

This service would position the bus or commercial vehicle very precisely relative to the curb or loading platform. The driver would maneuver the bus into the loading area and then turn it over to automation. Sensors would continually determine the lateral distance to the curb, front and rear, and the longitudinal distance to the end of the vehicle loading area. The driver would be able to override at any time by operating brakes or steering, and would be expected to monitor the situation and take emergency action if necessary (for example, if a pedestrian steps in front of the vehicle). When the vehicle is properly docked, it would stop and revert to manual control. In freight or bus terminals this service could increase facility throughput as well as safety.

Fully Automated Control at Certain Facilities

This service would enhance efficiency and productivity by providing automated movement of vehicles in dedicated facilities. Initial applications may include automated bus movement in maintenance areas and automated container movement within a terminal area. The transit bus application could be a preliminary use of automation in a low-speed, controlled environment. The automated container movement application would consist of using vehicle automation technologies to move containers within rail depots,

truck terminals, ship yards, or other centralized facilities. This service could be expanded to include platooning capabilities such as electronic tow bars.

4.6.12 Innovative, High-Payoff Technologies

As the R&D plan for the 21st Century Truck Program is defined in more detail, provisions will be made for periodically seeking out new, innovative, potentially high-payoff technologies that could result in significant improvements in truck safety, fuel efficiency, and/or reduction in emissions. A major source for the leading-edge technology breakthroughs will come from ongoing programs sponsored by the government and industry, including research at the national laboratories, universities, and companies involved in the trucking industry. However, it will also be very valuable to track all of the latest relevant advances at the National Aeronautics and Space Administration (NASA), the Defense Advanced Research Projects Agency (DARPA), and the National Institute of Standards and Technology (NIST); from industry at large; and from foreign research activities.

Areas in which particularly relevant advances can be expected include the following:

- fundamental understanding of engines, including breakthrough advances in combustion and aftertreatment;
- new materials technology breakthroughs;
- new analytical and computational methods, particularly those resulting from supercomputing initiatives;
- advances in motors and power electronics, including new materials and models, superconductivity, and high-temperature superconductivity;
- advances in energy storage, including advanced batteries, ultra-capacitors, flywheels, and other novel storage media;
- the integration of mechanical-hybrid technology into heavy vehicles;
- radical breakthroughs in tires, aerodynamics, auxiliaries, and other sources of parasitic losses; and
- breakthroughs in vehicle intelligence for improved efficiency and safety.

In addition, programs such as the Cooperative Automotive Research for Advanced Technologies (CARAT) Program or the Program to Stimulate Trucking Innovative Concepts and Knowledge (STICK) in the DOE Office of Transportation Technologies, as well as similar programs in other participating agencies, should be monitored as a way of mining advanced technologies from innovative small businesses.

5. PROGRAM SUMMARY

5.1 SCHEDULE AND MILESTONES

The overall program schedule and milestones developed by the Roadmap subteams are given in Table 5.1. At the time of this printing, the milestones are those developed by each platform and crosscut team working independently. Since the platform and crosscut teams have some members in common, there has been some coordination between the platform and crosscut teams, but not as much as will be needed as more detailed R&D plans are developed in the coming months. The dates by which technology will be available from the crosscut activities must be reconciled with the dates planned to demonstrate technologies on vehicle platforms. This has not yet been done, but will be the focus of Roadmap activities in the next few months.

Based on input from most of the platform and crosscut technology subteams, it is estimated that a budget of \$300 to \$350 million per year for 10 years will be required to achieve the 21st Century Truck Program goals. This reflects only the federal government share, assuming that the program will be 50-50 cost share with industry over the 10-year life of the program. This budget estimate will be refined as more detailed R&D program plans are developed.

Table 5.1. 21st Century Truck schedule and milestones

		01	02	03	04	05	06	07	08	09	10
4.1	Large Truck—Tractor Trailer										
4.1.1	Waste Heat—Develop technology to reduce engine waste heat from 240 kWh to 220 kWh by 2002, to 175 kWh by 2006, and to 141 kWh by 2009		◇				◇			◇	
4.1.2	Auxiliary Loads—Develop technology to reduce auxiliary load energy losses from 15 kWh to 12.5 kWh by 2003, to 10 kWh by 2006, and to 7.5 kWh by 2009			◇			◇			◇	
4.1.3	Drivetrain Efficiency—Develop technology to reduce drivetrain energy losses from 9 kWh to 6 kWh by 2003, to 5 kWh by 2006, and to 4.5 kWh by 2009			◇			◇			◇	
4.1.4	Rolling Resistance—Develop tire technology to reduce rolling resistance energy loss from 70 kWh to 60 kWh by 2003, to 50 kWh by 2005, and to 40 kWh by 2008			◇		◇			◇		
4.1.5	Aerodynamic Drag—Develop and validate tools to enable new designs to reduce aerodynamic drag energy losses from 85 kWh to 80 kWh by 2003, to 75 kWh by 2005, and to 68 kWh by 2010			◇		◇					◇
4.1.6	Mass Reduction—Complete project to demonstrate capability for 10% tare-weight reduction in each of 2005 and 2009					◇				◇	
4.1.7	Collision Avoidance—Complete demonstration of collision avoidance systems							◇			
4.1.8	Crashworthiness—Complete laboratory tests and field trials of systems to reduce destructive effects of crashes									◇	
4.1.9	Brake Performance—Initiate development of electronic brake systems		◇								
4.1.10	Demonstrate electronic brake systems on tractors and trailers			○						◇	
4.1.11	Develop technology for rollover avoidance	○								◇	
4.1.12	Complete operational test and evaluation of vehicle intelligence and communication system									◇	
4.1.13	Implement a practical retrofit program to greatly reduce PM		◇								
4.1.14	Establish feasibility of practical engine and aftertreatment for 2010 emissions compliance				◇						
4.1.15	Identify fuel and lubricant requirements for success of the complete emissions control (EC) systems			◇							
4.1.16	Develop the enabling technology (materials, lubes, sulfur traps, turbomachinery, etc.) to ensure performance and durability of EGR, aftertreatment, and air-handling systems						◇				

Table 5.1 (continued)

		01	02	03	04	05	06	07	08	09	10
4.1.17	Develop and implement advanced engineering simulations for integrated engine and aftertreatment systems to use in optimizing the system configuration and operating protocols								◇		
4.1.18	Confirm adequate durability of complete EC systems								◇		
4.1.19	Complete field tests of EC systems								◇		
4.1.20	Complete construction of prototype tractor-trailer platforms		◇		◇		◇		◇		◇
4.2	Transit Bus										
4.2.1	Investigate state of manufacture of hybrid electric technology and the individual components	○									◇
4.2.2	Develop innovative vehicle designs and materials usage to achieve target weight reduction	○									◇
4.3	Medium Truck										
4.3.1	Identify detailed power-train architectures and specifications required to reduce engine and accessory losses and to enable hybrid propulsion		○		◇						
4.3.2	Identify detailed opportunities and designs for weight reduction		○			◇					
4.3.3	Develop control strategies for optimizing power-train performance for typical duty cycles			○			◇				
4.3.4	Demonstrate Phase I mass, rolling resistance, and accessory load reduction				○			◇			
4.3.5	Demonstrate Phase I power-train improvements					○			◇		
4.3.6	Demonstrate Phase II advanced mass, rolling resistance, and accessory load reduction						○			◇	
4.3.7	Demonstrate Phase II advanced power-train improvements							○			◇
4.4	Small Truck (TBD)										
4.5	Military Vehicles (TBD)										
4.6	Crosscutting Technologies										
4.6.1	Alternative Fuels (TBD)										
4.6.2	Internal Combustion Engine										
4.6.2.1	Achieve 2002 emissions levels with engine efficiency maintained at approximately 44%		◇								
4.6.2.2	Demonstrate, in a dynamometer environment, the potential (stretch) engine efficiency achievable with integration of high peak firing pressure engine design, feasible exhaust-heat recovery, advanced controls and other improvements in auxiliary drives, low-mechanical-friction features, air handling, and thermal management								◇		
4.6.2.3	Achieve 2010 emissions levels with a production-feasible engine system with 10% higher efficiency over 2002 levels, including any losses from emission-control devices										◇
4.6.3	Aftertreatment										
4.6.3.1	Improve the performance and durability of NO _x reduction technology through improved understanding of basic mechanisms									◇	
4.6.3.2	Improve and apply emission-control simulation tools								◇		
4.6.3.3	Develop better methods and technologies for generating and introducing NO _x reductants to the NO _x control device				◇						
4.6.3.4	Establish the influence of fuels and lubricants on emission-control technologies				◇						
4.6.3.5	Determine the best system configuration for NO _x and PM control devices through examination of their interdependence in full systems					◇					
4.6.3.6	Establish a feasible infrastructure/supply strategy for SCR systems that use non-fuel reductants					◇					
4.6.4	Hybrid Electric Power Trains										
4.6.4.1	Develop a new generation of electric traction motor systems that have higher specific power, lower cost, and durability matching the service life of the vehicle		○					◇			
4.6.4.2	Develop advanced electrical energy-storage systems having higher specific power, improved power acceptance, and lower cost. Demonstrate improved system performance and service life in commercial vehicles		○						◇		

Table 5.1 (continued)

		01	02	03	04	05	06	07	08	09	10
4.6.4.3	Develop power-electronics building blocks needed to lower the cost and improve the performance of hybrid propulsion control systems		○				◇				
4.6.4.4	Determine "best practices" for hybrid electric vehicle electrical safety, disseminate safety information, and promote safety awareness	○									◇
4.6.4.5	Design and test a brake-by-wire regenerative braking system on a prototype vehicle that is capable of capturing more than 50% of the wheel braking energy over the CBD cycle				○		◇				
4.6.4.6	Develop application-specific power plants and customizable system-controller interfaces for commercial and military hybrid electric vehicles		○					◇			
4.6.5	Mechanical Hybrid										
4.6.5.1	Systems Analysis/Architecture—Coordinate with platform teams to analyze and determine the systems architecture for mechanical hybrid trucks and buses	○									◇
4.6.5.2	Safety Standards—Coordinate with platform teams and with safety/standards organizations to develop safety standards associated with mechanical hybrid components and systems	○									◇
4.6.5.3	Mechanical Hybrid Drivetrain Technology—Demonstrate mechanical hybrid drivetrain enabling technologies, such as efficient accumulators/flywheels, valve blocks, transmissions, actuators, clutches, pumps, motors, and regenerative braking components	○									◇
4.6.5.4	Mechanical Hybrid Engine Technology— Demonstrate advanced engines that will enable mechanical hybrid technologies	○									◇
4.6.5.5	Mechanical Hybrid Components for Small Truck—Demonstrate components for a mechanical hybrid to achieve 3× fuel efficiency improvement in a small truck	○			◇						
4.6.5.6	Technical System Integration for Small Truck—Demonstrate integrated production-intent vehicle for a mechanical hybrid to achieve 3× fuel efficiency improvement in a small truck				○		◇				
4.6.5.7	Mechanical Hybrid Components for Medium Truck—Demonstrate components for a mechanical hybrid to achieve 3× fuel efficiency improvement in a medium truck		○				◇				
4.6.5.8	Technical System Integration for Medium Truck—Demonstrate integrated production-intent vehicle for a mechanical hybrid to achieve 3× fuel efficiency improvement in a medium truck.						○		◇		
4.6.5.9	Mechanical Hybrid Components for Transit Bus—Demonstrate components for a mechanical hybrid to achieve 3× fuel efficiency improvement in a transit bus.			○					◇		
4.6.5.10	Technical System Integration for Transit Bus—Demonstrate integrated production-intent vehicle for a mechanical hybrid to achieve 3× fuel efficiency improvement in a transit bus.								○		◇
4.6.6	Fuel Cells										
4.6.6.1	Design and develop reformer systems for logistics fuels	○									◇
4.6.6.2	System design and integration for fuel cells for primary propulsion power	○									◇
4.6.6.3	System design and integration for APUs	○									◇
4.6.6.4	Develop gaseous fuel storage technology	○									◇
4.6.7	Auxiliary Power										
4.6.7.1	Complete truck electrification technology roadmap			◇							
4.6.7.2	Initiate heavy-vehicle electrification program		○								
4.6.7.3	Complete component and APU demonstration and evaluation					◇					
4.6.7.4	Initiate component and APU integration projects					○					
4.6.7.5	Complete prototype demonstration and evaluation of truck electrification								◇		
4.6.7.6	Initiate durability and cost-reduction projects								○		
4.6.7.7	Complete demonstration and evaluation of full truck electrification										◇

Table 5.1 (continued)

		01	02	03	04	05	06	07	08	09	10
4.6.8	Thermal Management										
4.6.8.1	Develop intelligent sensors, controls, and management algorithms to optimize thermal-management systems	○						◇			
4.6.8.2	Develop advanced designs for heat exchangers, taking advantage of newly developed heat-exchanger materials and heat-transfer fluids	○							◇		
4.6.8.3	Develop thermal management systems for advanced power trains (e.g., power electronics and fuel cells)	○							◇		
4.6.8.4	Perform comprehensive computational fluid dynamic simulations of truck airflow to optimize cooling	○							◇		
4.6.8.5	Develop innovative thermal-management concepts						○				◇
4.6.8.6	Design, develop, and demonstrate new thermal-management systems in multiple-truck platforms			○							◇
4.6.9	Materials										
4.6.9.1	Diesel Engines: Develop cost-effective materials solutions for critical problems in fuel systems, air handling, exhaust aftertreatment, high-pressure cylinder heads and engine blocks, and thermal management	○							◇		
4.6.9.2	Hybrid Propulsion: Develop cost-effective materials for power storage (batteries, ultra-capacitors, flywheels, hydraulic-pneumatic mechanical storage systems) and power electronics for hybrid electric propulsion systems	○							◇		
4.6.9.3	Fuel cells: Develop cost-effective SOFC materials technology for hybrid propulsion systems and for APUs	○									◇
4.6.9.4	Develop cost-effective manufacturing technology for lightweight truck components	○									◇
4.6.9.5	Develop advanced design concepts and materials data bases for lightweight components	○							◇		
4.6.9.6	Develop joining, maintenance, and repair technology for lightweight truck components	○									◇
4.6.9.7	Develop advanced materials for truck braking systems to enhance vehicle safety and reliability	○									◇
4.6.9.8	Develop advanced tire systems to reduce rolling resistance while improving truck safety and reliability	○									◇
4.6.9.9	Develop improved lubricant and bearing materials to reduce power-transmission losses and to improve component durability	○									◇
4.6.9.10	Develop advanced sensors for intelligent engine control and emission reduction of diesel engines	○									◇
4.6.9.11	Develop advanced piezoelectric materials for smart actuators in fuel and valve-train systems of diesel engines	○									◇
4.6.9.12	Develop long-life corrosion-control materials and coatings to minimize required corrosion allowances and to enable the use of high-strength weight-reduction materials	○									◇
4.6.10	More-Efficient and/or Lower-Emission Heat Engine Systems (TBD)										
4.6.11	Vehicle Intelligence (See Fig. 4.18)										
○	Indicates beginning										
◇	Indicates completion										

6. REFERENCES

- Achten, P. A. J. 1996. "The End of a Revolution," Ph.D. Thesis, Eindhoven University of Technology, Eindhoven, The Netherlands.
- American Public Transportation Association (APTA). 2000a. *APTA 2000 Public Transportation Fact Book*. American Public Transportation Association, Washington, D.C.
- American Public Transportation Association (APTA). 2000b. *Standard Bus Procurement Guidelines*. <http://www.apta.com/services/procurement/index.htm>.
- Appleby, J. A. 1989. *Fuel Cell Handbook*, Van Nostrand, New York.
- Arthur D. Little, Inc. (A. D. Little). 2000. *Cost Analysis of Fuel Cell System for Transportation: Baseline System Cost Estimate—Report to the U.S. Department of Energy*. Ref. No. 49739, SFAA No. DE-SC02-98EE50526. Arthur D. Little, Inc., Cambridge, Massachusetts.
- Assanis, D. N., E. Karvounis, and J. A. E., Bell. 1993."Design Optimization of the Piston Compounded Adiabatic Diesel Engine Through Computer Simulation," SAE 930986, Society of Automotive Engineers, Warrendale, Penn.
- Blau, P. 1999. *Energy Efficiency in Heavy Vehicle Tires, Drivetrains, and Braking Systems: Draft Multi-Year Program Plan for Running Resistance*. December 22, 1999.
- California Air Resources Board (CARB). 1998. *1998 Zero-Emission Vehicle Biennial Program Review*. California Air Resources Board.
- Chalk, S.1999. *Progress Report for Fuel Cells for Transportation*. U.S. Department of Energy, Office of Advanced Automotive Technologies, Washington, D.C.
- Clark, N. N., J. J. Daley, R. D. Nine, and C. M. Atkinson. 1999. "Application of the New City-Suburban Heavy Vehicle Route (CSHVR) to Truck Emissions Characterization." Topic in General Emissions. Special Publication SP-1459, Paper 1999-01-1467. SAE International, Warrendale, Penn. 1–15.
- Clarke, J. M. 1990. "Ideal Cycles Incorporating Heat Exchange," SAE 900913, Society of Automotive Engineers, Warrendale, Penn.
- Clarke, J. M., and W. G. Berlinger. 1999. "A New Compression Ignition Engine Concept for High Power Density." *Journal of Engineering for Gas Turbines and Power* 121 (2): 211.
- Davis, Stacey C. 1999. *Transportation Energy Data Book: Edition 19*. DOE/ORNL-6958, Oak Ridge National Laboratory, Oak Ridge, Tenn.
- Diesel Emission Control Sulfur Effects Program (DECSE). 1999. *DECSE Program Phase I Interim Data Report No. 2: NO_x Adsorber Catalysts*. U.S. Department of Energy, Office of Transportation Technologies, Washington, D.C.
- Diesel Vehicle Emission Control Sulfur Effects Program (DVECSE). 2000. *Diesel Vehicle Emission Control Sulfur Effects Program. (DVECSE) Project, Phase 1 Final Report*. Oak Ridge National Laboratory, March 2000.
- Ecopoint. 2000. *Selective Catalytic Reduction, DieselNet Technology Guide*. Ecopoint Inc. Revision 2000.08.

- Energy Information Administration (EIA) 1999. *EIA Annual Energy Outlook 2000*. DOE/EIA-0383 (2000). Energy Information Administration, Washington, D.C., December.
- Fanick, Robert, et al. 1995. "Reduction of Diesel NO_x/Particulate Emissions Using a Non-Thermal Plasma." In *Proceedings of the 1995 Diesel Engine Emission Reduction Workshop*, July 24–27, 1995. U.S. Department of Energy, Washington, D.C.
- Federal Highway Administration (FHWA). 1998. *Highway Statistics '97*. FHWA-PL-98-020. U.S. Department of Transportation, Washington, D.C.
- Ferrenberg, A. 1990. "The Single Cylinder Regenerated Internal Combustion Engine." SAE 41st Earthmoving Industry Conference. Society of Automotive Engineers, Warrendale, Penn.
- Ferrenberg, A., et al. 1993. "The Low Heat Rejection Regenerated Diesel Engine," 28th. Intersociety Energy Conversion Engineering Conference (IECEC), August 1993, Atlanta, Georgia.
- Flynn, P. F., R. P. Durrett, G. L. Hunter, W. C. Akinyemi, and L. A. Farrell. 2000. "Minimum Engine Flame Temperature Impacts on Diesel and Spark-Ignition Engine NO_x Production." SAE 2000-01-1177. Society of Automotive Engineers, Warrendale, Penn.
- Goertz, M., and L. Peng. 2000. "Free Piston Engine: Its Application and Optimization," SAE 2000-01-0996. Society of Automotive Engineers, Warrendale, Penn.
- Goldsborough, S. S., and P. Van Blarigan. 1999. "A Numerical Study of a Free Piston IC Engine Operating on Homogeneous Charge Compression Ignition Combustion." SAE 1999-01-0619, Society of Automotive Engineers, Warrendale, Penn.
- Gornitz, V., and I. Fung. 1994. "Potential Distribution of Methane Hydrates in the World Oceans." *Global Biogeochemical Cycles* 8(3): 335–347.
- Hofbauer, P. 2000. "Principles of Operation of an Electrically Assisted Turbocharger with Electronic Speed Modulation." September 2000.
- Inform, Inc. 2000. *Bus Futures—New Technologies for Cleaner Cities*. Inform, Inc.
- Ishibashi, Y., and M. Asai. 1996. "Improving the Exhaust Emissions of Two-Stroke Engines by Applying the Activated Radical Combustion." SAE 960742. Society of Automotive Engineers, Warrendale, Penn.
- Karpuk, M. E. 1989. *Design and Testing of a Dissociated Methanol Vehicle*. DOE/CH/10093-H5. U.S. Department of Energy, Washington, D.C.
- Kawamura, H., and A. Ishida. 2000. "Development of Ceramics Adiabatic Engine Having 68% Thermal Efficiency." ASME 2000-ICE-334, ASME ICE Fall Technical Conference. American Society of Mechanical Engineers, Warrendale, Penn.
- Larminie, J., and A. Dicks. 2000. *Fuel Cell Systems Explained*. John Wiley and Sons, New York.
- Letavec, C. A., J. S. Degal, and J. P. Uihlein. 2000. "EC-Diesel Technology Validation Program Interim Report." CEC/SAE Spring Fuels & Lubricants Meeting & Exposition, June 2000, Paris, France. 2000-01-1854. Society of Automotive Engineers, Warrendale, Penn.
- Liang, C. Y., et al. 2000. "Effects of Diesel Fuel Sulfur Level on Performance of a Continuously Regenerating Diesel Particulate Filter and a Catalyzed Particulate Filter." CEC/SAE Spring Fuels &

- Lubricants Meeting & Exposition, June 2000, Paris, France. 2000-01-1876. Society of Automotive Engineers, Warrendale, Penn.
- Manufacturers of Emission Controls Association (MECA). 2000. *MECA-Written Statement of the Manufacturers of Emission Controls Association on the U.S. Environmental Protection Agency's Proposed Heavy-Duty Engine and Vehicle Standards and Highway Diesel Sulfur Control*. Docket No. A-99-06, August 14, 2000.
- Miller, William, et al. 2000. "The Development of Urea-SCR Technology for U.S. Heavy Duty Trucks." SAE Paper No. 2000-01-0190. Society of Automotive Engineers, Warrendale, Penn.
- Minh, N. Q., and T. Takahashi. 1995. *Science and Technology of Ceramic Fuel Cells*. Elsevier, Amsterdam.
- National Archives. 1996. *Federal Register*. Vol. 61, 33421, June 26, 1996.
- National Renewable Energy Laboratory (NREL). 1996. *Alternative Fuel Transit Buses, Final Results from the NREL Vehicle Evaluation Program*. National Renewable Energy Laboratory, Golden, Colo.
- National Renewable Energy Laboratory (NREL). 2000a. *Alternative Fuel Transit Buses, DART's LNG Bus Fleet Final Data Report*. National Renewable Energy Laboratory, Golden, Colo.
- National Renewable Energy Laboratory (NREL). 2000b. *Development of an Ultra-Safe, Ultra-Low Emissions Natural Gas Fueled School Bus: Final Report*. NREL/SR-540-23842. National Renewable Energy Laboratory, Golden, Colo.
- National Renewable Energy Laboratory (NREL). 2000. "Biomass: Nature's Renewable Storehouse of Solar Energy and Chemical Resources." http://www.nrel.gov/research/industrial_tech/biomass.html.
- Nixdorf, Dick. 2000. "Microwave-Regenerated Ceramic Filter for Diesel Exhaust Particulate Control," *CIDI Engine Combustion, Emission Control, and Fuels Review*. May 2000.
- Nurun, N. M., et al. 1999. "Ultra Low NO_x and Smokeless Diesel Combustion with Highly Oxygenated Fuel," 15th International Combustion Engine Symposium, Seoul.
- NYC. 2000. *NYC Transit Report*.
- Office of Heavy Vehicle Technologies (OHVT). 1997. *Comprehensive Program Plan for Natural Gas Vehicle Research*. Office of Heavy Vehicle Technologies, Office of Transportation Technologies, Energy Efficiency and Renewable Energy, U.S. Department of Energy, Washington, D.C.
- Office of Heavy Vehicle Technologies (OHVT). 1998. *Diesel Engine Combustion Research, Program Plan FY 1998–2002*. June 1998 Draft, Office of Heavy Vehicle Technologies, Office of Transportation Technologies, Energy Efficiency and Renewable Energy, U.S. Department of Energy, Washington, D.C.
- Office of Heavy Vehicle Technologies (OHVT). 1999a. *Heavy Vehicle Propulsion Materials Draft Multi-Year Program Plan*. Revision 4. Office of Heavy Vehicle Technologies, Office of Transportation Technologies, Energy Efficiency and Renewable Energy, U.S. Department of Energy.
- Office of Heavy Vehicle Technologies (OHVT). 1999b. *Heavy Vehicle Hybrid Propulsion Systems R&D, Program Plan FY 1999–2003*. Draft, Office of Heavy Vehicle Technologies, Office of Transportation Technologies, Energy Efficiency and Renewable Energy, U.S. Department of Energy.

- Office of Heavy Vehicle Technologies (OHVT). 1999c. *Multi-Program Plan—Reducing Friction and Wear in Heavy Vehicles*. Office of Heavy Vehicle Technologies, Office of Transportation Technologies, Energy Efficiency and Renewable Energy, U.S. Department of Energy, Washington, D.C.
- Parks, J. E. II, G. J. Wagner, W. S. Epling, M. W. Sanders, and L. E. Campbell. 1999. “NO_x Sorbate Catalyst System with Sulfur Catalyst Protection for the Aftertreatment of No. 2 Diesel Exhaust,” SAE Technical Paper 1999-01-3557. Society of Automotive Engineers, Warrendale, Penn.
- Penetrante, B. M. “Plasma-Assisted Heterogeneous Catalysis for NO_x Reduction in Lean-Burn Engine Exhaust.” *Proceedings of the 1997 Diesel Engine Emission Reduction Workshop*.
- Psaras, Dimitri, and Jerry Summers. 1995. “EOLYS (trademark), an Effective System Approach for Achieving Low Emissions in Advanced Diesel Engines,” *Proceedings of the 1995 Diesel Engine Emission Reduction Workshop*, July 24–27, 1995. U.S. Department of Energy, Washington, D.C.
- Sherman, A. J., R. H. Tuffias, and R. B. Kaplan. 1991. “Refractory Ceramic Foams: A Novel, New High Temperature Structure.” *American Ceramics Society Bulletin* 70 (6): 1025–29.
- Sklad, P. 2000. *High-Strength Weight Reduction Materials Draft Multi-Year Program Plan*. Revision 1. February 24, 2000 (Draft).
- Society of Automotive Engineers (SAE). 1988. “Truck and Bus Engine and Vehicle Performance Subcommittee, Information Relating to Duty Cycles and Average Power Requirements of Truck and Bus Engine Accessories.” SAE J1343, Society of Automotive Engineers, Warrendale, Penn.
- Society of Automotive Engineers (SAE). 1999. “Non-Thermal Plasma for Exhaust Emission Control: NO_x, HC, and Particulates.” SAE Special Publication SP-1483. Edited by M. L. Balmer, G. Fisher, and J. Hoard. Society of Automotive Engineers, Warrendale, Penn.
- Solid State Energy Conversion Alliance. 2000. *Workshop Proceedings*. Baltimore, Md.
- Stodolsky, F., L. Gaines, and A. Vyas. 2000. *Analysis of Technology Options to Reduce the Fuel Consumption of Idling Trucks*. ANL/ESD-43. Center for Transportation Research, Argonne National Laboratory, Argonne, Ill.
- Transit Cooperative Research Program (TCRP). 2000. *Hybrid Electric Transit Buses: Status, Issues, and Benefits*. Report No. 59. National Academy of Sciences, Washington, D.C.
- Transportation Research Board (TRB). 2000. *Review of the Research Program for a New Generation of Vehicles*. Transportation Research Board, National Research Council, Washington, D.C.
- Truck Index. 1994. *Gasoline Truck Index and Diesel Truck Index*. Truck Index, Inc., Santa Ana, Calif.
- . 1995. *Gasoline Truck Index and Diesel Truck Index*. Truck Index, Inc., Santa Ana, Calif.
- . 1996. *Gasoline Truck Index and Diesel Truck Index*. Truck Index, Inc., Santa Ana, Calif.
- . 1997. *Gasoline Truck Index and Diesel Truck Index*. Truck Index, Inc., Santa Ana, Calif.
- U.S. Department of Commerce (DOC). 1999. *1997 Economic Census: Vehicle Inventory and Use Survey*. EC97TV-US, U.S. Census Bureau, Department of Commerce, Washington D.C.

- U.S. Department of Commerce (DOC). 2000. *1997 Vehicle Inventory and Use Survey: Microdata File*. U.S. Census Bureau, U.S. Department of Commerce, Washington, D.C.
- U.S. Department of Defense (DOD). Army Tank-Automotive and Armaments Command (TACOM). <http://www.tacom.army.mil/>.
- U.S. Department of Energy (DOE). 1996. *An Assessment of Flywheel Energy Storage Technology for Hybrid and Electric Vehicles*. U.S. Department of Energy, Washington, D.C.
- U.S. Department of Transportation (DOT). 1997. *Intelligent Vehicle Initiative Business Plan*. U.S. Department of Transportation, Intelligent Transportation Systems Joint Program Office, Washington, D.C.
- U.S. Department of Transportation (DOT). 2000. *Intelligent Vehicle Initiative Business Plan*. U.S. Department of Transportation, Intelligent Transportation Systems Joint Program Office, Washington, D.C.
- U.S. Environmental Protection Agency (EPA). 2000. *Proposed Heavy Duty Engine and Vehicle Standards and Highway Diesel Fuel Sulfur Control Requirements*. EPA420-F-00-022, U.S. Environmental Protection Agency, Washington, D.C.
- Warren, J. P., et al. 2000. "European Experience of High Mileage Durability of Continuously Regenerating Diesel Particulate Filter Technology." SAE 2000 World Congress, March 2000, Detroit, Mich. 2000-01-0480. Society of Automotive Engineers, Warrendale, Penn.
- Wipke, K., M. Cuddy, D. Bharathan, S. Burch, V. Johnson, T. Markel, and S. Sprik. 1998. "ADVISOR 2.0: A Second-Generation Advanced Vehicle Simulator for Systems Analysis." In Conference Proceedings from North American EV & Infrastructure Conference and Exposition, Phoenix, Arizona.

APPENDIX A

CONTRIBUTORS TO THE 21st CENTURY TRUCK PROGRAM TECHNOLOGY ROADMAP

APPENDIX A

CONTRIBUTORS TO THE 21st CENTURY TRUCK PROGRAM TECHNOLOGY ROADMAP

Rene Abarcar, *Energetics*
Ed Bass, *Allison Transmission*
Kevin Beaty, *Eaton*
Rich Bergstrand, *PACCAR*
Tom Biro, *International Truck and Engine*
(*Subteam Chair*)
Ron Bradley, *ORNL (Team Leader)*
Fred Cartwright, *Allison Transmission*
John Clark, *Caterpillar (Subteam Chair)*
Roger Clark, *General Motors*
Bob Clarke, *U.S. DOT*
Patrick Dessert, *Oakland University*
Lee Dodge, *SwRI*
Kate Drakos, *EMA*
James Eberhardt, *U.S. DOE*
Pat Flaherty, *U.S. DOE*
Christina Gikakis, *U.S. DOT*
Bill Gouse, *Freightliner*
Ron Graves, *ORNL (Subteam Chair)*
Charles Gray, *EPA*
Nabil Hakim, *Detroit Diesel (Subteam Chair)*
Katherine Hartman, *U.S. DOT*
Norm Helgeson, *Navy/NFESC*
Dean Helms, *TMA*
Greg Hofmann, *BAE SYSTEMS Controls*
Shang Hsiung, *U.S. DOT (Subteam Chair)*
Caitlin Hughes, *U.S. DOT*
John Hull, *ANL (Subteam Chair)*
John Kargul, *EPA (Subteam Chair)*
Glenn Keller, *EMA*
Jack Klein, *Mack Trucks*
Bill Knee, *ORNL*
Linda Lawson, *U.S. DOT*
William Leasure, *TMA*
Scott Lockledge, *OSTP*
Bart Mancini, *Nova Bus*
Scott McBroom, *SwRI*
Jim McDowell, *Nova Bus*
Oliver McGee, *U.S. DOT*
Don Moore, *Western Star Trucks*
Dave O’Kain, *ORNL*
Jim Patten, *Battelle-Columbus*
Duane Perrin, *U.S. DOT*
Rob Piacesi, *SwRI*
David Powell, *IITRI*
Ray Resendes, *U.S. DOT (Subteam Chair)*
Guy Rini, *Mack Trucks*
Charles Roehm, *ANL*
Dan Santini, *ANL*
S.M. Shahed, *Honeywell*
Bill Siegel, *U.S. DOT (Subteam Chair)*
Mike Simon, *ISE Research*
Gurpreet Singh, *U.S. DOE*
Paul Skalny, *TACOM*
Dave Smith, *Allison Transmission*
David Stafford, *Michelin*
Randy Steer, *OMB*
Frank Stodolsky, *ANL*
Tom Vachon, *Caterpillar*
Kathy VanLenten, *Energetics*
Keith Vertin, *NREL (Subteam Chair)*
Jud Virden, *PNNL (Subteam Chair)*
John Woodrooffe, *TMA Canada*
(*Subteam Chair*)
Skip Yeakel, *Volvo*
Ron York, *General Motors (Subteam Chair)*
Steve Zimmer, *DaimlerChrysler*
(*Subteam Chair*)

APPENDIX B

21st CENTURY TRUCK PROGRAM SUBTEAMS

APPENDIX B

21st CENTURY TRUCK PROGRAM SUBTEAMS

Large Truck—Tractor Trailer

John Woodrooffe (Chair), *TMA Canada*
Rich Bergstrand, *PACCAR*
John Bishop, *SwRI (Army rep)*
Bob Clarke, *U.S. DOT*
Bill Corwin, *ORNL*
Dan Farmer, *PACCAR*
Bill Gouse, *Freightliner*
Ron Graves, *ORNL*
Nabil Hakim, *Detroit Diesel*
Kate Hartman, *U.S. DOT*
Scott McBroom, *SwRI (Army rep)*
Rich Nellums, *Eaton*
Guy Rini, *Mack Trucks*
Dan Santini, *ANL*
S.M. Shahed, *Honeywell*
Dave Smith, *Allison Transmission*
David Stafford, *Michelin*
Tom Vachon, *Caterpillar*
Keith Vertin, *NREL*
Steve Weissner, *International Truck and Engine*
Chris Yakes, *Oshkosh Trucks*
Skip Yeakel, *Volvo*

Transit Bus

Bill Siegel (Chair), *U.S. DOT*
Ed Bass, *Allison Transmission*
Bill Corwin, *ORNL*
Vinod Duggal, *Cummins Engine*
Mary Gerstner, *Honeywell*
Greg Hofmann, *BAE SYSTEMS Controls*
Jim McDowell, *Nova Bus*
Dave O'Kain, *ORNL*
Mike Simon, *ISE Research*
Jerry Trotter, *APTA*
Keith Vertin, *NREL*

Medium Truck

Tom Biro (Chair), *International Truck and Engine*
Ed Bass, *Allison Transmission*
John Bishop, *SwRI (Army rep)*
Shubhayu Chakraborty, *Eaton*
Bill Corwin, *ORNL*

Bill Gouse, *Freightliner*
Greg Hofmann, *BAE SYSTEMS Controls*
Scott McBroom, *SwRI*
Duane Perrin, *U.S. DOT*
Charles Roehm, *ANL*

Small Truck

Ron York (Chair), *General Motors*
Steve Zimmer (Chair), *DaimlerChrysler*
Kevin Beaty, *Eaton*
John Bishop, *SwRI (Army rep)*
Roger Clark, *General Motors*
Bill Gouse, *Freightliner*
Greg Hofmann, *BAE SYSTEMS Controls*
Scott McBroom, *SwRI (Army rep)*
Duane Perrin, *U.S. DOT*
Charles Roehm, *ANL*
John Stang, *Cummins Engine*
Jud Virden, *PNNL*

Internal Combustion Engine

Nabil Hakim (Chair), *Detroit Diesel*
Tom Asmus, *DaimlerChrysler*
Brian Bolton, *Detroit Diesel*
Bob Carling, *SNL*
Christina Gikakis, *U.S. DOT*
Shang Hsiung, *U.S. DOT*
Gary Hunter, *Cummins Engine*
Yury Kalish, *Detroit Diesel*
Glenn Keller, *EMA*
Pete Schihl, *TACOM*
Tom Vachon, *Caterpillar*

Aftertreatment

Ron Graves (Chair), *ORNL*
Mari Lou Balmer, *PNNL*
Lee Dodge, *SwRI (Army rep)*
Christina Gikakis, *U.S. DOT*
Bill Gouse, *Freightliner*
Nabil Hakim, *Detroit Diesel*
Shang Hsiung, *U.S. DOT*
Dale McKinnon, *MECA*

George Muntean, *Cummins Engine*
Jim Patten, *Battelle-Columbus*
Tom Vachon, *Caterpillar*
Jud Virden, *PNNL*

Hybrid Electric Power Trains

Keith Vertin (Chair), *NREL*
Ed Bass, *Allison Transmission*
Kevin Beaty, *Eaton*
Bill Corwin, *ORNL*
Vinod Duggal, *Cummins Engine*
Mike Duoba, *ANL*
Mary Gerstner, *Honeywell*
Greg Hofmann, *BAE SYSTEMS Controls*
Shang Hsiung, *U.S. DOT*
Bill Kahn, *Peterbilt Motors*
Scott McBroom, *SwRI (Army rep)*
Jim McDowell, *Nova Bus*
Dave O'Kain, *ORNL*
Kaushik Rajashetara, *Delphi*
Bill Siegel, *U.S. DOT*
Mike Simon, *ISE Research*
Dave Smith, *Allison Transmission*
Jerry Trotter, *APTA*

Mechanical Hybrid

John Kargul (Chair), *EPA*
Tom Biros, *International Truck and Engine*
Dwight Holloway, *Caterpillar*
Scott McBroom, *SwRI (Army rep)*
Dave O'Kain, *ORNL*
Tom Vachon, *Caterpillar*

Fuel Cells

Shang Hsiung (Chair), *U.S. DOT*
Tim Armstrong, *ORNL*
Ed Bass, *Allison Transmission*
Vince Callaghan, *International Fuel Cells*
Steve Chalk, *U.S. DOE*
Ken Koyoma, *California Energy Commission*
Nguyen Minh, *Honeywell*
Alan Montemayor, *SwRI (Army rep)*
Robert Nowak, *DARPA*
Ric Pow, *EXCELLSiS Fuel Cell Engines*
Bob Rose, *U.S. Fuel Cell Council*
Jules Routbort, *ANL*

Jim Wood, *Delphi*
Jiemin Zhu, *Detroit Diesel*

Auxiliary Power

Jud Virden (Chair), *PNNL*
Tim Armstrong, *ORNL*
Jeff Corey, *Peterbilt*
Lee Dodge, *SwRI (Army rep)*
Mary Gerstner, *Honeywell*
Christina Gikakis, *U.S. DOT*
Bill Gouse, *Freightliner*
Shang Hsiung, *U.S. DOT*
Dave Orr, *Caterpillar*

Thermal Management

John Hull (Chair), *ANL*
Lee Dodge, *SwRI (Army rep)*
Christina Gikakis, *U.S. DOT*
Shang Hsiung, *U.S. DOT*
Moe Khaleel, *PNNL*
Rick Kleine, *Cummins Engine*
James Klett, *ORNL*
Mark Moeckel, *Caterpillar*
Eric Poulson, *PACCAR*
Freidoon Rastegar, *Honeywell*
Marty Wambsganss, *Consultant*

Materials

Bill Corwin (Chair), *ORNL*
Paul Becker, *Cummins Engine*
Rich Bergstrand, *PACCAR*
Christina Gikakis, *U.S. DOT*
Shang Hsiung, *U.S. DOT*
Caitlin Hughes, *U.S. DOT*
Bart Mancini, *Nova Bus*
Phil McCluskey, *Caterpillar*
Mark Smith, *PNNL*
Tom Yonushonis, *Cummins Engine*

More-Efficient and/or Lower-Emission Heat Engine Systems

John Clarke (Chair), *Caterpillar*
Mark Aramli, *Capstone Turbine*
Lee Dodge, *SwRI (Army rep)*
Ron Graves, *ORNL*
Karl Hellman, *EPA*
Glenn Keller, *EMA*
Tom Vachon, *Caterpillar*

Vehicle Intelligence

Ray Resendes (Chair), *U.S. DOT*
Bill Gouse, *Freightliner*
Bill Knee, *ORNL*

Guy Rini, *Mack Trucks*
Ron Temple, *Cummins Engine*
Skip Yeakel, *Volvo*

APPENDIX C

**PARTICIPANTS IN THE OCTOBER 25, 2000, MEETING OF THE
21st CENTURY TRUCK PROGRAM PARTNERSHIP COORDINATING COMMITTEE**

APPENDIX C

PARTICIPANTS IN THE OCTOBER 25, 2000, MEETING OF THE 21st CENTURY TRUCK PROGRAM PARTNERSHIP COORDINATING COMMITTEE

Industry Members

René Allen, *Vice President, Product Planning,
NovaBUS Incorporated*

Randy Allran, *Executive Vice President,
Engineering and Operations, Detroit Diesel
Corporation*

Keith Brandis, *Vice President, Marketing, Volvo
Trucks North America*

Eduardo Castro-Wright, *President and CEO,
Honeywell Transportation Systems,
Honeywell, Inc.*

Philip J. Christman, *Vice President, Core
Engineering and Product Support,
International Truck and Engine Corporation*

Denyse LeFever, *Vice President, HEV Power
and Drive Systems, BAE SYSTEMS Controls*

Stephen Homcha, *Executive Vice President,
Class 8 Program, Mack Trucks, Inc.*

Tim Morscheck, *Vice President and General
Manager, Trucking Electronic Systems
Division, Eaton Corporation*

David M. Piper, *Director of Engineering,
Allison Transmission Division, General
Motors Corporation*

Bernard I. Robertson, *Senior Vice President,
Engineering Technologies, DaimlerChrysler
Corporation*

Margaret Sullivan, *Director of Advanced
Technology, PACCAR Inc.*

Don Verhoff, *Vice President, Technology,
Oshkosh Truck Corporation*

Michael von Mayenburg, *Senior Vice President,
Engineering and Technology, Freightliner
LLC*

Christine Vujovich, *Vice President,
Environmental Policy and Product Strategy,
Cummins, Inc.*

Sherril K. West, *Vice President, Technical
Services Division, Caterpillar, Inc.*

Ron York, *Director, Partnership for a New
Generation of Vehicles, GM Advanced*

*Technology Vehicles, General Motors
Corporation*

Government Members

Roger Ballentine, *Deputy Assistant to the
President, Executive Office of the President*

Mortimer L. Downey (Vice-Chair), *Deputy
Secretary, Office of the Secretary, S-2, U.S.
Department of Transportation*

T. J. Glauthier (Chair), *Deputy Secretary, U.S.
Department of Energy*

Thomas Gross, *PCO Executive Director and
Deputy Assistant Secretary for
Transportation Programs, Energy Efficiency
and Renewable Energy, EE-30, U.S.
Department of Energy*

Paul J. Hoeper (Vice-Chair), *Assistant Secretary
of the Army for Acquisition, Logistics, and
Technology, U.S. Department of Defense*

Duncan T. Moore, *Associate Director for
Technology, White House Office of Science
and Technology Policy*

Robert Perciasepe (Vice-Chair), *Assistant
Administrator for Air and Radiation, U.S.
Environmental Protection Agency*

Dan Reicher, (Alternate Chair), *Assistant
Secretary, Energy Efficiency and Renewable
Energy, EE-1, U.S. Department of Energy*

Wesley P. Warren, *Associate Director for
Natural Resources, Energy and Science
Office of Management and Budget*

Morley A. Winograd, *Senior Policy Advisor and
Director, Partnership for Reinventing
Government, Office of the Vice President*

Observing Members

Glenn F. Keller, *Executive Director, Engine
Manufacturers Association*

Bill Leasure, *Executive Director, Truck
Manufacturers Association*

APPENDIX D

INTERNAL COMBUSTION ENGINE TECHNOLOGY

APPENDIX D

INTERNAL COMBUSTION ENGINE TECHNOLOGY

D.1 IN-CYLINDER COMBUSTION AND EMISSIONS

The in-cylinder combustion and emissions processes are central to the performance, efficiency, and engine-out emissions of diesel engines. Our understanding of these processes have improved dramatically over the past decade through the application of advanced optical diagnostics and modeling tools. However, much still remains to be learned, and modeling improvements are required. Moreover, in-cylinder processes will need to be optimized to work efficiently with aftertreatment systems.

D.1.1 Combustion Event and Emissions Processes

Diesel engine combustion and emissions formation processes are driven by a very complex set of interacting fluid-mechanic and chemistry processes. The current understanding of these processes provides a general picture of the structure of a diesel spray during injection for moderate-load, quiescent conditions and the scaling of many of the features of the diesel spray with engine and injector parameters. This picture includes when and where fuel breaks up and is vaporized, where combustion occurs, and when and where soot and NO_x are formed. The knowledge of the spatial evolution of NO_x and soot after the end of injection is also emerging.

This understanding provides a foundation on which to build a more comprehensive picture of the diesel combustion process for a wide range of in-cylinder conditions. The goal is to provide the understanding needed to enhance fuel-air mixing during injection, tailor and control heat release, lower peak in-cylinder temperatures, and enhance late-cycle mixing. These comprise the basic pathways for improving combustion performance and reducing emissions. To achieve this goal, improved understanding is needed in the following main areas: in-cylinder flow prior to fuel injection, fuel-injection spray interaction, ignition/premixed burn (fuel effects), combustion and emissions formation during injection, post-injection combustion, and emissions development.

D.1.2 Exhaust Gas Recirculation (EGR)

Current understanding of the impact of EGR on in-cylinder diesel processes is very limited. Models and data must be developed to understand the effects of EGR on all the various in-cylinder diesel processes. Mixing uniformity of EGR with fresh intake air in the engine cylinders needs to be studied.

D.1.3 Bowl Geometry and Fluid-Mechanics Effects

Bowl geometry influences the diesel combustion process through several paths, including the interaction of the vaporized fuel jet with the bowl wall; bowl shape influences on the turbulent energy that promotes fuel-air mixing; and bowl aspect ratio and re-entrancy influence on the strength of the squish flows, which help large-scale vortical structures within the bowl (a critical factor in late-cycle mixing).

Predictive models of bowl geometry effects, pinned in the underlying physics, are presently inadequate. A detailed understanding is needed and can only be achieved through comprehensive in-cylinder measurements of flow and composition, supported by detailed modeling.

D.1.4 Fuel Types and Effects

Chemical and physical properties of fuels are known to influence pollutant emissions through several mechanisms. A complete understanding is lacking of the influence of fuel properties on in-cylinder

processes. In-cylinder diagnostics can provide a knowledge base, enabling new engines to be developed that use new fuels to their full potential. Three general fuel classes require further study: improved “traditional” petroleum-based diesel fuel and how a tailored set of fuel properties can help achieve fuel efficiency and emissions targets; oxygenated (renewable) fuels, which also contain oxygen that can be produced domestically to reduce dependence on foreign oil; and Fischer-Tropsch fuels that can be produced from natural gas and coal.

D.1.5 Fuel-Injection System

Recent research strongly indicates that further fuel-injection system improvements will yield significant enhancements to engine performance and emissions. Briefly, technology areas requiring further R&D include pilot injection, injection-rate shaping, and multiple injections; increased and controlled injection pressures; injector tip/orifice geometry; and advanced actuators such as piezoelectric for more precise control of injection parameters.

D.1.6 Water Emulsions and Other Water-Injection Techniques

Water injection technology holds the promise of breaking the soot-NO_x trade-off conundrum that often limits the design of diesel engine combustion strategies. Water-emulsified fuels require no special injection equipment. However, they have several drawbacks, including the supply infrastructure and possible separation of the water and fuel. A fixed water concentration eliminates the possibility of “tuning” the water fraction to obtain an optimal reduction in soot formation without inhibiting the final soot burnout at each operating condition. Alternative water supply methods provide greater control and cycle-by-cycle flexibility. Although the benefits of water (and other oxygenates) addition have been well documented, the cost of cosolvents or additional injection equipment has been prohibitive so far.

D.1.7 Advanced Fuel-Injection and Mixing Techniques

Advanced, nonconventional fueling techniques and auxiliary in-cylinder mixing offer the potential of reducing diesel emissions while maintaining or even improving fuel consumption. An evaluation of potential techniques would be followed by a down-selection to the most promising methods for more in-depth R&D. Examples include

- variable orifice size;
- high-frequency injection-rate modulation to increase air entrainment and spreading the angle of the jet in the near-orifice region, leading to reduced soot formation;
- ultrasonic dual-fluid mixing injectors as means for supplying a water-fuel mixture that can be varied on demand;
- late-cycle air-gas mixing; and
- possibly gaseous fumigation techniques for HCCI-like combustion of gaseous-diesel fuel combinations.

D.1.8 Heat Transfer

Heat transfer influences both global and spatially localized aspects of the combustion process. Globally, heat transfer affects the energy available in the in-cylinder gases to perform useful work, while local heat-transfer rates can affect processes as diverse as film vaporization rates and the kinetics of chemical reactions. Improvements in predictive capabilities are required for convective and radiative heat transfer in both models and correlations.

D.1.9 Advanced Modeling Development and Techniques

The current spray-modeling approach is inappropriate for the high-pressure injectors used in modern diesel engines. Areas of improvement for the computational fluid dynamics codes include improved spray and jet-mixing models, variable-density and one-dimensional turbulence models, fuel injector orifice-flow modeling, and soot burnout.

Understanding chemical kinetics is critical to the complete understanding of diesel combustion, including an experimental program to measure reaction rates at high pressure, the development of chemical kinetic mechanisms for a small set of molecules that make up the surrogate diesel fuel, and the development of new techniques to minimize the number of reaction mechanisms needed to adequately describe the in-cylinder chemistry.

D.1.10 Advanced Diagnostic Development for Combustion and Emissions Measurements

Developing an understanding of the foregoing requires advanced diagnostic tools for the measurement of parameters such as temperature, molecular species, particulates, and liquid-vapor fuel quantification.

D.2 ENGINE SUBSYSTEM TECHNOLOGY

D.2.1 Parasitic Losses

Some of an engine's useful work is dissipated through the friction losses or is expended through pumping losses. Significant fuel savings can be realized by addressing these parasitic losses.

The major portion of total engine mechanical friction can be traced to the cylinder kit, bearings, and valve train. Further advancement in the tribology of these interfaces can yield improvements of several percent in overall engine fuel economy, especially through the introduction of new materials and coatings. Longer-term concepts include vapor-phase lubrication and advanced lubricants.

Energy expended on driving the engine fuel, oil, and water pumps is an unavoidable part of the engine energy balance, but its reduction is necessary and indeed possible. The highest potential in this area lies with the introduction of electronically controlled pumps. The development of novel pump designs is an important priority.

Currently, turbocharged engines capture part of their available exhaust energy. Additional utilization of the exhaust energy is possible. Significant development is needed to create cost-effective and reliable turbocompounding designs or other concepts.

A significant portion of the crankshaft energy is still expended in driving the engine-cooling fan, generator/alternator, air compressor, and air conditioning. New approaches need to be developed to reduce this energy expenditure. Ways of reducing the time of engine idling can be helpful.

D.2.2 Heat Rejection

Heat rejection is an important consideration for fuel economy. It is also a significant application issue. High heat rejection implies the need for larger coolers and radiator, which is contradictory to truck design trends requiring smaller frontal areas and smaller engine compartments for better aerodynamics as well as improved visibility and safety. Areas of lower heat rejection include strategic cooling, EGR cooling, charge cooling, radiator design, and measurements.

Not all engine components require the same level of cooling, which calls for strategically routing the coolant. This would provide more coolant flow to the areas of the engine that need it most and reduce the coolant flow to other areas, thus minimizing parasitic fan and pump use.

Addition of EGR counteracts heat rejection reduction. Lowering the heat rejection will include evaluating EGR to air coolers, improving the efficiency of EGR coolers, and routing the EGR. EGR cooler development will continue targeting durability, erosion, corrosion, and fouling. It is also important to continue development of lower-cost, more-efficient and less-bulky radiator and charge air coolers.

Experimental measurements of engine heat rejection in a truck are cumbersome and expensive. Measurement of engine heat rejection in the laboratory exhibits significant variability. Heat-rejection measurement methods need improvement, and reliable analytical means of predicting heat rejection require continual development.

D.2.3 Controls

Early electronically controlled diesel engines had two control parameters: beginning of injection (BOI) and pulse width. Newer engines will feature many other controlled subsystems, such as turbochargers, EGRs, aftertreatment devices, and possibly coolant and lubricating pumps. By itself, a common rail fuel-injection system, in addition to BOI and pulse width of the main event, requires control of rail pressure, duration of pilot injections and post-injections, and separations between sub-injections.

All of these changes will require significant new developments in control strategies, rapid prototyping of controls, auto-calibration, and on-board diagnostics (OBD). Always a large part of the control development process, engine calibration (populating numerous maps in the engine controls software) will invariably become more cumbersome on future engines with many more maps to fill. Automatic calibration, if successfully developed, will shorten the calibration time and will arrive at global optima without the tedious experimental calibration process. Approaches include design of experiments and neural networks and application of genetic algorithms.

Significant groundwork needs to be initiated for the truck industry to be prepared for future OBD requirements. Novel sensors need to be developed and applied as part of the controls strategies. Some may be virtual sensors, requiring model based controls development.

D.2.4 Noise-Vibration-Harshness (NVH)

Attention to all three noise steps—generation, propagation through the engine structure, and radiation—is necessary for adequate engine noise abatement. The characteristic diesel engine combustion sound is a product of the sharp pressure rise in the combustion chamber during fast premixed burn. Further research will allow reducing combustion noise without affecting engine performance or emissions. Mechanical noise is related to piston slap and impacts in the bearings, valve train, and gear train. Research into the exact mechanisms of mechanical noise generation will provide further reductions. Other sources include high-frequency turbocharger whine and airborne noise of the gas in the EGR circuit.

Prior studies into noise propagation have identified that main paths of vibration energy travel through the engine structure. Developments of statistical energy analysis (SEA) and boundary element analysis (BEA) should be expanded to yield proper ways of engine structure design for low noise.

BEA may also be applied to structure-borne noise radiation. The shape of engine surface and location of engine accessories need to be selected with noise radiation in mind. Acoustical materials such as laminated steels, foams, and viscoelastic damping layers require further development. Also, engine-mounting innovations will contribute to the vibration isolation from the engine to the vehicle.

D.2.5 Tribology

Tribology benefits engine fuel economy through friction reduction, engine durability through wear reduction, and engine performance-emissions trade-offs by enabling a broader-temperature engine

operation. Tribological issues requiring further development include cylinder kit, bearings, EGR condensation, and fuel-injection system wear.

The cylinder kit is a source of significant friction losses and often becomes the limiting factor for engine reliability (due to scuffing) and for engine durability (due to wear). It is also the major contributor to engine oil consumption and related particulate emissions formation. Cylinder kit tribological improvement will produce large benefits. Better understanding is required of physical processes through analytical modeling and experimental investigations and the correlation of fixture results to the engine. Also, low-friction coatings, and durable-wear and scuff-resistant coatings require development. Innovative lubrication systems and oil formulations, especially the additives package, also require further improvement. In particular, alternatives to today's sulfur-laden anti-wear additives may be needed to prolong the life of aftertreatment devices.

EGR is an effective means of reducing NO_x but acidic condensation of EGR gas is a serious threat to the reliable operation of an engine. Better protection from EGR condensation requires new corrosion-resistant materials and coatings for application to intake manifold and in-cylinder components.

Fuel-injection systems lubricated with low-lubricity diesel fuel present some of the most challenging tribological problems. Better understanding of the fuel-system tribology with its very high pressures is needed. New materials and coatings will be enabling technologies.

D.2.6 EGR—Multiple-Cylinder Effects

Many EGR technical areas still require improvement and optimization, including EGR layout, EGR drivers, actuation and sensing, mixing, condensation and integration with aftertreatment. Several EGR options exist, such as cooled variable-geometry turbocharger (VGT)-driven, high-pressure-loop EGR. Many analytical and experimental investigations are needed to sort out all options, reveal technical barriers, and identify possible trade-offs.

Modulated EGR in transient operation requires innovative controls. Improvements should also come from developing better flow-measurement and flow-calculation methodologies.

EGR effectiveness for a multiple-cylinder engine is dependent on even distribution between the cylinders. Technology development in this area will provide significant improvement in NO_x reduction. Additional research into EGR-based acid formation and behavior under in-cylinder conditions is needed. Effective ways to prevent EGR condensation under all ambient and engine operating conditions must be developed.

Future proposed emission levels forcing particulate aftertreatment will make it important to reconsider the viability of the low-pressure loop EGR. Temperature requirements for some aftertreatment devices will require careful optimization of EGR rates across engine speeds and loads.

D.2.7 Engine Components and Subsystems

Improvements of individual engine components and subsystems, especially the injection system and turbocharging, will provide significant contribution to overall engine performance and emissions. Fuel-injection development includes achieving higher pressure for all speeds and loads and greater flexibility with the injection event. Ways of reducing manufacturing variability need further investigation. Fast actuators need to be developed, including more powerful solenoids and smart materials.

Transient response of the turbocharger is an important design characteristic and will be improved through the introduction of lightweight wheel materials and shaft bearings with lower friction. More efficient blade shapes need to be developed. Development is also needed for cost-effective, reliable designs of VGTs and dual-stage turbochargers and alternate boosting machinery. Approaches that provide some

additional flexibility in boosting, such as electric-assisted machines, can help with EGR control as well as air handling.

D.2.8 Aftertreatment

While development and selection of the exhaust gas aftertreatment package is a subject of another section, its success is only possible within an integrated engine/aftertreatment system. Specific engine-related issues include selection of the proper exhaust temperature regimes, NO_x/soot ratio, reductant and emission spatial and temporal distribution, tuning of the late cycle fuel injection as a reductant, implications for the selection of the EGR approach and packaging.

D.2.9 Variable Valve Actuation (VVA)

Heavy-duty diesel engines with their relatively narrow speed range and tough durability requirements will not be the initial application for VVA; smaller engines may achieve significant, positive trade-offs in fuel economy vs emissions. VVA approaches include electrohydraulic, electromagnetic, and hydromechanical systems. Research would include VVA's parasitic losses, energy consumption, reliability, and production cost.

D.2.10 Materials

Technological improvement in future diesel engines will require better or new materials. A general need is the improvement of material-characterization tools. In many cases, research would be improved with the introduction of on-line material-characterization methods and tools to be used during engine testing.

D.2.11 Sensors

The use of new engine sensors is addressed in the controls section. The development of novel sensors is an important subject on its own. New, more robust, more accurate, environmentally friendly, durable, reliable, and less-expensive ways of measuring temperature (especially exhaust), pressure (especially high cylinder pressure), and concentration of chemical species are needed. Self-diagnostics of sensors is another important area of research.

D.2.12 Vehicle Integration

Many research areas are related to power-train and vehicle integration. These include interactions between engine braking and vehicle braking systems, trends toward engine weight and size reduction, implications of required storage space for additional fluids on board, and much more.

D.2.13 Manufacturing

Manufacturing processes require improvement to realize the potential of many new technologies for future diesel engines. Precision and reliable machining is needed for fuel injector tip holes and for a wider range of hole shapes. The engine-block and cylinder-head casting process must be improved to allow for thinner walls, elimination of core shift, strategic cooling, and more aggressive intake port shapes. Ceramic manufacturing, especially ceramic machining, needs to be improved to deliver on the promise of ceramic structural components. Cost-effective piezoelectric stack manufacturing may be a barrier to introduction of novel fuel-injection systems.

D.3 ENGINE SYSTEM INTEGRATION VIA VIRTUAL METHODOLOGY DEVELOPMENT

Future aggressive engine performance targets require an integrated test/simulation "Wired" approach, incorporating sophisticated virtual (simulation) and experimental methodologies to define a pervasive roadmap. Integral pieces of the overall engine system simulation toolbox include engine structural design,

charge-air, fuel-injection, combustion, cooling and lubrication systems. Enhancements are paramount as physical-process understanding improves with tool integration and refinement to allow realistic modeling of system interactions. To achieve these performance targets, the integrated tools will focus on individual components as well as the total engine system. Diesel-cycle simulation, materials and structural analysis, engine fluid system, air-handling system, fuel-injection system, in-cylinder combustion, engine and aftertreatment system, and underhood thermal-management modeling are all individual simulation tools.

D.3.1 Diesel Engine Cycle Simulation

Cycle simulation is perhaps the most powerful available system tool for addressing basic engine design and engine calibration parameters as related to overall engine performance. Deficient current submodels include combustion, heat transfer, flow dynamics and distribution at complex junctions, turbocharger turbine modeling, and idealized actuator control as well as a lack of control strategy models. Integrating more complex software [higher-resolution computational fluid dynamics (CFD), heat transfer, chemical kinetics, or control] to reconcile these deficiencies will improve cycle simulation resolution and predictive capabilities.

D.3.2 Engine Fluid System Modeling

Intelligent control of fluid systems is implied by the competing demands to achieve the fuel efficiency, emissions, safety, and life-cycle cost targets. An integrated fluid management system balances available cooling capacity against cooling requirements within the engine and points toward intelligent cooling resource utilization. This tool is essential for properly addressing engine thermal management and its impact on EGR cooling, lube oil temperature, and required pump and fan loads with strong implications concerning system controls and strategic heat rejection. This will require integration and special attention on proper interfacing with vehicle- and engine-level boundary and initial conditions.

D.3.3 Materials and Structural Modeling

Fuel efficiency, life-cycle costs and reduced size and weight pressures have driven the use of lighter-weight structures of steel, aluminum, magnesium, and plastics. These lightweight materials and improved designs mandated improved engineering analysis. Rapid-prototyping capability of the forward-engineered design is critical to accelerate commercialization potential. The greater thermal-mechanical loading associated with achieving future engine performance targets will require much greater model resolution than is standard today to ensure eventual convergence toward a robust design.

D.3.4 Air-Handling System Modeling

The engine's air throughput system has direct impact on combustion air utilization and EGR effectiveness toward meeting both high thermal efficiency requirements and associated emission standards. Exhaust and induction systems require tuning for delivery of proper in-cylinder EGR distribution, necessary in-cylinder flow distribution, and proper residual gas distribution while controlling in-cylinder heat transfer. Many complex interactions between the induction, exhaust, EGR, and reciprocator need to be addressed at a system level. Corresponding modeling tools that address associated issues with each subsystem and its interfaces will provide a mechanism for optimization of the engine.

D.3.5 Fuel-Injection System Modeling

The historical improvement in power and efficiency of diesel engines is due, to some extent, to advances in fuel-injector technology. Adequate in-cylinder mixing between fuel and air is strongly dependent on the characteristics of the fuel injector. Because fuel-spray characteristics such as velocity, spray angle, and droplet size and dispersion are critical factors in fuel-air mixing, it is important to understand the relationship between these characteristics and injector design. CFD modeling of the flow inside and at the exit of injectors could provide important information about how design parameters actually relate to spray

characteristics. Control strategy and actuator-modeling capability extend the analysis to the entire fuel-injection system, allowing analysis of cylinder-to-cylinder differences caused by calibration or concept designs. There are still wide gaps in the understanding of the physical processes inside the injector and how they relate to the subsequent formation of liquid sheets and drops beyond the injector exit. High-resolution CFD models of a fuel injector could provide both fundamental and specific design information for the next generation of high-efficiency, low-emission engines.

D.3.6 In-Cylinder Combustion Modeling

This aims at dissecting root causes of emission formation in evolutionary combustion systems and evaluation of promising revolutionary, novel systems without initial hardware development. Current models offer tremendous insight of the combustion event but require continual tuning to maintain predictive capability. Beyond the injector, diesel-combustion performance is determined to a large extent by the efficiency with which the liquid fuel droplets evaporate and mix with the air. Thus it is important to have computational models that simulate the impact of droplet characteristics and airflow features. At a minimum, this type of simulation requires consideration of the three-dimensional continuum turbulence associated with both flows. Furthermore, the heat released during combustion can modify the turbulence in the flow, resulting in a fully coupled evolution of the fluid-flow and chemical processes. Current understanding of this type of flow field is limited, and future augmentation in engine performance will require significant further improvement in our understanding of how the flow and combustion processes couple together.

D.3.7 Engine and Aftertreatment System Modeling

Often, the simultaneous goals of high fuel efficiency and low emissions are strongly at odds. This is especially true for diesel combustion, which is carried out under lean conditions that do not favor the subsequent reduction of NO_x in a catalytic converter. An unprecedented level of engine and aftertreatment integration will be required to achieve engine system durability simultaneously with future required emission reduction and thermal efficiency targets. Models of the catalytic converter's dominant physical and chemical processes could greatly speed the development of new generations of catalyst technology. There is also a strong need to accurately model the flow, mass transport, and heat transport in the exhaust gases flowing to the converter and the coupling between these macroscopic flow effects and the chemical processes occurring on the catalyst surface.

Integrating engine system thermal, chemical specie, and flow effects with the aftertreatment device surface kinetics simultaneously in high detail should offer the most accurate predictions about the impact of design changes or changes to the catalyst properties. Low-order aftertreatment models offer another approach for modeling the complete engine and aftertreatment system over short transient events. Such information could also be valuable for assessing the effectiveness of various types of on-board emissions sensors. A third major modeling need for diesel emissions control is to simulate the mechanisms for catalyst regeneration, degradation, and/or poisoning by engine behavior.

D.3.8 Underhood Thermal Management

The use of cooled EGR is an example of the approach to maintain thermal efficiency while reducing NO_x trade-off. Often, increasing the amount of EGR to achieve the transient and steady-state NO_x emissions targets is a significant step toward improving thermal efficiency and vehicle fuel economy. However, this yields higher heat rejection that conflicts with aerodynamic enhancements via reducing frontal area and the airflow to the underhood area. Designing the underhood systems and components such as engine, fans, radiators, heat exchangers, and intake manifolds requires optimal location and shapes as well as optimization of the thermal performance of the power system. This complicated analysis requires integration of high-fidelity models of thermal-hydraulic processes that stretch the state of the art in CFD and high-performance computing. The computational model should integrate thermal models for

convective, conductive, and radiative heat transport as well as integrate models for critical heat-management system components, including cooling fans and radiators.

D.4 EXPERIMENTAL METHODOLOGY DEVELOPMENT

Experimental testing is one of the most expensive and time-consuming aspects of the engine R&D process. Truck engine companies maintain test facilities that typically include dozens of performance test cells, durability test stands, specialized test facilities, and technical support personnel. There is a constant demand for providing more accurate and higher-value data in a shorter time.

For example, future regulations call for a tenfold reduction in emissions. Current measurement is not capable of measuring these low levels reliably. In fact, the general accuracy of the measurements is the same order of magnitude as the absolute levels that will need to be measured. Accuracy of the instrumentation needs to be improved, and types of the instruments and methodology of emissions testing may need to be invented.

A more direct, cost-effective real-time measurement of particulates is needed. Another issue related to particles is particulate size distribution. Instrumentation capable of analyzing exhaust particle size in a practical fashion needs to be developed.

Modern engine performance test facilities rely on real-time combustion analysis equipment. Integration and comparison of the processed data sets is a time-consuming and tedious task for the test engineer. Valuable development time may be reduced and errors may be eliminated if a major initiative is undertaken to integrate test cell data acquisition and post-processing equipment into combustion analysis software. Significant reductions in the duration of the test programs will be realized with better-automated test protocols. Another benefit of this is the improvement in the accuracy of data and test-to-test variability. The most immediate need is in the area of performance development testing.

The advent of virtual testing is changing the nature of the experimental testing. Instead of providing large amounts of data for further analysis by a development engineer, experimental testing is becoming a tool for model-input parameters and validation. Only carefully designed experiments covering few hardware configurations are run on a limited number of test conditions. This paradigm shift will undoubtedly create new requirements for the experimental testing.

Most engine systems and components developments are tested as part of the overall engine package, expending valuable resources and risking failures of expensive prototype engines. The alternative approach is the development of test rigs and fixtures for evaluation of individual engine subsystems. The current use of this approach is limited due to the lack of full correlation between the performance of a component on a fixture and on an engine. Development of new, better methodologies for subsystems such as fuel-injection systems, turbochargers, cylinder kits, bearings, and valve trains will remove that barrier.

Examples of other areas of engine development processes that could benefit from better experimental methodologies include heat rejection measurement, EGR condensation detection and quantification, reliable means of data transmission from moving components, real-time wear measurements, and motion measurements of fuel-injection components.

APPENDIX E

AFTERTREATMENT/EMISSION CONTROL

APPENDIX E

AFTERTREATMENT/EMISSION CONTROL

E.1 STATUS OF EMISSION CONTROL TECHNOLOGY

E.1.1 NO_x Control

E.1.1.1 NO_x Adsorber-Catalysts

A NO_x adsorber-catalyst is a flow-through emissions control device that has the potential to significantly lower NO_x, HC, and CO emissions from diesel engine exhaust. A NO_x adsorber catalyst consists of two principal components: a NO_x adsorbent and a three-way conversion catalyst (the two components are actually on the same substrate material). Periodically, NO_x stored by the adsorbent is released and reduced to N₂. This process requires a momentary exhaust gas composition that is depleted of oxygen but contains CO and HC.

An engine management system is thus critical to the operation of a NO_x adsorber. The system must determine when the NO_x adsorbent is approaching saturation and then trigger the change in engine operation that results in generation of the rich condition required for release and reduction of the stored NO_x. The duration and “richness” are critical to avoid excessive fuel use and HC breakthrough while still accomplishing complete regeneration (DECSE 1999).

The NO_x adsorber-catalyst is very sensitive to sulfur, its effectiveness dropping quickly with fuels containing 16 ppm or more of sulfur. In programs utilizing 3-ppm sulfur fuel, NO_x reduction levels of over 90% have been achieved for fresh devices in both engine test cells and experimental vehicle systems, the latter over a transient cycle (DECSE 1999, DVECSE 2000). In heavy-duty engine transient tests, experiences have shown conversion efficiencies of about 60%. While these results provide encouragement, extensive R&D work is still needed in optimizing the NO_x adsorption/desorption and conversion functions, and defining and optimizing sulfur removal (“desulfurization”) techniques and strategies, as well as examining the use of sulfur traps upstream of the catalyst. The interactions with DPFs in a full system are in the early stages of exploration. The NO_x adsorber-catalyst carries a substantial fuel-economy penalty due to frequent NO_x regeneration, although further optimization is expected to bring this to a tolerable level (a few percent). Furthermore, durability of the adsorber-catalyst is far from established.

E.1.1.2 Urea Selective Catalytic Reduction (SCR)

SCR of NO_x using ammonia or urea has been used for many years in stationary diesel engine applications. In the SCR process, NO reacts with the ammonia, which is injected into the flue gas stream before the catalyst. Due to the toxicity and handling problems with ammonia, the most widely accepted and commercialized reductant is urea, CO(NH₂)₂ (Ecopoint 2000). Water solutions appear to be the preferred form of urea. Different SCR catalyst systems based on platinum, vanadium oxide, or zeolites have different operating temperature windows and can be selected for a particular SCR applications. SCR catalysts have not been used commercially for diesel vehicles due to their complexity, large size, safety concerns, and ammonia/urea injection control issues (Ecopoint 2000). SCR systems would further require an anti-defeat system to ensure that the vehicle was not operated without a urea supply. SCR technology, which utilizes an oxidation catalyst to facilitate NO_x reduction to achieve high control efficiencies, requires the same low sulfur levels as the NO_x adsorber technology (MECA 2000). Certain SCR technology designs are less sensitive to sulfur, but very low sulfur fuel allows even these technologies to achieve the highest NO_x reductions and allows for the full optimization of the engine/exhaust control technology system and potential fuel economy improvements.

Numerous SCR experiments and demonstrations are in progress. NO_x control efficiency has been recorded at 80 to 90%, with 70% being more representative in transient operation. Durability is being determined by the numerous field tests, largely in Europe, but now getting under way in the U.S. (Miller 2000).

E.1.1.3 Hydrocarbon (HC) SCR

Also known as “lean NO_x catalysis,” HC SCR typically utilizes diesel fuel or a HC readily derived from fuel as the reducing agent for NO_x in the presence of a catalyst. Other hydrocarbons, ethanol for instance, have been used in commercial SCR systems for stationary power plants. After many years of experiments and tests of thousands of catalyst formulations, the probability of HC SCR achieving 90% NO_x conversion over a sufficiently wide temperature range is presently low. NO_x reductions of 80% or more have been achieved in research environments in narrow temperature ranges, but the scale-up systems have exhibited only 30% conversion at best over test cycles. The technology remains attractive because of its passiveness, requiring no regeneration and likely no second fluid to replenish. The keys to success appear to be getting the optimum HCs manufactured from on-board fuel, and greatly improving the understanding of the HC utilization/NO_x reduction mechanisms. Lean NO_x catalysts exhibit a moderate degree of sensitivity to sulfur compounds from fuel.

E.1.1.4 Plasma-Assisted NO_x Catalysis

Non-thermal plasma-assisted catalytic reduction of NO_x is a relatively new technology that has shown promise for enhanced NO_x reduction. Up to 80% NO_x reductions have been observed on simulated exhaust and 55% in real exhaust (SAE 1999).

The plasma is believed to enhance NO_x reduction over catalysts via a two step process (Penetrante 1997). First, the plasma is a strongly oxidizing environment in which NO is converted to NO₂, as well as accomplishing some partial oxidizing of the HC reductants, if present. The second step is reduction of NO₂ to N₂ by the HC over a catalyst. It is widely understood that in lean NO_x catalysts, NO₂ is the primary species that reacts with HCs, so the catalyst must typically achieve both steps unless a plasma is present. By using plasma one can separate the oxidation and reduction function of the catalyst to open the door for several new lean-NO_x catalyst systems.

Plasma-assisted catalyst NO_x control is unproven in transient test cycles. Limited testing on light-duty vehicles has been performed for PM removal. The energy penalty (from electrical energy and reductant addition) is possibly higher than other NO_x reduction technologies (about 5% total). Although both NO_x and particulate removal by plasmas have been demonstrated separately, a system with combined function for NO_x and PM removal has not been developed or tested.

E.1.2 Particulate Matter (PM) Emission Controls

E.1.2.1 Catalyst-Based DPF

Control technologies for PM have seen significant progress in recent years to the point of limited commercial application. Catalyst-based DPFs used on engines operated on low-sulfur diesel fuel can achieve PM and toxic HC reductions well in excess of 90%. Where diesel fuel containing less than 10 ppm sulfur has been used, filter technology has demonstrated impressive durability, in some applications continuing to provide excellent particulate removal at 600,000 km of vehicle operation (Warren et al. 2000). The ability of catalyst-based DPFs to reduce hydrocarbon emissions by greater than 95% has also been clearly established (Letavec et al. 2000).

Two types of DPFs are well-developed and are engaged in field trials: the CR-DPF and the catalytic DPF CDPF. For both, PM is removed from the exhaust stream by collecting on a ceramic wall-flow filter element. Unlike other diesel emissions control devices, primary removal of the targeted pollutant (PM) is

fixed by the physical characteristics of the filter medium and is relatively unaffected by the engine operating conditions. The critical issue, instead, is the cleaning or regeneration of the DPF (by oxidation of the collected PM) to prevent the DPF from plugging.

The CR-DPF accomplishes regeneration by continuously converting engine-out NO to NO₂ over an oxidation catalyst placed upstream of a DPF (here, the DPF has no active catalyst on it). The NO₂, which is a more effective low-temperature oxidizing agent for diesel PM than oxygen, completes the regeneration. Sulfur in the exhaust however, can be oxidized over the CR-DPF, forming sulfates, which are measured as PM. Sulfur oxides also compete for the critical NO and NO₂ reaction, making the regeneration characteristics less effective (Liang et al. 2000).

The CDPF regenerates by using a catalyst coating on the DPF element to promote oxidation of the collected PM using available oxygen in the diesel exhaust. Sulfur in the exhaust can be oxidized over the CDPF to form sulfates.

Exhaust-gas temperature and fuel-sulfur level are critical factors that affect the performance of both types of DPFs (CR-DPF and CDPF). The poor regeneration at low temperatures, and filter plugging by ash (mostly from engine lubricating oil) over time are among the few remaining shortcomings of the technology. The ash can be removed by backflushing with air, but the required frequency is not fully established.

The catalyst-based DPF is additionally attractive because it is a self-contained, passive device that can be retrofitted to diesel-powered vehicles that exhibit sufficient exhaust heat to ensure regeneration.

E.1.1.2 Diesel Oxidation Catalysts (DOCs)

DOCs employ technology that dates back to the early stages of gasoline vehicle emission control in the early 1970s. When formulated for use in diesel vehicles, these catalysts are effective in removing HC, CO, and the soluble organic fraction of PM, which can be on the order of 30% or more of the total PM. They also diminish the usual pungent odor of diesel engine exhaust. DOCs are used on off-road vehicles, diesel-powered trucks, and cars worldwide. For the future, additional uses may be as components within total NO_x and PM control systems where oxidation or temperature rise is needed. DOCs, of course, will convert SO₂ to sulfate PM, this being their most significant sensitivity to fuel sulfur. Sulfur, as well as phosphorous and zinc from the lubes and fuel, will tend to poison and deactivate a DOC over time; but the durability of DOCs has been acceptable for widespread use in vehicles using 500-ppm sulfur fuel.

E.1.1.3 Plasma Reduction of PM

Plasma devices for PM removal have been the subject of numerous experiments, and full-scale prototypes are emerging in test programs. In laboratory experiments, they have been very effective in PM control (Fanick et al. 1995).

E.1.1.4 Non-Catalytic DPF

There have been numerous proposed non-catalytic systems for PM control that relied on a trapping process and then heating by external means. Typically, extra fuel was burned to raise the temperature of the trap to burn the stored carbon. The fuel-economy penalty is rather prohibitive for most applications. Other systems use a fuel additive that deposits a material on the filter to lower the light-off temperature (Psaras and Summers 1995) and to promote regeneration. In addition, a filter made of a ceramic paper has been developed whose material of construction couples efficiently with microwave energy. The filter can be regenerated on demand with externally supplied microwave energy. It has particular attractiveness in applications like small passenger cars, where the exhaust temperature may not always reach the regeneration temperature required by passive devices. Prototypes of this device have been evaluated in

engine test cells and on vehicles and have shown good filtering efficiency (over 80%) and the ability to regenerate as intended (Nixdorf 2000).

E.1.3 Enablers for Emissions Controls

E.1.3.1 Sulfur Traps

A sulfur-trapping system is attractive to protect the NO_x or PM control devices that exhibit high sensitivity. Even the 15-ppm fuel sulfur cap proposed by EPA may not be low enough to ensure the needed durability of devices such as NO_x adsorbers. Furthermore, sulfur compounds in the lubricant also give rise to notable SO₂. Sulfur traps or “guard beds” are similarly used in fuel refining to protect the process catalysts. Sulfur traps for diesel emission control systems are being developed, and at least in one case are being integrated with NO_x adsorbers (Parks et al. 1999).

E.1.3.2 Reductant Generation and Deposition Systems

NO_x catalysts and adsorber-catalysts function with higher efficiency if the reducing agent is a prescribed compound other than diesel fuel. Mixtures of hydrogen, CO, and specific hydrocarbons, have been found to be among the best reductants. Devices such as diesel fuel reformers could provide a higher level of NO_x control by generating reductants on the vehicle. Reformer technology is mature for some applications using natural gas but is not well developed for reforming diesel fuel. Optimizing fuel constituents for this purpose has received little investigation. Experiments with in-cylinder late fuel injection have been conducted to achieve a similar effect, that is, producing a more tailored exhaust for NO_x reduction. These have shown trends in the right direction, yet not a large enough effect.

E.1.3.3 Sensors

NO_x and PM sensors are critical for emission and aftertreatment control. Either sensor, with an adequate response time, can aid in the control of engine out emissions depending on the control strategy of the engine manufacturer. Unfortunately, a PM sensor does not currently exist and NO_x sensors are inadequate in the current configuration.

Current electrochemical NO_x sensors have many shortfalls (slow response time, approximately 500 ms; poor poison resistance; inadequate selectivity) but are based on a proven, robust technology. This type of sensor could be considerably faster and more dependable with continued research. However, the electrochemical NO_x sensor will not be able to meet the response times necessary to be used as a control sensor (less than 15 ms). For aftertreatment systems such as SCR, NO_x sensors are being integrated for control and diagnostics. Their durability remains less than desired.

APPENDIX F

HYBRID ELECTRIC PROPULSION TECHNOLOGIES

APPENDIX F

HYBRID ELECTRIC PROPULSION TECHNOLOGIES

Hybrid electric propulsion systems may be needed to meet performance and efficiency goals for both commercial and military vehicles. A “crosscut” R&D effort is needed to develop enabling technologies for hybrid electric propulsion systems. The status of technology, technical targets, barriers, and technical approach have been summarized in the 21st Century Truck Roadmap.

This appendix provides additional information about the current status of hybrid electric propulsion system technologies. The current status of electric motors, batteries, power electronics, and electrical safety are further discussed to establish a baseline for improving performance and efficiency of hybrid electric components and systems.

F.1 STATUS OF ELECTRIC MOTOR TECHNOLOGY

Electric motors capable of driving heavy-duty HEVs are presently offered by numerous suppliers, including Allison, Emerson Electric, General Electric, Hughes, ISE Research, Kaman, Lockheed Martin, Northrop-Grumman, Reuland Electric, SatCon, Siemens, Solectrica, Systronix, and Unique Mobility. Rated motor power for a variety of commercial HEVs are illustrated in Fig. F.1.

Several types of motors have been proposed for hybrid electric drive systems, many of which merit further evaluation and development. Certain types of motors may work better for specific vehicle applications or performance requirements than others.

At least five major electrical design options exist, including classical DC-commutator type, permanent magnet, switch reluctance, AC-synchronous, and AC-induction motor designs. Each of these options has advantages and disadvantages with respect to size, weight, efficiency, cost, complexity, and other considerations.

Motor generators can be configured before or after the transmission. Series HEVs typically have larger motors with higher power ratings because the motor alone propels the vehicle. In parallel hybrids, the power plant and the motor combine to propel the vehicle. Motor and engine torque blending is usually accomplished through couplings and planetary gear sets.

Air-cooled motors are simpler and generally less expensive than liquid-cooled motors. Liquid-cooled motors may also require more cooling-system maintenance than air-cooled versions require. However, liquid-cooled motors are generally smaller and lighter for a given power rating. Various coolant options exist for liquid-cooled motors, including water, water-glycol, and oil.

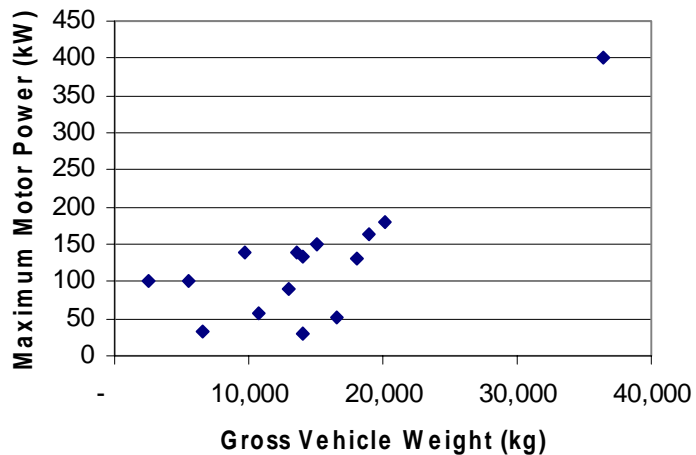

Fig. F.1. Motor power for heavy-duty hybrid electric vehicles.

Wheel motors, in which at least one wheel on each side of the vehicle is driven directly by its own motor, require more extensive changes to the vehicle but offer the potential benefits of increasing motive drive efficiency, reducing vehicle weight, and lowering the chassis. Wheel motors allow independently controllable four-wheel traction control to potentially improve vehicle performance and safety. Fail-safe design of wheel motors must be considered such that operational problems with any one motor does cause a loss of vehicle control. Wheel motors have been used in a small number of heavy-duty HEV designs, but further systems analysis is needed to investigate efficiency, weight, and packaging issues.

Heavy-duty vehicles are driven with motors operating at voltages ranging from less than 300 VDC to more than 600 VDC. Higher operating voltages enable lower operating currents, reducing I^2R losses and generally reducing inverter costs. However, higher-voltage systems require more batteries and more complex DC-to-DC conversion if the main battery pack is used to drive lower-voltage (e.g., 12 VDC or 24 VDC) subsystems.

F.2 STATUS OF BATTERY TECHNOLOGY

Although a few production HEVs with advanced batteries have been introduced in the market, improvements in life-cycle economics, power, and energy efficiency are needed, especially for commercial and military vehicles that have longer service life requirements than light-duty vehicles.

Desirable attributes of high-power batteries for HEV applications are high-peak and pulse-specific power, high specific energy at pulse power, a high charge acceptance to maximize regenerative braking utilization, and long calendar and cycle life. Developing designs and methods to balance the packs electrically and thermally, developing accurate techniques to determine a battery's state of charge, developing abuse-tolerant batteries, and improving recycleability are additional technical challenges.

Lead acid batteries are currently used in many electric vehicles and have been used in hybrid transit bus applications. Lead acid batteries can be designed for high power and are inexpensive, safe, and reliable. A recycling infrastructure is in place for them. But low specific energy, poor cold temperature performance, and short calendar and cycle life are still impediments to their use. Advanced high-power lead acid batteries are being developed for HEV applications.

Although nickel-cadmium batteries, used in many electronic consumer products, have higher specific energy and better life cycle than lead acid batteries, they have lower specific power for HEV applications. The toxicity of cadmium is of concern and may limit the widespread use of these batteries.

Nickel-metal hydride (NiMH) batteries, used routinely in computer and medical equipment, offer good specific energy and specific power capabilities. Their components are recyclable, but a recycling structure is not yet in place. NiMH batteries have a much longer life cycle than lead acid batteries and are safe and abuse-tolerant. These batteries have been used successfully in production electric vehicles and recently in low-volume production HEVs. The main challenges with nickel-metal hydride batteries are their high cost, high self-discharge and heat generation at high current, the need to control losses of hydrogen, and their low cell efficiency.

Lithium ion batteries are rapidly penetrating into laptop and cell-phone markets because of their high specific energy. They also have high specific power, high energy efficiency, good high-temperature performance, and low self-discharge. Components of lithium ion batteries could also be recycled. These characteristics make lithium ion batteries suitable for HEV applications. However, to make them commercially viable for HEVs, further development is needed, including improvement in calendar and cycle life, a higher degree of cell and battery safety, abuse tolerance, and cost reduction.

Lithium polymer batteries with high specific energy, initially developed for electric vehicle applications, also have the potential to provide high specific power for HEV applications. The other key characteristics

of the lithium polymer batteries are safety and good cycle and calendar life. The battery could be commercially viable if the cost is lowered and batteries having higher specific power are developed.

ZEBRA batteries, developed in Europe, have been demonstrated in more than 50 grid-connected hybrid and diesel HEVs. They have a high specific energy (more than 90 Wh/kg) and a specific power of 160 W/kg. The battery modules have built-in monitoring systems for each battery pack, and the cells fail similarly to NiCd batteries in a low-resistance mode, which does not initiate a string problem. This characteristic makes the batteries reliable and tolerant to abuse. The battery temperature must be maintained, which causes a self-discharge rate that varies depending on climate. (Cost of batteries is currently \$840/kWh, the target is \$420/kWh CDN or \$560/kWh and \$280/kWh.)

Among the batteries available today, lead acid and nickel cadmium batteries are inexpensive, available, and reliable. From a recent survey, most heavy hybrid vehicles use these two battery types in their vehicles (Table F.1). The capacity of the battery packs for heavy-duty commercial vehicles typically ranges from 20 kWh to 70 kWh (Fig. F.2). A small number of prototype vehicles have used ultra-capacitors. Hybrid electric buses with flywheel energy storage are in use in several services in Germany. A prototype hybrid electric bus with a flywheel energy storage unit is being built for Houston Metro.

Table F.1. Type of energy storage used in heavy-duty hybrid electric vehicle projects

Energy storage type	Europe and Asia	USA
Lead acid	8	12
Nickel cadmium	7	5
Other (including ultra-capacitors and flywheels)	2	2
Total projects surveyed	17	19

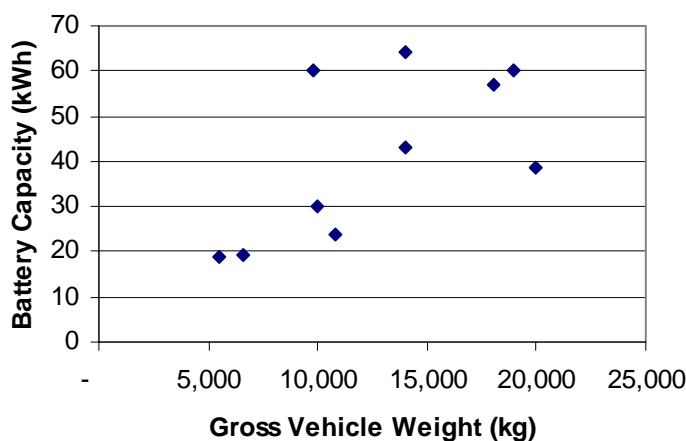

Fig. F.2. Battery pack capacity for heavy-duty hybrid electric vehicles.

A summary of the current status of these battery types is shown in Table 4.16. HEV batteries need to have high power and adequate specific energy (energy per weight) and energy density (energy per volume),

low cost (per Wh, W, or unit), and longevity (years) and cycle life (number of cycles). Safety and reliability must also be considered. Lead acid and lithium ion batteries could deliver a very high power, although NiMH batteries may also have adequate power and life. Both Honda Insight and Toyota Prius use NiMH for their energy storage systems. NiCad batteries are reliable, provide good energy and adequate power, and have reasonable cost. Lithium ion batteries can provide good energy, power, and eventually low cost, however, life and safety issues remain. More data are needed on cycle life for discharge between 65 to 60% SOC.

A significant amount of engineering effort is needed to package the electrical energy storage system in vehicles. The system must be continuously monitored to ensure proper performance. In addition an electronic control system and a thermal management system are needed for controlling and balancing the pack to ensure optimum performance and safe operation. In the last few years, battery and vehicle manufacturers and system integrators have worked together on the development of packaging and management systems using computer-aided design tools and electrical simulation software. Most of the energy storage systems in current prototype or production vehicles have a management system.

F.3 STATUS OF POWER ELECTRONICS

The U.S. industry is currently in need of suppliers and power electronic products for commercial and military HEV applications. The power electronics system plays a crucial role in the conversion and distribution of power and energy in automotive applications. The selection of power semiconductor devices, converters/inverters, control and switching strategies, packaging of the individual units, and system integration are very important for the development of an efficient, high-performance truck of the future.

The advancement of the technology of power semiconductor devices led to the development of lightweight, small-size, high-efficiency power conversion systems. Thyristors, gate turn-off thyristors (GTOs), power metal-oxide semiconductor field-effect transistors (MOSFETs), and insulated-gate bipolar transistors (IGBTs) are being used at different power levels and voltages depending on the application. Thyristors are mainly used for AC to DC power conversion and have low voltage drop compared with other devices. GTOs, MOSFETs, and IGBTs are used for conversion of DC to AC power because they can be turned off more easily than thyristors can. GTOs, are being used in high-voltage, high-power applications and they need an elaborate gate drive circuit for turn-off. MOSFETs are being used mainly up to voltages of about 200 V. Higher-voltage devices have higher on-resistance. Also, as the current increases, the on-resistance of the device increases, leading to higher power dissipation at higher currents. IGBTs have the high input impedance and high-speed characteristics of MOSFETs with the conductivity characteristics of bipolar transistors. IGBTs are being widely used up to about 1,000 V; in limited applications, higher than 1,000-V devices are used.

The inverter strategies for controlling AC motors are being mainly classified as hard-switched inverters and soft-switched inverters. They are also classified as voltage-source and current-source inverters, depending on the type of the input source. The hard-switched inverters are simple and easy to control. However, unlike soft-switched inverters they have more switching losses and generate electromagnetic interference (EMI). The commonly used three-phase hard-switched inverter is the three-phase bridge voltage source inverter. There are several versions of the three-phase soft-switched inverters based on the resonant power conversion. Soft-switched inverters have low switching losses and generate less EMI than the hard-switched inverters do. The inverters need to be operated at as high a frequency as possible to obtain less acoustic noise and to generate low ripple current in the motor current waveforms. But higher switching frequency results in higher switching losses and hence reduces the efficiency of the system. The switching frequency is also limited by the switching times of the power devices.

The stability and dynamic performance of any system depends on the closed-loop control strategy. The closed loop control strategy depends on the type of the AC machine and the required control

characteristics. Field orientation control (or vector control) has become the standard strategy for high-performance systems. Field orientation control enables independent control of torque and flux in all AC machines. There are various versions of the field orientation control, such as rotor flux orientation, stator flux orientation, and air gap flux orientation. The pulse-width modulation (PWM) strategies and vector control strategies are implemented by using high-performance microprocessors or digital signal processors. To have intelligent control systems, fuzzy logic and neural network technologies are being incorporated into the machine control and are being interfaced with the rest of the complete vehicle system controllers. Sine-triangle modulation techniques and space vector modulation techniques are the commonly used PWM strategies to generate three-phase variable voltage and frequency at the output of the inverters. These strategies allow for smooth control of the output power, lower harmonics at the inverter output, and simpler implementation.

In addition to the power devices and controllers, capacitors, inductors, bus bars, thermal systems, and other components form a major portion of the power electronics unit. In the past ten years, the technology of magnetic components and capacitors has significantly advanced to be used in high-frequency power electronics applications. The packaging of all these units as one system has significant challenges. The U.S. Department of Energy, U.S. Navy, and other organizations have funded the development of Power Electronics Building Blocks (PEBBs), to develop modular types of power electronics systems ranging from 10 kW to several megawatts of power.

The DC-DC converter technologies have significantly advanced over the years, and now they have become commodity units for many types of applications. However, they are still under development stage for automotive applications.

F.4 STATUS OF ELECTRICAL SAFETY

Electrical safety requirements must encompass acceptable design practice, accessibility, durability of safety provisions, human factors, and risk management. Electrical vehicle technology has led the way for development of hybrid vehicle safety technology to a substantial extent. However, the greater extent and complexity of high-voltage components and cabling in HEVs requires extension of safe practices. (For purposes herein, “high voltage” shall be considered to be any voltage exceeding 50 volts DC or 50 volts rms AC.) Electrical safety can be considered in three subcategories: functional, personnel, and hazard identification and mitigation.

Functional safety includes establishing a product safety checklist and design practice, ensuring crash/rollover isolation, integrating of low-voltage accessories, and conducting failure effects and sneak-path effects analysis. The guiding principle here is, “No normally operating system, or system having a single-point electrical failure shall present risk of injury or death from electrical contact.” Such a requirement has vast implications for design decisions affecting use of chassis ground/double insulation or floating ground/single insulation circuit architectures, architecture of ground-fault monitoring and architecture of safety-related failure monitoring.

Personnel safety includes consideration of emergency disconnects, access door/cover/power interlocks, high-voltage cable/harness routing, high-voltage cable/harness unique identification, maintenance and emergency personnel training, and warning labels. The guiding principles here are “Prevent personnel casual contact with high voltage”; and “Provide training, interlocks, and labeling to guide authorized personnel safely through maintenance and emergency procedures involving high voltage.”

Hazard analysis, tracking, and mitigation are means by which safety objectives may be accomplished. They represent a continuous process. Hazard analysis, tracking, and mitigation are especially effective when applied to technologies in transition from laboratory to marketplace as is the case for HEV technology. Hazard analysis consists of identifying, to the extent possible, all hazards that may result in outcomes of injury, death, or significant loss of property. Analysis proceeds by ranking hazards by a

severity index that relates to the seriousness of the outcome and the frequency with which that outcome is expected to occur. An example matrix for assigning a severity index to (each) outcome is given in Table F.2. The severity index ranges from 1 to 20; 1 represents the most severe risk/loss level and 20 represents the least severe risk/loss level. The severity index is useful for prioritizing risk-mitigating activities, but eventually all risks must be mitigated as required to achieve acceptable loss levels.

Hazard tracking is the formal process by which hazards are recorded as they occur, are recognized, or are identified; progress on their mitigation is monitored, and the ultimate actions for mitigation are documented.

Hazard mitigation is the process of reducing risk/loss to acceptable levels. Mitigation is accomplished by design, protective devices/construction, warning labels, definition of formal safety procedures, and personnel training.

Table F.2. Hazard risk categories

Hazard risk index	Hazard risk category			
	Catastrophic (CAT I) Death or system loss	Critical (CAT II) Severe injury, occupational illness, or major system damage	Marginal (CAT III) Minor injury, occupational injury, minor system damage	Negligible (CAT IV) Less than minor injury, occupational illness, or system damage
Frequent (A) Likely to occur frequently	1 (highest risk)	3	7	13 (medium risk)
Probable (B) Will occur several times in life of system	2	5	9 (medium risk)	16
Occasional (C) Likely to occur sometime in life of system	4	6	11 (medium risk)	18
Remote (D) Unlikely, possible to occur in life of system	8	10 (medium risk)	14	19
Improbable (E) So unlikely, assume it may never occur	12 (medium risk)	15	17	20 (lowest risk)

APPENDIX G

MECHANICAL HYBRID SYSTEMS FOR 21st CENTURY TRUCKS

APPENDIX G

MECHANICAL HYBRID SYSTEMS FOR 21ST CENTURY TRUCKS

G.1 PRIMARY POWER SOURCE—ENGINE AND FUEL CELLS

G.1.1 Engines

The problem with state-of-the-art piston engine designs is that such designs have been refined and optimized for decades for those parameters that have been most important to the consumer, such as low cost, reliability, durability, and power. Unfortunately, there has been little motivation to redesign piston engines from a “clean sheet of paper” for high efficiency or minimum greenhouse gas emissions. The key feature of the engine used in a mechanical hybrid truck is that when it runs, it only runs at or near its peak efficiency throughout its typical driving cycle.

For a mechanical hybrid truck to meet the 21st Century Truck Program fuel-economy goals, the piston engine must be extremely efficient. The goal in the near term is to demonstrate an engine with peak efficiencies in the 40 to 45% range and overall urban cycle efficiency, when used in a hybrid configuration, of around 35 to 40%. The long-term goal is peak efficiency in the 45 to 55% range and an urban cycle efficiency of 40% or greater.

Another desirable goal would be to ensure that the engine could operate on renewable fuels, which will help to minimize total greenhouse emissions even more.

In addition, the piston engine must be extremely clean with respect to conventional exhaust emissions. For most pollutants, such as hydrocarbons and carbon monoxide, this should not present a major problem in that there is some (though not a proportional) correlation between efficiency and lower emissions (the one exception to this is the possibility of multiple restarts with a hybrid truck). The pollutant of most concern, however, is the class of compounds that are referred to as oxides of nitrogen, or NO_x. A small, efficient engine operated at or near peak power can emit high levels of NO_x because of the elevated combustion temperatures and pressures. A major objective of any hybrid engine project should be to identify engine designs that yield maximum efficiency and that meet the proposed 2007 NO_x emission standard of 0.020 grams per brake horsepower.

Affordability is a goal of the 21st Century Truck Program; therefore, the engine must cost as little as possible. This is, of course, an advantage of utilizing a piston engine because, for example, it will not require as many changes relative to current designs as would a fuel cell. The fact that a piston engine for hybrid application (in urban use trucks) will be smaller than today’s truck engines is helpful in this regard. The cost reduction that will accrue based on the size reduction will help offset the increased cost of other hybrid components that are not necessary with current truck designs.

G.1.2 Fuel Cells

As discussed in the “Mechanical Hybrid” section of the Roadmap (see Sect. 4.6.5), a fuel cell could be used as a power source for either type of hybrid storage as well, but it is much more likely to be used in a hybrid electric truck. The discussion of fuel cells is contained in Sect. 4.6.6.

G.2 ENERGY STORAGE—SECONDARY POWER SOURCES (ACCUMULATORS, FLYWHEELS)

Mechanical hybrids store excess energy in a mechanical storage system so it is available to be retrieved and use during other times when the truck needs energy in addition to that provided by the engine.

Mechanical hybrids using pneumatic pressure and hydraulic oil as the working fluid use accumulators to store that energy. Flywheels represent another mechanical energy storage system.

G.2.1 Accumulators

Accumulators are vessels that store energy in mechanical hybrid designs. They perform a similar function to that of a battery in a battery-electric hybrid. Because accumulators are characteristically high-specific-power/low-specific-energy devices, they are best suited to the “load-leveling” or “power-trimming” role they play in the mechanical hybrid design. When the hydraulic system is acting as a pump (running off the engine or recovering braking energy), hydraulic fluid is pumped into the accumulator, where it is pressurized against nitrogen gas in the accumulator, up to many thousands of pounds per square inch. The nitrogen gas acts as a gas spring, storing energy to be utilized later. When the truck needs energy in addition to that provided by the engine, the pressurized hydraulic fluid is released from the accumulator and through the hydraulic motor, producing mechanical power.

Important design parameters for accumulators include weight, specific energy (energy storage density), cycle efficiency (charge/discharge efficiency), cost, safety, and optimum storage pressure. Today, accumulators are used predominantly in stationary applications and industrial mobile applications, such as large earth-moving equipment. Accordingly, little effort has gone into optimizing for certain parameters, particularly weight, specific energy, efficiency, and optimum storage pressure. When more energy storage capacity was needed for a stationary application, the easiest thing to do was to simply make the tank larger, rather than to try to optimize for these other parameters. Consequently, current accumulator designs are heavy, thick-walled steel vessels; therefore, there is great opportunity to optimize accumulator designs for commercial truck applications.

There are many potential trade-offs between the various accumulator design parameters that must be examined. For example, using advanced lightweight materials for the accumulator vessel will reduce the weight of the vessel and will increase the specific energy, but doing so may also increase cost. Higher pressures within the accumulator will reduce the size of the vessel as well as the amount and weight of oil needed for a given level of stored energy but will also require a stronger accumulator, which could tend to increase weight and cost. The considerable ongoing research on improved methods for storing compressed natural gas (CNG) on board trucks should be very helpful in finding answers to these questions about accumulators because the issues are very similar.

For an accumulator with a capacity of about 30 gal (approximately the size that may be needed for a Class 6 hybrid truck), today’s steel designs typically weigh approximately 600 lb (272 kg) empty [the hydraulic fluids will add approximately 150 lb (68 kg)]. The near-term goal is to work with contractors to design and build a filament-reinforced composite accumulator, which could lower the weight down to approximately 400 lb (181 kg) empty. In the long term, the use of ultralight materials in novel accumulator designs suggests the possibility of reducing accumulator weight down to 150 lb (68 kg) empty.

A second critical criterion for accumulator performance is specific energy. Specific energy is directly related to the weight of the accumulator, so one way to increase specific energy is to reduce the accumulator shell weight. A second option is to increase system pressure, which will decrease the amount of oil necessary, again reducing weight. A third option is to increase accumulator capacity by retrieving a higher percentage of energy stored in the accumulator. Today’s designs produce about 0.0004 hp-h/lb and short and long-term goals are 0.0006 and 0.0012 hp-h/lb, respectively.

A third important design parameter is the accumulator cycle efficiency (this is a measure of the energy that is discharged from the accumulator expressed as a percentage of the energy that is provided to the accumulator). Cycle efficiencies for current accumulator designs are approximately 80%. Near-term and long-term goals for accumulator efficiency are 95% and 98%, respectively.

A fourth critical design criterion is cost. The near-term goal is approximately \$1,600 and the long-term goal is to reduce it to less than \$1,000 for high production volumes. The goals of reducing weight and increasing efficiency may require the use of advanced materials and construction, which might drive cost up, but efficiency gains and high production volumes suggest the potential for lowering costs overall. The considerable research now devoted to bringing down the cost of tanks to store CNG should be directly transferable to accumulator design as well.

Safety is an important design parameter as well. Accumulators should not present much of a fire hazard because the nitrogen gas is relatively inert compared, for example, with natural gas stored under similar pressures in CNG vehicles; likewise, the mineral oil used in the accumulators is relatively less flammable than the gasoline stored in conventional vehicles. However, accumulator fluids are under high pressures, and the potential exists for tank ruptures. Fortunately, safety has always been an important design parameter with accumulators. We will investigate ways of segregating the nitrogen gas/mineral oil mixture so that the effects of any possible rupture could be minimized (the energy is stored in the compressed nitrogen gas, not the hydraulic fluid). Certain new materials such as Kevlar and other strong, lightweight fibers may be able to act as a “blanket,” allowing the release of gas pressure but inhibiting the release of high-pressure oil or any vessel fragments. Again, the ongoing research with CNG tanks will provide important assistance in this regard.

A final fruitful area for future research will involve determining the optimum storage pressure. Higher pressures will reduce the size of the accumulator vessel and the amount and weight of oil needed for a given level of stored energy, but will also require stronger accumulators, which would increase vessel weight and cost. An evaluation of the overall impacts on specific energy and cost is essential. The trend with natural gas storage technology has been toward higher pressures based on improvements in design and the use of advanced materials. Just a few years ago CNG was generally stored at pressures of around 2,000 psi, but now CNG tanks are being designed to hold pressures of 3,600 psi and industry researchers have discussed the likelihood of further increases in the future. We will investigate the desirability of accumulator pressures of 5,000 psi and possibly even higher.

To meet the efficiency goal, accumulators should demonstrate 95% efficiency (charge plus discharge) within 2 years and 98% efficiency within 4 years. Weight considerations and heat loss from the compressed nitrogen after regeneration are key barriers to reaching the technical targets.

G.2.2 Flywheels

Modern high-performance flywheels offer several attractive features for use in hybrid vehicles. (For a discussion of electric flywheels, see Sect. 4.6.4.) Flywheels offer outstanding power-handling capabilities with low-to-moderate specific energy; therefore, flywheels are best fitted for applications that demand high power levels and relatively low energy storage, such as a “power-assist” parallel hybrid vehicle. Flywheels provide significant advantages over batteries in the areas of calendar life, cycle life, efficiency, consistent performance at different temperatures and different ages, and ease of measurement of state of charge.

A key design issue will be structural properties of the rotor to permit the high-speed operation necessary for high specific energy and minimization of risks associated with rotor failure. Safety and containment are major issues being addressed by flywheel developers. Understanding of the safety issues (rotor stress design margin, rotor integrity, control of rotor failure modes, and containment system design) is a key barrier to the commercialization of flywheel technology. Selection of rotor material will likely involve the use of fiberglass or carbon-fiber composite materials. The designer will face a trade-off of price and performance.

When used in a mechanical hybrid, the flywheel rotor will be attached to a continuously variable transmission (CVT). Minimization of losses will be a key issue. It will be necessary to operate the

flywheel in a vacuum environment in order to reduce windage drag losses on the rotor surface. Low-drag seals and bearings are essential; magnetic bearings are options.

The energy storage device in a hybrid vehicle needs to have high input and output efficiency to maximize the percentage of energy available for reuse. A round-trip efficiency of 90% within 2 years and 95% within 4 years are targets for achieving the overall power-train efficiency goals.

G.3 POWER MANAGEMENT—VALVE BLOCKS, TRANSMISSIONS, ACTUATORS, AND CLUTCHES

For mechanical hybrid trucks to work efficiently, they must manage power stored in the secondary power source. In many hydraulic hybrid designs components (such as control valve blocks), actuators and clutches are used to manage the flow of power. For hybrid flywheel designs, components such as CVTs, clutches, and conventional transmissions are used to move power. These are examples for general mechanical components commonly seen in hybrid designs. In the future other power management components may be added based on additional research.

To reach the 21st Century Truck Program efficiency goal, overall power management efficiency would need to reach 90% within 2 years and 95 % within 4 years.

G.3.1 Hydraulic Valve Blocks

Hydraulic valve blocks are used to manage high and low pressure. Mechanical valve noise, leakage, low efficiency, and cost are the key barriers to achieving the efficiency goal. The technical approach will begin with investigation of new multifunction control valves.

G.3.2. CVT for Flywheel System

A toroidal system is an example of a power management system used to transfer speed from a flywheel back into the drive shaft. Durability, low efficiency, and cost are the key barriers that must be overcome to reach the efficiency goal. The technical approach will begin with evaluating new CVT systems like the one proposed by Southwest Research Institute (SwRI) for electric hybrids.

G.3.3 Transmissions

Transmissions transfer engine power to the axle and wheels. One of the great advantages of a hybrid truck, with respect to efficiency, is that at any given time the power output of the engine can be independent of the power needed by the truck; the corresponding drawback is that the transfer of power among the various system components becomes more complicated.

In its mechanical hybrid design activities, the 21st Century Truck Program will consider a CVT with the usual movable pulley of variable effective diameter (or other multiple-gear-ratio transmission). The most valuable benefit of a CVT is that by permitting an unlimited number of gear ratios, the engine can be operated at or near its peak efficiency for any given power demand. CVTs have been under development for many years and are now used in a limited number of production trucks. The project will develop a unique CVT configuration that is hydraulically activated and electronically (computer) controlled and that can be integrated with the mechanical hybrid propulsion systems. In parallel with CVT development, hydrostatic drive designs will also be investigated that could be easily integrated with the hydraulic hybrid design and could replace the need for a separate transmission.

The critical criteria for transmission design for a hybrid truck are efficiency, weight, responsiveness, and cost. Of course, trade-offs are involved in optimizing a design for a particular truck. The objective of the transmission project will be to design a transmission that is more efficient, lighter, and lower cost than current designs while retaining excellent responsiveness.

G.3.4 Actuators and Clutches

Actuators and clutches are particularly important in a hybrid truck because the dual power sources make power transmission, shifting, and management much more complex. Because hybrid truck design is in its infancy, little work has been done in this area, particularly with mechanical hybrids. The ultimate goal is to make the existence of two power sources completely transparent to the driver of the truck. Of course, this must be done without adding much weight or cost to the truck. There are many different options for the use of clutches in a hybrid truck, and the first objective of the work in this area will be to investigate the advantages and disadvantages of each.

One interesting option with the hydraulic hybrid is to not utilize any clutching between the engine, the hydraulic pump/motor, and the transmission. The advantage of this, of course, is that it minimizes weight and cost. The drawback is that the engine may occasionally be motoring while the pump/motor is charging the accumulator during regenerative braking or when delivering small amounts of power by itself. This creates a small drag on the power train and therefore decreases its efficiency. Given the small displacement of the hybrid engine and the low frequency for the motoring mode, it may well be that the motoring is preferable from a cost-effectiveness standpoint. In any case, the trade-offs associated with utilizing or not utilizing a clutch in this regard must be examined in detail.

G.4 POWER TRANSFORMERS—PUMPS AND MOTORS, CVT

For mechanical hybrid trucks to work efficiently, they must transform power from the primary and secondary power sources. Mechanical systems have a distinct advantage over most electrical systems to be able to provide very high specific power for a given weight.

Hydraulic hybrid designs typically utilize pumps and motors. Flywheel hybrid designs can use CVT, electric motor/generators (for an electric flywheel), and hydraulic motors (for a hydraulic-based flywheel). These are examples for general mechanical components commonly seen in hybrid designs. All of these components have the advantage of being well demonstrated. In the future, other power management components, based on additional research, may be added.

To reach the 21st Century Truck Program efficiency goal, overall power management efficiency (power retrieved from power stored) of at least 90% would be needed within 2 years and at least 95% within 4 years.

G.4.1 Hydraulic Pumps and Motors

Hydraulic pumps and motors are essential in hydraulic hybrid truck design. They assist in the powering of the truck, they allow the engine to be utilized as much as possible and at peak efficiency, they permit the recovery and reuse of energy otherwise lost in braking, and they allow the deletion of some systems otherwise required on conventional trucks.

Hydraulic pumps and motors are used, of course, in a wide range of industrial applications. However, they have never been optimized for use in hybrid trucks. Conventional hardware can be used for initial proof-of-concept evaluations, but there is considerable opportunity for optimization for truck applications. Consequently, they will need considerable development to yield the speed, torque, and power ranges necessary for hybrid application but with maximum efficiency and minimum weight and cost implications. Key performance criteria for hydraulic pumps and motors are efficiency, weight, cost, noise/vibration, and responsiveness.

Current designs can be 90% or more efficient over a wide range of their operating maps. A near-term goal is to develop systems that can be 95% efficient over 80% of the operating map. A long-term goal is a design that has an efficiency of 97% or greater over 90% of the operating map. Of course, weight is a critical design parameter as well; a very efficient pump/motor would be worthless if its weight were

prohibitive. Cost is also critical and related to efficiency and weight. Today's most efficient prototype pumps/motors can cost thousands of dollars when custom ordered in small numbers. A near-term goal will be to lower cost to approximately \$1,000 per unit; the long-term goal will be less than \$500 per unit for high production volumes. Noise and vibration will be much more important in a truck application than in many other uses. In addition, the hydraulic unit must be able to instantaneously change from supplying power for truck acceleration (acting as a motor) to receiving power from the kinetic energy during truck braking (acting as a pump).

One interesting area that must be studied is to evaluate the relative advantages and disadvantages of utilizing one pump/motor or two pump/motor systems. The latter would add hardware, but it would allow the use of a smaller transmission and a smaller primary pump/motor system, which would increase the efficiency of both of these components. This important trade-off must be investigated. Key barriers in meeting the efficiency goal are basic cost, efficiency, and mechanical noise of the pump motors.

G.4.2 CVT

When a flywheel system is used, there are several variations to transform power. For example, if a flywheel hybrid used a CVT to get power to and from the flywheel it would need a transmission to deliver the power to the wheels. However, if it used an electric motor or a hydraulic motor to get power from the flywheel, then it could just send electric or hydraulic power directly to the drive wheels. Key barriers in meeting the efficiency goal are cost and efficiency.

G.5 REGENERATIVE BRAKING

Regenerative braking, or recovering and storing at least some of the energy otherwise lost in truck braking, is utilized in most hybrid truck designs. For conventional trucks in urban driving, braking can waste one-half or more of the total useful energy provided to the wheels. Recovering and reusing as much of this energy as possible is a highly desirable feature of strategies to fulfill the "factor of three" fuel economy goal. In a hybrid truck that already has a secondary energy storage system, the addition of regenerative braking is much less complex and costly. In a hydraulic mechanical hybrid truck, the energy is recovered by using a hydraulic pump to store braking energy in the accumulator for reuse to power the truck or for other purposes. In a flywheel mechanical hybrid truck, the energy is recovered by using a CVT to spin up the flywheel, thereby transferring the vehicle's kinetic energy to flywheel kinetic energy during braking. The CVT is then used in reverse fashion to transfer the flywheel kinetic energy to vehicle kinetic energy for the next vehicle acceleration.

Efficiency of energy recovery, safety, and cost are the most important issues in regenerative braking system design. The overall net efficiency (energy received from the wheels, stored, and then redirected to the wheels) of a regenerative braking system is critical and is dependent on the individual efficiencies of several components. Based on hardware currently available, none of which has been optimized for automotive applications, overall net efficiency is around 60%. The long-term goal is to increase it to 80%.

Braking systems for conventional cars are currently in a transitional state with respect to safety, moving toward widespread industry adoption of anti-lock braking systems (ABSs). Ultimately, regenerative braking will have to be fully integrated with ABSs.

G.6 CONTROL TECHNOLOGY

Sophisticated on-board electronic control systems will be essential for hybrid trucks to provide the driver the "feel" that he or she is accustomed to with a conventional truck drivetrain. Control systems on conventional trucks have become much more sophisticated in recent years, but hybrid systems involving two power sources and several additional power-train components will necessarily require much more complex systems.

A control system for a mechanical hybrid truck design will have to include all the variables included in control systems for conventional engines and trucks, such as engine speed, engine temperature, oil pressure, coolant temperature, fuel rate, injection timing, airflow, exhaust gas temperature, and exhaust oxygen levels. Additionally, the control problem is greatly complicated by the need to coordinate and optimize the utilization of two different power sources (the engine and the flywheel or hydraulic system) as well as the additional components associated with the regenerative braking.

G.7 ACCESSORIES

There could also be some consideration for how some of the truck accessories are powered. For example, in a hydraulic hybrid, the power steering pump could be powered from the hydraulic system, thus leaving the control system able to shut the engine down during low power modes. The 21st Century Truck Program designs will consider the incremental fuel-economy benefit against the cost of changing accessory components.

APPENDIX H

MORE-EFFICIENT AND/OR LOWER-EMISSION ENGINE SYSTEMS

APPENDIX H

MORE-EFFICIENT AND/OR LOWER-EMISSION ENGINE SYSTEMS

H.1 FREE PISTON ENGINE CONFIGURATIONS

Goldsborough and Van Blarigan 1999 and Goertz and Peng 2000 have simulated free piston engines that couple a reciprocating piston directly to a linear generator. (See Fig. H.1.) Such devices contain no crankshaft or camshaft. Freed from some of the kinematic and bearing load constraints of the slider-crank mechanism, they appear well suited for application to the HCCI combustion process. They are also well suited because they have more operating degrees of freedom, which may be vital for control of practical HCCI combustion. This design offers the attractive possibility that the mechanical simplicity will lead to cost-effective, efficient, clean, and more nearly direct conversion of combustion energy to electric power. Achten 1996 has built and tested a free piston engine in which the diesel 2-stroke working chamber is directly attached to a hydraulic pump. (See Fig. H.2.) This is also suitable for HCCI operation for the same reasons as described in the discussion of HCCI in Sect. 4.6.10.4. Applications would obviously focus on vehicles for which hydraulic transmissions are appropriate. It is not yet clear whether the transmission and energy storage required for hybrid vehicles should be based on electric or hydraulic technologies. Either way, the free piston engine with HCCI may be an attractive prime mover.

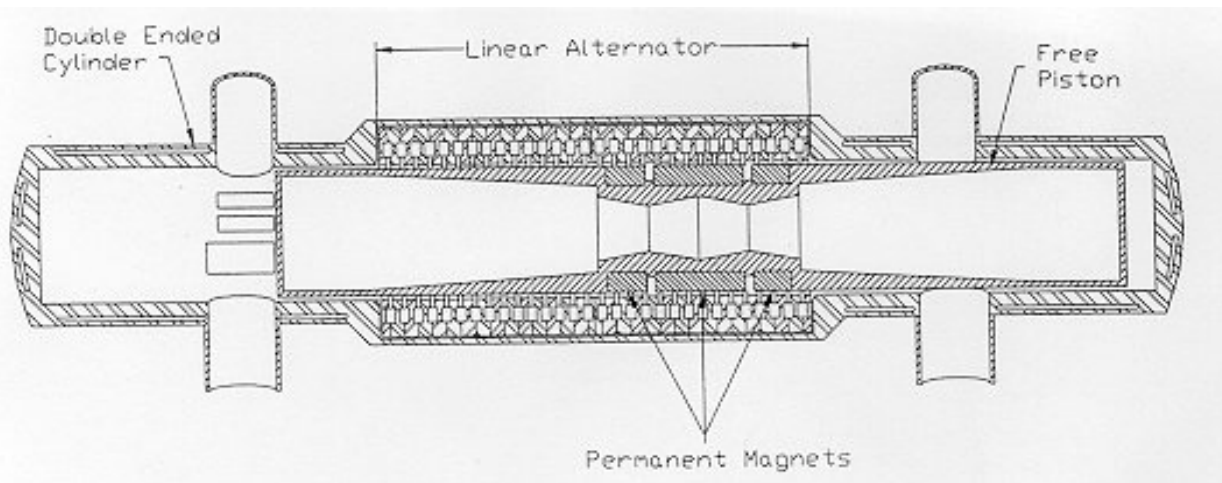

Fig. H.1. Schematic of free-piston-powered linear alternator.

H.2 IN-CYLINDER REGENERATION

Ferrenberg has simulated the thermodynamic performance of cylinders in which the working gas picks up heat prior to combustion by passing through a thin disc of porous material (Farrenberg 1990, Ferrenberg et al. 1993). (See Fig. H.3.) The disc is reheated when the expanded gas passes through it prior to exhaust. Simulated efficiency of such an engine is up to 58%. The reasons for this high efficiency are discussed in an earlier section.

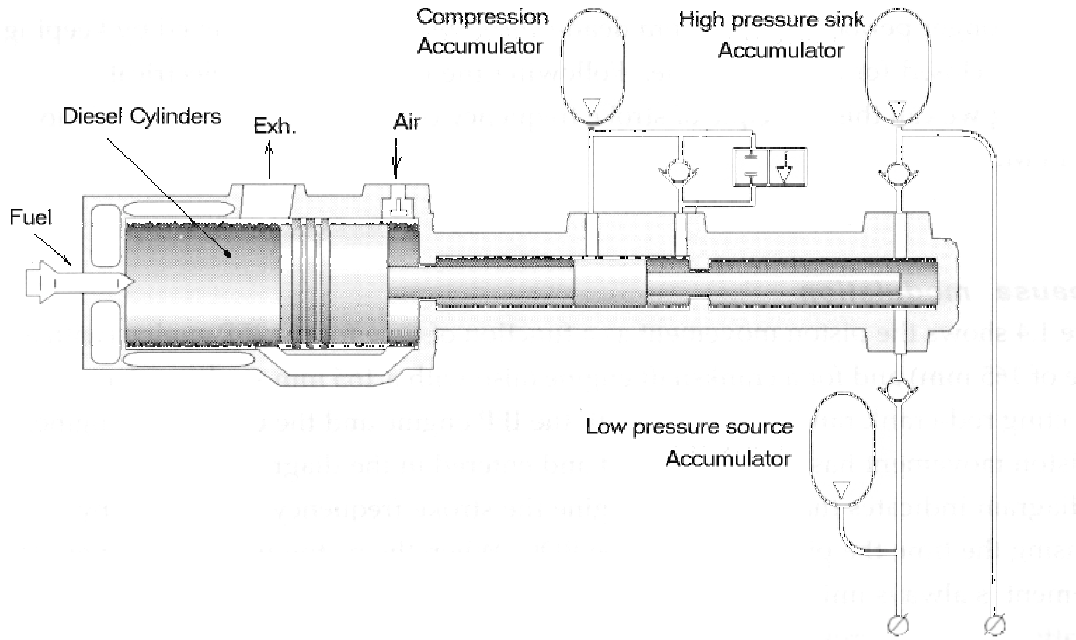

Fig. H.2. Schematic of free-piston hydraulic motor.

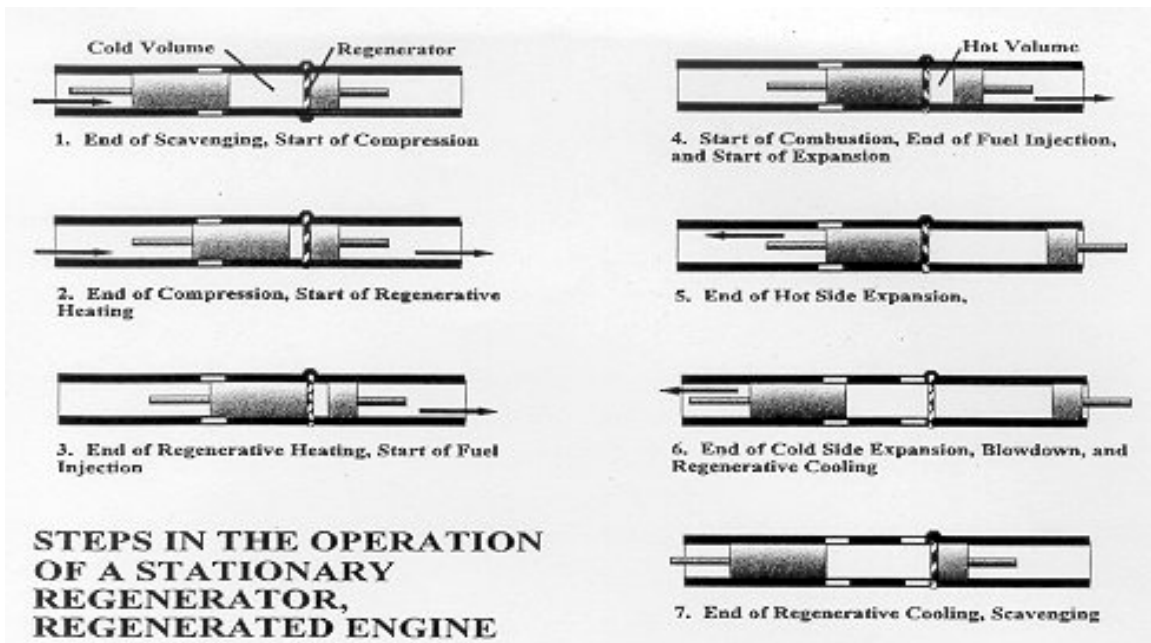

Fig. H.3. Cylinder cycle for stationary-regenerator two-stroke sleeve-valve engine.