

Paper Number:

DOE/MC/30174-97/C0821

Title:

Rapid Surface Sampling and Archival Record (RSSAR) System

Authors:

E. Barren

S.B. Dorn

A.L. Ortiz, Jr.

C.M. Penney

R.B. Sheldon

A.P. Shapiro

A.A. Bracco

Contractor:

GE-Corporate Research and Development

P.O. Box 8

Schenectady, NY 12301

Contract Number:

DE-AC21-93MC30174

Conference:

Industry Partnerships to Deploy Environmental Technology

Conference Location:

Morgantown, West Virginia

Conference Dates:

October 22-24, 1996

Conference Sponsor:

Morgantown Energy Technology Center

Disclaimer

This report was prepared as an account of work sponsored by an agency of the United States Government. Neither the United States Government nor any agency thereof, nor any of their employees, makes any warranty, express or implied, or assumes any legal liability or responsibility for the accuracy, completeness, or usefulness of any information, apparatus, product, or process disclosed, or represents that its use would not infringe privately owned rights. Reference herein to any specific commercial product, process, or service by trade name, trademark, manufacturer, or otherwise does not necessarily constitute or imply its endorsement, recommendation, or favoring by the United States Government or any agency thereof. The views and opinions of authors expressed herein do not necessarily state or reflect those of the United States Government or any agency thereof.

Rapid Surface Sampling and Archival Record (RSSAR) System

E. Barren (barrene@crd.ge.com; 518-387-7712)
S. B. Dorn (dorn@crd.ge.com; 518-387-5125)
A. L. Ortiz, Jr. (ortizal@crd.ge.com; 518-387-5540)
C. M. Penney (penney@crd.ge.com; 518-387-5128)
R. B. Sheldon (sheldon@crd.ge.com; 518-387-6565)
A. P. Shapiro (shapiroa@crd.ge.com; 518-387-5760)
A. A. Bracco (bracco@crd.ge.com; 518-387-6647)
GE- Corporate Research and Development
P.O. Box 8
Schenectady, NY 12301

T.G. Albro (tgalbro@c-mail.apgea.army.mil; 410-676-1449)
R.S. Marshall (marshall@aws.com; 301-258-8390)
J. C. E. Berends, Jr. (berends@eaicorp.com; 410-676-1449)
EAI Corporation
1308 Continental Drive, Suite J
Abingdon, Md. 21009

Introduction

The purpose of this effort is to develop a rapid surface contamination measurement system that will provide a “quick-look” indication of contaminated areas, an archival record, and an automated analysis of that record. By providing rapid analyses and a large number of accurate measurements of surface and subsurface contamination, the cost of remediation of large industrial sites will be dramatically lowered by reducing both the characterization time and the material fraction that must be remediated.

The Department of Energy (DOE) sites contain very large areas contaminated with radionuclides and semivolatile organic compounds as the result of decades of nuclear weapon and fuel production activities. Concrete, transite, and metal surfaces have been exposed to these contaminants. Unknown but substantial portions of these surfaces have been contaminated to various depths. Because contamination concentrations can vary widely over adjacent exposed surfaces, these surfaces must be sampled at closely spaced intervals to provide accurate identification of contaminants. Consequently, a huge number of surface regions must be characterized, particularly because remediated areas must be sampled more than once for identification and verification.

Current surface characterization procedures are difficult, expensive, and slow. They require an unacceptably long time to perform and consume a large share, often around 30%, of remediation/disposition resources. Accordingly, they will not meet the challenge of providing low-cost, rapid,

Industry Partnerships to Deploy Environmental Technology

quantitative and certifiable surface characterization on the scale required by DOE as part of its decontamination and decommissioning activities.

Objectives

The objective of this effort is to help develop and demonstrate new and existing technologies that will enable the DOE to decontaminate and decommission their facilities in the most cost-effective manner possible. The costs and environmental risks associated with disposing of structures and equipment as hazardous waste are unacceptably high owing to the nature of the contaminants and the sheer volume of material in question. The DOE recognizes that a large portion of its contaminated material and equipment must be processed in some manner to a state from which it can be recycled and reused. If recycle or reuse proves impossible, then the material must be cleaned in a manner to allow for its disposal as a nonhazardous substance. Disposal of materials as hazardous waste must be minimized.

Characterization technology is key to accomplishing the DOE's decontamination and decommissioning goals. Building materials and equipment must be adequately characterized before, during, and after decontamination and decommissioning activities. The nature and level of contaminants must be initially established to determine whether cleanup is required. During the cleanup, analysis will be required as an element of cleanup process control. Ultimately, the material will have to be certified as clean before it can be recycled or disposed of.

A number of constraints must be met by any technology facing the challenge of characterizing the DOE's sites. It must be a cost-effective portable system capable of providing rapid results from the enormous amount of surface area to be screened. It must accurately assess the identity and level of contaminants in an analytical format acceptable to regulatory agencies. The technology must be robust, operable by persons with minimal amounts of training, and give screening results in a readily understandable format.

Competitive Analysis

Existing technology for analyzing surface contamination does not meet the above constraints. The most common and accepted current method for sampling surfaces for hazardous materials is the EPA wipe or swipe test, in which a measured surface area is wiped with a gauze cloth or other absorbent material soaked with an organic solvent. The wipe is then sent off to a laboratory, extracted with solvent, and the extracts are analyzed for the presence of the contaminants. The method, though widely used, suffers from serious limitations. It provides extremely variable results, because it relies on the technique and consistency of individual samplers and is inaccurate, with results depending upon the nature of the surface (rough, smooth, rusted, etc.) The wipe method requires expensive offsite laboratory analysis that can result in delays of days to weeks and does not lend itself to efficient data handling. Furthermore, the method analyzes the surface only, not the region below, exposes workers to potentially dangerous and harmful solvents, and generates additional waste including wipes, solvents and sample containers that must be disposed of as hazardous waste.

Industry Partnerships to Deploy Environmental Technology

On porous surfaces, such as concrete, a freshly cleaned surface may pass a wipe test (contain $<10 \mu\text{g}/100 \text{ cm}^2$ contaminant) only to fail it at a later date as material from below the surface migrates upward. In spite of these limitations, wipe sampling is widely used to detect surface contamination.

Approach

This program, which concerns the development of a Rapid Surface Sampling and Archival Record (RSSAR) System, was undertaken to provide a solution to the cost and technical shortcomings of conventional methods for characterizing contaminated surfaces. It is directed to the development of a portable instrument system capable of sampling a variety of surfaces for semivolatile organic contaminants. The system under development provides rapid sampling (one sample per 100 sec.), a “quick-look” indication of contamination level, and a stored record for detailed, automatable analysis.

This system is assembled from instruments incorporating several well-established techniques and instruments incorporating innovative techniques. It comprises thermal sampler heads, a “quick-look” module, and an archival multisample trapping module. The RSSAR system is composed of several modular units, as illustrated in Figure 1.

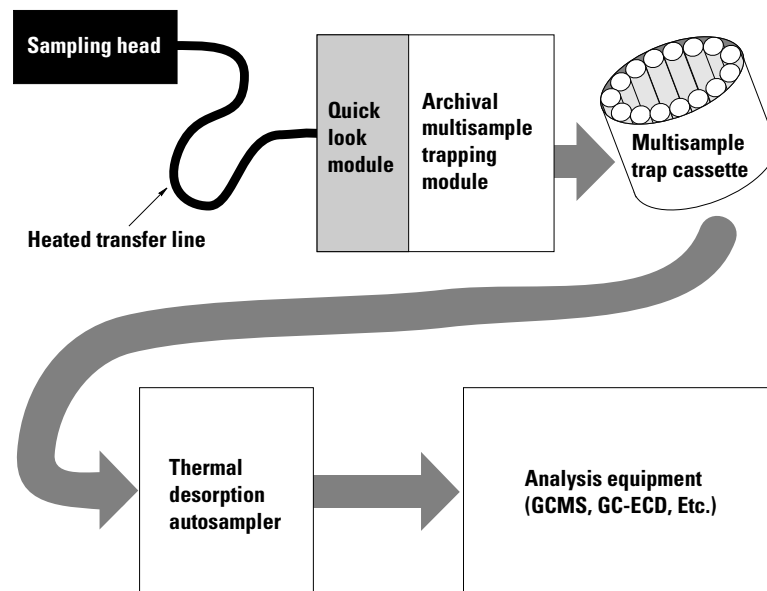

Figure 1. Configuration of RSSAR System. This modular system includes several sampler heads, a quick look facility, an archival record, an organized set of stored samples, and an automated interface to couple this record into various types of analysis equipment.

Project Description

Thermal sampling for semivolatile compounds has been chosen for development because this technology can provide substantially more reliable readings of surface contamination than wipe sampling. It also minimizes the production of contaminated sampling waste, lends itself to automated processing, separates chemical samples from radioactive materials, and is fast. In general, samples are acquired using thermal desorption of contaminants at approximately 250°C by radiant heat.

“Concrete,” bulk, and “steel” sampler heads are being developed to handle the most frequent sampling requirements. A concrete surface sampler, which has been developed and demonstrated, can be used to determine contamination levels at surfaces and down to a few millimeters below the surface for porous, low thermal-conductivity materials, providing information also targeted by the standard wipe test. A bulk sampler head has been developed and demonstrated that can be used to measure contaminants in asbestos, paint scrapings, particulate waste, and samples from drilling as well as calibration standards. To determine subsurface contamination, samples from drilling would be placed in the bulk sampler head connected to the RSSAR system for “quick look” and archival analyses. A steel sampler head has been designed for the markedly different sampling conditions provided by nonporous surfaces with high-thermal conductivity.

The purposes of the “quick-look” module are to provide a real-time guide of sampling strategy, a real-time practical indication of system performance, a personnel safety indicator, a redundant indicator channel, and a method to reduce the fraction of samples that are subjected to more time-consuming detailed analysis. The viability of “quick-look” has been demonstrated using both a photoionization detector and ultraviolet absorption.

The archival multisample trapping module traps contaminants and stores them for detailed analysis. This stored record, organized in a cassette format (as shown in Figure 1), is associated with corresponding sample information, to facilitate record-keeping, to minimize handling and training requirements, to reduce errors caused by operator fatigue in the highly repetitive sample acquisition and analysis tasks, and to expedite automated readout. A single sample trapping module was tested initially and the results were used in the design and fabrication of an archival multisample trapping module. The archival multisample trapping module allows trapping of up to 50 separate samples and transfer to a modified thermal desorption autosampler for subsequent analyses.

The thermal desorption autosampler accepts the organized record format and provides an automated interface to alternative readout instruments such as gas chromatography/mass spectrometry, tandem mass spectrometry, gas chromatography with electron capture detector, or a fast optical readout such as a photo-ionization detector. By manipulating sample and substrate size, quantities of PCBs of interest to the DOE (10 µg on 100 cm² surface) should easily be detectable with little additional optimization of techniques that have been developed.

The overall RSSAR System is modular and will use accurate sample acquisition, handling, and analysis techniques. The availability of an archival record that allows detailed analysis (and an

occasional backup check on the quick-look detector) will expedite material disposition planning and regulatory approval. Consequently, the RSSAR System should provide a cost-effective approach for the measurement of semivolatile contamination required for large industrial site remediation.

Results

Concrete Sampling

A prototype concrete sampling head was developed based on results from field testing of initial concepts and Monte Carlo simulations of illumination patterns. The concrete sampling head uses a one thousand watt tungsten halogen lamp as the heat source located near the top of a smooth reflective hemispheric housing to provide more efficient coupling and minimize hot spots on the surface. A diffuser plate is located just below the lamp with a protective window at the bottom. Vapors are collected through eight slots in the lower chassis which are connected to a recessed channel in the heating block. Figure 2 shows a cross-sectional view of the concrete sampling head.

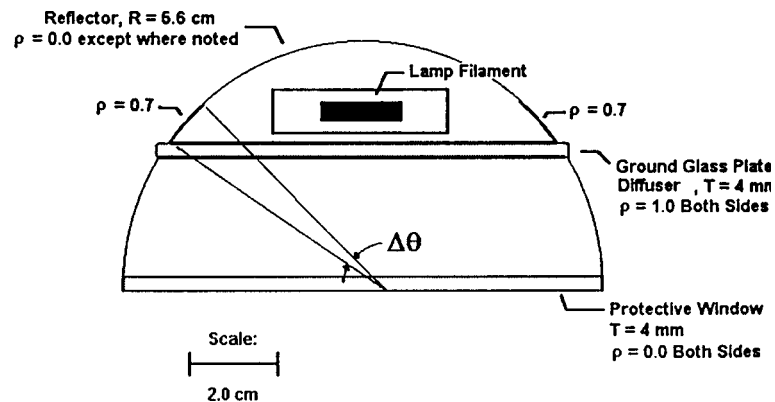

Figure 2. Concrete Sampling Head Cross Section

Results from thermal testing of the modified concrete sampler using an imaging radiometer are shown in Figure 3. Uniform temperatures were achieved at over 60 % of the heated surface with another 15 to 20 % of the area at temperatures close to the uniform area.

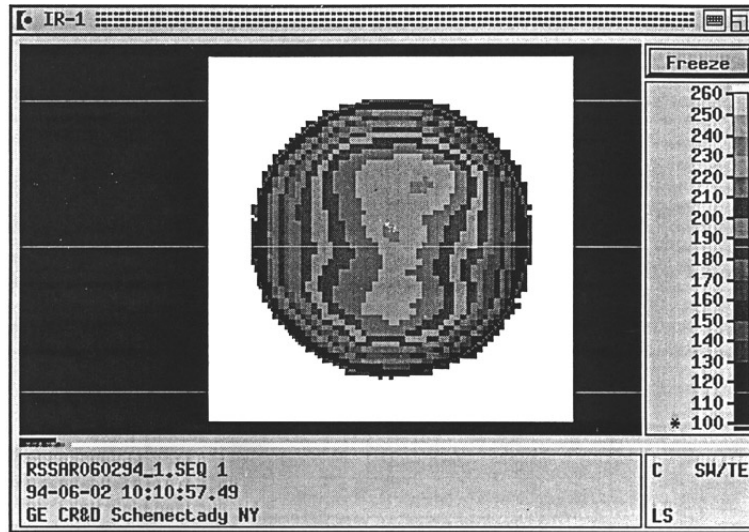

Figure 3. Concrete Sampling Head Temperature Distribution. The peak temperature shown in the two small regions of the upper central lobe is between 230 and 240 °C.

The concrete sampling head was configured as shown in Figure 4 for performance testing to ascertain the ability of the system to detect contaminants.

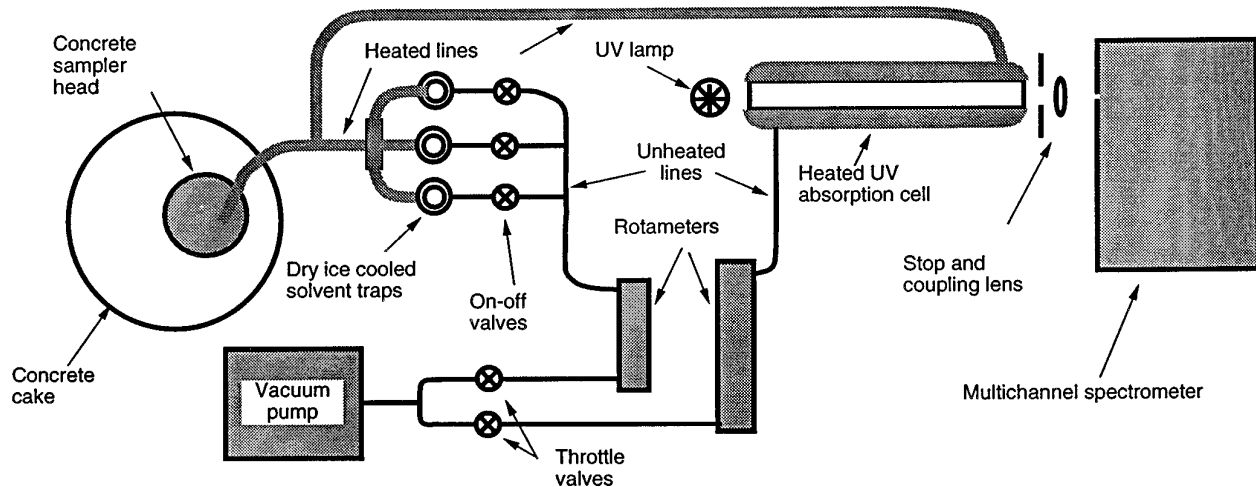

Figure 4. Concrete Sampling Head Performance Testing Configuration

Tests were conducted on prepared concrete specimens previously spiked with known concentrations of anthracene, 2,4,5- trichlorobiphenyl, and phenyldodecane as surrogates for polyaromatic hydrocarbons, polychlorinated biphenyls, and oil, respectively. Results which are shown in Figure 5 indicate that thermal sampling is able to correlate well with bulk contamination levels. The essential elements of the RSSAR process including the semiquantitative performance of a quick-look detector, trapping of desorbed contaminants, efficient transfer to a gas chromatography column, and close quantitative correlation between concentration determinations and original bulk contaminant loadings gave positive results in these experiments.

Industry Partnerships to Deploy Environmental Technology

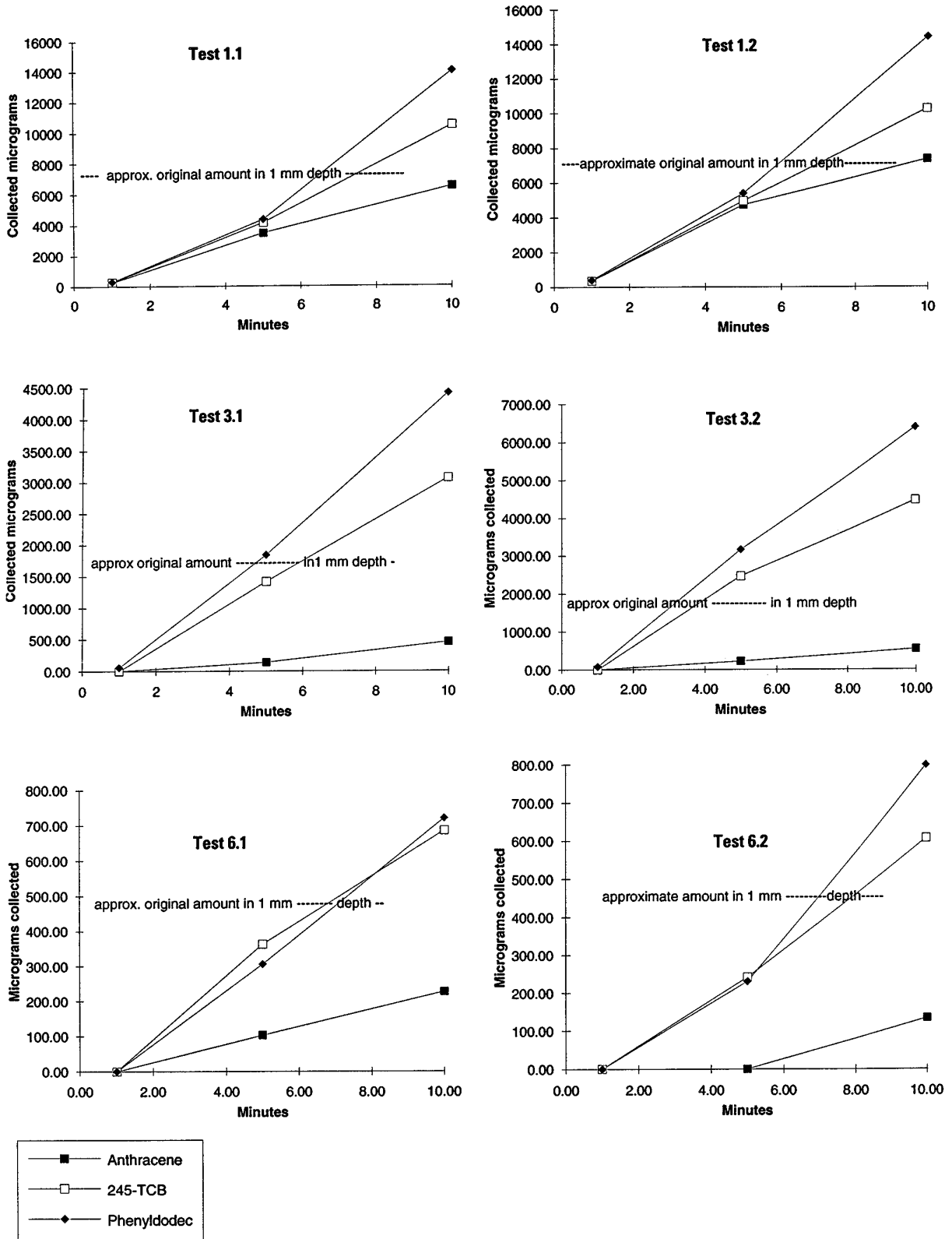

Figure 5. Total Contaminant Extraction Amounts vs. Time Determined From GC Analysis of Solvent Traps.

Industry Partnerships to Deploy Environmental Technology

Bulk Sampling Head

A bulk sampling head was developed for analysis of drill cuttings, pulverized concrete, soil, and particulate waste. The sampler was made from a solid aluminum block heated with a 700 watt calrod heater. The sampler was connected to the quick-look module through insulated tubing and swagelock fittings. The bulk sampling head was used extensively for testing of commercial sorbents for their ability to trap the target contaminants. The results from thermal recovery of anthracene, 2,4,5- trichlorobiphenyl, and phenyldodecane are reported in Table 1. Carbotrap 370[®] was found to have the best performance with recoveries ranging from 77.8% to 100%.

Steel Sampling Head

The metal sampler head has undergone initial testing with an arc lamp. Total lamp power output and output through the delivery line were measured at various lamp inputs. Results to date are shown in Table 2. These powers were measured with a high power calibrated thermopile detector, which responds essentially uniformly to UV, visible and infrared wavelengths.

Table 1. Percent Recovered by Thermal Desorption¹

Sorbent	Load (ug)	Anthracene	2,4,5- TCB	Phenyldodecane
Carbotrap 370	10	77.8	86.1	78.7
Carbotrap 370	20	81.3	83.6	79.5
Carbotrap 370 ²	40	85.0	82.4	80.7
Carbotrap 370 ²	20	87.2	87.4	84.4
Carbotrap 370 ²	20	101	100	96.2
Tenax GR	10	79.2	80.1	81.3
Tenax GR	20	106.4	93.1	78.6
Tenax GR	40	55.8	70.8	65.3
Carbopack B	10	85.4	98	85.7
Carbopack B	20	91.7	91.6	81.9
Carbopack B	40	53.1	55.6	47
Carbopack C	10	47.8	81.8	51.9
Carbopack C	20	57.4	86.2	68.2
Carbopack C	40	10.3	85.9	11
XAD-2	10	1.5	0	0
XAD-2	20	89.6	88.9	85.8
XAD-2	40	51.4	50	50.7

¹ Average of two trials

² Numbers obtained from one run

Table 2. Steel Sampling Head Power Delivery

<u>Lamp Power Setting</u>	<u>Power Into Delivery System</u>	<u>Delivery System Output</u>
400W	120W	26W
600W	205W	42.5W
800W	295W	59W

Coupling efficiencies into the delivery system are lower than expected. Actions to increase coupling efficiency from the present 20% level to near 50% are underway.

A thin (1.2 mm thick) rusty carbon steel sample with a tack welded thermocouple on the back end was illuminated with the steel sampler at room temperature and lamp power set at 600 watts. The approximate surface temp of the sample reached 205 °C in 30 seconds following the time dependence shown in Table 3. Thinner metal samples heat up more quickly while thicker specimens take longer to reach proper sampling temperatures.

Table 3. Steel Sampling Head Sample Temperatures with Time

<u>Time (sec)</u>	<u>Temperature (°C)</u>
0	21.7
5	80.5
15	143.2
30	204.8
45	243.9
60	287.2

Thermal Modeling

A mathematical model of heat and mass transport in concrete has been applied to the process of rapid thermal desorption of contaminants from concrete. It has been shown that the presence of moisture plays a significant role in the efficiency of contaminant removal. The range of simulated water contents included from 0 to 1000 kilograms per cubic meter, and the range of permeabilities extended from 10^{-17} to 10^{-15} m². The model indicates that the removal of PCBs is fairly insensitive to moisture content as long as the moisture content is between 50 and about 400 kilograms per cubic meter as shown in Figure 6. At lower moisture contents, the reduced amount of steam available for stripping the PCB vapors out of the concrete decreases the removal rate. Maximum contaminant removal occurs when the moisture content is about 100 kg per cubic meter. At higher moisture contents, the increased latent heat requirements reduce the heating rate and hence the PCB removal rate.

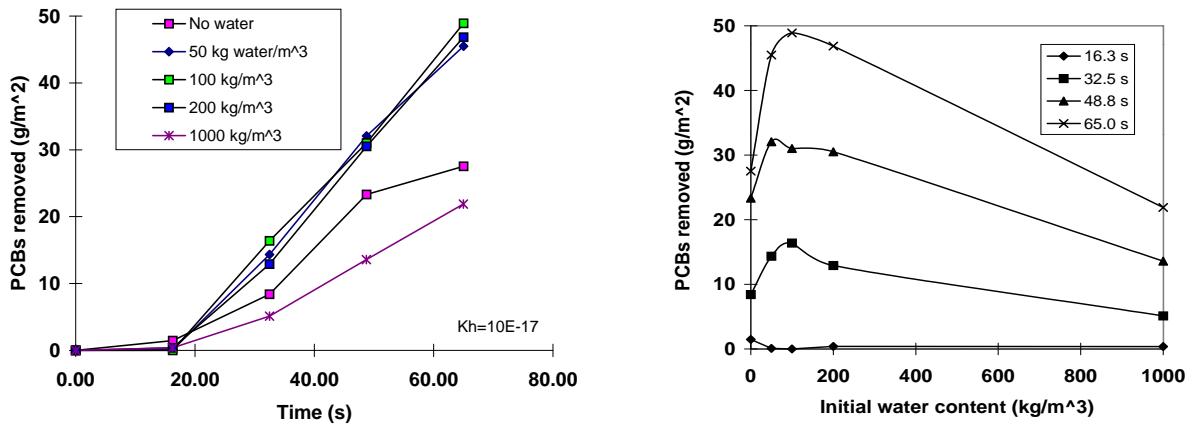

Figure 6. Thermal Modeling of Effect of Moisture Content on PCB Removal.

The model also indicates that highly permeable concrete is expected to have higher PCB removal rates, with other conditions being the same as shown in Figure 7. In a 30 second simulation, concrete with an intrinsic permeability of 10^{-15} m^2 had twice the removal of PCBs than concrete with 10^{-17} m^2 permeability. While the relation between removal rate and permeability is much weaker than linear, the fact that the local permeabilities within a real concrete specimen can vary by several orders of magnitude make this effect significant. Extension of these results to heterogeneous concrete would suggest PCBs would be removed preferentially from regions containing microcracks rather than uncracked regions.

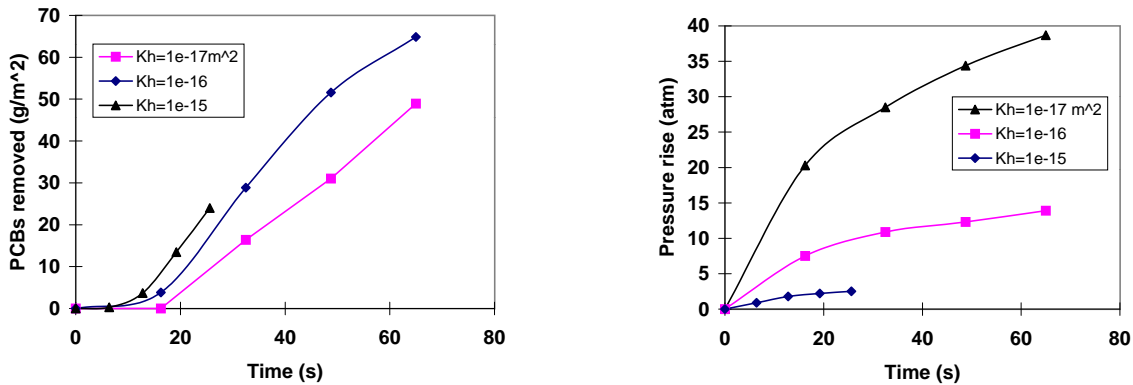

Figure 7. Effect of Permeability on PCB Removal.

Multisample Trapping Module and Thermal Desorption Unit

A fully automated, modular, and versatile concept has been developed for the Multisample Trapping Module (MSTM) portion of the RSSAR system. The concept will allow for RSSAR operations to be conducted with minimal operator input and virtually no operator handling of individual samples. Sorbent tubes will be housed in a transportable magazine that will interface to both the RSSAR system and the Thermal Desorption unit (TDU) system. Samples will be protected prior to, and subsequent to, sampling to minimize contamination and cross-contamination potential.

Industry Partnerships to Deploy Environmental Technology

During sampling, sensors will monitor all relevant parameters to ensure reliable, accurate samples. Data generated from sensors during sampling and RSSAR quick-look detector results will be stored in nonvolatile electronic memory resident in the sorbent tube magazine. The data will then be available to the TDU and analytical instruments to facilitate timely and accurate analysis. Figure 8 depicts the three major components comprising the field portion of the MSTM and the TDU that will reside in the laboratory.

Interface to the Perkin-Elmer TDU requires a sample transfer device that resides on top of the ATD-400. The RSSAR system will have the capability to perform both quick-look detection and sorbent tube sampling at each location. However, a sorbent tube sample is not required for each location. Sufficient memory exists in the magazine to store data for all 50 archived sorbent tube samples plus 500 quick-look sampling points.

Future Activities

Laboratory performance testing of the steel sampling head, multisample trapping module, thermal desorption autosampler, and the integrated system are underway. Pending acceptable results from this “proof of concept” testing, a field portable system will be designed, fabricated, and tested in the field. Upon completion of testing and receipt of applicable regulatory and government approvals, two prototype systems will be built and delivered to DOE for use in supporting decontamination and decommissioning activities.

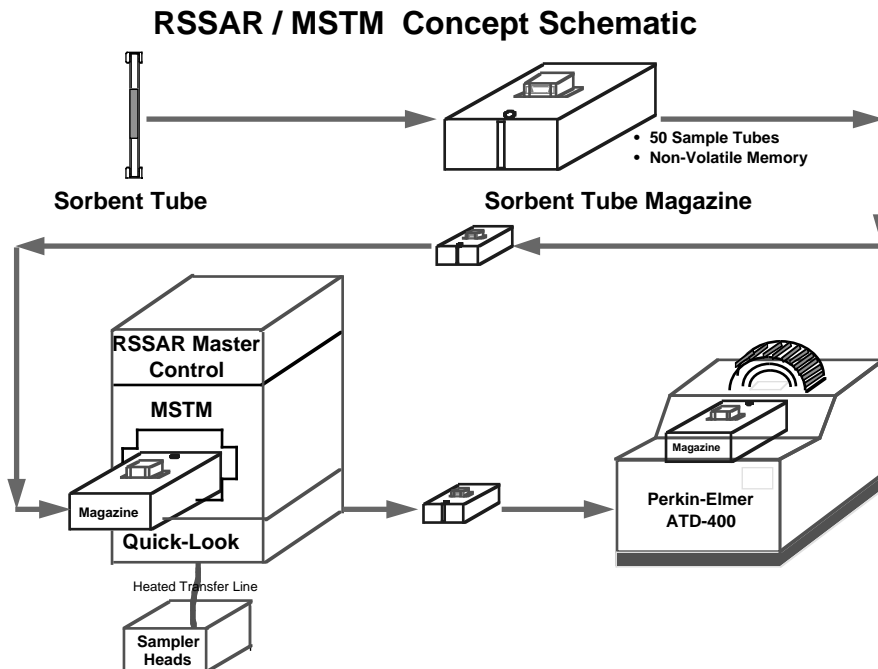

Figure 8. Three major components comprising the field portion of the MSTM and the TDU that will reside in the laboratory.

Reference

Sheldon, R.B., C.M. Penney, E. Barren, S.F. Feldman, A.L.Ortiz, Jr., and D.R. Berdahl. 1995. Rapid Surface Sampling and Archival Record (RSSAR) System, Phase 1 Final Report, DE-AC21-93MC30174, 138 pp.

Acknowledgments

We would like to acknowledge the support of Scott Renninger, our Contracting Officer's Representative throughout the latter phases of phase 1 and during phase 2 of this project extending between January 1, 1995 and December 30, 1996. In addition, the administrative support of Janet S. Bennett from GE-CRD is greatly appreciated.

Contract Information

Research sponsored by the U.S. Department of Energy's Morgantown Energy Technology Center, under contract DE-AC21-93MC30174 with GE Corporate Research and Development, P.O. Box 8, Schenectady, NY 12301-008; 518-387-7611.