

Paper Number:

DOE/MC/31203-97/C0743

Title:

Initial Failure Analysis of Ceramic Filters

Authors:

Z. Huque

D. Mei

J. Zhou

Contractor:

Prarie View A&M University

Department of Mechanical Engineering

P.O. Box 397

Prarie View, TX 77446-0397

Contract Number:

DE-FG21-94MC31203

Conference:

Advanced Coal-Fired Power Systems '96 Review Meeting

Conference Location:

Morgantown, West Virginia

Conference Dates:

July 16-18, 1996

Conference Sponsor:

U.S. DOE, Morgantown Energy Technology Center

Disclaimer

This report was prepared as an account of work sponsored by an agency of the United States Government. Neither the United States Government nor any agency thereof, nor any of their employees, makes any warranty, express or implied, or assumes any legal liability or responsibility for the accuracy, completeness, or usefulness of any information, apparatus, product, or process disclosed, or represents that its use would not infringe privately owned rights. Reference herein to any specific commercial product, process, or service by trade name, trademark, manufacturer, or otherwise does not necessarily constitute or imply its endorsement, recommendation, or favoring by the United States Government or any agency thereof. The views and opinions of authors expressed herein do not necessarily state or reflect those of the United States Government or any agency thereof.

Initial Failure Analysis of Ceramic Filters

Ziaul Huque (zhuque@pvcea.pvamu.edu; 409-857-4023)

Daniel Mei (dmei@pvcea.pvamu.edu; 409-857-4023)

Jianren Zhou (jzhou@pvcea.pvamu.edu; 409-857-4023)

Mechanical Engineering/Prairie View A&M University

College of Engineering and Architecture

Post Office 130X 397

Prairie View, Tx 77446-0397

Abstract

Effective high temperature ceramic filters are indispensable in the advanced, coal based power systems (IGCC and PFBC). To meet the environmental particulate emission requirements and improve thermal efficiency, ceramic filters are utilized to cleanup the hot gas particulate to protect downstream heat exchanger and gas turbine components from fouling and corrosion. The mechanical integrity of ceramic filters and an efficient dust cake removal system are the key issues for hot gas cleanup systems. The filters must survive combined stresses due to mechanical, thermal, chemical and steam attack throughout normal operations (cold back pulse cleaning jets), unexpected excessive ash accumulation, and the start up and shut down conditions.

To evaluate the design and performance of ceramic filters, different long term filter testing programs were conducted. To fulfill this purpose, two Advanced Particle Filter (APF) systems were complete at Tidd PFBC Demonstration Plant in Brilliant, Ohio in late 1990 as part of the Department of Energy's (DOE) Clean Coal Technology Program. However, many filter failures were reported prior to its desired life time. In Tidd APF vessel, 28 filters failed one time,

The objectives of this program were to provide an understanding of the factors pertinent to the failures of ceramic filters by characterizing filter properties and the dust cake removal mechanism, Researches were emphasized on understanding of changes of filter properties and back pulse cleaning mechanism to resolve the issues relating to filter permeability variations, ash bridging and micro-thermal cracks induced during cold back pulse cleaning.

To perform failure analysis of ceramic filters, thermal numerical simulation, material laboratory analysis on filter materials and dust cake, and measurements on filter properties and back pulse intensity along filter axis within a bench scale filter chamber were conducted.

The initial failure analysis of ceramic filters program consisted of five phases:

Phase I - Literature survey, filter chamber design and test plan generation

Phase II - Test chamber fabrication, assembly and filter property testing

Phase III - Thermal numerical simulation on candle filter during back pulse cleaning

Phase IV - Material laboratory analysis on filters, dust cake and microscopic study by means of X-ray diffractometer, SEM and X-ray photoelectron spectroscope

Phase V - Measurement on pulse intensity and optimization on back pulse system design

Material laboratory analysis indicates that the outer layer of used filters have different phase structure than its inner layers due to filtration of foreign materials, The permeability of used filters varies randomly compared with the unused ones. Back pulse induced micro-cracks can be reduced by providing heated back pulse stream to reduce the temperature gradient within the filter. Back pulse cleanup efficiency can be improved by optimizing the back pulse system design.

Even dust layer deposition on **filter** is particle size and cohesive force dependent, an efficient dust cake removal system can help prevent excessive dust cake deposit on **filter** surface and eliminate ash bridging problems contributing to the failures of ceramic filters, Thermal induced load which damaged candle filters could be eliminated as ash bridging disappears. Test data collected by this research program can help filter researchers **verify** the accuracy of their numerical simulation results prior to extensive simulation on filter system design and analysis.

More measurements and analysis will be performed on filter clusters within a bench scale filter chamber to help optimize the back pulse plenum system design.

Acknowledgements

We would like to thank our Contracting Officer's Representative, **Dr. Norman Holcombe**, filter cluster leaders, **Dr. T. K. Chiang** and **Dr. Duane Smith**, and **Mr. Charlie Komar** as well as the management at **DOE/METC** for their extensive support on this research program and made our visits to other research institutes and filter industries possible for **helpful** technical discussions, Special thanks to **Mr. Komar** for all of his efforts in helping establish Hot Gas Cleanup (**HGCU**) research program at Prairie View A&M University.

Research sponsored by the U.S. Department of Energy's **Morgantown** Energy Technology Center, under contract DJ3-FG21 -94MC3 1203 with Mechanical Engineering/Prairie View A&M University, College of Engineering and Architecture, P.O. Box 397, Prairie View Tx 77446-0397; 'l'cl: (409) 857-4023 Fax: (409) 857-4395

Introduction

Electricity demand has been closely tied to economic growth, The need for electrical power is estimated to double for every twenty years. Coal gasification is an critical process in advanced energy conversion systems for power generation, because it can improve the efficiency of electricity generation with less cost along with the Integrated Gasification **Combined** Cycle system, To protect high temperature gas turbine system, heat exchange components from corrosion and damages caused by gasified particulate, and meet the environmental protection measures, hot gas cleanup is one of the most critical technologies required to ensure the success of low-cost methods of electric power generation. Ceramic filters are indispensable in removing the particulate in coal gasification applications, Among the current hot gas cleanup technologies, the most economical one is the use of rigid ceramic candle filters to remove particulate from gas streams being introduced into hot gas turbine. The mechanical integrity of ceramic filters and an efficient dust cake removal system are the key issues to be resolved for hot gas cleanup systems. The filters must survive combined stresses due to mechanical, thermal, chemical and **steam** attack throughout cold back pulse cleaning jets and system start up and shut down conditions.

Problems

To evaluate the design and performance of ceramic filters, different long term filter testing programs were conducted. To **fulfill** this purpose, two Advanced Particle Filter (**APF**) systems were complete at Tidd PFBC Demonstration Plant, in Brilliant, Ohio in late 1990 as part of the Department of Energy's (DOE) **Clean** Coal Technology Program. But the most undesirable thing ever happened was the sudden fictional and physical failures of filters prior to its designed life time, In Tidd APF filter vessel, twenty eight (28) filters failed one time. Significant research effort has been carried out to find out the exact cause of early failure of filters, In this work, the studies are emphasized on the possible failure cause analysis of rigid ceramic candle filters.

Objectives

The objectives of this program were to provide an understanding of the factors pertinent to the failures of ceramic filters by characterizing filter properties and the dust cake removal mechanism, Researches were emphasized on understanding of changes of **filter** properties and back pulse cleaning mechanism to resolve the issues relating to filter permeability variations, ash bridging and micro-thermal cracks induced during cold back pulse cleaning.

Approach

To **perform** failure analysis of ceramic filters, thermal numerical simulation, material laboratory analysis on filter materials and measurements on filter properties and gas stream pressure field along filter axis within a bench scale filter chamber were conducted,

Project Description

The initial failure analysis of ceramic filters program consisted of five phases:

Phase I - Literature survey, filter chamber design and test plan generation

Extensive literature survey was performed on research work conducted by academic and industrial researchers. Most of work was concentrated on the **microstructural** or material aspect (mechanical, thermal and chemical properties) of filters, Westinghouse and South Research Institute has performed significant amount of testing on the **thermo-mechanical** properties of various filters provided by filter industry. But little work had been conducted on the variations of filter permeability and the pressure distribution field of the gas stream during dust cake cleaning process, Therefore, a filter chamber and a testing plan for candle filter were designed to study the variations of filter permeability and gas flow pressure field in the filter chamber.

After a thorough discussion, the samples for this analysis program are silicon carbide ceramic filters supplied by **IF&P**, Chicago, Illinois, U.S.A. with 154.83 cm long, 3,81 cm I.D. and an O. D. of 6.35 cm.

Phase II - Test chamber fabrication, assembly and filter property testing

The schematic of the room ambient temperature filter test chamber is shown in Figure 1. To facilitate the testing, this test chamber vessel was made from a transparent plastic pipe with a 15,24 cm O. D., 198.12 cm long and 0,71 cm wall thickness. This test chamber vessel passed a 150.0 psig static pressure testing, compatible with Tidd APF pressure level, prior to its final assembly. Ten 1/2 -20 threaded holes are evenly spaced along the chamber axis to mount fast response pressure transducers and the pressure calibrator, A filter sealing plug base (15.33 cm diameter by 8.90 cm long) and a pressure inlet plug (1 5.33 cm diameter and 8.9 cm long) are placed at the top and bottom end of the test chamber respectively. All the test chamber components were carefully machined with a tight tolerance control within +/- 0,001 inches.

The candle filter is installed in the pressure sealing assembly to ensure the **hermeticity** of pressure sealing and the filter is located along the center of the vessel axis to provide a cylindrical symmetric system, Rubber pads are placed in between the filter and the sealing plug to reduce shock and mechanical stress on the filter flange during pressure testing, A pressure sealing diaphragm is installed on the top of the filter sealing assembly. The technique of perforating the diaphragm was utilized to seal and release filter test chamber pressure. The sealing diaphragm was **perforated** by a special designed perforating device to establish the chamber pressure per the ambient pressure test plan. Figure 2 shows the schematic of the diaphragm perforating arrangement.

An advanced microprocessor based hand held pressure calibrator and micro-machined silicon pressure transducers for each pressure range were installed along the axis of the filter test chamber to characterize candle filter permeability variations and the gas flow pressure distribution field in the test chamber. **All** of the pressure transducers were **carefully** calibrated prior to the use

of pressure in the testing work, A data acquisition system is utilized to collect test data.

The total leak time required for preset positive chamber pressure to reduce to room ambient pressure was recorded as a relative measure to correlate the permeability variations of the filters to be evaluated. Positive pressure was provided by nitrogen bottle. Vacuum chamber environment is support by a vacuum system,

To character IF&P filter performance, permeability changes of unused and used filters were first evaluated within an innovative test setup assembled in the mechanical engineering laboratory at Prairie View A&MU. To ensure the validity of the test results, the test setup and controls had been modified and improved until repeatable test environment and controls were available, The permeability distribution of **IF&P** filters was then carefully measured and characterized along the axis of the filters with different exposure percentage of filter surfaces to the gas flow.

A technique has been successfully developed to seal the filter surface. This technique was applied on partial filter surface areas to characterize the variations of filter permeability along filter axis and along filter perimeter. To facilitate the characterization of filter permeability variations, it was decided that only 25% of the filter surface area, along filter axis and its perimeter, was evaluated each time **after** a few test iterations. Each filter was tested four times with the same test environment under one pressure range. Four to five tests were **performed** for each pressure range and test data were reviewed and ensured it were consistent and repeatable. Therefore, the averaged data represents the characteristics of filter performance with good confidence.

Every test was repeatedly performed five times. After technical discussion and evaluation, the test results were found to be repeatable and representative as planned. This testing philosophy was applied on all testings. These measurements did **identify** the variations of filter permeability can be randomly distributed only along the used filter axis and its perimeter; and the variations could be filter operation history dependent.

Phase 111- Thermal numerical simulation on candle filter during back pulse cleaning

A finite element analysis was initiated using the commercial finite element code ANSYS (Version 5.0), The initial analysis was focused on temperature distribution within filter during dust cake cleanup process. Half of a filter cut along the vertical plane of symmetry was used as the calculation domain.

The module was developed by dividing the computation zone into five volumes. This **multizone** approach was used in order to overcome the difficulties in meshing due to high slenderness ratio (length to diameter) of the filter. **Discretization** of the computational zone was done using two types of 3-D elements from the ANSYS element library, The bottom closed end of the filter was meshed with 3-D 10-node tetrahedral thermal solid, The rest of the cylinder was meshed with 20-node Thermal Solid Brick, In total for the entire computation domain 3598 elements were used. Connective boundary conditions were used for both outside and inside surface, The inside environmental temperature was assumed to be 40 degree C and the outside environment temperature was taken as 800 degree C, selected because it is close to the working

temperature. 40 degree C at the inside was used to be close to the back pulse temperature.

The convective heat transfer coefficients were obtained using correlation for forced flow. the thermal conductivity for the **filter** was taken as 87-86 W/mK, a value for silicon carbide. The convective heat transfer coefficients used were 1105W/mK and 992 W/mK for inside and outside surface respectively. Figure 3 shows the model of the entire half filter with exact scale factor. Figure 4 shows a blow-up of the filter near the flange neck. The figure also depicts the meshing of the elements. Figure 5 shows the temperature contour plots. The highest temperatures were on the outside surface close to the middle of the filter. The lowest temperature was on the inner surface close to the neck, The temperature variation ranges from about 567 degree C to about 405 degree C.

The initial analysis was done using solid wall for the **filter** and using steady state boundary conditions. Subsequent analysis will focus on unsteady state boundary conditions with solid wall and porous wall with unsteady state conditions. This **will** require coupling of heat transfer and fluid flow equations. The fluid solver that will be used is **FLOTRAN** which is a stand alone version of fluid flow solver in ANSYS. The analysis will include flow and pressure boundary conditions as are obtained from experiments in our laboratory.

Phase IV - Material laboratory analysis on filters and microscopic study by means of X-ray diffractometer, SEM and X-ray photoelectron spectroscope

Ceramic candle filters have been extensively used in the filtration of coal derived gases at high temperature and pressure. However, due to severe working condition and environment, some filters deteriorated prior to the desired life time. It is very important to **identify** and investigate the filter degradation mechanisms,

Figure 6, 7, 8 and 9 show some results of related investigation. It shows that the unused ceramic filter is a double-layer porous candle with gray color. The broken used filter samples were in dark yellow color. The yellow color surface layer is the product of emission particle deposition and the chemical reactions between emission gases and filter material. The composition of this layer are mainly SiO₂, Al₂O₃ and Al₂Si₄O₁₀ according to the XRD analysis (Figure 7). This layer would reduce the **efficiency** of ceramic filters.

The observation and analysis also indicates that there is no significant difference in morphological characteristics between used and unused ceramic filters. it seems to indicate that no obvious change in microstructure occurred **after** usage. But, the XRD spectrashowed that **after** usage the crystal structure of the main composition SiC has been changed. The crystal plan spaces of the SiC in the outer layer were increased, For the inner layer, not only has SiC changed the crystal plane spaces, but also its grain orientation, The preferred orientation along (1034) of SiC in the inner layer of the used ceramic filter can be seen clearly in Figure 9. The growing and change in microstructure of the grain caused by thermal cycle may result in great stress inside the filter, The thermal induced stresses may promote the nucleation and the propagation of **microcracks** leading to the **final** fatigue fracture failure of the ceramic filters,

Phase V - Measurement on pulse intensity and optimization on back pulse system design

The negative pressure is generated within the filter test chamber with the use of the diaphragm sealing technique. Therefore, the back pulse pressure can be created at various pressure ranges, sealed by the diaphragm per the vacuum pressure level maintained in the filter chamber. The testing for the measurement of the pressure distribution of the back pulse is under way. Parameters for back pulse jet optimization has complete planning.

Results

Material laboratory analysis indicates that the outer layer of used filters have different phase structure than its inner layers due to filtration of foreign materials at very high temperature gradient. The main thermal attack tied to the back pulse cleaning did change the grain orientation and spacing of microstructure of the filters. The permeability of used filters varies randomly compared with the unused ones. These variations is also responsible for the nonuniform gas flow pressure field found in the filter test chamber.

Back pulse induced micro-cracks can be reduced by providing heated back pulse stream to reduce the temperature gradient within the filter. Back pulse cleanup efficiency can be improved by optimizing the back pulse system design, Figure 3,4 and 5 display the finite element simulation of thermal analysis, Figure 6, 7, 8 and 9 display the material study results. Filter permeability test data are attached in Appendix A.

The test data indicated that the unused **filter** is characterized with a fairly uniform permeability distribution along its axis. The permeability distributions of the four sections along the filter axis are almost the same, However, the used filter displayed a random and nonuniform permeability distribution along filter axis and its perimeter, when both type of filters were tested under the same environment with the same test setup. The used filter displays the same or better permeability in section 111 area. But the filter permeability at area section IV area is much less than that of the unused filter **as shown in figure 10**. Along the filter chamber wall, area section 111 always display a lower pressure field and that of area IV displayed a higher pressure field. Reverse gas flows were also monitored during the gas stream **flowing** process at a **range** of pressure level close to filter section area 111, These observations were consistent with different chamber pressure levels. This indicates that the pressure field in the **filter** chamber can not be assumed with a **laminar** flow or a steady state flow for flow process simulation.

Pressure fluctuations also were observed within the candle **filter** along the axis of the filter as the gas stream filtered through the filter wall. The pressure fluctuations are also consistent with the permeability variations of the filter under tested. A small scale reverse flow were also observed within the filter cavity with a flow pattern resemble outside flow pressure field.

These findings provide insights into the different pressure **field** distributions can happen both outside and inside the filter. These changes agrees with the variations of the permeability changes of the filter after its operation in the **field**. The changes of the permeability y indicate a random pattern and the induced pressure distribution will affect the **efficiency** of particulate filtration and

the back pulse cleanup. The pressure variation is also filter chamber pressure related. At much **higher** filter chamber operation pressure, the pressure field fluctuations could be worse. More severe adverse pressure field distributions may appear in both the filter chamber and the **filter** cavity. Blind cleanup spots or dust patches may have better chances to deposit along the filter surface to generate a vicious circulation.

Thermal **cycles**, chemical attacks did generate **microcracks** along the inner surface wall of the filter. The changes of the **filter permeability** **after** its field operation make the filter assembly a **function** of time, Without a optimized dust cake removal system, nonuniform dust cake removal is inevitable, which will definitely contribute to the patching of dust cake along filter surface. The randomly distributed filter permeability and the defects of filter integrity maybe the primary causes of the failure of ceramic filters. Piled dust cake, dust pileup induced thermal and mechanical stress applied on filter clusters may be the secondary causes that caused filter failures.

At Prairie View **A&M** University, we decide that we can not afford keep testing filters at a very high operation cost without knowing the fundamental variation and mechanism of dust cake cleaning,

These test data can be served as a filter performance data base to support numerical simulation analysis, back pulse cleanup optimization and filter failure analysis, As more test data are collected at PV A&MU, it can be utilized to support researchers, including professor M. Jhon of Carnegie Mellon **Universit y** and professor G. Ahmadi of **Clarkson** University on the verification of their numerical simulation analysis for back pulse flow and particulate flow pattern per PV A&MU research setup configuration.

In the **future**, PV A&MU **will** also report all of the test data to **D.O.E.** to support filter research institutes and filter industry for as required.

The research efforts planned at PV A&MU in the **future will** include the following areas:

- Measurement of filter permeability and flow rate under controlled environments on various filters.
- Measurement of back pulse pressure distribution in filter chamber for candle filters with and without dust cake
- Back pulse pressure distribution studies for unused and used filters for back pulse cleaning design optimization.
- Pressure field measurement for filter cluster during back pulse cleaning process.
- The optimization on back pulse system design.

Application and Benefits

Even dust layer deposition on filter is particle size and cohesive force dependent, an **efficient** dust cake removal system can help prevent excessive dust cake deposit on filter surface and eliminate ash bridging problems contributing to the failures of ceramic filters, Thermal induced load which damaged candle filters could be eliminated as ash bridging disappears. Test data collected by this research program can help filter researchers verify the accuracy of their numerical simulation results prior to extensive simulation on filter system design and analysis.

Future Activities

More measurements and analysis will be performed on filter clusters within a bench scale filter chamber to help optimize the back pulse plenum system design,

Acknowledgements

We would like to thank our Contracting **Officer's** Representative, **Dr. Norman Holcombe**, filter cluster leaders, **Dr. T. K. Chiang** and Dr. Duane Smith, and Mr. Charlie Komar as well as the management at **DOE/METC** for their extensive support on this research program and made our visits to other research institutes and filter industries possible for helpful technical discussions. Special thanks to Mr. Komar for all of his efforts in helping establish Hot Gas Cleanup (**HGCU**) research program at Prairie View A&M University.

References

Alvin, M. A., Tressler, R. E., Lippert, T. E., Diaz, E.S. and Smeltzer, E. E., 1994, "Durability of ceramic filter" Proceedings of the Coal Fired Power System 93- Advances in IGCC and PFBC Review Meeting, U.S. Department of Energy

Bruck, G.J. and Isaksson Juhani, 1994, "Karhula Hot Gas Cleanup Test Results" Proceedings of the Coal Fired Power System 93- Advances in IGCC and PFBC Review Meeting, U.S. Department of Energy

Goldsmith, R. L., September, 1992, "Ceramic Filters for Removal of Particulate from Hot Gas Streams", Proceedings of the Twelfth Annual Gasification and Gas Stream Systems Contractors Review Meeting, Volume 1

Heather M. McDaniel, Ronald K Staubly, Venkat K, Venkataraman, June, 1994, "Proceedings of the Coal Fired Power System 94- Advances in IGCC and PFBC Review Meeting" Volume 1, U.S. Department of Energy

Smoot, L.D. and Smith, P. J., 1985, "Coal Combustion and Gasification" Plenum Press, New York, NY

Klignspor, J.C. and Cope, D., FGD Handbook, May, 1987, "Flue Gas Desulfurization Systems" ICEAS/B5, International Energy Agency Coal Research, London, United Kingdom

Mei, D., 1995, "Characterization and Testing of Ceramic Filter and Dust Cake for Hot Gas Cleanup Program", Summer Research Study report presented at METC, United States Department of Energy

Pontitus, D.H. and Starrett, H. S., 1994 "Properties of Ceramic Candle Filters" Proceedings of the Coal Fired Power Systems 93- Advances in IGCC and PFBC Review Meeting, U.S. Department of Energy

Zievers, J. F., Eggerstedt, P. M., Aguilar, P.C. and Zievers, E. C., 1993, "Some Ceramic Options" Proceedings of the Coal Fired Power Systems 93- Advances in IGCC and PFBC Review Meeting, U.S. Department of Energy

APPENDIX A

PERMEABILITY TEST DATA OF UNUSED AND USED FILTERS

UNUSED FILTER

SECTION 1 EXPOSED SECTION 2 EXPOSED SECTION 3 EXPOSED SECTION 4 EXPOSED

| Time(min) | Press(psi) | Time(min) | Press(psi) | Time(min) | Press(psi) | Time(min) | Press(psi) |
|-----------|------------|-----------|------------|-----------|------------|-----------|------------|
| 0.00 | 10.72 | 0.00 | 10.79 | 0.00 | 10.65 | 0.00 | 10.37 |
| 0.50 | 5.08 | 0.50 | 5.12 | 0.50 | 5.01 | 0.50 | 4.96 |
| 1.00 | 2.43 | 1.00 | 2.48 | 1.00 | 2.37 | 1.00 | 2.35 |
| 1.50 | 0.69 | 1.50 | 0.75 | 1.50 | 0.70 | 1.50 | 0.63 |
| 1.68 | 0.00 | 1.75 | 0.00 | 1.71 | 0.00 | 1.69 | 0.00 |

SECTION 1 EXPOSED SECTION 2 EXPOSED SECTION 3 EXPOSED SECTION 4 EXPOSED

| Time(min) | Press(psi) | Time(min) | Press(psi) | Time(min) | Press(psi) | Time(min) | Press(psi) |
|-----------|------------|-----------|------------|-----------|------------|-----------|------------|
| 0.00 | 15.40 | 0.00 | 15.13 | 0.00 | 15.34 | 0.00 | 15.63 |
| 0.50 | 10.85 | 0.50 | 10.59 | 0.50 | 10.88 | 0.50 | 10.92 |
| 1.00 | 4.95 | 1.00 | 4.78 | 1.00 | 4.85 | 1.00 | 5.02 |
| 1.50 | 2.10 | 1.50 | 2.15 | 1.50 | 1.98 | 1.50 | 2.05 |
| 2.00 | 0.48 | 2.00 | 0.33 | 2.00 | 0.36 | 2.00 | 0.44 |
| 2.11 | 0.00 | 2.08 | 0.00 | 2.10 | 0.00 | 2.18 | 0.00 |

UNUSED FILTER

SECTION 1 EXPOSED SECTION 2 EXPOSED SECTION 3 EXPOSED SECTION 4 EXPOSED

| Time(min) | Press(psi) | Time(min) | Press(psi) | Time(min) | Press(psi) | Time(min) | Press(psi) |
|-----------|------------|-----------|------------|-----------|------------|-----------|------------|
| 0.00 | 20.27 | 0.00 | 20.39 | 0.00 | 20.22 | 0.00 | 20.37 |
| 0.50 | 16.14 | 0.50 | 16.09 | 0.50 | 16.17 | 0.50 | 16,10 |
| 1.00 | 11.29 | 1.00 | 11,33 | 1.00 | 11.23 | 1.00 | 11,29 |
| 1.50 | 6.59 | 1,50 | 6.61 | 1,50 | 6.58 | 1.50 | 6.77 |
| 2.00 | 2.98 | 2.00 | 2.93 | 2.00 | 2.88 | 2.00 | 3,02 |
| 2.50 | 0.82 | 2.50 | 0.84 | 2,50 | 0.78 | 2.50 | 0.85 |
| 2.72 | 0.00 | 2.75 | 0.00 | 2,68 | 0.00 | 2,70 | 0.00 |

USED FILTER

SECTION 1 EXPOSED SECTION 2 EXPOSED SECTION 3 EXPOSED SECTION 4 EXPOSED

Time(min) Press(psi) Time(min) Press(psi) Time(min) Press(psi) Time(min) Press(psi)

| | | | | | | | |
|------|-------|------|-------|-------------|-------|------|-------|
| 0.00 | 10,79 | 0.00 | 10.75 | 0,00 | 10.75 | 0.00 | 10,63 |
| 0.50 | 7.57 | 0.50 | 5.98 | 0.50 | 4.55 | 0.50 | 8.44 |
| 1.00 | 5.66 | 1.00 | 2.94 | 1.00 | 2.89 | 1.00 | 7.31 |
| 1.50 | 4.08 | 1,50 | 1.83 | 1.50 | 1,53 | 1.50 | 6.05 |
| 2.00 | 2.84 | 2,00 | 0,29 | 1.85 | 0.00 | 2.00 | 4.78 |
| 2.50 | 0,87 | 2.13 | 0.00 | | | 2.50 | 3.28 |
| 2.86 | 0.00 | | | | | 3.00 | 1.11 |
| | | | | | | 3,50 | 0.12 |
| | | | | | | 3.70 | 0.00 |

SECTION 1 EXPOSED SECTION 2 EXPOSED SECTION 3 EXPOSED SECTION 4 EXPOSED

Time(min) Press(psi) Time(min) Press(psi) Time(min) Press(psi) Time(min) Press(psi)

| | | | | | | | |
|------|-------|------|-------|-------------|-------|-------------|-------|
| 0,00 | 15,86 | 0.00 | 15,38 | 0.00 | 15.82 | 0.00 | 15.80 |
| 0,50 | 10.66 | 0.50 | 12.82 | 0.50 | 12.23 | 0.50 | 12.13 |
| 1,00 | 6.85 | 1.00 | 7.81 | 1.00 | 7.37 | 1.00 | 9.14 |
| 1,50 | 3.72 | 1.50 | 4.37 | 1.50 | 3.01 | 1.50 | 6.58 |
| 2.00 | 1.62 | 2,00 | 1,86 | 2.00 | 0.87 | 2.00 | 4.49 |
| 2.50 | 0.41 | 2.50 | 0.49 | 2.40 | 0,00 | 2.50 | 2.78 |
| 3.00 | 0.00 | 2.61 | 0.00 | | | 3.00 | 1.48 |
| | | | | | | 3.50 | 0,60 |
| | | | | | | 4.00 | 0.12 |
| | | | | | | 4.25 | 0.00 |

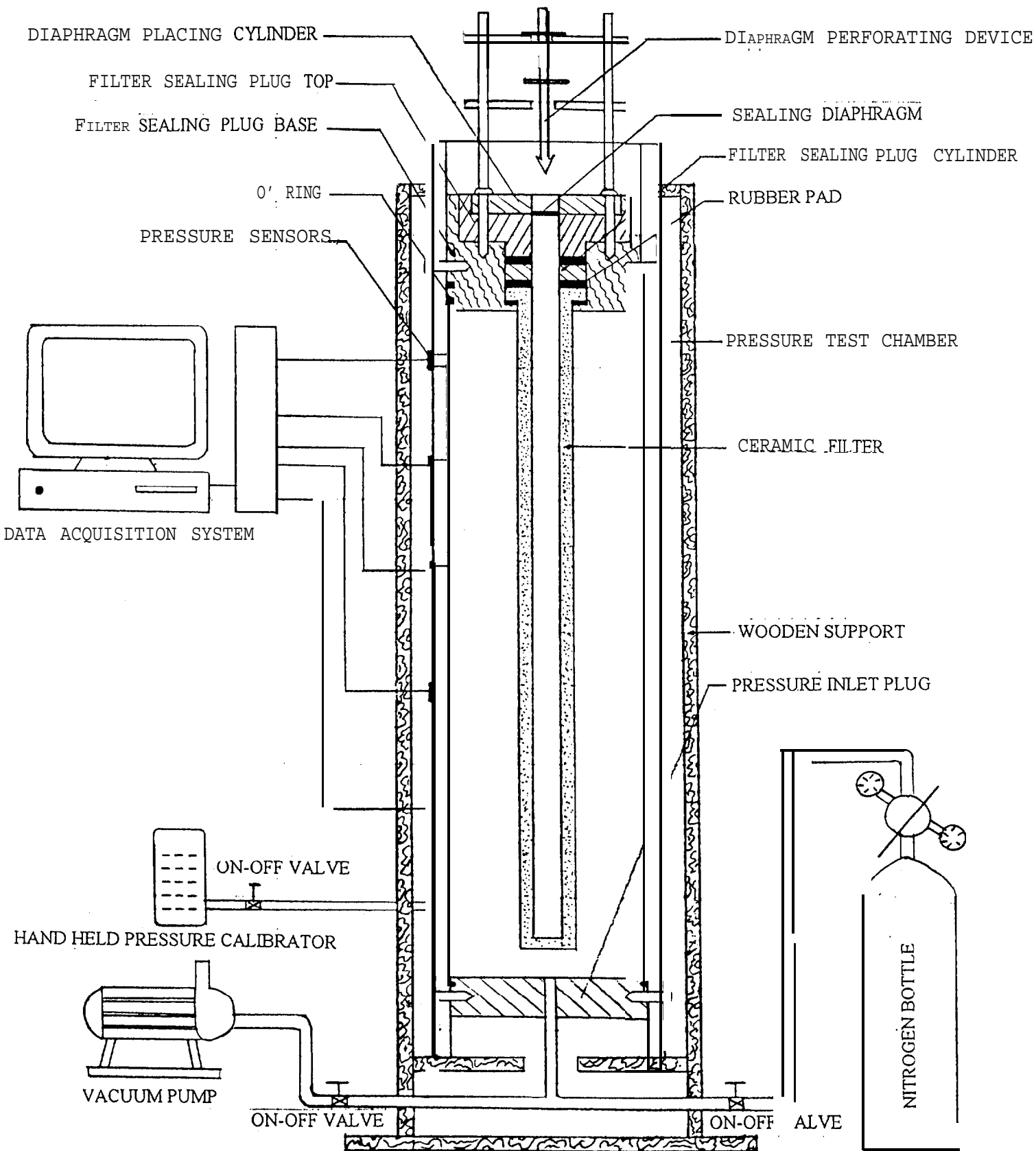

Fig. 1 SCHEMATIC DIAGRAM FOR UNUSED AND USED CERAMIC FILTER TEST

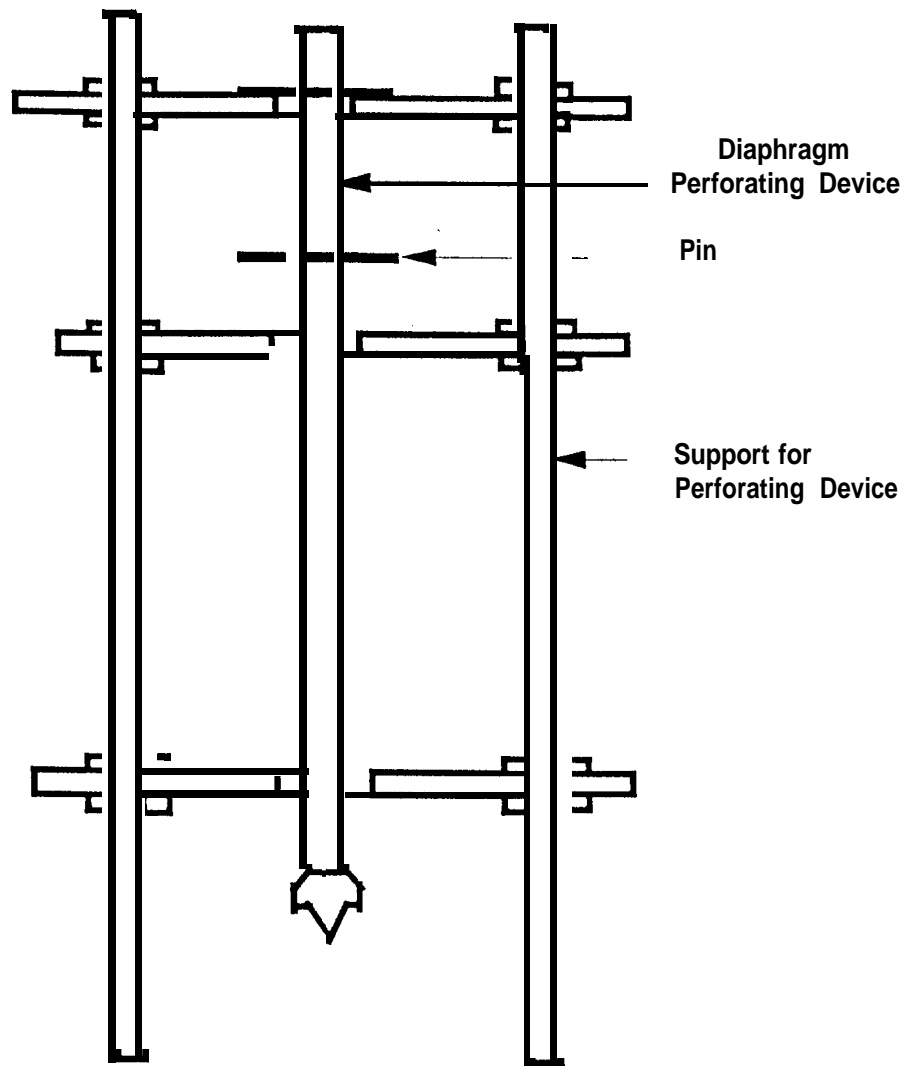

Figure 2 : Pressure Sealing Diaphragm Perforating Device

ANSYS 5.0 A 20
JUN 25 1996
13:14:11
PLOT NO. 1
ELEMENTS
TYPE NUM

XV =-0.298836
YV =-0.429547
ZV =-0.852166
*DIST=0.738934
*XF =0.046958
*YF =0.055429
*ZF =0.728796
A-ZS=-56.38
CENTROID HI=DEN

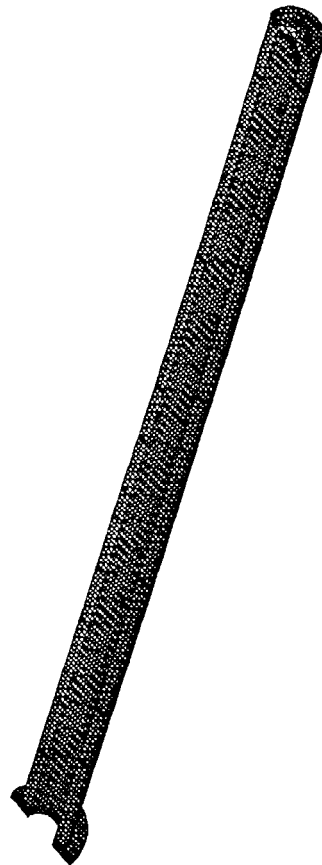
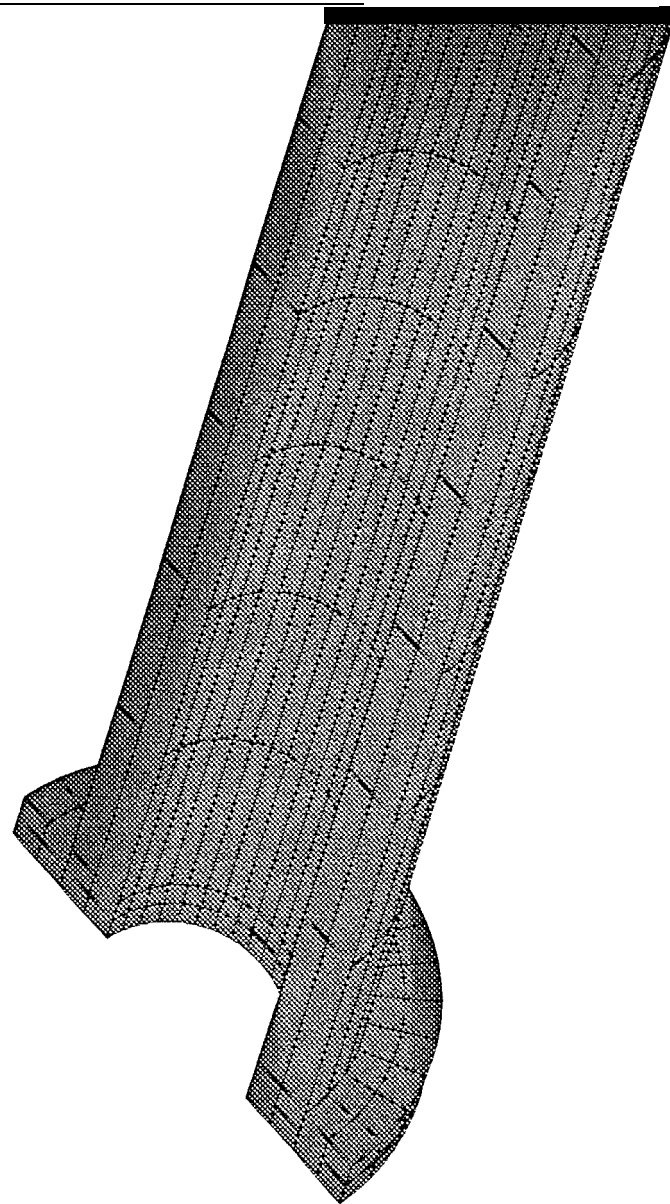

Fig. 3 Model of the filter













ANSYS 5.0 A 20
JUN 25 1996
18:10:15
PLOT NO. 1
ELEMENTS
TYPE NUM

XV = -0.298834
YV = -0.429547
ZV = -0.852166
*DIST = 0.131514
*XF = -0.168714
*YF = -0.246198
*ZF = 0.954447
A-ZS = -56.38
CENTROID HIDDEN

Fig. 4 Blow up of the model (Filter) near the neck with element meshing

ANSYS 5.0 A 20
JUN 26 1996
09:16:20
PLOT NO. 1
NODAL SOLUTION
STEP=1
SUB =1
TIME=1
TEMP
TEPC=2.024
SMN =405.75
SMX =567.369

| | |
|---|---------|
|  | 405.75 |
|  | 423.707 |
|  | 441.665 |
|  | 459.623 |
|  | 477.58 |
|  | 495.538 |
|  | 513.496 |
|  | 531.454 |
|  | 549.411 |
|  | 567.369 |

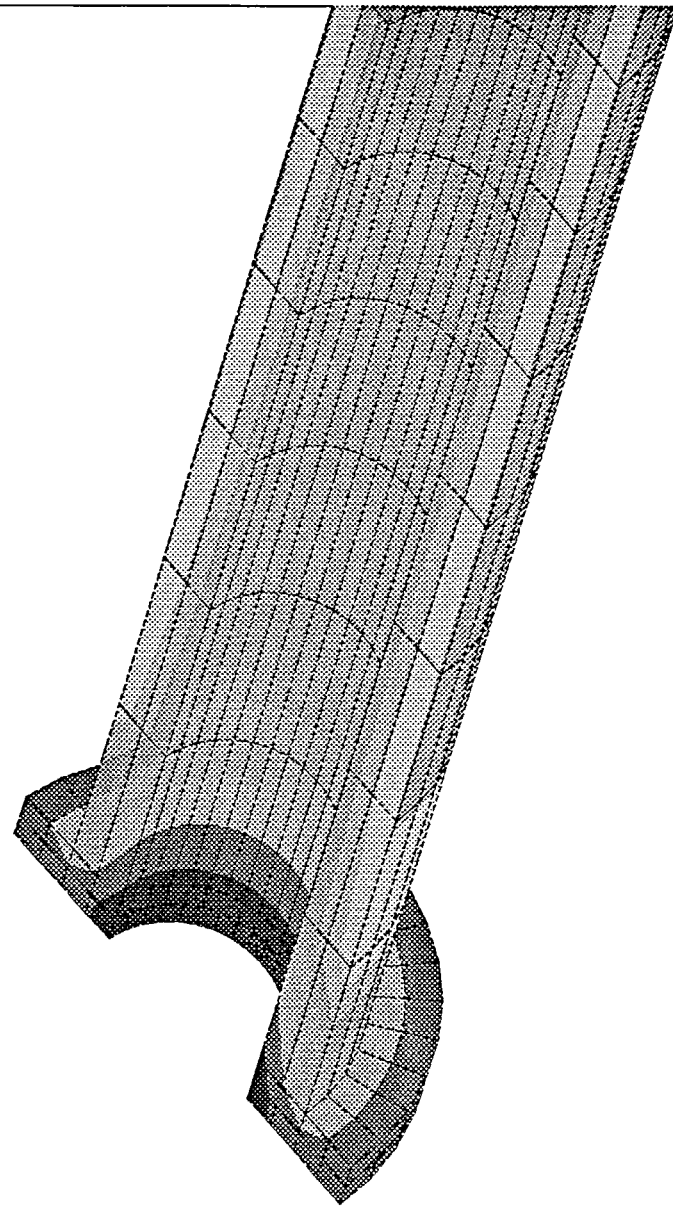

Fig. 5 Temperature contour from FEM ANALYSIS



(a)



(b)



(c)

Figure 6 (a) Metallographic photo of the unused ceramic filter showing the double layer structure, x80, (b) Microstructure of the inner layer of unused and (c) used ceramic filters, x200.

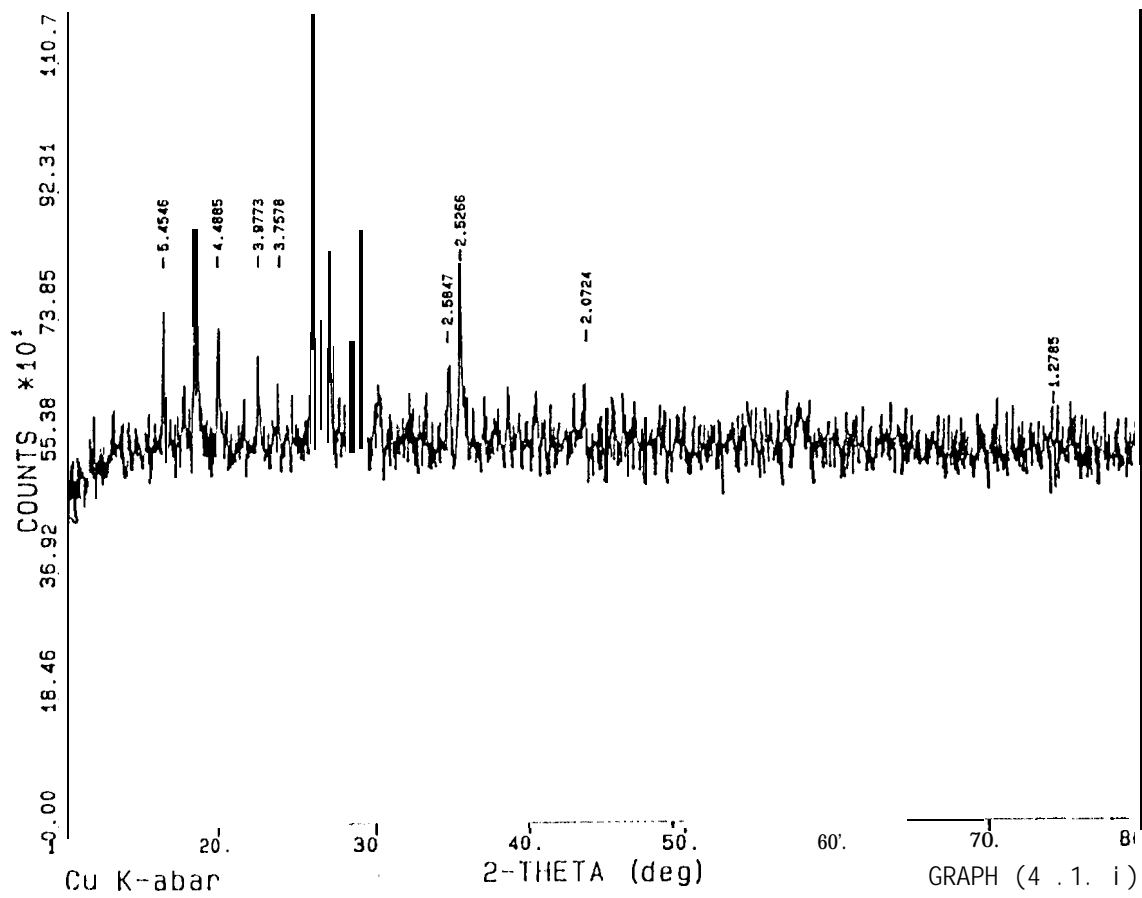

Figure 7 XRD spectrum of the deposition and reaction layer on the surface of the used ceramic filter,

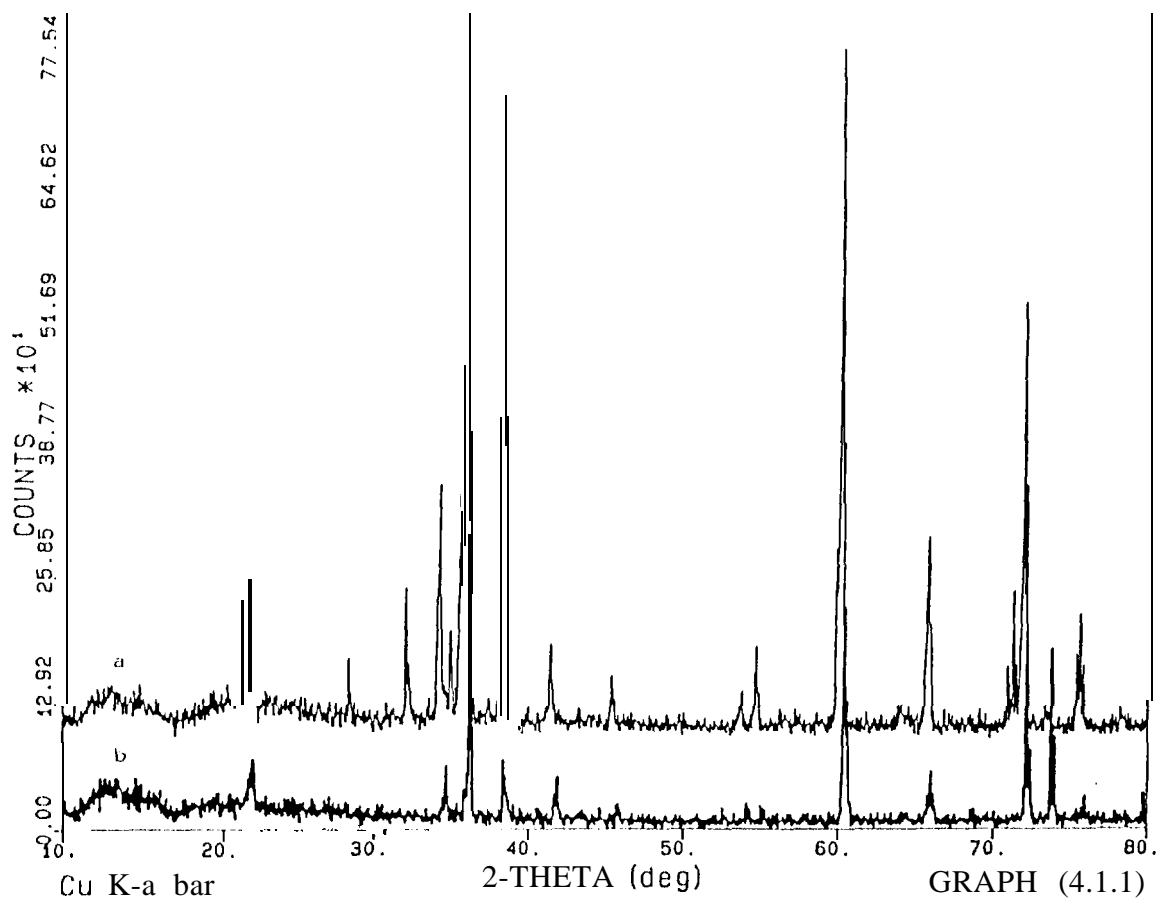

Figure 8 XRD spectra of the outer layers of (a) the used and (b) the unused ceramic filters, showing changes in crystal plane spaces after usage.

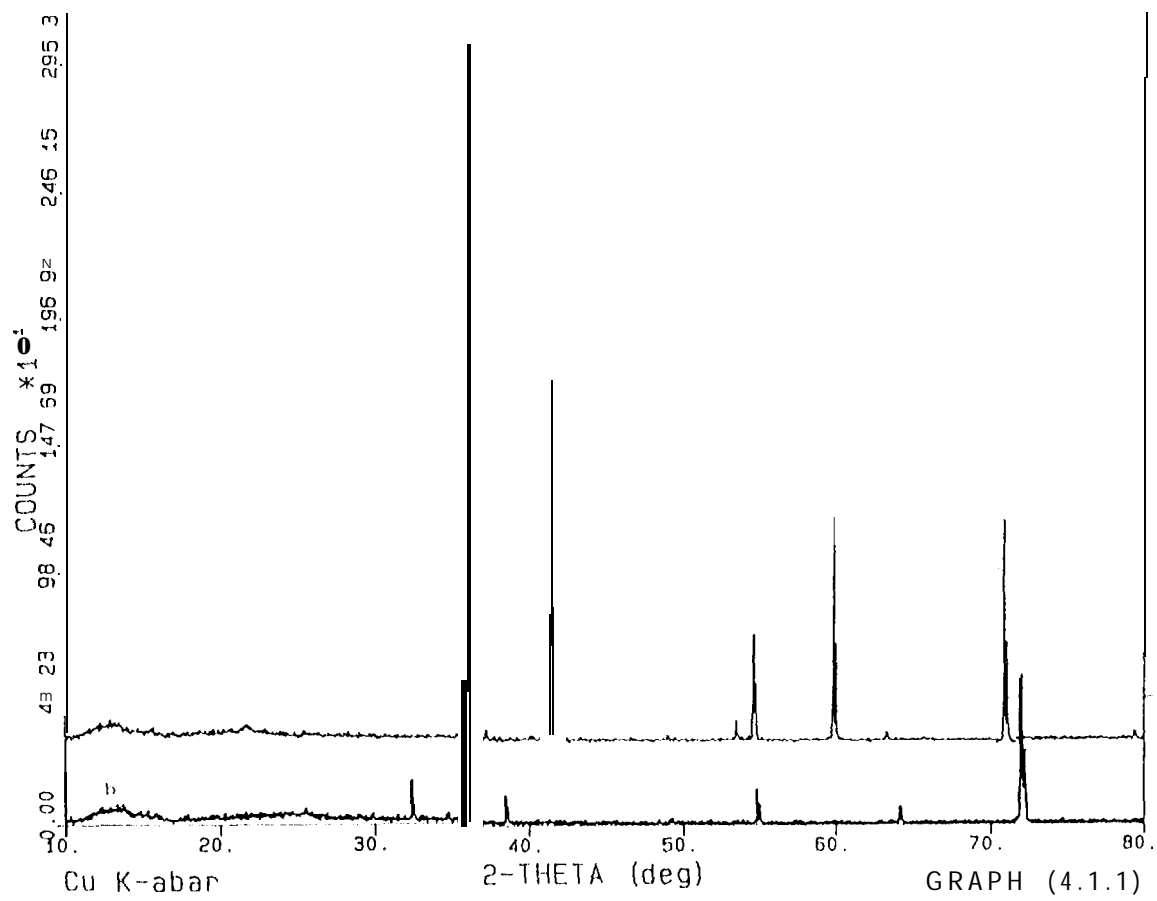

Figure 9 XRD spectra of the inner layers of (a) the used and (b) the unused ceramic filters, showing changes in crystal plane spaces and orientation after usage.

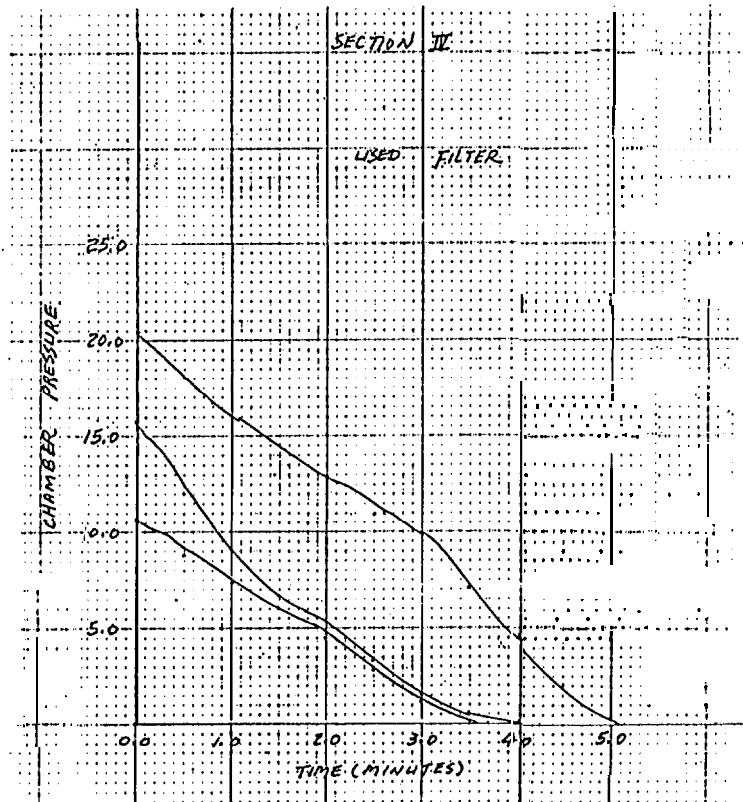
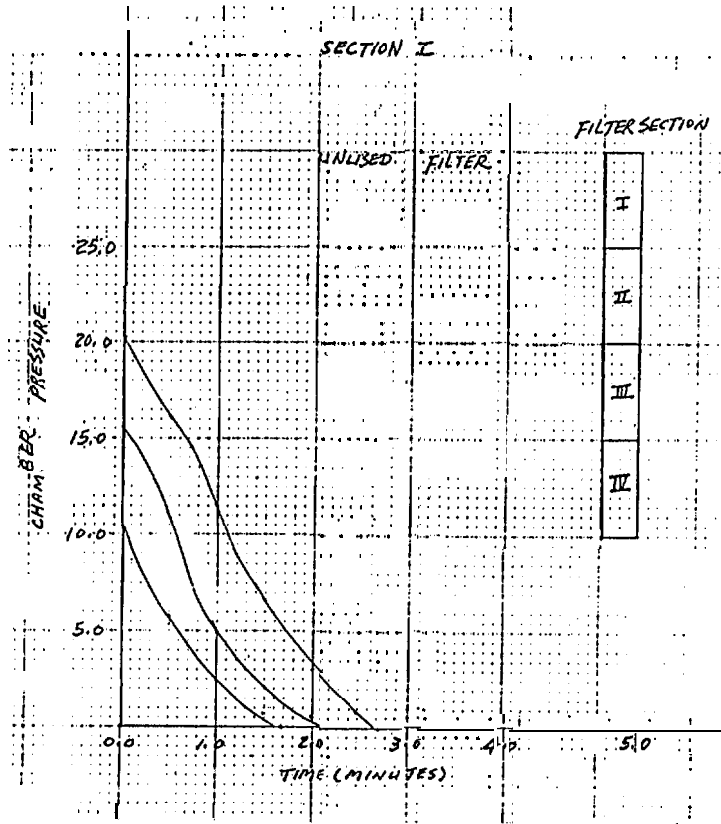

Figure 10: Filter permeability variations of used filter compared to unused filter