



Babcock & Wilcox

a McDermott company

Alliance Research Center

**High-Solids Black Liquor Firing in Pulp and Paper
Industry Kraft Recovery Boilers**

Phase I: Final Report

Volume II— Project Technical Results

PREPARED FOR:

The United States Department of Energy

UNDER CONTRACT NO. DE-FC36-94G010002, AMENDMENT M001

SUBMITTED BY:

The Babcock & Wilcox Company

RESEARCH AND DEVELOPMENT DIVISION
ALLIANCE, OHIO 44601

NOVEMBER 1995

DISTRIBUTION OF THIS DOCUMENT IS UNLIMITED *OK*

MASTER



Babcock & Wilcox

a McDermott company

Alliance Research Center

High-Solids Black Liquor Firing in Pulp and Paper Industry Kraft Recovery Boilers

Phase I: Final Report

Volume II — Project Technical Results

PREPARED FOR:

The United States Department of Energy

UNDER CONTRACT NO. DE-FC36-94G010002, AMENDMENT M001

SUBMITTED BY:

The Babcock & Wilcox Company

RESEARCH AND DEVELOPMENT DIVISION

1562 BEESON STREET

ALLIANCE, OHIO 44601

PRINCIPAL INVESTIGATORS:

W.T. Southards, Project Manager

J.L. Clement

R.A. McIlroy

M.R. Tharp

C.L. Verrill

R.A. Wessell

NOVEMBER 1995

LEGAL NOTICE

This report was prepared by The Babcock & Wilcox Company (B&W) pursuant to an agreement partially funded by the Department of Energy (DOE), and neither B&W, nor any of its subcontractors, nor DOE, nor any person acting behalf of either:

a. makes any warranty or representation, express or implied, with respect to the accuracy, completeness, or usefulness of the information contained in this report, or that the use of any information, apparatus, method, or process disclosed in this report may not infringe privately-owned rights; or

b. assumes any liability with respect to the use of, or for damages resulting from the use of, any information, apparatus, method or process disclosed in this report.

Contents

Section	Page
1 Summary	1-1
1.1 Program Objectives	1-1
1.2 Major Results	1-1
1.3 Recommended Future Program Direction	1-2
2 Results of Phase I Recovery Furnace Simulator Preliminary Design and Related Tasks ...	2-1
2.1 RFS Preliminary Design	2-1
2.2 Numerical Modeling of the RFS	2-3
2.3 RFS Arrangement and Support System Descriptions	2-4
2.4 RFS and Program Estimated Cost	2-8
2.5 RFS Industry Support and Potential Participants	2-12
2.6 Test Planning	2-12
2.7 High-Solids Firing Economic Justification	2-16
2.8 High-Solids Liquor Properties Effect on RFS Design	2-18
3 Technical Approach for Future Work	3-1
3.1 High-Solids Firing Versus Black Liquor Gasification	3-1
3.2 B&W Gasification Approach	3-1
3.3 Advanced Combustor	3-4
4 References	4-1
Appendix A — Functional Specifications for the Recovery Furnace Simulator	
Appendix B — Recovery Furnace Simulator - Scaling Methodology	
Appendix C — Numerical Modeling Results for Phase I	
Appendix D — High-solids Black Liquor Properties	
Appendix E — Advanced Combustion Development - Test Plans	
Appendix F — Letters of Interest and Support	
Appendix G — Economic Justification Analysis	
Appendix H — Black Liquor Gasification	
Appendix I — Future Plans	
Appendix J — Technical Paper: Recovery Furnace Simulator - Design and Modeling	

FIGURES

Figure	Page
1 Simplified RFS process flow diagram	2-2
2 Relative size of the RFS furnace compared to commercial process recovery boilers	2-3
3 RFS drop fate for water compared to a commercial process recovery boiler	2-5
4 RFS drop fate for inorganics compared to commercial process recovery boiler	2-6
5 RFS gas residence time (in furnace) compared to a commercial process recovery boiler	2-7
6 RFS gas temperature (in furnace) compared to a commercial process recovery boiler	2-7
7 RFS general arrangement	2-9
8 RFS facility general arrangement of major new components	2-10
9 Program schedule phases Ia, II, III, IV	2-11
10 Letter of interest from International Paper Company	2-13
11 Letter of interest from Boise Cascade Corporation	2-14

TABLES

Table	Page
1 Cost estimate summary for RFS phases Ia, II, III, and IV	2-11
2 Summary of economic justification NPV and investment level for most attractive option - effect of total population of units converted	2-18
3 Responses to trends in pulp mill recovery needs	3-2

1

SUMMARY

1.1 Program Objectives

The project objective, summarized from the statement of work, is:

This project is a multiple phase-effort to develop technologies to improve high-solids black liquor firing in pulp mill recovery boilers. The principal means to this end is to construct and operate a pilot-scale recovery furnace simulator (RFS) in which these technologies can be tested.

The Phase I objectives are to prepare a preliminary design for the RFS, delineate a project concept for evaluating candidate technologies, establish industrial partners, and report the results.

Phase I addressed the objectives with seven tasks:

- Develop a preliminary design of the RFS.
- Estimate the detailed design and construction costs of the RFS and the balance of the project.
- Identify interested parties in the paper industry and key suppliers.
- Plan the Phase II and Phase III tests to characterize the RFS.
- Evaluate the economic justification for high-solids firing deployment in the industry.
- Evaluate high-solids black liquor property data to support the RFS design.
- Manage the project and reporting results, which included planning the future program direction.

1.2 Major Results

Phase I produced a preliminary RFS design that is

detailed enough to adequately plan the RFS final design, construction, and commissioning and to estimate the cost and schedule of Phase II. The RFS design included careful consideration of scaling to assure that test results simulate the chemical processes present in a recovery boiler.

The design is robust in that it provides significant flexibility for future modification and operation over a reasonable range of conditions. Throughout the design, proven technology was applied where possible to solve the unique problems of simulating a recovery furnace while ensuring that the design will function as planned.

Numerical modeling was used to identify and address problem areas and to evaluate the adequacy of the design to produce results that can be related to commercial scale. The level of development of the design made it possible to identify key areas affecting costs and to identify potential suppliers. Thus, supplier and internal costs are adequately reflected in the resulting estimate to design, build, and commission the RFS. Existing liquor property data were evaluated and considered in the development of the system to process the liquor and deliver it to the combustion zone of the RFS, assuring adequate performance of this critical system.

The plans for future tests address the needs to adequately characterize the RFS, to quantify the basis for development of the advanced combustor, and to establish base performance data against which the advanced combustor can be compared. Within this report, high-solids advanced combustion refers to a significant modification of the Tomlinson recovery boiler technology, (particularly the lower furnace, air system, and black liquor system) to accommo-

date firing black liquor at up to 85% solids and with increased throughput compared to current commercial designs. A confidential advanced combustor design concept was included in the proposal for this project. Assuming the project moves forward along that technical path, that concept and potentially others would be evaluated using numerical modeling. Then a selected concept would be tested in the RFS during a later phase of the project.

In addition, tests to evaluate source-specific black liquor rheology, combustion, and atomization data were planned. These tests will detect unexpected liquor rheology changes and will assure the design performs as expected. They will also provide liquor combustion and spray distribution data to support numerical modeling that will facilitate scaling RFS test results to a commercial design.

Management in two major paper companies were contacted regarding our approach to the future direction of this program. Their responses support this direction and indicate an interest in potentially providing the host site in the last program phase. In addition, they expressed interest in considering black liquor gasification as an alternative to high-solids advanced combustion. This interest was also identified in confidential company sponsored customer interviews outside this contract. We reflected this interest in our proposed program direction described in this report.

The technical work supporting these results is discussed further in this report. In addition, the appendixes further describe the path the investigation followed and the results achieved.

1.3 Recommended Future Program Direction

An on-going market evaluation conducted concurrent with, but independent of, the Phase I contract work led us to conclude that black liquor gasification is the major recovery technology competing with the high-solids advanced combustion process recovery boiler. The Babcock and Wilcox Company (B&W) had previously investigated gasification and developed a low-temperature gasifier

conceptual design. (Here, low temperature refers to operating so that the inorganic materials are recovered from the gasifier as a solid.)

Black liquor gasification holds enough promise that B&W recommends that the future course of action include further evaluation. This evaluation should investigate development of a black liquor gasification test facility based on the existing gasifier conceptual design. Because this project did not include detailed investigation of the gasifier design, the discussion of this topic is limited in this report.

The gasifier concept and background information described in this report are based on work conducted at B&W expense outside the scope of this contract. Therefore, the information presented is limited to describing how B&W recommends evaluating the design concept within the context of the future direction of this program. After an interim phase to evaluate gasification technology, a decision would be required that would consider the following options:

- Proceed with detailed design, construction, and commissioning of a recovery furnace simulator to develop high-solids advanced combustion.
- Proceed with detailed design, construction, and commissioning of a black liquor gasifier development facility to develop black liquor gasification.
- Do not proceed with further work in this area.

B&W also considered the option of building a combined RFS/gasifier development facility. While this option provides the most flexibility, it would be considerably more expensive. Therefore, B&W recommends selecting a single technology, either high-solids advanced combustion or black liquor gasification, based on the Phase I results and the investigation of gasification. This will permit reaching the end point of a commercial product more quickly and cost effectively. If alternate use of the test facility to work on the remaining technology or other recovery technologies becomes more attractive in the future, the facility could be modified at that time.

2

RESULTS OF PHASE I RECOVERY FURNACE SIMULATOR PRELIMINARY DESIGN AND RELATED TASKS

In keeping with the overall program objective, an RFS preliminary design was developed using the conceptual design described in the project proposal as a starting point. The results of this investigation and those from the related and supporting tasks to complete this phase of the work are described in this section. Significantly more detail for each area of investigation is provided in the appendixes.

2.1 RFS Preliminary Design

A preliminary design of the RFS and associated support equipment was prepared. The RFS is based on a black liquor input that will produce a base design thermal capacity of 6 million Btu/hr, but the support systems (air, liquor, smelt, and flue gas handling) are sized to sustain up to 12 million Btu/hr. This provides the flexibility for high-capacity testing of advanced combustion concepts.

The heart of the facility and primary focus of the research is the combustion equipment or RFS and its coupling with the high-solids black liquor concentrator and delivery system. The RFS design was adapted and scaled from current recovery boiler technology. The black liquor concentrator will be procured from a leading industry supplier with proven capability. A final supplier has not been selected, but three leading suppliers expressed interest and provided preliminary equipment specifications and budgetary quotations used to plan the project.

The RFS design is based on installing the pilot facility at B&W's Alliance Research Center (ARC). This location offers the advantages of close proximity to expertise needed for the development work and support services, availability of an existing

structure and existing equipment, access to all support utilities, and reasonable proximity of potential black liquor suppliers. The small size of the facility compared to the capacity of mills that may supply black liquor minimizes the impact of RFS operations on the supplier mill. The RFS provides greater testing flexibility at lower costs than analogous field testing on operating recovery boilers.

A schematic block diagram of the facility that depicts the major process flows and systems is shown in Figure 1. The six major systems in the facility are:

- Black liquor receiving
- Black liquor concentration and handling
- RFS air supply
- RFS (including convection pass)
- Smelt handling
- Flue gas handling and discharge.

Each system is described briefly here and in more detail in Appendix A. A copy of the technical paper describing the RFS and numerical modeling results used to evaluate its design is included in Appendix J.

The black liquor receiving system will receive black liquor at nominally 50% solids via tank truck from the supplier mill, provide on-site storage, maintain liquor temperature control as needed, and route the liquor to the concentration and handling system. The major requirements for this system are to support continuous facility operation by storing a full tanker load of black liquor as a minimum and to provide environmental controls to contain any spills and fugitive emissions.

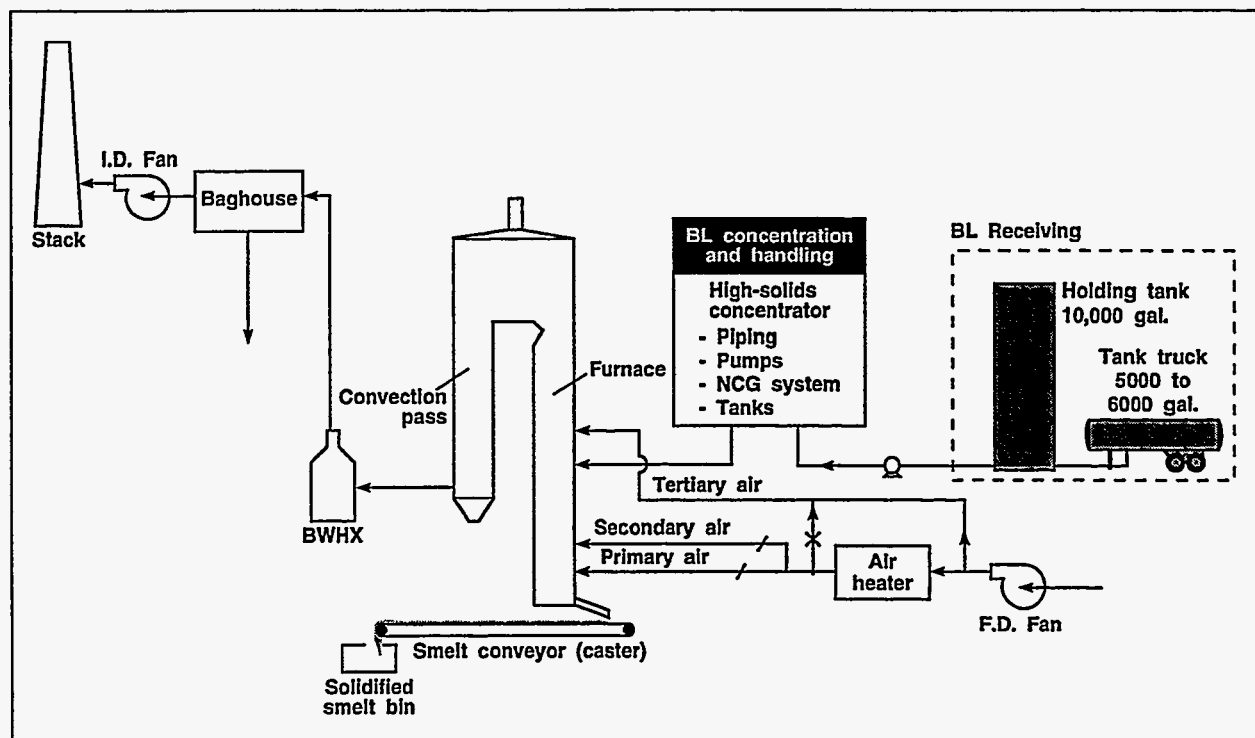

Figure 1. Simplified RFS process flow diagram.

The black liquor concentration and handling system consists of the concentrator, piping, tanks, valves, instrumentation, and controls needed to safely and effectively supply concentrated black liquor to the RFS. The base design conditions are to supply liquor at 65% to 71% solids when the incoming liquor is at 50% solids.

The system design will also provide high-solids liquor (85% solids) at the base design capacity (6 million Btu/hr). It will also provide liquor for high-capacity, 12 million Btu/hr heat input, at high solids (85%) for several hours by using a two-step concentration process with intermediate storage at nominally 65% solids concentration. Appendix A includes a discussion of the concentrator sizing rationale and a summary of heat and material balances that set concentrator performance for the base design, high-capacity, and high-solids and high-capacity conditions.

The process flow diagram (PFD) included in Appendix A identifies the major process stream flows and conditions and the major components of this and other systems. The process and instrumenta-

tion diagrams (P&IDs) contained in Appendix A identify the process instrumentation, controls, and equipment, for this and other systems. Three leading suppliers responded to requests for budgetary quotations to supply the black liquor concentrator. These suppliers use different design approaches that include two major classes of commercial concentrators -- a forced-circulation crystallizer design and a falling-film design.

The RFS design includes a three-level air system, analogous to modern commercial process recovery boilers, but with significantly greater flexibility to explore firing strategies. The primary and secondary air are introduced in the lower furnace at 300°F for nominal operating conditions and can be heated to as high as 500°F if desired for other test conditions. The tertiary air is introduced higher in the furnace and will be near ambient temperature (110°F) normally, but tempered air can also be used alone or blended with ambient air to provide a range of temperatures.

The RFS will share an existing forced-draft fan and gas-fired air heater with an adjacent test facility.

Provision is included to isolate the other test facility when the RFS is in use and *vice versa*. The air system includes appropriate dampers for balancing and controlling flow and the instrumentation needed to control operation and collect test data.

The RFS was designed to simulate the major features of a modern commercial recovery boiler. The scaling methods described in Appendix B focus on developing a base design that would reproduce the chemical processes in conventional chemical recovery boilers. At the reduced scale, the design cannot accurately reproduce commercial black liquor firing practice or heat removal technology. However, selection of appropriate refractory permits adequate control of the heat release. The base design firing rate was set at 6 million Btu/hr to provide a cost-effective, pilot-scale furnace while being of sufficient size to permit scaling of results.

B&W experience in fossil fuel combustion has

demonstrated that facilities sized for this firing rate provide results that can be reasonably related to commercial applications. Practical limitations also support selection of capacity near this level. The relative size of the RFS from the floor to the nose, compared to commercial units, is illustrated in Figure 2. In this figure, the unit capacities are shown in pounds of dry solids per day, and the simple boxes show the furnace width, depth, and height to the nose to illustrate relative furnace volumes.

2.2 Numerical Modeling of the RFS

Numerical modeling was used to screen furnace design options and evaluate the ability to scale results of the RFS to commercial units. The RFS was compared with a representative commercial process recovery boiler (reference commercial unit) of modern design using the numerical modeling results. Extensive field data and numerical modeling results are available for this reference commer-

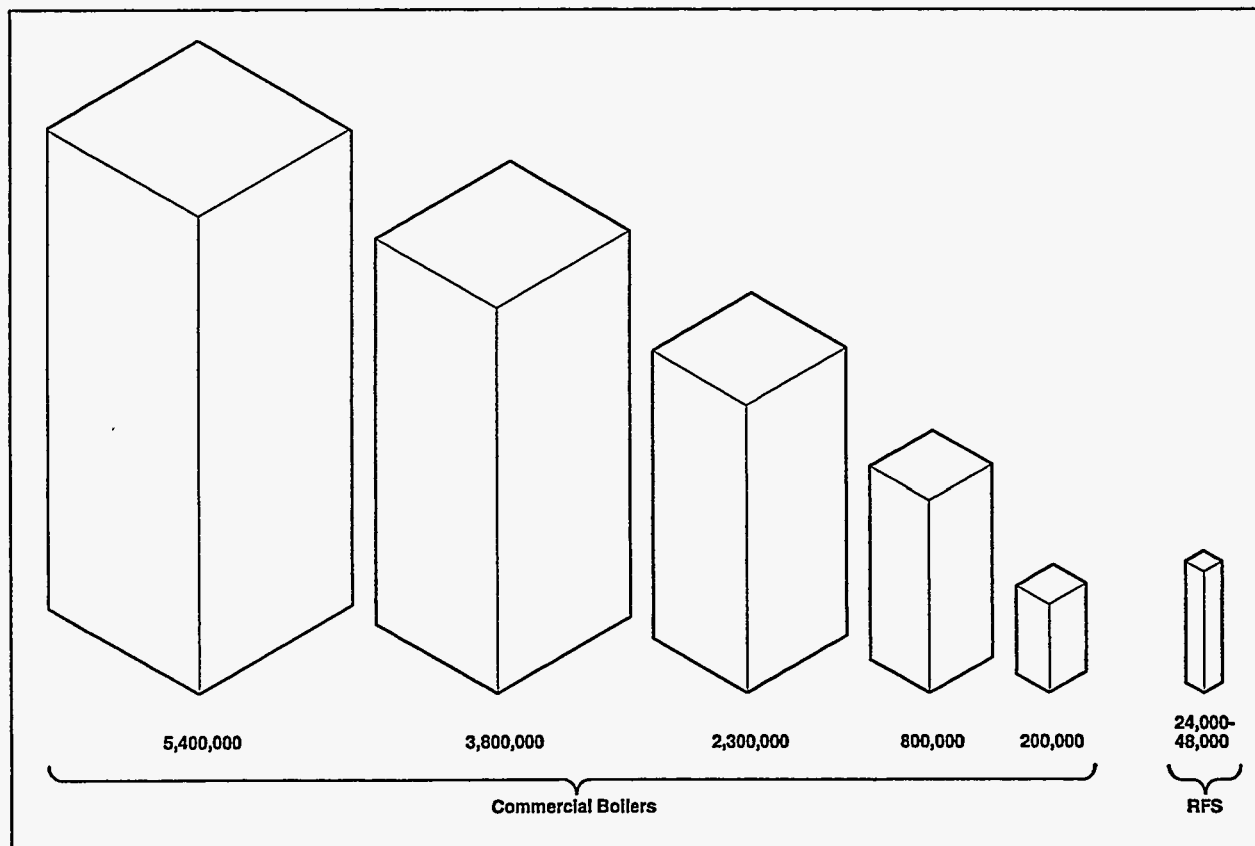

Figure 2. Relative size of the RFS furnace compared to commercial process recovery boilers.

cial unit. Comparison of the numerical modeling results for the RFS with the reference commercial unit demonstrate that the RFS would be well suited for experimental simulation of black liquor combustion. Key areas of similarity included:

- Black liquor distribution, or drop fate, within the unit; that is, where major liquor constituents were evolved, reacted, or deposited.
- Average gas temperature and residence time profiles along the main flow direction of the furnace.
- Chemical environment of the lower and upper furnace.

Selected numerical modeling results are provided in Figures 3 through 6. Drop fate (liquor distribution) plots are shown in Figures 3 and 4. In the numerical model, black liquor is treated as consisting of four constituents: water, volatiles, char, and inorganics. Black liquor drops are tracked by the numerical model. This enables the investigator to determine the "fate" of the liquor drop constituents -- where drying, devolatilization, char burning, and inorganic deposition occur.

Considering two of these constituents, water and inorganics, Figure 3 shows the fate of the water constituent, and Figure 4 the fate of the inorganic constituent in the RFS and the commercial reference unit. The two figures show where the constituent of interest is evolved (or deposited) for drops over the range of relative drop sizes. The relative drop size refers to the ratio of the initial drop size to that of the mass median drop size for the initial spray distribution. Note that the scaled design of the RFS requires the mass median drop size to be approximately one-third of that in the commercial unit. The "drop fate" or possibilities of where the constituent may be evolved (or deposited) for drops entering the furnace and tracked through their trajectories include: in-flight, walls, bed, and exit. These plots provide a graphical representation of these results, with the regions shown representing the following for the constituent considered:

- The "in-flight" region represents the constituent fraction (as a function of relative drop size) evolved from drops while suspended in the furnace gas.

- The "walls" region represents the constituent fraction (as a function of relative drop size) deposited on the furnace walls.
- The "bed" region represents the constituent fraction (as a function of relative drop size) deposited on the char bed located on the furnace floor.
- The "exit" region represents the constituent fraction (as a function of relative drop size) that exits the furnace with the flue gas.

The RFS and reference commercial unit were modeled at similar operating conditions. These figures illustrate that the RFS black liquor distribution reasonably represents commercial results. When comparing the results, it is important to consider that the RFS processes approximately 7% of the black liquor processed by the commercial unit. Also, the RFS liquor nozzle and gun design was not optimized to simulate the walls/bed distribution of the reference commercial unit.

The RFS gas residence time and gas temperature are compared to the reference commercial unit operating at two different firing conditions (Comm. 1 and Comm. 2) in Figures 5 and 6. In both plots, the relative elevation refers to the elevation from the furnace floor to the point of interest divided by the elevation from the furnace floor to the furnace nose. These results indicate that the RFS provides good simulation of the residence time and the temperature profile compared to the referenced commercial unit.

Beyond evaluating design options for adequate simulation, numerical modeling of the RFS identified the problem of the combustion gases being entrained by the liquor spray in the early RFS configurations. A change to a liquor nozzle with a lower exit velocity at the same flow rate minimized this effect. The modeling results also illustrate the potential to use the RFS to produce data for future model validation. The modeling results are detailed in Appendix C.

2.3 RFS Arrangement and Support System Descriptions

The recovery furnace simulator general arrangement is shown in Figure 7. The RFS was scaled to

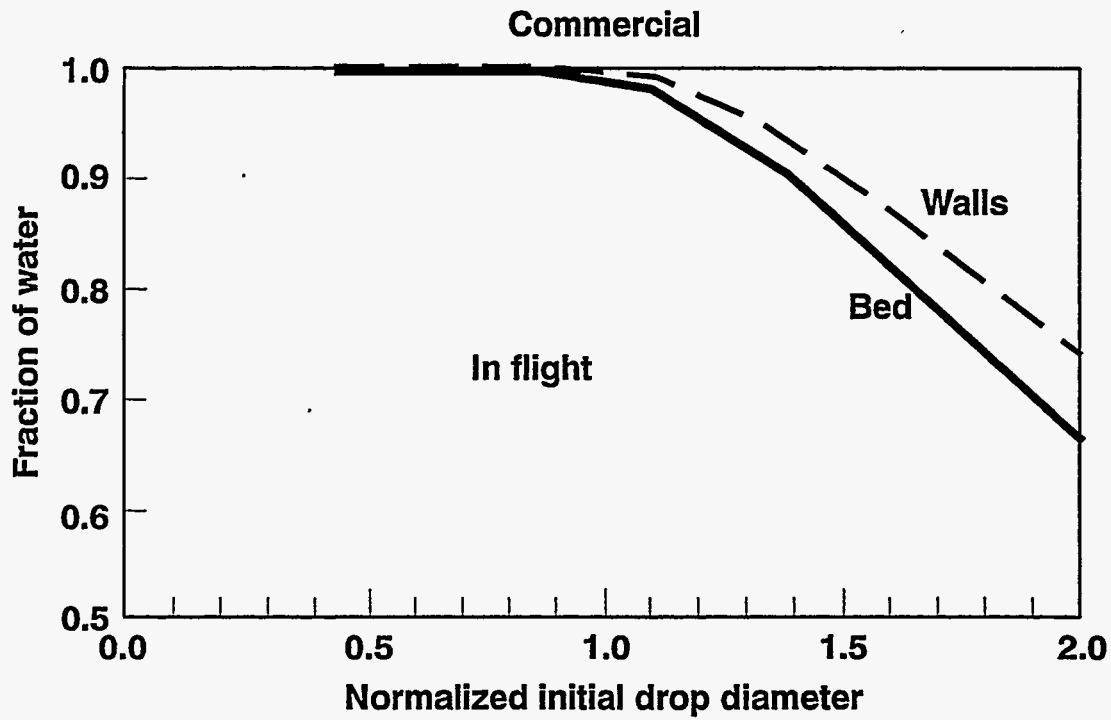
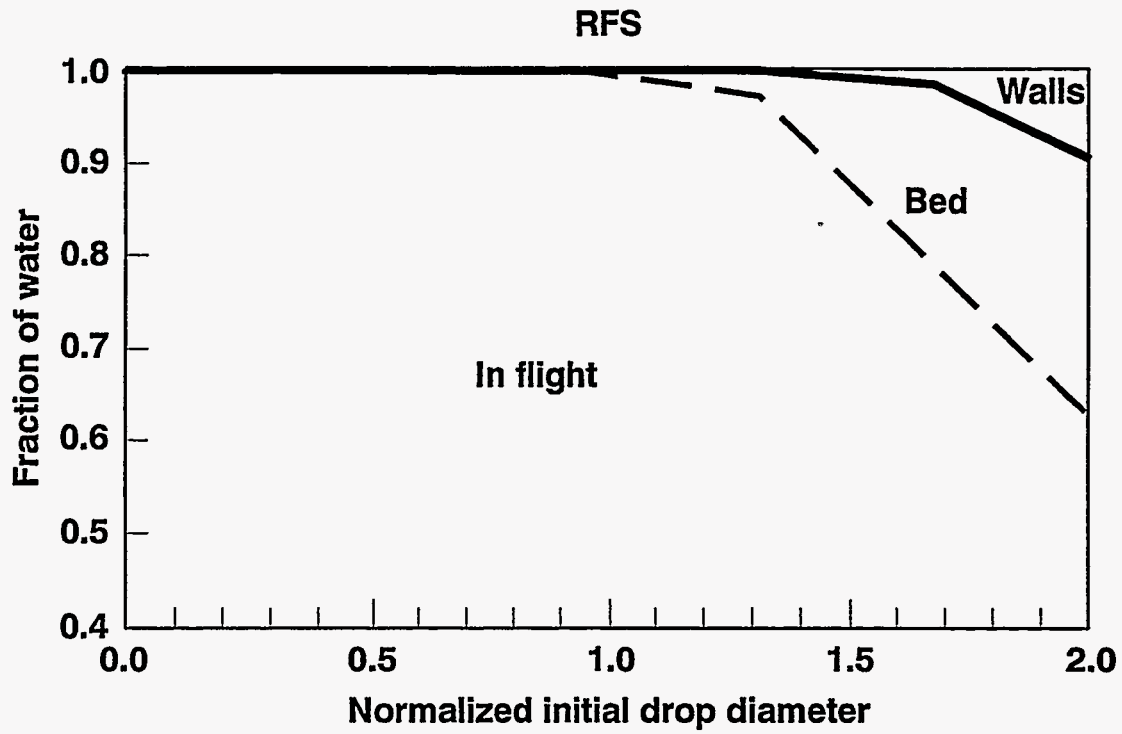

Figure 3. RFS drop fate for water compared to a commercial process recovery boiler.

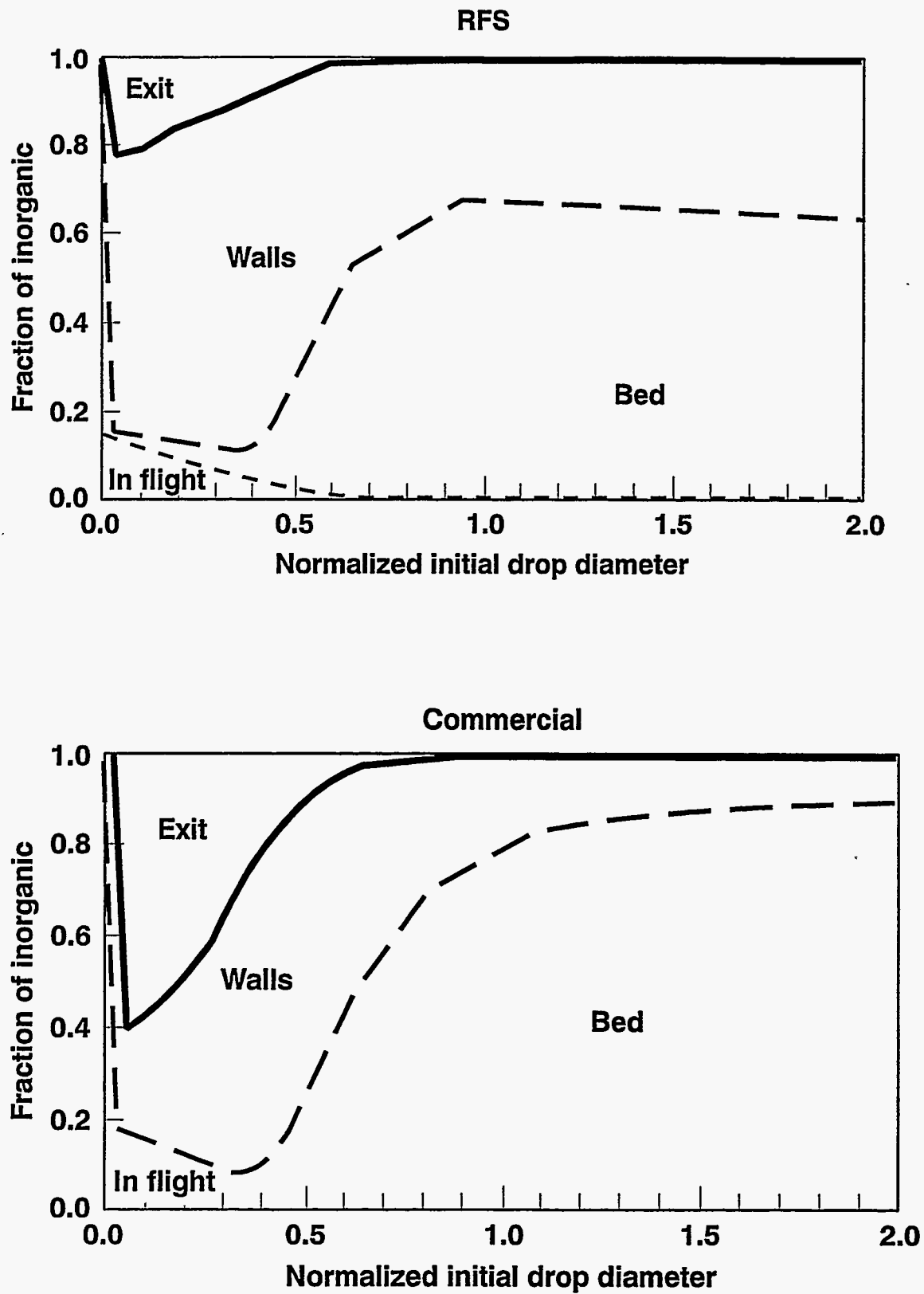

Figure 4. RFS drop fate for inorganics compared to commercial process recovery boiler.

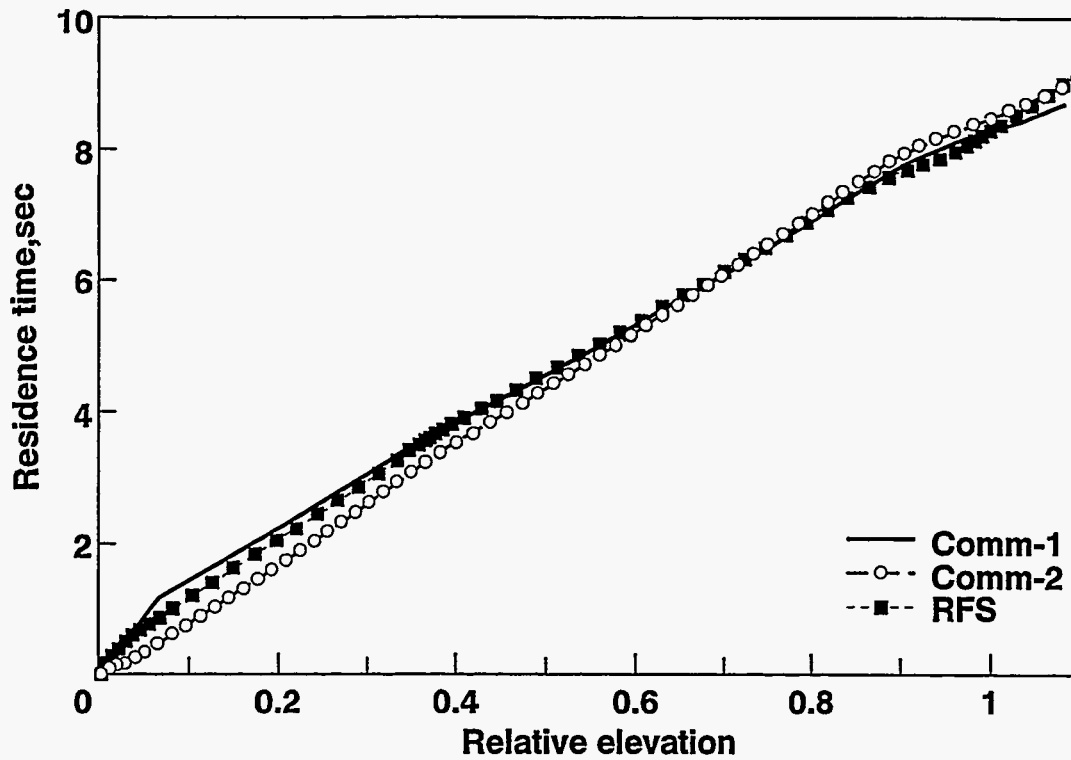

Figure 5. RFS gas residence time (in furnace) compared to a commercial process recovery boiler.

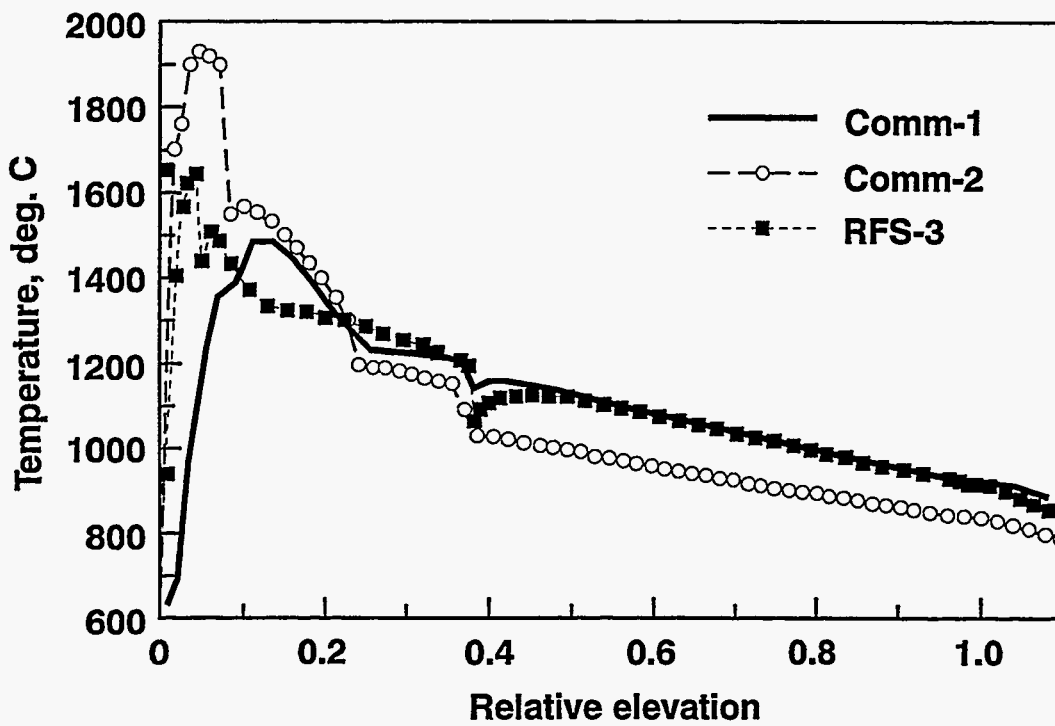

Figure 6. RFS gas temperature (in furnace) compared to a commercial process recovery boiler.

replicate the gas-side time/temperature history from the secondary air ports to furnace nose. The furnace design uses a water-cooled enclosure that is refractory lined to the top of the furnace section. The water cooling utilizes natural circulation, boiling-water circuits that are vented to atmosphere. The atmospheric pressure design facilitates easy modification for future configuration changes. The refractory lining in the furnace controls heat removal to achieve the gas time/temperature history in the furnace that approximates a commercial recovery boiler.

The RFS convection pass consists of multiple banks of water-cooled tubes, also with natural circulation, boiling-water cooling, vented to atmosphere. The tube banks are arranged so that the gas time/temperature history through the convection pass approximates that of a commercial recovery boiler.

The furnace floor is flat and lined with high-density refractory to resist smelt attack. The smelt spout is located so that a frozen smelt layer will be maintained under a liquid smelt layer to protect the floor.

The furnace three-level air system shown in Figure 7 includes primary, secondary, and tertiary air similar to commercial boilers. The air system has considerable flexibility to change air distribution, temperature, and jet velocity, along with air port arrangement.

Black liquor is introduced via a single spray nozzle through the front wall of the furnace, between the secondary and tertiary air. Due to the variation in test parameters, a slot design with removable, segmented cover plates permits selection of the preferred liquor nozzle elevation for a particular test condition. The scaling methods used to select liquor spray nozzle and set the nozzle elevation are described in Appendix B.

The design utilizes auxiliary natural gas firing for start-up and supplementary firing if needed when firing liquors with low heating value or with high-viscosity smelt. The auxiliary burners include two larger burners on the side wall and a single smaller burner on the front wall above the smelt spout.

The smelt handling system casts the smelt into solid "ingots." This system is comprised of a smelt conveyor/caster, smelt ingot chute, and ingot-handling bins. This design provides significantly reduced volume of material to return to the mill as compared with a typical commercial green liquor system. The arrangement of RFS and the major new equipment for this and other systems is shown in Figure 8.

After the flue gas exits the RFS and is cooled in a boiling-water heat exchanger (BWHX), the entrained smelt/fume particles are collected using a baghouse and the gas is discharged via an induced-draft fan to a stack. The existing equipment used in this system will require modification to connect to the RFS; however, the major components (that is, the boiling water heat exchanger, baghouse, induced draft fan, and stack) can be shared with the adjacent facility. The design includes consideration for isolating the RFS from the existing facility and *vice versa*.

The anticipated flue gas emissions from the RFS were determined to be within limits for all species addressed under current permits for the existing facility and stack. The levels of species not addressed by current permits were evaluated using a proven air dispersion model and determined to be well below levels typically required for air permits at ARC.

2.4 RFS and Program Estimated Cost

The cost of the program is summarized in Table 1. These costs are based on a detailed estimate of RFS facility design and construction and a review of the associated test costs for startup. The estimate is based on the schedule shown in Figure 9. The Phase II estimate was developed using draft arrangement drawings of the facility, the RFS, and site; and the PFD and P&IDs that are included in Appendix A.

The projected cost increases over those proposed in 1991 are due primarily to general inflation and the engineering and construction requirements of the later phases of the project being more complex than anticipated. Examples of items that significantly impacted the cost include:

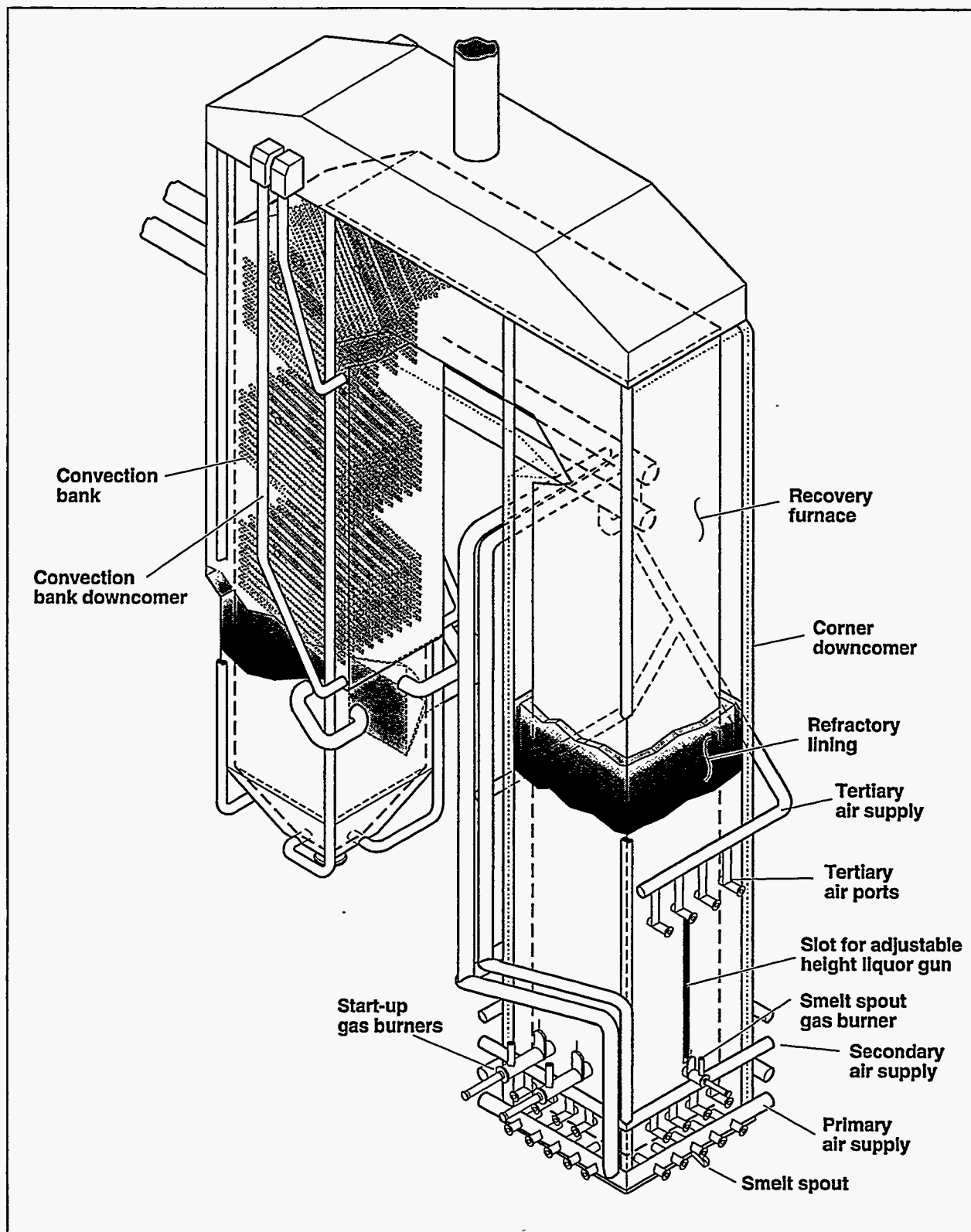

Figure 7. RFS general arrangement.

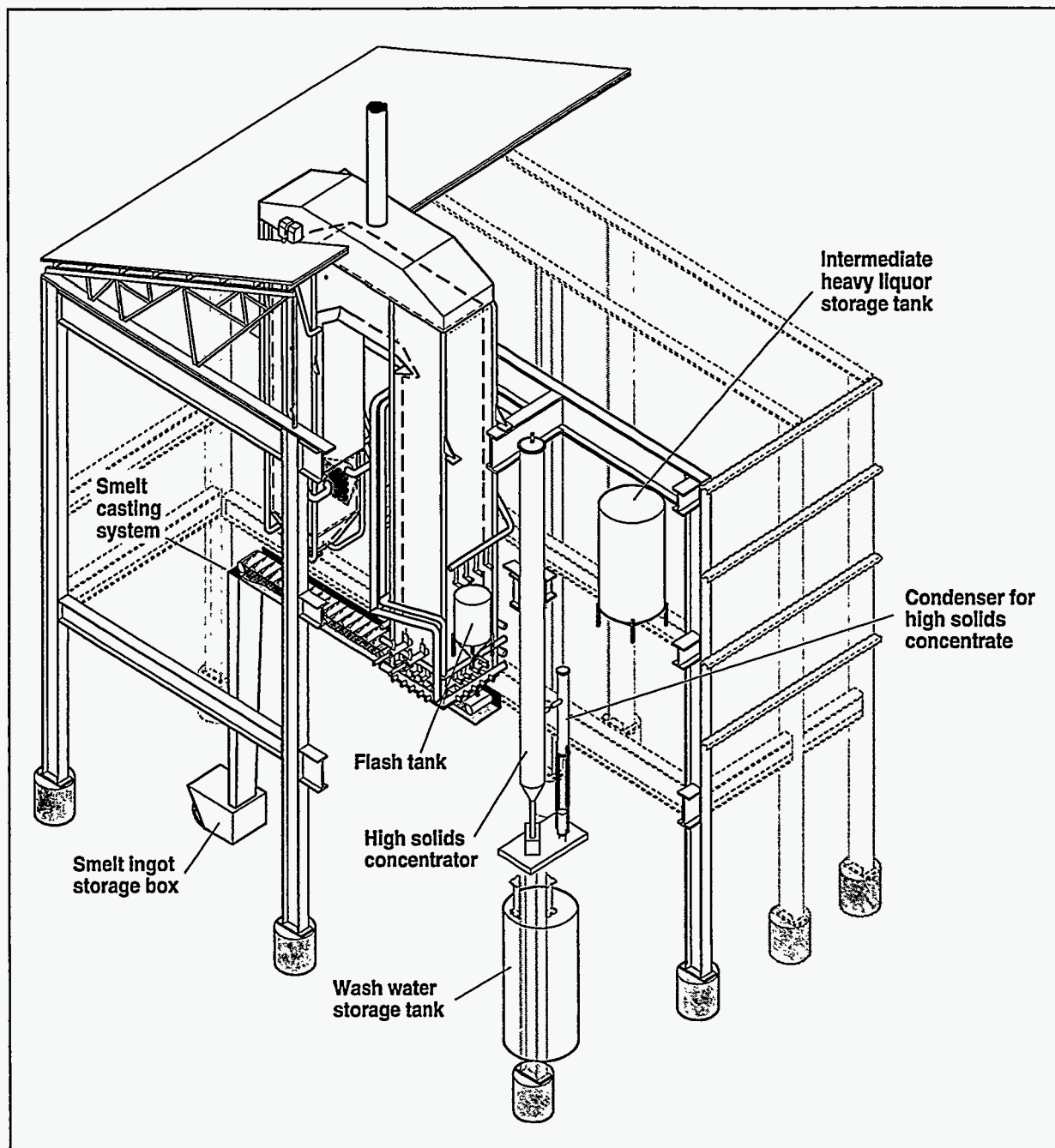

Figure 8. RFS facility general arrangement of major new components.

- Need for additional black liquor storage and handling equipment to address environmental requirements.
- Modifications more complex than anticipated to use the existing ARC facility.
- Commercial unit identified for conversion to high-solids advanced combustion in Phase IV.

Estimates for Phases III and IV are budgetary due to the dependence upon results from the prior phases and the ultimate host site selected. Estimated cost for an interim phase, designated Phase Ia, to evaluate gasification as an option is included in Table 1 and the workscope described in Section 3.2.

Table 1. COST ESTIMATE SUMMARY FOR RFS PHASES Ia, II, III, AND IV

<i>Description</i>	<i>Phase Ia</i>	<i>Phase II</i>	<i>Phase III</i>	<i>Phase IV</i>
Direct Cost (Labor+Matl)	\$455K	\$7,625K	\$3,700K	20,800K
Indirect Cost (G&A + COM*)	\$107K	\$1,700K	\$1,175K	\$7,200K
Total Cost	\$562K	\$9,325K	\$4,875K	28,000K

* COM - Cost of Money

<i>Project Phase</i>	95	96	97	98	99	00	01
Ia Gasifier Evaluation		■					
II Pilot Facility			■	■			
III Pilot Test and Development					■	■	
IV Commercial Deployment							■

Figure 9. Program schedule phases Ia, II, III, V.

The following general notes apply to these estimated costs:

- Escalation of 5%/year is used throughout to adjust for inflation.
- G&A and COM rates are assumed at current values.
- Only total costs are shown for this estimate. Cost shares, industry contributions, and final costs to the government will be addressed under future proposals to modify/extend the contract as needed.
- The results shown are based on estimates for the detailed design and construction of the RFS at ARC as described in this report. Phase Ia, is included, assuming it would be executed to provide input for the decision of whether to pursue advanced combustion or gasification in future phases. Phases II - IV assume that advanced combustion is the technology selected after Phase Ia.
- The Phase IV budgetary cost is that used for a representative unit in the economic justification and includes the cost of low-odor conversion of the representative unit.
- Gasification would impose similar costs except that the demonstration unit would be a smaller unit and is not a retrofit; so Phase IV costs would be lower. Note that the Phase IV advanced combustion costs would also be lower for conversion of a smaller unit.

2.5 RFS Industry Support and Potential Participants

This project has the potential to significantly benefit the U.S. pulp and paper industry. Through our ongoing efforts to maintain contact with our customers in this industry, B&W has continued to evaluate interest in this area of development. Letters of interest from officials of two major pulp and paper companies (International Paper Company and Boise Cascade Corporation) are provided in Figures 10 and 11. These letters also include expressions of interest to be considered for host sites in Phase IV. Based on 1993 total sales, these companies are ranked first and fourteenth among North American paper products companies. In addition, International Paper Company operates the largest number of recovery boilers in the world.

To adequately plan and estimate the project, B&W contacted suppliers of products and specialized analyses that would be required. The majority of the suppliers contacted provided budgetary bids when requested, thus indicating their interest and ability to respond to the project needs.

The black liquor concentrator will be the largest single purchase of project equipment and will require a supplier with highly specialized technical capabilities. B&W contacted potential suppliers of this equipment and identified three industry leaders with strong interest in participating in the program. Letters of interest from potential concentrator suppliers are provided in Appendix F.

Researchers at the University of Florida and the Institute of Paper Science and Technology were identified as potential suppliers of black liquor characterization tests to be performed on the specific liquors used for tests in Phases II and III. Letters from both institutions indicating their interest in performing characterization tests and interest in the project are in Appendix F. Both institutions have conducted extensive work for DOE and would apply the equipment and knowledge from that work to support the work needed for this project.

2.6 Test Planning

The purpose of the RFS is to provide a means to develop advanced black liquor combustion. Extensive

testing will be required to verify that the RFS adequately simulates black liquor combustion conditions of commercial designs and to demonstrate the advanced design adequately before it is used in a first-of-a-kind commercial application. Tests included in Phases II and III, aside from those to test the advanced concept, were planned as part of this program phase. These tests are divided into two groups: (1) liquor and spray tests, and (2) RFS operation tests.

The liquor and spray tests are to obtain physical property data, combustion data, and atomization data specific to the black liquor and candidate atomizers that would be used in the RFS testing. In Phase I, existing property data were evaluated and candidate atomizers were selected. These results were based on available black liquor property data for current commercial firing conditions and high-solids data developed for DOE by the University of Florida and other academic institutions. These results are adequate for preliminary design, but the final design must assure operation with high-solids black liquor. Also, the liquor properties may ultimately restrict tests in the RFS.

The planned tests will assure that the properties of the liquor from the supplier mill selected are adequately understood to consider the effects on the test results. Also, limited tests of liquor properties as the project proceeds will assure that effects of changes in properties of the liquor received will be known and available when interpreting test results. The planned tests included in this category and a brief description of the purpose of each follow.

Liquor Properties Characterization. These tests will determine the physical and combustion properties of liquor from the supplier mill. The liquor properties tests and their objectives are:

- Screen Mill Liquor for Excessive Viscosity -- Determine apparent viscosity as a function of shear rate for liquor from the candidate supplier mill to determine if there are liquor-handling problems that will affect the choice of the supplier mill.
- Liquor Preparation -- Composite liquor samples from the supplier mill over multiple days and fraction the composite into samples for subse-

INTERNATIONAL  PAPER

POST OFFICE BOX 160707 • MOBILE, ALABAMA 36616

March 9, 1995

FRANK W. MOULTON
MANAGER, POWER TECHNOLOGY
TECHNOLOGY

Mr. Hayes C. Orender
Babcock and Wilcox
Power Generation Group
Post Office Box 351
Barberton, OH 44203-0351

Dear Hayes:

I am writing to indicate our continuing interest and support for the B&W effort to significantly improve kraft recovery technology through joint programs with the U.S. Department of Energy.

As you know, International Paper operates the largest fleet of kraft recovery boilers in the pulp and paper industry and advances that would enhance safety, efficiency, environmental performance or capital requirements would improve our ability to compete in the world market.

As you also know, the combination of process improvements, energy conservation measures, and environmental control systems implemented in our industry in recent years has upset the traditional energy balance—reducing our demand for process heat (steam) while increasing our need for electric power. Your work, especially the development of black liquor gasification technology for integration with combustion turbine-combined cycle power systems, offers significant potential to favorably alter the steam/electric power production relationship.

Please keep us informed and let us know if we can be of assistance. When it is time for a demonstration project, we definitely would like to be considered as a potential partner with one of our mills serving as the host site.

Very truly yours,

Frank Moulton

cc: Paul Herbert
Richard Phillips

Figure 10. Letter of interest from International Paper Company.

3/14/95 15:03 208 384 7637

BOISE CASCADE

002



Boise Cascade Corporation

Paper Engineering
P.O. Box 50
Boise, Idaho 83728-0001
208/384-6665

March 14, 1995

Mr. Hayes C. Orender
Industrial Boiler Marketing
Babcock & Wilcox Power Generation Group
P. O. Box 351
Barberton, Ohio 44203-0351

Re: Recovery Furnace Simulator

Dear Hayes:

In response to your letter of February 27, 1995, Boise Cascade Corporation is very interested in improving the kraft recovery process. The current chemical recovery boiler has made large improvements in efficiency and environmental emissions during the past several years, but there must be continuous improvement to the process to keep the United States paper industry competitive in the market place.

The proposal to install an advanced black liquor processing facility is an excellent opportunity to explore black liquor recovery combustion alternatives. The industry currently needs to add incremental black liquor capacity at a lower capital cost. The optimization of our current processes would help achieve a greater black liquor through-put with the existing chemical recovery boilers.

The knowledge to be gained from a simulator would also help the paper industry evaluate our current technical options as well as the development of new technologies. The development of the pressurized gasification process would improve the combustion efficiency and also potentially provide a high efficiency electrical generation combined cycle operation.

Boise Cascade Corporation does support your request to develop a design of a combined high solids combustion and gasification facility. Both combustion processes would be an asset to the industry for optimization of the existing combustion process and for future expansion requirements.

Very truly yours,

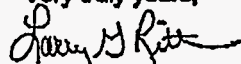
Larry G. Ritter
Energy Manager

LGR.h50314a

c. Colin Miller

Figure 11. Letter of interest from Boise Cascade Corporation.

quent property and combustion tests.

- Liquor Physical Properties -- Determine density, rheology, and boiling point elevation for liquor from the supplier mill.

These tests are planned to be conducted at B&W and the University of Florida. The tests are described in more detail in Test Series E.1 of Appendix E.

Atomizer Evaluation. These tests are to select atomizer nozzles for the RFS tests at base design and high-solids conditions and to determine the drop size distribution and spray patterns for those nozzles. Two series of tests, one with black liquor representing the base design solids level and a second representing high-solids level are planned. Both tests series will use the existing B&W atomization test facility and will seek to select commercially available nozzles that will be used for subsequent RFS testing.

Candidate atomizers were selected in Phase I using engineering methods to estimate the nozzle spray cone angle and drop size distribution for black liquor based on nozzle manufacturers' data for water. In addition to supporting nozzle selection, the drop size distribution and spray pattern data will be available for use in numerical models when evaluating the performance of the RFS compared to commercial units. Refer to Test Series E.2 of Appendix E for specific test details.

Drop Combustion Characterization. These tests are planned to be conducted at the Institute of Paper Science and Technology. A specialized test facility permits testing single liquor drops to evaluate black liquor drying, devolatilization, and char burning rates. This permits evaluation of liquor-specific differences that result from its origin or processing. The results will:

- Provide drying time estimates to verify design calculations.
- Provide numerical modeling inputs to evaluate RFS performance compared to predicted results.
- Predict changes in drying, devolatilization, and char burning rates with changes in liquor solids level to aid in final test planning.

Since there is little or no operating experience in the range of liquor conditions that will be used for high-solids firing, these data will aid in interpreting the high-solids firing test results. These tests are further described in Test Series E.3 of Appendix E.

RFS Operations Tests. The second group of tests involves combustion of black liquor in the RFS. These tests are to commission the facility, characterize the RFS when operating at conditions close to commercial conditions, and then to push the limits of high solids and liquor throughput of the RFS in the initial configuration.

Descriptions of these tests series, including the major objectives of each, follow.

Shakedown Tests. This series of six tests will move the RFS from initial checkout to full, stable operation at base design conditions. Preliminary data collected in this test series, while not intended to be adequate for validating RFS simulation of commercial operation, will be useful in guiding the subsequent tests. The major objectives of the six tests are:

- Bring the RFS on line with the major systems working together.
- Run the RFS at design load with auxiliary systems operating.
- Preliminarily evaluate the effects of liquor temperature and spray nozzle configuration on RFS performance.
- Preliminarily evaluate the effects of air system changes on performance.
- Approach the limits of the concentrator design capacity for liquor evaporation and heat input.
- Repeat any tests that failed to achieve the test objectives.

Baseline Characterization Tests. This test series will provide steady-state evaluation of the RFS at the base design heat input range, with liquor solids near commercial values (65% nominally and up to 78%). RFS response to parametric changes in operating conditions will be evaluated to characterize the unit. These tests will provide the baseline against which any changes to improve performance

are measured and will provide the base data for use with numerical modeling to demonstrate that the RFS simulates commercial performance. Four test groups are planned that will examine the parameters:

- Air distribution, including establishing the upper limit of tertiary air.
- Total airflow, including the lower limit for excess air.
- Air jet penetration.
- Black liquor solids level.

High-Solids Liquor in Base Unit. These tests will evaluate two major parameters: (1) high-solids firing (>78%) at base design heat input (6 million Btu/hr) and, (2) high-solids firing at high heat inputs (> 6 million Btu/hr). These tests will use the base configuration of the RFS that best simulates commercial design. This will quantify difficulties that may be encountered when firing high-solids liquor, and high-solids liquor at increased throughput (or heat load) with a commercial furnace configuration. It will also enable us to approach the upper limit for higher throughput with high-solids liquor when limited to the current commercial unit configuration. These tests will provide the baseline for firing high-solids liquor at base design and high throughput against which to measure performance improvement for the advanced combustor design. The planned test groups include tests to:

- Increase liquor solids in steps to a maximum achievable level.
- Evaluate the effect of as-fired liquor temperature at a constant high-solids concentration.
- Evaluate the effect of nozzle elevation at constant high-solids liquor firing conditions.

(Note: The first three test groups are planned at the base design heat input.)

- Fire at increasing heat input above the base design load to the maximum achievable load within the range of parameters explored the first three test groups.

These tests are described in greater detail in Test Series E.4 and E.5 of Appendix E.

Tests for the advanced combustor concept will be defined during its design in Phase III. The advanced combustor design and testing will undoubtedly be influenced by results of the high-solids liquor tests in the base unit and numerical modeling results.

2.7 High-Solids Firing Economic Justification

The economic justification task evaluated the economic impact of combining high-solids advanced combustion and increased capacity or throughput upgrades with conversion of a significant number of existing recovery boilers from direct-contact evaporator (DCE) units to low-odor operation. The conclusion drawn from this evaluation is that if an upgrade includes a sufficient capacity increase, it can be economically justified at the projected cost. However, several mill-specific issues may affect the attractiveness of high-solids advanced combustion. These issues include:

- Can the added chemical recovery and the added electrical and steam-generating capacity be utilized cost effectively?
- Can the necessary steam economy for the black liquor concentrator be achieved?
- Is it attractive to invest in the specific mill compared to other investments?
- Are emissions compliance requirements driving the low-odor conversion? If so, the alternative levels of higher solids firing and the increased capacity would be evaluated on an incremental cost basis.

The economic evaluation included in this report is limited to considering the value of the added electric power and steam generated by the upgrade and does not attempt to evaluate the value of the end products of the mill. Some major points of the economic evaluation are described here and more detail is provided in Appendix G.

The economic value of a high-solids advanced combustor retrofit was evaluated for a typical recovery boiler upgrade that could be used to estimate the impact on the full population of similar units and, therefore, the industry. The "typical" unit selected

for evaluation was a DCE design and is one unit in a population of 88 similar units.

The unit processes 48% black liquor (upstream of the DCE), with a higher heating value of 6310 Btu/lb of dry solids, at the rate of 2.94×10^6 lbs of dry solids per day to deliver 370,100 lb/hr of steam at 1020 psig and 825°F. The evaluation considered the performance improvement of increased steam flow from low-odor conversion coupled with raising the solids content of black liquor to the boiler as high as 85%.

This upgrade was also evaluated for two cases, one with a 21% increase in capacity (Case B) and one without (Case A). The economic attractiveness of this upgrade depends substantially on the steam economy achieved by the concentrator, which is required to produce the high-solids black liquor. Therefore the evaluation considered two options:

- A six-effect concentrator steam economy.
- A two-effect concentrator steam economy.

The evaluation considered the capital costs required for the upgrades and the increased steam flow used by the concentrator. The economic value resulting from the upgrades considered was limited to the resulting useable energy output in the form of steam or electricity.

The evaluation assumes that the additional energy produced will displace purchased electricity or steam generated with purchased fuel.

The impact on end-product cost or the cost of chemical recovery were not evaluated due to the site-to-site variations in processing chemical costs and product value. These may be additional mill-specific factors impacting the decision of whether or not to utilize high-solids advanced combustion.

The two cases and two options were evaluated for black liquor solids levels of 75%, 80%, and 85% solids. [Putting these levels of black liquor solids into perspective, 75% solids is near the level of solids being fired commercially in newer units (units in operation 5 years or less), 80% solids has been achieved commercially on a very limited basis (References 1, 2, and 3), 85% solids has been approached in at least one mill under special circum-

stances. (See Reference 4 and note that for this case, "There is significantly less chloride and potassium in the black liquor ... than in typical American liquors, which results in the more benign melting behavior of the fly ash.")]

Gain/loss, net present value, and payback analyses for the resulting 12 combinations considered (2 capacity increase cases x 3 levels of black liquor solids concentration x 2 levels of concentrator steam economy = 12 combinations) are presented in Exhibits G-1 and G-2 in Appendix G.

Looking at the economic results of these alternatives, investing in higher-solids-firing levels is clearly advantageous if the higher concentrator steam economy is achieved and the high-solids firing is coupled with increased capacity. The case for the lower concentrator steam economy and without the added capacity is not a clear economic advantage. The plant-specific factors, stated previously, may make the options for high-solids advanced combustion attractive.

The results for the single unit can be used to estimate the impact for the industry by considering the advantage of applying this technology to the full population of units that meet similar selection criteria.

Assuming this could be achieved for various amounts of the total capacity in this group of 88 potential units (25%, 50%, 75%, or 100% -- these values were selected arbitrarily), the investment in high-solids advanced combustion including a 21% capacity upgrade in conjunction with a low odor conversion would yield the net present values shown in Table 2.

Note that the capacity increases achieved as part of the upgrades represents capacity that would not have to be added as new units. Additionally, if high-solids advanced combustion is developed, the technology would also be available for integration into new boiler designs.

The chemical recovery capacity in the U.S. can be expected to grow at a limited rate (less than 1% per year), and older units will also require replacement. The resulting new capacity and replacement units would provide an additional economic benefit from

Table 2. SUMMARY OF ECONOMIC JUSTIFICATION NPV AND INVESTMENT LEVEL FOR MOST ATTRACTIVE OPTION - EFFECT OF TOTAL POPULATION OF UNITS CONVERTED

<i>Capacity Upgraded/ Capacity Added (21%) (10⁶ lbs dry solids processed/day)</i>	<i>Segment of Potential Population Upgraded (% of capacity)</i>	<i>Investment Required for Upgrades (\$)</i>	<i>Net Present Value (\$) of the Investment</i>
160 / 34	100%	\$1,040 million	\$219 million
120 / 25	75%	\$ 780 million	\$164 million
80 / 17	50%	\$ 520 million	\$110 million
40 / 8.4	25%	\$ 260 million	\$ 55 million

high-solids advanced combustion technology if the technology is developed and utilized.

This area was not specifically evaluated, but would produce additional savings for the industry and increase the rate of self generation -- further reducing dependence on purchased fuel.

Beyond these benefits, high-solids advanced combustion technology would also increase the attractiveness of recovery boilers as exports. Substantial growth in pulp production is expected in South America and the Pacific Rim of Asia in the next two decades^[5]. This growth has the potential to increase equipment exports during this period and provide additional benefit from the program in the form of increased equipment exports.

2.8 High-Solids Liquor Properties Effect on RFS Design

DOE has sponsored significant research to develop black liquor properties data, including considerable data for high-solids black liquor. These results were evaluated along with information from the open literature by other investigators. The preliminary design of the RFS used these existing data.

Viscosity, surface tension, boiling point rise, and density data for black liquor were evaluated (Refer to Appendix D). Review of the available data identified uncertainties that should be resolved to complete the RFS detailed design and to be better able to interpret test results in Phases II and III. A strategy to minimize testing of liquor from the supplier mill was considered when planning Phase II. This strategy included applying correlations developed to date and correlations that were being completed when planning these tests.

A cautious approach to the RFS design and related liquor property evaluation was used. Elements of this approach, described in Appendix E, include:

- Initial screening of liquor from the candidate supplier mill for handling problems.
- Establishing the rheologic and combustion characteristics of the supplier mill's liquor during detailed design to minimize unanticipated results.
- Establishing a sufficient rheology data base on the supplier mill's liquor to anticipate and prevent problems during RFS combustion tests.

3

TECHNICAL APPROACH FOR FUTURE WORK

3.1 High-Solids Firing Versus Black Liquor Gasification

Trends in pulp production that will influence the choice of future recovery equipment include:

- Emissions -- more stringent emission limits.
- Mill Energy Requirements -- a shift in the energy mix (electrical versus steam) needed by the industry.
- Age of Equipment -- in particular, the age of the installed base of recovery boiler capacity.
- Capacity -- process changes resulting in increased demand for recovery capacity.

These trends favor both advanced combustion and gasification to some degree. If the costs for the two options for a given capacity increase were similar and both were equally proven, gasification may be favored in general. However, the choice is not clear due to site-specific advantages that each technology may offer. Also, since both technologies are not yet commercial, uncertainties that remain to be addressed during development are important.

Gasification has the potential long-term advantage of offering gas turbine topping to increase power generation efficiency and a resulting cost advantage. Advanced combustion offers the advantage that its development is more incremental than gasification; so it may offer better performance earlier. Consideration of how the two technologies, gasification and advanced combustion, address these four trends is shown in Table 3.

3.2 B&W Gasification Approach

The B&W gasification approach would use a low-temperature design to recover inorganic material from the gasifier as a solid. B&W work completed external to this contract on gasification is described in Appendix H. This section outlines the program option to evaluate gasification and the program phases that would be followed if gasification is selected for development.

Combined Facility Design Concept. A combined liquor processing facility that could be initially configured as either a gasifier or an RFS was considered. However, budgetary cost evaluation revealed that a combined facility with full capability to develop both advanced combustion and gasification would be too expensive. As a result, the recommended approach is to evaluate gasification as an option to a level comparable with the investigation of advanced combustion (via an RFS) completed in Phase I, and then select the path forward as gasification, advanced combustion, or neither of the two. The technology that would have been deferred under the combined approach could be pursued as a facility addition if it becomes attractive in the future.

Phase Ia -- Gasification Evaluation. This interim phase is recommended to evaluate gasification as the major technology competing with the high-solids advanced combustion recovery boiler. Phase Ia would include the following key tasks:

Bench Scale Testing. This task will use testing in a bench-scale reactor to produce the engineering and reaction rate data needed for preliminary design of the gasifier pilot.

Table 3. RESPONSES TO TRENDS IN PULP MILL RECOVERY NEEDS

Trend	High-Solids Advanced Combustion Response	Black Liquor Gasification Response
<p>Emissions— More stringent control of all emissions will be required of paper mills, evolving toward minimum environmental impact over time. ^[6,7]</p>	<p>To date, as the solids levels used in direct combustion have risen, it has been possible to continue to meet emission requirements. ^[1,2,3] Also, higher solids levels have been associated with lower SO_x emissions. ^[1,2,3]</p>	<p>Black liquor gasification requires low-temperature gas cleanup to complete the chemical recovery at present. (Note that one manufacturer is pursuing high-temperature gas cleanup processes) ^[8] As a result, the emission levels will be low. However, the low-temperature gas cleanup also contributes to the overall cost.</p>
<p>Mill Energy Requirements — Electrical demand compared to steam demand will increase in both pulp and integrated mills due to additional environmental control equipment and the increased use of recycle fiber, resulting in integration of recycle fiber production with virgin pulp production. ^[9,10]</p>	<p>High-solids advanced combustion is an upgrade of the Tomlinson recovery boiler technology that uses steam to generate electricity. Since no significant increase in steam pressure and temperature is anticipated, the cycle efficiency and, thus, the electrical/steam generation mix would be similar to the modern recovery boiler designs.</p>	<p>Gasification has an advantage of generating more electricity; i.e., a more favorable energy mix if the gas is consumed in a gas turbine. ^[8,11] However, gasification is anticipated to be implemented initially in smaller units to provide incremental capacity and produce fuel gas. The fuel gas would be consumed in a power boiler or would displace purchased fuel. Thus, initial applications would not improve the electrical/steam generation mix.</p>
<p>Age of Equipment — There is a significant base of installed pulp production equipment in North America. Between 2000 and 2020, a significant segment of this capacity will require replacement or upgrade. ^[5,12] The technology used will be the most cost effective, proven technology available at the time the capacity is replaced.</p>	<p>High-solids advanced combustion— is an advancement or improvement of current recovery boiler technology. As such, the technology would be expected to be quickly assimilated into new recovery boiler designs once it is proven. Therefore, the technology can reasonably be expected to be available for replacement of large blocks of aging recovery boiler capacity significantly sooner than gasification technology.</p>	<p>After its initial development, gasification may be favored for smaller capacity replacements. A capital cost advantage is more probable for small blocks of capacity where economies of scale that are achievable with large recovery boiler projects cannot be applied. Gasification may develop an advantage for larger blocks of capacity in the longer term if larger capacity units or modular design approaches are developed and become proven technology.</p>
<p>Capacity — A shift in pulping and bleaching processes to displace elemental chlorine will increase the quantity of solids processed. ^[12] In general, the recovery system is the single most expensive capital investment in pulp mills. Due to economies of scale, recovery capacity is typically installed in large increments. However, smaller incremental increases could be an advantage within a segment of North American market faced with increases in solids loads caused by pulping and bleaching process changes.</p>	<p>High-solids advanced combustion technology may offer a cost advantage for smaller capacity increments if an existing boiler can be upgraded using this technology to provide the required increase in capacity and achieve the necessary steam economy. However, the technology will need to be commercially proven for industry acceptance.</p>	<p>Gasification may offer a cost advantage over new recovery boiler capacity for smaller capacity increments if the existing boiler capacity does not accommodate cost-effective upgrades, or if replacement of one or more existing units with higher capacity units is not favored. However, the technology will need to be commercially proven for industry acceptance.</p>

Gasifier Pilot Preliminary Design. A preliminary design will be developed in sufficient detail to estimate facility design, construction, and commissioning costs. This design effort will also include consideration of the testing needs of the balance of the program. Every effort will be made during the design to reduce the size and complexity of the pilot facility to contain cost while producing a facility that is fully adequate for the development tasks.

Re-estimate Program Cost. The cost of the balance of the program will be re-estimated assuming gasification is the technology pursued in subsequent phases. The major goals of the subsequent phases will be analogous to those of the high-solids advanced combustor program but will be based on gasification being the technology pursued. Those major goals by phase are:

- **Phase II** -- Design, construct, and commission the pilot gasifier; obtain industry endorsement and tentative commitments; and update the estimate to complete the program through Phase IV.
- **Phase III** -- Test the pilot gasifier; select the host site and obtain firm host site commitment; begin the commercial demonstration unit design; and update the Phase IV estimate.
- **Phase IV** -- Complete a first-of-a-kind (FOAK) commercial design; construct and start up the commercial unit; and obtain sufficient performance data to validate the design.

The Phase II gasifier development estimate will consider the preliminary design information. Phases III and IV will be budgetary estimates.

Test Planning. Prepare a test program outline for the tests in Phases II and III in enough detail to estimate the cost and assure that the facility is adequate for the tests planned for the later project phases.

Economic Justification. Conduct an economic evaluation covering the pulp and paper industry perspective of gasification as a means of adding or replacing capacity beyond 2000.

Reporting and Project Management. Plan, coordinate, and control all project activities. Prepare and issue progress reports, prepare a final report,

and present the results of the phase and recommend the future direction for the program to DOE at a project review.

Decision Point. The results of Phase I and Phase Ia will provide sound technical and cost information upon which to select the path forward to advance the recovery process for Kraft pulp production. At that time the options will consider:

- Proceeding with gasification development using a dedicated pilot facility.
- Proceeding with advanced combustion development using a dedicated pilot facility.
- Terminating the program.

This decision point should be achievable within 12 months of beginning Phase Ia.

Phases II - IV for gasification will be analogous to those proposed for advanced combustion in the project proposal. The major tasks in each phase follows:

Phase II will include tasks to address:

- Detailed design of the pilot gasifier and all support systems, equipment, and facility changes.
- Engineering modeling and analysis to support detailed pilot gasifier design and subsequent scaling to commercial designs.
- Procurement of major subcontracted components.
- Atomizer testing.
- Facility construction and commissioning.
- Estimating the cost to complete the program (i.e., Phases III and IV)
- Reporting and project management.

Phase III will include:

- Testing the pilot unit over a range of conditions sufficient to demonstrate the technology for the FOAK commercial design (prototype) for Phase IV.
- Selecting the host site and obtaining firm commitment from the industry partner(s).

- Initiating the commercial design and completing sufficient detail to support the commercial prototype estimate and to satisfy the industry partner.
- Estimating the cost to complete the program (i.e., Phase IV the design, construction, startup, and demonstration, of the FOAK commercial prototype).
- Reporting and project management.

Phase IV will include:

- Detailed design of the commercial prototype.
- Commercial prototype final design review.
- Fabrication and installation of the commercial prototype.
- Commercial prototype startup and testing to demonstrate the design.
- Reporting and project management.

3.3 Advanced Combustor

The advanced combustor will be considered as an option along with gasification after Phase Ia is complete. Advanced combustion, if pursued, would use the same basic path for development as outlined in the proposal. However, there are several changes to the workscope that differ from the original proposal. The more significant changes are described here.

The RFS design evolved during the Phase I study, which resulted in several changes. These are covered in the following paragraphs.

Scaling. The RFS is intended to simulate a commercial process recovery boiler. During Phase I, detailed scaling from a reference unit of modern (current) design was carefully developed. This revealed that the furnace dimensions needed to be modified to achieve a gas residence time match. This resulted in furnace inside width and depth changing from nominally 39 inches to 60 inches while the height to the furnace nose remained approximately the same. Air port scaling was adjusted to provide jet penetration that simulated commercial design practice. The convection pass design was revised to approximate the gas time/temperature profile at a modern commercial unit.

Smelt handling. The proposed design was to develop a system that would use air blowing to produce shot in combination with a limited amount of fiber from the smelt. This material was to be collected and returned to the supplier mill. This approach included a development task with several uncertainties for successful operation. A caster/conveyor approach replaced the air-blown approach primarily because it would not require development but would adapt proven commercial technology to this application and would be a more cost-effective and lower-risk technical solution.

Flow Modeling. The proposal included use of scaled plastic flow models to support design development. This task was dropped because numerical modeling improvements that have occurred since the proposed work was planned made the physical modeling unnecessary for this case.

Liquor Processing and Supply. The black liquor handling system design evolved from the design in the proposal. It now includes additional considerations for viscosity and temperature control, noncondensable gas destruction, and preliminary liquor gun height and nozzle selection.

Design Detail. The preliminary design work completed in Phase I advanced the level of detail considered in the design. This was a natural evolution in the design process. The following items are examples of areas receiving additional attention as a result:

- Process design and instrumentation.
- Control room requirements.
- Materials selection.
- Furnace and convection pass circulation.
- Personnel access to the RFS interior for maintenance/modifications.
- Structural support system.
- Building modifications.
- Material impoundment for environmental protection.
- Considerations for fugitive emission.
- Utility access.

Similarly the test planning was more detailed and identified several changes:

Liquor Characterization. In keeping with the revised workscope agreed upon with DOE, no liquor characterization was conducted in Phase I because of the extensive data available from other work conducted for DOE and in literature sources. The characterization of the supplier mill's liquor was deferred to Phase II and will adapt the correlations from the DOE sponsored work or other sources for use with the supplier mill's liquor at that time. The methods to be used and the data to be collected from the liquor combustion characterization for Phase II were modified to use captive single-drop tests that will be more cost effective and will provide data that can easily be adapted for integration into numerical modeling methods.

RFS Combustion Tests. The number of experiments and approximate duration of the test program did not change significantly. However, the specific tests were planned to evolve from simple shake-down of the system to increasingly complex characterization. The test plans now more fully consider this evolution. Each test sequence is planned to carefully build on the knowledge gained from prior results. This will make it possible to reach an endpoint that quantifies the limiting factors for the current design to achieve higher throughput of high-solids liquor. Thus the results may directly support development of the advanced combustor design.

Refer to Appendix I for a description of the scope of work in Phases II through IV to develop and deploy advanced combustion technology.

4

REFERENCES

1. Huber, E., Rauscher, J.W., Ronk, P., Williamson, D.F., *High Black Liquor Solids Firing at Pope & Talbot*, Preprints 1995 Int. Chemical Recovery Conference, Toronto, Ontario, Canada, 1995.
2. Shuey, B., Strandell, O., Kaila, J., Spangler, R., *Comparison of Very High Dry Solids Firing with Conventional Operation*, Preprints 1995 Int. Chemical Recovery Conference, Toronto, Ontario, Canada, 1995.
3. Ibach, S., *Conversion to High Solids Firing*, presented at 1995 ICRL, Toronto, Ontario, Canada, 1995.
4. Mantyniemi, J., Isoniemi, M., and Harila, P., *Biosludge and NCG Incineration in a Recovery Boiler*, Preprints 1995 Int. Chemical Recovery Conference, Toronto, Ontario, Canada, 1995.
5. Proprietary B&W Marketing Database.
6. Fleisman, E., Sobczynski, S., *Pulp and Paper Mill of the Future - A Workshop - Final Report*, USDOE; October, 1993, CONF - 930252-(DE94013841).
7. *Agenda 2020 A Technological Vision and Research Agenda For America's Forest Wood and Paper Industry*, AF&PA, November, 1994.
8. Grace, T.M., Timmer, W.M., *A Comparison of Alternative Black Liquor Recovery Technologies*, Preprints 1995 Int. Chemical Recovery Conference, Toronto, Ontario, Canada, 1995.
9. Clement, J.L., "Recovery Boiler Capacity to Accommodate Alternate Kraft Mill Processes", *Proceedings International Symposium on Pollution Prevention in the Manufacture of Pulp and Paper*, August, 1992, Washington, D.C., pp. 65-75, U.S. EPA.
10. Rickard, J.C., "The 2020 Mill - Utility Requirements for Market Kraft Pulp," *Tappi Journal*, Volume 78, No. 3.
11. Berglin, N., Person, L., Benntsson, T., *Energy System Options with Black Liquor Gasification*, Preprints 1995 Int. Chemical Recovery Conference, Toronto, Ontario, Canada, 1995.
12. Patrick, K.L., *et al.*, "Closing the Loop the Effluent-Free Pulp and Paper Mill," *Tappi Journal*, Volume 77, 1994.

Project Manager W T Southards 30 NOV 95
W. T. Southards Date

R&DD Manager D R Rowley 11/30/95
D. R. Rowley Date

APPENDIX A

**FUNCTIONAL SPECIFICATIONS FOR THE
RECOVERY FURNACE SIMULATOR**

(THIS PAGE LEFT INTENTIONALLY BLANK)

TABLE OF CONTENTS

<u>Section</u>	<u>Page</u>
A.1 FACILITY LOCATION.....	A-1
A.2 SCALE UP TO COMMERCIAL SIZE.....	A-1
A.3 FACILITY SIZE.....	A-3
A.4 FURNACE GEOMETRY.....	A-4
A.5 FURNACE AND CONVECTION PASS DESIGN PHILOSOPHY.....	A-4
A.6 LIQUOR FIRING RATE.....	A-8
A.7 HIGH SOLIDS CONCENTRATOR DESIGN.....	A-8
A.8 BLACK LIQUOR HANDLING SYSTEM.....	A-9
A.9 LIQUOR SPRAY NOZZLE.....	A-11
A.10 AIR DELIVERY SYSTEM.....	A-12
A.11 AUXILIARY SUPPORT FIRING SYSTEM.....	A-14
A.12 SMELT HANDLING SYSTEM.....	A-14
A.13 ENVIRONMENTAL CONSIDERATIONS.....	A-15
A.13.1 Fume.....	A-15
A.13.2 Gas Emissions.....	A-16
A.13.3 Water Discharge.....	A-16
A.13.4 Concentrator Non-Condensable Gas.....	A-17
A.13.5 Fugitive Emissions.....	A-17
A.14 MATERIAL AND ENERGY BALANCE AND PROCESS FLOW DIAGRAM.....	A-17
A.15 NITROGEN OXIDE REDUCTION CAPABILITY.....	A-18
A.16 SMELT-WATER EXPLOSION.....	A-18
A.17 EXTENDED PERIOD OF OPERATION.....	A-19

TABLE OF CONTENTS (Continued)

<u>Section</u>	<u>Page</u>
A.18 FUTURE EXPANSION.....	A-20
A.19 REFERENCES.....	A-20
ATTACHMENT 1.....	A-22
ATTACHMENT 2.....	A-23

LIST OF FIGURES

<u>Figure</u>	<u>Page</u>
A-1 B&W Process Recovery Furnace Simulator and Support Equipment.....	A-2
A-2 General Arrangement of the RFS.....	A-5
A-3 Convection Bank Time Temperature History.....	A-7

LIST OF TABLES

<u>Table</u>	<u>Page</u>
A-1 Summary of Concentrator Performance.....	A-10

APPENDIX A: FUNCTIONAL SPECIFICATIONS FOR THE RECOVERY FURNACE SIMULATOR

The Functional Specifications of the Recovery Furnace Simulator (RFS) are presented and the rationale supporting the parameters used in the siting and design of the facility are discussed in this appendix. A schematic block diagram of the furnace and the supporting equipment that comprise the total facility is shown in Figure A-1. A more detailed process flow diagram (PFD) is included as part of Attachment 1. The Process and Instrumentation Drawings (P&ID) for the black liquor system, air distribution system and furnace water supply are also included as part of Attachment 1.

A.1 FACILITY LOCATION

The United States Department of Energy (DOE) recognizes the need for a pilot scale facility where black liquor combustion equipment and processes can be developed, tested, and optimized on an ongoing basis. Operation of this facility will produce the results to make it possible for DOE and The Babcock & Wilcox Company (B&W) to aid the U.S. pulp and paper industry in remaining competitive in the world market, while addressing environmental needs. The facility will further make it possible for the U.S. to increase its share of the world market for process recovery equipment.

Constructing the pilot facility at B&W's Alliance Research Center (ARC) will provide an ideal site for multi-disciplined investigations. The facility will be readily available, accessible, and reasonably economical to operate and maintain. There is strong support available by analytical chemistry, instrument, environmental technology, and heat transfer personnel at ARC. It will be easier to ensure data quality under controlled test conditions independent of commercial mill operations at an on-site pilot facility. These considerations contribute to data reliability and applicability. There will be no travel expenses for test personnel. Utilizing an existing building, existing equipment, and available utility access will also reduce cost. These advantages outweigh the need to ship liquor to Alliance and return smelt and fume to the supplying mill. Experts in commercial recovery boiler operation and design are located in close proximity, 30 miles, at the world headquarters of the Company's Power Generation Group in Barberton, Ohio. These experts will be directly involved in all phases of the contract.

A.2 SCALE UP TO COMMERCIAL SIZE

The results from the RFS must be scaleable to commercial units. The initial design, developed from engineering calculations, was refined and adjusted using numerical modeling. The numerical modeling was performed using the B&W three-dimensional numerical flow and combustion model, PR-FURMO, that describes the various interacting processes that

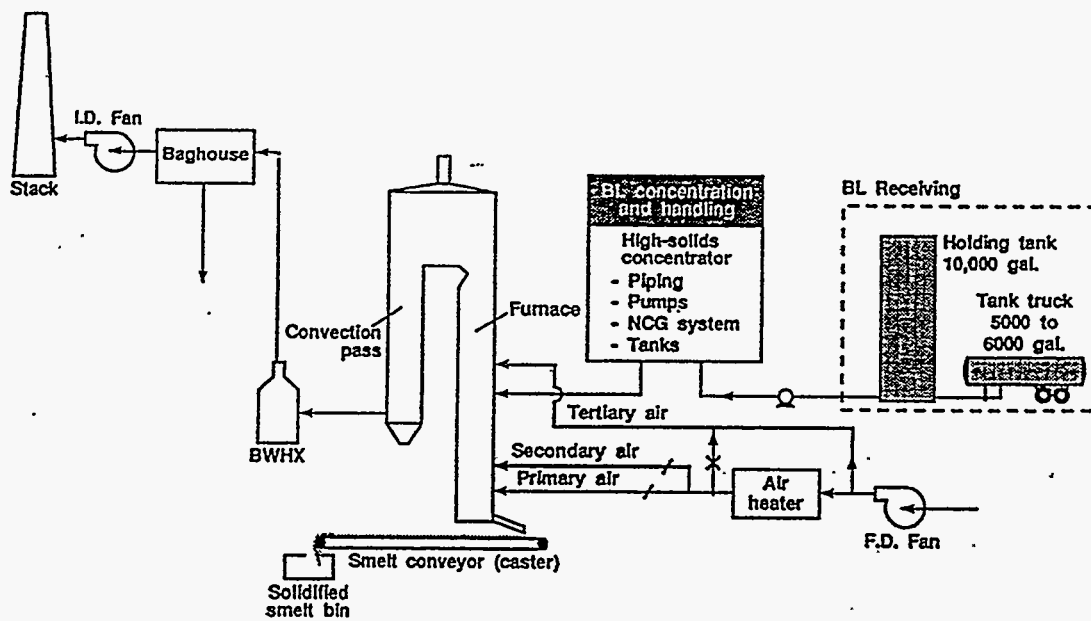

Figure A-1 B&W Process Recovery Furnace Simulator and Support Equipment

occur in a kraft process recovery furnace¹. PR-FURMO has been used in combination with field testing to evaluate the performance of existing commercial units. This numerical model was used to compare the predicted performance of the RFS with a modern, one-drum commercial unit. The liquor analysis, operating conditions, and PR-FURMO simulation results from this commercial unit have been used as the basis of the RFS design. The detailed B&W performance data available from the commercial unit and its modern design make it an ideal reference unit^{2,3}.

Preliminary results of the PR-FURMO simulation of the RFS design have shown that gas residence times, axial time-temperature profile, gas flow patterns (jet penetration and percent of up-flow) and upper and lower furnace oxygen concentrations are similar to those found in the reference commercial unit. It should be noted that both gas velocity and residence time can not be duplicated in the pilot furnace. It was considered more important to achieve the proper residence time because of its influence on gas phase chemistry. Modeling results have also been used to adjust the liquor gun elevation and drop size distribution required to achieve comparable droplet fate and carryover for comparable liquor firing conditions and air distribution. The numerical modeling results are described in more detail in Appendix C.

These results increase confidence that the RFS will simulate emissions, fume generation, carryover, heat release, ash chemistry and fouling of a commercial unit. This study bolsters confidence in the scaleability of the RFS to commercial applications prior to the final commitment of government and company funds for the RFS construction.

A.3 FACILITY SIZE

The pilot RFS must be of a reasonable size to simulate the processes occurring in a commercial recovery unit (e.g. drying, devolatilization, char burning, smelt reduction, gaseous emission formation, aerosol formation and heat removal). The RFS has been designed based on a nominal heat input of 6.0 million Btu/hour. This will result in a firing rate of about 1000 pounds of dry solids per hour, or 1400 pounds per hour of liquor with a nominal solids concentration of 70% and a higher heating value (HHV) of 6000 Btu/lb dry solids. The spray nozzle will deliver about 2.1 gpm.

This facility size is sufficient to provide the required experimental data, but does not require excessive resources (e.g. liquor, labor, and utilities). Past experience with other fuels has shown that 5 to 6 million Btu per hour provides a reasonable basis for scaling. A larger heat input would require larger auxiliary equipment, incur higher operating costs, increase shipping costs for liquor delivery and by-product return, and increase logistics problems. A smaller furnace would increase the scaling uncertainties due to "wall effects," limit the number of air ports on each elevation, and increase the difficulty of directing liquor spray toward the walls or bed.

A.4 FURNACE GEOMETRY

An artist's rendition of the RFS is shown in Figure A.2. The RFS furnace cross section will be 5 ft by 5 ft. A smaller hearth area would require an excessive height to the furnace nose to match the reference gas residence time and would result in an unrealistically high length-to-diameter ratio. The furnace will have a flat (decanting) floor to simplify construction, maintain a uniform refractory thickness, and a uniform primary air elevation. The bottom of the smelt spout opening will be located about 4 inches above the refractory floor to provide a protective layer of frozen smelt. The top of the 3 inch schedule 80 pipe used to form the spout opening in the front wall will be the reference point for all elevations.

The air port elevations and furnace height to the nose were selected to simulate the reference unit (refer to Appendix B for additional details). The primary and secondary air port elevations have been scaled to the square root of the hearth area. The centerline of the primary ports is located 6 inches above the spout and the secondary at 18 inches. The tertiary port elevation is set 11 feet above the spout to reproduce the gas residence time between the secondary and tertiary port levels found in the PR-FURMO study of the reference unit. The tip of the nose is set at 18 feet above the tertiary or 29 feet above the spout to maintain tertiary zone residence time. These elevation have been confirmed by the PR-FURMO simulation of the RFS.

The furnace will be supported in such a manner that the entire hearth zone up to the tertiary air zone can be cut off and removed in Phase III of the DOE contract. This will permit using alternate air systems and furnace geometries for the advanced concepts. The atmospheric pressure water jacket construction will also permit easy relocation of the air ports by cutting out wall sections and rewelding.

A.5 FURNACE AND CONVECTION PASS DESIGN PHILOSOPHY

In order to achieve the gas temperature profile that will simulate a commercial unit, the furnace will be designed as a refractory-lined, water-cooled box. The convection pass will be designed to match the gas time-temperature history of the reference unit.

The refractory lining in the lower furnace will retard heat loss to ensure that the char bed will stay hot enough to drive endothermic reactions and to cause smelt to tap easily. The refractory lining in the upper furnace will control heat loss so that the furnace exit gas temperature (FEGT) is nominally 1750°F at the design heat input rate (6.0 million Btu/hr). The FEGT value will be determined as the average across the horizontal plane at the tip of the nose where gas flow is more uniform. The target FEGT value is consistent with that predicted by PR-FURMO for the reference unit and typical of commercial designs.

Although a final refractory has not been selected, the wall conductance value used in the PR-FURMO study was based on using a practical thickness (3 or 4 inches) of commercial

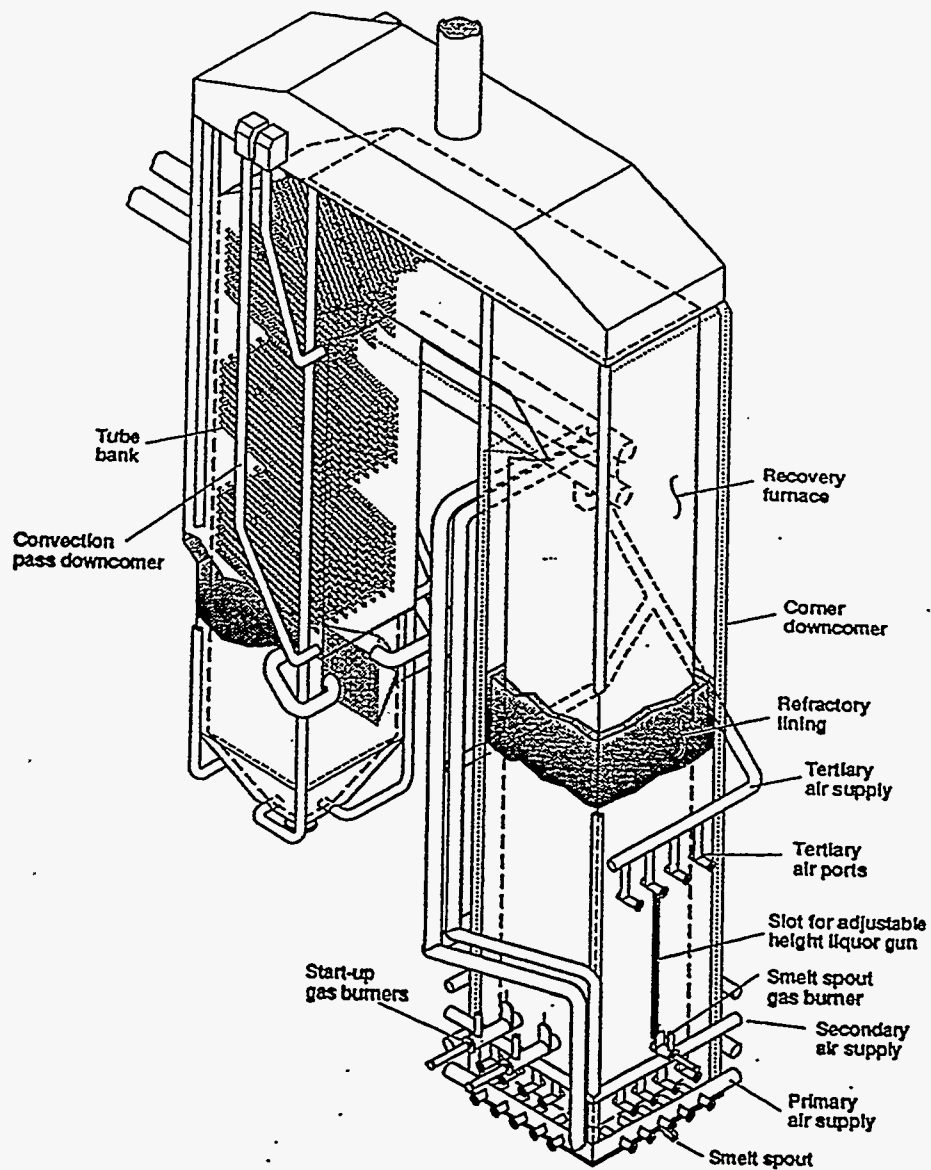

Figure A-2 General Arrangement of the RFS

refractory materials. A dense castable refractory suitable for molten smelt contact, Kao-Tab SR-RFT, (thermal conductivity = 8.7 Btu-in/hr-ft²-°F) was used in the initial design study. In the Phase II detailed design task, additional consideration will be given to the necessity of this material to resist chemical attack.

Different types or thickness of refractory may be used in the lower furnace and in the upper furnace. The refractory will be designed so that it can be replaced to address the problem of chemical attack by the smelt and provide the option to change heat flow to match heat input.

The convection pass cooling surface will be arranged to simulate the gas time-temperature history found in the reference commercial unit. The convection pass consists of several water cooled tube banks across the gas flow path. Tube wall temperatures and tube materials are not planned to simulate typical commercial conditions. The carbon steel, single-wall tubes will operate at temperatures close to the boiling point of the jacket water. The tube spacing in each tube bank will be uniform, but the depth of the cavities between banks will be used to achieve the desired overall cooling rate. The tube spacing (side and back) will be selected consistent with that for commercial designs at similar gas temperatures. The gas temperature entering the convection pass will be approximately 1650°F and the exit temperature approximately 700°F.

A large cavity has been provided between the furnace exit plane and the first tube row in the convection pass for practical design considerations. This cavity will result in that portion of the flow path having an atypically long residence time and, if refractory lined, approximately 200°F temperature drop. If the cavity is unlined, the temperature drop will be closer to 230°F, but the temperature at the end of the first tube bank is in good agreement with the commercial reference unit. The time-temperature curves for the RFS convection bank, with and without refractory in this initial cavity, and for the reference commercial unit are shown in Figure 3.

The initial cavity also permits all of the convection pass surface to be installed such that if tube leaks would occur, the leaks would not introduce water into the furnace. This arrangement improves safety. It may also be useful for future selective non-catalytic reduction of NO_x (SNCR) studies (See Section A.15).

The convection pass will be equipped with manually operated air-lances (i.e., sootblowers) to control deposition in the tube banks to allow for periods of extended operation.

A boiling water heat exchanger (BWHX) will further reduce the flue gas temperature leaving the convection pass to approximately 300°F before entering the baghouse. This will protect the bags from over-heating.

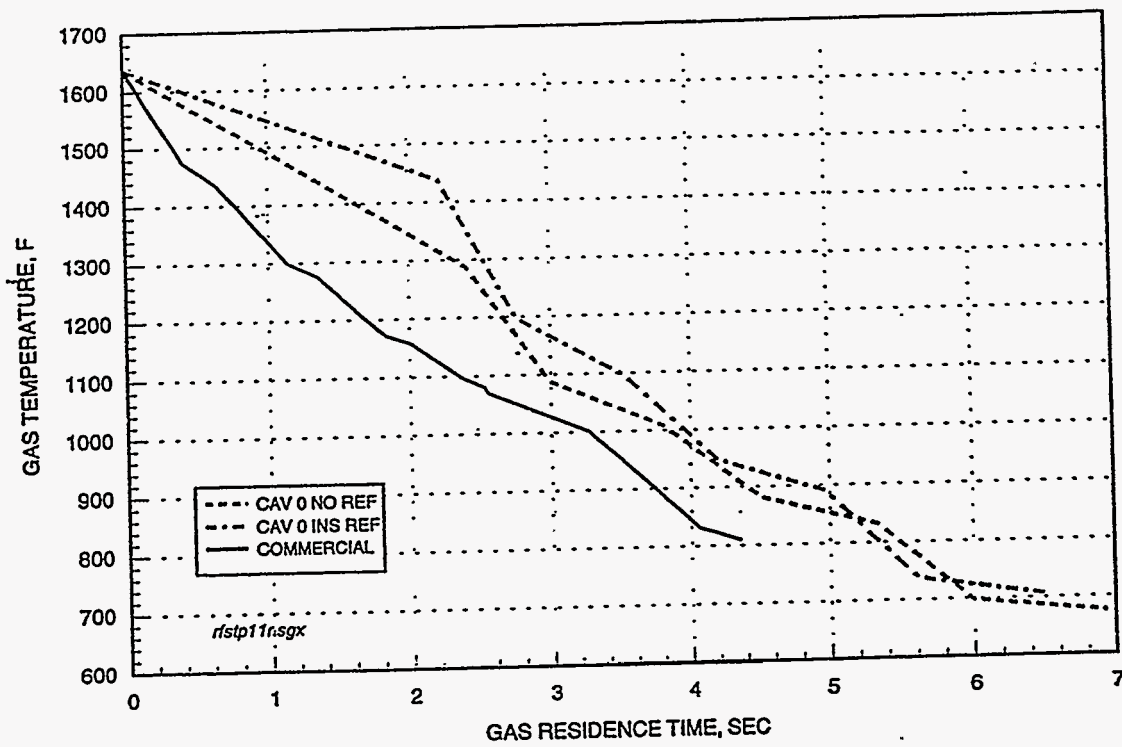

Figure A-3 Convection Bank Time Temperature History

The facility will allow investigation of the effects of operating conditions on particulate and gas (SO₂ and NO_x) emissions in the furnace. Sample ports will be provided in the furnace shaft and convection pass for gas sampling, particulate sampling, and high velocity thermocouple (HVT) traverses. Continuous on-line instruments will be included for the measurement of O₂, SO₂, NO_x, and CO.

Provisions will be made in the design of the convection pass to install deposition probes to collect ash samples. These probes will be air cooled so that the surface temperature can be regulated to a desired value. The probes will be removable during operation so that they can be exposed to the flue gas for varying periods of time. A similar type of probe has been used extensively for collecting ash deposits in other test facilities at ARC.

A.6 LIQUOR FIRING RATE.

The nominal firing rate is 1000 pounds per hour of solids or about 6.0 million Btu/hr heat input. However, in order to achieve the Phase III objective of increased capacity, the liquor supply pump and fans will be sized for 2000 lb/hr of solids. This will allow a heat input of about 12.0 million Btu/hr. By using a two stage concentration approach (see Section A.7), liquor flow can be maintained at this higher rate for up to 8 hours. This is sufficient time to conduct tests at steady state operation.

A.7 HIGH SOLIDS CONCENTRATOR DESIGN

The RFS facility will include a black liquor concentrator system capable of producing liquor with concentrations from 65% to 85% solids at the nominal design firing rate. It is anticipated that black liquor will be shipped to ARC in tank trucks at about 50% solids concentration.

The required evaporation rate will be 824 lb/hr of water for 85% solids product liquor at the nominal design firing rate of 6.0 million Btu/hr with the reference unit liquor. The ARC steam plant will operate as required to supply 125 psig saturated steam to the concentrator. Adequate cooling water for the concentrator's condenser is available from plant facilities as well.

A two stage concentration mode will be used for supplying high solids liquor (85% solids) at high capacity firing rates (above the nominal 6.0 million Btu/hr.) Prior to the high capacity, high solids tests, liquor will be concentrated to 63% solids (density = 11.1 lb/gal) and stored in an intermediate storage tank. A storage capacity of 2300 gallons is required for 8 hours of high capacity operation. The stored liquor will be further concentrated to 85% during the test. The required on-line evaporation rate under this scenario will be 822 lb/hr.

This strategy avoids oversizing the concentrator for normal testing. An evaporation rate of 1647 lb/hr would be required to concentrate liquor from 50% to 85% continuously at the high capacity (12.0 million Btu/hr) firing rate.

A summary of the required evaporator performance under several operating scenarios is shown in Table A-1. At 71.4% as-fired liquor, the concentrator will limit the heat input to about 10.7 million Btu/hr with 50% solids feed liquor. Increasing the feed solids to 55% will allow the RFS to run at 12 million Btu/hr with 71.4% as-fired liquor. For the high solids/high capacity case, note that the feed liquor is 63%, having been concentrated to that level off-line and stored in the intermediate liquor tank.

A.8 BLACK LIQUOR HANDLING SYSTEM.

The black liquor handling system consists of the tanks, pumps, and piping required to store and transfer the liquor between the various pieces of process equipment. As indicated in Section A.7, it is anticipated that black liquor will be shipped to ARC at 50% solids concentration in 6000 to 8000 gallon tank trucks equipped with steam heating coils. Upon arrival, the plant steam and a circulating pump will be connected to the truck. Liquor will then be transferred to a new 10,000 gallon, steam heated liquor storage tank located in a spill containment system. A heat-traced transfer line will direct liquor to the concentrator. The flow to the concentrator will be about 3.2 gpm at the nominal firing rate of 6.0 million Btu/hr. However, when the concentrator is operating at the maximum evaporation rate, 824 lb/hr, to fill the intermediate storage tank with nominal 63% solids liquor, a feed pump flow rate of 6.4 gpm will be required.

A small heated tank, 250 gallons, will be used as a "flash tank". The flash tank allows the temperature of the as-fired liquor to be set independently of the concentrator temperature. By operating at a liquor temperature at or slightly below the atmospheric pressure boiling point of the liquor, "flashing" of the liquor at the furnace nozzle will be minimized. Flashing occurs when the pressure of the high temperature liquor is reduced in the nozzle resulting in vapor formation within the nozzle. This will cause fine atomization of the spray liquor into many very small droplets leading to excessive carryover. To prevent this, the liquor will normally be allowed to "flash" in the flash tank. The pressure in the flash tank will be controlled by venting steam to the condenser. The temperature in the tank is governed by the enthalpy-concentration relationship of the liquor. The temperature of the pressurized liquor from the concentrator will be above 300°F to maintain a low viscosity in the concentrator. This liquor can be flashed down to its atmospheric pressure boiling point, anticipated to be about 260°F at 85% solids. The concentration of the liquor will increase about 2.5 percentage points across the flash tank. Under some conditions it may be desirable for the liquor to flash at the nozzle so the tank is also designed for pressurized operation.

The flash tank will be designed for 150 psig and full vacuum. Operating this tank at about one-half full (125 gallons) will provide about 0.75 to 1 hours operation at full load for

BLACK LIQUOR RECOVERY FURNACE SIMULATOR

SUMMARY OF HEAT & MATERIAL BALANCES

Design Cond.	Nominal	Present	High solids	<----->	High Capacity	<----->	<----->	High Solids at High Capacity	<----->	
	Design	Commercial	Liquor	Evap limited	Nominal feed	Higher Solids Feed	One-pass	Off-line #	On-line	
As-fired Solids, % :	65.0	71.4	85.0	65.0	71.4	71.4	85.0	63.0	85.0	
Heat Input, MBtu/hr :	6.0	6.0	6.0	10.7	12.0	12.0	12.0	12.0	12.0	
As-Rec'd HHV, Btu/lb:	6012	6012	6012	6012	6012	6012	6012	6012	6012	
Solids flow, #/hr :	1000	1000	1000	1780	2000	2000	2000	2000	2000	
High Solids Concentrator										
As-Rec'd Solids, % :	50	50	50	50	50	55.2	50	50	63	
Feed Liquor, #/hr:	2000.0	2000.0	2000.0	3559.5	4000.0	3623.2	4000.0	4000.0	3174.6	
Density (Cal), #/ft ³ :	77.7	77.7	77.7	77.7	77.7	80.0	77.7	77.7	83.6	
Liquor flow, gpm:	3.21	3.21	3.21	5.71	6.42	5.65	6.42	6.42	4.73	
Prod Liquor solids, %:	63.7	68.8	82.0	62.5	68.8	68.8	82.0	63.0	82.0	
Prod Liq. Flow, #/hr:	1569.2	1453.8	1219.6	2847.7	2907.6	2907.6	2439.1	3174.6	2439.1	
Conc. Liq. Temp., °F:	230	300	315	280	300	300	315	250	315	
Vapor Dens P., psig:	4.6	27.2	20.7	15.1	27.2	27.2	20.7	4.6	20.7	
Evaporation, lb/hr:	461.5	599.8	823.5	821.4	1199.7 #	822.9	1647.1 #	825.4	821.7	
Heat req'd, MBtu/hr:	0.51	0.68	0.91	0.92	1.35	0.96	1.81	0.99	0.95	
Steam Required, #/hr:	544.2	748.7	1021.8	1002.3	1497.4	1064.2	2043.5	1051.1	1071.5	
Steam Temperature, °F:	265.0	315.0	330.0	295.0	315.0	315.0	330.0	265.0	330.0	
Steam Pressure, psig:	20.7	63.0	88.4	42.9	63.0	63.0	88.4	20.7	88.4	
Steam Economy, --:	0.85	0.80	0.81	0.82	0.80	0.77	0.81	0.79	0.77	
Flash Tank										
As-fired Solids, % :	65.0	71.4	85.0	65.0	71.4	71.4	85.0	63.0	85.0	
As-fired Liq., #/hr :	1538.5	1400.2	1176.5	2738.1	2800.3	2800.3	2352.9	3174.6	2352.9	
Density (Cal), #/ft ³ :	83.4	85.9	92.7	83.4	85.9	85.9	92.7	81.5	92.7	
Liquor flow, gpm :	2.39	2.19	1.72	4.41	4.39	4.39	3.43	4.85	3.43	
As fired temp., °F :	220	240	250	220	240	240	230	260	250	
BP temp (calc), °F :	24.0	30.0	50.6	24.0	30.0	30.0	50.6	22.5	50.6	
F. Tank Press, psig:	-4.1	-0.6	-3.6	-4.1	-0.6	-0.6	-3.6	4.6	-3.6	
F. Tank T(sat), °F:	196.0	210.0	199.4	196.0	210.0	210.0	199.4	227.7	199.4	
Vapor flow , #/hr:	30.8	53.6	43.1	109.6	107.3	107.3	86.2	0.0	86.2	

A-10

TABLE 1 Summary of Concentrator performance

either the concentrator or the furnace. A 15 gpm recirculating liquor loop will be used to keep the tank contents mixed and to send liquor to the furnace and through the instruments to measure solids, density, and viscosity. The liquor line to the nozzle will branch from the main circulating line as close to the firing port as practical in order to minimize the length of the small diameter pipe used.

The small diameter pipe to the nozzle will have a quick disconnect fitting close to the nozzle so that the nozzle can be easily removed and replaced. This will permit on-line change of nozzle type, facilitate large flow rate changes requiring a different size nozzle, or substitution of a similar nozzle in case of nozzle pluggage. The line will also have provisions for steam purging to clear pluggage and to preheat before liquor addition.

The intermediate liquor storage tank (nominal 63% solids), required to achieve high capacity operation with high solids, will operate at about 10 psig to prevent flashing. There is no need to pressurize this tank much above the atmospheric pressure boiling point of about 240°F. This tank will have an external steam heater on its conical bottom to maintain temperature.

Black liquor piping will be carbon steel. Other materials may be used for pumps, valves, etc. based upon B&W standards and a materials engineering evaluation. All liquor lines from the concentrator to the flash tank and the liquor nozzle will be electrically heat traced to maintain the liquor at temperatures up to 300°F.

The black liquor handling system will also include a 5000 gallon wash water (weak liquor) tank (refer to Section A.13.3).

A.9 LIQUOR SPRAY NOZZLE

The liquor spray nozzle must be compatible with the furnace dimensions while producing a suitable liquor drop size distribution. Too many fine droplets will result in excessive mechanical carry over, while too many large drops will cause excessive wet liquor to reach the bed from a reasonable gun height. A conventional splash plate nozzle is not suitable since it will cause most of the liquor to impinge on the side walls with little time for drying because of the wide spray angle and relatively narrow width of the furnace. The walls would be coated with wet liquor under these conditions. A free flow cone nozzle, with a suitable spray angle will be used to achieve in-flight drying. An alternate design may be selected if a predominately "wall drying" mode of firing is desired.

The average (superficial plug flow) gas velocity at the nozzle elevation under the design conditions is 3.3 ft/s. This velocity will entrain all drops smaller than 0.23 mm. A spray nozzle (orifice size and pressure drop) was selected based on the drop size distribution, that will give a minimum fraction of drops less 0.23 mm diameter. This will result in

carryover comparable to the reference unit. Entrained drops will contribute to tube bank deposition.

The height of the gun above the spout was set so that the majority of the drops would dry in flight. This height was determined from the time required to dry the median-sized drop produced by the nozzle. This results in a nozzle height of 3 to 10 feet above the spout, depending on the liquor conditions (solids, viscosity, etc) and final nozzle selection. It is also anticipated that different nozzle locations will be required for optimizing the liquor spray pattern over the desired range of liquor solids concentrations (65 to 85%). The liquor port will be a slot, approximately 7 feet tall, with sectional, refractory lined, plug covers that can be moved to adjust firing elevation.

Design calculations and PR-FURMO simulations have identified a suitable nozzle for achieving the objectives of liquor drying with minimal entrainment. However, nozzle selection was based on the manufacture's performance data for water sprays, corrected to account for the higher viscosity and density of black liquor. Spray testing of several candidate nozzles will be required prior to combustion tests in the RFS to ensure the desired atomization is achieved with black liquor at 65-85% solids. A separate nozzle test program will be carried out in Phase II. The firing conditions will be simulated in B&W's atomization facility using a model fluid or lower solids liquor at room temperature to simulate high solids liquor viscosity at firing temperature.

A.10 AIR DELIVERY SYSTEM

The RFS will have three levels of air admission to simulate the primary, secondary, and tertiary zones used in commercial units. A single fan will be used to supply air to all zones of the furnace with individual zone dampers to control flow distribution. The total air flow required is about 10,000 lb/hr at the high capacity (12.0 million Btu/hr) firing rate.

Heated primary air will normally be admitted on all four walls of the RFS at all times. A single control damper and flow meter will be used for this system. Flow to each wall header will be balanced during commissioning.

Secondary air will normally be admitted on only two walls at a time, either both side walls or the front and back walls. The change between walls will be accomplished by having a separate duct leading to the ports on each wall. The supply to each duct will have a slide gate valve and pitot tube to balance flows and spectacle flange connections to isolate the two unused headers. Total secondary air flow will be measured and controlled in the main line leading to the supply ducts.

Tertiary air will be admitted only to the front and rear wall of the unit. Total tertiary air flow will be measured and controlled in the main duct leading to the headers. Flow to the individual headers will be balanced using slide gate valves and pitot tubes.

The headers and ducts in the air distribution system will be designed for a maximum flow of 50% of the total combustion air in the secondary zone, 50% in the tertiary zone, and 60% in the primary zone.

The number of primary air ports has been set to give a relatively low jet velocity so that the primary air reaction zone will be close to the wall. The number and spacing of the secondary and tertiary ports were scaled using representative commercial design criteria. The air port diameters were also scaled to reproduce the jet penetration found in the representative commercial unit. The elevations of the three port levels are set forth in Section A.4.

All air ports will be designed as 3 inch schedule 40 pipe penetrations (3.068 inch ID) through the water jacket into which sleeves with the desired port size can be inserted. This arrangement will permit port sizes and jet velocities to be readily changed.

The current port design (subject to change in Phase II) is summarized below:

Port	No per wall	No. Total	Elev. inches	I.D. inches	velocity ft/sec	spacing inches
PA	5	20	6	2.00	20	10
SA	4 S/S	16*	18	2.11	36	15
TA	4/3 F/R	7	132	1.94	35	15/20

(* only 8 are in use at one time)

where:

- PA - Primary air
- SA - Secondary air
- TA - Tertiary air
- S/S - Side walls
- F/R - Front and rear walls

Note that the RFS has the flexibility to admit secondary air to all four walls or secondary and tertiary air to a single wall if desired with the duct system described. The primary air system arrangement permits air to be admitted to less than four walls if desired. However, the air port sizing must be evaluated before using these alternate modes of operation.

An additional regulated air system will be used to supply the natural gas burners used for start-up and smelt tap heating. Air to these burners will be the minimum required to cool the ports when the burners are out of service. (Refer to Section A.11)

The RFS will share the existing forced draft fan and air heater with the adjacent 2.5 MW Circulating Fluid Bed (CFB) facility in order to reduce costs. Both the fan and air

heater have more than adequate capacity. This gas fired indirect air heater has the capability of preheating the primary and secondary air to 500°F at the design firing rate of 6.0 million Btu/hr. This temperature exceeds the normal value for kraft liquors, 300°F, but may be required for liquors with low heating value. Tertiary air will normally be supplied to the furnace at the fan exit conditions (i.e., without preheat). However, fan and air heater capacity are adequate at the nominal design heat input rate to preheat tertiary air to 500°F if desired.

A.11 AUXILIARY SUPPORT FIRING SYSTEM

The facility must be capable of burning low heating value liquors, or of operating at low loads with minimum auxiliary fuel. Auxiliary natural gas fired burners will be installed on one wall to support low heat input operation. These burners will also be used to preheat the furnace before liquor addition.

Two large (2 million Btu/hr each) auxiliary, gas-fired burners will be located in the east sidewall just above the secondary air ports. These burners will be used primarily to heat the refractory prior to the addition of liquor to the furnace. Two burners are used to achieve a more uniform heat distribution. A small (0.25-0.50 million Btu/hr) auxiliary, gas-fired burner will be located adjacent to the smelt spout to keep the smelt flowing freely. This burner will also be especially useful when burning low heating value liquors or when dealing with high melting point smelts.

These burners will be located in separate air ports that can supply about 20% of the combustion air for the natural gas. The majority of the air required for combustion will be supplied through the RFS primary and secondary ports. The burner designs will be based on proven industrial boiler lighter designs adapted to this application, and will be retractable so that they can be withdrawn from the furnace when not in use to prevent overheating. A guillotine damper will be closed when the burners are not in service to minimize air flow to that required to cool the ports and dampers.

A.12 SMELT HANDLING SYSTEM

Molten smelt will be tapped from the furnace via a 3 inch schedule 80 pipe (2.90 inch ID) used to form the spout opening in the front water wall of the furnace. The refractory lining inside the furnace will have a corresponding hole. The pipe will not extend through the refractory since that portion would be uncooled. Due to the relatively short periods of operation, any damage to the refractory opening can be repaired between test series. External to the furnace, a short uncooled stainless steel smelt spout will be bolted to the front wall. The external spout will carry the smelt away from the furnace wall and direct it to the smelt handling system (described in the following paragraphs) located immediately below the furnace. There is sufficient access to the furnace that the spout opening and the spout can be "rodded" when they become blocked with frozen smelt. It is recognized that the

uncooled external spout will suffer some attack by the hot smelt, but due to the relatively short operating periods, it can be replaced between test series if required.

Unlike a conventional pulp mill where the green liquor (produced when molten smelt from the recovery furnace is dissolved in water) can be reused in the process, there is no on-site use for green liquor. Green liquor cannot be sent to the sewer because of the high pH and reduced sulfur content. If green liquor produced at ARC were to be shipped back to the pulp mill, the volume returned would be approximately twice that of the black liquor received due to the limited solubility of the inorganic salts, about 25-30%. An alternate approach to handle smelt as a solid will be used.

It is proposed to cast the molten smelt into ingots using a pan conveyor system, similar to the system used commercially at Millar Western, Meadow Lake, Sask., Canada for disposal of smelt from a BCTMP process⁴. A series of shallow Meehanite pans, attached to a chain conveyor, move under the spout to receive the molten smelt. As the pans move away from the spout, the pans cool and the smelt will freeze into thin ingots. Solidification is controlled by the length and speed of the conveyor. The supplier, Industrial Equipment Co., Ltd., has provided a conceptual design of the system for the RFS.

The ingots will be collected in a closed container for return to the pulp mill that supplied the black liquor. At the mill the ingots can be dissolved in weak wash and added to the green liquor system. The details of the mill handling system remain to be developed when securing a liquor supplier.

A.13 ENVIRONMENTAL CONSIDERATIONS

The facility must satisfy the air and water emissions limits imposed by State and Federal regulations applicable to ARC. Solid and gaseous emissions from the furnace and liquid emissions from the concentrator must be considered.

A.13.1 Fume

In order to reduce cost and meet local emission regulations, the RFS will use an existing multicell baghouse to collect particulate matter (fume and mechanical carryover) in the flue gas leaving the convection pass. The baghouse is part of a 2.5 MW Circulating Fluid Bed (CFB) facility and is located immediately adjacent to the RFS. Although baghouses are not normally used in commercial kraft recovery applications, they are widely used for collecting fine aerosols. The suitability of a baghouse for this service has been demonstrated by the high collection efficiencies obtained by the University of Tennessee Space Institute (UTSI) on a similar fume, K_2SO_4 , from the coal fired magnetohydrodynamic (MHD) process⁵. Even if pluggage becomes a problem, the multiple cells of the existing baghouse will allow extended operation.

The saltcake (Na_2SO_4) catch from the baghouse, anticipated to be 80 to 100 lb/hr, will be collected in barrels or dry bulk containers for return to the pulp mill supplying the liquor. Bulk density of the recovered fume is on the order of 8 lb/cu.ft.

A.13.2 Gas Emissions

Maximum sulfur dioxide (SO_2) emissions are anticipated to be on the order of 200 to 500 ppm, depending on the sulfidity of the liquor. Under normal operating conditions, enough alkali fume will be present in the flue gas to maintain very low levels of SO_2 at the stack. Operating with a hotter bed will increase alkali levels. On the other hand, operating with no SO_2 in the flue gas may contribute to ash deposition problems in the convection pass.

Oxides of nitrogen (NO_x) are anticipated to be on the order of 70 to 100 ppm based on commercial unit experience^{3,6}. Because of the relatively low temperatures in a recovery unit, NO_x is formed from nitrogen in the fuel, with little or no contribution of thermal NO_x .

Available air dispersion model results indicate that using the existing CFB stack will not exceed permitted ground level concentrations of regulated species. Since sharing of some equipment will preclude running both the CFB and the RFS at the same time, discharge limits will not require modification. The B&W R&D Division is structuring its permits such that continuous emission monitors will not be required on small test units such as the RFS. The emissions levels could be reported on a parametric basis using the quantity and characteristics of the fuel burned. However, since the regulatory process is on-going, the potential for requiring a continuous emission monitor remains.

A.13.3 Water Discharge

There will be a blowdown stream from the furnace and convection pass water jackets to prevent excessive build up of water treatment chemicals. Based on the study of a larger test facility, the blowdown stream, which is nominally 2 gpm, can be safely discharged into the sanitary sewer with no noticeable effect on the total ARC sewer flow. The blowdown stream will be cooled from 212°F to 140°F with the make-up water as the heat sink, using a double pipe heat exchanger similar to the design used on other facilities.

The process vapor condensate from the concentrator system condenser will normally be discharged to the sanitary sewer. The flow rate, 2 gpm, is within the range that can be handled without special precautions based on the blowdown study. The temperature will be about 150°F, which will not upset the plant limit of 140°F. During upset periods, when liquor entrainment may contaminate the condensate, it will be diverted to the wash water tank. Contamination will be detected by a conductivity meter in the condenser discharge line. Plant steam condensate is returned to the plant boiler hot well and is not discharged from the RFS facility.

The RFS facility will have a sealed floor and a dike surrounding the area under the concentrator and liquor storage tanks to contain any spills. Because of the elevated location of the liquor handling equipment, any water or spilled liquor will drain from the dike to the 5000 gallon wash water tank located under the RFS. Any time the heavy liquor lines need to be flushed out, the dilute liquor will also be sent to this wash water tank. This tank will also be a source of wash water since dilute liquor, up to about 25% solids, will work well for washing out equipment and liquor lines.

There will be no discharge of liquid from the wash tank to the sanitary sewer. In order to prevent liquor solids from building up in the wash water tank, the wash water can be bled back into the concentrator system. Although it is not necessary to completely empty the tank, the entire 5000 gallons can be evaporated in 48 hours. If the tank is in danger of overflowing, the excess wash water can be transferred into an empty liquor tank truck and returned to the mill supplying the black liquor.

A.13.4 Concentrator Non-Condensable Gas

There will be some non-condensable gas (NCG) that must be withdrawn from the condenser shell of the concentrator system in order for the system to work properly. Normally this gas will be mostly air. It is anticipated that very little organic vapor will be released, since all of the more volatile compounds, such as methanol, having been steam stripped from the liquor during the initial concentration from about 12-15% to 50% at the mill. However, some malodorous sulfur-bearing NCGs may be formed during concentration to higher solids at higher temperatures^{7,8}. The NCGs will be drawn from the concentrator system condenser by a steam eductor. The eductor not only creates a partial vacuum in the condenser, it also dilutes the NCG stream for safety reasons (toxicity and flammability). The eductor exit stream will be sent to the FM boiler or the gas fired air heater for thermal oxidation. Note that the FM boiler must be running whenever the concentrator is in operation to supply steam and the gas fired heater is required for air preheating during RFS operation.

A.13.5 Fugitive Emissions

Fugitive emissions from the liquor tanks can be prevented by sealing all tanks and running vent lines to a knockout drum and a caustic bubbler or to a carbon filter. The knockout drum will prevent drawing sodium hydroxide solution back into the system. A vacuum breaker will also be included in the design. A dedicated carbon filter may be used on the concentrator feed tank because of its remote location.

A.14 MATERIAL AND ENERGY BALANCE AND PROCESS FLOW DIAGRAM

Heat and material balances have been prepared using a LOTUS 1-2-3® spreadsheet program for a number of operating conditions of the RFS. The balances include the concentrator, flash tank, and baghouse as well as the furnace. The purpose of these balances

was primarily to quantify the air, water and steam requirements under different load and solids concentrations. The results of these balances are displayed on a schematic four page Process Flow Diagram (PFD) to better illustrate the relationship of the various streams. Also printed as part of the PFD is a listing of all the inputs used in the balance.

The PFD for the nominal design case is shown in Attachment 2 as an example of a typical heat and material balance.

It should be noted that all the "dust" in the flue gas is the result of an assumed carryover rate. There has been no attempt to calculate alkali vaporization (fuming) or aerodynamic droplet entrainment. There are several features in the PFD for potential future expansion such as ammonia injection for NO_x control, an air heater/gas cooler, and a dry scrubber for acid gas control. These all show zero flows since they are not part of the base design.

A.15 NITROGEN OXIDE REDUCTION CAPABILITY

The facility will have the future capability to investigate NO_x control processes such as selective non-catalytic reduction (SNCR) using urea or ammonia injection. Provisions will be made in the design of the furnace and convection pass to accommodate the addition of equipment for NO_x control studies in the future. The recommended temperature window for SNCR is 1700°F to 2000°F for either urea or ammonia⁹. The supplier recommended residence time is 1.0 sec. for urea and 0.5 sec. for ammonia in coal fired units. The residence time is unknown in recovery units. This temperature window will exist from the top of the furnace (just below the nose) to the simulated convection bank inlet. An extended cavity will be provided that results in a residence time of approximately 2 seconds. The NH₃ requirement is about 3 lb/hr to 5 lb/hr at the design heat input rate. Ammonia can be injection as a 25-28% NH₄OH solution (as in a utility boiler) or as NH₃ gas. The latter choice is possible in view of the small quantities involved and likely short-term nature of the tests that might be performed.

A.16 SMELT-WATER EXPLOSION

One of the unique concerns in the operation of a kraft process recovery furnace is the danger of a smelt-water explosion. The frequency of recovery boiler explosions is approximately one per 100 years of boiler exposure (including approximately 23% attributed to auxiliary fuel explosions)¹⁰. The facility must be designed and operated in such a manner that the risk of an explosion is minimized.

Smelt-water explosions are the result of a sudden vaporization of water caused by an intimate mixing of liquid water into molten smelt. The explosion potential is minimized by preventing liquid water and molten smelt from coming into contact.

There are two primary causes of water introduction into the recovery furnace that could initiate smelt-water explosions: 1) leaking pressure parts or water cooled parts and 2) inadvertent introduction of low solids liquor or water directly via the liquor gun. The RFS, unlike a commercial unit, does not have pressurized components. Any leaks will be limited to the driving pressure of the static head in the walls from the near ambient pressure boiling water. The RFS will be lined with refractory and will be hydrostatically tested prior to refractory installation to ensure there are no leaks present after fabrication and erection. An aggressive refractory inspection and maintenance program will be used to assure that this protection remains viable.

The water spray cooled smelt conveyor is the other water cooled device associated with the RFS. It is external to the furnace and based on commercial design to minimize the chance of any problems arising.

The second source of water will be minimized by continuously measuring liquor density and concentration in the liquor feed system to warn operators of low liquor solids concentrations. A system interlock will close an isolation valve stopping liquor flow, should density or concentration fall below a setpoint that will be established based on industry experience.

A "Panic Button" will be installed, per an internal B&W Design Review Finding, that can be used to initiate an Emergency Shutdown Procedure (ESP) in case of a suspected leak into the furnace. The ESP will shut off all fuel flow to the system (black liquor and natural gas to furnace and air heater) and shut off primary and secondary air flow. Tertiary air flow continues and the ID fan continues to run to purge the furnace of any combustible gases and provide draft. The furnace walls will not be drained because the stored heat in the refractory could overheat the metal jacket. Overheating the jacket could cause structural damage to the facility or failure of the jacket. Jacket failure could allow more water to enter the furnace and potentially cause an explosion.

An ESP will be initiated when the operator sees water running into furnace, the DEWBI meter detects an abnormally high exit gas humidity, or the feed water flow is abnormally high for the liquor flow. (The DEWBI meter is a B&W developed "wet bulb/dry bulb thermometer" specially designed to work in dirty gas environments.)

A.17 EXTENDED PERIOD OF OPERATION

The RFS must be capable of operating continuously for several days at a time to provide steady state operations and minimize costs. The alternative operation method of daily startups would limit the hours of actual testing and severely stress the refractory due to the daily thermal cycles.

Long term operation of the facility will depend on receiving liquor shipments in a timely manner. At the nominal design firing rate of 6.0 million Btu/hr, the system will use about 3.2 gpm of 50% solids liquor or about 200 gal/hr. A 6000 gallon tank truck will be consumed in a little over one day. This means a new liquor truck must arrive every day. During winter operation, the arriving tank truck must be connected to a steam line and preheated before transferring the liquor into the concentrator feed liquor tank.

Adequate temporary storage of the smelt ingots will be provided so that their disposal does not limit the duration of testing.

A.18 FUTURE EXPANSION

It is desirable for the RFS facility to provide flexibility for future expansion to address research alternatives or needs that are not currently identified. As an example, there is space available in the facility layout to add flue gas handling equipment and conduct future research programs on gaseous emission controls. Examples include additional equipment such as a condensing heat exchanger (CHX), a dry scrubber, or flue gas recirculation for NO_x control. The proposed facility arrangement would permit addition of such equipment.

As discussed in the report executive summary and project technical results, black liquor gasification is the leading candidate technology competing with high solids advanced combustion recovery boilers to improve black liquor processing. When developing plans for the balance of the project, a combined processing facility that could support both advanced combustion and gasification development was considered as an option for the later phases of this project. However a budgetary cost evaluation indicated that a better approach is to evaluate these two technologies and select a path forward based on pursuing a single technology, either high solids advanced combustion or black liquor gasification.

This specification addresses the facility design needed to support high solids advanced combustion development. It assumes that if gasification is developed, it would be pursued by possibly an addition to the facility. The general site arrangement has space to the north that could accommodate a future facility addition if that would be desired. Also, the facility liquor handling and processing, and supporting utilities (such as natural gas, electricity, plant steam, and compressed air) would also be available to support such an addition. Thus, the facility arrangement also provides this longer term flexibility.

A.19 REFERENCES

1. Wessel, R. A., Parker, K. L. and Akan-Etuk, A.; "Three-Dimensional Flow and Combustion Model of a Kraft Recovery Unit"; presented at TAPPI Engineering Conference; Orlando, FL; Sept. 20-25, 1993.
2. Hiner, L.A., "Kraft Recovery Boiler Operation for Control of Ash Chemistry", Proc.

2. Hiner, L.A., "Kraft Recovery Boiler Operation for Control of Ash Chemistry", Proc. TAPPI Eng. Conf., San Francisco, CA 1994.
3. Clement, J. L., and Barna, J. L., "The Effect of Black Liquor Fuel Bound Nitrogen on NO_x Emissions", Proc. TAPPI Eng. Conf. 1993.
4. Young, J. W., "Meadow Lake Enters Third Year of Zero-Effluent Pulp Production"; Pulp & Paper, 68(3):56-61 1994.
5. Johanson, N. R., Attig, R. C., Muehlhaeuser, J. W., Chapman, J. N., and Sanders, M., "2004 Hours of Proof-Of-Concept Testing at the CFFF"; Proc. 29th Symposium on Engineering Aspects of Magnethohydrodynamics, New Orleans, LA, p. 1.2.1 1991.
6. Aho, K., Hupa, M., and Vakkilainen, E., "Fuel Nitrogen Release during Black Liquor Pyrolysis", TAPPI 77(5):121-127, 1994.
7. Oshen, S., Stewart, P. J., and Golike, G. P., "Ultra-High Solids Concentration of Black Liquor Using the HPD High-Solids Crystallizer", Proc. CPPA/TAPPI Int. Chemical Recovery Conf., Ottawa, Ontario, p. 161-168 1989.
8. Ryham, R., "A new Solution to Third Generation Chemical Recovery", Proc. CPPA/TAPPI Int. Chemical Recovery Conf., Seattle, Washington, p. 581-588 1962.
9. Stultz, S. C., and Kitto, J. B., editors; STEAM/its generation and use: 40th Ed; Babcock & Wilcox; 1992.
10. Grace, T. M., "Recovery Boiler Explosions"; 1990 Kraft Recovery Operators Short Course, TAPPI Press; 1990.

ATTACHMENT 1

to

APPENDIX A

PFD and P&ID

(THIS PAGE LEFT INTENTIONALLY BLANK)

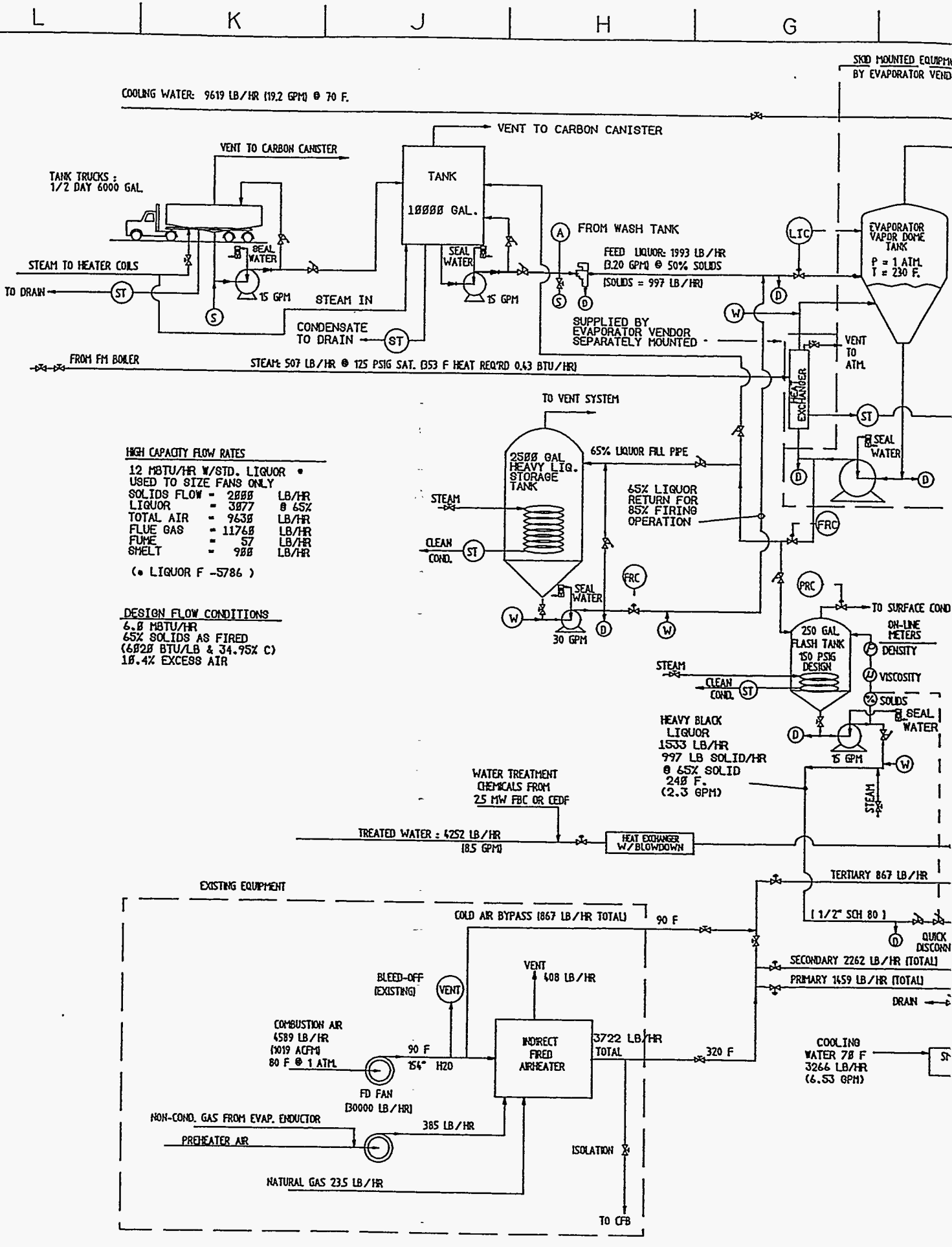

COOLING WATER: 9619 LB/HR (19.2 GPM) @ 70 F.

TANK TRUCKS :
1/2 DAY 6000 GAL.

VENT TO CARBON CANISTER

10000 GAL. TANK

FROM WASH TANK
FEED LIQUOR: 1993 LB/HR
@ 2.20 GPM @ 50% SOLIDS
(SOLIDS = 997 LB/HR)

SUPPLIED BY
EVAPORATOR VENDOR
SEPARATELY MOUNTED

EVAPORATOR VAPOR DOME TANK
P = 1 ATM.
T = 230 F.

STEAM TO HEATER COLS

SEAL WATER

CONDENSATE TO DRAIN

FROM FM BOKER

STEAM: 507 LB/HR @ 125 PSIG SAT. @ 53 F HEAT REQ'D 0.43 BTU/HR

VENT TO ATM

HIGH CAPACITY FLOW RATES

- 12 MBTU/HR W/STD. LIQUOR • USED TO SIZE FANS ONLY
 - SOLIDS FLOW = 2888 LB/HR
 - LIQUOR = 3877 @ 65%
 - TOTAL AIR = 9638 LB/HR
 - FLUE GAS = 11768 LB/HR
 - FUME = 57 LB/HR
 - SMELT = 988 LB/HR
- (• LIQUOR F -5786)

DESIGN FLOW CONDITIONS

- 6.8 MBTU/HR
- 65% SOLIDS AS FIRED
- (6828 BTU/LB & 34.95% C)
- 18.4% EXCESS AIR

TO VENT SYSTEM

2500 GAL. HEAVY LIQ. STORAGE TANK

65% LIQUOR FILL PIPE

65% LIQUOR RETURN FOR 85% FIRING OPERATION

STEAM

CLEAN COND.

SEAL WATER

30 GPM

STEAM

CLEAN COND.

TO SURFACE COND

ON-LINE METERS
DENSITY
VISCOSITY
SOLIDS

250 GAL FLASH TANK
150 PSIG DESIGN

SEAL WATER

15 GPM

HEAVY BLACK LIQUOR
1533 LB/HR
997 LB SOLID/HR
@ 65% SOLID
248 F.
(2.3 GPM)

WATER TREATMENT CHEMICALS FROM 25 MW FBC OR CEDF

TREATED WATER: 4252 LB/HR (18.5 GPM)

HEAT EXCHANGER W/BLOWDOWN

TERTIARY 867 LB/HR

EXISTING EQUIPMENT

COLD AIR BYPASS (867 LB/HR TOTAL) 90 F

BLEED-OFF (EXISTING) VENT

VENT 408 LB/HR

COMBUSTION AIR
4589 LB/HR
(1019 ACFM)
80 F @ 1 ATM

90 F

754° H2O

FD FAN (30000 LB/HR)

NON-COND. GAS FROM EVAP. ENDOCTOR

385 LB/HR

PREHEATER AIR

NATURAL GAS 235 LB/HR

INDIRECT FIRED AIRHEATER

3722 LB/HR TOTAL

320 F

ISOLATION

TO CFB

1 1/2" SCH 80

QUICK DISCON

SECONDARY 2262 LB/HR (TOTAL)

PRIMARY 1459 LB/HR (TOTAL)

DRAIN

COOLING WATER 78 F
3266 LB/HR
(6.53 GPM)

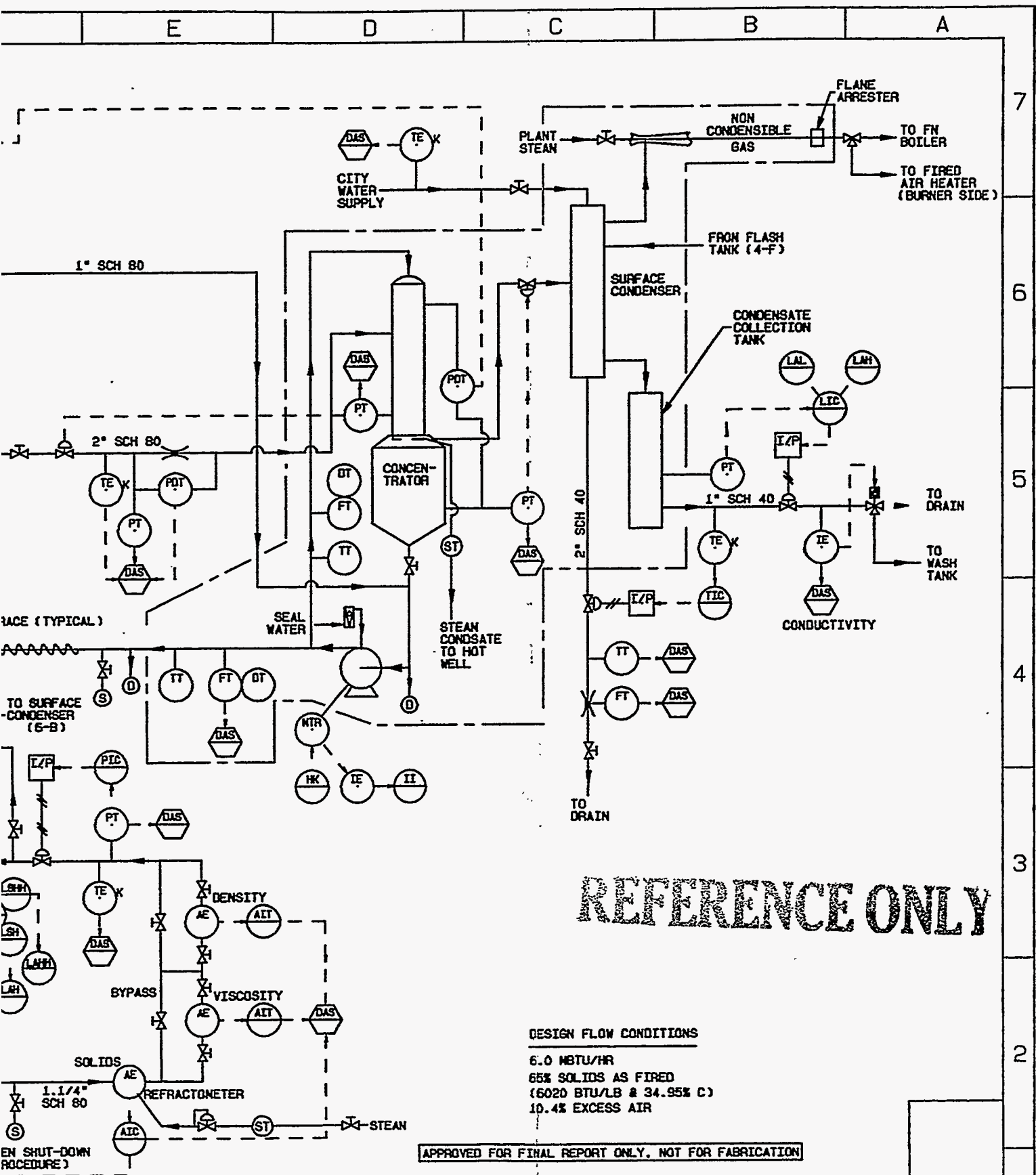

REFERENCE ONLY

DESIGN FLOW CONDITIONS
 6.0 MBTU/HR
 65% SOLIDS AS FIRED
 (6020 BTU/LB & 34.95% C)
 10.4% EXCESS AIR

APPROVED FOR FINAL REPORT ONLY. NOT FOR FABRICATION

				RECOVERY FURNACE SIMULATOR (RFS)		THIS DRAWING IS THE PROPERTY OF BABCOCK & WILCOX RESEARCH AND DEVELOPMENT DEPARTMENT	
				BLACK LIQUOR PREPARATION SYSTEM		DO NOT LOAN, REPRODUCE OR DISSEMINATE THIS DRAWING TO ANY OTHER PERSONS WITHOUT THE WRITTEN PERMISSION OF THE PROJECT MANAGER. IT IS TO BE RETURNED UPON REQUEST.	
				PROCESS & INSTRUMENTATION DRAWING		REV 1	
				THIS IS A CAD DRAWING - DO NOT REVISE MANUALLY		REV 2	
				DO NOT SCALE - USE DIMENSIONS ONLY		REV 0	
REV NO		REVISED BY	CHECKED BY	DATE	DESIGNED BY	SCALE	NO
					FESER	NA	15081-D
					DATE	APP'D BY	NO
					3-20-95		0
						43244-010-010	

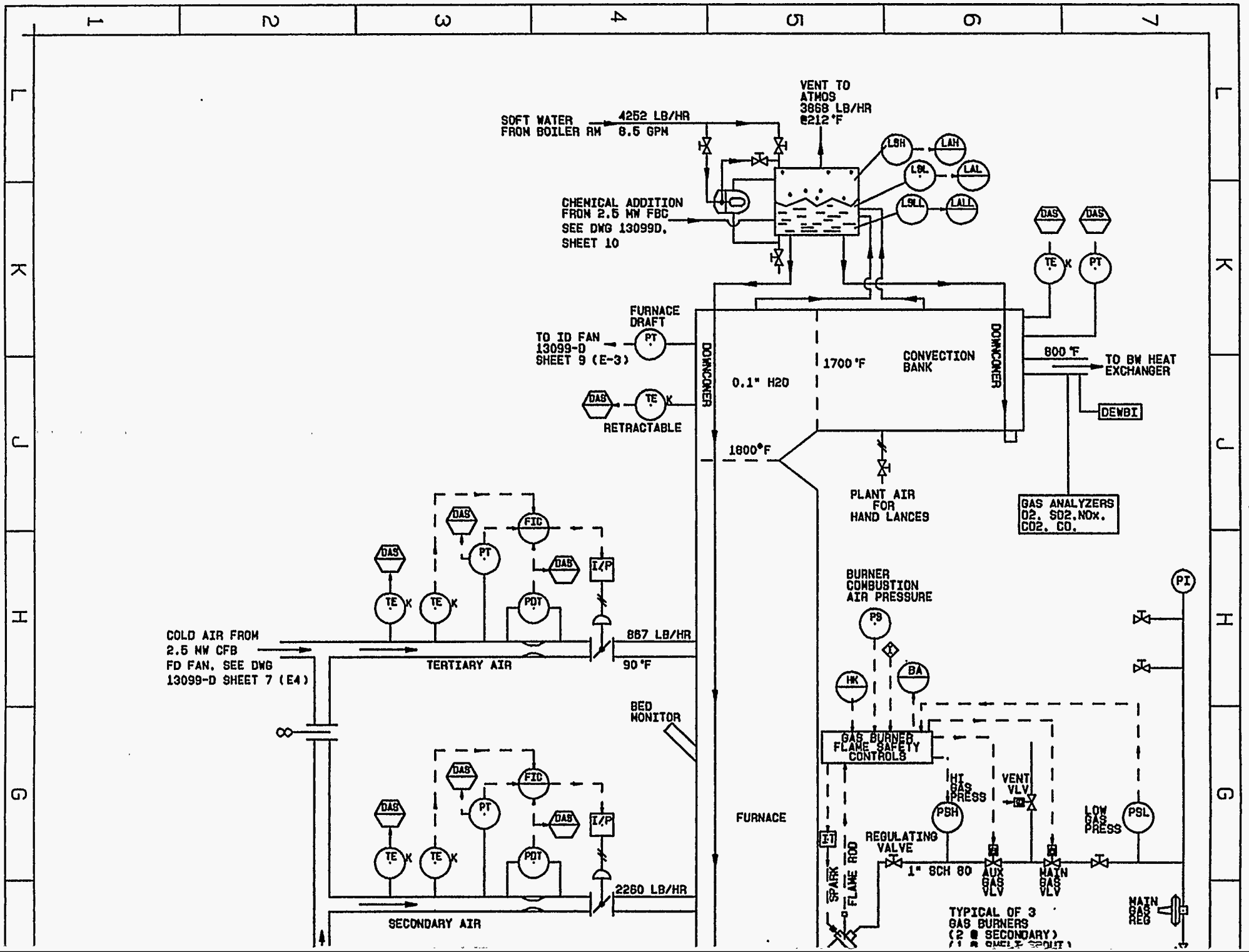

REV NO	REVISED BY	DATE

REVISION	DATE	BY	REASON

DO NOT SCALE - LINE CONNECTIONS ONLY	SCALE	NA
DESIGNED BY: FESER	PROJECT BY: FESER	SCALE: NA
CHECKED BY: [Signature]	DATE: 3-20-95	PROJECT NO: 48244-010-010

15081-D	2	2	FINAL
---------	---	---	-------

PREHEATED AIR FROM
2.5 MW CFB AIR HEATER
SEE DWG 13099-D
SHEET 7 (E6)

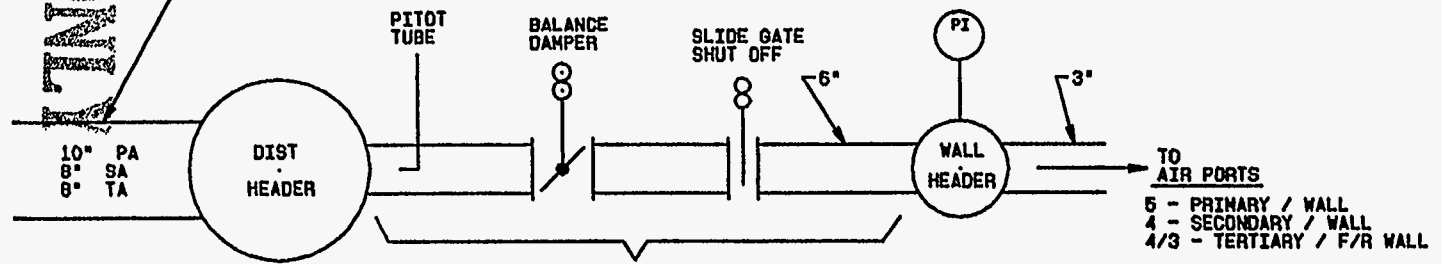
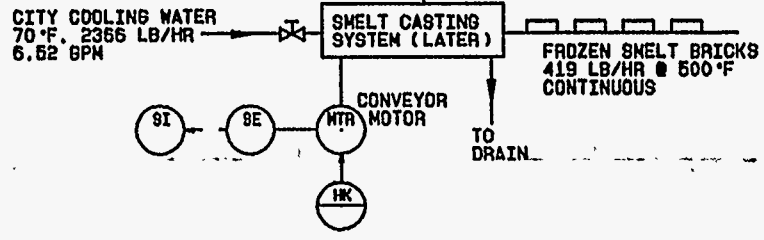
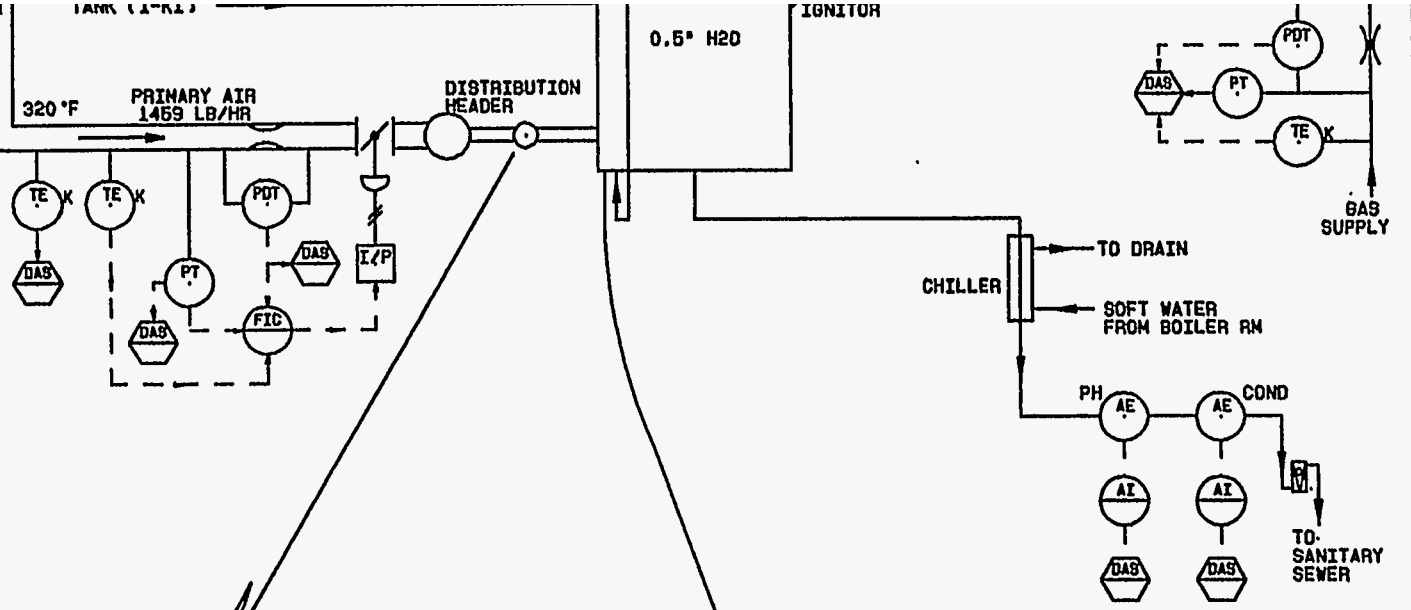

TYPICAL BRANCH LINE
 4 - PRIMARY (NO SLIDE GATE)
 4 - SECONDARY
 2 - TERTIARY (NO SLIDE GATE)

APPROVED FOR FINAL REPORT ONLY, NOT FOR FABRICATION

REFERENCE ONLY

RECOVERY FURNACE SIMULATOR (RFS)

FURNACE AND CONNECTION PASS
PROCESS & INSTRUMENTATION DRAWING

DESIGNED BY: BABCOCK & WILCOX
PROJECT NO: 48244-010-010

E

D

C

B

A

F

D

C

B

A

1

2

3

4

5

6

7

ATTACHMENT 2

to

APPENDIX A

RFS Heat and Material Balance

(THIS PAGE LEFT INTENTIONALLY BLANK)

BLACK LIQUOR RECOVERY FURNACE

PROCESS FLOW DIAGRAM and MATERIAL & ENERGY BALANCE

(All Values are Pounds/Hour unless noted otherwise)

Basis: 1000 lb solids/hr from Nominal Design Conditions
 Fuel has 50 % moisture and 6012 Btu/lb as received.

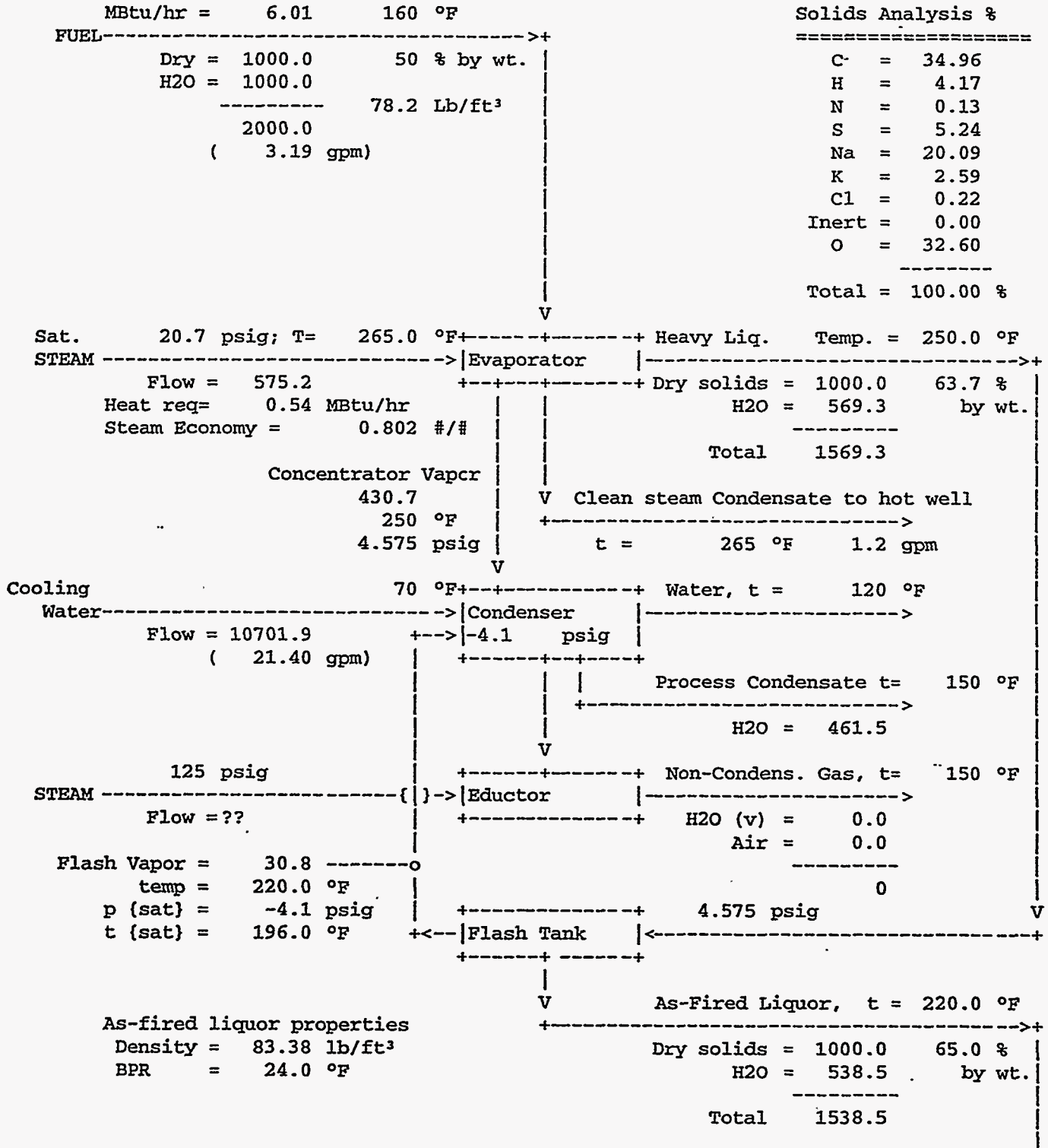

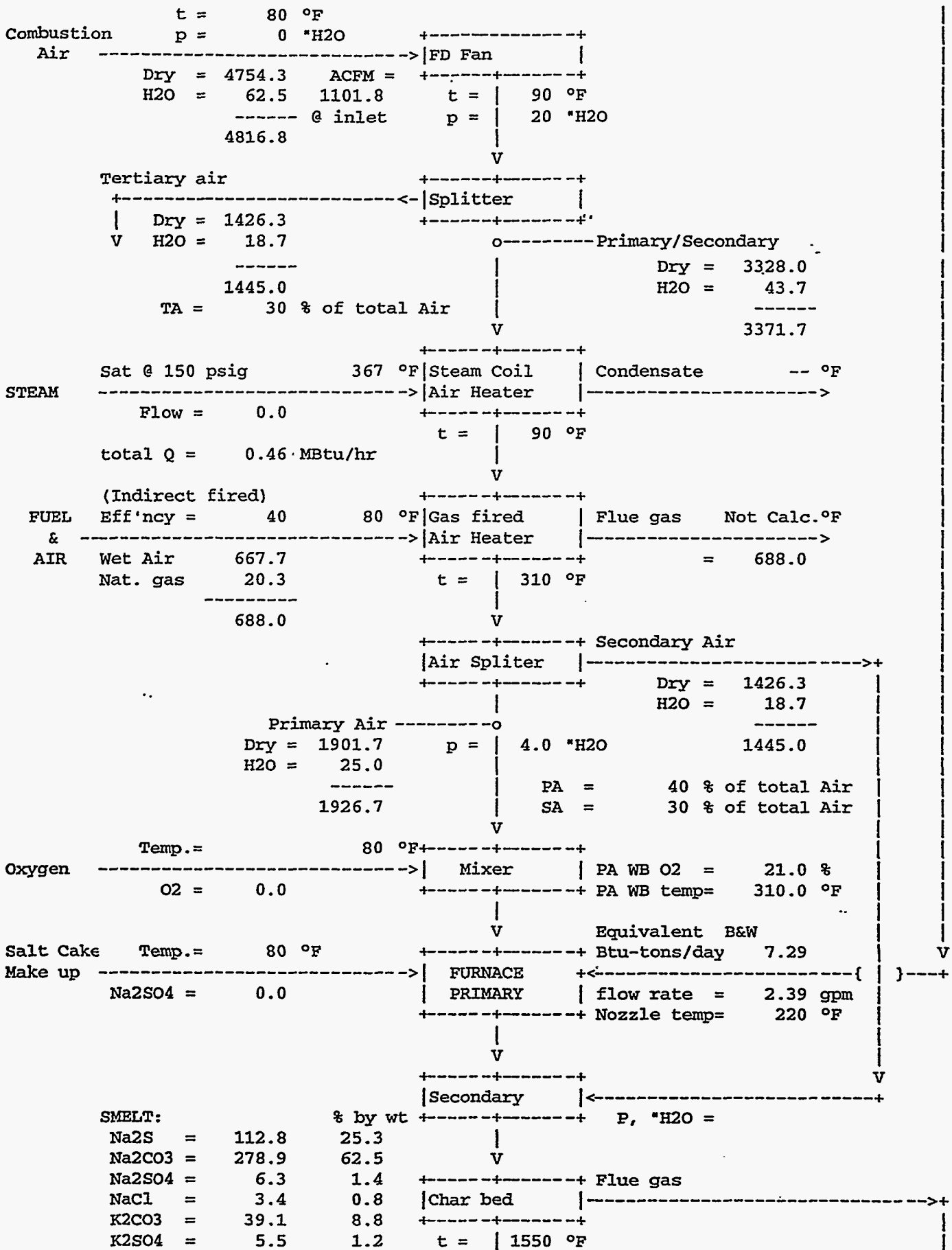

Carbon =	0.0	0.0		Reduction =	95.00 %
Inert =	0.0	0.0		Sulfidity =	33.15 %
				Salinity =	0.66 %
Total =	446.1	100.0	-----o	K in Alkali =	7.05 %

V

Cooling water	t = 70 °F	+	SMELT @ t = 500 °F
	Flow = 3462.0	+	
	(6.92 gpm)	+	
	Q = 0.17 MBtu/hr	+	water @ t = 120 °F

Supplemental Nat. Gas	t = 80 °F	+	Flue gas:	t = 2200 °F	V
	Flow = 0.0	+	Dry Gas = 3481.5	%O2 = Substoic	
	Q = 0.00 MBtu/hr	+	H2O = 954.8		
	= 0 % of input	+	total 4436.3	Mol wt = 26.10	

Tertiary air	t = 90 °F	+	RhoG = 0.01344	lbm/ft ³
	Dry = 1426.3	+	Vel. = 3.67	fps
	H2O = 18.7	+	1.12	m/s
	1445.0	+	t = 2452 °F (adiabatic T.)	
		+	NOx = 87 ppm	
		+	0.07 #/MBtu	

Ammonia Injection NH3(g)	t = 80 °F	+	Flue gas	
	Flow = 0.0	+	Dry = 4907.2	H =
		+	H2O = 973.6	0.1984 #/#
Dilution Air		+	Dust = 28.4	
	Dry = 0.0	+	total 5909.1	
	H2O = 0.0	+		
	0.0	+		

Makeup Treated Water H2O	80 °F	+	FURNACE Shaft	(Q = 1.6 MBtu/hr)
	4085.3	+		Steam = 1472.4
	(8.2 GPM)	+		t = 212 °F
		+		p = 0 psig
		+		Blowdown 10 %
		+		H2O = 371.4
		+		(0.7 gpm)
		+	t = 1700 °F	
		+	p = 0 "H2O	

		+	CONVECTION BANK	(Q = 1.9 MBtu/hr)
		+		Steam = 1700.7
		+		t = 212 °F
		+		p = 0 psig
		+	t = 700 °F	
		+	p = "H2O	

Water treatment chemicals from CEDF/CFB		+	BWHX	(Q = 0.6 MBtu/hr)
		+		Steam = 540.8
		+		t = 212 °F
		+	t = 350 °F	
		+	p = "H2O	

Flue gas -----o-----	Flue Gas Composition		
Dry gas = 4907.2	CO2	16.40 %	dvb
H2O = 973.6	O2	2.04	
Dust = 28.4	Ar	0.96	
	N2	80.58	
Total gas 5880.7	SO2	0.02	{ppm = 195
	HCl	0.00	{ppm = 0
Dust = 4.73 #/MBtu	CO	0.00	{ppm = 0
= 3.48 grain/DSCF	NOx	0.01	{ppm = 87
	NH3	0.00	{ppm = 0

Cooling t = 80 °F (Q = 0.0 MBtu/hr)
 Air----->| Air Heater |----->
 t = 350 °F
 p = *H2O

Infiltration t = 80 °F
 Air----->| MIXER |----->
 Dry = 116.1 2.0 %
 H2O = 1.5

 117.6
 t = 345 °F t{dp} = 147.0 °F
 p = -10 *H2O

Vent Air -----o----- Flue Gas Composition
 t{dp} = 148 °F
 Dry = 80 °F
 H2O = -----
 t = 80 °F
 Slurry ----->| Dry Scrub. |----->
 Na2CO3 =
 Inerts =
 H2O =
 Atom Air =
 H2O in Air =

 0
 (Na2O/S = ---)
 (Rho = ---)
 t = 345 °F
 p = -10 *H2O
 Flue Gas Composition
 CO2 15.99 % dvb
 O2 2.50
 Ar 0.96
 N2 80.52
 SO2 0.02 {ppm = 190
 HCl 0.00 {ppm = 0
 CO 0.00 {ppm = 0
 NOx 0.01 {ppm = 85
 NH3 0.00 {ppm = 0

Dust t = 350 °F
 | BAG HOUSE |----->
 Na2CO3 = 15.9 56.6 % by wt
 Na2SO4 = 9.2 32.6
 NaCl = 0.2 0.6
 K2SO4 = 2.9 10.2
 Inert = 0.0 0.0

 total 28.1 100.0

Dry flue gas
 Mol wt = 30.84
 ACFM = 2140 @ Fan inlet

RFS elevation = 1100 feet
 | ID Fan |----->
 Flue Gas t = 345 °F
 Dry gas = 5023.2 H =
 H2O = 975.1 0.1941 #/#
 Dust = 0.3

PROCESS: RECOVERY FURNACE SIMULATOR
 Liquor : Nominal Design Conditions
 Date : 09-Aug 1995
 Time : 08:34 AM

total = 5998.6
 SO2 = 0.33 lb/MBtu
 190 ppm
 Dust = 0.05 lb/MBtu

PROCESS MATERIAL BALANCE

IN		OUT	
Liquor Solids	1000.0	Dry Gas	5023.2
H2O in Liquor	1000.0	H2O	975.1
Dry P/S air	3328.0	Fume (dust)	0.3
Dry Ter air	1426.3	Baghouse catch	28.1
Total H2O in air	62.5	Smelt	446.1
Salt cake	0.0	Evap. Cond	461.5
Oxygen	0.0	Non-Con gas	0
Natural Gas	0.0		
Air infiltration	117.6		-----
Vent air	0		6934.4
Soda ash Slurry	0		
Atomizing air	0		
NH3 Injection	0.0		
	-----	Error {in - out} =	-0.0
TOTAL	6934.4	% of input	-0.00

Liquor firing conditions:

As fired Solids=	65 %
HHV	= 6012 Btu/lb
Liquor Temp.	= 220 °F
Heat capacity	= 0.646 Btu/lb°F
Density {S,t}	= 83.4 Lb/ft³

Furnace Conditions:

Furnace EGT	=	1700.0 °F
Convec. Bank EGT	=	700.0 °F
Economizer EGT	=	350.0 °F
Blowdown rate	=	10.0 %

Heat Input Rate= 6.0 MBtu/hr

Design Conditions - Evaporator:

Liquor Temp out,	=	250 °F
cooling H2O, in	=	70 °F

Liquor in	=	160 °F
Cooling H2O out	=	120 °F

Design Conditions - Furnace:

Excess Air, %	=	10.4	Equiv. Ratio	=	0.906
O2 content of EA	=	30 %dwb (if used) based on total air to unit			
Atmospheric Air supplies:		100.00 mol % of dry "EA", Balance is pure O2			
Sup. Natural gas	=	10 % of fuel Btu input (if used)			
NH3 Molar Ratio	=	2.0 based on NOx (if used)	NH3 Slip	=	5.00 %
NOx reduction	=	50.0 % of NOx formed (if NH3 used)			
Dilution air ratio	=	10 mol air/mol NH3(g)			
Primary Air Split	=	40 % of total air			
Secondary Air	=	30 % of total air			
Pri/Sec Air Temp	=	310 °F			
Steam Supply	=	857.5 Btu/lb @ 150 psig sat, t = 367°F			
Smelt cooler exit	=	500 °F	smelt C{p}	=	0.28 Btu/#-°F
Indirect AH eff	=	40 % (if used)	Air infiltration	=	2.0 % of flue gas
Ind AH Excess air	=	100 % (if used)	BagHouse Eff.	=	99.0 % of inlet dust

Carryover assumed:	0.0500 lb/lb	=	5.0 % of spray liq.
salt cake make up:	0.0000 lb/lb solids	=	0 lb/Ton
Heat released :	100.0 % based on unburned Carbon only; @		14093 Btu/# C
CO :	0.00 % of carbon input Btu/# C		
NO formation :	15.00 % of N2 in Liquor		

STEAM CONDITIONS :

Enthalpy of Steam @ T & P =	212 °F.	0 Psig;	=	1150.4 Btu/lb
Enthalpy of Feed water @ T=	80 °F	=		48.0 Btu/lb

(THIS PAGE LEFT INTENTIONALLY BLANK)

APPENDIX B
RECOVERY FURNACE SIMULATOR -
SCALING METHODOLOGY

(THIS PAGE LEFT INTENTIONALLY BLANK)

TABLE OF CONTENTS

<u>Section</u>	<u>Page</u>
SUMMARY OF FURNACE DESIGN.....	B-1
PILOT FURNACE SCALING.....	B-2
AIR PORT SIZING.....	B-6
LIQUOR SPRAY ELEVATION AND NOZZLE SELECTION.....	B-7
Black Liquor Spray Drop Size Distribution.....	B-7
Critical Drop Size for Entrainment.....	B-8
Preliminary Nozzle Selection.....	B-10
Liquor Spray Elevation.....	B-11
DESIGN EVALUATION BY NUMERICAL MODELING.....	B-12
LITERATURE CITATIONS.....	B-13

LIST OF FIGURES

<u>Figure</u>	<u>Page</u>
1 Tertiary Air and Furnace Nose Elevation as a Function of RFS Plan Area.....	B-3
2 Relative Size of RFS and a Range of Commercial Recovery Boilers.....	B-3
3 Wall Surface Area Per Furnace Volume for RFS and a Range of Commercial Units.....	B-4
4 Furnace Volume per Net Heat Input for RFS and a Range of Commercial Units.....	B-5
5 Heat Input per Plan Area for RFS and a Range of Commercial Units.....	B-5

LIST OF TABLES

<u>Table</u>	<u>Page</u>
I Black Liquor Drop Size Distribution from Commercial Nozzles.....	B-9

(THIS PAGE LEFT INTENTIONALLY BLANK)

APPENDIX B: RECOVERY FURNACE SIMULATOR - SCALING METHODOLOGY

The goal of Recovery Furnace Simulator (RFS) operation is to reproduce the chemical processes occurring in a conventional recovery boiler (e.g., black liquor drying and devolatilization, char carbon conversion, sodium sulfate reduction, aerosol formation, and gaseous pollutant formation and destruction). It is necessary to accurately simulate the distribution and mixing of black liquor and air, furnace temperature profile, gas species concentrations, and residence times because these factors control the chemical processes of interest. It was not a design objective to reproduce commercial liquor firing practice or heat removal technology.

The methodology used to arrive at a preliminary RFS design is described in this section. A large, single-drum recovery boiler was used as the basis of this design. As described elsewhere, numerical modeling was used to support the design and to verify that the RFS would reproduce the following characteristics of the commercial boiler:

- gas residence time and temperature profile
- air jet penetration and mixing patterns
- black liquor distribution (amount of fired black liquor burned in flight, amount deposited on walls and bed, and amount entrained in gas flow and carried into convection pass).

SUMMARY OF FURNACE DESIGN

A nominal heat input rate of 6.0 million Btu/hr (6.33×10^6 kJ/hr) was chosen as a practical value for handling black liquor at the pilot scale. Other pilot test facilities operating at about 6 million Btu/hr have proven successful for studying fossil fuel combustion and emissions chemistry [1,2]. In order to simulate the gas temperature profile of a commercial unit, the RFS furnace has been designed as a refractory-lined, water-cooled chamber with a 25 ft² (2.32 m²) plan area. The furnace will have a three level air system and single liquor spray nozzle. The primary air ports are located on all four walls 6 in. (15 cm) above the smelt spout. The secondary ports at 18 in. (45 cm) above the spout are also located in all four walls but will be operated only on two opposite walls at a time. The tertiary port elevation is 11 ft (3.35 m) above the spout to reproduce the gas residence time between the secondary and tertiary port levels of a commercial unit. The tip of the nose is 18 ft (5.5 m) above the tertiary to maintain tertiary zone residence time.

Reproducing the commercial time-temperature profile in a small cross section requires a lower average gas velocity in order to maintain a practical furnace height. Due to the lower gas velocity in the RFS, black liquor drop size had to be reduced in order to simulate commercial drop fate. The standard splash plate nozzle used in recovery boilers will not work in the small cross section of the RFS, the wide spreading angle of the liquor spray would result in wet liquor impinging on the furnace walls. A BETE® MP nozzle was selected as the best candidate for RFS operation. This nozzle produces a full cone spray pattern and the desired drop size distribution to achieve in-flight drying without excessive carryover.

The height of the liquor spray gun above the floor should be set so that the majority of the drops will dry in flight. This results in a nozzle height of 3-10 ft (1-3 m) above the floor, depending on the final nozzle selection and the liquor solids concentration. To accommodate this wide variation, the liquor port will be a slot, approximately 7 ft (2 m) tall, with sectional, refractory lined, plug covers that can be moved to adjust firing elevation.

PILOT FURNACE SCALING

The elevations of primary and secondary air ports in commercial boilers are set according to guidelines established by past operating experience. In order to control the char bed in the RFS, the elevations of the primary and secondary ports were geometrically scaled from the reference unit by the square root of plan area. It is expected that this design will maintain a stable char bed up to the height of the secondary air ports. Accumulation of char on the furnace floor to this elevation should simulate commercial operation by providing residence time for the relatively slow char carbon gasification and sodium sulfate reduction reactions to occur.

The elevations of the tertiary air ports and furnace nose in the RFS were set to reproduce the time-temperature profile of a commercial boiler. Much of the heat release, aerosol formation, and emissions reactions occur in this region of a recovery boiler. It is therefore important to accurately reproduce the gas residence time and temperatures found in commercial units. Percent excess air and air distribution to each level of ports in the RFS were set equal to typical values of the reference commercial unit. A typical industrial liquor composition, solids content, and heating value were assumed to calculate the mass flows of gas above and below the tertiary air level. Assuming that gas residence times from secondary to tertiary air ports and from tertiary ports to the furnace nose are equal for pilot and commercial scale, then the vertical distance between these locations can be estimated as:

$$y_{RFS} = y_{com} \frac{(v_g)_{RFS}}{(v_g)_{com}} = y_{com} \frac{(\dot{m} \rho_g / A_p)_{RFS}}{(\dot{m} \rho_g / A_p)_{com}} \quad (1)$$

where y = vertical distance between secondary and tertiary air ports, or between tertiary and nose elevation, ft

v_g = mean gas velocity in each region, ft/s

\dot{m}_g = mass flow rate of gas in each region, lb/hr

ρ_g = gas density, lb/ft³

A_p = cross-sectional area (plan area) of furnace shaft, ft

Subscripts:

RFS - Recovery Furnace Simulator

com - Commercial unit

The gas densities in Eq. 1 were assumed equal; this requires that the bulk mean gas temperatures be equal for pilot and commercial scale. In practice, refractory thickness can be varied in the RFS to control heat absorption to the water walls to match average gas temperature at critical locations.

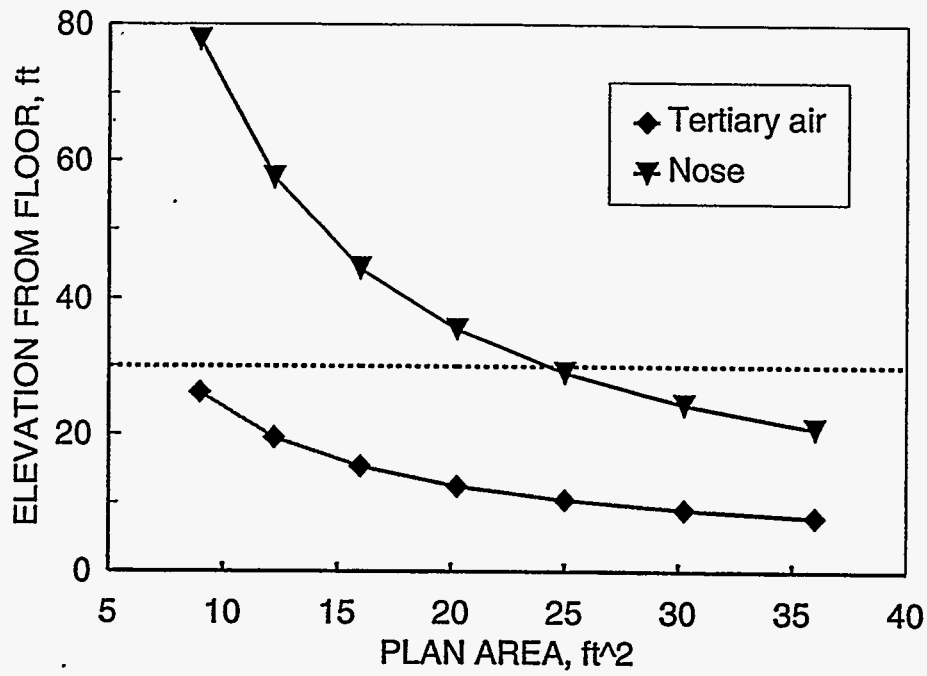

Figure 1. Tertiary air and furnace nose elevation as a function of RFS plan area.

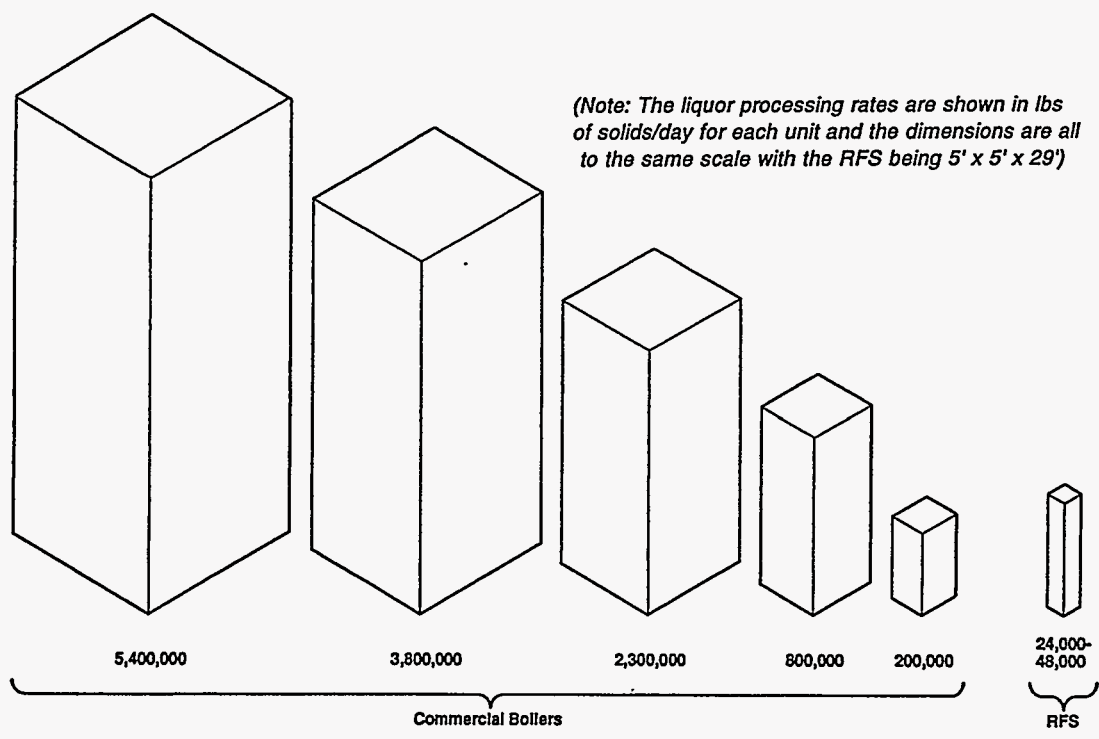

Figure 2. Relative size of RFS and a range of commercial recovery boilers.

Figure 1 shows furnace height as a function of RFS plan area. This result was calculated using the geometric scaling factor for secondary air port elevation and Eq. 1 for tertiary air port and nose elevations. A practical limit of approximately 30 ft (9 m) to the furnace nose (dotted line in Fig. 1) set the plan area at 25 ft². A larger plan area would result in a shorter furnace, which would be more practical for construction considerations. However, for plan area greater than 25 ft², the resulting gas velocity would be too low to adequately simulate commercial drop fate with available nozzles. It would also be difficult to maintain realistic combustion temperatures in a larger plan area without increasing heat input by auxiliary fuel firing.

The scale of the proposed RFS design is compared to a range of commercial recovery boilers in Fig. 2. The dimensions of the rectangular parallelepipeds represent the width, depth, and approximate height from the floor to the nose of the units. The approximate black liquor firing rate in pounds of solids per day is also given in Fig. 2.

The internal surface to volume ratio is plotted against plan area for the RFS and a range of commercial designs in Fig. 3. Clearly, wall effects in the RFS will be greater than in commercial units, but this condition is unavoidable for pilot equipment. Besides exceeding practical height limits with a plan area of less than 25 ft², an RFS of smaller width and depth will increase scaling uncertainties caused by wall effects.

Figure 4 compares furnace volume available for heat release as a function of plan

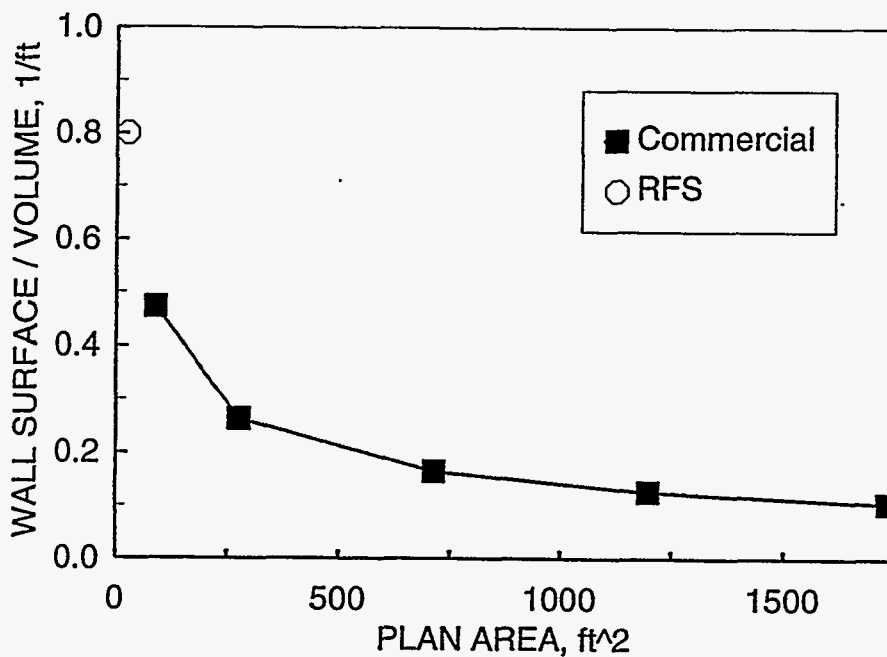

Figure 3. Wall surface area per furnace volume for RFS and a range of commercial units.

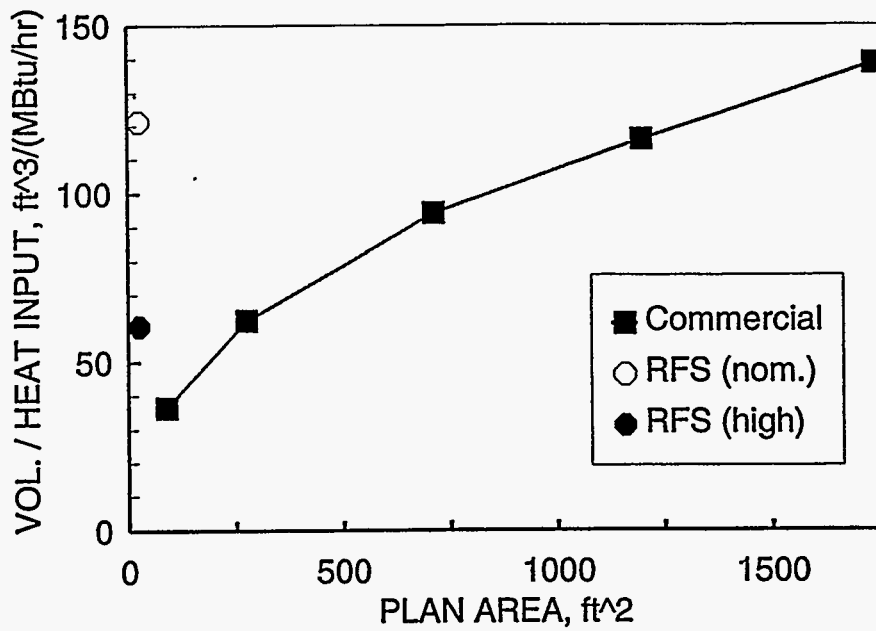

Figure 4. Furnace volume per net heat input for RFS and a range of commercial units.

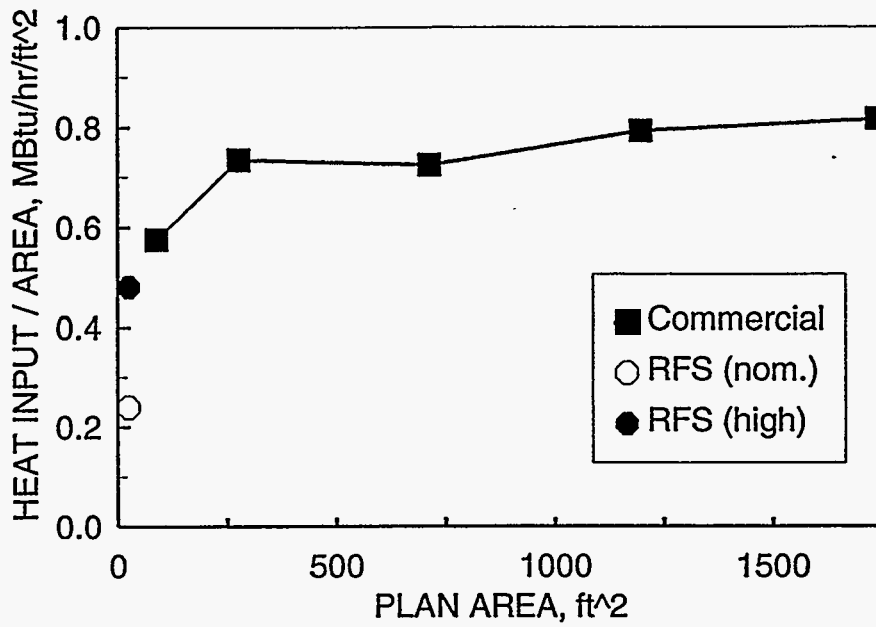

Figure 5. Heat input per plan area for RFS and a range of commercial units.

area; this parameter is an indication of gas time-temperature profile. As expected from its commercial design basis, the RFS at nominal load resembles large, commercial units in terms of volumetric heat release. At maximum firing rate, the furnace volume available for heat release is more like that of a small two-drum unit. The results in Fig. 4 suggest that, by varying firing rate, the RFS can reproduce the time-temperature profiles for a wide range of boiler sizes.

At high firing rate, RFS heat input per plan area approaches that of small commercial units (Fig. 5). This suggests that combustion will be self-sustaining at high firing rates. The refractory lining in the lower furnace will retard heat loss to insure that the char bed will stay hot enough to drive endothermic reactions and cause smelt to tap easily. According to modeling results, a suitable refractory lining will compensate for lower heat release per plan area at nominal load to maintain realistic combustion temperatures in the RFS. In practice some auxiliary fuel firing may be required to support combustion at nominal load. It is not an objective of RFS operation to maximize liquor processing capability; it was therefore deemed unnecessary to achieve a commercial level of 0.8 million Btu/hr heat input per square foot of plan area (Fig. 5). Moreover, matching the heat input per plan area of a large recovery boiler would result in impractical constraints on the design, such as locating the liquor gun above the tertiary air level.

AIR PORT SIZING

Primary air port size was estimated from standard design practice for small furnaces. For uniform air distribution, 20 ports were evenly spaced around the furnace perimeter. Relatively large openings were specified (3.068 in ID) to allow space for insertion of tubular sleeves in order to reduce port flow area if higher velocity air jets are needed to maintain char bed control.

Secondary and tertiary air ports were sized to reproduce air jet penetration typical of the reference boiler. The methodology of Ivanov [3] was followed, whereby the depth of air jet penetration is related to the jet's vertical deflection in the upward-flowing furnace gases:

$$\frac{X^3}{Y} = d_e^2 \left[\frac{v_a^2}{v_g^2} \frac{\rho_a}{\rho_g} \right]^{1.3} \quad (2)$$

where X = horizontal air jet penetration, ft
 Y = vertical air jet deflection, ft
 d_e = effective diameter of port, ft
 v_a = mean velocity of air jet, ft/s
 v_g = mean combustion gas velocity, ft/s
 ρ_a = density of air, lb/ft³
 ρ_g = density of combustion gas, lb/ft³.

An equation for RFS secondary air port size was derived from Eq. 2 by scaling Y with furnace height and X with furnace width (for secondary air ports located on opposite side

walls). Requiring similarity between pilot and commercial scale, and making the assumption of equal combustion gas density and air preheat temperature between the two units provides the following design equation:

$$A_{RFS} = A_{com} \frac{\left[\left(\frac{H}{W^3} \right)^{0.625} \left(\frac{\dot{m}_a}{\dot{m}_g} W D \right)^{1.625} \right]_{RFS}}{\left[\left(\frac{H}{W^3} \right)^{0.625} \left(\frac{\dot{m}_a}{\dot{m}_g} W D \right)^{1.625} \right]_{com}} \quad (3)$$

where A_i = area of air port opening, in²
 H = furnace height to nose, ft
 W = furnace width, ft
 D = furnace depth, ft
 \dot{m}_a = mass flow rate of air to each port, lb/hr
 \dot{m}_g = mass flow rate of combustion gas, lb/hr
 Subscripts:
 RFS - Recovery Furnace Simulator
 com - Commercial

For sizing the tertiary air ports, located on front and back walls of the furnace, depth instead of width was taken as the characteristic horizontal dimension in Eqs. 2 and 3.

The number and positioning of the air ports were specified according to commercial design practice in order to achieve bed control and minimize opposing air jet interference. Four secondary ports were located on each side wall, offset from each other so that the air jets will interlace. Seven ports were required at the tertiary level. Again, the four ports on the front wall and three on the rear wall were offset to minimize jet interference.

LIQUOR SPRAY ELEVATION AND NOZZLE SELECTION

A critical element in RFS design was the selection of a liquor nozzle to give reasonable gun height and spray pattern to achieve in-flight drying without excessive carryover. An iterative approach was required to identify a small, commercially available nozzle to satisfy the design objectives.

Black Liquor Spray Drop Size Distribution

Black liquor drop size distributions from a number of pressuring-atomizing nozzles have been shown to fit a square root normal distribution [4,5,6]:

$$F(x_j) = \frac{1}{s\sqrt{2\pi}} \int_{-\infty}^{x_j} \exp \left[-\frac{(x - \bar{x})^2}{2s^2} \right] dx \quad (4)$$

where $\bar{x} = (d_{mm})^{0.5}$; $x_j = (d_j)^{0.5}$
 $s =$ standard deviation
 $d_{mm} =$ mass median diameter.

Table I compares reported values of drop size distribution parameters from commercial spray nozzle tests. A range of operating conditions (liquor temperature, pressure, and flow rate) were investigated for each nozzle. The Malvern drop size analyzer (method A in Table I) can measure a lower minimum drop diameter than the image analysis techniques (methods B and C). Methods B and C omit the drops smaller than 0.5 mm, which tends to slightly increase the estimated median diameter and reduce the standard deviation, the net result is an artificially low normalized standard deviation [4]. Drop size distribution has been shown to be a strong function of minimum flow opening and fluid properties [5]. The normalized standard deviation (NSD) however, shows no systematic variation with these variables and is very nearly constant for a given type of nozzle.

The same mechanisms of spray break-up and drop formation apply to all pressure atomizing nozzles; it is therefore reasonable to assume that the normalized standard deviation for all pressure atomizing nozzles is the same [6]. In commercial boiler simulations, Wessel et al. [7] estimated an NSD of 0.263 from a subset of the reported data for splash plate nozzles [4]. For preliminary design and modeling of the RFS, an NSD of 0.263 was also assumed. According to the above analysis, this assumption should be valid as long as a pressure atomizing nozzle is selected.

Critical Drop Size for Entrainment

Entrainment occurs when the settling velocity of a drop is less than the mean upward gas velocity. Assuming the critical minimum drop size obeys the "intermediate law" of unhindered settling [8]:

$$u_t = \frac{0.153 g^{0.71} d_{crit}^{1.14} \rho^{0.71}}{\rho_g^{0.29} \mu_g^{0.43}} \quad (5)$$

where $u_t =$ settling velocity, ft/s
 $g =$ gravitational constant, 32 ft/s²
 $d_{crit} =$ critical minimum drop diameter, ft
 $\rho =$ density of black liquor drop, lb/ft³
 $\rho_g =$ density of combustion gas, lb/ft³
 $\mu_g =$ viscosity of gas, lb/sec.

Table I. Black liquor drop size distribution from commercial nozzles.

Nozzle ^a	Type ^b	Ref.	Exp. method ^c	No. obs. ^d	Orif., ^e mm	range d_{mm} , mm	range NSD ^f	av. NSD ^g
B&W 12/49	SP	[4]	A	17	9.5	1.41-2.37	0.232-0.322	0.296
B&W 12/35	SP	[4]	A	18	9.5	1.74-2.85	0.230-0.329	0.276
B&W 12/49	SP	[4]	B	2	9.5	2.80-2.99	0.248-0.284	0.266
B&W 16/57	SP	[4]	B	2	12.7	2.58-3.26	0.232-0.287	0.260
CE Sw-12	HC	[4]	B	6	9.5	1.74-3.06	0.187-0.247	0.216
B&W 12/45	SP	[5]	C	9	9.5	2.05-2.64	0.189-0.252	0.219
SS U-65200	FS	[5]	C	9	8.7	1.68-2.23	0.175-0.196	0.182
CE Sw-12	HC	[5]	C	26	9.5	1.07-2.70	0.162-0.232	0.187
B&W 12/45	SP	[6]	C	4	9.5	1.96-2.30	0.182-0.198	0.191
SS H-12	FC	[6]	C	4	10.7	1.52-2.39	0.170-0.188	0.181
CE Sw-10	HC	[6]	C	4	7.9	1.65-2.27	0.195-0.211	0.201
BT NC1520N	FC	[6]	C	4	14.3	1.81-2.58	0.180-0.199	0.192
BT ST24FCN	FC	[6]	C	4	9.5	1.39-2.00	0.171-0.209	0.193

^a Nozzle manufacturers: B&W=Babcock & Wilcox; CE=ABB/Combustion Engineering; SS=Spraying Systems; BT=BETE.

^b Nozzle types: SP=splash plate; HC=hollow cone; FS=flat spray; FC=full cone.

^c Experimental drop size measurement method: A) Malvern ST2600 drop size analyzer, lower cut off < 0.2 mm; B) X-ray shadowgraph and Trapix 55/512 image analyzer, lower cut off 0.5 mm; C) Xybio ISG-250 high speed videograph and Tracor Northern TN-8502 image analyzer, lower cut off 0.5 mm.

^d Number of reported data points.

^e Minimum flow opening.

^f Normalized standard deviation, $c_{NSD} = s(d_{mm})^{-0.5}$.

^g Average of reported values of NSD.

Given the mean gas velocity in the lower furnace, a minimum drop size for entrainment was calculated by substituting $u_t = v_g$ in Eq. 5.

An equation was derived from the square root-normal distribution function (Eq. 4) to calculate the median drop size associated with the critical minimum drop size:

$$d_{mm} = d_{crit}(1 + ct_{crit})^{-2} \quad (6)$$

where $t_{crit} = (x_{crit} - \bar{x})/s$ and $x_{crit} = (d_{crit})^{0.5}$.

Numerical modeling of commercial recovery boilers typically predicts that 1-2% of the fired liquor mass is entrained with the gases and exits the furnace boundary. A carryover probability of 2% was therefore assumed in the RFS design. The value of t_{crit} in Eq. 6 is related to the carryover probability by the normal distribution; for $F(t_{crit}) = 0.02$, $t_{crit} = -2.055$.

Preliminary Nozzle Selection

There are a number of spray nozzles which produce acceptable drop size and spray patterns which were evaluated for use in the RFS. Flat spray (VeeJet[®] or fan) and full cone (FullJet[®] or whirl) nozzles from two manufacturers were considered: Spraying Systems Co. of Wheaton, IL and BETE Fog Nozzle Inc. of Greenfield, MA. Flat spray nozzles are desirable because they have no internals which could clog when spraying a high viscosity, "dirty" fluid like black liquor. The mass distribution from flat spray nozzles is similar to that from a splash plate. Full cone nozzles offer the advantage of better coverage of the furnace volume, and there are designs which produce a square spray pattern. The primary disadvantages of full cone nozzles are narrow internal passages and high pressure drop. BETE however offers a Maximum Free Passage full cone nozzle which features a larger minimum flow opening than other full cone nozzles.

When firing high viscosity black liquor, the drop size will be greater and the spreading angle smaller than the values given by nozzle manufacturers for water sprays. The median drop size of a black liquor spray ($d_{mm,BL}$) from a given nozzle can be predicted from manufacturers' test data and black liquor properties [9]:

$$\frac{d_{mm,BL}}{d_{mm,w}} = \left(\frac{\sigma_{BL}}{73} \right)^{0.5} \left(\frac{\mu_{BL}}{1} \right)^{0.2} \left(\frac{\rho_{BL}}{62.4} \right)^{-0.3} \quad (7)$$

where:

- $d_{mm,w}$ = mass (or volume) median drop diameter from test data, mm
- $d_{mm,BL}$ = mass (or volume) median drop diameter for black liquor, mm
- σ_{BL} = surface tension of black liquor, dyne/cm
- μ_{BL} = apparent viscosity of black liquor, cP
- ρ_{BL} = density of black liquor, lb/ft³,

It was assumed that $\sigma_{BL} = 70$ dyne/cm, because the constantly-renewed surface during atomization maintains surface tension closer to that of water than the much lower equilibrium values that have been reported in the literature [10]. Black liquor viscosity and density were predicted from correlations based on mill liquor analysis. Over the range of solids content

(65-75%) and firing temperature (230-280°C) investigated in the preliminary design, these field-proven correlations are expected to be accurate.

Equation 7 was used to calculate an equivalent water drop diameter from the desired median black liquor drop size for the RFS. The nominal black liquor mass flow rate was converted to equivalent volumetric flow of water by Eqn. 8:

$$\dot{V}_w = \frac{\dot{m}_{BL}}{\sqrt{\rho_{BL} \rho_w}} \quad (8)$$

where

- \dot{V}_w = volumetric water flow, ft³/sec
- σ_{BL} = density of black liquor, lb/ft³
- σ_w = density of water, lb/ft³
- \dot{m}_{BL} = black liquor mass flow, lb/sec.

Given the equivalent median drop size and flow rate of water, several candidate nozzles were selected from the manufacturers' performance data. Spraying Systems provided drop size distributions for selected nozzles that has been compiled from years of experience (much of the test data was 20-25 years old). BETE appears to have more advanced characterization facilities, including image analyzers for drop size and a "Patternator" for mass distribution measurements.

The minimum flow opening of each candidate nozzle was used in the liquor gun height calculation, described below, to check that excessive gun height would not be required to achieve drying, and that good coverage of the lower furnace would be possible from the predicted elevation. Numerical modeling was then used to simulate the distribution of black liquor spray and the amount of carryover (gas-entrained particulate leaving the furnace). This procedure identified the BETE[®] MP nozzle as the best choice for RFS operation. This nozzle produces a heavy-edged, full cone spray pattern with a fairly uniform mass distribution in the center of the cone. The nozzle can produce the desired drop size with a larger minimum flow opening than other designs; the larger opening reduces initial spray velocity which allows the gun to be located lower in the furnace. Moreover, the larger openings reduce the likelihood of nozzle pluggage by suspended solids.

Due to the uncertainty of how well the selected nozzle will atomize highly viscous black liquor, the spray pattern and drop size distribution will be measured in our Atomization Test Facility prior to use in the RFS. The liquor mass distribution as a function of spray location for the BETE[®] MP nozzle will also be measured to validate the numerical modeling assumptions.

Liquor Spray Elevation

The drying time for a median-sized drop was estimated by a simple heat transfer model that assumes no swelling of the liquor and constant properties [10]:

$$t_d = \frac{(1 - S_0/S_f) \rho d_0 \Delta H_v}{6[\epsilon \sigma^0(T_g^4 - T_s^4) + h_c(T_g - T_s)]} \frac{1}{3600} \quad (9)$$

where t_d = elapsed drying time, s
 S_0 = initial solids content, %
 S_f = final solids content, %
 ρ = black liquor density, lb/ft³
 d_0 = initial median drop diameter, ft
 ΔH_v = enthalpy of vaporization of water, Btu/lb
 ϵ = particle surface emissivity
 σ^0 = Stefan-Boltzmann constant, 1.714×10^{-9} Btu/(h·ft²·°R⁴)
 T_g = gas temperature, °R
 T_s = drop surface temperature, °R
 h_c = convective heat transfer coefficient, Btu/(h·ft²·°R)

A heat transfer coefficient correlation accounting for both forced and natural convection was used to evaluate Eq. 9 [11]. Two limiting cases of drop velocity were considered in this calculation, the initial velocity of the black liquor sheet leaving the spray nozzle and the terminal velocity of the drop settling in a uniform up-flowing gas. The former condition requires an initial assumption of liquor gun firing angle to calculate the horizontal and vertical components of nozzle exit velocity; the correct gun angle was arrived at by iteration.

The vertical distance required for a median-sized drop to dry to $S_f = 85-90\%$ before reaching the char bed was taken as the product of vertical downward velocity and the drying time for each of the limiting cases. The gun height was assumed to lie between these the two estimates. The final solids content of the median-sized drop and the proportioning factor between the two estimates of drying distance were adjusted to reproduce the gun height of the reference commercial unit. These parameters were then fixed in the RFS design calculations to estimate gun elevation. The liquor gun firing angle was calculated to direct the center of the spray at the midpoint of the char bed (assumed to be at the secondary air port elevation). The gun height elevation calculation was repeated until the firing angle converged.

DESIGN EVALUATION BY NUMERICAL MODELING

A three-dimensional numerical model, PR-FURMO, was used to simulate combustion in the RFS and a commercial scale recovery boiler. The model was used to screen preliminary designs of the air and liquor delivery systems, for a pilot furnace of fixed size and shape. Modeling results confirmed that the optimal design of the RFS furnace is achieved with a three level air system and a BETE® MP full-cone spray nozzle.

Results of numerical simulations confirmed that the air system will provide sufficient air jet penetration without undue interference among jets. Excellent agreement of black liquor drop fate, gas temperature, and gas residence time predictions for the RFS and a commercial unit was demonstrated. Similarity in chemical and thermal environment, combined with gas residence time make the RFS well suited for experimental simulation the black liquor

combustion in a kraft recovery boiler.

LITERATURE CITATIONS

1. MARINGO, G.J., HATFIELD, P.E., FARZAN, H. and RODGERS, L.W., "Furnace Sorbent Injection for SO₂ Reduction in Cyclone Equipped Boilers," EPRI CS-5855, Project 2533-5, Final Report (June, 1988).
2. DANIEL, P.L., CHOU, S.F., RODGERS, L.W. and AYRES, Jr., S.P., "Fireside Corrosion in Low-NO_x Combustion Systems," EPRI GS-6339, Project 2154-3, Topical Report (April, 1989).
3. IVANOV, Y.V., "Effective Combustion of Overfire Fuel Gases in Furnaces," Estonian State Pub. House, Tallin, Estonia (1959).
4. SPIELBAUER, T.M., ADAMS, T.N., MONACELLI, J.E. and BAILEY, R.T., "Drop Size Distribution of Black Liquor Sprays," Proc. TAPPI/CPA Int. Chem. Recovery Conf., Ottawa, Ontario, p. 119-125 (1989).
5. EMPIE, H.J., LIEN, S.J., YANG, W. and ADAMS, T.N., "Spraying Characteristics of Commercial Black Liquor Nozzles," *Tappi* 78(1):121-128 (1995).
6. EMPIE, H.J., LIEN, S.J., YANG, W. and SAMUELS, D.B., "Kraft Black Liquor Delivery Systems," Report No. 4 to U.S. Dept. of Energy, Inst. of Paper Sci. and Tech., Atlanta, GA (1993).
7. WESSEL, R.A., PARKER, K.L. and AKAN-ETUK, A., "Three-Dimensional Flow and Combustion Model of a Kraft Recovery Furnace," Proc. TAPPI Eng. Conf., Orlando, FL (1993).
8. McCABE, W.L. and SMITH, J.C., Unit Operations of Chemical Engineering, 3rd. Ed., McGraw-Hill, New York, p..150-156 (1976).
9. FAIR, J.R., STEINMEYER, D.E., PENNY, W.R. and BRINK, J.A., "Liquid Gas Systems," in Chemical Engineer's Handbook, 5th Ed., R.H. Perry and C.H. Chilton, eds. section 18, pp. 58-67 (1973).
10. ADAMS, T.N. and FREDERICK, W.J., Kraft Recovery Boiler Physical and Chemical Processes, American Paper Institute, New York (1988).
11. FREDERICK, W.J., "Combustion Processes in Black Liquor Recovery: Analysis and Interpretation of Combustion Rate Data and an Engineering Design Model," Report No. 1 to U.S. Dept. of Energy DOE/CE/40637-T8 (DE90012712) (1990).

(THIS PAGE LEFT INTENTIONALLY BLANK)

APPENDIX C

**RFS NUMERICAL MODELING AND
COMPARISON WITH COMMERCIAL PERFORMANCE**

(THIS PAGE LEFT INTENTIONALLY BLANK)

TABLE OF CONTENTS

<u>Section</u>	<u>Page</u>
C.1 INTRODUCTION	C-1
C.1.1 Background	C-1
C.1.2 Objectives	C-1
C.1.3 RFS Unit Description	C-1
C.1.4 Commercial Unit Description	C-2
C.2 TECHNICAL APPROACH	C-5
C.2.1 Modeling Test Matrix	C-5
C.2.2 Conceptual Design Analysis	C-8
C.2.3 Comparison of RFS and Commercial Unit Performance	C-8
C.2.4 Model Setup and Results	C-8
C.3 CONCEPTUAL DESIGN ANALYSIS	C-9
C.3.1 Black Liquor Nozzle	C-10
C.3.2 Air System Design	C-11
C.3.3 Furnace Refractory	C-11
C.4 COMPARISON OF RFS AND COMMERCIAL UNIT PERFORMANCE	C-14
C.4.1 Gas Flow Field	C-14
C.4.2 Black Liquor Spray Distribution	C-14
C.4.3 Thermal and Chemical Environment	C-15
C.5 CONCLUSIONS	C-33
C.6 RECOMMENDATIONS	C-33
C.7 REFERENCE	C-34

LIST OF FIGURES

<u>Figure</u>	<u>Page</u>
C.1 Schematic of furnace geometry for RFS (case 3 air port configuration)	C-3
C.2 Schematic of furnace geometry for commercial boiler (case 2 air port configuration)	C-4
C.3 Comparison of RFS lower furnace flow patterns (cases 1, 2, 2r1)	C-12
C.4 Gas flow patterns in RFS lower furnace (case 3)	C-13
C.5 Gas flow patterns at center planes for RFS (case 3)	C-17
C.6 Gas flow patterns at center planes for commercial boiler (case 2)	C-18
C.7 Gas recirculation (percentage of downward flow) as a function of relative elevation to furnace nose	C-19
C.8 Representative liquor particle trajectories for RFS (case 3)	C-20
C.9 Representative liquor particle trajectories for commercial boiler (case 2)	C-21
C.10 Fate of black liquor versus normalized drop size for RFS (case 3)	C-22
C.11 Fate of black liquor versus normalized drop size for commercial boiler (case 2) . . .	C-23
C.12 Temperature distribution at center planes for RFS (case 3)	C-25
C.13 Temperature distribution at center planes for commercial boiler (case 2)	C-26
C.14 Average gas temperature as a function of relative elevation to furnace nose	C-27
C.15 Oxygen distribution at center planes for RFS (case 3)	C-28
C.16 Oxygen distribution at center planes for commercial boiler (case 2)	C-29
C.17 Temperature, oxygen and vertical velocity at several horizontal planes for RFS (case 3)	C-30
C.18 Temperature, oxygen and vertical velocity at several horizontal planes for commercial boiler (case 2)	C-31
C.19 Average residence time as a function of relative elevation to furnace nose	C-32

LIST OF TABLES

<u>Table</u>		<u>Page</u>
C.1	Modeling test matrix for RFS and commercial unit	C-5
C.2	RFS furnace operating conditions (case 3)	C-6
C.3	Commercial unit operating conditions (cases 1 and 2)	C-7
C.4	Comparison of black liquor drop fate for RFS (cases 1, 2 and 2r1)	C-10
C.5	Black liquor drop fate for RFS (case 3)	C-24
C.6	Black liquor drop fate for commercial unit (case 2)	C-24

(THIS PAGE LEFT INTENTIONALLY BLANK)

C.1 INTRODUCTION

C.1.1 Background

The goal of the High Solids Black Liquor Firing project is to develop technologies to improve high-solids black liquor firing in pulp mill recovery boilers. This goal will be met by constructing and operating a pilot-scale Recovery Furnace Simulator (RFS) in which these technologies can be tested. The project is divided into four phases: RFS Concept Design, Simulator Development, Advanced Combustor Development and Advanced Combustor Verification. Numerical modeling was used in Phase I to support the design of the RFS facility and will be used in subsequent phases to scale results to commercial units.

Since the mid-1970's, the Babcock and Wilcox Company has invested considerable resources in the development of numerical methods for the design and evaluation of boiler systems. A family of general-purpose computer programs have been developed for three-dimensional flow, heat transfer, and combustion in boilers. These numerical models are based on engineering physics and can be applied to laboratory, pilot, and full-scale equipment. Numerous applications have been performed which allowed comparison between model predictions, limited field data, and B&W experience. In addition, scaled physical flow models have been tested with three-dimensional velocity measurements to provide data to verify flow predictions.

A Process Recovery FURNace MOdel, PR-FURMO, is used to simulate black liquor combustion in kraft recovery boilers (Wessel, Parker, and Akan-Etuk, 1993). The model is based on a fundamental mathematical description of various interacting processes which occur during combustion: turbulent flow, droplet dispersion, gas and solid phase chemical reaction, and heat transfer. B&W's PR-FURMO computer program provides the most comprehensive model that is currently available for such analysis.

C.1.2 Objectives

The objectives of Task 1.5 of the DOE High Solids Black Liquor Firing project were to:

- o use PR-FURMO to screen preliminary designs of the Recovery Furnace Simulator.
- o demonstrate the scaling capability of the RFS facility prior to commitment of capital funds

C.1.3 RFS Description

The schematic of the Recovery Furnace Simulator (RFS) is shown in Figure C.1. The furnace is a refractory-lined, water-cooled chamber with a 2.32 m² (25 ft²) plan area, that is designed to fire black liquor at the rate of 11 metric tons of dry solids per day. It is equipped with a three level air system similar to B&W commercial units. The primary air ports are located on all four walls. The secondary air ports are located on all four walls, but only the ports on two opposing walls will be in operation at a given time. The tertiary ports are located on front and

rear walls. Secondary and tertiary air ports are interlaced to insure adequate penetration of jets and good mixing between the air and combustion gases. The height of the tertiary air ports and furnace nose were designed to reproduce the gas residence time found in a typical commercial unit. A single liquor port is located on the front wall. The liquor nozzle is designed to produce a spray pattern with adequate in-flight drying and without excessive carryover. Since it is not practical to use splash plate nozzles to achieve the small drop sizes (~1.0mm) required in the RFS, other commercially available nozzles (VeeJet and Bete nozzles) were considered. Refractory lining is used in the furnace to reduce heat loss to ensure that the char bed is hot enough to drive endothermic reactions in the char bed and maintain gas temperatures similar to commercial scale.

C.1.4 Commercial Unit Description

A large single-drum recovery boiler shown in Figure C.2 was used as the basis of the RFS design. The furnace fires black liquor at a rate of 1700 metric tons (3.8 million pounds) of dry solids per day. Combustion air is introduced through three levels of air ports. The primary level consists of 126 ports distributed uniformly around the base of the furnace. The secondary level consists of 17 air ports and 8 burners in a staggered arrangement on all four walls, with the majority of the air admitted through the side wall ports. The tertiary air level consists of seven air ports on the front and rear walls. Black liquor is introduced through a combination of 8 liquor ports, three ports on each side wall and one port on front and rear walls. The furnace walls are constructed of membrane tubes, cooled with natural circulation of high pressure boiling water.

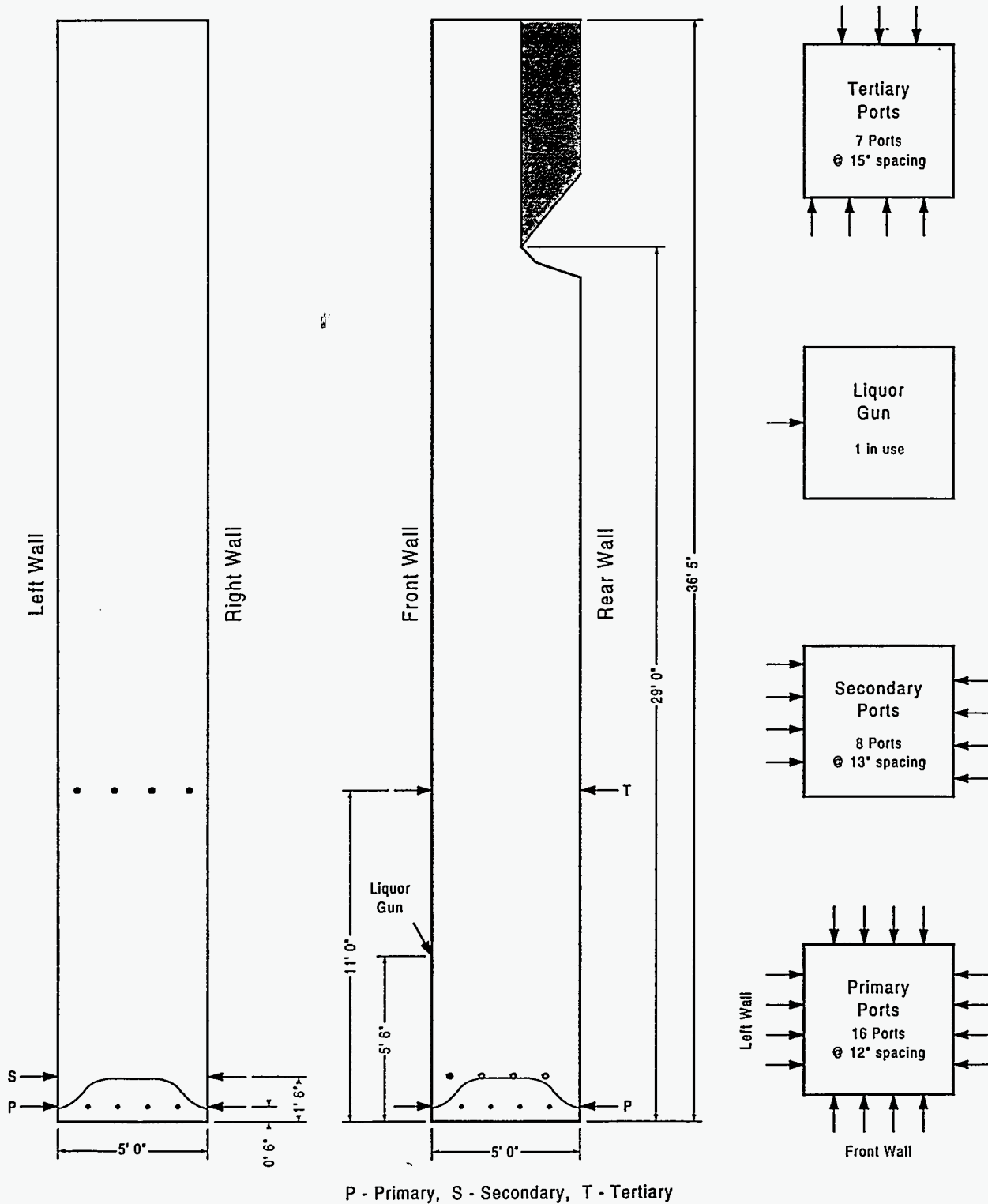

Figure C.1 Schematic of furnace geometry for RFS (case 3 air port configuration).

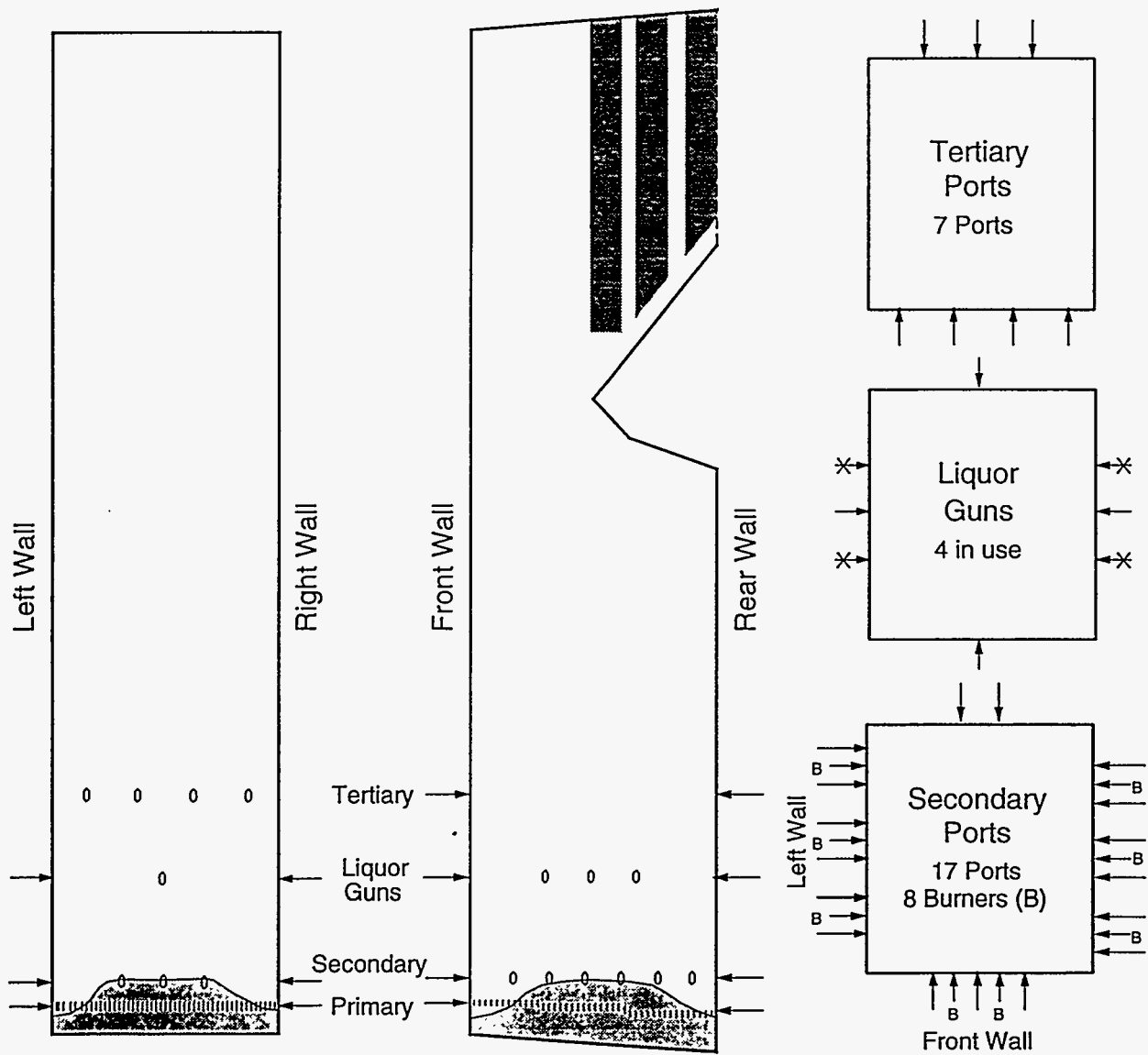

Figure C.2 Schematic of furnace geometry for commercial boiler (case 2 air port configuration).

C.2 TECHNICAL APPROACH

C.2.1 Modeling Test Matrix

The cases that were modeled for the RFS and reference commercial unit are summarized in Table C.1. Both suspension drying and wall drying modes of operation were considered for the RFS design. With suspension drying, black liquor is directed toward the center of the furnace to maximize the time the drops are suspended in the gas flow during drying and devolatilization. With wall drying, black liquor is intentionally sprayed on the furnace walls where it completes drying, then sloughs from the walls to the char bed where devolatilization and char burning are completed.

The furnace operating conditions of the RFS (case 3) and reference commercial unit (cases 1 and 2) are given in Tables C.2 and C.3 respectively. These cases will be discussed in more detail in Section C.4. The RFS fires black liquor at the rate of 11.6 metric tons (0.0255 million pounds) of dry solids per day as compared to that of the commercial unit which fires black liquor at a rate of 1700 metric tons (3.8 million pounds) of dry solids per day. The air distribution to the three level air system is similar to that of the commercial unit. Air and liquor inlet temperatures are also similar. Median drop size of the black liquor spray is 1.0 mm for the RFS as compared to 2.5 to 3.0 mm for the commercial unit. The differences in drop size are offset by roughly a factor of 3 increase in average vertical gas velocity from pilot to commercial scale. The modeling results for case 1 of the commercial unit were described elsewhere (Wessel et al., 1993). The results of case 2 are presented in Section C.4 for comparison with the RFS, because the operating conditions are more similar to the nominal values chosen for RFS design.

Table C.1 Modeling Test Matrix for RFS and Commercial Unit

Case	Air Distribution (Pri/Sec/Ter) (%)	Firing Rate (Mlb/day)	Number of Nozzles	Nozzle Type	Nozzle Diameter (mm)	Median Drop Diameter (mm)	Firing Mode
RFS-1	32/49/19	0.0255	1	VeeJet	2.8	1.26	Suspension
RFS-2	40/30/30	0.0255	1	VeeJet	2.2	0.72	Suspension
RFS-2r1	40/30/30	0.0255	1	VeeJet	2.4	1.06	Suspension
RFS-3	40/30/30	0.0255	1	Bete	4.0	1.00	Suspension
RFS-4	40/30/30	0.0255	1	Splash Plate	2.8	1.32	Wall Drying
Comm-1	32/49/19	3.91	6	Splash Plate	23.8	3.00	Suspension
Comm-2	42/32/26	3.51	4	Splash Plate	20.6	2.75	Suspension
Comm-3	40/30/30	3.65	4	Splash Plate	22.2	2.58	Wall Drying

Table C.2 RFS Furnace Operating Conditions (Case 3)

Flow Rates

Air	0.553 kg/s (1.219 lb/s)
Liquor	0.191 kg/s (0.421 lb/s)
Solids	70.0 %

Air Distribution & Temperature

Primary	40.0 %	154°C (310°F)
Secondary	30.0 %	154°C (310°F)
Tertiary	30.0 %	43°C (110°F)

Black Liquor Solids

Volatile Matter	24.8 %
Fixed Carbon	20.9 %
Inorganic	54.3 %
Heating Value	13157 kJ/kg (5657 Btu/lb)

Stationary Liquor Gun

Nozzle type	Bete MP
Nozzle diameter	0.396 cm (5/32 inch)
Tilt angle	60° down
Nozzle conditions	114.6°C, 127 kPa gauge (238.3°F, 18.4 psig)

Table C.3 Commercial Unit Operating Conditions (Cases 1 and 2)

	Case 1	Case 2
<i>Flow Rates</i>		
Air	28.7 kg/s (63.2 lb/s)	26.2 kg/s (57.8 lb/s)
Liquor	86.3 kg/s (190 lb/s)	81.9 kg/s (181 lb/s)
Solids	71.6 %	70.2 %
<i>Air Distribution & Temperature</i>		
Primary	32% 164°C (328°F)	42% 161°C (321°F)
Secondary	49% 159°C (318°F)	32% 172°C (342°F)
Tertiary	19% 62°C (144°F)	26% 66°C (150°F)
<i>Black Liquor Solids</i>		
Volatile Matter	24.9 %	22.3 %
Fixed Carbon	20.8 %	18.6 %
Inorganic	54.3 %	59.1 %
Heating Value	13153 kJ/kg (5655 Btu/lb)	12,430 kJ/kg (5344 Btu/lb)
<i>Stationary Liquor Guns</i>		
Guns in Operation	6 (3 right, 3 left)	4 (one on each wall)
Nozzle type	35° B&W Splash Plates	49° B&W Splash Plates
Nozzle diameter	2.38 cm (15/16 inch)	2.06 cm (13/16 inch)
Barrel angle	5° down	10° down
Nozzle conditions	131°C, 106.2 kPa gauge (267°F, 15.4 psig)	113°C, 185.4 kPa gauge (235°F, 26.9 psig)

C.2.2 Conceptual Design Analysis

The PR-FURMO model was used to screen preliminary designs of the air and liquor delivery systems, for the RFS furnace of fixed size and shape. The modeling objectives for the conceptual design analysis were:

- o Use flow predictions to verify design calculations and evaluate air system performance based on air jet penetration, mixing effectiveness, and upward flow uniformity.
- o Optimize the distribution of black liquor spray to achieve adequate suspension drying and produce a level of carryover (gas entrained particulate leaving the furnace) that is typical of a commercial unit. Minimize the effects of scaling such as gas entrainment by the black liquor spray and excessive wall deposition that is not typical of commercial units.
- o Determine the refractory type and thickness necessary to achieve the desired gas temperature distribution in the RFS furnace.

C.2.3 Comparison of RFS and Commercial Unit Performance

Modeling results for the RFS were compared to commercial unit performance to verify that the thermal and chemical conditions in the furnaces are similar. The ability to achieve similar furnace conditions will increase our confidence in the RFS design and the capability for scaling RFS experimental results to commercial unit performance. The following criteria were used as the basis of comparison:

- o Gas residence time and furnace temperature profile
- o Air jet penetration and mixing performance
- o Black liquor distribution

The black liquor distribution is the amount of black liquor burned in flight, deposited on the walls and char bed and the amount entrained in the gas flow and carried to the convection pass.

C.2.4 Model Setup and Results

The furnace design and operating conditions for the RFS and a commercial scale recovery boiler were used to set up the numerical model. The furnace enclosure was subdivided into control volumes and blockages were used to approximate the shape of the enclosure walls, char bed and furnace nose. In these applications, approximately 50,000 control volumes were used, with smaller control volumes in the lower furnace to resolve individual air jets. Much greater detail was not practical with current limitations in computer resources.

Air flow was introduced into the model by specifying the mass flow rate, velocity and temperature at each inlet to the furnace. In the commercial unit, the primary air ports were

represented as a slot with distributed mass flow and velocity boundary conditions to match actual port spacing, size and operation. The primary air ports of the RFS, and secondary and tertiary air ports were represented individually in the model at control volume faces corresponding to the location of each port. The control volume faces were larger than the actual port area due to practical limitations in the spacial resolution of the model. Inlet boundary conditions were prescribed by introducing permeabilities at control volume faces to match actual port area, mass flow rate and momentum at each inlet.

Black liquor is introduced into the furnace as a spray leaving each black liquor nozzle. Black liquor properties (elemental analysis, physical properties, swelling characteristics) operating parameters (temperature, pressure and flow rate) and firing arrangement (gun position, orientation and nozzle design) were provided as input to the model. The initial drop velocity distribution from the nozzles in the commercial unit were calculated from mass and momentum balances for the black liquor sheet leaving a splash plate. The velocity distribution from the VeeJet and Bete nozzles used in the RFS were estimated from supplier information. The mass flow distribution and the square root normal distribution of drop size were calculated based on correlations of experimental results. The continuous distribution of drop size and velocity for each liquor gun were approximated by several discrete size groups leaving the splash plate at several discrete angles, with several streams per angle and size group.

In the commercial unit, membrane walls were modeled with thermal boundary conditions to represent conduction heat transfer through a thin deposit layer and metallic tube wall. Flow resistance was used to simulate pressure drop across tube banks. Heat transfer was simulated with radiation and convection to the tubes and conduction through deposits and tube metal to the steam/water inside the tubes. Similar conditions were imposed on the walls of the RFS representing conduction heat transfer through the refractory lined, water-cooled walls.

Numerical results are achieved using a high-speed computer workstation which takes approximately a week to solve the three-dimensional distribution of flow, temperature and chemical species in the furnace. The model produces a variety of three-dimensional output. Selected results are presented for comparison of the RFS and commercial unit:

C.3 CONCEPTUAL DESIGN ANALYSIS

The model was used to screen preliminary designs of the air and liquor delivery systems, for a furnace of fixed size and shape. This section summarizes the numerical modeling results used for the conceptual design of the RFS. The model was used to verify design calculations and optimized the design of the black liquor nozzle, air system and furnace refractory. Based on these results, the optimal design of the RFS furnace is achieved with the three level air system and a full-cone spray nozzle simulated in case 3. The modeling results for case 3 are described in more detail and compared with commercial unit performance in Section C.4.

C.3.1 Black Liquor Nozzle

The performance of the black liquor nozzle was evaluated to determine the distribution of black liquor spray and the amount of carryover (gas entrained particulate leaving the furnace). The objective was to achieve a design that resulted in the same distribution of black liquor as that of a commercial unit. Modeling results show that the black liquor spray distribution in the RFS is sensitive to nozzle design and operating parameters. Several nozzle designs were evaluated before an acceptable configuration was achieved.

Table C.4 compares the fate of the black liquor drops for different liquor nozzles in the RFS with similar predictions for suspension drying in a commercial unit. The drop fate is defined as the amount of black liquor mass that is evolved during combustion in suspension (in-flight), on the walls and char bed, and the amount that reaches the exit of the furnace at the superheater inlet. The RFS design variables having the largest effect on drop fate are gun elevation, mass median diameter, injection angle and spray pattern. For case 1 the nozzle was aimed at the intersection of the bed and the rear wall. Compared to the commercial unit, too much of the spray impacted the furnace walls and not enough reached the furnace exit. For case 2, the nozzle was lowered and aimed at the center of the bed. This improved agreement with the in-flight evolution, but the other components differed significantly from the commercial unit. For case 2r1, the nozzle was raised and the droplet diameter increased; however, agreement with the commercial unit was only slightly improved. For case 3, a Bete nozzle was substituted for the VeeJet which improved the spray pattern and required a lower injection velocity to achieve the same droplet diameter. The lower injection velocity entrains less flue-gas in the spray and allows the nozzle to be located closer to the bed. This combination greatly improved agreement with the commercial unit and was selected as the RFS reference design.

Table C.4 Comparison of Black Liquor Drop Fate for RFS (Cases 1, 2 and 2r1)

	Gun Elevation (ft)	Med. Drop Diameter (mm)	<i>In-Flight</i>	<i>Walls</i>	<i>Bed</i>	<i>Exit</i>
RFS-1	8.5	1.26	26.8	41.2	31.9	0.1
RFS-2	6.5	0.72	31.6	7.1	61.1	0.2
RFS-2r1	10.0	1.06	30.6	12.5	56.6	0.3
RFS-3	5.5	1.00	34.7	25.7	38.9	0.7
Comm-1	24.5	3.00	35.0	35.7	28.0	1.3
Comm-2	24.5	2.75	35.4	18.4	44.3	1.9

The RFS requires high injection velocities to obtain the small drop sizes needed to simulate drop fate in a commercial unit. As a result, the spray entrains a significant amount of flue gas affecting the flow pattern in the lower furnace. This effect is illustrated by Figure C.3, which compares velocity vectors in the lower furnace for cases 1, 2 and 2r1 in a vertical plane at the furnace centerline and parallel to the side walls. The Bete flow nozzle specified for case 3 requires a smaller injection velocity, reducing the effect on lower furnace flow distribution as shown in Figure C.4.

A fourth case was conducted for the RFS to simulate wall drying operation of the furnace. An unique type of splash plate nozzle was used to direct most of the spray to the two side walls. However, insufficient drying was achieved before the wet liquor was deposited on the furnace walls. The resulting flow patterns and flue gas temperature distributions were strongly biased toward the front wall and extremely non uniform. Thus modeling the RFS with wall drying was unsuccessful in achieving performance that is similar to a commercial unit. Additional variations in nozzle design and operation should be considered to improve wall drying performance, such as a hollow cone or wider angle full cone Bete nozzle.

C.3.2 Air System Design

Flow predictions were used to verify design calculations and evaluate air system performance based on air jet penetration, mixing effectiveness, and upward flow uniformity. Optimal flow conditions were not difficult to achieve with the slender shape of the RFS furnace. The velocity vectors in horizontal planes at the elevation of the secondary and tertiary air ports are shown in Figure C.4. The penetration of the air jets is more than adequate to achieve good mixing of the tertiary air with the combustion products evolved in the lower furnace.

C.3.3 Furnace Refractory

Furnace heat transfer predictions were used to determine the refractory type and thickness necessary to achieve the desired gas temperature distribution and exit gas temperature from the RFS furnace. The surface to volume ratio of the RFS is significantly greater than the commercial unit. The heat flux to the furnace walls must be reduced to match the RFS and commercial unit flue gas temperature profile over the height of the furnace. Refractory insulation is applied to the flue gas side of the RFS furnace walls to reduce the heat absorption. A uniform insulation conductance of 2.2 BTU/hr-ft²-F was assumed for this design study and was sufficient to maintain the desired furnace exit gas temperature of 1750°F (954°C) at nominal load conditions. A 4-inch thick kaolin based insulation would provide the required heat flux reduction.

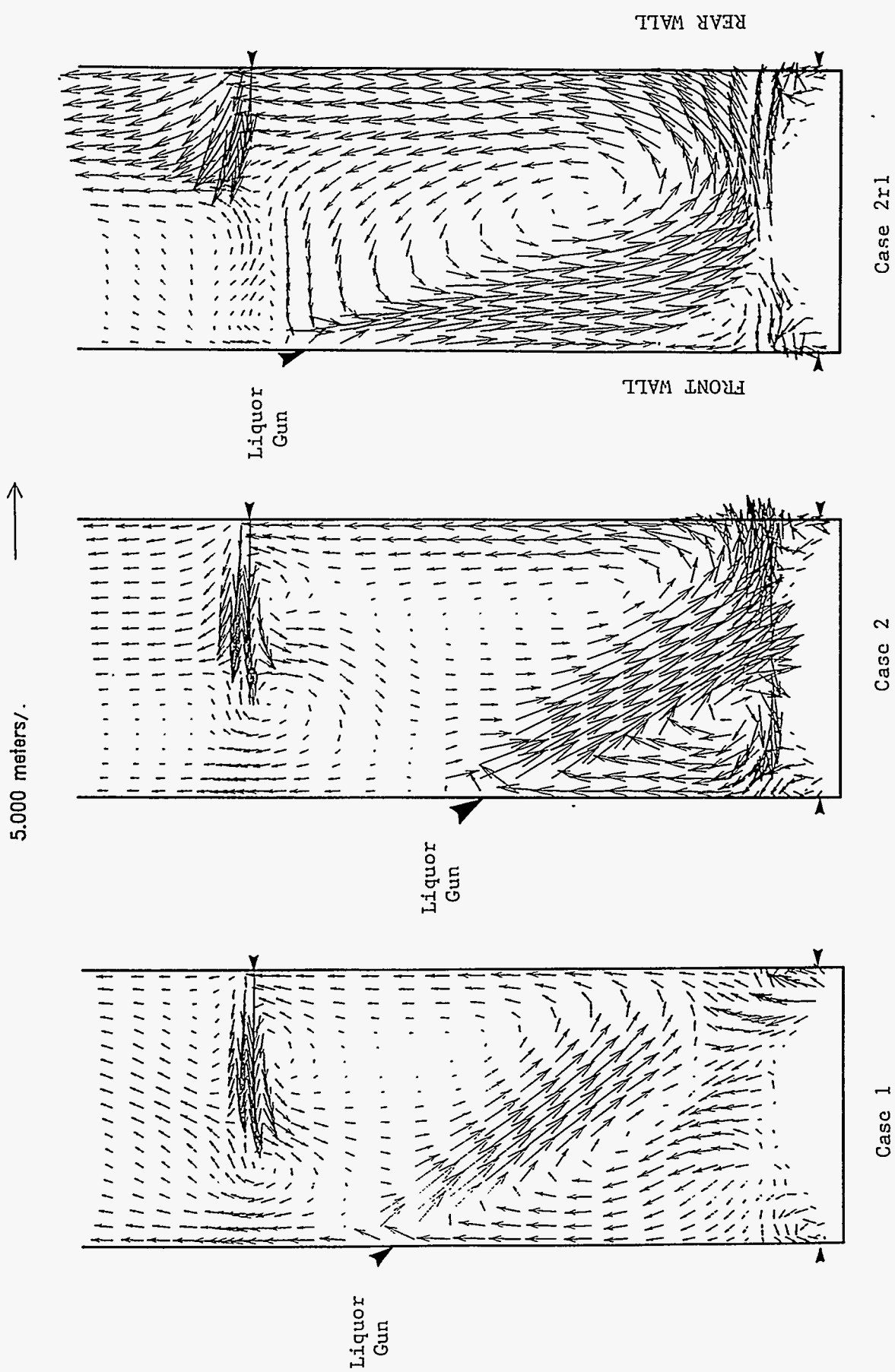

Figure C.3 Comparison of RFS lower furnace flow patterns (cases 1, 2, 2r1).

5.000 meters/sec equals

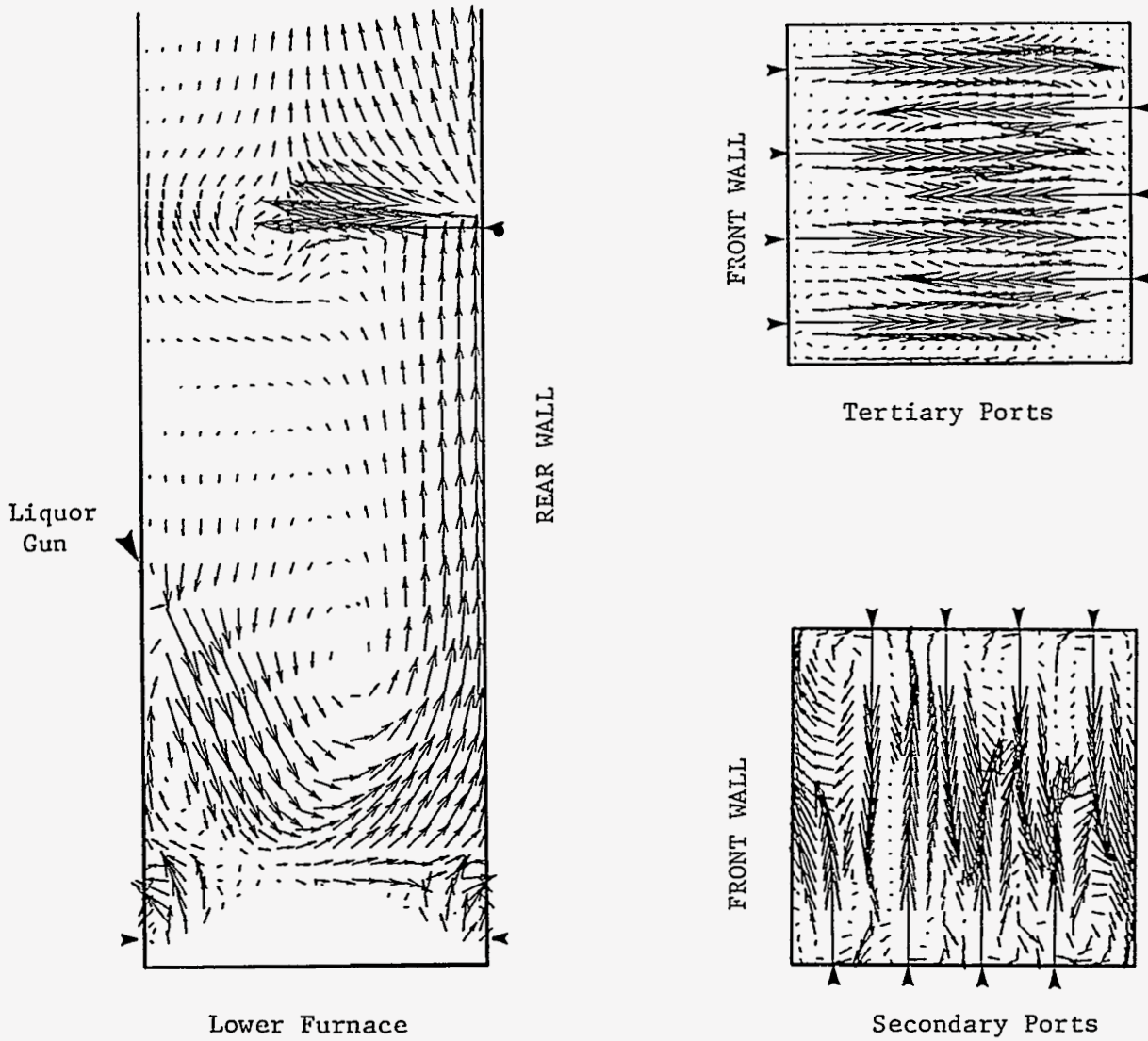
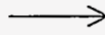

Figure C.4 Gas flow patterns in RFS lower furnace (case 3).

C.4 COMPARISON OF RFS AND COMMERCIAL PERFORMANCE

Model predictions for the RFS were compared to that of a commercial unit to verify that the thermal and chemical conditions in the furnaces are similar. The following sections discuss the gas flow field, black liquor distribution, and thermal and chemical environment in the two units.

C.4.1 Gas Flow Field

The gas flow field at vertical planes at the center of each furnace are shown in Figures C.5 and C.6. The arrows outside the furnace denote the elevation of primary, secondary and tertiary air ports and black liquor guns. In the commercial unit, several jets of air are shown entering the furnace at the primary, secondary and tertiary air levels. Primary and secondary air jets are not shown for the RFS because the crosssections of the furnace shown in Figure C.5 do not cut through any of the primary or secondary ports. In both units, the tertiary air jet on the rear wall penetrates approximately halfway into the furnace and interlaces with other jets on the opposite wall.

The most significant difference between pilot and commercial scale flow patterns occurs near the black liquor guns as shown in Figures C.5 and C.6. In the commercial unit, the gas flow is relatively unaffected by the black liquor spray; the gas flow is generally countercurrent with the particles which settle to the bottom of the furnace. However in the lower furnace of the RFS, the black liquor spray has a significant influence on the gas flow distribution. The spray entrains the gas, creating downward flow near the front wall and upward flow near the rear wall. There is two reasons for this behavior: 1) the momentum ratio between the spray and the gas is higher in the RFS, and 2) the exchange in momentum between particles and gas occurs more rapidly for the smaller drop size. Gas entrainment by the black liquor spray was minimized with the use of the Bete nozzle, but cannot be eliminated.

The fraction of downward, recirculating gas flow is shown in Figure C.7 for the RFS and commercial unit at two operating conditions. Furnace elevation is normalized in this figure with 0.0 representing the elevation of the primary air ports and 1.0 representing the tip of the bullnose. Gas recirculation in the lower furnace can vary considerably as exhibited by the two operating conditions for the commercial unit. A greater amount of downward flow is present in the lower furnace of the RFS due to gas entrainment by the black liquor spray. However the location of the recirculation zone is similar to that of commercial scale. In the upper furnace, the upward flow is less uniform in the RFS, and some recirculation exists along the front wall. An adjustment to the tertiary air flow velocity could be made to correct this flow maldistribution, however it was not simulated in the model.

C.4.2 Black Liquor Spray Distribution

The particle combustion model calculates several thousand particle trajectories to represent the black liquor spray as it burns in-flight. Representative trajectories are shown in

Figures C.8 and C.9 for different size particles simulated in the model. Particle trajectories begin at the tip of the black liquor nozzle at each liquor port. Particle trajectories are terminated when the particles strike the walls or surface of the char bed where they are assumed to stick, and burning is completed. The largest particles are largely unaffected by the gas flow and either strike the walls or fall to the char bed. The particle diameter decreases moving from left to right through the figures. The smallest particles are substantially influenced by the gas flow field, with many leaving the furnace exit. The behavior of particle trajectories is similar between the RFS and commercial unit for particles with similar normalized diameter.

Figures C.10 and C.11 summarizes where the black liquor constituents are evolved as a function of normalized (initial) drop diameter. The four graphs represent the fate of the liquor constituents: water, volatiles, char and inorganic. The "in-flight" region represents the fraction that is evolved from the particle while in suspension in the gas. The "walls" region represents the fraction that is deposited on the furnace walls. The "bed" region represents the fraction that is deposited on the surface of the char bed. The "exit" region represents the fraction that is carried out of the furnace exit. Most particles lose all of their water while they are still in flight. Char and inorganic material with normalized diameters less than about 0.7 are the only particles that exit the furnace. The maximum normalized diameter for entrainment is about 1.5. For normalized diameters above 1.5, the fraction of volatiles, char and inorganic hitting the bed and walls remains constant. These results demonstrate that the black liquor distribution in the RFS and commercial unit are similar despite the factor of 3 difference in mean drop size.

Tables C.5 and C.6 are summaries of the total liquor drop fate for the RFS and commercial unit, which is inclusive of all particle sizes. The columns represent where particle mass is evolved or deposited, while the rows represent the constituents of the black liquor: water, volatiles, char, and inorganics. Taking water as an example, over 90% is evolved in-flight, a small percentage is deposited on the walls and bed and nothing leaves the furnace exit. Volatiles that are not evolved in-flight, are evolved from deposits on furnace walls and the char bed. Most of the char and inorganic material is deposited on the bed or the furnace walls, where the char continues to burn. Based on these results, the amount of suspension drying and burning of black liquor spray, and the amount of burning that occurs on the char bed of a commercial unit is experimentally simulated in the RFS. The amount of carryover is 0.7% of the total black liquor for the RFS as compared to 1.9% in the commercial unit. Carryover is lower in the RFS due to the narrower range of particle size produced by the smaller black liquor nozzle.

C.4.3 Thermal and Chemical Environment

The temperature distribution in the RFS and commercial unit are compared in Figures C.12 and C.13. Gas temperature is highest near the char bed and decreases as upward flowing gases lose heat by radiation to the furnace walls. The introduction of air to the furnace causes lower temperatures near these inlets. In the RFS, water evaporation from the black liquor reduces gas temperature in the vicinity of the spray. The effects of water evaporation are less evident for the commercial scale boiler because particle flow is generally

counter current with the gas flow. The profile of planar-averaged gas temperature is shown in Figure C.14 for the RFS and the commercial unit at two operating conditions. Gas temperatures in the lower furnace can vary considerably as exhibited by the two operating conditions for the commercial unit. In case 1 the commercial unit is hotter near the liquor gun elevation because there is more black liquor burning in suspension than on the char bed. In case 2, there is more combustion on the char bed and less suspension burning. Gas temperatures in the RFS fall within the range of conditions predicted for commercial scale.

The oxygen distribution in the RFS and commercial unit are compared in Figures C.15 and C.16. The highest oxygen concentrations exist where primary, secondary and tertiary air jets enter the furnace. In the lower furnace, black liquor burns with the primary and secondary air, creating reducing conditions with low oxygen concentrations (< 1%). Tertiary air penetrates and mixes with lower furnace gases to achieve oxidizing conditions in the upper furnace. Mixing is completed in the upper furnace and any remaining combustible gases are oxidized before the flow exits the furnace. The gas exits the furnace with 1.5 to 2% excess O₂. Based on predicted oxygen distributions, the chemical environment in the lower and upper furnace of the RFS is similar to that of commercial scale.

The three dimensional distributions of temperature, oxygen and vertical velocity are shown in Figure C.17 for the RFS and Figure C.18 for the commercial unit. The jets of air at the secondary and tertiary air levels are visible as narrow regions of low temperature gas with high oxygen concentration. A region of downward flowing, cooler gas exists below the liquor gun in the RFS due to gas entrainment by the black liquor spray. High temperature, reducing conditions are characteristic of the lower furnace in both units; and oxidizing conditions are achieved in the upper furnace above the tertiary air level. Regions of higher temperature generally correspond to regions of higher upward velocity. It is expected that minor flow imbalances in the upper furnace of the RFS can be corrected by air system adjustments.

The gas residence time profile shown is shown in Figure C.19 for the RFS and the commercial unit at two operating conditions. The gas residence time from the primary air ports (0.0) to the bullnose (1.0) is approximately 8.2 seconds for pilot and commercial scale. The residence time between air levels is also well represented in the RFS design, due to the similarity in the residence time profile. Similarity in chemical and thermal environment, combined with gas residence time make the RFS well suited for experimental simulation the black liquor combustion in a kraft recovery boiler.

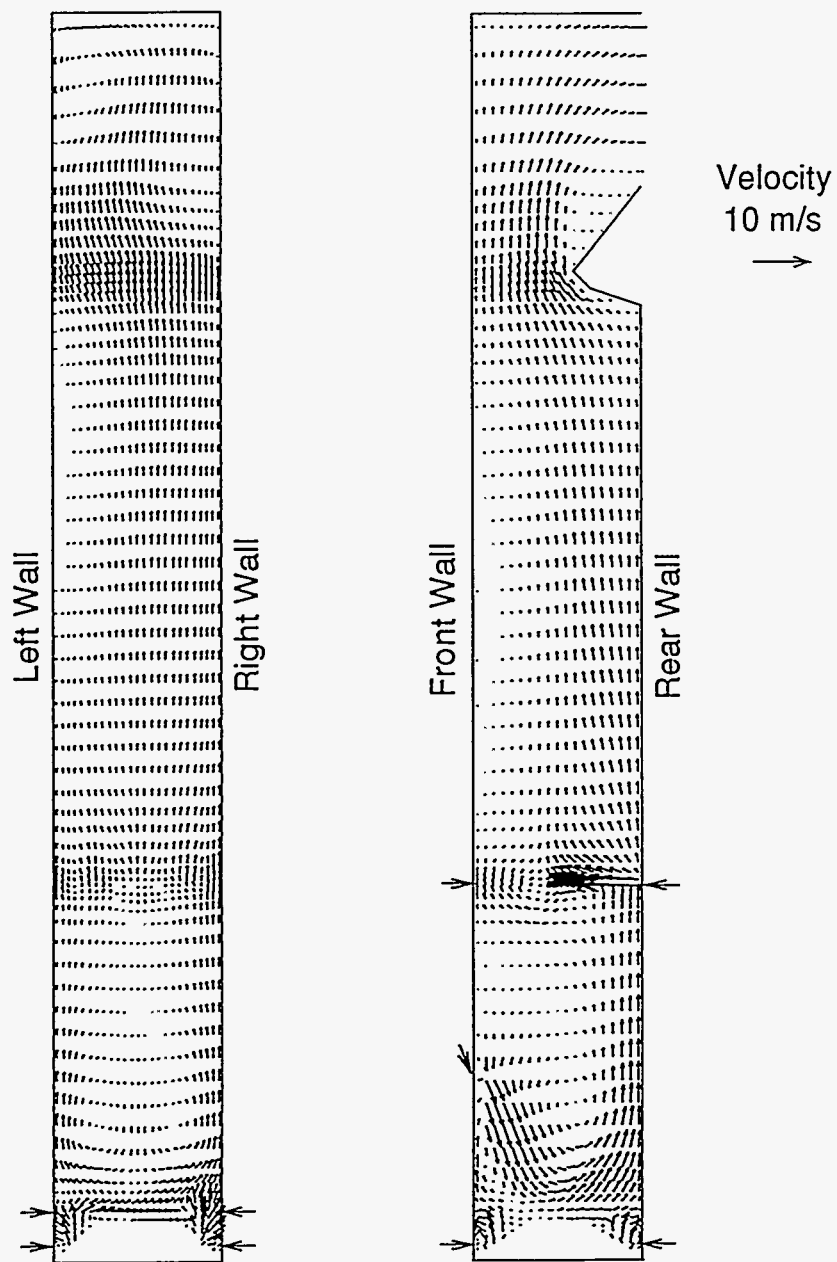

Figure C.5 Gas flow patterns at center planes for RFS (case 3).

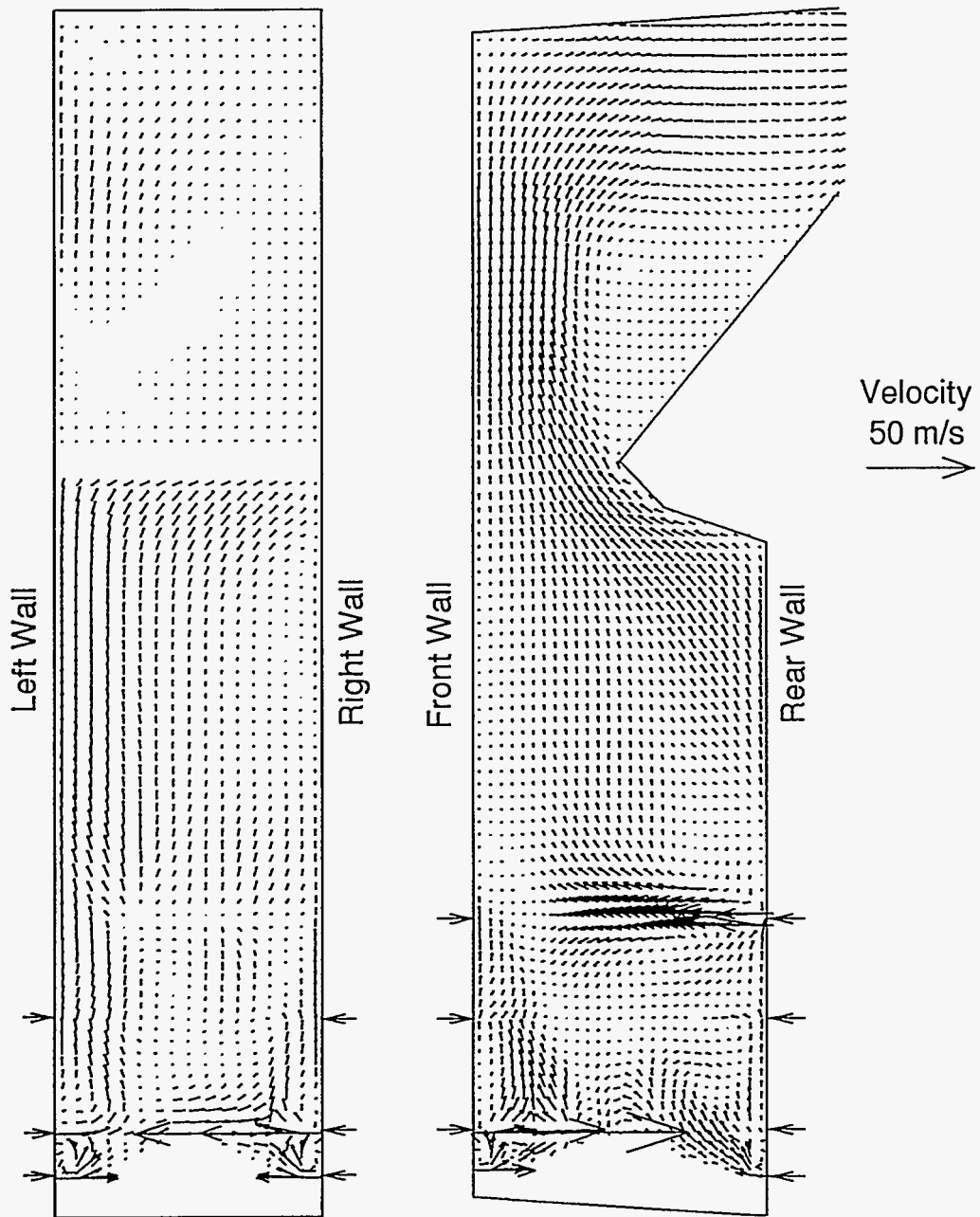

Figure C.6 Gas flow patterns at center planes for commercial boiler (case 2).

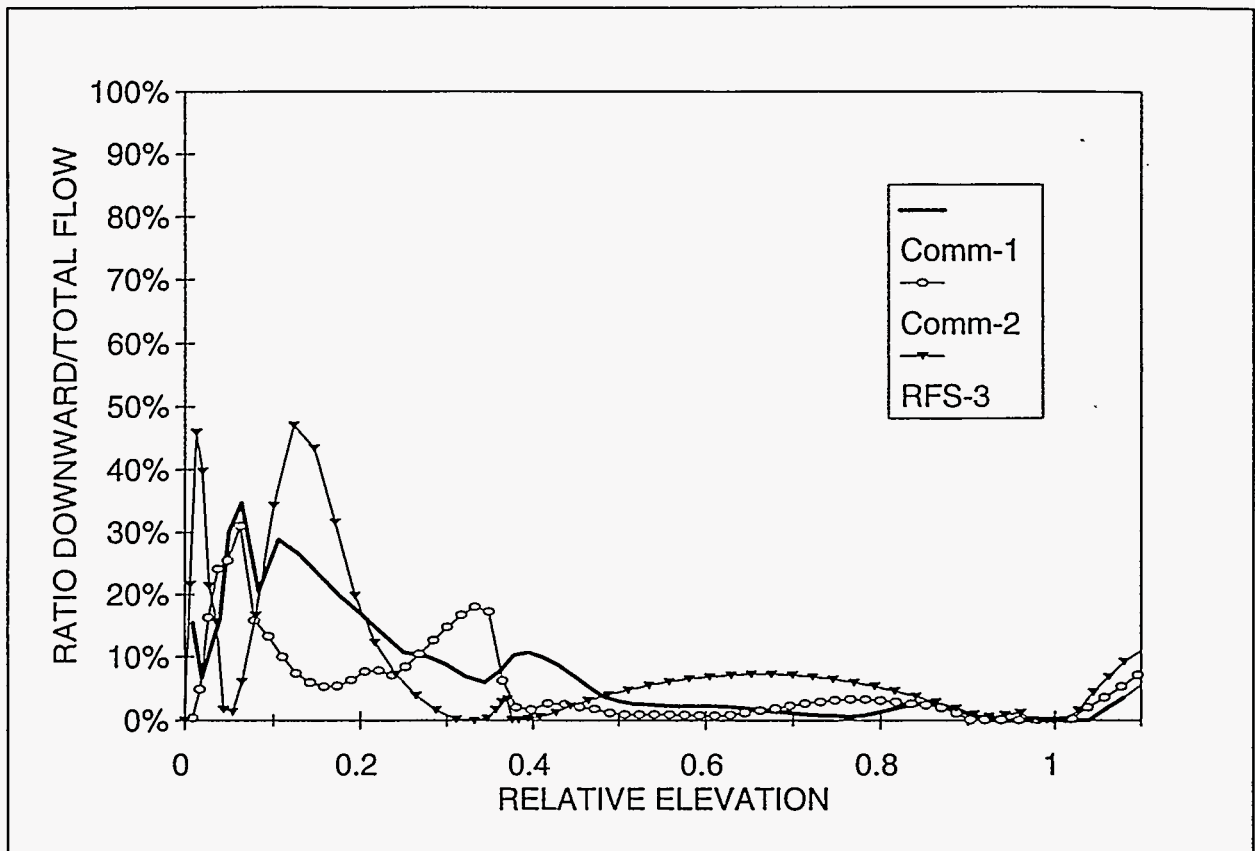

Figure C.7 Gas recirculation (percentage of downward flow) as a function of relative elevation to furnace nose.

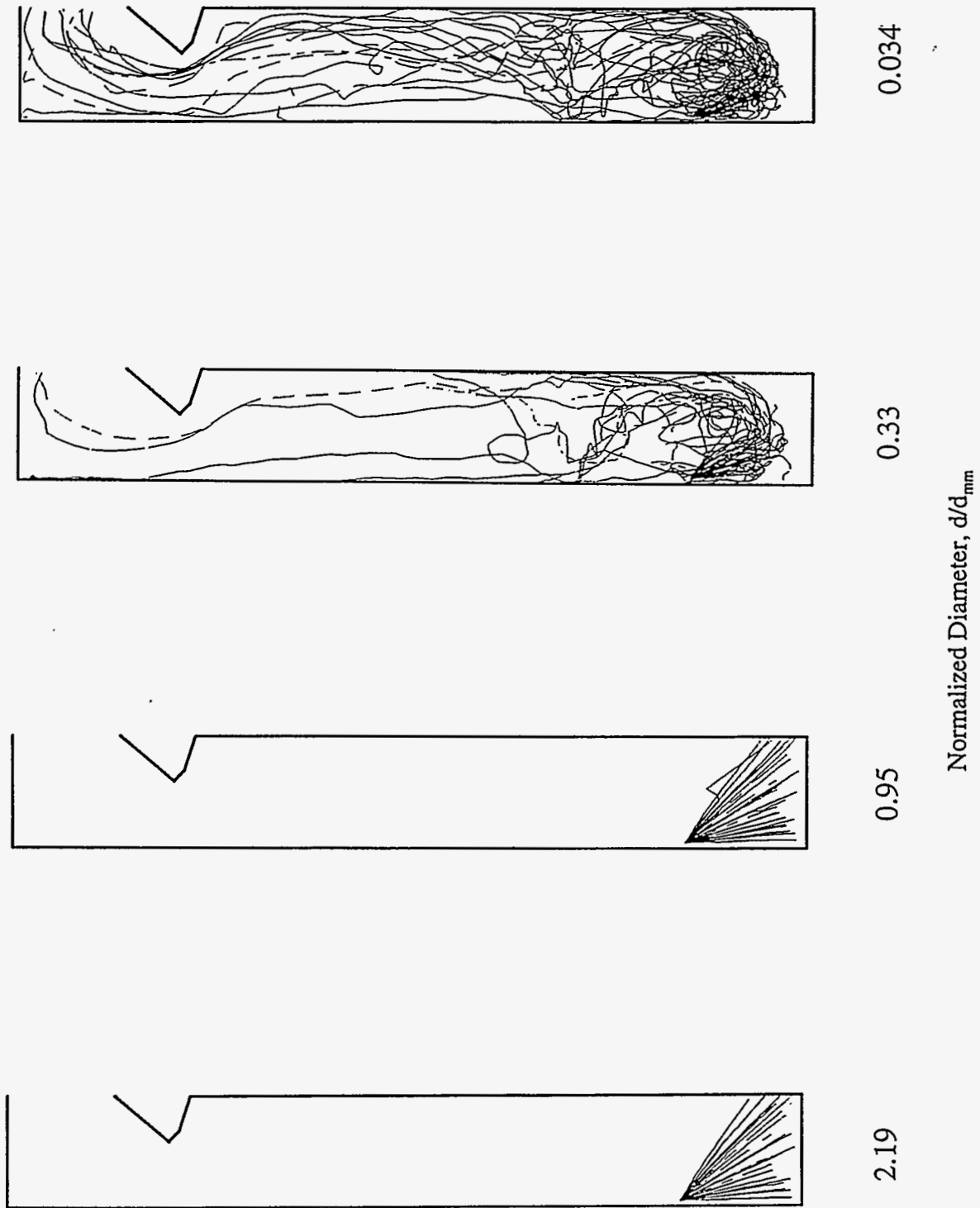

Figure C.8 Representative liquor particle trajectories for RFS (case 3).

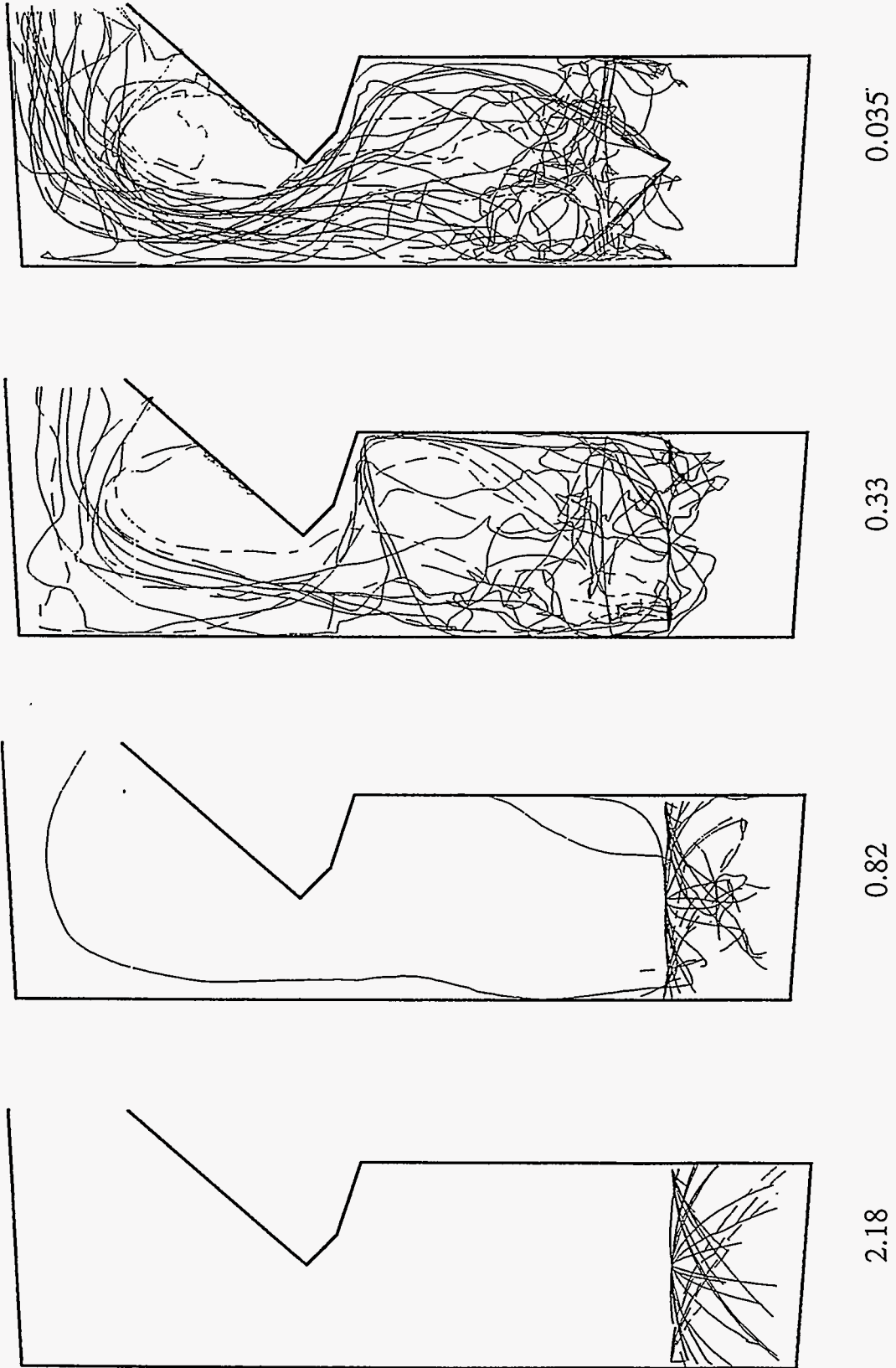

Figure C.9 Representative liquor particle trajectories for commerial boiler (case 2).

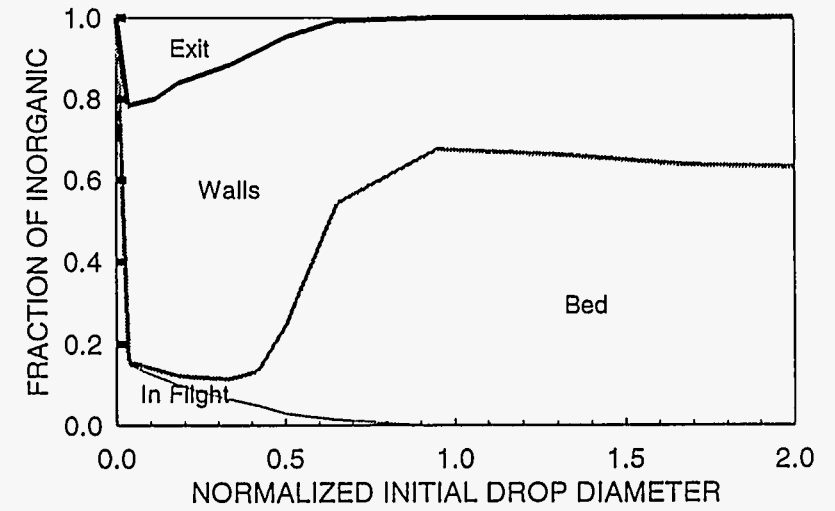
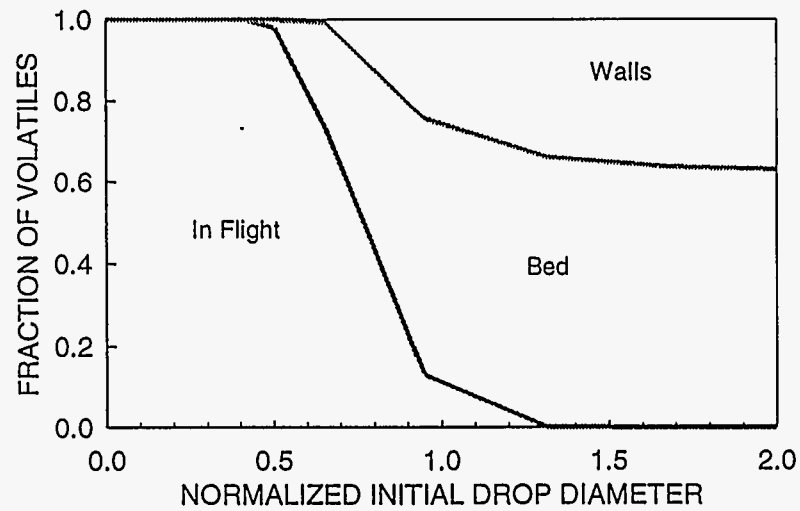
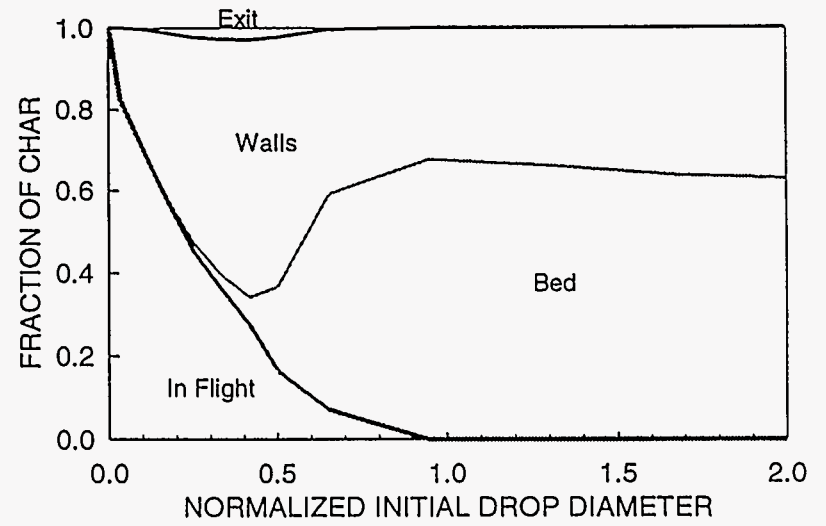
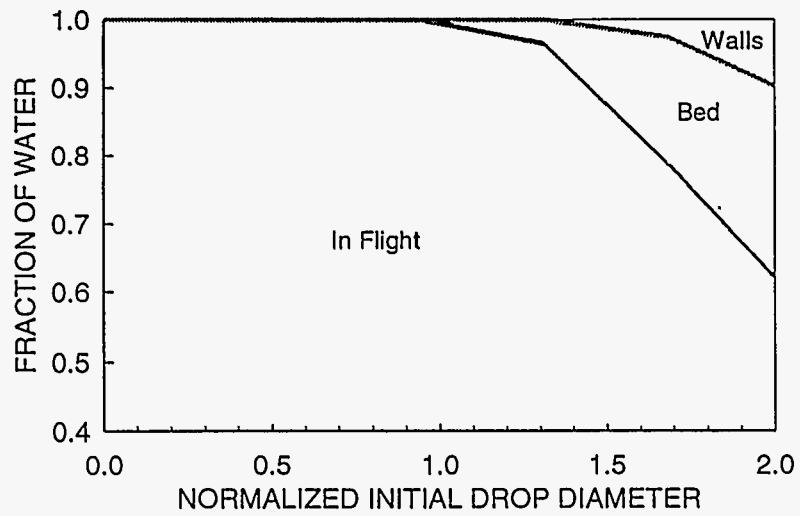

Figure C.10 Fate of black liquor versus normalized drop size for RFS (case 3).

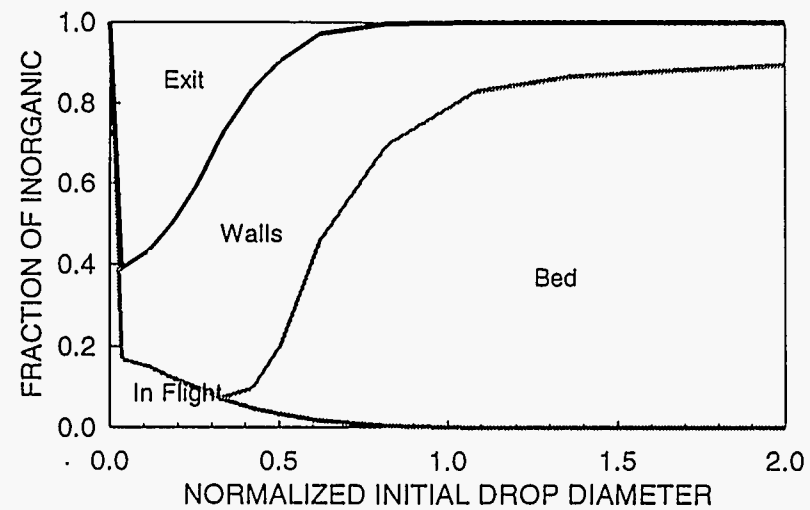
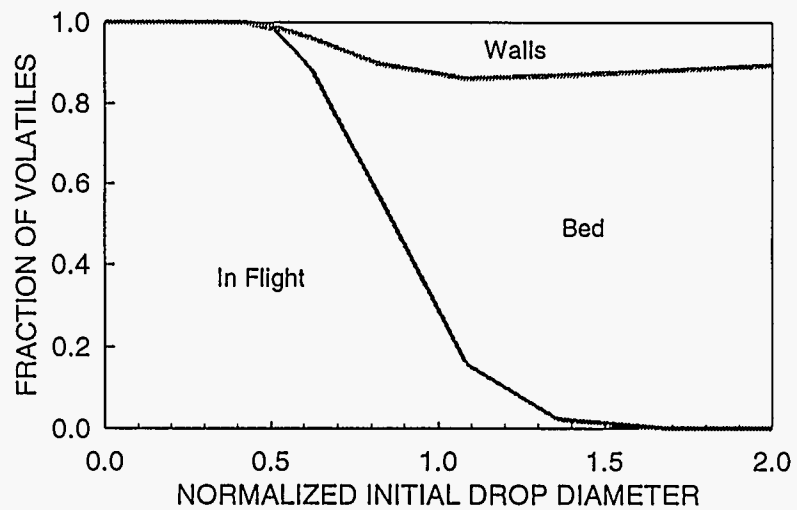
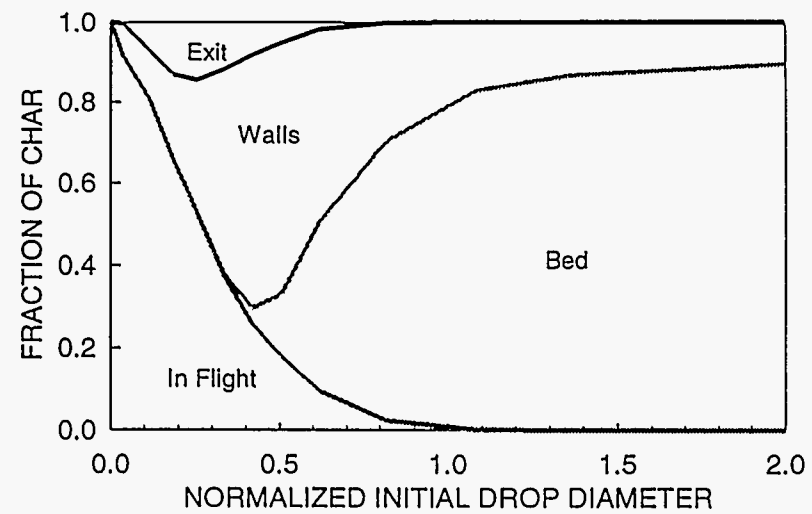
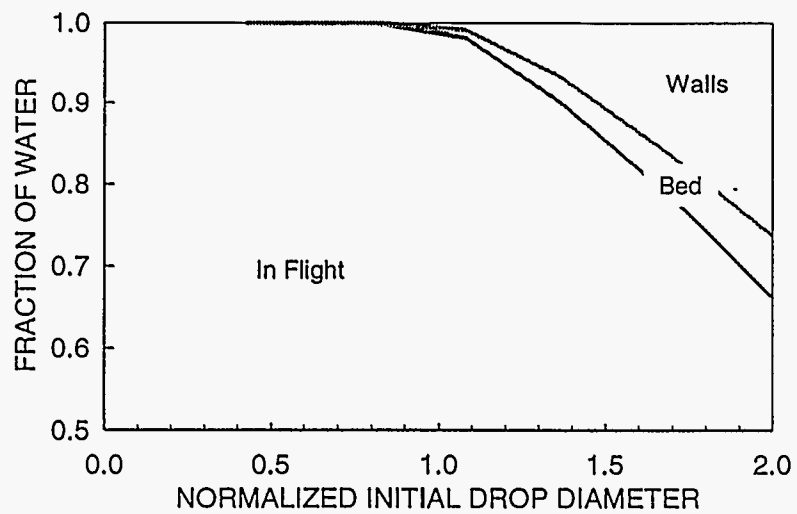

Figure C.11 Fate of black liquor versus normalized drop size for commercial boiler (case 2).

Table C.5 Summary of Black Liquor Drop Fate for RFS (Case 3)

	<i>Liquor Mass Fraction</i>	<i>In-Flight</i>	<i>Walls</i>	<i>Bed</i>	<i>Exit</i>
Water, %	30.0	93.4	1.3	5.3	0.0
Volatiles, %	17.4	30.8	21.1	48.1	0.0
Char, %	14.6	6.2	38.6	54.7	0.5
Inorganics, %	<u>38.0</u>	<u>1.1</u>	<u>42.8</u>	<u>55.1</u>	<u>1.7</u>
	100.0	34.7	25.7	38.9	0.7

Table C.6 Summary of Black Liquor Drop Fate for Commercial Unit (Case 2)

	<i>Liquor Mass Fraction</i>	<i>In-Flight</i>	<i>Walls</i>	<i>Bed</i>	<i>Exit</i>
Water, %	29.9	92.8	5.3	1.9	0.0
Volatiles, %	15.6	39.8	9.3	50.9	0.0
Char, %	13.0	7.0	26.3	65.1	1.6
Inorganics, %	<u>41.5</u>	<u>1.3</u>	<u>28.8</u>	<u>65.7</u>	<u>4.2</u>
	100.0	35.4	18.4	44.3	1.9

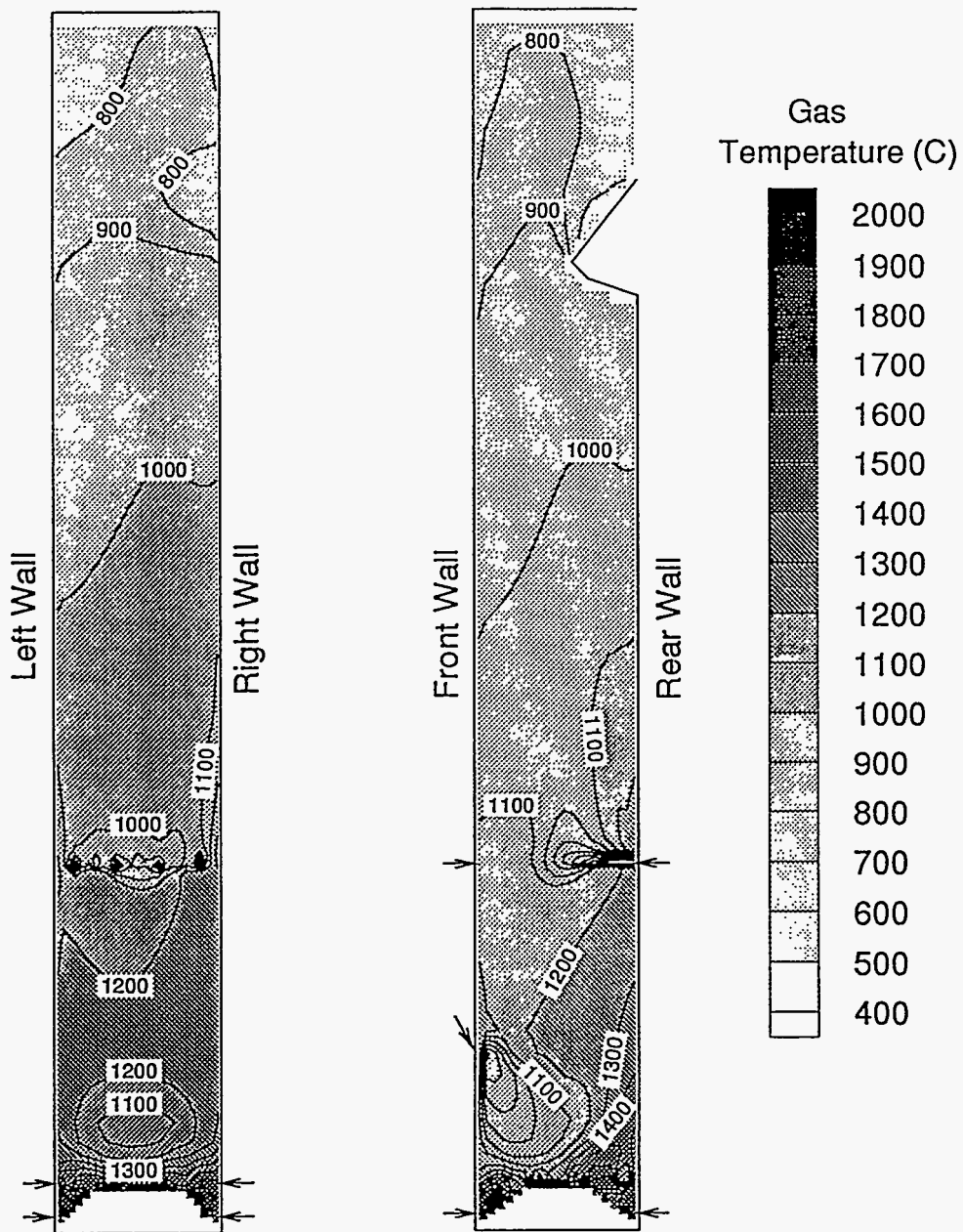

Figure C.12 Temperature distribution at center planes for RFS (case 3)

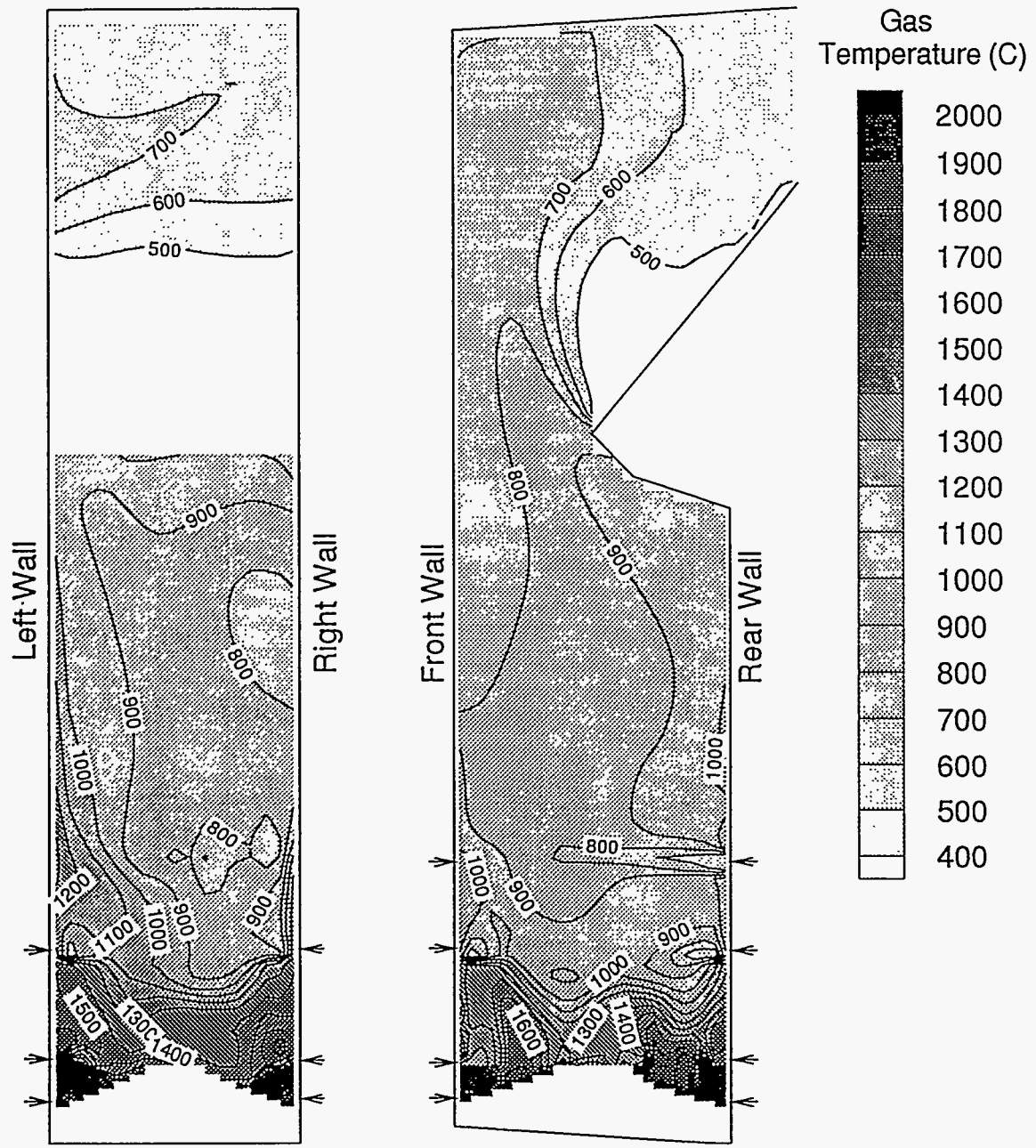

Figure C.13 Temperature distribution at center planes for commercial boiler (case 2)

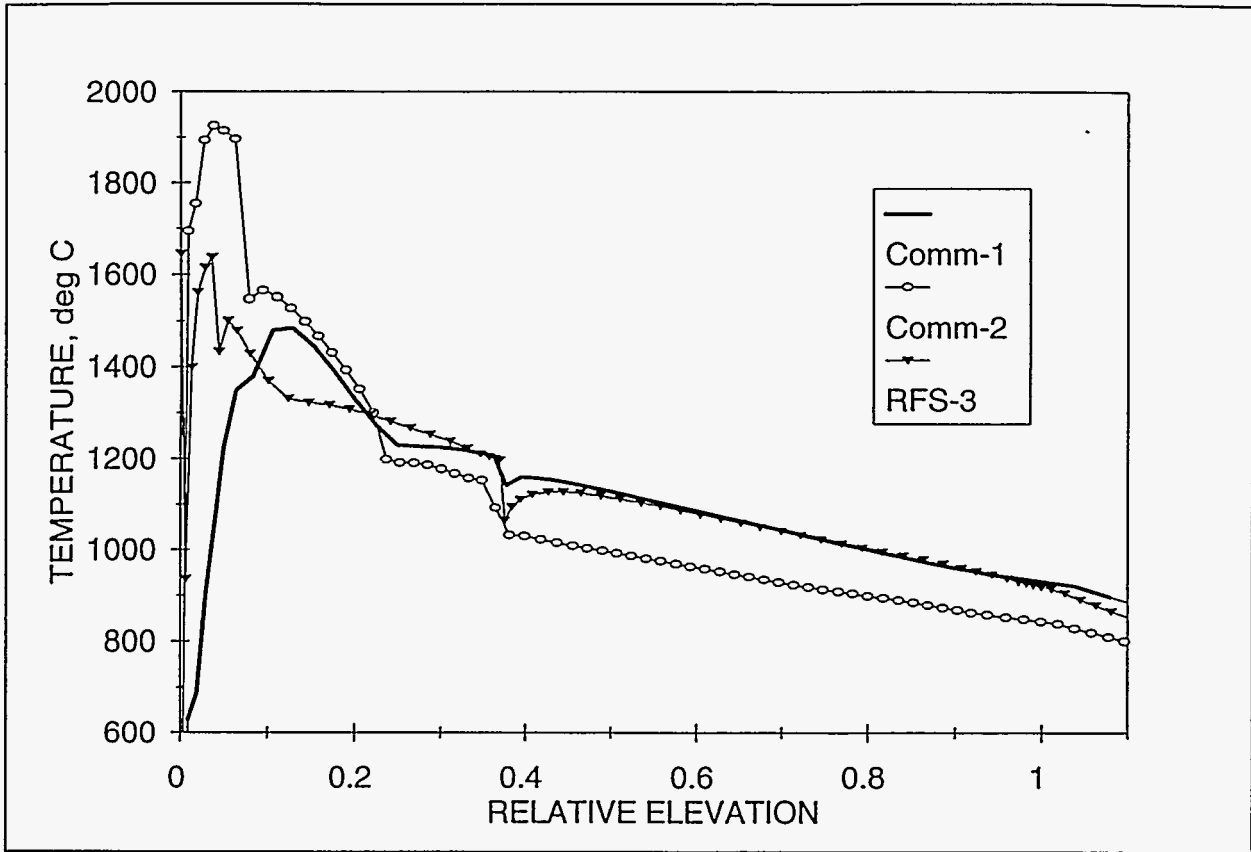

Figure C.14 Average gas temperature as a function of relative elevation to furnace nose.

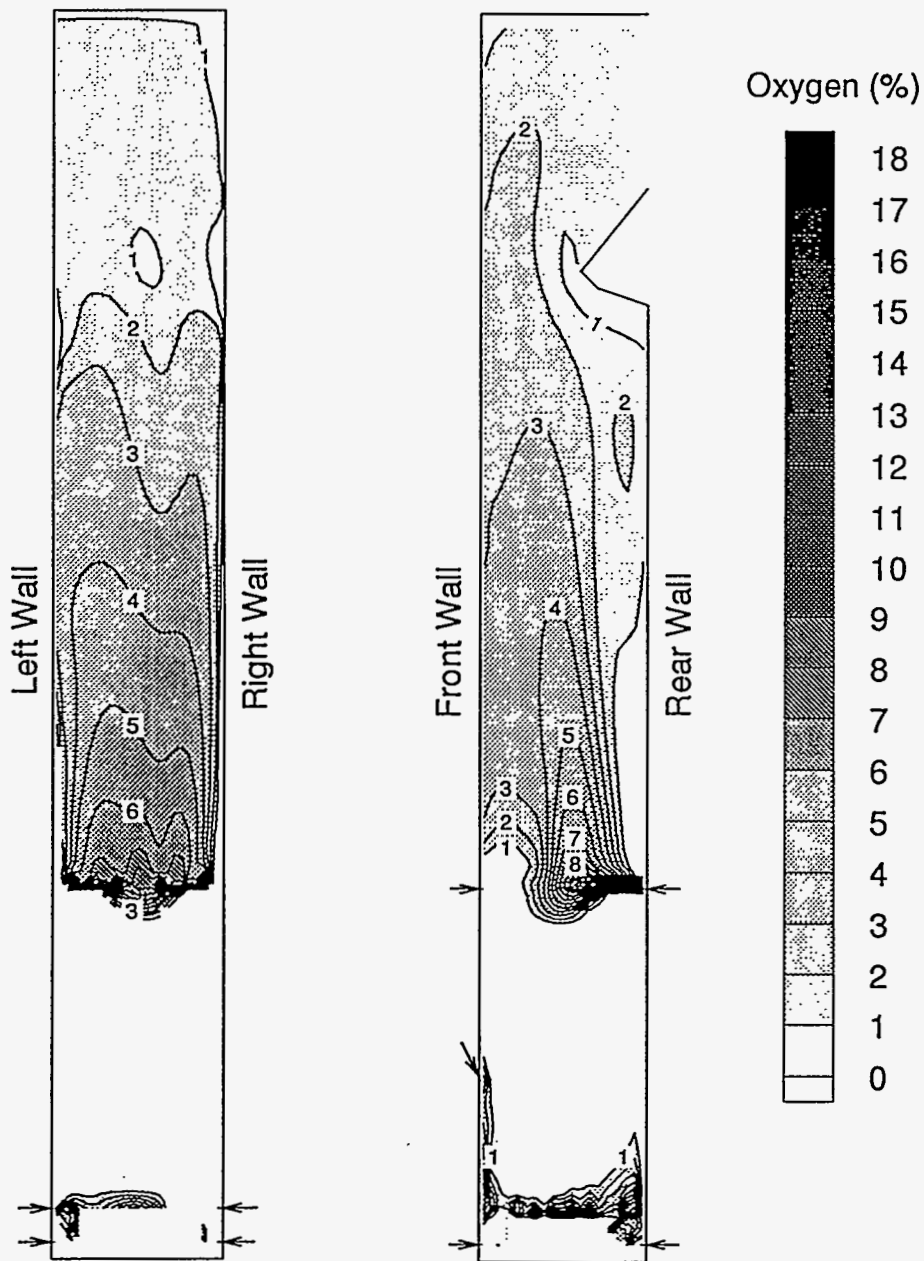

Figure C.15 Oxygen distribution at center planes for RFS (case 3).

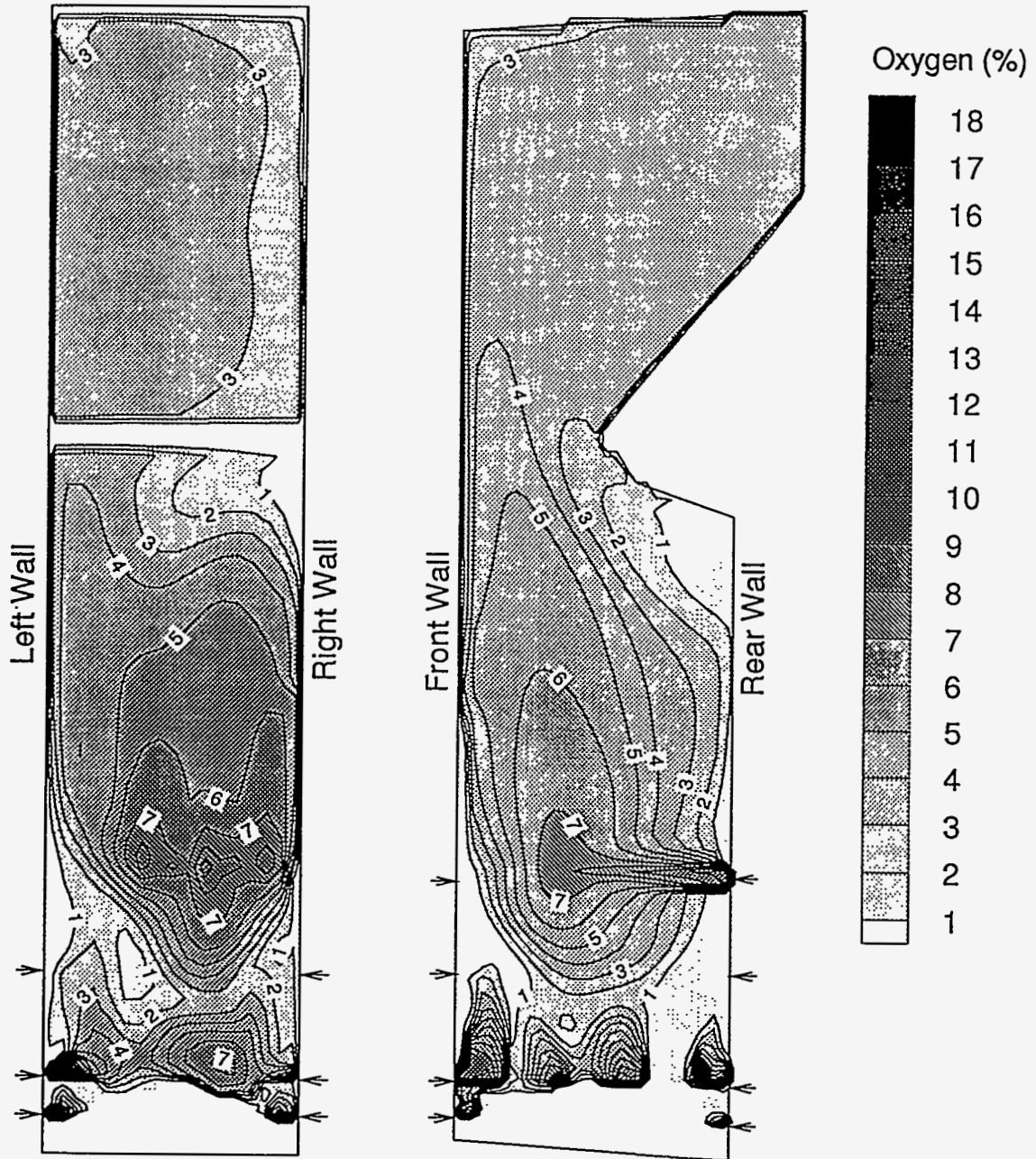

Figure C.16 Oxygen distribution at center planes for commercial boiler (case 2).

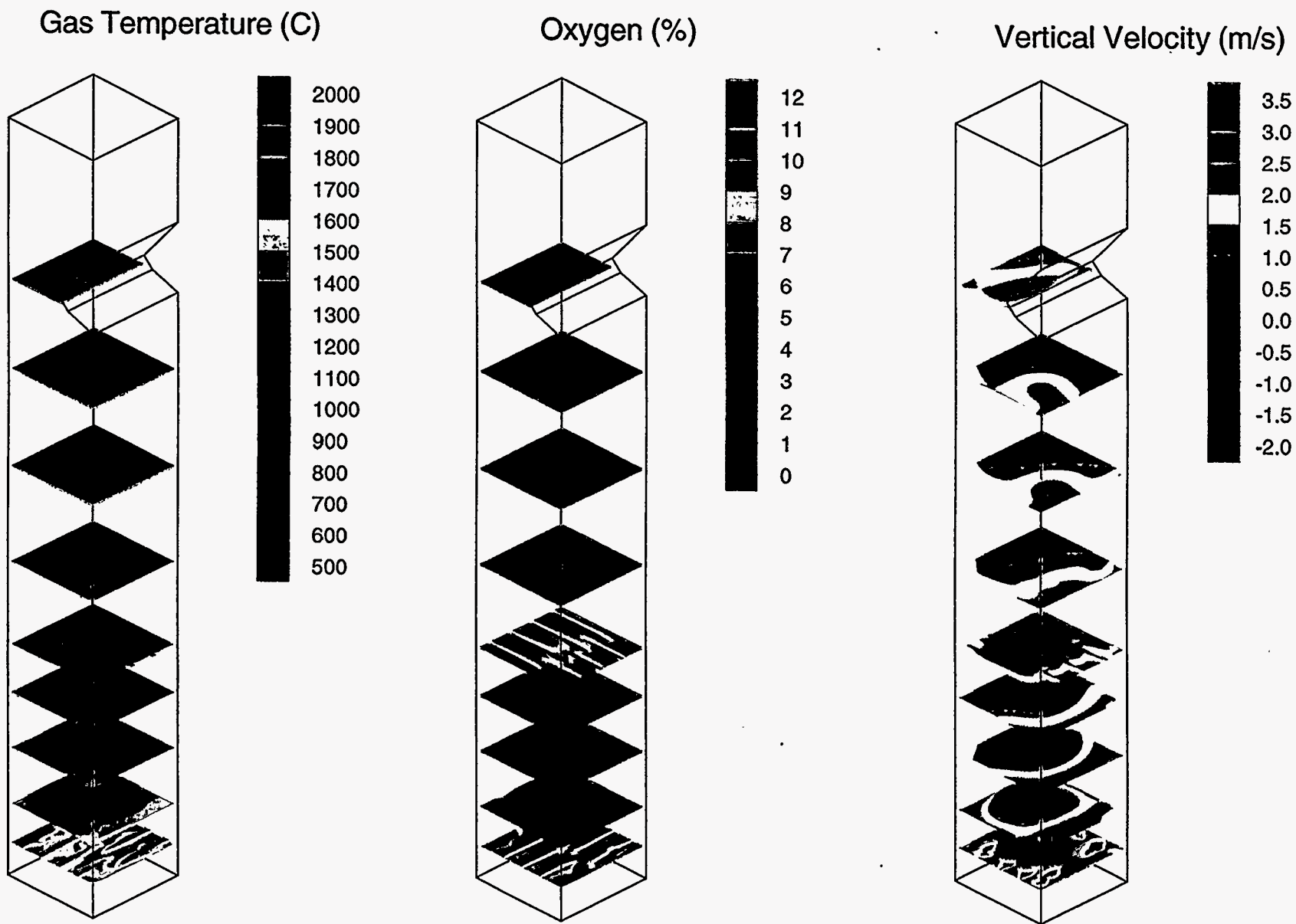
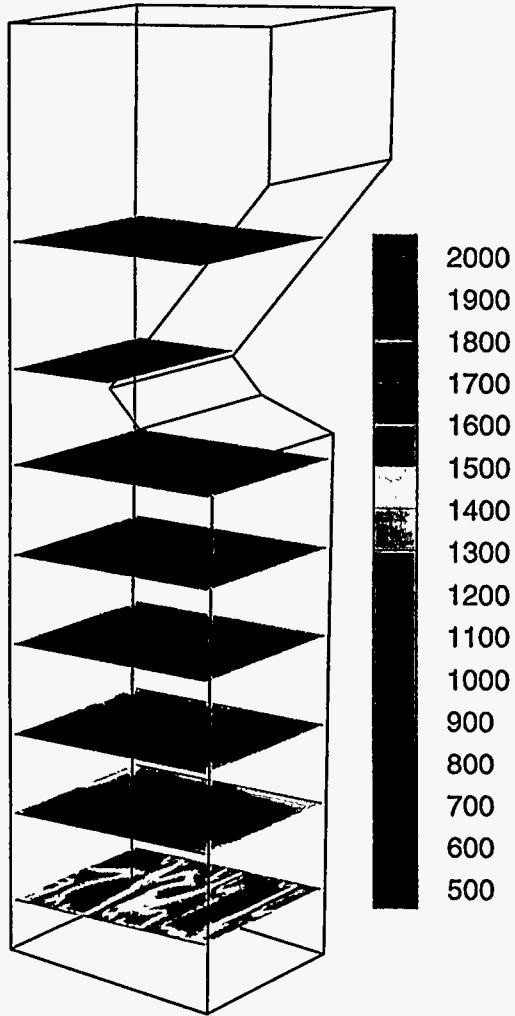
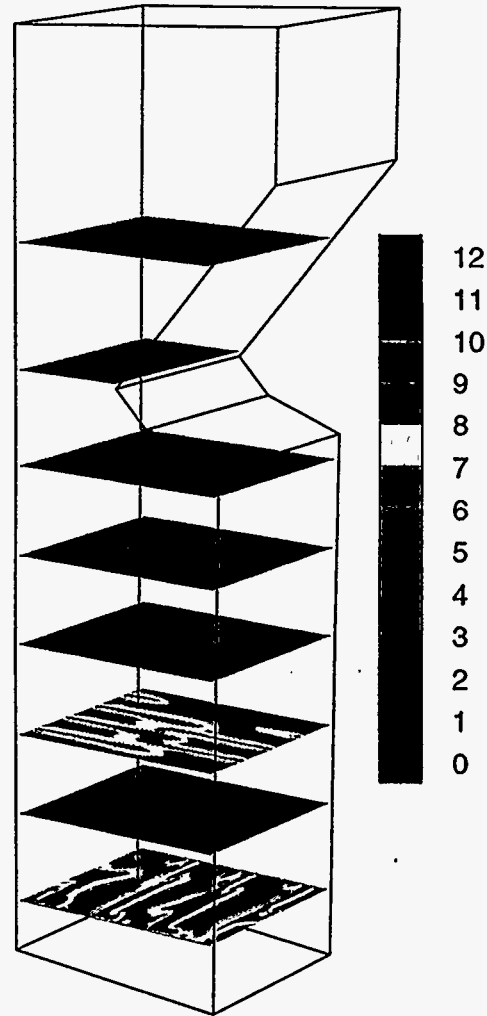

Figure C.17 Temperature, oxygen and vertical velocity at several horizontal planes for RFS (case 3).

Gas Temperature (C)



Oxygen (%)



Vertical Velocity (m/s)

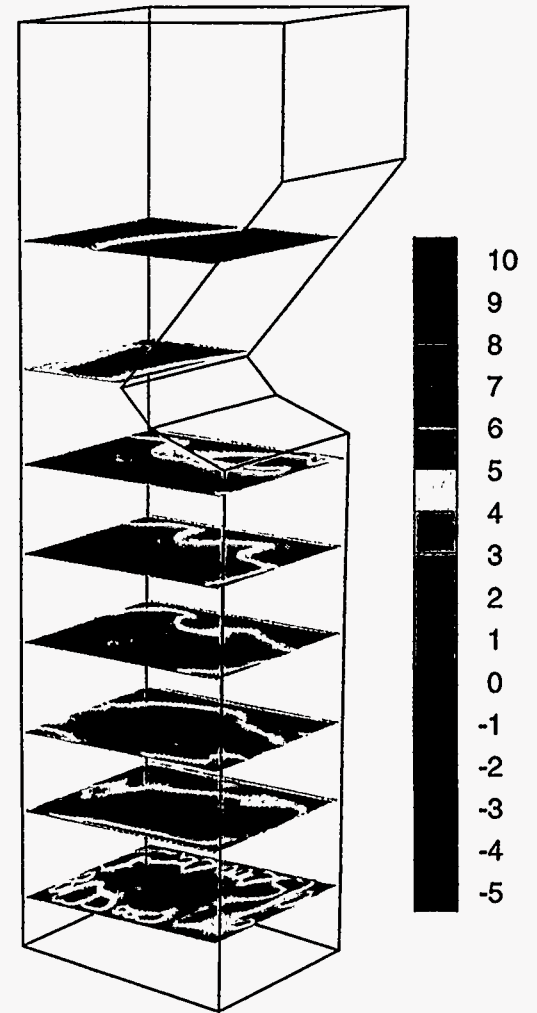

Figure C.18 Temperature, oxygen and vertical velocity at several horizontal planes for commercial boiler (case 2)

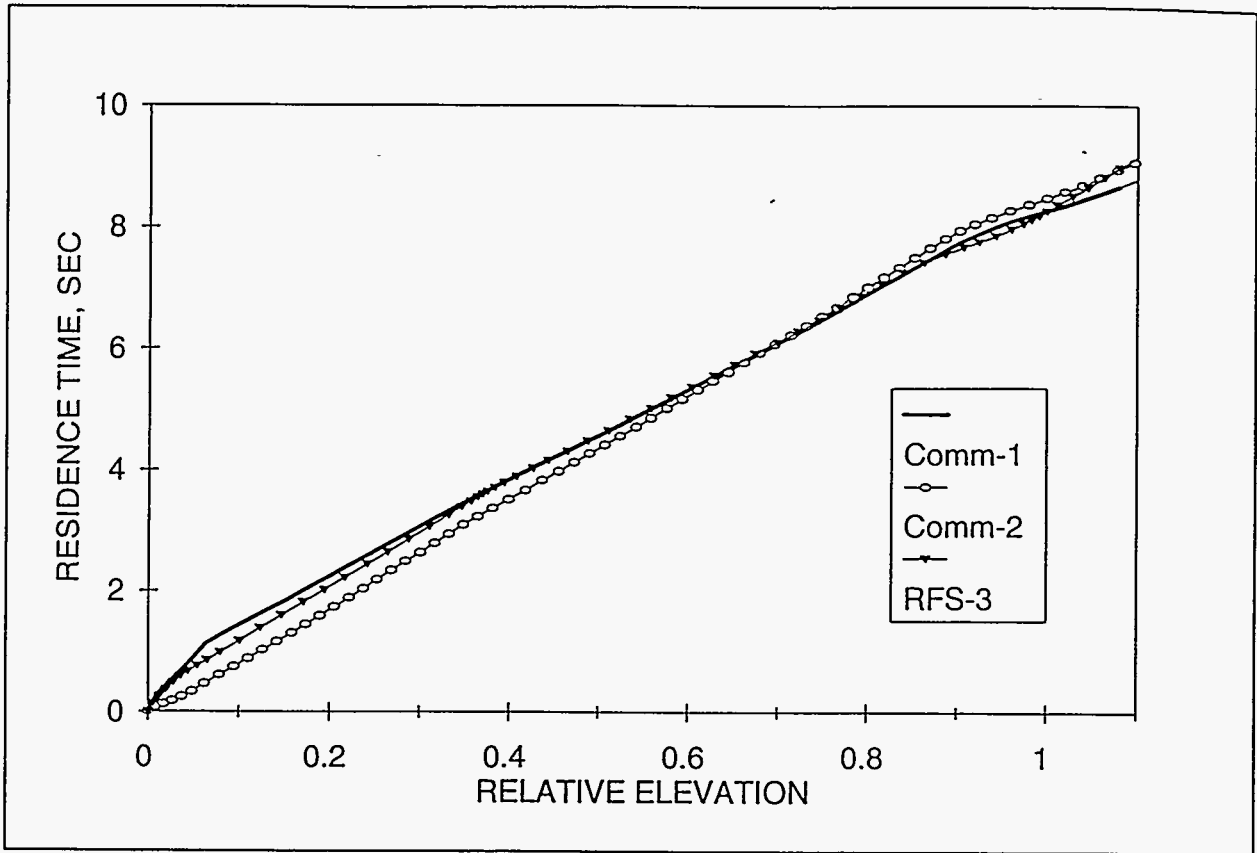

Figure C.19 Average residence time as a function of relative elevation to furnace nose.

C.5 CONCLUSIONS

PR-FURMO was useful for screening preliminary designs of the air and liquor delivery systems of the RFS. Based on modeling results, the optimal design for suspension drying is achieved with the three-level air system and full-cone (Bete) spray nozzle used in case 3.

- o Flow patterns and mixing performance are relatively insensitive to air system design, due to the slender shape of the furnace.
- o Spray distribution is sensitive to nozzle design, elevation and operating parameters (spray velocity, drop size).
- o Gas entrainment by black liquor spray is minimized, but cannot be eliminated in the RFS design.

An insufficient number of alternatives were considered to recommend a design for wall drying operation.

Numerical modeling results demonstrate that the RFS would be well suited for experimental simulation of black liquor combustion with suspension drying because RFS performance is similar to commercial scale, based on:

- o black liquor spray distribution and mechanical carryover
- o gas temperature and residence time profiles
- o chemical environment of lower and upper furnace

The predictive capabilities of PR-FURMO will be even more useful for evaluating RFS performance as more advanced models are implemented for black liquor drop combustion, wall processes, char bed combustion and fume formation.

The RFS will provide a unique, scientifically controlled environment to make measurements for model validation.

C.6 RECOMMENDATIONS

- o B&W should continue to use PR-FURMO to evaluate the performance of the RFS and commercial units for conventional and high-solids, black liquor firing strategies.

- o After construction, modeling should be used to evaluate RFS test conditions to assist in test planning, data interpretation, and scale-up of experimental results.
- o The RFS should be used to make measurements for model validation.

C.7 REFERENCE

1. R.A. Wessel, K.L. Parker and A. Akan-Etuk, "Three-Dimensional Flow and Combustion Model of a Kraft Recovery Furnace," Presented at the TAPPI Engineering Conference, Orlando, Florida, September 20-25, 1993.

APPENDIX D

HIGH SOLIDS BLACK LIQUOR PROPERTIES

(THIS PAGE LEFT INTENTIONALLY BLANK)

TABLE OF CONTENTS

<u>Section</u>	<u>Page</u>
D.1 INTRODUCTION.....	D-1
D.2 SUMMARY.....	D-1
D.3 RECOMMENDATIONS.....	D-2
D.4 BACKGROUND.....	D-3
D.5 HIGH SOLIDS BLACK LIQUOR PROPERTIES.....	D-5
D.5.1 Viscosity.....	D-5
D.5.2 Viscosity Correlations.....	D-7
D.5.3 Viscosity Control.....	D-9
D.5.4 Surface Tension.....	D-10
D.5.5 Density.....	D-12
D.5.6 Boiling Point Elevation.....	D-14
D.6 CONCLUSION.....	D-14
D.7 REFERENCES.....	D-15

LIST OF FIGURES

<u>Figure</u>	<u>Page</u>
1 Viscosity as a Function of Shear Rate for Different Black Liquors at 70°C.....	D-3
2 Viscosity as a Function of Shear Rate for Black Liquor ABAFX043,33 at 76.28% solids.....	D-4
3 Zero Shear Rate Viscosity as a Function of Temperature and Solids Content for Black Liquor ABAFX043,44.....	D-4
4 Reduced Viscosity Plot for Black Liquor ABAFX043,44.....	D-6
5 Surface Tension of Black Liquor as a Function Solids Content and Temperature.....	D-11

LIST OF FIGURES (Continued)

<u>Figure</u>		<u>Page</u>
6	Density (at 25°C) of Kraft Black Liquor as a Function of Solids Content.....	D-13
7	Black Liquor Boiling Point Elevation as a Function of Solids Content.....	D-13

LIST OF TABLES

<u>Table</u>		<u>Page</u>
I	Composition of Black Liquors (mass % of dry solids).....	D-5

D.1 INTRODUCTION

As part of the work proposed to the Department of Energy (DOE) for Phase I of our High Solids Black Liquor Firing contract [RDD 43244], we stated that: "The physical properties of high-solids liquors from several sources will be determined to characterize the liquor. In addition to viscosity, surface tension and density should be evaluated since they also influence liquor handling."¹ The DOE statement of work specifies that B&W "...shall evaluate existing DOE projects and other projects from which information on characterization of high-solids liquor is available to accelerate or perhaps eliminate laboratory work associated with this task. If any further laboratory work is required, expansion of existing DOE agreements or contracts will be evaluated in order to accomplish this work in existing projects in the most expeditious manner."²

Professor Arthur Frike and his associates at the University of Florida (UF), Gainesville, FL have generated a significant body of black liquor property data during their ten-year research program. Most of Dr. Frike's work has been funded under various DOE contracts, administrated by the Office of Industrial Technology. Further information on black liquor properties can be found in other DOE-sponsored projects, which were carried out at the University of Maine (UM) in Orono, ME. There are also a number of relevant studies from other countries published in the open literature.

This report considers the physical properties which will affect the design and operation of our recovery furnace simulator (RFS), namely: viscosity, surface tension, and density. Evaluation of boiling point elevation (BPE) was not specified in our project proposal. However, investigation of this property is justified because it will affect operation of the black liquor concentrator and drying time of black liquor drops in the RFS.

D.2 SUMMARY

Black liquor physical properties have been extensively studied in academic research programs. There is enough information available in the open literature and in company design standards to eliminate the need for experimental measurements or basic black liquor properties research during the design of the RFS. However, due to the effect of wood species and pulping conditions on black liquor properties, it will be necessary to experimentally characterize the liquor from the chosen supply mill prior to actual combustion experiments in the RFS.

Black liquor viscosity is strongly affected by liquor composition and the conditions of storage and handling. At a given solids level, temperature, and shear rate, high solids liquor viscosity from different sources can vary by *several orders of magnitude*. Within a given mill, day-to-day process changes can result in significant viscosity variation.

For RFS design purposes, a B&W correlation based on mill liquor analysis was used to estimate black liquor viscosity. Over the range of solids content (65-75%) and firing

temperature (110-140°C) investigated in the design, this field-proven correlation is likely to be more accurate than the seven-parameter model developed at the University of Florida.

If black liquor is held at elevated temperature for a period of time, the residual alkali will continue to degrade the organic compounds and cause a permanent decrease in viscosity. This is the basis of commercial viscosity control technologies.

Experimental difficulties limit surface tension measurements for black liquor to less than 71% solids. Because the time scale for liquor atomization is an order of magnitude less than that required to make a surface tension measurement, the dynamic surface tension affecting drop formation may be much higher than that measured by laboratory techniques.

Density is not a strong function of liquor composition. In the range of nominal operation (65-75% solids), the error from using a B&W design correlation is not expected to exceed 10%. Extrapolation of this correlation to greater than 80% solids could result in overprediction of density by as much as 15%.

Boiling point elevation is dependent on the inorganic composition of black liquor. In the absence of a good correlation, a non-linear fit of commercial data was utilized for estimating BPE in RFS design calculations. Over the range of 65-75% solids, there was agreement within 10% between the correlation and published data.

The current DOE-sponsored research at UF includes development of a computer spreadsheet program to allow users to generate correlations for their liquor samples and evaluation of on-line viscometers for high solids black liquor. These advances should be available by the end of 1995.

D.3 RECOMMENDATIONS

Periodic contact with Drs. Frike and Zaman at the University of Florida is recommended to remain cognizant of their activities in three critical areas:

- o laboratory techniques for measuring high solids black liquor properties,
- o procedures for creating generalized correlations of liquor properties,
- o evaluation of on-line instrumentation for continuous property measurement.

In planning Phase II activities, sufficient resources must be allocated for a R&FBB Section Research Engineer and Analytical Chemistry Section personnel to generate viscosity and density correlations for our selected liquor.

It will be necessary to run a viscosity check on each arriving liquor shipment, because process upsets at the mill could result in different viscosity behavior. After a database of liquor properties from the source mill has been established, it will be easy to detect variances

and take measures to maintain uniform feed to the RFS. This will aid in assuring that any effects on test results are interpreted accurately.

D.4 BACKGROUND

Black liquor is a by-product of the kraft chemical pulping process. The kraft process is widely used by the pulp and paper industry to liberate papermaking fibers from wood.

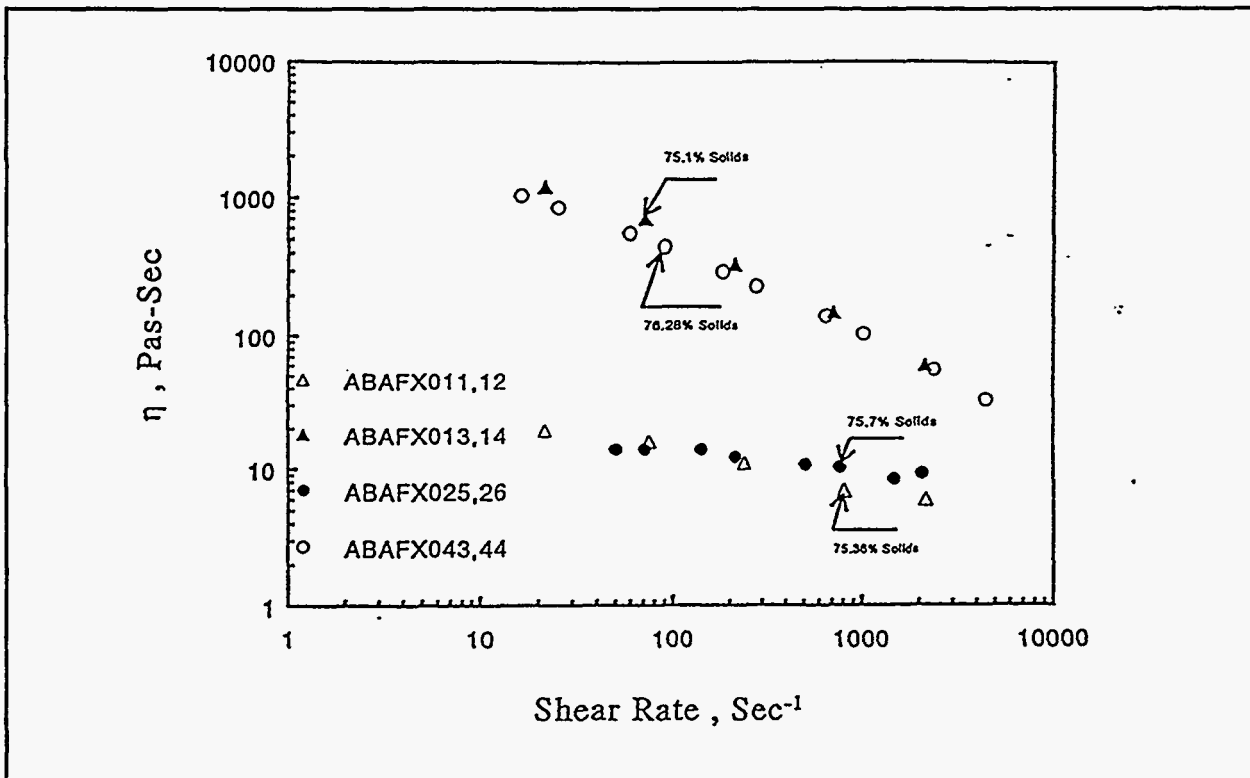

Figure 1. Viscosity as a function of shear rate for different black liquors at 70°C.¹²

Recovery of the pulping chemicals and utilization of the energy value of the dissolved organic compounds in the black liquor is carried out in the kraft process recovery boiler. An understanding of the physical properties of black liquor is required to design and control the operation of equipment for concentration and combustion of black liquor.

The composition of black liquor depends on the wood species being pulped, the amount of chemicals added, and the pulping conditions. Typical Finnish black liquor compositions are presented in Table I.³ The composition of North American black liquors is similar. Hydrolysis of wood lignin (a natural adhesive) during pulping generates the alkali lignin portion of black liquor; it is present largely as colloidal polymer molecules. The carboxylic acids arise primarily from unwanted degradation of cellulose fibers. More than half of the sodium present in black liquor is bound to the various ionized organic liquor

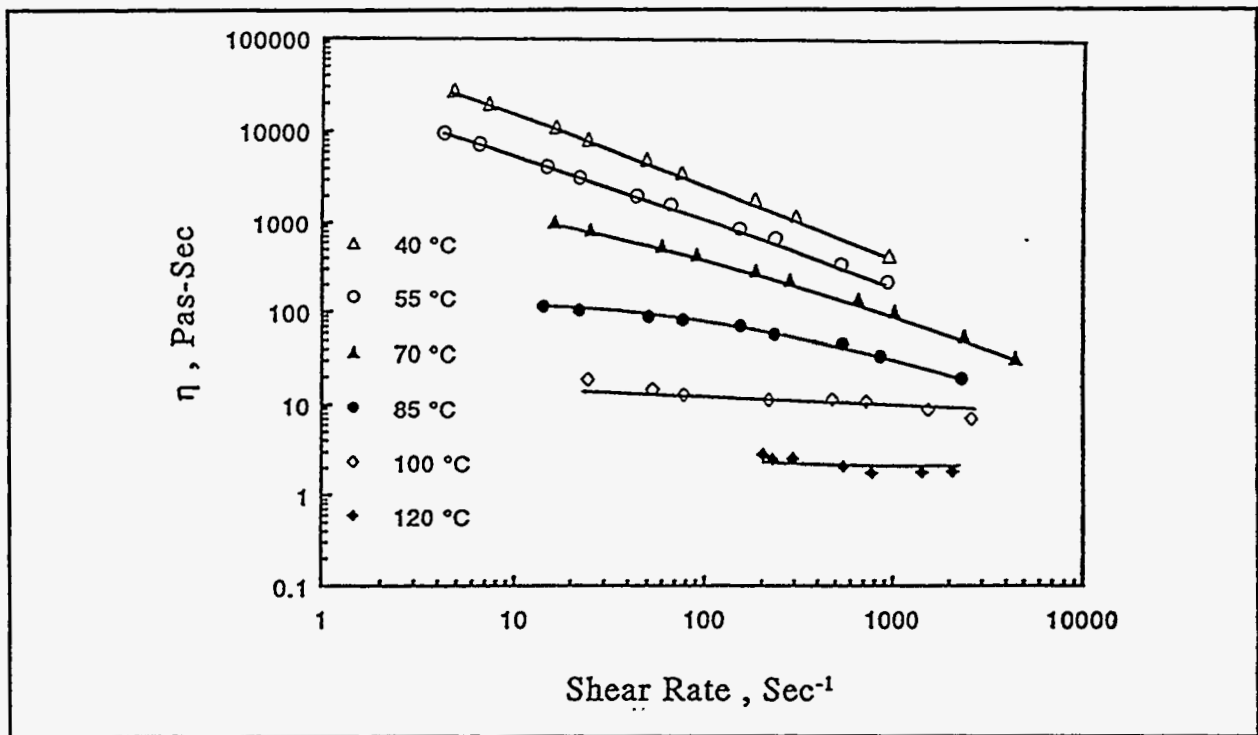

Figure 2. Viscosity as a function of shear rate for black liquor ABAFX043,33 at 76.28% solids.¹²

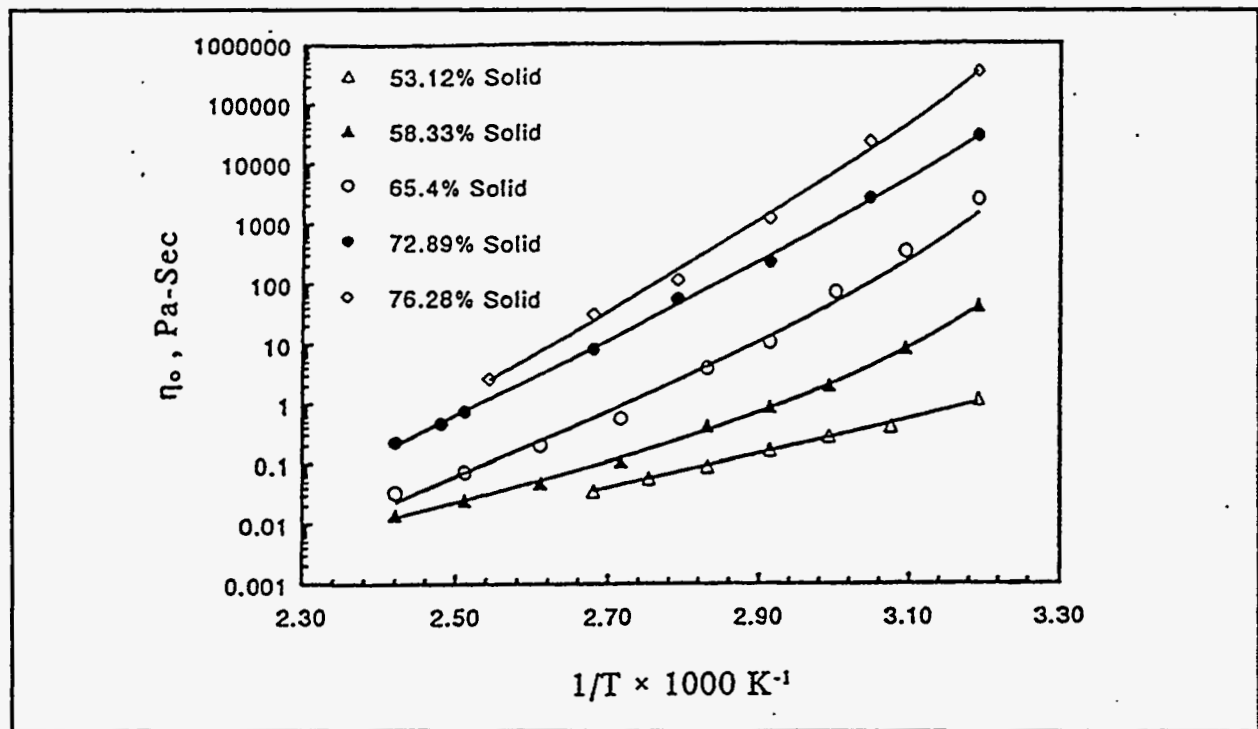

Figure 3. Zero shear rate viscosity as a function of temperature and solids content for black liquor ABAFX043,44.¹⁰

components.⁴ The remaining sodium is present as a mixture of residual active pulping chemicals (NaOH and Na₂S) and reacted, inert species, primarily Na₂CO₃ and Na₂SO₄. Black liquor also contains minor amounts of solvent-extractable compounds and polysaccharides,³ and trace quantities of many inorganic species.⁴

Table I. Composition of black liquors (mass % of dry solids).

Component	Pine Liquor	Birch Liquor
Lignin	33	27
Aliphatic carboxylic acids	31	32
Inorganics ^a	28	29
Extractives	5	4
Other organics	3	8

^a Including organically-bound sodium.

Below 60% solids, black liquor behaves as an aqueous mixture of colloidal organic and dissolved inorganic molecules. Its physical properties (density, viscosity) can be adequately modeled by simple relationships derived from the physical chemistry of dilute solutions.⁵ Above 60% solids, water is no longer the continuous phase and black liquor begins to behave as a non-newtonian polymer melt. Liquor behavior becomes even more complex as concentration increases and inorganic salts begin to precipitate as their solubility limits are exceeded.

A comprehensive review of black liquor physical properties is given in Chapter 2 of Adams and Frederick's Kraft Recovery Boiler Physical and Chemical Processes.⁶ At the time their review was compiled (1987), there was little available information on liquor properties at greater than 70% solids content. The long-term objective of our research program is to improve combustion technology for burning 80-90% solids black liquors. Our immediate need is to design a pilot facility for burning black liquor at conventional levels of 65-75% solids. For the purposes of RFS design and planning future phases of research, this review considers recently-published information on high solids liquor properties.

D.5 HIGH SOLIDS BLACK LIQUOR PROPERTIES

D.5.1 Viscosity

The rheology of black liquor has been extensively studied, although only recently has viscosity has been reported at 75-85% solids content.^{7,8,9,10,11} The viscosity of a given pulp

mill's black liquor is very difficult to characterize because black liquor viscosity is strongly (and often non-linearly) dependent on:

- o shear rate
- o temperature
- o solids content
- o liquor composition (a function of wood species and pulping conditions)
- o thermal history

The effects of temperature and shear rate on apparent viscosity of a 75% solids black liquor are shown in Fig. 2.¹² Figure 3 demonstrates the effect of solids content and temperature on zero shear rate viscosity.¹⁰ The general trends of increasing viscosity with decreasing temperature and increasing solids is characteristic of all black liquors; however, the magnitude of the effects can vary tremendously with liquor source. The shear-thinning or pseudoplastic behavior, apparent in Fig. 2, also increases with increasing solids and decreasing temperature.

Dramatic effects of wood species on liquor viscosity have been reported,^{7,13} but these effects remain to be adequately explained. One of the original objectives of the UF research program was to investigate the effect of wood species on black liquor viscosity.⁶ Thus far only black liquors derived from a single wood species, slash pine, have been studied in detail.

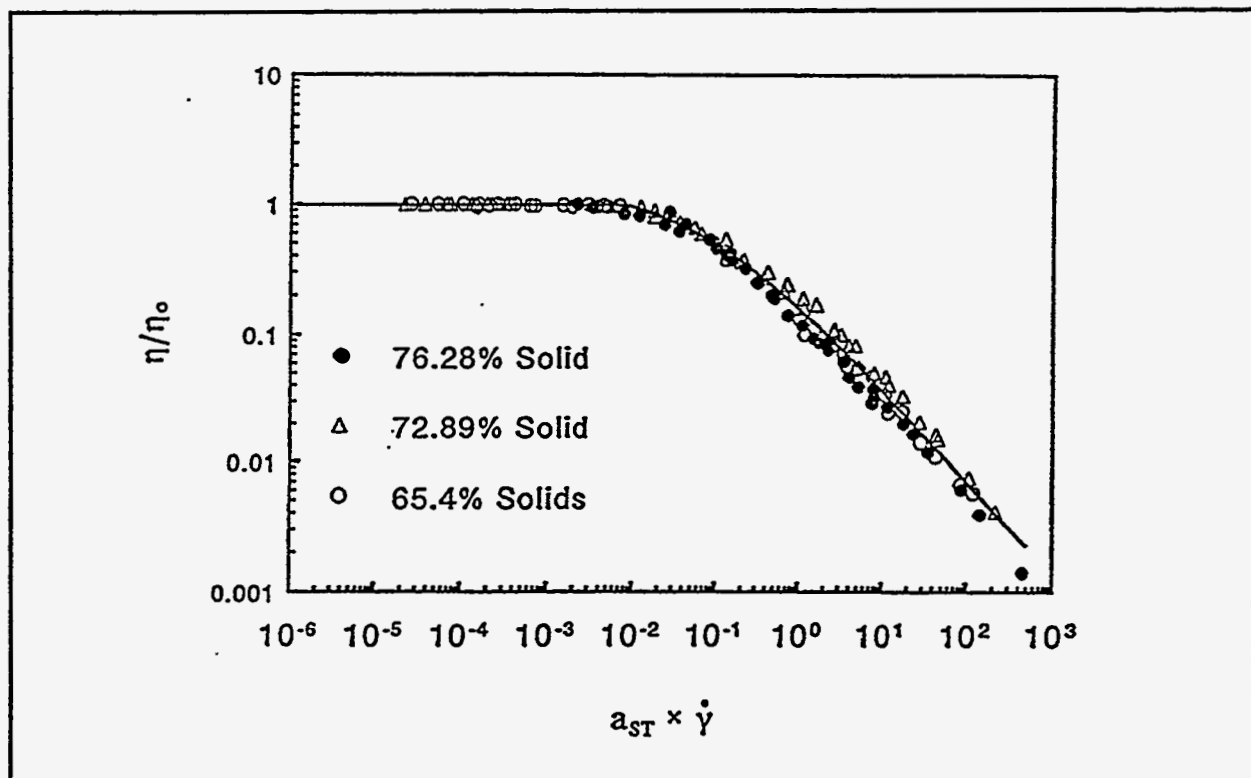

Figure 4. Reduced viscosity plot for black liquor ABAFX043,44.¹²

Limited analyses of other liquors has demonstrated that the fundamental relationships and correlation procedures developed for slash pine can be generally applied to all species.⁵

It has been proposed that the amount and size (mass-average molecular weight) of the lignin component is the most important factor affecting black liquor viscosity.¹² Söderhjelm¹¹ contends that the polysaccharide content has the greatest effect on viscosity. Regardless of which type of compound (or combination of compounds) is responsible for black liquor viscosity, researchers agree that the conditions of pulping have a strong effect.^{11,12,14} Figure 1 shows that viscosities of 75% solids slash pine liquors at 70°C vary by as much as ± 600% (measured at a shear rate of 1000 sec⁻¹), and by ± 1825% at 100 sec⁻¹. The four liquors represented in Fig. 1 were prepared from laboratory pulping experiments in which the conditions were chosen to vary the extent of delignification and the average molecular weight of the lignin in the black liquor.¹⁵

The inorganic fraction of black liquor has some effect on viscosity, although this is understood even less than that of the organic content. In an early investigation of viscosity reduction by thermal treatment (described below), the addition of NaOH to weak black liquor prior to heat treatment resulted in an increase of the viscosity of the concentrated liquor.¹³ Results of Milanova and Dorris¹⁴ confirm this effect, but only after a minimum residual alkali content has been exceeded. In one study, increasing the sulfur content of the pulping liquor significantly decreased the viscosity of resulting birch black liquors, but had little effect on liquors derived from pine.¹¹

Measuring high solids black liquor viscosity is not straight-forward. The measurements must be made at elevated temperatures to allow the fluid to flow in the viscometer, this requires pressurized, sealed equipment to prevent evaporation. Rapid measurement is necessary because viscosity irreversibly decreases when liquor is held at elevated temperatures. The procedures set forth by Frike and coworkers have been adapted for use in the ARC Analytical Chemistry laboratory. A Haake viscometer with a pressurized, coaxial cylinder measurement cell has been used to characterize the rheological properties of a number of industrial high solids liquor samples.

D.5.2 Viscosity Correlations

For black liquors of less than 50% solids content, viscosity can be adequately correlated to solids and temperature by a polynomial expression derived from the theory of dilute solutions:¹⁶

$$\log(v_R) = a_1 \left(\frac{S}{T} \right) + a_2 \left(\frac{S}{T} \right)^2 \quad (1)$$

where v_R = reduced kinematic viscosity (ratio of liquor kinematic viscosity to kinematic viscosity of water at same temperature,
 S = percent solids concentration,

T = absolute temperature,
 a_1 = wood species dependant constant,
 a_2 = liquor composition dependent constant.

The liquor-specific constants in Eq. 1 can be defined with six to eight viscosity measurements; accuracy of the correlation is approximately 15%.⁵ Zaman and Frike¹⁶ describe another method of correlating low solids liquor, based on free volume theory, which allows more accurate extrapolation to higher temperatures. However, the free volume method is less practical in that it requires determination of additional liquor-specific constants.

Because high solids liquors are polymer melts rather than solutions, a reduced correlation like Eq. 1 cannot be applied.⁶ At very low shear rates, viscosity of high solids black liquor approaches Newtonian behavior. The "zero shear rate" viscosity can be determined by direct measurement at very low shear or extrapolation of experimental data to zero shear rate.¹⁷ The following equation is recommended for correlating high solids viscosity data:

$$\log(\eta_0) = g_0 + g_1 \left(\frac{S}{S+1} \frac{1}{T} \right) + g_2 \left(\frac{S}{S+1} \frac{1}{T} \right)^2 \quad (2)$$

where η_0 = zero shear rate viscosity,
 S = solids mass fraction,
 T = absolute temperature,
 $g_{0,1,2}$ = liquor specific constants.

Three constants in Eq. 2 are required to generate a zero shear rate "master curve" for a given black liquor. In order to predict viscosity at different temperatures, solids contents, and shear rates, Zaman and Frike¹² developed superposition "shift factor" (a_{ST}), which depends on glass transition temperature. Glass transition temperature of black liquor can be correlated to solids content with two constants.¹⁷ Finally, a model of the viscosity behavior must be utilized to extrapolate the zero shear rate master curve viscosity to higher shear rates. The two-parameter power law models of Cross and Carreau-Yasuda were shown by Zaman and Frike¹² to accurately predict the viscosity-shear rate curves for high solids black liquor. A total of seven composition-dependant constants are required to generate high solids viscosity correlations.⁵ Figure 4 is an example reduced viscosity (η/η_0) versus shear rate ($\dot{\gamma}$) plot for one laboratory black liquor; the accuracy of the correlation is approximately 30%.

For RFS design purposes, a B&W design correlation based on mill liquor analysis was used to estimate black liquor viscosity. Over the range of solids content (65-75%) and firing temperature (110-140°C) investigated, this field-proven correlation is likely to be more accurate than the UF procedure described above. Considering the high variability of liquor viscosity with wood species and pulp mill conditions, it is not practical to generate a correlation like Fig. 4 until the liquor source mill has been identified.

The liquor-specific constants in the viscosity relationships are being correlated with readily measurable liquor composition and pulping process variables in ongoing work at UF.⁵ One deliverable of the DOE-sponsored research program is an interactive personal computer program to enable users to generate correlations for their liquor samples; this software should be available by the end of 1995.

D.5.3 Viscosity Control

Control of liquor viscosity is important for two aspects of RFS operation: pumping and spraying. Without some means of control, viscosity would rise to unpumpable levels (i.e., greater than 2500 cp) as solids content increases from 75 to 85%. Furthermore, the median drop size and spray pattern from a pressure atomizing nozzle is sensitive to fluid viscosity.¹⁸ Drop size would increase and spray angle decrease with increasing viscosity until the fluid spray deteriorates to a single stream exiting the nozzle.

Two approaches have been taken by concentrator vendors to control viscosity at high solids: pressurized liquor storage and handling systems, and thermal treatment. These are to (1) control viscosity by maintaining heavy liquor at higher temperatures and under pressure in the handling and feed system, and (2) permanently reduce the viscosity by heat treatment prior to the concentrators.

The approach taken by Wheelabrator HPD to maintain moderate liquor viscosity at high solids is to increase liquor temperature and evaporator pressure.¹⁹ In pilot trials, HPD maintained a constant viscosity of 200 cp (0.2 Pa-s) as solids content was increased from 80 to 81.5% by increasing operating temperature from 318 to 336°F (159-169°C). Goslin-Birmingham²⁰ and Tampella²¹ use similar technology to commercially produce 80+% solids liquor. Observations reported in the literature suggest that, when viscosity is controlled by elevated temperature, the design must address the problem that the liquor will solidify in the equipment if pressure is lost and the liquor is allowed to cool.²²

The Ahlstrom "Liquor Heat Treatment" process can achieve an irreversible 65-75% reduction in liquor viscosity with some liquors without requiring pressurized liquor storage systems.²³ In the Ahlstrom process, black liquor is taken from the evaporator train at 40-50% solids, heated to 355-375°F (180-190°C) and "cooked" for 20-30 minutes to break down the high molecular weight organic compounds.²⁴ The reaction vessel is presumably pressurized to greater than 145-185 psia (21-27 kPa). Ahlstrom's results suggest that 80% solids liquor can be produced with the same viscosity as untreated liquor at 69% solids. Operational experience at three Finnish mills has shown that this liquor can be stored and handled at atmospheric pressure.²⁵

A disadvantage of high temperature concentration and heat treatment is the generation of malodorous noncondensable gases (NCGs). This must be considered in RFS design to minimize nuisance and safety risks as well as prevent excessive sulfur loss from black liquor. The majority of the NCGs produced during kraft pulping are stripped from the black liquor

during normal evaporation to 55% solids. However, as liquor temperature is increased beyond 300°F (150°C), pyrolytic degradation of sulfur-bearing lignin molecules releases volatile malodorous fragments (e.g., methyl mercaptan). NCG generation has been noted by HPD during high solids concentration trials.¹⁹ Ahlstrom's aggressive heat treatment process results in enough NCG generation to require sulfur reclamation operations to minimize chemical loss from the liquor cycle.²⁵

A minimum level of residual alkali (NaOH) is required to achieve viscosity reduction during liquor heat treatment.²⁵ Further addition of NaOH may only increase viscosity.^{13,14} Depolymerization reactions proceed rapidly if thermal treatment is carried out at less than 50% solids and greater than 355°F (180°C).²⁴ However, permanent reduction in viscosity of greater than 50% have been observed while holding concentrated liquor at above 110°C for several hours.⁹ Other studies have shown that mild thermal treatments (e.g., holding 60% solids liquor at 120°C for 24 hours) have resulted in slight viscosity increases.¹⁴

Shear thinning behavior of high solids black liquors poses another handling concern for RFS operation. The liquor must be constantly circulated to prevent "setting up" at the greatly reduced shear conditions within a retention tank or isolated section of piping. Separation of precipitated inorganics will occur if liquor circulation is stopped. Constant circulation generating a shear rate of 100-1000 s⁻¹ should be sufficient to prevent pluggage of piping.⁶

D.5.4 Surface Tension

Surface tension significantly effects drop formation during spraying. Decreasing surface tension tends to increase spray angle from a pressure atomizing nozzle and reduce the median drop size produced.¹⁸ To evaluate potential spray nozzles for use in the RFS, the median drop size of a black liquor spray ($d_{vm,BL}$) from a given nozzle can be predicted from the manufacturer's test data (obtained with water) and the black liquor properties:

$$\frac{d_{vm,BL}}{d_{vm,w}} = \left(\frac{\sigma_{BL}}{73} \right)^{0.5} \left(\frac{\mu_{BL}}{1.0} \right)^{0.2} \left(\frac{\rho_{BL}}{62.4} \right)^{-0.3} \quad (3)$$

where:

$d_{vm,BL}$	=	volume (or mass) median drop diameter for black liquor
$d_{vm,w}$	=	volume (or mass) median drop diameter from test data for water
σ_{BL}	=	surface tension of black liquor (dyne/cm)
μ_{BL}	=	apparent viscosity of black liquor (cp)
ρ_{BL}	=	density of black liquor (lb/ft ³).

Black liquor surface tension at up to 71% solids and 120°C was measured at the University of Maine as part of a DOE contract. Krishnagopalan et al.²⁶ developed a maximum bubble pressure surface tensiometer/densitometer apparatus to overcome some of

the difficulties associated with measuring black liquor surface tension. A typical result is shown in Fig. D-5.

Other researchers' results (presented by Adams and Frederick⁶) show similar behavior up to 60% solids. The initial decrease in surface tension with increasing solids concentration is a result of an increasing concentration of surface active components (organic fragments and extractives).²⁶ At higher solids, the increase in surface tension brought about by the concentration of inorganics is greater than the decrease caused by the organics. Black liquor surface tension at greater than 75% solids has not been measured, but is not expected to exceed typical values for water.

Adams and Frederick⁶ point out that equilibrium measurements of black liquor surface tension are ten times longer than the time scale associated with black liquor drop formation. While the liquor spray is breaking up into drops, the constantly-renewed surface may keep the surface tension closer to that of water than the much lower equilibrium value. For this reason black liquor surface tension should be taken as 59 dyne/cm (the value of boiling water) in Eq. 3 to predict median drop size of a black liquor spray from water spray test data. In selecting nozzles for the RFS, it was assumed that $\sigma_{BL} = 70$ dyne/cm. The calculated median drop diameter is 8.9% larger than would be predicted with the recommended surface tension (59 dyne/cm). Correspondingly, the standard deviation of the drop size distribution is 4.4% higher. In modeling drop fate in the RFS, carryover decreases with increasing median drop size, but is greater for a broader drop size distribution. The effects of assumed surface

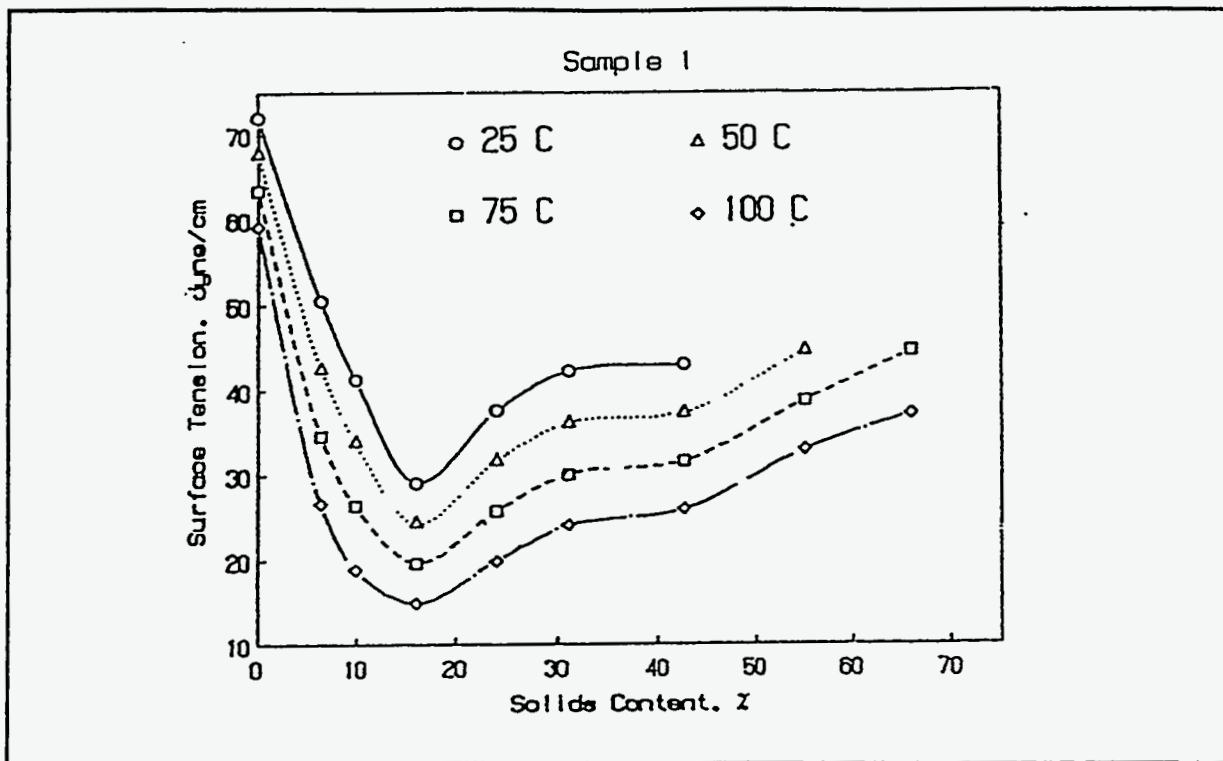

Figure 5. Surface tension of black liquor as a function solids content and temperature.²⁶

tension on drop size distribution parameters therefore tend to offset one another when modeling drop trajectories. Considering the uncertainty associated with predicting liquor viscosity, the error created by surface tension assumption is insignificant.

D-5.5 Density

Density of black liquor is an essential physical property for RFS design calculations and for mass and energy balances during operation. Frike and coworkers^{6,27} found that density at constant temperature was a linear function of solids content up to 50% and that density data taken at 77°F (25°C) could be fit with a single correlating parameter to account for variations in liquor composition. The effect of thermal expansion could be accounted for by a second empirical expression with two additional fitting parameters. Linear extrapolation of low solids data to 100% solids predicts a density approximately 10% higher than the theoretical value, estimated as a non-interacting mixture of the black liquor components.

Zaman et al.²⁷ recommend the following procedures for precise black liquor density measurements: absolute pycnometry for up to 60% solids; gas comparison pycnometry (a.k.a., helium density) for 60 to 100% solids (Micromeritics Model 1330 Accupyc); dilatometry (AOCS Method Cd 10-57) for thermal expansion measurements up to 85% solids and 100°C. There is some uncertainty as to how values of thermal expansion measured at a maximum of 212°F (100°C) can be extrapolated to actual firing temperatures of 230-300°F. This uncertainty may affect the calibration of on-line instrumentation.

Experimental measurement of density at 55-100% solids revealed there are two discontinuities in the density versus solids content curve (Fig. 6).²⁷ The slope change at approximately 65% solids represents the transition from an aqueous polymer solution to a polymer melt. The transition at approximately 80% solids (at 25°C) corresponds to an observed change in liquor behavior from a deformable fluid to a glassy substance which fractures under stress. The concentration at which the lower transition occurs shifts slightly to the right with a 75°C increase in liquor temperature. Work is underway at UF to further study these transitions and to extend black liquor density correlations to 80% solids.²⁷

Unlike viscosity, black liquor density is not strongly effected by pulping conditions. There is about a 5% density variation among liquor samples at 65% solids.²⁷ This suggests that a generalized correlation can be used for design calculations. Accordingly, a B&W standard correlation was used in RFS design. The predicted trend of density as function of solids content at 25°C is compared with measured values in Fig. 6. Agreement is excellent over the range from 50-80% solids; the estimated value at 100% solids is 12% higher than the experimental value.

After the liquor source is selected for the RFS combustion experiments, density at less than 50% solids can be correlated with solids content and temperature. Such a correlation

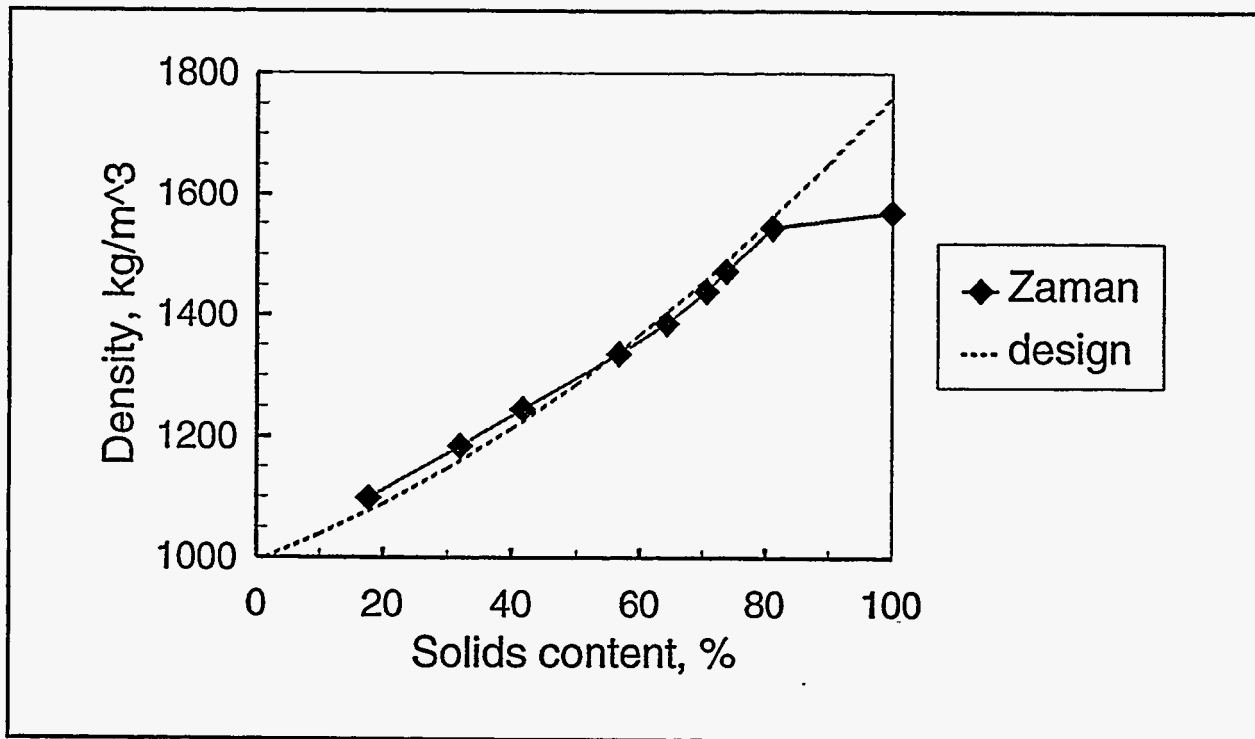

Figure 6. Density (at 25°C) of kraft black liquor as a function of solids content. Experimental data from Zaman and Frike.²⁷

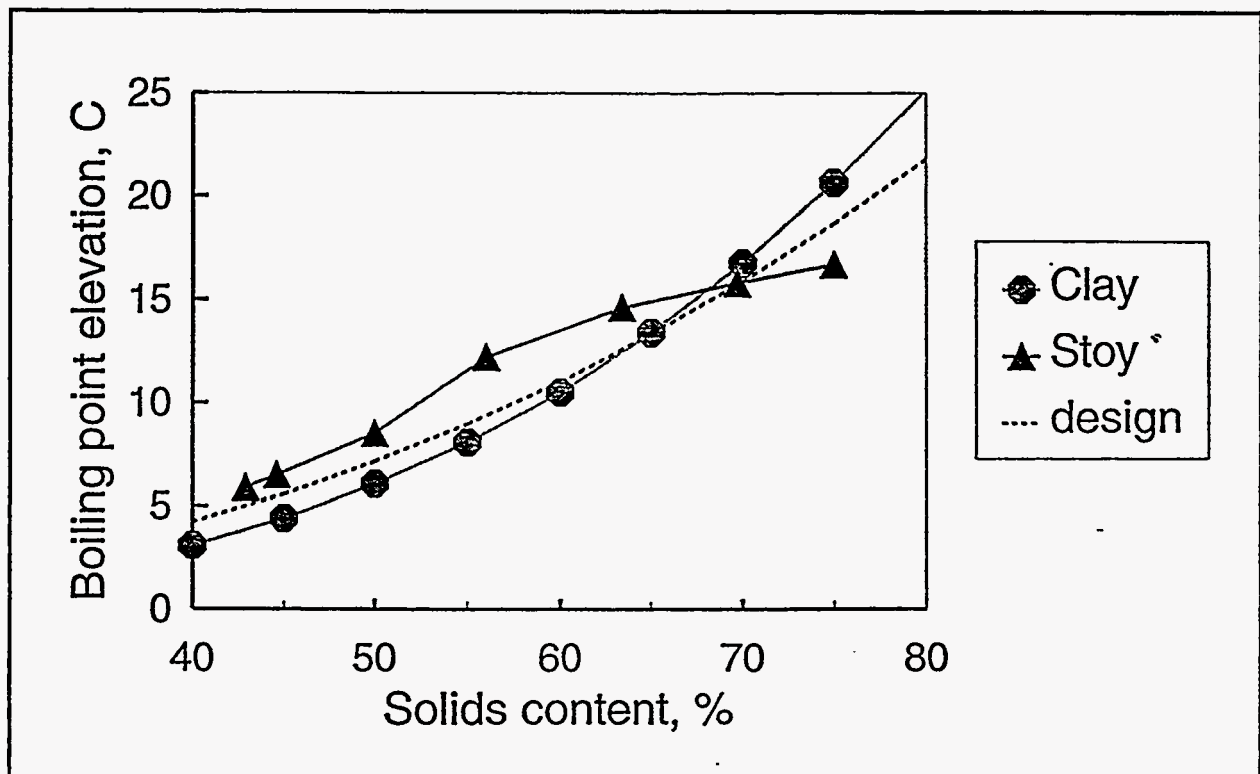

Figure 7. Black liquor boiling point elevation as a function of solids content. Experimental data from Clay and Grace²⁹ and Stoy et al.²⁸

will be used for feed system and concentration equipment control algorithms and data acquisition calculations. The low solids correlation will require only one precise density measurement and one precise thermal expansion measurement.²⁷ A methodology for developing high solids density correlations should be available by the time our test program is underway. Ideally an on-line sensor will be used to constantly monitor fired liquor density.

D-5.6 Boiling Point Elevation

The boiling point of black liquor is an important physical property for the design and operation of concentration equipment. Boiling point was required as input to energy balances to estimate the drying time of black liquor drops in the RFS. This drying time set the elevation of the liquor spray nozzle in RFS design.

Recent work at UF has utilized a pseudoequilibrium still to characterize boiling point elevation (BPE) as a function of solids content and pressure up to 85% solids.²⁸ This method reduces the measurement errors associated with other techniques used to report earlier results.⁶ The variation of the new data with solids content differs from that reported previously in that there is an inflection point at approximately 50% solids. Figure 7 compares a typical set of softwood liquor data reported by Stoy et al.²⁸ with that of Clay and Grace²⁹ (an example of the older measurements).

Boiling point elevation is significantly affected by black liquor composition and the effect increases with increasing solids content.²⁸ It has been suggested that the liquor-specific dependance is related to the inorganic composition of the black liquor,⁶ but a satisfactory correlation has yet to be developed. For simplicity a non-linear fit of commercial data was utilized for estimating BPE in RFS design calculations. The predicted trend of BPE with solids content is also plotted in Fig. 7. Over the nominal operating range of 65-75% solids, there is agreement within 10% between the correlation and the published data.

D.6 CONCLUSION

Liquor spray drop size distribution is a critical variable affecting RFS design and operation. The drop size distribution is affected by fired liquor viscosity, surface tension, and density. Of these only density can be confidently predicted at 65-75% solids. Considering the tremendous variability in black liquor viscosity and the uncertainty of the true value of surface tension, the commercial boiler design correlations are expected to provide adequate estimates for RFS design purposes. Within the range of nominal operation, the field-proven correlations for viscosity and density are consistent with available literature information. The RFS was designed to allow adjustment of equipment (nozzle type, spray elevation) or process conditions (firing temperature, thermal treatment) to compensate for variations in liquor properties from the source mill. The planned Phase II test program includes work to adequately determine the properties of the test liquor before completing the final design. Liquor property tests during the test program in Phase III should assure that variations in liquor properties are known so that the impact on test results can be considered.

APPENDIX E

ADVANCED COMBUSTION DEVELOPMENT - TEST PLANS

(THIS PAGE LEFT INTENTIONALLY BLANK)

TABLE OF CONTENTS

<u>Section</u>	<u>Page</u>
LIQUOR AND SPRAY TESTS.....	E-1
Purpose of Liquor Properties Characterization.....	E-1
Purpose of Atomization Tests (Test Series: E.2).....	E-1
Purpose of Liquor Combustion Characterization (Test Series E.3).....	E-2
TEST SERIES E.1 - LIQUOR PROPERTIES CHARACTERIZATION.....	E-4
Test E.1.1 Screen Mill Liquor for Excessive Viscosity.....	E-4
Objective.....	E-4
Procedure.....	E-4
Data recorded by data acquisition system (DAS).....	E-4
Data recorded from off-line measurements.....	E-5
Visual observations.....	E-5
Sample analysis (off-line).....	E-5
Performance calculations.....	E-5
Test E.1.2 Liquor Preparation.....	E-6
Objectives.....	E-6
Procedure.....	E-6
Data recorded by DAS.....	E-7
Data recorded from off-line measurements.....	E-7
Visual observations.....	E-7
Sample analysis (off-line).....	E-7
Performance calculations.....	E-7
Test E.1.3 Liquor Physical Properties.....	E-8
Objectives.....	E-8
Procedure.....	E-8
TEST SERIES E.2 - ATOMIZATION TESTS.....	E-9
Test E.2.1 - Nozzle for Nominal Operation.....	E-9
Objective.....	E-9
Procedure.....	E-9
Data recorded by DAS.....	E-10
Data recorded from off-line measurements.....	E-10
Visual observations.....	E-10
Sample analysis (off-line).....	E-10
Performance calculations.....	E-10

TABLE OF CONTENTS (continued)

<u>Section</u>	<u>Page</u>
Test E.2.2 - Nozzle for High Solids Operation.....	E-11
Objectives.....	E-11
Procedure.....	E-11
Data recorded by DAS.....	E-11
Data recorded from off-line measurements.....	E-11
Visual observatins.....	E-11
Sample analysis (off-line).....	E-11
Performance calculations.....	E-11
 TEST SERIES E.3 - LIQUOR COMBUSTION CHARACTERIZATION.....	 E-12
Objectives.....	E-12
Procedure.....	E-12
Data recorded by DAS.....	E-13
Data recorded from off-line measurements.....	E-13
Visual observations.....	E-13
Sample analysis (off-line).....	E-13
Performance calculations.....	E-13
 RECOVERY FURNACE SIMULATOR OPERATION TESTS.....	 E-15
 TEST SERIES E.4 - SHAKEDOWN TESTS.....	 E-15
Test No. E.4.1.....	E-15
Objectives.....	E-16
Procedure.....	E-16
Data recorded by DAS.....	E-17
Visual observations.....	E-17
Sample analysis (off-line).....	E-18
Performance calculations.....	E-18
Test No. E.4.2.....	E-18
Objectives.....	E-18
Procedure.....	E-19
Data recorded by DAS.....	E-19
Data recorded from off-line measurements.....	E-19
Sample analysis (off-line).....	E-19
Performance calculations.....	E-20

TABLE OF CONTENTS (continued)

<u>Section</u>	<u>Page</u>
Visual Observations.....	E-20
Test No. E.4.3.....	E-20
Objectives.....	E-20
Procedure.....	E-20
Data recorded by DAS.....	E-21
Data recorded from off-line measurements.....	E-21
Visual observations.....	E-21
Sample analysis (off-line).....	E-21
Performance calculations.....	E-21
Material evaluation.....	E-22
Test No. E.4.4.....	E-22
Objectives.....	E-22
Procedure.....	E-23
Data recorded by DAS.....	E-23
Visual observations.....	E-23
Data recorded from off-line measurements.....	E-23
Sample analysis (off-line).....	E-23
Performance calculations.....	E-24
Test No. E.4.5.....	E-24
Objectives.....	E-24
Procedure.....	E-24
Data recorded by DAS.....	E-25
Data recorded from off-line measurements.....	E-25
Sample analysis (off-line).....	E-25
Visual observations.....	E-25
Performance calculations.....	E-25
Test No. E.4.6.....	E-26
Objectives.....	E-26

TABLE OF CONTENTS (continued)

<u>Section</u>	<u>Page</u>
TEST SERIES E.5 - BASELINE CHARACTERIZATION TESTS.....	E-27
Purpose.....	E-27
Procedure.....	E-27
Test Matrix.....	E-28
Objectives.....	E-28
Test Group No. 1.....	E-28
Test Group No. 2.....	E-28
Test Group No. 3.....	E-28
Test Group No. 4.....	E-28
Data recorded by DAS.....	E-30
Data recorded from off-line measurements.....	E-31
Visual observations.....	E-31
Additional data.....	E-31
Sample analysis (off-line).....	E-31
Performance calculations.....	E-32
TEST SERIES E.6 - HIGH SOLIDS LIQUOR IN BASE UNIT.....	E-33
Purpose.....	E-33
Procedure.....	E-33
Test matrix.....	E-34
Objectives.....	E-36
Test Group No. 1.....	E-36
Test Group No. 2.....	E-36
Test Group No. 3.....	E-36
Test Group No. 4.....	E-37
Data recorded by DAS.....	E-37
Visual observations.....	E-38
Additional data.....	E-38
Sample analysis (off-line).....	E-38
Performance calculations.....	E-39
REFERENCES.....	E-40
ATTACHMENT 1.....	E-1.1
Atomization Facility.....	E-1.2
Malvern 2600 Particle Sizer.....	E-1.3

TABLE OF CONTENTS (continued)

<u>Section</u>	<u>Page</u>
ATTACHMENT 2.....	E-2.1
ATTACHMENT 3.....	E-3.1
Part 1: Black Liquor Analysis.....	E-3.2
Solids.....	E-3.2
Gross Heating Value.....	E-3.2
Ultimate Analysis - Elemental.....	E-3.2
Carbon and Hydrogen.....	E-3.2
Nitrogen.....	E-3.3
Sulfur.....	E-3.3
Chlorine.....	E-3.3
Sodium and Potassium.....	E-3.3
Inerts.....	E-3.3
Oxygen.....	E-3.4
Part 2: Smelt Analyses.....	E-3.4
Sodium Carbonate.....	E-3.4
Sodium Hydroxide.....	E-3.4
Sodium Sulfide.....	E-3.4
Sodium Thiosulfate.....	E-3.4
Sodium Sulfite.....	E-3.5
Sodium Hydrosulfide.....	E-3.5
Total Sulfur.....	E-3.5
Sulfate Sulfur.....	E-3.5
Chlorine.....	E-3.5
Sodium and Potassium.....	E-3.5
Carbon.....	E-3.5
Reduction and Sulfidity.....	E-3.6

LIST OF TABLES

<u>Table</u>		<u>Page</u>
1	Samples Required for Liquor Analysis and Combustion Tests.....	E-7
2	Test Plan for Test E.5; Detailed Characterization Tests.....	E-29
3	Test Plan for Test E.6; High Solids/High Heat Input Base Unit Tests.....	E-35
E.1-1	Atomization Facility Equipment and Capabilities.....	E-1.6
E.2-1	Black Liquor System.....	E-2.2
E.2-2	Air System.....	E-2.3
E.2-3	Flue Gas System.....	E-2.4
E.2-4	Miscellaneous Instruments.....	E-2.5

LIST OF FIGURES

<u>Figure</u>		<u>Page</u>
E.1-1	Arrangement of Atomization Facility.....	E-1.4
E.1-2	Malvern 2600 Particle Sizer.....	E-1.5

APPENDIX E. ADVANCED COMBUSTION DEVELOPMENT - TEST PLANS

The test plans that have been developed for all tasks in Phase II and Phase III are presented in this Appendix. By preparing the test plans at this point we have assured that the appropriate support tests have been considered and that adequate instrumentation and controls are included in the equipment design. The test plans are laid out in an orderly manner so that the support test results are available before the combustion tests in the RFS commence.

LIQUOR AND SPRAY TESTS

This section describes the experimental program required to support the design, modeling, and operation of the RFS. The test plans are presented in logical order, i.e., black liquor viscosity measurements must be made before atomization studies can begin, and specification of drop size for single-drop combustion tests depends on the outcome of the atomization studies.

Purpose of Liquor Properties Characterization (Test Series: E.1):

Professor Arthur Frike and associates at the University of Florida (UF) have extensively studied black liquor physical properties.¹ These studies reveal significant variations in black liquor physical properties, particularly viscosity, with wood species and pulping conditions. The published results were therefore deemed suitable for preliminary RFS design. Experimental characterization of high solids black liquor, originally planned as a Phase I activity, was deferred until Phase II, after the liquor supply source has been identified. Viscosity and density measurement of the selected liquor are required to verify design assumptions as well as for inputs to the atomization studies and numerical modeling activities.

Prior to combustion tests in the RFS, density correlations must be generated for process control algorithms, and viscosity correlations are needed for predicting liquor behavior as a function of firing conditions. It will be necessary to run a viscosity check on arriving liquor shipments, because process upsets at the mill could result in different viscosity behavior. After a database of liquor properties from the source mill has been established, it will be easy to detect variances and take measures to maintain uniform feed to the RFS. This approach will assure that any impact of variations in liquor properties or tests are minimized so that results may be more clearly interpreted.

Purpose of Atomization Tests (Test Series: E.2):

A standard black liquor splash plate nozzle will not work in the small cross section of the RFS. The preliminary design phase of this project identified a commercial nozzle that should produce a spray pattern that puts most of the liquor on the bed without excessive carryover or wall deposition. Design calculations estimate that the drop size distribution will

be small enough to achieve a degree of in-flight liquor drying similar to that in a commercial unit.

Atomization variables (nozzle type, orifice size, liquor pressure, and temperature) strongly affect combustion stability and furnace operation. While it is not the intent of this program to develop a new atomization technology, a number of screening tests of commercial nozzles must be conducted before combustion tests commence in the RFS. These out-of-furnace tests will be conducted in an existing atomization test facility using an unheated fluid to simulate the viscosity of hot as-fired black liquor at 65-75% solids content. Out-of-furnace nozzle tests will allow evaluation of spray pattern and drop size distribution, important parameters for controlling the char bed size and shape. Adequate in-furnace performance of the selected nozzle will then be evaluated during shake down testing. Adequacy is defined as no pluggage of the spray nozzle, no excessive carryover, and no bed blackouts.

One objective of this research program is to move rapidly from characterizing baseline performance of the RFS at nominal solids contents to developing advanced combustor designs for high solids liquors. Additional atomization tests will be required to determine if the nozzle chosen for 65-75% solids operation is suitable for spraying greater than 80% solids black liquor.

Purpose of Liquor Combustion Characterization (Test Series: E.3):

Bench-scale tests are necessary for characterizing the combustion behavior of the selected black liquor prior to pilot-scale combustion tests in the RFS. Experimental measurement of characteristic combustion times will be useful for setting spray nozzle height and will provide validating data for numerical model predictions. A comparison of single drop burning behavior over a range of solids contents will suggest how RFS performance would be affected by increasing solids content, e.g., an increase in swelling at higher solids will produce a lower density char that could result in more suspension burning and carryover.

The Institute of Paper Science and Technology (IPST) was identified as a subcontractor for characterizing liquor combustion in Phase II of the High Solids Black Liquor Firing program (as proposed to USDOE in 1992). The large black liquor furnace at IPST, originally considered for the subcontract services, has not been operated for 3-4 years. A significant cost and effort would be required to prepare this equipment to satisfy B&W's current technical needs.

There is a single, captive-drop furnace at IPST which could be used to obtain meaningful results at a much lower cost. Characteristic combustion times can be measured from video analysis of single drops, exposed to simulated combustion atmospheres. Additionally, video images can be analyzed to determine extent of liquor swelling during combustion.

Given these experimentally-determined combustion characteristics, B&W's detailed drop combustion model² would be used to estimate the rates of various combustion processes (drying, devolatilization, char burning) for our chosen liquor. These predictions can be validated by experimental measurement of drop temperature and off-gas analysis during the captive-drop combustion tests.

TEST SERIES E.1 - LIQUOR PROPERTIES CHARACTERIZATION

Test E.1.1 Screen Mill Liquor for Excessive Viscosity

Viscosity of high solids black liquor may be a deciding factor in choosing the liquor supply mill. The general goal of this test is to screen liquor samples from the candidate mill for unusually high viscosity before the commitment to the supplier mill is made.

It is important to select the liquor source early in Phase II because viscosity and density measurement of the selected liquor are required as inputs to the atomization studies and numerical modeling activities. The concentrator vendor will also require liquor samples for equipment design.

Objective:

Identify potential problems with handling high solids liquor from the candidate supply mill.

Procedure:

The prospective mill will send a 5 liter sample at approximately 50% solids. This sample should be drawn from the same location in the process from which the liquor tank trucks will be filled.

A liquor sample will be concentrated to 80% solids at ARC in laboratory batch evaporation equipment. Because of the limited capacity of the evaporator relative to the viscometer, several batches will be required for each viscometer run.

Measure apparent viscosity versus shear rate of each high solids sample at a realistic firing temperature. If the viscosity at 80% solids is unexpectedly high, an alternate candidate mill will be considered.

Data recorded by data acquisition system (DAS):

Each rheology test is performed by linearly accelerating from zero to the maximum set shear rate in 4 minutes, holding the maximum shear rate for 1 minute, and then decelerating back to zero in 4 minutes. For each rheology test, the DAS will generate a curve of apparent viscosity (expressed in mPa·sec) versus shear rate (expressed in reciprocal seconds). The liquor temperature, held constant by the viscometer jacket, is measured by a thermocouple in the liquor and recorded by the DAS.

Data recorded from off-line measurements:

Process conditions and sampling location from source mill.

Visual observations:

Unusual behavior of liquor during concentration.

Sample analysis (off-line):

Liquor solids content, before and after concentration.

Performance calculations:

The experimental data, apparent viscosity and shear rate, are curve fit to an Ostwald (Power Law fluid model) Equation by the DAS. The Ostwald equation:

$$y = a*x^b$$

where:

y = shear stress (τ), expressed in dynes/cm²

a = consistency index. Analogous to the viscosity of a Newtonian fluid (@ 1 sec⁻¹ shear rate) and similarly enables quantitative comparison of the consistency of fluids having identical flow-behavior indexes.

x = Shear rate, expressed as sec⁻¹

b = flow-behavior index;

= 1 for a Newtonian fluid; <1 for a pseudoplastic fluid
defines the apparent viscosity (μ_a) at a specified shear rate

where $\mu_a = a/x^{(1-b)}*10^3$, expressed in mPa \cdot sec

The DAS also determines the correlation coefficient, R², which evaluates the fit of the experimental data with the a and b values used in the Ostwald equation.

The apparent viscosity of different liquors at a given shear rate, the consistency index, and flow-behavior index can be compared.

Test E.1.2 Liquor Preparation

It is very important to obtain a representative sample of the supply mill's black liquor. The goal of this "test" is to prepare a homogeneous composite sample for all subsequent liquor properties, analysis, and combustion tests.

Objectives:

1. Specify liquor sampling conditions for selected supply mill.
2. Prepare homogenous composite sample of mill liquor.
3. Divide sample into separate lots for test various procedures.

Procedure:

In order to reduce the effect of transient process upsets, a series of samples should be taken from the mill over a number of days and sent to our laboratories for homogenization and bottling for the various tests. The mill should provide an appropriate port to safely draw samples from the same location in the process from which the liquor tank trucks will be filled.

Four one liter samples of nominal 50% solids liquor should be drawn during the day shift for 10 days. The wide mouth HDPE sample bottles should be filled completely and tightly sealed. Detailed sampling procedures will be provided to the mill. Refrigeration prior to shipment is desirable but not necessary. All samples should be shipped together. A daily sample should be delayed or skipped altogether if there is an unusual process disturbance (e.g., evaporator boil outs, or failure of the soap-skimming equipment) within several hours prior to the designated sampling time. Due to the potential impact of changes in species of the incoming wood, a mill that uses essentially hardwood only or softwood only will be sought as the liquor supplier.

The complete set of liquor samples (40 liters) will be composited at ARC in a manner that minimizes evaporation, loss of volatiles, and oxidation. Approximately half of the as-received daily sample will be composited on an equal weight basis. A 5 liter sample of the composite as-received sample will be sent to the chosen concentrator vendor for evaluation of thermal properties required for concentrator design. The remaining samples of as-received and composited liquor will be retained as backup.

The elemental analysis, solids content, and higher heating value (Btu/lb) will be determined by ARC on the composite sample. These values will serve as reference values for later tests.

A 5 liter portion of the composited sample will be sent to Arthur Frike's liquor characterization laboratory at UF for concentration and detailed characterization (described later). It will be possible to extract 100 ml portions of liquor from their laboratory evaporator at various solids contents (e.g., 65, 70, 75, 80, 85%) for our combustion characterization tests. This will avoid some duplication of laboratory work.

Individual sample containers will be filled with liquor for analysis and combustion tests according to Table 1.

Data recorded by DAS:

N/A

Data recorded from off-line measurements:

N/A

Visual observations:

Unusual behavior of liquor.

Sample analysis (off-line):

Liquor solids content, elemental analysis, and heating value of composited as-received liquor sample.

Performance calculations:

N/A

Table 1. Samples Required for Liquor Analysis and Combustion Tests.

Procedure	Test plan	Solids, %	Sample size, ml	No. of samples
Physical properties	E.1.3	50	1000	2
Ultimate analysis	E.3	50	100	2
Burning profile	E.3	70, 80	100	4
Single-drop combustion	E.3	70, 75, 80, 85	100	8

Test E.1.3 Liquor Physical Properties

The goal of this test is to make carefully-controlled measurements of the selected liquor's apparent viscosity and density at nominal firing temperature over a range of solids contents for design validation and spray test/modeling inputs. Additional measurements will allow generation of density and viscosity correlations for process control algorithms, prediction of spray behavior and quality control on liquor shipments.

A full thermal characterization of the black liquor as function of solids content will be required for pilot concentrator control algorithms and for accurate energy balances around the RFS.

Objectives:

1. Determine black liquor density at nominal firing temperatures for 50 to 85% solids content.
2. Develop density correlation for chosen liquor as functions of solids content and firing temperature.
3. Define rheological behavior of black liquor at nominal firing temperature for 50 to 85% solids.
4. Develop viscosity correlation for chosen mill liquor as a function of solids, firing temperature, and shear rate.
5. Determine boiling point elevation, heat of combustion, and enthalpy-concentration relationships at nominal firing temperature for 50 to 85% solids.

Procedure:

B&W will subcontract detailed physical and thermal characterization to Professor Arthur Frike and associates at UF. Their laboratory is fully equipped to make the necessary measurements, and they have the expertise to promptly generate the desired viscosity and density correlations.

Because the UF research program in black liquor properties is largely funded by USDOE, details of the UF equipment, experimental procedures, and performance calculations are described in a series of reports by Dr. Arthur Frike to USDOE.

TEST SERIES E.2 - ATOMIZATION TESTS

Test E.2.1 - Nozzle for Nominal Operation

The BETE[®] Maximum Free Passage (MP) nozzle can theoretically produce an optimum drop size distribution at relatively low spray exit velocity. The overall goal of this test is to recommend the proper size of BETE[®] nozzle for use in the shakedown and baseline testing of the RFS at nominal 70% solids operation.

Objectives:

1. Quantify drop size distribution and spray pattern for commercially available candidate nozzles for RFS.
2. Select nozzle orifice to give desired drop size for firing nominal 70% solids liquor.

Procedure:

Evaluation of black liquor spray nozzles for the RFS will be performed in the ARC's Atomization Facility. The facility is equipped with laser-based instrumentation for measuring droplet sizes, and has liquid flow capabilities to about 16,000 lb/hr. A complete description of the facility is given in Attachment E-1 of this Appendix.

Site preparation will be performed on the Atomization Facility and will include miscellaneous piping changes, setup of the Malvern Particle Sizer, mass distribution measurement equipment, fluid loading, and system checkout. Following completion of the testing, the facility will be returned to its original state.

The receiving optics for the Malvern Particle Sizer will be changed to allow measurement of larger drops. The modified system will enable measurements of drops in the range of about 0.11 mm to 11.3 mm. This setup has been used previously for black liquor spray testing.³

The atomization fluid will be chosen to reproduce the black liquor viscosity (from Test E.1.3) at 70% solids. This fluid will either be diluted black liquor at room temperature or a model fluid system such as glycerine and water. About 800 gallons of the test fluid will be used for the spray testing.

Four to six candidate nozzles (about 2.6 gpm water capacity) with various orifice sizes and spray angles will be purchased. In order to predict the spray quality and flow behavior, each atomizer will be characterized using a predetermined test matrix to cover the range of conditions expected in the pilot tests. The process variables will include nozzle pressure and fluid flow rate.

The nozzles will be securely mounted in the spray booth with the spray directed horizontally. Shielding will be used if needed to control the quality of the spray in the measurement region. Drop size measurements will be made far enough downstream of the atomizer so that the droplet formation is complete.

Runs will also be made at one flow condition for each test atomizer to determine the variation in spray quality as a function of vertical position in the spray. Physical properties of the test fluid will be monitored periodically throughout testing so that any changes can be detected and corrected.

Data recorded by DAS:

Malvern particle sizer output: fraction of drops in various size categories. Size distribution calculations as described below. Primary system pressures and flows.

Data recorded from off-line measurements:

N/A

Visual observations:

Spray angle and pattern, quality of atomization.

Sample analysis (off-line):

Viscosities of model fluids before and after tests.

Performance calculations:

Size distribution data will be fit to a square-root-normal function to determine the mass (or volume) median drop diameter and normalized standard deviation for all nozzles tested.

Median drop size, spray mass distribution and, spray angle will be plotted against flow conditions, and nozzle specifications.

Predicted median drop size (used in design calculations) will be compared to measured.

Nozzle flow versus pressure drop will be compared to manufacturers' flow curves.

Test E.2.2 - Nozzle for High Solids Operation

The overall goal of this test is to recommend the best nozzle for high solids firing in the RFS.

Objectives:

1. Quantify effect of solids (viscosity) on drop size distribution and spray pattern for commercially available candidate nozzles for RFS.
2. Select nozzle to give desired drop size for firing high solids (80%) liquor.

Procedure:

General test procedures are described in Test No. E.2.1. To simulate higher solids liquor, a more concentrated atomization fluid will be chosen to reproduce the black liquor viscosity (from Test No. E.1.3) at 80% solids.

It is expected that a larger flow opening and spray angle will be required to achieve desired atomization at higher viscosities. Based on the results of Test No. E.2.1, approximately four nozzles will be evaluated. At least one nozzle from Test No. E.2.1 will be evaluated at higher viscosity. If the BETE[®] MP nozzle fails to provide adequate atomization, it may be necessary to evaluate a different type of nozzle or commercially available atomization technology.

The conditions of the test matrix for evaluating spray quality and flow behavior may have to be adjusted to accommodate the higher viscosity fluid (i.e., higher nozzle pressures may be required to achieve atomization).

Data recorded by DAS: See Test No. E.2.1.

Data recorded from off-line measurements: See Test No. E.2.1.

Visual observations: See Test No. E.2.1.

Sample analysis (off-line): See Test No. E.2.1.

Performance calculations:

In addition to results described in Test No. E.2.1, drop distribution and spray pattern results from one nozzle will be compared at different viscosities.

TEST SERIES E.3 DROP COMBUSTION CHARACTERIZATION

The goal of this bench-scale test program is to characterize the combustion properties of the selected black liquor prior to pilot-scale tests in the RFS. A combination of video analysis of black liquor combustion in the IPST captive-drop furnace and in-house fuel analysis offers a cost-effective means of characterizing black liquor combustion behavior.

Objectives:

1. Estimate drying time for median size black liquor drop to verify RFS design assumptions and set initial gun height in shakedown tests.
2. Provide numerical modeling inputs: liquor analysis, volatiles yield, characteristic combustion times, and swelling factors for chosen black liquor at 70 and 80% solids.
3. Determine drying, devolatilization, and char burning rates to predict performance of RFS as liquor content is increased from 70 to 85% solids.

Procedure:

A standard ultimate analysis of the composited as-received liquor will be conducted in the ARC Analytical Chemistry laboratories. This analysis includes determination of solids content, heating value and the following major elements: C, H, O, N, S, Cl, Na, K. The amounts of volatiles and fixed carbon in the black liquor will be determined by thermogravimetric analysis (TGA) by heating 300 mg samples of liquor at 70 and 80% solids at 15°C/min in air.

A qualitative assessment of liquor swelling can be made by placing a fixed amount of black liquor solids in a ceramic crucible and heating to 600°F (315°C) in 100°F increments over one hour. The sample is then held at 600°F for one hour, removed from the muffle furnace and allowed to cool. The extent of swelling is determined by comparison with an established database of liquor swelling behavior.

Single-drop determinations of characteristic combustion times and swelling history for the selected liquor should be subcontracted to IPST. These measurements would be made in a captive-drop experimental apparatus described elsewhere.⁴ Single drops of black liquor at four solids contents (concentrated by UF) will be exposed to simulated combustion atmospheres and the combustion processes will be recorded on video tape for subsequent analysis. Drop temperature and off-gas analysis for CO and CO₂ may also be monitored.

The specified drop size at each solid content will be taken as the median drop size determined from the atomization studies. Five individual drops at each solids content will be exposed to two different simulated combustion atmospheres, e.g., nitrogen at 1700°F and 10% O₂ in N₂ at 1500°F. The gas flow rate will be set to produce a realistic slip velocity; this

Coalescence of a smelt bead denotes the start of smelt oxidation. Visible cooling of the smelt marks the end of drop combustion.

Swelling behavior is characterized by plotting drop volume, estimated from projected area on video images, as a function of exposure time. Swollen volume should be normalized by initial mass of liquor solids according to Frederick et al.⁵ The maximum swollen volumes from the captive-drop experiments will be compared to qualitative determinations from the ARC laboratory.

Plots will be prepared of CO/CO₂ production and particle temperature versus exposure time. The resulting CO/CO₂ release curves are indicative of devolatilization rates.

RECOVERY FURNACE SIMULATOR OPERATION TESTS

This section describes the experimental program to be carried out on the Recovery Furnace Simulator once construction is complete. The program consist of three parts; the initial shakedown of the equipment in Phase II and in Phase III characterization of the RFS to compare it with commercial operating conditions and operation of the facility at high solids conditions.

TEST SERIES E.4 SHAKEDOWN TESTS

Purpose:

A series of short-term tests will be carried out at the completion of the RFS construction phase to verify that the system operates as designed.

During this shakedown phase, the RFS will be operated approximately every other day. Each operating day will include a start up period, a test period, and a shutdown, char bed burnout period. The intervening, non-firing days will be devoted to modifications and repairs as required.

Prior to testing, the RFS will be put into service by running air and water through the system.

Operating procedures for startup, normal shutdown and emergency shut down will be written, including procedures to ensure that water is not inadvertently introduced via the liquor gun. Cold testing will be used to evaluate and verify acceptability.

Water (but not liquor) will be circulated through all black liquor lines to ensure that the pumps run, valves operate correctly and that all instruments are in service. All instruments will be calibrated. The concentrator will be operated on water with steam to the heater.

Natural gas will be burned in the furnace to cure the refractory and to ensure that all the air/flue gas system components, including instrumentation, are operating properly. The baghouse pulse jet (for cleaning the bags) and ash handling systems will be tested. The smelt conveyor system will be run empty to ensure it is operational.

Test No. E.4.1:

The overall goal of this first shakedown test is to get all the pieces of equipment on-line and working together as a system.

Objective:

1. Commission and achieve stable operation of the black liquor concentrator.
2. Commission the black liquor delivery system and achieve controlled liquor flow to the furnace.
3. Burn liquor to produce smelt with reducing conditions in the lower furnace.
4. Commission smelt handling system.
5. Checkout the data acquisition system (DAS) and calculation procedures with actual test data.

Procedure:

The concentrator will be filled with feed liquor (nominal 50% solids), circulation pump started, steam flow and condensor cooling water flow started. When the liquor concentration reaches 65%, liquor flow to the pressurized flash tank will be started. Throughput will be set at 1 gpm. When the level in the tank is sufficient to operate the pump, liquor will be circulated through the instrument loop. Air flow to the recovery furnace will be established at about 600 cfm through all three air zones. Natural gas flow will be established at about 48 scfm (3 million Btu/hr heat input) through both burners in the secondary air ports. When the flue gas temperature leaving the furnace has reached a steady state value and the feed tank level has reached about 100 gallons, liquor will be sent to the furnace. A BETE[®] spray nozzle, selected in Test E.2.1, will be used to spray the liquor into the furnace to achieve drying in flight over the bed. As the liquor begins to burn, the natural gas flow will be reduced to maintain the total heat input in the 3 to 4 million Btu/hr range. The smelt casting machine will be started and the water sprays turned on. The baghouse pulse jet cleaning and hopper discharge systems will be turned on. This test will be terminated after a steady smelt flow is established. Liquor flow to the concentrator will be shut off, but liquor flow to the furnace will continue to reduce the concentrator tank inventory. Liquor flow to the furnace will then be shut off and the bed burned down with natural gas. The residual liquor in the concentrator and flash tank will be diluted to about 50% and pumped back to the feed liquor tank. If the idle interval is short (1-2 days), dilute liquor may be retained and circulated in the concentrator and flash tank.

At least two identical nozzles will be available during each planned combustion trial. These must be plumbed to allow rapid exchange due to the potential for unexpected pluggage.

Data recorded by DAS

1. Concentrator: Liquor flow to and from concentrator
Product liquor density
Circulation rate
Liquor temp to and from concentrator and in body
Liquor density in circulation line
Plant steam flow and steam chest pressure
Cooling water flow, and temp in and out of condenser
Process condensate flow & temperature from condenser
Conductivity of process condensate
Condenser pressure
2. Furnace: Liquor flow, temperature and pressure at nozzle
Solids, density and viscosity in liquor circulation loop
Air flow, temperature and header pressure for each zone
Natural gas flow to auxiliary burners
Natural gas flow to the smelt zone burner
Flue gas temperature leaving furnace, tube bank and boiling water heat exchanger (BWHX)
Gas composition leaving tube bank: O₂, CO₂, SO₂, CO, NO_x
3. Smelt System: Conveyor speed
Cooling water flow
4. Baghouse: Pressure drop
5. Water Jacket: Feed water flow
Blowdown flow and temperature

Note: A list of the instruments used to measure and control the system is found in Attachment 2.

Data recorded from off-line measurements:

Approximate smelt flow: Number of ingots and weight of selected representative ingots
Baghouse catch flow: Total weight of dust collected

Visual observations:

Bed height and shape
Relative quantity of carryover (i.e. "sparklers") in top of furnace

2. Burn 68 to 70% solids black liquor at the design heat input rate of 6 to 6.2 million Btu/hour under reducing conditions in the lower furnace.
3. Evaluate the performance of the BETE[®] spray nozzle.
4. Achieve bed burning with minimum carryover or suspension burning.
5. Reduce or eliminate supplementary fuel flow.
6. Analyze non-condensable gas (NCG) from concentrator for sulfur compounds to determine if this is a potential problem area.
7. Commission the bed camera and record bed characteristics and temperatures.

Procedure:

The concentrator will be brought on line as in Test No. E.4.1. The pressurized fuel feed tank and instrument loop will also be brought on line when the liquor concentration reaches about 68% solids. Liquor will then be sent to the preheated furnace. As the liquor begins to burn and a bed is established, the liquor flow will gradually be increased to about 2 to 2.5 gpm while the gas flow is reduced to maintain the total heat input in the 5 to 6 million Btu/hr range. A BETE[®] spray nozzle will be used to spray the liquor into the furnace to achieve in flight drying over the bed. Air flow distribution will be adjusted to cause combustion to occur as low as possible in the furnace. When a stable bed has been achieved, the natural gas flow will be reduced to a minimum level. Total air flow will also be reduced to hold flue gas oxygen at 2 to 3% (dry basis).

Data recorded by DAS:

See Test No E.4.1.

Bed characteristics as seen by bed camera during assumed steady state periods. (Tape saved for later comparisons.) Bed temperature via bed camera.

Data recorded from off-line measurements:

See Test No E.4.1.

Sample analysis (off-line):

See Test No 1 for liquor, dust and solids.

Process condensate from the concentrator condenser will be periodically sampled and analyzed for sodium, sulfur and total organics. The NCG stream will be drawn through a

condenser and bubbler train to absorb any sulfur compounds. Sampling this stream will require some method development since it will be almost entirely steam at near atmospheric pressure.

Performance calculations:

See Test No E.4.1.

Visual observations:

Bed height and shape
Relative quantity of "sparklers" in upper furnace.

Test No. E.4.3:

The general objective of this shakedown test is to preliminarily screen the influence of liquor temperature and spray nozzle type on the performance of the RFS.

Objectives:

1. Produce and burn 68 to 70% solids black liquor at the design heat input rate of 6.0 to 6.2 million Btu/hour (flow rate of 2.3 gpm).
2. Determine the optimum liquor firing temperature.
3. Achieve bed burning (as opposed to in flight burning with high carryover) under reducing conditions in the lower furnace.
4. Evaluate the effect of nozzle height (high and low position) on combustion performance.
5. Visually evaluate the performance of an alternate spray nozzle.
6. Determine optimum smelt sampling location (spout vs end-of-conveyor).

Procedure:

The concentrator, fuel feed tank, and furnace will be brought on-line as in Test No. E.4.2. Liquor at about 68% solids will then be sent to the preheated furnace. The pressure in the flash tank will be set so that the liquor will "flash" to maintain a temperature of 240°F in the tank (The boiling point of 68% solids liquor is about 240°F.). As the liquor begins to burn and a bed is established, the flow will gradually be increased to about 2 to 2.5 gpm while the gas flow is reduced to maintain the total heat input at 5 to 6 million Btu/hr. After a period of stable operation, the pressure in the flash tank will be gradually increased to raise

the liquor temperature to 260°F (i.e. above the boiling point). Anticipating there will be a significant change in bed appearance between the high and low temperature, the preferred liquor temperature to the BETE® spray nozzle will be set for further testing. The spray nozzle will be repositioned in the firing slot to evaluate the effect of nozzle height on combustion performance by the initial spray nozzle. Anticipating that alternate nozzle sizes or types will be available, a brief period of operation will be made with one of them. Air flow distribution will be adjusted to cause combustion to occur as low as possible in the furnace with minimum natural gas. A sample pot, similar to that used on commercial units, will be used to collect smelt at the end of the spout.

Data recorded by DAS:

See Test No. E.4.2.

Data recorded from off-line measurements:

See Test No E.4.2.

Visual observations:

Visual observations will be made of the relative performance of the various liquor firing conditions, including bed height and shape, and the relative quantity of "sparklers" in the upper furnace, to establish a (subjective) preferred mode of operation for further testing. Note that this is neither a detailed parametric study nor an attempt to define an "optimum" condition. This test is intended to establish a starting point for more detailed studies in Task III.

Sample analysis (off-line):

Test No. E.4.1 samples plus smelt samples

End-of-conveyor samples: Weight percent total: Na, K, S, Cl, CO₃
Standard green liquor analysis.

Smelt spout samples: Weight percent total: Na, K, S, Cl, CO₃
Standard green liquor analysis.
Impurities from refractory: SiO₂ & Al₂O₃.
Unburned carbon.

Performance calculations:

1. Concentrator: Verify ability to produce 68 to 70% solids product liquor at the design flow rate. Material balance should close within ±10%. Calculate overall heat transfer coefficient and steam economy for comparison with later

runs. Determine the amount of NCG produced and the quantity of sulfur lost in this gas. This should uncover any deficiencies in the design of the eductor system or the need for it and may suggest incineration is not required.

2. Furnace: Verify ability to burn 68-70% solids product liquor at design flow rates. Determine if there is an effect of nozzle position and type on measured smelt flow (For a system with no ash recycle, large changes in smelt flow may reflect changes in carryover). Material and energy balance should close within $\pm 20\%$ for this short test. Determine smelt reduction, sulfur recovery, and sodium recovery.
3. Smelt system: Verify that little or no change occurs in smelt reduction between the end of the spout and the end of the conveyor. Sampling at the conveyor end is much simpler than collecting molten smelt at the spout.

Material evaluation:

At the conclusion of this test the furnace will be closely examined for signs of refractory damage such as wastage or cracking. The presence of significant amounts of impurities from the refractory in the smelt samples will also be used as a preliminary assessment of the refractory condition. The refractory condition will be evaluated.

Test No. E.4.4:

The general objective of this shakedown test is to obtain a better understanding of the influence of the air distribution on the performance of the RFS with a specific liquor nozzle and liquor flow condition.

Objectives:

1. Operate the concentrator at 68 to 70% solids and the nominal design flow rate of 2.3 gpm.
2. Burn 68 to 70% solids black liquor with 6000 Btu/lb liquor at the design heat input rate of 6 to 6.2 million Btu/hour.
3. Establish the preferred air distribution with low excess air at the convection bank outlet, e.g., 2% O₂.
4. Determine if increased air temperature will eliminate the need for auxiliary gas firing.

5. Determine the time required to reestablish a steady state condition after an operating condition change.
6. Provide a complete set of preliminary performance data, to compare with the PR-FURMO predictions.

Procedure:

The concentrator, fuel feed tank, and furnace will be brought on-line as in Test No. E.4.3. Liquor at about 68% solids will then be sent to the preheated furnace. As the liquor begins to burn and a bed is established, the flow will gradually be increased to about 2 to 2.5 gpm while the gas flow is reduced to maintain the total heat input in the 5 to 6 million Btu/hr range. After a period of stable operation at about 68% solids and the optimum liquor temperature from Test No. E.4.3, the total air flow will be gradually reduced to produce about 2 to 3 % oxygen in the flue gas. Air flow distribution will be adjusted to produce a high bed temperature causing high fuming and low SO₂ emissions. Further air distribution adjustments will move primary air to the tertiary level to lower bed temperature and increase SO₂ concentrations in the flue gas. Anticipating there will be a significant change in bed behavior (and thus appearance) between the high and low temperature, the preferred air distribution will be set for further testing. If a significant amount of auxiliary gas firing is still required to give stable combustion conditions, the primary and secondary air temperature will be increased to minimize gas firing.

Data recorded by DAS:

See Test No. E.4.2.

During at least one significant change in operating conditions, the data acquisition system will be used to carefully follow trends in selected parameters such as FEGT, flue gas SO₂ and O₂, and bed temperature, so that the time required to achieve steady state conditions can be estimated.

Visual observations:

Visual observations will be made of the relative performance of the various air distributions to establish a preferred mode of operation for further testing. Note that this is neither a detailed parametric study nor an attempt to define an "optimum" condition. It is indented to establish a starting point for those studies in Phase III.

Data recorded from off-line measurements:

See Test No. E.4.2.

Sample analysis (off-line):

See Test No. E.4.2 for liquor, dust and solids.

Performance calculations:

See Test No. E.4.2.

Test No. E.4.5:

The general goal of this shakedown test is to test the facility at the limits of its design capacity, i.e., maximum evaporation rate and maximum heat input.

Objectives:

1. Operate the concentrator at 75 to 78% solids and the nominal design solids flow rate of 1000 lb/hr.
2. Operate the concentrator at 75 to 78% solids and higher pressure in the steam chest to confirm the design evaporation rate of 825 lb/hr.
3. Burn the maximum output of the concentrator during the evaporation rate test, i.e., operate at the maximum heat input rate.
4. Operate the concentrator at 78+% solids and the nominal design solids flow rate of 1000 lb/hr to establish maximum liquor concentrating ability. The "high solids" design is 85% solids.
5. Burn the high solids black liquor at the design heat input rate of 6 to 6.2 million Btu/hour.
6. Collect samples on the deposition probes.

Procedure:

The concentrator, fuel feed tank, and furnace will be brought on-line as in Test No. E.4.3. Liquor at about 70% solids will then be sent to the preheated furnace to establish a bed. The liquor concentration will be gradually increased by restricting the flow from the concentrator and increasing the steam chest pressure. The firing rate (gpm) will be gradually decreased to maintain the same excess air and heat input (i.e., constant solids flow). After a brief period of stable furnace operation at about 78% solids with the firing conditions and air distribution from Test No. E.4.4 to satisfy objective #1, the firing rate (i.e., liquor flow) will be gradually increased from 6 million Btu/hr to about 8 million Btu/hr (objective #3). This will increase the evaporation rate to 825 lb/hr (objective #2) to maintain the flash tank level

(higher inputs can not be achieved without the use of the intermediate storage tank). After another brief period of stable furnace operation at about 78% solids, the liquor firing rate will be decreased and the solids concentration increased to evaluate the "high solids" capacity of the concentrator (objective #4). The target solids level is 85%. Successfully burning this liquor will satisfy objective #5. It is anticipated that the liquor nozzle and possibly gun height will be changed at least once in this test and that optimum furnace performance will not be obtained at all firing conditions. Air distribution and liquor temperature will be adjusted as required to maintain acceptable combustion conditions.

Data Recorded by DAS:

See Test No. E.4.2.

Data recorded from off-line measurements:

See Test No. E.4.2.

Sample analysis (off-line):

See Test No. E.4.1 for liquor, dust and solids.

Deposition probes: Deposit weight; dust analysis.
Reduced sulfur, organic carbon (liquor carryover), pH of 1% solution.

Visual observations:

Visual observations will be made of the bed shape and the relative amount of burning particles leaving the upper furnace. The appearance of the deposition probes will be monitored.

Performance calculations:

1. Concentrator: Material balance should close within 10%. Calculate overall heat transfer coefficient and steam economy for all throughput and solids conditions. This test will verify the ability of the concentrator to produce 85% solids product liquor and to match the furnace demand at the higher throughput.
2. Furnace: Material & energy balance should close within 20% for this short test. Determine combustion efficiency, sulfur reduction efficiency, sulfur recovery, and sodium recovery. Determine gas temperature at selected points in system.

Test No. E.4.6:

Objectives:

1. Repeat any of the previous test that failed to achieve its objects.
2. To be determined if the test is required.

TEST SERIES E.5 BASELINE CHARACTERIZATION TESTS

Purpose:

A series of steady-state tests will be carried out in Phase III to characterize the Recovery Furnace Simulator. The focus of these tests will be on the combustion of liquor at typical commercial solids levels over a range of operating conditions. Concentration to higher solids is not part of this test series. Liquor will be burned at a nominal design heat input of 6.0 million Btu/hour and a liquor concentration of 68-78% solids. This range of liquor concentration is typical of present commercial unit operations. These characterization tests will provide a baseline against which all improvements in furnace performance can be measured. These tests will also demonstrate how the simulator responds to changes in operating conditions. The data from some of these test will be used with PR-FURMO to evaluate similarity of pilot and commercial scale results. By slowing comparable results at nominal conditions, this study will increase the level of confidence in the RFS results when the unit is operated outside the boundaries of present commercial operating conditions.

In order to ensure that all data collection occurs under steady-state conditions, the bed will be allowed to equilibrate for several hours after changes are made to operating conditions. The equilibration time will be based on the results of the Phase II tests. The furnace will be operated continuously for 24 hours per day for 3 to 5 days at a time with several tests being run in series (a group). Most of the data acquisition will take place during the day shift, operational changes being made on second shift and equilibration occurring during the third shift. This mode of operation will shorten the overall test program and reduce the thermal strain on the refractory lining by minimizing the number of startups and shutdowns.

Prior to these test, the simulator will have undergone a series of shakedown test in Phase II to prove that it is fully operational. The test program presented in this section is subject to change based on performance information developed in these Phase II shakedown tests.

Procedure:

The concentrator, flash tank, and furnace will be brought on line as described in the Phase II test plans. The furnace will be allowed to come to steady-state conditions, with the operating conditions as desired for the first test point. Auxiliary natural gas firing will be reduced to the minimum quantity required to maintain stable firing operations. After a period of data and sample acquisition, the new operating conditions for the next test in the group will be established and the furnace allowed to equilibrate. Optimum conditions from Group 1 will be used as the starting point for Group 2. At the completion of each group of tests, liquor flow to the concentrator will be shut off, but flow will continue to the furnace to partially empty the flash tank. The bed will be burned out with natural gas. Liquor in the concentrator and flash tank will be diluted and returned to the concentrator feed tank if a long

idle period is planned before the next test series. For short idle periods the diluted liquor will be circulated through the concentrator and tank

In Test Group No. 1, air will be moved from the secondary to the tertiary zone in steps. In Test Group No. 2, the total air flow will be decreased in steps at constant distribution. In Test Group No. 3, air port pressure will be increased in steps by changing the air port sleeves. In Test Group No. 4, the solids concentration will be increased in steps. The corresponding liquor flow will be decreased to maintain relatively constant heat input. It is anticipated that the nozzle will be moved closer to the bed as the solids are increased to reduce in-flight burning

Test matrix: The operating conditions for each test are shown in Table 2.

Objectives:

Test Group No. 1:

1. Characterize the performance of the furnace with respect to air distribution at a fixed solids level of 75%.
2. Establish an upper limit for tertiary air (Will the furnace give satisfactory performance with 50% tertiary air?).
3. Document the response of the char bed shape to changes in air distribution.

Test Group No. 2:

1. Characterize the performance of the furnace with respect to total air to the furnace.
2. Establish a lower limit for excess air supply (will the furnace still give satisfactory carbon burn out and CO levels with 5% excess air?; 5% excess air is about 1% oxygen in the flue gas.)

Test Group No. 3:

1. Characterize the performance of the furnace with respect to air jet penetration.
2. Document the response of the char bed shape to changes in air jet penetration.

Test Group No. 4:

1. Characterize the performance of the furnace with respect to black liquor solids concentration using a single air distribution.

TABLE 2 TEST PLAN for TEST E.5; Detailed Characterization Tests

Test Group No		1	----->			2	----->		3	----->		4	----->				
Test Group Name:		Air distribution				Excess Air			Port Press.			Liquor Concentration					
Test No.		1	2	3	4	5	6	7	8	9	10	11	12	13	14	15	
Heat Input	MBtu/hr	6.0	----->			6.0	----->		6.0	----->		6.0	----->				
Nozzle Conditions																	
Nozzle type	---	TBD	----->			TBD	----->		TBD	----->		TBD	----->			R	I
Nozzle Elevation	ft	TBD	----->			TBD	----->		TBD	----->		TBD	----->			e	f
Solids	%	68	----->			68	----->		68	----->		72	75	78			p
Liquor temp	°F	240	----->			240	----->		240	----->		AR	----->			e	R
Pressure	psig	AR	----->			AR	----->		AR	----->		AR	----->			a	R
Air Conditions																	
Excess Air Distribution	%	10	----->			5	15	20	10	----->		10	----->			P	I
Primary	%	40	30	30	25	40	----->		40	----->		40	----->			r	r
Secondary	%	30	40	30	25	30	----->		30	----->		30	----->			e	d
Tertiary	%	30	30	40	50	30	----->		30	----->		30	----->			v	i
Air Temperature																	
Pri/Sec	°F	320	----->			320	----->		320	----->		320	----->			o	u
Tertiary	°F	90	----->			90	----->		90	----->		90	----->			s	s
Header Pressure (a)																	
Primary	"H2O	4	AR	----->		4	----->		3	6	8	4	----->			T	e
Secondary	"H2O	8	AR	----->		8	----->		4	8	12	8	----->			s	t
Tertiary	"H2O	12	AR	----->		12	----->		12	16	20	12	----->				
Air Ports in use																	
Primary	#	20	----->			20	----->		20	----->		20	----->			#	
Secondary	#	8	----->			8	----->		8	----->		8	----->				
Tertiary	#	7	----->			7	----->		7	----->		7	----->				

Note: Test 1 settings may be changed based on shakedown test results.

TBD = To be determined in shakedown tests

AR = As required to achieve air distribution

(a) Air port sleeves will be changed to achieve desired velocity and port pressure

2. Document the response of the char bed shape to changes in liquor concentration.
3. Document the response of the char bed shape to changes in liquor nozzle elevation assuming it will be necessary to change nozzle height as the solids are increased.

Data recorded by DAS:

1. Concentrator:
 - Liquor flow to and from concentrator;
 - Product liquor density
 - Liquor temperature to and from concentrator
 - Temperature in concentrator body
 - Circulation rate
 - Liquor density in circulation line
 - Plant steam flow and pressure in steam chest
 - Cooling water flow, temperature in and out of condenser
 - Condenser pressure
 - Process condensate flow and temperature from condenser
 - Conductivity of process condensate
2. Furnace:
 - Liquor flow, temperature and pressure at nozzle
 - Solids, density and viscosity in liquor circulation loop
 - Air flow, temperature and header pressure for each zone
 - Natural gas flow to auxiliary burners
 - Natural gas flow to smelt zone burner
 - Flue gas temperature leaving furnace, convection pass and BWHX
 - Bed temperature via bed camera
 - Gas composition leaving convection pass: O₂, CO₂, SO₂, CO, NO_x
3. Smelt System:
 - Conveyor speed
 - Cooling water flow
4. Baghouse:
 - Pressure drop
 - Total weight of dust collected
5. Water Jacket:
 - Feed water flow
 - Blowdown flow and temperature
 - Conductivity and pH

Note: A list of the instruments used to measure and control the system is found in Attachment 2.

Data recorded from off-line measurements:

Smelt flow rate: Number of ingots and weight of selected representative ingots.
Baghouse catch: Total weight of dust collected.

Visual observations:

Bed height, shape and other characteristics. These will also be recorded by the bed camera on video tape during periods of steady state operations for comparison between tests. Liquor spray pattern and wall appearances. Relative quantity of "sparklers" in top of furnace. General appearance of the deposition probes.

Additional data:

Spray nozzle used and nozzle elevation above the reference point. Number of air ports in use and the diameter of the opening in the port sleeves. Number and location of auxiliary burners in service.

Sample analysis (off-line):

Feed Liquor to concentrator: Percent solids, heating value, elemental analysis. [one sample at start of test]

Heavy Liquor to feed tank: Percent solids [Sample every half hour].

Heavy Liquor to furnace: Percent solids, heating value, elemental analysis [sample every hour; Composite for analysis].

Smelt from end of conveyor: Weight Percent total: Na, K, S, Cl, C.
Ingot weight and bulk density.

Dust from baghouse hopper: Weight Percent total: Na, K, S, Cl, C.
Bulk density of dust.

Ash deposition probes: Weight Percent total: Na, K, S, Cl, C
Reduced sulfur, Organic carbon/carryover.

Process condensate: Sodium, sulfur and total organics.

Non-Condensable Gas (NCG): Sulfur compounds after absorption.

Note: A list of standard analytical procedures used by B&W for black liquor and smelt/dust samples is found in Attachment 3.

TEST SERIES E.6 HIGH SOLIDS LIQUOR IN BASE UNIT

Purpose:

A series of steady-state tests will be carried out in Phase III to evaluate the performance of the Recovery Furnace Simulator when burning high solids liquor (solids > 78%) at the nominal design heat input of 6.0 million Btu/hour. The performance of the concentrator during the preparation of these high solids liquors will also be evaluated. It is assumed for planning purposes that the target product solids levels of 85 to 90% solids can be achieved. If these levels can not be achieved, the program will be adjusted to maintain the maximum practical solids. The test plan presented in this section is subject to change based on the information gained in the characterization and shakedown tests.

A second series of tests will be carried out at a high solids level (~85%) with higher liquor flow rates to determine the maximum heat input to the furnace. The data from some of these high solids and high input test will be used with PR-FURMO to evaluate the maximum capability of the code to predict behavior at the maximum capacity firing conditions.

During these test series, the furnace will be operated continuously for 24 hours per day for 3 to 5 days at a time with several tests being run in a group. All data collection will take place under steady-state conditions. Based on the results of baseline characterization tests, the bed will be allowed to equilibrate for a period of time after each change in operating conditions. It is currently anticipated that most of the data acquisition will take place during the day shift with operational changes being made on second shift and equilibration occurring during the third shift. This mode of operation will shorten the overall test program and reduce the thermal strain on the refractory lining by minimizing the number of startups and shutdowns.

Procedure:

The concentrator, flash tank, and furnace will be brought on line as described in shakedown test plans. The furnace will be allowed to come to steady-state conditions, with the operating conditions as desired for the first test point for each group of tests. The starting point for each group will be the optimum conditions found in the previous series. Auxiliary natural gas firing will be reduced to the minimum quantity required to maintain stable firing operation. After a period of data and sample acquisition, the new operating conditions for the next test in the group will be established and the furnace allowed to equilibrate. Optimum conditions from Group 1 will be used as the starting point for Group 2. At the completion of each group of tests, liquor flow to the concentrator will be shut off, but flow will continue to the furnace to partially empty the flash tank. The bed will be burned out with natural gas. Liquor in the concentrator and flash tank will be diluted and returned to the concentrator feed tank if a long idle period is planned before the next test series. For short idle periods, the diluted liquor will be left in the concentrator and tank and circulated.

In Test Group No 1, the solids will be increased in one step from the demonstrated operating condition of 78-80% to 85% and then gradually increased to the maximum obtainable or 90%. The solids will be increased by restricting the concentrator output and increasing the steam chest pressure. In Test Group No 2, the temperature of the as-fired liquor will be varied in steps, while holding the solids at a constant value. Anticipating that the nozzle must be moved closer to the bed as the solids are increased to reduce in-flight burning, Test Group No 3, will vary the nozzle position. The final test in this group is expected to result in very high carryover and ash deposition on the sample probes. It may also be desirable, based on the furnace characterization test, to change the liquor spray nozzle to produce a larger drop size at high solids.

In Test Group No 4, the heat input to the furnace will be increased in steps by increasing liquor flow to the maximum firing rate obtainable or 12 million Btu/hr. A change of nozzle type or nozzle elevation may be required to achieve the desired heat input. Because of the limited concentrator capacity, this group of tests will be run for shorter periods and will require intermediate idling periods at low load with auxiliary fuel support while enough heavy liquor (63 to 65%) is accumulated as feed liquor for the next test.

Test matrix:

The operating conditions for each test are shown in Table 3. Changes in nozzle elevation, as-fired liquor temperature, and air distribution may be required in Test Group No. 1 as the solids are increased to maintain a stable bed and optimum furnace appearance. The initial operating conditions (i.e., air distribution, excess air, air port pressure) will be based on the results of the baseline characterization tests, but for planning purposes typical set of conditions has been selected as the starting point for this test series.

TABLE 3 TEST PLAN for TEST E.6; High Solids/High Heat Input Base Unit Tests

Test Group No	1	2	3	4	5	6	7	8	9	10	11	12	13	14	15
Test Group Name:	Solids Conc.			liquor Temp			Nozzel Elev.			High Heat Input					
Test No.	1	2	3	4	5	6	7	8	9	10	11	12	13	14	15
Heat Input	MBtu/hr	6.0		6.0			6.0			8.0	10.0	12.0	10.0	12.0	
Nozzle Conditions															
Nozzle type	---	TBD		TBD			TBD			TBD			No. 2		R
Nozzle Elevation	ft	7		7			5	3	10	5			AR		e
Solids	%	80	85	90	85		85			85			85	90	p
Liquor temp	°F	240			230	260	280	260		260			AR		e
Pressure	psig	AR			AR			AR		AR			AR		a
Air Conditions															
Excess Air	%	10		10			10			10			10		p
Distribution															
Primary	%	40		40			40			40			40		e
Secondary	%	30		30			30			30			30		v
Tertiary	%	30		30			30			30			30		i
Air Temperature															
Pri/Sec	°F	320		320			320			320			320		u
Tertiary	°F	90		90			90			90			90		s
Header Pressure															
Primary	"H2O	4		4			4			4			4		T
Secondary	"H2O	8		8			8			8			8		e
Tertiary	"H2O	12		12			12			12			12		s
Air Ports in use															
Primary	#	20		20			20			20			20		
Secondary	#	8		8			8			8			8		#
Tertiary	#	7		7			7			7			7		?

Note: Test settings may be changed based on characterization test results.

TBD = To be determined in characterization tests

AR = As required

Objectives:

Test Group No 1:

1. Characterize the performance of the furnace with respect to the solids level of the as-fired liquor.
2. Determine the maximum solids level that can be produced in the concentrator and burned in the RFS.
3. Document the response of the char bed shape to changes in solids concentration.
4. If a nozzle change is required, document the changes to furnace performance with the different nozzle.

Test Group No 2:

1. Characterize the performance of the furnace with respect to the temperature of the as-fired liquor.
2. Determine the amount of liquor carryover (sparklers) in the upper furnace as the spray liquor temperature changes from non-flashing to flashing.
3. Document trends in bed temperature and SO₂ releases with changes from non-flashing to flashing conditions.
4. Document the response of the char bed shape to changes in firing temperature, which is anticipated to cause changes in the amount of liquor reaching the bed.

Test Group No 3:

1. Characterize the performance of the furnace with respect to the elevation of the liquor nozzle when all other parameters remain constant.
2. Determine the nozzle height (i.e., drop flight time) required to achieve acceptable firing conditions. Demonstrate the adverse effects of excess drop flight time.
3. Demonstrate the impact of in-flight burning of "overdried" liquor droplets on carryover and the resulting ash deposition on the sample probes.
4. Determine the SO₂ and gas temperature at the convection bank under wall/bed burning and in-flight burning conditions.

5. Document the response of the char bed shape to changes in nozzle elevation, which is anticipated to change the amount of liquor reaching the bed.

Test Group No 4:

1. Determine the maximum heat input that can be achieved in the RFS when burning high solids liquor.
2. Document the response of the char bed shape to the increased heat input rates.
3. Determine the SO₂, gas temperature at the convection bank inlet, and deposition on the convection bank probes at the high heat input conditions.

Data recorded by DAS:

1. Concentrator: Liquor flow to and from concentrator;
Liquor temperature to and from concentrator
Temperature in concentrator body
Circulation rate
Liquor density in circulation line
Plant steam flow and pressure in steam chest
Cooling water flow, temperature in and out of the condensor
Condenser pressure
Process condensate flow and temperature
Conductivity of process condensate
2. Furnace: Liquor flow, temperature and pressure at nozzle
Solids, density and viscosity in liquor circulation loop
Air flow, temperature and header pressure for each zone
Natural gas flow to auxiliary burners
Flue gas temperature leaving furnace, convection pass and BWHX
Gas composition leaving convection pass: O₂, CO₂, SO₂, CO, NO_x
3. Smelt System: Conveyor speed
Water flow
4. Baghouse: Pressure drop
Total weight of dust collected
5. Water Jacket: Feed water flow
Blowdown flow and temperature
Conductivity and pH

Note: A list of the instruments used to measure and control the system is found in Attachment 2.

Visual observations:

Bed height, shape and other characteristics. These will also be recorded by the bed camera on video tape during periods of steady state operations for comparison between tests. Liquor spray pattern and wall appearances. Relative quantity of "sparklers" in top of furnace. General appearance of the deposition probes.

Additional data:

The following items will be noted in the furnace operating log: Spray nozzle used and nozzle elevation above the reference point. Number of air ports in use and the diameter of the opening in the port sleeves. Number and location of auxiliary burners in service.

Sample analysis (off-line):

Feed Liquor to concentrator:	Percent solids, heating value, elemental analysis [one sample at start of test].
Heavy Liquor to feed tank:	Percent solids [sample every half hour]
Heavy Liquor to furnace:	Percent solids, heating value, elemental analysis [sample every hour; composite for analysis].
Smelt from end of conveyor:	Weight percent total: Na, K, S, Cl, C. Ingot weight and bulk density.
Dust from baghouse hopper:	Weight percent total: Na, K, S, Cl, C. Bulk density of dust.
Ash deposition probes:	Weight percent total: Na, K, S, Cl, C. Reduced sulfur, organic carbon/carryover.
Process condensate:	Sodium, sulfur and total organics.
Non-Condensable Gas (NCG):	Sulfur compounds after absorption.

Note: A list of standard analytical procedures used by B&W for black liquor and smelt/dust samples is found in Attachment 3.

Sample frequency required, except for black liquor, will be determined during the shakedown tests.

ATTACHMENT 1 to APPENDIX E

ATOMIZATION FACILITY

ATTACHMENT 1

Atomization Facility

The Atomization Facility consists of a spray booth and an assortment of equipment and transducers that can support a wide range of atomizers and nozzles (see Figure E.1-1). The spray booth is 8' x 8' x 10' long with two 4' x 8' plate glass windows mounted in opposing walls. The windows provide optical access to the spray for laser diagnostics, visual observation and still and motion picture photography. Air is continually forced through the spray booth to prevent the build-up of a "fog" of very fine droplets. The air is supplied by a forced draft fan and enters the booth through the windbox. Turning vanes and a honeycomb flow straightener are used to provide a uniformly distributed flow over the spray booth cross-section. At the exit of the spray booth, the droplets are removed from the sweep air by a series of demisters.

The facility is equipped with a 2000 gallon stainless steel tank for storing liquids and slurries to be used for testing. After spraying in the facility the liquid is collected in a waste hopper for disposal or for recycle to the storage tank.

The standard test equipment used at the Atomization Facility is listed in Table E.1-1. The wide range of pumping capacity accommodates utility size atomizers as well as small capacity atomizers. The associated calibrated instrumentation yields accurate repeatable data at all possible test conditions.

Malvern 2600 Particle Sizer

The Malvern 2600 droplet sizer system uses the diffraction pattern created by the spray to generate a droplet size distribution. Droplets, when illuminated by a beam of monochromatic light, give rise to a diffraction pattern. This pattern consists of a series of bright and dark rings superimposed on the smaller geometric image. If a lens is placed between the particles and a detector (with the detector placed at the focal point of this lens), then the undiffracted light is focussed to a small spot at the center of the detector with the much larger diffraction pattern surrounding (see Figure E.1-2). This diffraction pattern is stationary: movement of the particles does not cause a shifting pattern.

Although a given particle diffracts light to all radii, the light energy distribution has a maximum at a radius s , given by:

$$2\pi rs/kf = 1.375 \quad (A-1)$$

where:

- r = particle radius
- k = wavelength of the laser
- f = focal length of the lens

Therefore, if the detector is divided into a series of circular rings whose mean radii, s_i , correspond to equation (A-1), then a set of drop radii, r_i , can be measured, where r_i is the mean particle radius of the i 'th size range. For each range, a uniform size distribution is assumed. Now a unique light energy distribution will yield a unique particle size distribution.

The instrument will span a drop size range of about 100:1. Depending on the focal length of the light collection lens the range of drop sizes extends from about 5 microns to 10 mm. For typical dual fluid atomizer testing the drop size range extends from about 10 to 1000 microns. For low pressure nozzles a drop size range of 0.1 to 10 mm is typically used.

The detector signals are collected serially, converted to digital values, and then transmitted to a minicomputer. This process takes only a few milliseconds for each sweep of all the rings. The raw data is then stored for later recall and analysis.

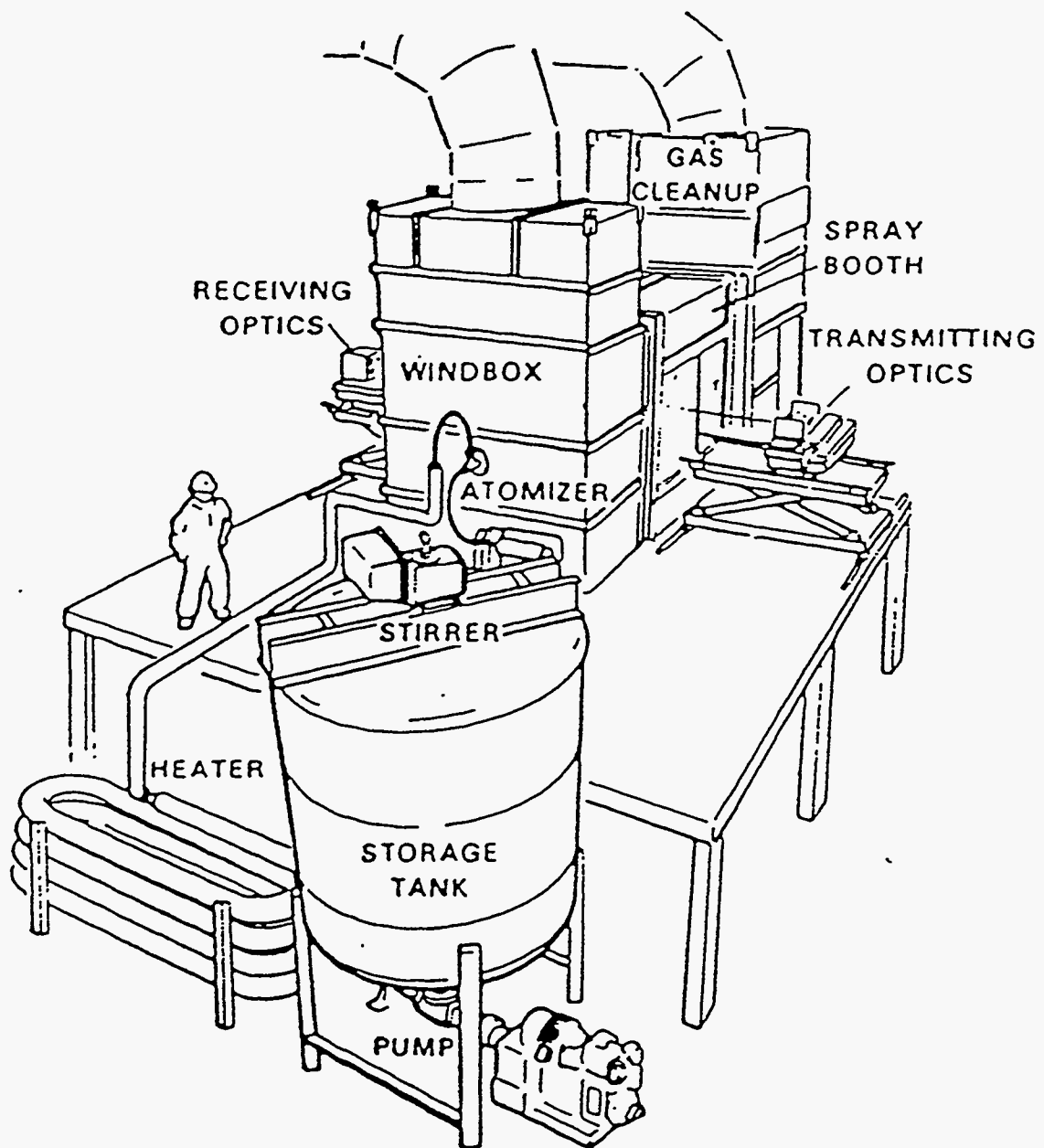

Figure E.1-1. Arrangement of Atomization Facility.

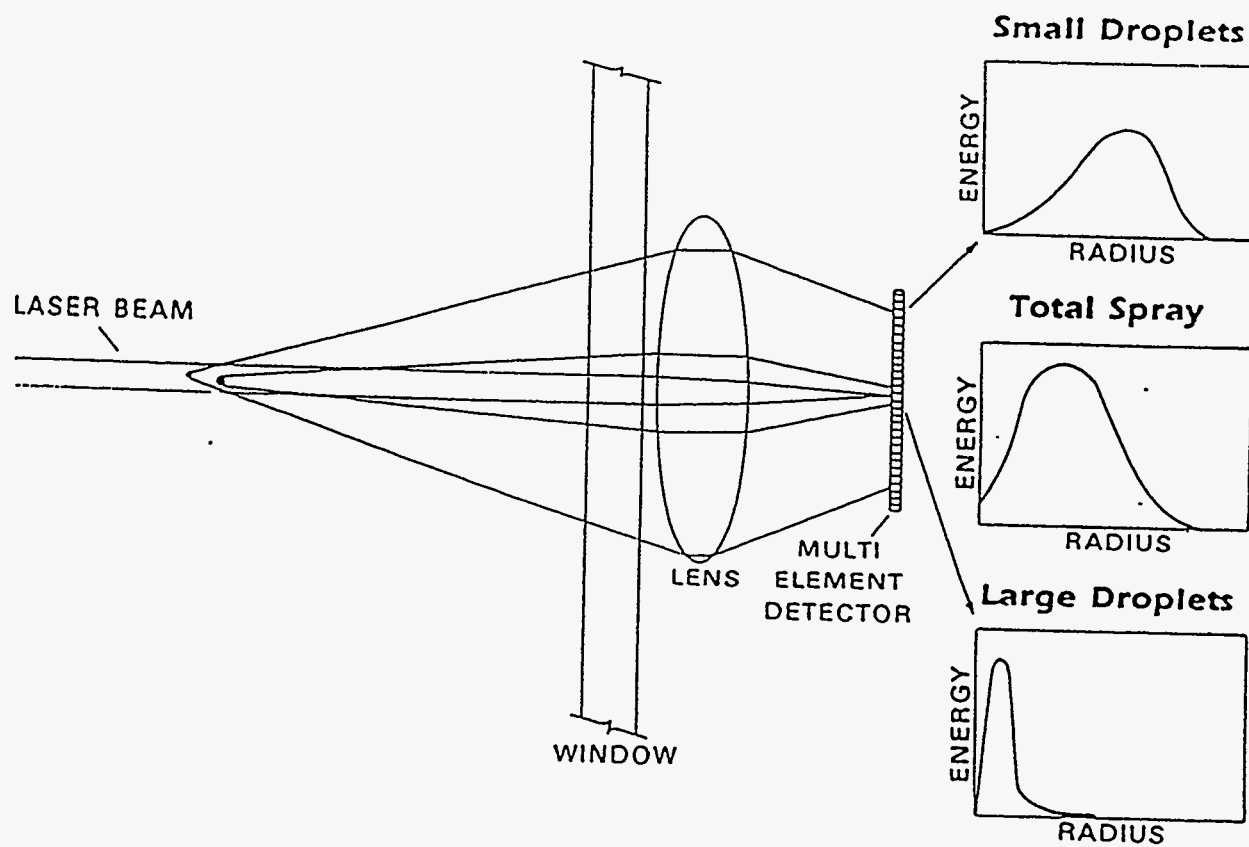

Figure E.1-2. Malvern 2600 Particle Sizer

**TABLE E.1-1
ATOMIZATION FACILITY EQUIPMENT AND CAPABILITIES**

Equipment	Manufacturers	<u>Capacity/Range</u>
Air Compressor	Ingersoll/Rand	220 psig at approx. 200 lb/hr, 150 psig at 1000 lb/hr.
Progressing Cavity pump	Moyno	Approx. 15000 lb/hr at up to 450 psig.
Mechanical Positive Displacement Pump	Worthington	8000 lb/hr at up to 1100 psig.
Low Pressure Centrifugal Pump		600 GPM
Forced Draft Fan	New York Blower	Up to 40,000 SCFM through the spray booth.
Malvern Droplet Sizing System	Malvern	100:1 range in drop size.
Top-Size Measurement	In-House	Volume percent greater than 169 microns.
Liquid Flowmeters	Micro-Motion In-House Orifice	0 - 10,000 lb/hr in multiple ranges. 30 to 300 GPM.
Air Flow	In-House Orifice	Multiple sizes as required by test.
Thermocouples	-----	Fluid temperatures.
Pressure Transmitters	Bailey Controls Company	0 - 500 psig liquid 0 - 500 psig air pressure
Low Capacity Pumping System	Moyno	Portable pump and storage tank for flows up to 100 lb/hr

ATTACHMENT 2 to APPENDIX E

INSTRUMENT LIST

TABLE E.2-1. BLACK LIQUOR SYSTEM

Line No.	Item No.	Description	Normal Oper. Point	Qty	Sensor Type	Line or Connect. Size	Signal to DAS
1	1	Concentrator Feed Flow	2000 #/h	1	Conc. Vendor Supply	1" pipe	X
	2	Concentrator Feed Density	SG = 1.25		Conc. Vendor Supply	1" pipe	X
	3	Concentrator Feed Temp.	180 °F		Thermocouple	1" p "T"	X
	4	Concentrator Level	Vendor		Conc. Vendor Supply	flange	
	5	Conc. Feed Flow Controller	NA		Control Valve	1" pipe	
2	6	Concentrator Output Flow	1539 #/h	Conc. Vendor Supply	3/4"	X	
	7	Concentrator Output Density	SG = 1.33	Conc. Vendor Supply	3/4"	X	
	8	Concentrator Output Temp.	240 °F	Thermocouple	3/4"		
3	9	Conc. Recirc. Flow	Vendor	Conc. Vendor Supply	vendor		
	10	Conc. Recirc. Temp.	240 °F	Conc. Vendor Supply	vendor		
	11	Conc. Recirc. Density	SG = 1.33	Conc. Vendor Supply	vendor		
4	12	Conc. Steam Chest Pressure	15.7 psig	Press XMTR	Tank	X	
	13	Steam Flow	508 #/hr	Orifice	1"	X	
	14	Steam Temperature	251 °F	Thermocouple	1"	X	
	15	Steam Press At Flow meter	20-90psig	Press XMTR	1"	X	
	16	Steam Flow Controller	NA	Control Valve	1"		
	5	17	Vapor Head Pressure	2-20 psig	Conc. Vendor Supply	Tank	X
		18	Vapor Flow Controller	NA	Control Valve	vendor	
6	19	Condenser Water Flow	8000 #/h	Conc. Vendor Supply	2" pipe	X	
	20	Condenser Water Exit Temp	130 °F	Conc. Vendor Supply	2" pipe	X	
	21	Condenser Water Flow Controller	NA	Control Valve	2" pipe		
7	22	Condenser Water Inlet Temp	70 °F	Thermocouple	2" pipe		
8	23	Process Cond. Tank Level	± 0 "H2O	Press XMTR	Tank		
	24	Process Condensate Temperature	212 °F	Thermocouple	1" pipe		
	25	Process Condensate Conductivity	300 mMho	Cond. cell	1" pipe	X	
	26	Condensate Flow Controller	NA	Control Valve	1" pipe		
	27	Condensate Diverter Valve	NA	3 way Valve	1" pipe		
9	28	Flash Tank Level	± 0 inch	Diff Press XMTR	Tank		
	29	Flash Tank Feed Controller	NA	Control Valve	3/4"		
	30	Flash Tank Pressure	± 0 psig	Press XMTR	Tank	X	
10	31	Flash Tank Vent Gas Controller	NA	Control Valve	1" pipe		
	32	As-Fired Solids	65%	Refractometer	1 1/4"	X	
	33	As-Fired Viscosity	200 cp	TBD (Based on UF	1 1/4"	X	
	34	As-Fired Desity	SG = 1.33	TBD Results)	1 1/4"	X	
	35	As-Fired Temperature	220 °F	Thermocouple	1 1/4"	X	
	36	By-Pass Flow Controller	NA	Control Valve	1 1/4"		
	11	37	As-Fired Flow to nozzle	1539 #/h	Micromotion	3/4"	X
38		As-Fired Nozzle pressure	30 psig	Press XMTR	3/4"	X	
12	39	Heavy Liquor Storage Tank Level	0 - 10 ft	Diff Press XMTR	Tank		
	40	H.L. Storage Tank Temperature	240 °F	Thermocouple	Tank		
	41	H.L. Flow Controller	NA	Control Valve	3/4"		
13	42	Flow Cont.: Steam to F. Tank	NA	Press Reduc. Valve	1" pipe		
	43	Flow Cont.: Steam to H.L. Tank	NA	Press Reduc. Valve	1" pipe		
14	44	Feed Liquor Tank Level	0 - 10 ft	Diff Press XMTR	Tank		

TABLE E.2-2. AIR SYSTEM

Line No.	Item No.	Description	Normal Oper. Point	Qty	Sensor Type	Line or Connect. Size	Signal to DAS
1	1	Total Air Flow	4815 #/h	1	Orifice		X
	2	Total Air Temp @ Meter	90 °F	1	Thermocouple		X
	3	Total Air Pressure @ Meter	90" H2O	1	Press XMTR		X
	4	Total Air Flow Controller	NA	1	Damper (Existing)		
	5	Ambient Air Dry Bulb	80 °F	1	Thermocouple (Exis.)		TC 7
	6	Ambient Air Wet Bulb	69 °F	1	Thermocouple (Exis.)		TC 8
	7	Total Air Temp @ Air heater	90 °F	1	Thermocouple (Exis.)		TC10
2	8	Primary Air flow	1926 #/h	1	Orifice	10" pipe	X
	9	Primary Air Temperature	310 °F	1	Thermocouple		X
	10	Primary Air Pressure @ meter	30" H2O	1	Press XMTR		X
	11	Primary Air flow Controller	NA	1	Damper		
	12	Balancing Dampers	NA	4	Manual Slide Gate	6"	
	13	Balancing Pitot tubes	NA	4	Pitot tubes		
	14	Primary Air Windbox Pressure	4" H2O	1	Press XMTR (1)		X
3	15	Secondary Air Flow	1445 #/h	1	Orifice	8" pipe	X
	16	Secondary Air Temperature	310 °F	1	Thermocouple		X
	17	Secondary Air Pressure @ Meter	30" H2O	1	Press XMTR		X
	18	Secondary Air flow controller	NA	1	Damper		
	19	Balancing Dampers	NA	4	Manual Slide Gate	6"	
	20	Balancing Pitot tubes	NA	4	Pitot tubes		
	21	Secondary Air Winbox Pressure	8" H2O	1	Press XMTR (1)		X
4	22	Tertiary Air Flow	1445 #/h	1	Orifice	8" pipe	X
	23	Tertiary Air Temperature	90 °F	1	Thermocouple		X
	24	Tertiary Air Pressure @ meter	30" H2O	1	Press XMTR		X
	25	Tertiary Air flow controller	NA	1	Damper		
	26	Balancing Dampers	NA	2	Manual Slide Gate	6"	
	27	Balancing Pitot tubes	NA	2	Pitot tubes		
	28	Tertiary Air Windbox pressure	12" H2O	2	Press XMTR		X
5	29	Air to Startup Burner Flow		1			
	30	Startup Burner Air Temp @ meter		1			
	31	S. Burner Air Pressure @ meter		1			
	32	Startup Burner Windbox Pressure		3			
6	33	Gas flow to auxillary burners		1			X
	34	Gas Temperature		1	Thermocouple		X
	35	Gas Pressure @ meter		1	Press XMTR		X
	36	Gas flow controller		1	Control Valve		
7	37	Gas flow to fired air heater		1	DPI-2 (existing)		no
	38	Gas flow controller		1	Existing Htr controls		---

TABLE E.2-3. FLUE GAS SYSTEM

Line No.	Item No.	Description	Normal Oper. Point	Qty	Sensor Type	Line or Connect. Size	Signal to DAS	
1	1	Furnace Exit Draft	-0.1 "H2O	1	Press XMTR	1" pipe	X	
	2	Furnace Exit Gas Temp.	1750 °F	1	Thermocouple		X	
2	3	Flue gas temperature @ CB exit	800°F	1	Thermocouple {TC301}	1" pipe	X	
	4	Con. Bank Exit Draft	-0.1 "H2O	1	Press XMTR		X	
		Convection Bank Exit Gas Composition						
	5	O2 Concentration	2% dwb	1	Existing Analyzer		X	
	6	SO2 Concentration	200 ppm	1	shared w/2.5 MW		X	
	7	CO2 Concentration	16%	1			X	
	8	CO Concentration	200 ppm	1			X	
	9	NOx Concentration	100 ppm	1	v		X	
3	10	Flue gas temp @ Baghouse Inlet	350°F	1	Thermocouple {TC1}		X	
	11	Flue gas temp @ Baghouse Exit	350°F	1	Thermocouple {TC2}		X	
	12	Baghouse Exit Pressure	-7" H2O	1	Press XMTR {DP8}		X	
	13	Baghouse Differential Pressure	5" H2O	1	Press XMTR		X	
	14	Flue gas temp @ ID Fan Inlet	350°F	1	Thermocouple {TC3}		X	
	15	ID Fan Inlet Damper	NA	1	{Existing}			
	16	Stack Wet/Dry Bulb Temp	350/160	1	DEWBI meter		X	

TABLE E.2-4. MISCELLANEOUS INSTRUMENTS

Line No.	Item No.	Description	Normal Oper. Point	Qty	Sensor Type	Line or Connect. Size	Signal to DAS
1	1	Smelt conveyor Speed	20 fps	1	Tachometer		X
	2	Smelt pan depth	1 inch	1	WTS/RAM NI#4405		X
2	3	Furnace Jacket Blowdown pH	10	1	pH meter		X
	4	Furnace Jacket Blowdown Cond.	3000 mMho	1	Conductivity meter		X
3	5	Bed Camera System	---	1	B&W Imaging System		
4	--	Liquor Cooker (Solids meas.)	---	1	Infrared Balance		

(THIS PAGE LEFT INTENTIONALLY BLANK)

ATTACHMENT 3 to APPENDIX E
ANALYTICAL PROCEDURES

ATTACHMENT 3

Analytical Procedures

Part 1: Black Liquor Analysis

The following is a list of the procedures used for the analysis of black liquors. A brief description is supplied with each procedure.

Solids

The solids content of a black liquor is determined gravimetrically using TAPPI T 650 "Solids Content of Black Liquors." In this method the black liquor is dried at 105°C for a minimum of 6 hours. An inert high silica sand is used as a surface extender. High solids black liquors are diluted to reduce scum formation. The method measures the "solids" remaining after removal of water and other nonaqueous volatile materials normally lost in commercial evaporation systems. This test is done in triplicate.

Gross Heating Value

The heating value is determined according to TAPPI T 684 "Gross Heating Value of Black Liquor." In this method the gross (or high) heating value is determined by combusting a sample of the black liquor in an adiabatic oxygen bomb calorimeter. To insure complete combustion, benzoic acid is used as an auxiliary fuel. This procedure is applicable to black liquors containing up to 55% water. This test is performed in duplicate.

Ultimate Analysis - Elemental

A TAPPI procedure is not available for the determination of the ultimate analysis. The ultimate procedure is a B&W procedure based on the analysis of coal, coke and other fuels. Following is a description of each of the determinations:

Carbon and Hydrogen

This procedure is based on ASTM D 3178 "Carbon and Hydrogen in the Analysis Sample of Coal and Coke." In this procedure, a sample of black liquor is burned in a closed system. The combustion products are collected in an absorption train. The carbon and hydrogen are determined gravimetrically. The hydrogen is corrected for the moisture in the sample. This procedure was modified by B&W by lowering the temperature at which the sample is combusted. Lowering the combustion temperature prevents decomposition of the ash. As a result, the carbon value must be corrected for the carbonate in the ash. Care is taken to insure that the temperature is sufficient to burn out all carbon black in the sample.

The ash is saved for the determination of carbonate and the inerts. This test is performed in duplicate.

Nitrogen

Nitrogen is determined by ASTM D 3179 "Nitrogen in the Analysis Sample of Coal and Coke." Test Method A (Kjeldahl-Gunning Macro Analysis) is used by B&W. In this procedure, the nitrogen is converted into ammonium salts by destructive digestion of the sample with a hot, catalyzed mixture of concentrated sulfuric acid and potassium sulfate. These salts are decomposed in a hot alkaline solution from which the ammonia is recovered by steam distillation. The nitrogen is then determined by acidimetric titration. The method has been slightly modified in the digestion reagents used. The modification is for laboratory safety reasons and not specific to black liquors. Numerous round robins have shown that the B&W modification has no effect on the nitrogen values obtained. This test is performed in duplicate.

Sulfur

Sulfur is determined following ASTM D 3177 "Total Sulfur in the Analysis Samples of Coal and Coke." The Bomb Washing Method is used. In this method, Sulfur is precipitated as BaSO₄ from the oxygen bomb calorimeter washings. The precipitate is filtered, ashed, and weighed. This test is performed in duplicate.

Chlorine

Chlorine is determined using ASTM D 2361 "Chlorine in Coal." In this method, the chlorine is determined after combustion of the sample in an oxygen bomb calorimeter. The chlorine is absorbed in alkaline reagent in the bomb. The bomb washings are titrated by a modified Volhard procedure. This test is performed in duplicate.

Sodium and Potassium

Sodium and Potassium are determined by digesting a known weight of black liquor with a mixture of nitric and perchloric acids. After digestion the sample is diluted to a known volume for analysis. Sodium is determined using Inductively Coupled Plasma (ICP) spectroscopy. Potassium is determined using Flame Emission Spectroscopy. These procedures are performed in duplicate.

Inerts

In black liquor analyses, inerts are reported in place of the ash in the classical determination of the ultimate analysis of coal in coke. The inerts are determined by correcting the ash (or ultimate ash) obtained in the carbon and hydrogen determination. The ultimate ash is composed of sodium, potassium, sulfate and carbonate. Sodium and potassium

were determined previously. The ultimate ash is analyzed for carbonate and sulfate. The inerts are then calculated by difference (inerts = $100 - \text{Na}_2\text{O} - \text{K}_2\text{O} - \text{SO}_3 - \text{CO}_2$). The carbonate carbon should be added to the carbon previously determined to obtain the total carbon for the sample. These are single determinations combining the duplicate ashes from the ultimate analysis.

Oxygen

Oxygen is obtained by difference. Oxygen = $100 - \text{carbon} - \text{hydrogen} - \text{nitrogen} - \text{sulfur} - \text{sodium} - \text{potassium} - \text{chlorine} - \text{inerts}$. Values are on a "dry" basis. Moisture must also be subtracted if values are on "as received" basis.

Part 2: Smelt Analyses

Following is a list of procedures used for the analysis of smelts. A brief description is supplied with each procedure. At ARC, the smelt sample is dissolved in treated water and analyzed as a green liquor. Analyses consist of a combination of titrimetric, gravimetric and instrumentation methods. (Essentially identical procedures are used for total sulfur, sodium, potassium and chlorine in fume and ash deposits.)

Sodium Carbonate

Sodium carbonate is determined by direct acid titration. A correction must be made for the sodium hydroxide and sodium sulfite present. This method is derived from the Mead Carbonation Recovery Operation methods. An alternate evolution method is contained in TAPPI 624T, "Analysis of Soda and Sulfate White and Green Liquors."

Sodium Hydroxide

Sodium hydroxide is determined by direct titration after precipitation of the carbonate as barium carbonate. A correction must be made for the sodium sulfite present. (See TAPPI 624T)

Sodium Sulfide

Sodium sulfide is determined by an iodine titration for active alkali with corrections made for the presence of thiosulfate and sulfite. (See TAPPI 624T). If the correction yields a negative value, see sodium hydro sulfide.

Sodium Thiosulfate

Sodium thiosulfate is determined by an iodine titration on a solution in which the sulfide has been precipitated in zinc carbonate and the sulfite reaction with iodine has been inhibited by the addition of formaldehyde. (See TAPPI 624T)

Sodium Sulfite

Sodium sulfite is determined by the difference of the combined thiosulfate and sulfite titration and the titration for the thiosulfate alone. (See TAPPI 624T)

Sodium Hydrosulfide

Sodium hydrosulfide appears in smelts when the sodium hydroxide analysis is a negative value. The amount of (negative value) sodium hydroxide is the amount of sodium hydrosulfide present. The sodium sulfide is corrected for the amount of sodium hydrosulfide.

Total Sulfur

Total sulfur is determined by TAPPI 624T using nitric and perchloric acid to digest the smelt after oxidation with bromine water. The sulfur is precipitated with BaCl. The precipitate is filtered, ashed and weighed.

Sulfate Sulfur

Sulfate sulfur is determined by Mead Carbonation Recovery Operation Method. Analysis consist of a BaCl precipitation after the sulfide sulfur has been boiled off in a solution of excess acid. The precipitate is filtered, ashed and weighed. Sodium sulfate is calculated directly from the sulfate sulfur determined.

Chlorine

Chlorine is determined using the Volhard procedure. In this method, the chlorine is determined by titration with ammonium thiocyanate after the chlorine is absorbed as AgCl₂. Sodium chloride is then directly calculated from the chlorine present.

Sodium and Potassium

Sodium and Potassium are determined by digesting with a mixture of nitric and perchloric acids, then dilute to a known volume. Sodium is determined by Inductively Coupled Plasma (ICP) spectroscopy. Potassium is determined by Flame Emission Spectroscopy.

Carbon

Carbon is determined by a B&W developed method based on ASTM D3178, "Carbon and Hydrogen in the Analysis Sample of Coal and Coke." A known volume, representing a known weight of smelt in solution is filtered and then burned in a closed system purged with oxygen. The combustion products are collected in an absorption train. The carbon is determined gravimetrically.

Reduction and Sulfidity

Reduction and Sulfidity are calculated using the values for the sodium compounds determined above.

APPENDIX F
LETTERS OF INTEREST AND SUPPORT

(THIS PAGE LEFT INTENTIONALLY BLANK)



3006 Northup Way
Bellevue, WA 98004-1407

Phone: 206 828-2400
Fax: 206 828-0526

A Division of Ionics, Incorporated

March 20, 1995

Mr. W.T. Southards
Senior Research Engineer
Babcock & Wilcox R&DD
1562 Beeson Street
Alliance, Ohio 44601

Reference: U.S. Department of Energy High Solids Black Liquor Project

Dear Mr. Southards:

We are pleased to confirm our continuing interest as a potential supplier for future work in high solids black liquor utilization.

Ionics RCC is specifically interested in providing a commercially-proven, vertical tube, falling film, high solids concentrator system for the recovery furnace simulator facility you are proposing to construct at B&W's Alliance Research Center. If, based on further investigation, the decision is made to pursue gasification as part of the program, we are also interested in supporting that technology development with the appropriate black liquor concentrator equipment.

Ionics RCC is a competitive supplier of black liquor evaporator and concentrator systems to the pulp and paper industry. Capacities range up to 160,000 lb/hr black liquor solids throughput with concentrations as high as 80%. We are confident in our ability to provide equipment that meets the demands for the high solids operation you have outlined.

Ionics RCC recognizes the significant value of this research to the pulp and paper industry and looks forward to the opportunity to pursue high solids black liquor utilization through this program.

Very truly yours,
Ionics Resources Conservation Company

Ted M. Fosberg, P.E., Ph.D.
Process Design Manager
Pulp and Paper Applications

(THIS PAGE LEFT INTENTIONALLY BLANK)



Wheelabrator Engineered Systems Inc.

A Wheelabrator Technologies Company
55 Shuman Blvd.
Naperville, Illinois 60563

PH. 708.357.7330
FX. 708.717.2247

HPD Division

March 23, 1995

Babcock & Wilcox
1562 Beeson Street
Alliance, OH 44601

Fax: (216) 829-7283

Attention: Mr. Tom Southards
Project Manager

Subject: Cooperative Agreement with USDOE

Gentlemen:

The Cooperative Agreement between Babcock & Wilcox (B&W) and the U.S. Department of Energy (USDOE) to evaluate means of significantly improving the Kraft Process Recovery provides tremendous opportunities for the investigation of technologies which the Pulp & Paper industry will be looking for in the coming years.

The HPD Division of Wheelabrator Engineered Systems can only welcome the chance given to us to participate with B&W in this development program.

In recent years, HPD has investigated various concentrator designs and configurations aimed at achieving ultra-high solids concentrations (80 + % T.S.) in an energy efficient, environmentally sound and cost effective manner. This R&D work led to the development of our enhanced heat transfer technology which is now a standard for all our black liquor concentrator and indirect heater designs. The use of this concept allows a substantial increase in allowable heat fluxes at high solids along with a substantial reduction in overall power usage.

We believe the B&W / USDOE agreement will allow us to further the development of this technology but also, more globally, to investigate the best integration of our concentrator with the new B&W Advanced Combustion Unit. The issues here involve control of liquor viscosity not just for best operation of the HPD concentrator but for the best operation of the whole HPD / B&W process entity.

To support this effort, HPD is committed to providing B&W with a pilot concentrator system designed for maximum flexibility in mind to allow the independent investigation of global operating conditions (temperature, pressure, etc...) specific design criteria (tube velocities, heat fluxes, etc...) and impact of this unit on the whole mill environment (NCG emissions, sulfur losses, etc...).

HPD considers the B&W / USDOE as the ideal vehicle for the development of a true North American approach to the next generation of Kraft Process Recovery Units. Our mutual know-how, interest and dedication will be a tremendous asset in our common goal of defining the best technology possible.

Very truly yours,

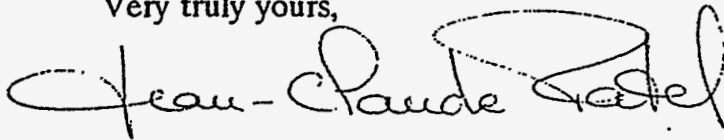
A handwritten signature in cursive script that reads "Jean-Claude Patel". The signature is fluid and includes a large, stylized flourish at the end.

Jean-Claude Patel
Director of Sales

JCP/jm



April 20, 1995

Thomas Southards
Babcock & Wilcox
1562 Beeson Street
Alliance, OH 44601

SUBJECT: IPST Participation in DOE-Sponsored Program on Improved Kraft Recovery Process

Dear Tom:

IPST will be happy to participate in your program targeted at an improved Kraft recovery process. Our participation will be as outlined in the February 20, 1995 letter from your Christopher Verrill and will involve the evaluation of the combustion properties of four black liquor samples. These samples would be provided by B&W. The samples will be evaluated in our single particle combustor. Single drops from each sample will be exposed to two different combustion atmospheres and the combustion process will be recorded on video tape for subsequent analysis of changes in size and shape during combustion. Drop temperature and off-gas analysis for CO and CO₂ will be monitored. Five drops per each sample will be evaluated. Test results and copies of the video tape will be provided to B&W. If desired, representatives of B&W can be present during the running of the tests.

Our estimated cost for this service is \$10,000. Additional charges may occur if equipment or testing changes are needed to meet special needs of B&W,

We support your efforts to provide the paper industry with access to a recovery furnace simulator. Improvements in technology that will result from the use of this facility will lead to improved economies of combustion and power generation. In addition, environmental benefits from improved control of emissions will be likely.

Please contact me if you have any questions.

Sincerely,

Earl W. Malcolm
Chemical & Biological Sciences

cc: Junyong Zhu
Thomas M. Grace

Institute of Paper Science and Technology, Inc.

(THIS PAGE LEFT INTENTIONALLY BLANK)



College of Engineering
Department of Chemical Engineering

PO Box 116005
Gainesville, FL 32611-6005
Phone: (904) 392-0881
Fax: (904) 392-9513
E-Mail: chemical@engnet.ufl.edu

March 24, 1995

Dr. Thomas Southards
Babcock & Wilcox Company
Alliance Research Center
1562 Beacon Street
Alliance, OH 44601

Dear Dr. Southards:

This letter is in response to the telephone conversation of March 21, 1995 between Dr. Zaman of our group and you concerning physical properties of black liquors.

At the University of Florida, we are able to characterize black liquors by four categories of chemical and physical analysis. These are:

1. Chemical analyses for major components, except high molecular weight saccharinic derivatives and TAPPI test analyses
2. Lignin molecular weight characterization
3. Thermal and thermodynamic analyses
4. Rheological analyses

We have developed fundamentally based data reduction correlations for heat capacity, heat of dilution, density, thermal expansion, and rheological properties that have been shown to be applicable to both our experimental liquors and to mill liquors that we have obtained from a number of sources. These mill liquors and liquors from other sources include liquors from carbonate, sulfite, and solvent pulping processes. For the experimental liquors, we have made excellent progress in correlating these properties to pulping conditions and to the composition of the black liquor solids. We believe, based on our experience with use of data reduction correlations, that these overall correlations will serve as a guide to estimate the effects of changing pulping conditions on liquors from species other than Slash Pine. Finally, we have been able to show that the results of thermodynamic measurements are thermodynamically consistent and that rheological results are in agreement with accepted theories for rheological properties of polymer solutions.

At this point, we believe that we are leaders in research directed toward a fundamental understanding of the behavior of black liquors, and we have successfully characterized black

liquors for mills located worldwide, but especially in the US and Canada, over the past few years. We are very well equipped to perform these studies in a complete and efficient manner, and we are very willing to support your effort in every way that we can.

Dr. Verrill was sent information on costs for services in a letter addressed to him at Babcock & Wilcox. We will forward a complete cost estimate for the specific services that you require when necessary.

Please let us know if there are any further details that you require from us.

Sincerely,

A handwritten signature in cursive script that reads "Arthur L. Fricke".

Arthur L. Fricke

cc: Dr. A. A. Zaman
Mr. S. F. Sobczynski, DOE

APPENDIX G
ECONOMIC JUSTIFICATION

(THIS PAGE LEFT INTENTIONALLY BLANK)

TABLE OF CONTENTS

<u>Section</u>	<u>Page</u>
G.1 BACKGROUND.....	G-1
G.1.1 Introduction.....	G-1
G.1.2 International Competitiveness.....	G-1
G.1.3 Environmental Compliance.....	G-3
G.1.4 Industry Outlook.....	G-3
G.1.5 New Technology Outlook.....	G-4
G.2 THE ECONOMICS OF HIGH SOLIDS FIRING.....	G-4
G.2.1 Assumptions.....	G-4
G.2.2 Economic Analysis.....	G-6
G.2.3 "Low Odor Conversion Upgrade \$ Gain/Loss Analysis": Two-Effect Concentrator Installed in Six-Effect Economy.....	G-7
G.2.4 "Low Odor Conversion Upgrade \$ Gain/Loss Analysis": Two-Effect Concentrator Installed in Two-Effect Economy.....	G-8
G.2.5 "Low Odor Conversion \$ Net Present Value Analysis": Two Effect Concentrator Installed in Six-Effect Economy.....	G-9
G.2.6 "Low Odor Conversion \$ Net Present Value Analysis": Two-Effect Concentrator Installed in Two-Effect Economy.....	G-10
G.3 ECONOMIC ANALYSIS: CONCLUSION.....	G-11
G.4 REFERENCES.....	G-11
EXHIBITS.....	G-12

(THIS PAGE LEFT INTENTIONALLY BLANK)

APPENDIX G: ECONOMIC JUSTIFICATION

G.1 BACKGROUND

G.1.1 Introduction

The forest, wood and paper industry is a leading contributor to the U.S. economy and employs over one and a quarter million people while producing products valued at over \$200 billion per year (1). The U.S. paper and allied products industry is recognized worldwide as a high quality, high volume, low-cost producer that benefits from a large consumer base, a modern technical infrastructure, adequate raw materials, and a highly skilled labor force.

The industry ranks eighth among U.S. manufacturing industries in the value of its shipments, and third among nondurables sectors in sales (2). It ranks second in capital expenditures, according to the most recent Bureau of the Census data. In addition, although the paper industry is one of the largest U.S. consumers of energy, ranking third behind metals and chemicals, it also has the highest rate of self-generation energy, totaling over 56% in 1992-93.

Despite depressed prices and earnings, shipments of paper and allied products climbed about 3 percent in real terms during 1994. Although shipments are up, manufacturers are still struggling to make much needed capital expenditures for plant modernization during a time of reduced profitability. As a result, for the first time in recent years, improvements and rebuilds of existing machinery and equipment were reported to have exceeded the installation of new machines.

This phenomenon should continue into the future given the significant savings that upgrading existing facilities represents in comparison to building new output capability.

G.1.2 International Competitiveness

U.S. wood products valued at \$7.3 billion were exported in 1993. Because of tightened lumber supply in the Pacific Northwest and fewer overseas log exports, imports valued at \$8.3 billion surpassed exports. Exports of U.S. pulp and paper products were also considerable in 1993, totaling \$9.6 billion. The relatively strong economic growth in the U.S., coupled with recessions in major industrialized countries, created a surge of paper and paperboard imports into the country. In 1993, U.S. pulp and paper imports were valued at \$10.6 billion (1).

In spite of the success of the U.S. forest, wood, and paper industry, it has significant challenges ahead in meeting the changing standards of society while remaining economically viable and globally competitive. Land available for growing commercial wood is diminishing, and pressures are building to remove even more public lands from commercial production. In addition to driving up prices, this puts pressure on the industry to use lower

quality wood which can in turn result in higher energy usage. This reduced availability of large timber has shifted wood-based building materials towards engineered products which are more energy and capital intensive (1). A litany of concerns related to U.S. competitiveness exist among domestic participants on both the demand and supply sides of the market pulp industry. Potential negative factors on the "demand side" of the market are:

- slowing economic growth in North America in reaction to rising interest rates,
- the possibility of a deceleration in European economic growth due to a weak performance in the consumer sector,
- a high probability of a consumer inventory reduction in North America and European paper markets in the second half of 1995,
- expanding integrated pulp production in the Far East as a result of higher operating rates in Japan and an increasing amount of integrated capacity, especially in Indonesia,
- the startup of significant amount of integrated and deinked market pulp capacity in the U.S. over the course of 1995 with this output destined mainly for the important printing and writing paper market.

Concerns on the "supply side" of the market pulp business include:

- rising output from the two large Indonesian pulp lines that started in the latter part of 1994,
- the restart of three market BCTMP lines in eastern Canada,
- the reopening of several small chemical pulp lines in North America,
- settlement of the FC Canada Labor situation and the task of putting this capacity back into the market.
- an assumed shift of some pulp capacity back from integrated to market output in the second half of 1995 in association with the projected slowdown in North America and European paper demand,
- the incentive to run all mills at full capacity due to the high price of pulp
- the ability of the pulp industry to attract more supplies of pulpwood as a result of sharply higher prices being paid for fiber.

Developing countries (e.g. Chile, Indonesia, and South Africa) are now setting the pace as low cost producers of pulp and some paper products; this is due to their low cost of labor and wood, and subsidies from their governments. Other lesser developed countries with abundant wood resources will likely join these challengers. In addition, Canada and the

Scandinavian countries have traditionally been strong competitors in the forest products industry. Because of the high dependence of their national economies on forest products, they will undoubtedly continue to press the U.S. producers with high quality, low cost products and innovative technological developments.

G.1.3 Environmental Compliance

In the three years through 1994, U.S. companies surveyed had spent continuously less on mill improvements due to global economic conditions. With the industry's expansion winding down from the record 1987-90 period, environmental improvements have actually replaced capacity additions as the driving force behind capital spending plans. Stricter state and federal standards have prompted projects to add secondary treatment plants, control odorous emissions, and reduce or eliminate the use of elemental chlorine.

Amendments to the Clean Air Act, signed into law at the end of 1990, provide for extensive changes to existing regulations regarding sources of ozone, carbon monoxide, and particulate matter, which could have a profound effect on pulp and paper mills in regions where ambient air quality does not meet health-based national standards. Guidelines already enacted and soon to be promulgated will require paper companies to demonstrate, on a case-by-case basis, that they are in compliance with all existing air standards, or that the benefits of a mill significantly outweigh the costs of complying with anti-pollution regulations.

G.1.4 Industry Outlook

Corporate restructuring continues within the industry, although merger and takeover activity has declined due to the uncertain economy and poor cash flows. Some major acquisitions were actually followed by divestitures, consolidations, and closings of less profitable operations.

By controlling operating rates and improving sales and distribution methods, manufacturers are poised for a steady growth period. According to industry forecasts, shipments of paper and allied products are expected to grow at an average annual rate of more than 2 percent through 1998. Exports are expected to grow faster than domestic sales, however, the reliability of this forecast is greatly affected by the strength of the dollar versus foreign currencies and the corresponding effect on the cost of U.S. exports abroad.

Significant structural, technological, and organizational changes should keep the U.S. industry highly competitive in both domestic and international markets. However, competition from abroad will intensify as foreign paper companies in developing countries improve their product quality and compete more aggressively in major Western markets. Prior to the 1990's the U.S. was the clear technical leader in pulp and paper science, processes and equipment manufacture. However, the Scandinavian countries and Canada have taken the lead in many areas (3).

The tremendous capital investment in plant improvements and environmental compliance during the 1980s have taken a toll on U.S. industry cash flow and debt levels.

The prospect of additional scarce industry capital being needed to meet more costly environmental requirements further threatens the industry's global competitiveness. These issues present a major challenge in the next decade to regain and maintain U.S. leadership positions and assure that the pulp and paper industry continues to be a positive contributor to the U.S. economy and trade balance.

G.1.5 New Technology Outlook

A number of new technologies, operation modes, and system configurations will advance the state-of-the-art of pulp and paper production throughout the world in the next few years.

Each of the major pulp and paper companies in the world today are continually weighing the investment in such technology (and the R&D that precedes its introduction) against the economic ramifications that accompanies such investment. Basic papermaking has been around for nearly 2,000 years, and the pulp and paper industry in general, spends conservatively on developing the craft. U.S. pulp and paper companies spend on average about 1.1% of their annual sales on R&D.

Most scientific effort in the pulp and paper industry has gone into developing new products and improving existing ones. In recent years, however, public concern over the quality of the environment has set a new course for most R&D agendas. Recycling and mill pollution issues have captured bigger headlines and have been the cause for more stringent legislation, prompting the industry to spend more on "greening" its performance and image.

Spending on environmentally motivated capital should continue to increase as environmental issues affecting the pulping process continue to become more stringent. Such issues include: recycling of post-consumer waste, sludge incineration to reduce landfill volume, chlorine-free bleaching to eliminate emission of chlorine compounds, greater energy efficiency to reduce power plant emissions, and zero discharge of liquid effluent (4).

Environmental based technology changes will be the most important factors that distinguish the mill of 1995 and the mill of 2005. However, new technology will also play a major role in maintaining older mills and equipment and in facilitating incremental capacity additions of existing equipment. One method of both helping to comply with existing and forthcoming environmental regulations and increasing both the life and performance characteristics of existing mills is via the conversion to "high solids firing".

G.2 THE ECONOMICS OF HIGH SOLIDS FIRING

G.2.1 Assumptions

It is anticipated that recovery boilers using "direct contact" evaporators will require "low odor conversions" under the new E.P.A. cluster rules. This means eliminating the direct contact evaporator and replacing it with a solids concentrator which uses steam to concentrate the liquor and then installing a long flow economizer to utilize the heat in the flue gas. This

economizer addition increases efficiency and steaming capacity which subsequently affects superheat temperature possibly requiring additional superheat surface.

In order to define the economics associated with increasing solids firing levels from low (i.e., approximately 65-70%) concentrations to high (i.e., 75-85%) concentrations, a number of different assumptions and scenarios were developed. The major assumptions are stated in Items A-F that follow.

- A. Mills that have not yet converted to low odor operations are considered to be the most likely candidates for high solids firing upgrades. This is due to the fact that increasing the unit capacity (via the addition of a high solids concentrator) in conjunction with a low odor conversion is a means of economically justifying the environmentally-based low odor conversion expenditure. The increased process steam availability and electricity generated that accompanies a high solids firing upgrade helps to offset the investment for the low odor conversion.
- B. Approximately 160 million pounds of solids per day are processed within the 88 U.S. units that have not been converted to low odor operations. Depending upon the final timing and content of the E.P.A. "cluster rules", owners of each of these units will likely need to select one of five actions. These actions are:

Direct Evaporator Compliance Options

- 1. Convert the unit to low odor operations,
 - 2. Replace the boiler and system at the site,
 - 3. Close the unit or mill and increase the capacity elsewhere,
 - 4. Close the unit and add a new unit elsewhere,
 - 5. Close the unit and not add replacement capacity.(5)
- C. For the purposes of this analysis, a representative unit amenable to conversion was selected as a candidate for study. This unit is typical of many of the existing units that will be converted during the next decade. It is a 48% virgin solids concentration direct contact evaporator unit rated at a solids rate of 2,940,000 lbs./day with a gross steam flow of 370,100 lbs./hr. Electrical generation of the representative unit equates to 20,138 kw.
 - D. Exhibits G-1, G-2, and G-3 depict financial analyses associated with two typical low odor upgrade scenarios for an existing direct contact evaporator facility firing at a 48% solids rate. Henceforth referred to a Scenario A1, A2, A3 and B1, B2, B3 each of these scenarios reflects a different configuration with regard to solids firing (75%, 80%, 85%) and whether or not a 21% upgrade in overall capacity accompanies the low odor conversion.

In addition, two distinct cases are examined that include representative concentrator/economies for the population of the 88 units most likely to be upgraded via low odor conversions. Specifically, a two-effect concentrator installed in a six-effect economy and a two-effect concentrator installed in a two-effect economy are analyzed for all six scenarios.

- E. In Scenario A1, A2, and A3, it is assumed that a mill may also choose to accompany the low odor upgrade with a high solids upgrade in an effort to increase both steam and electric production.

This assumption is based upon the fact that the incremental cost of going to high solids firing during a low odor conversion is relatively small in relationship to the total cost of the low odor conversion. In this case, the principal additional cost is attributed to the increased concentrator size.

- F. Scenario B1, B2, and B3 depicts a similar potential upgrade scenario for an existing direct contact evaporator plant during a low odor conversion resulting in a high solids upgrade that increases both steam and electric production. In addition, it is further assumed that a 21% increase in capacity would also accompany the high solids firing upgrade. The assumption that some mills will choose to increase capacity during a low odor conversion is based upon the fact that the incremental cost of going to high solids firing (with an additional capacity upgrade) during a low odor conversion is relatively small in comparison to the entire cost of the low odor conversion. The principal additional cost of a 21% capacity upgrade is attributed to the modifying (or modernizing) the existing boiler.
- G. Based upon industry statistics a 95% utilization rate is assumed throughout the economic analyses. In addition, a 4¢/kw hour cost of electricity is assumed for the purpose of both crediting increased output or debiting increased demand for externally supplied electric. Since, in most cases a credit is obtained, the 4¢ figure is considered to be "conservative" for most geographic regions. Finally, a \$2.25/per 1000 lb of steam value is placed on the cost of process steam produced by each system configuration. This value is representative of the steam that could be produced from a fuel source other than liquor.

G.2.2 Economic Analysis

The economic analyses associated with the high solids firing scenarios evaluated are "operating performance-based" analyses. They include operating input and output parameters that have been analyzed via engineering systems algorithms and subsequently converted to economic information. They do not contain overall economic data corresponding to unit or mill pulp output. This is primarily due to the wide differences associated with individual plant performance. In addition, the performance based output (i.e., gain/loss kw and steam) are easily convertible to end product output (i.e., pulp) by users and are typically contained within end user calculations utilized to analyze capital expenditure decisions.

As previously stated in the assumptions for these analyses, all changes in operation are predicated upon a representative direct contact evaporator unit typical of many of the existing units that will be converted during the next decade. It is a 48% virgin solids concentration direct contact evaporator unit rated at a solids rate of 2,940,000 lbs./day with a gross steam flow of 370,100 lbs./hr. Electrical generation of the representative unit equates to 20,138 kw. Two effect concentrators installed in either six-effect or two-effect economies are examined for all cases (A1-B3).

G.2.3 'Low Odor Conversion Upgrade \$ Gain/Loss Analysis': Two-Effect Concentrator Installed in Six-Effect Economy

The first analysis (contained in Exhibit G-1) examines the various operating parameter changes associated with a direct contact evaporator's low odor conversion. As can be seen in the analyses, for cases A1, A2 and A3 where a low odor conversion is accompanied by 75%, 80% and 85% solids firing (respectively), the primary change to the output characteristics is in the gross steam flow and then to the 65 psia steam to process resulting in increases in both process steam availability and electrical generation.

The resultant economic gains for cases A1, A2 and A3 are gains associated with the gains in steam to process and electric output. These gains, due to the low odor conversion and accompanying high solids firing upgrades result in more steam and electricity to the mill that would have otherwise been purchased or foregone. For these cases, and all cases to follow, economic translation of performance gains/losses is as follows:

Electric:

\$ NET GAIN/LOSS (kw) =

$$(\text{NET GAIN kw}) \times 24 \times (365 \times .95) \times \$.04$$

Where; 24 = Hours in a day
 365 = Days in a year
 .95 = Utilization rate of 95%
 \$.04 = 4 cents per kw hour electric rate

Steam:

Process Steam Increase/Decrease =

$$(\text{NET GAIN/LOSS Steam}) \times 24 \times (365 \times .95) \times \$2.25$$

Where; 24 = Hours in a day
365 = Days in a year
.95 = Utilization rate of 95%
\$2.25 = \$2.25 per 1000 lb. of steam (production cost)

In cases A1, A2 and A3 the economic performance gains increase as the virgin solids concentration increases. It should be noted that these gains are not linear with regard to solids concentration levels. For instance, moving from case A1 (75% solids) to case A2 (80% solids) results in a approximate economic gain of 28% (from \$976k to \$1,254k). However, moving from case A2 (80% solids) to case A3 (85% solids) results in an economic gain of about 20%.

Cases B1, B2, and B3 are analyzed wherein a 21% capacity increase (in the solids processing rate) accompanies the low odor conversion. Overall, the 21% increase in capacity results in much larger economic performance gains (i.e., electric, steam, and total gains) than those not including the capacity increase. Total gains, for all three solids concentrations are approximately three times the gains associated with case A1, A2, and A3. In addition, as was the case previously, a non-linear positive trend accompanies economic performance gains related to higher solids firing levels.

G.2.4 'Low Odor Conversion Upgrade \$ Gain/Loss Analysis': Two-Effect Concentrator Installed in Two-Effect Economy

Changing the base case to a two-effect economy, resultant performance gains/losses change dramatically. As can be seen in cases A1, A2, and A3 (in Exhibit G-1) the differences due to a two-effect economy versus the six-effect economy are primarily related to the decrease in process steam available due to the two-effect economy concentrator. Subsequent electric and steam gains/losses are effected by the increase demand for steam in the two-effect mode. The overall process steam available in all cases (A1, A2, and A3) is less (and actually results in a negative figure) due to the fact that more steam is required than is produced at all three solids concentrations.

As were Cases B1, B2, and B3 in the six-effect economy (wherein a 21% capacity increase in the solids rate accompanies the low odor conversion), the increase in capacity once again results in much larger economic performance gains (i.e., electric, steam, and total gains) than those not including the capacity increase. Total gains, for all three solids concentrations are all at least six times the gains associated with case A1, A2, and A3. In addition, as were the cases previously, a non-linear positive trend accompanies economic performance gains related to various high solids firing levels.

It should also be noted that in Case A (related to the two-effect economy) a U-shaped curve exists with regard to total economic gain. More specifically, for low odor cases without increase in capacity (i.e., case A1, A2, and A3) moving from 75% solids to 80% solids actually results in a reduction in total economic gain. This is explained by the fact that at 80% solids concentration 150 psia steam is needed for the concentrator. The related drop in electrical generation produces a drop in the gross increased generation. The

drop in gross increased generation results in a corresponding drop in the economic electric gain at 80% and forces the total gain below that of the 75% solids case. As can be seen in case A3, this offset is no longer visible when solids concentrations are increased from 80% to 85%. After the increase to 85% the total economic gain is once again greater than the previous solids concentration gain at the 80% level. This economic phenomenon is not evident in case B (with the 21% increase in capacity accompanying the low odor conversion); however, a corresponding drop in gross increased generation does exist and the total economic gain from 75% to 80% solids is much less than that from 80% to 85% solids.

G.2.5 "Low Odor Conversion \$ Net Present Value Analysis": Two-Effect Concentrator Installed in Six-Effect Economy

Exhibit G-2 depicts the economic analysis associated with the both a low odor conversion (i.e., cases A1, A2 and A3) and a low odor conversion accompanied by a 21% increase in capacity (i.e., cases B1, B2, and B3). As was the case in the economic gain/loss analysis (Exhibit G-1) this analysis is limited to the calculation of a net present value associated with performance outputs specific to process changes evaluated. It does not incorporate consideration of the ultimate product (i.e., pulp) increase due to capital expenditure because of the wide range of exogenous variables associated with different units' ability to convert added capacity to product.

Installed costs for both the six-effect and two-effect economy cases were derived as follows:

Low Odor Conversion Cost:	\$14,000,000
21% Capacity Increase Cost:	\$2,000,000
75% Solids Concentrator Cost:	\$2,410,000(6)
80% Solids Concentrator Cost:	\$2,690,000(6)
85% Solids Concentrator Cost:	\$3,120,000(6)

Cost of Capital: 15%

Revenue Period: 20 years

The net present value calculation associated with each case includes both the cost of the conversion/upgrade and the 20 year "revenue stream" as generated based upon the annualized calculation in Exhibit G-1. Once again, purely from a performance perspective, the net present value figures generated in the analyses represent the net gain/loss related to investment cost versus performance improvements.

In cases A1, A2 and A3 a negative net present value accompanies the low odor conversion regardless of solids concentration. However, as solids concentrations increase the negative net present value decreases. More specifically, if a mill is converted from a direct

contact evaporator via a low odor conversion this analysis suggests that the higher the solids level will achieve the lower the overall negative net present value.

In cases B1, B2 and B3 the net present value associated with the low odor conversion turns positive due to the 21% capacity increase associated with the low odor conversion. Although the initial capital cost is increased from case A1, A2, and A3, the resultant increase in net economic gain far exceeds the marginal cost associated with the capacity increase. In addition, as was the case in A, as solids concentration increases so does the net present value of the investment. For all cases a break-even value is calculated. Once again, this value (representing a number of years) incorporates economic performance output changes over economic investment. When greater than 20 years, the break-even is not considered, given the predicted life of the equipment.

In general, it is obvious that it would be very short sighted to perform a low odor conversion without at the same time increasing capacity. This is actually a common practice among those mills that have or are going to convert to low odor operations due to the fact that such an expansion in capacity often economically justifies an environmental based capital expenditure.

G.2.6 'Low Odor Conversion \$ Net Present Value Analysis': Two-Effect Concentrator Installed in Two-Effect Economy

In cases A1, A2, and A3 the net present value associated with a low odor conversion is once again negative. In essence, this says that the low odor conversion is unable to pay for itself in terms of increase performance and is only done as an environmental compliance measure. The most notable difference between the two-effect economy and the previously examined six-effect economy is that even if a 21% capacity increase accompanies the low odor conversion (as in cases B1, B2, and B3) the net present value associated with performance outputs and cost remains negative. This is explained by the decreased annual economic gain in the two-effect economy case versus the six-effect economy. It should also be noted that, once again, the U-shape curve associated with the 150 psia steam requirements at 80% solids (and above) is evident in the two-effect economy case. In addition, although a marginal increase in the economic gain associated with going from 80% to 85% solids does exist, it is relatively small in comparison to similar gains in a six-effect economy. The results of the net present value analysis for both two-effect and six-effect concentrator economy are shown graphically in Exhibit G-3.

G.3 ECONOMIC ANALYSIS: CONCLUSIONS

Based upon the previous analyses it is obvious that if a mill is going to convert a direct contact evaporator system via a low odor conversion that an accompanying upgrade in capacity makes economic sense. However, it is less obvious whether an accompanying increase to 80% or 85% solids firing is economically justifiable. In the case of a concentrator installed with a six-effect economy, the merits of achieving as high of a solids concentration as possible during a low odor conversion and capacity upgrade are seemingly obvious. However, the merits of going to higher solids levels (i.e., from 75% to either 80% or 85%) are less obvious in the two-effect economy regardless of whether a capacity upgrade accompanies the low odor conversion.

In an effort to account for the performance high solids firing over the next twenty years, Exhibit G-4 "Total Market Value for High Solids Firing" depicts an economic profile for the industry as a whole. As in previous cases, net present value calculations reflect only economic gains/losses associated with performance changes related to steam and electric output due to plant upgrades. In this exhibit, annual gains/losses are aggregated for the industry under four different penetration rate scenarios.

Given that 88 facilities in the U.S. are currently considered to be low odor conversion candidates, a sensitivity analysis was done at 20%, 40%, 60%, and 80% adoption rates. For example, at 20% adoption, the calculation for a 20 year period accounts for 0.20 times 88, or 17.6 plants converted to low odor operations. Only 80% and 85% solids levels are examined in the exhibit because a low odor conversion with current technology will likely firing at 65% - 75% solids

G.4 REFERENCES

1. Agenda 2000: A Technology Vision and Research Agenda for America's Forest, Wood and Paper Industry (1994), American Forest and Paper Association.
2. U.S. Industrial Outlook (1994), U.S. Department of Commerce.
3. World Pulp Monthly (1995), Resource Information Systems, Inc.
4. The 2020 Mill - Utility Requirements for Market Kraft Pulp (1995), Tappi Journal, pps. 175-184, (March).
5. North American PR Boiler Market Overview (1994) Babcock and Wilcox Research and Development Division, (June).
6. Adapted from Goslin-Birmingham Letter to B&W (1995).

(THIS PAGE LEFT INTENTIONALLY BLANK)

APPENDIX G
EXHIBITS

(THIS PAGE LEFT INTENTIONALLY BLANK)

EXHIBIT G-1 "HIGH SOLIDS FIRING GAIN/LOSS ANALYSIS"

	CASE:	TWO-EFFECT CONCENTRATOR INSTALLED IN SIX-EFFECT ECONOMY						
		DIRECT CONTACT	A1 LOW ODOR CONVERSION	A2 LOW ODOR CONVERSION	A3 LOW ODOR CONVERSION	B1 LOW ODOR/ 21%INC.CAP.	B2 LOW ODOR/ 21%INC.CAP.	B3 LOW ODOR/ 21%INC.CAP.
VIRGIN SOLIDS CONCENTRATION	%	48	75	80	85	75	80	85
SOLIDS RATE	LBS/DAY	2,940,000	2,940,000	2,940,000	2,940,000	3,564,000	3,564,000	3,564,000
GROSS STEAM FLOW	LBS/HOUR	370,100	408,700	421,200	430,900	498,600	513,700	528,500
65 PSIA STEAM TO PROCESS	LBS/HOUR	222,000	242,900	253,500	261,400	298,000	310,700	320,400
PROCESS STEAM INCREASE	LBS/HOUR	BASE CASE	20,900	31,500	39,400	76,000	88,700	98,400
ELECTRICAL GENERATION	kw	20,138	22,495	22,932	23,494	27,468	27,992	28,680
GROSS INCREASED GENERATION	kw	BASE CASE	2,357	2,749	3,357	7,330	7,854	8,542
GROSS GAIN (CORRECTED)	kw	BASE CASE	NA	NA	NA	6,058	6,491	7,060
NET GAIN	kw	BASE CASE	1,757	1,994	2,357	5,332	5,523	5,850
\$ NET GAIN/LOSS (kw)	\$/YEAR	BASE CASE	\$585,292	\$664,241	\$785,164	\$1,776,196	\$1,839,822	\$1,948,752
\$ NET GAIN/LOSS (Steam)	\$/YEAR	BASE CASE	\$391,624	\$590,247	\$738,277	\$1,424,088	\$1,662,061	\$1,843,819
TOTAL ECONOMIC GAIN/LOSS:			\$976,916	\$1,254,488	\$1,523,441	\$3,200,284	\$3,501,882	\$3,792,571

TWO-EFFECT CONCENTRATOR
INSTALLED IN TWO-EFFECT ECONOMY

65 PSIA STEAM TO PROCESS	LBS/HOUR	222,000	204,270	210,400	214,600	251,300	261,360	266,730
PROCESS STEAM INCREASE	LBS/HOUR	BASE CASE	(17,730)	(11,600)	(7,400)	29,200	39,630	44,730
ELECTRICAL GENERATION	kw	20,138	22,495	22,217	22,720	27,468	27,180	27,922
GROSS INCREASED GENERATION	kw	BASE CASE	2,357	2,079	2,582	7,330	7,042	7,780
GROSS GAIN (CORRECTED)	kw	BASE CASE	NA	NA	NA	6,058	5,820	6,430
NET GAIN	kw	BASE CASE	1,757	1,279	1,582	5,332	4,852	5,220
\$ NET GAIN/LOSS (kw)	\$/YEAR	BASE CASE	\$585,292	\$426,060	\$526,996	\$1,776,196	\$1,616,298	\$1,738,886
\$ NET GAIN/LOSS (Steam)	\$/YEAR	BASE CASE	(\$332,225)	(\$217,361)	(\$138,661)	\$547,150	\$742,587	\$838,151
TOTAL ECONOMIC GAIN/LOSS:			\$253,067	\$208,700	\$388,335	\$2,323,345	\$2,358,885	\$2,577,037

NET PRESENT VALUE ANALYSES

HIGH SOLIDS FIRING (75%, 80%, 85%)

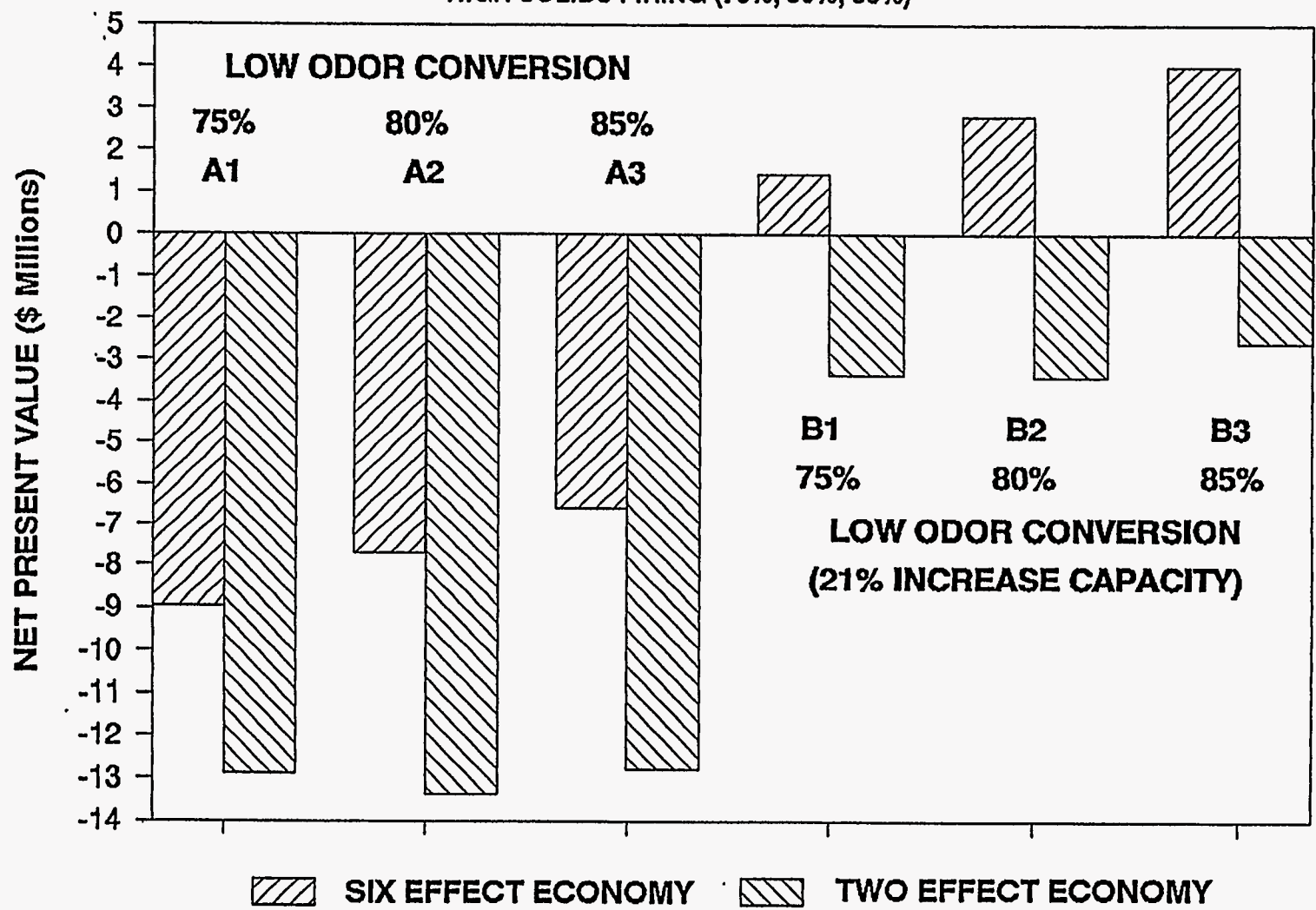

EXHIBIT G-4 "TOTAL MARKET VALUE FOR HIGH SOLIDS FIRING"

CASE:	A1	A2	A3	B1	B2	B3
TWO-EFFECT CONCENTRATOR INSTALLED IN SIX-EFFECT ECONOMY	<u>LOW ODOR CONVERSION</u>	<u>LOW ODOR CONVERSION</u>	<u>LOW ODOR CONVERSION</u>	<u>LOW ODOR/ 21% INC. CAP.</u>	<u>LOW ODOR/ 21% INC. CAP.</u>	<u>LOW ODOR/ 21% INC. CAP.</u>
SOLIDS:	75	80	85	75	80	85
TOTAL COST:	(\$16,410,000)	(\$16,690,000)	(\$17,120,000)	(\$18,410,000)	(\$18,690,000)	(\$19,120,000)
TOTAL GAIN:	\$976,916	\$1,254,488	\$1,523,441	\$3,200,284	\$3,501,882	\$3,792,571
NPV:	(\$8,952,312)	(\$7,684,993)	(\$6,595,024)	\$1,410,119	\$2,808,211	\$4,016,487
TOTAL GAIN/LOSS DUE TO SOLIDS INCREASE: (20 YEAR PERIOD)		\$1,267,319	\$1,089,969		\$1,398,091	\$1,208,276
INDUSTRY GAINS DUE TO SOLIDS INCREASE: (20 YEAR PERIOD)						
20% ADOPTION RATE:		\$22,304,811	\$19,183,456		\$24,606,409	\$21,265,664
40% ADOPTION RATE:		\$44,609,623	\$38,366,913		\$49,212,817	\$42,531,328
60% ADOPTION RATE:		\$66,914,434	\$57,550,369		\$73,819,226	\$63,796,991
80% ADOPTION RATE:		\$89,219,246	\$76,733,825		\$98,425,634	\$85,062,655
TWO-EFFECT CONCENTRATOR INSTALLED IN TWO-EFFECT ECONOMY						
TOTAL COST:	(\$16,410,000)	(\$16,690,000)	(\$17,120,000)	(\$18,410,000)	(\$18,690,000)	(\$19,120,000)
TOTAL GAIN:	\$253,067	\$208,700	\$388,335	\$2,323,345	\$2,358,885	\$2,577,037
NPV:	(\$12,892,147)	(\$13,377,113)	(\$12,773,291)	(\$3,362,966)	(\$3,413,005)	(\$2,599,539)
TOTAL GAIN/LOSS DUE TO SOLIDS INCREASE: (20 YEAR PERIOD)		(\$484,966)	\$603,822		(\$50,039)	\$813,466
INDUSTRY GAINS DUE TO SOLIDS INCREASE: (20 YEAR PERIOD)						
20% ADOPTION RATE:		(\$8,535,394)	\$10,627,259		(\$880,688)	\$14,316,994
40% ADOPTION RATE:		(\$17,070,788)	\$21,254,518		(\$1,761,377)	\$28,633,989
60% ADOPTION RATE:		(\$25,606,181)	\$31,881,777		(\$2,642,065)	\$42,950,983
80% ADOPTION RATE:		(\$34,141,575)	\$42,509,036		(\$3,522,754)	\$57,267,978

APPENDIX H
BLACK LIQUOR GASIFICATION

(THIS PAGE LEFT INTENTIONALLY BLANK)

APPENDIX H. BLACK LIQUOR GASIFICATION

The U.S. Pulp and Paper Industry is becoming more interested in black liquor gasification (BLG) as a means of increasing their competitive position versus the rest of the world. Through discussions with selected customers, B&W has identified the basic driving forces in this area and is attempting to develop a process that will satisfy the customers needs.

There is a strong need for methods of adding low cost incremental capacity to handle black liquor. As mills make incremental equipment additions or changes to the process in other parts of the mill, the flow of black liquor will increase. At some point the increased flow exceeds the rated capacity of the process recovery boiler(s). An approach to handling the additional increased input is a major upgrade of the boiler. The approach of applying the Tomlinson recovery furnace is less economical in small sizes. Development of a BLG with a nominal capacity of 480,000 to 650,000 lbs of dry solids/day, that could operate in parallel with the recovery unit would address this problem.

Another driving force for gasification is the increased demand for electric power in a pulp mill without a corresponding increase in steam demand. For example, pollution control systems include many electric motors for material handling and aeration. Production of a fuel gas that can be burned in a gas turbine will satisfy this need. A combined cycle where the turbine exhaust gas is sent to a heat recovery steam generator will improve the overall process efficiency.

Another need that can be addressed through development of BLG is the continual desire for improved safety and lower emissions. Elimination of the need to handle molten smelt would remove one of the major safety risks of the recovery furnace, the potential for smelt-water explosions.

B&W has spent considerable effort before the award of this contract in developing a gasifier design concept that will satisfy the customers needs. This effort identified a low temperature process, i.e., one that operates below the melting point of the product sodium compounds, as having the best potential to satisfy the process requirements. The low temperature process is inherently safer since it eliminates the potential for smelt-water explosions. In addition to having no smelt, thermodynamics indicates that the sodium product will be predominately sodium carbonate, Na_2CO_3 , which is generally considered non-explosive. Most of the sulfur will be released as hydrogen sulfide (H_2S) at thermodynamic equilibrium. The H_2S must be reabsorbed to produce the green liquor returned to the pulping process. The low temperature process is ideally suited for a fluidized bed reactor since it will give a long residence time for the solid reactants. The low temperature process also simplifies construction since the gasifier vessel is essentially an adiabatic reactor with no heat flow to or from the gasifier walls.

Other requirements that the gasifier process must satisfy include minimum unburned carbon in the bottom product. This material is a direct energy loss and complicates the down stream processing of the green liquor. Large quantities would require addition of a filter and carbon recycle for combustion. The gasifier reactor should also have a minimum demand for external heat input. If heat must be added by in-bed heat transfer surface, the high temperature surface could melt some of the bed material leading to agglomeration and defluidization. Finally the product gas should have a minimum heating value of 100 to 150 Btu/DSCF (dry standard cubic foot) from the initial installation. This is compatible with existing burner designs and is a good starting point for further improvements designed to raise the heating value for gas turbine applications.

A number of different gasifier concepts were evaluated in some detail. Process flow diagrams were prepared for each concept to ensure that no significant operations were omitted. Material and energy balances were developed to identify all flows to and from the process. Particular attention was paid to the heating requirements to balance high temperature waste heat with steam demand. At this stage thermo-dynamic equilibrium between the bed materials and the product gas at the designated temperature was assumed. The possibility of non-attainment of equilibrium composition due to mass transfer or chemical kinetics limitations were recognized but not factored into the evaluation.

The first process evaluated was a direct pyrolysis process. Black liquor would be sprayed onto the bed which would be fluidized by recycle of the product gas. This process generated a gas with a high heating value but had a very low carbon conversion. This evaluation indicated there was insufficient oxygen available in the liquor to consume all the carbon. A number of different oxygen sources were then considered such as pure oxygen, air, steam, and carbon dioxide.

The carbon dioxide gasification process extracts CO_2 from the gasifier product gas and uses it to fluidize the bed as well as react with the char carbon. The process had a higher product gas heating value but no significant reduction in unreacted carbon and therefore no advantage over the pyrolysis process. The additional process steps required to absorb and strip the CO_2 used for recycle added complexity to the cycle. The improvement in heating value could be achieved in any cycle by removing the CO_2 but will require finding an economic use for the extracted gas.

The steam gasification process uses low pressure steam to fluidize the bed and carry out the carbon-water shift reaction with the char carbon. This process is very effective in producing a high heating value gas and low unreacted carbon. These results are achieved at the cost of a high external heat input and a large production of low level heat from condensing excess steam.

The air-blown gasifier concept uses a substoichiometric amount of air to fluidize the bed and carry out the reactions. The product gas has a relatively low heating value but very high conversion of char carbon to gas. The main advantage of this concept is the near zero

requirement for in-bed heat transfer surface. The endothermic gasification reaction enthalpy requirements can be balanced by combustion of a portion of the product gas by the air to minimize the external heat input requirement.

Based on the above conceptual evaluation, one process was then selected for a more detailed study. An ASPEN process simulation model of the process was developed to explore in greater detail the sensitivity of the process to assumptions and operating parameters. The ASPEN model also provides more information on the effects of the auxiliary equipment such as waste heat boilers and condensers. The model data has been used to help guide the preliminary equipment selection. A patent application has been filed on this concept.

A number of technical issues and concerns were identified that require further study including reaction rates, particle size control in the gasifier, sensitivity to gas flow rate, performance of the liquor spray feed system to concentrate liquor in droplets entering the gasifier, final gasification products generated, sulfate reduction rates, carbon conversion rates, and gas clean-up performance. These issues can only be resolved through the operation of bench and pilot scale test facilities.

Bench scale tests would provide engineering and reaction rate data and confirm that the major potential technical barriers to the success of this process can be resolved. The tests are included in the recommended interim project phase, denoted Phase IA described in the project technical results.

APPENDIX I
FUTURE PLANS

TABLE OF CONTENTS

<u>Section</u>	<u>Page</u>
APPENDIX I. FUTURE PLANS.....	I-1
PHASE II: RECOVERY FURNACE SIMULATOR DEVELOPMENT.....	I-2
Task 1: Detailed Design.....	I-2
Task 2: Numerical Model Studies.....	I-2
Task 3: Liquor Property Characterization.....	I-2
Task 4: Purchase Evaporator/Concentrator.....	I-2
Task 5: Atomization Studies.....	I-2
Task 6: Smelt Casting System.....	I-3
Task 7: Construct and Shakedown Recovery Furnace Simulator Facility.....	I-3
Task 8: Project Management and Phase II Final Report.....	I-4
PHASE III. ADVANCED COMBUSTOR DEVELOPMENT.....	I-5
Task 1: Detailed Characterization of Recovery Furnace Simulator.....	I-5
Task 2: Conceptual Design of Advanced Combustor.....	I-5
Task 3: Functional Design of Advanced Combustor.....	I-6
Task 4: Examine Combustor System Retrofit Feasibility.....	I-6
Task 5: Prepare Advanced Combustor System Test Plan.....	I-7
Task 6: Numerical Model Studies of Advanced Combustor.....	I-7
Task 7: Detailed Design of Advanced Combustor.....	I-8
Task 8: Fabricate and Install High-Capacity Modifications.....	I-8
Task 9: Conduct Test Program and Advanced Combustor (WBS 3.11).....	I-8
Task 10: Project Management and Phase III Final Report.....	I-9
PHASE IV: ADVANCED COMBUSTOR VERIFICATION.....	I-10
Task 1: Confirm Host Site Selection.....	I-10
Task 2: Design Facility Installation.....	I-10
Task 3: Construct and Install Advanced Combustion.....	I-10
Task 4: Conduct Advanced Combustor Test.....	I-10
Task 5: Project Management and Phase IV Final Report.....	I-10

(THIS PAGE LEFT INTENTIONALLY BLANK)

Appendix I. Future Plans

As described in the Section II.3, Technical Approach to Future Work, the recommended future path for this project is to conduct an interim work phase (denoted as Phase IA in this report) to evaluate gasification as an optional path to be considered in lieu of high solids advanced combustion. At the conclusion of Phase IA it is recommended to review the two options, high solids advanced combustion and gasification, and select a path forward. That path would then consider three options:

- 1) Proceed with high solids advanced combustion development using a dedicated pilot facility.
- 2) Proceed with black liquor gasification development using a dedicated pilot facility.
- 3) Do not aggressively pursue either technology as described in this report.

The major tasks recommended for Phase IA are described in Section II.3. The project phases that would follow and a brief description of the goals of each is also provided in that section for the second option (i.e., pursue black liquor gasification). The full scope of this project, assuming that high solids firing would be pursued through demonstration in a commercial unit (i.e., the first option) was described in the proposal for this project. This appendix provides an updated description of the workscope for Phases II through IV as the project would now be projected to proceed for that first case, that is pursuing high solids advanced combustion technology for recovery boilers.

PHASE II: RECOVERY FURNACE SIMULATOR DEVELOPMENT

Task 1: Detailed Design

Based on the preliminary design of the recovery furnace simulator (RFS) facility from Phase I, and approval by DOE, the detailed design of the RFS facility will be prepared. Drawings for the fabrication and assembly of the structural and process equipment will be prepared, reviewed, and released for fabrication.

The support structure will be designed so that the evaporator/concentrator can be installed as a skid mounted unit. The furnace bottom will be designed for easy removal and replacement by the advanced combustor bottom when required.

Task 2: Numerical Model Studies

Numerical modeling was used extensively for the preliminary design of the baseline facility as described in Appendix C. The model is continually being expanded to incorporate fundamental information as it becomes available. In particular, fume modeling and wall drying phenomena are currently being improved. The RFS configuration will be rerun with the new model to evaluate the effects of nozzle selection on inflight drying and to consider a wall drying arrangement.

Task 3: Liquor Property Characterization

Liquor characterization tests will be run to determine the physical and combustion properties of the black liquor from the supplier mill that will be burned in the RFS. Initially screening tests will be run to ensure that high solids liquor from the candidate mill does not have a viscosity that is abnormally high. After a supplier mill has been selected, detailed physical characterization tests will be carried out by University of Florida (UF), under subcontract, over a range of solids. Additional viscosity and combustion properties tests will be performed by B&W (refer to Appendix E for test details).

Task 4: Purchase Evaporator/Concentrator

Based on the preliminary design and the initial work completed under Task 1, contracts to purchase long-lead items will be issued. In particular specifications for the evaporator/concentrator will be finalized and sent to the suppliers identified in Phase I plus any new candidates. The bids will be evaluated and a supplier selected. The supplier selected will then be released to complete design and fabrication of the concentrator.

Task 5: Atomization Studies

The characteristics of black liquor as it is atomized liquor or sprayed into a recovery furnace will be investigated to cover the anticipated range of liquor viscosity from 68% to

85% solids liquor. This evaluation will be performed in the ARC Atomization Facility. A description of the planned tests and the B&W Atomization Facility is provided in Appendix E. The drop size distribution and spray pattern for commercially available nozzles, which were identified during Phase I, will be quantified with black liquor or a model fluid with similar viscosity. The nozzle type and size will then be selected for both the nominal 68-70% solids liquor and the nominal 85% solids liquor test conditions. (Note that flashing liquor conditions can not be evaluated directly, but will be considered using best estimates developed using engineering data.

Task 6: Smelt Casting System

A pan conveyor system similar to that used in a commercial mill at Millar Western, Meadow Lake, Sask., Canada, will be used to cast the molten smelt into ingots. Since it is anticipated that this will be a long lead item, final specifications will be written early in Phase II. The supplier will then be released to complete design and fabrication of the unit.

Task 7: Construct and Shakedown Recovery Furnace Simulator Facility

Upon Phase II approval, B&W will begin detailed design work. The construction of the Recovery Furnace Simulator facility at its Alliance Research Center (ARC) will follow.

Subtask 7.1: Fabricate and Erect Facility

B&W resources will be used to fabricate and erect the facility. A critical path network schedule will be used to manage the facility construction. Engineering, procurement, fabrication, and installation will be managed with the goal of cost-effective and timely completion of the facility.

Subtask 7.2: Fabricate and Ship Concentrator

The evaporator/concentrator will be constructed at the supplier's facilities as a skid-mounted unit. Since this is based upon a standard product design for the supplier, albeit much smaller than commercial units and requiring higher solids concentration, the supplier's standard procedures for construction management will be followed. All components except the instrumentation and possibly the main heat exchanger will be assembled and shipped as a single unit.

Subtask 7.3: Install Concentrator in Facility

The evaporator/concentrator will be installed in the RFS facility adjacent to the furnace. The heat exchanger may be mounted separately if necessary and connected to the rest of the unit. The instrumentation panel will be incorporated into facility control room and systems or mounted adjacent to the equipment as appropriate.

Subtask 7.4: Shared Equipment Connection

Several pieces of equipment such as the forced draft and induced draft fans, baghouse, stack, utility connections (steam, water, compressed air, and natural gas) will be shared between the RFS and an adjacent test unit, the 2.5-MW CFB. Once the connections to this equipment are made, air and water will be put through the system to test functionality. Water will be circulated and boiled in the evaporator. The natural gas start-up burners will be used to dry the refractory walls of the furnace.

Subtask 7.5: Shakedown Tests

The shakedown portion of the test plan prepared in Phase I, Task 4, will be carried out on the RFS.

The initial tests are short-term shakedown tests to establish that the system operates as designed. Evaporator performance will also be evaluated. The initial liquor burning tests will evaluate the liquor spray nozzle and the smelt handling system.

Task 8: Project Management and Phase II Final Report

This task will provide for the supervision, planning, coordination and integration of research, engineering, construction and other technical activities.

Monthly cost, management and technical progress reports will be submitted as specified in the contract reporting requirements checklist.

Meetings for consultation and review will be conducted to assure sponsor and peer review.

A technical paper describing the facility and preliminary results of startup testing, including comparisons with numerical modeling results, will be submitted to an appropriate conference.

B&W will prepare a Final Report to document design, the results of the Phase II startup tests, recommendations for any changes in Phase III plans, and an updated estimate for the balance of the project.

PHASE III: ADVANCED COMBUSTOR DEVELOPMENT

Task 1: Detailed Characterization of Recovery Furnace Simulator

The performance of the furnace will be evaluated by operating with black liquor at a nominal solids concentration of 68-78% over a range of concentration with a furnace heat input up to 6.0 million Btu/hr. These tests, as described in the Phase I, Task 4, test plan (refer to Appendix E), must be long duration tests so that steady-state conditions can be established at the furnace exit. It is anticipated that up to 15 furnace performance tests will be required. The data from some of these tests will be used with PR-FURMO to evaluate similarity of pilot and commercial scale results.

After the baseline characterization, the performance of the concentrator and furnace when burning high-solids liquor at the design heat input rate will be evaluated per the Phase I, Task 4, test plan (refer to Appendix E). It is anticipated that up to ten tests with high-solids liquor will be run. These will be long-duration tests to establish steady-state conditions.

A series of tests to determine the maximum heat input to the furnace will then be run per the Phase I, Task 4, test plan. It is anticipated that up to five tests with high-solids liquor will be run. The results will be compared with the baseline results to assess the level of improvement made and the limitations identified for firing high solids black liquor at higher heat input rates.

Task 2: Conceptual Design of Advanced Combustor

B&W will prepare a conceptual design, including performance specifications, for the Advanced Combustion System that is part of the next generation recovery plant.

Subtask 2.1: Literature Review

A literature survey focusing on high-solids firing and increased throughput will be performed. Relevant industry, technical association and research reports and literature will be obtained. This will provide the contractor with the latest theory and operating experience.

Subtask 2.2: Conceptual Design of Advanced Combustor System

The conceptual design of the advanced combustor system will be completed at the arrangement drawing level as a site specific design for the tentative host site. Numerical modeling of the host site boiler will be initiated to screen the advanced combustion design concepts. Up to six configurations and operating conditions may be considered (refer to Task 6).

A preliminary P&ID for the mill installation will be developed to show integration of the high-solids concentrator and furnace bottom in to the mill. Also included will be the location of the liquor spray nozzles, overfire primary air ports, and secondary ports. Heat absorption and circulation in the lower furnace will be reviewed.

Subtask 2.3: Host Site Consultation

The high-solids firing system, including furnace and black liquor delivery modifications will be reviewed with potential users, suppliers, and technical experts in the pulp and paper industry. Suggestions and modifications will be considered for the final design.

Task 3: Functional Design of Advanced Combustor

Preliminary designs of the modifications required to demonstrate the advanced combustor concept in the RFS will be completed at the arrangement drawing level.

Subtask 3.1: Process Design Including P&ID

Complete material and energy balances for the modified system at high heat input rates will be completed. A new P&ID for the system will be prepared to indicate any problems with auxiliary equipment at high flows.

Subtask 3.2: Arrangement Drawings of Modifications

Drawings will be made showing where the bottom of the baseline furnace can be removed. Arrangement drawings will be prepared of the new furnace and air system.

Subtask 3.3: Develop Cost Estimate for Modifications

A cost estimate will be prepared for removal of the old bottom and the fabrication and installation of the modified high capacity bottom.

Task 4: Examine Combustor System Retrofit Feasibility

B&W will examine the conceptual designs and performance specifications done under Task 2 for retrofit applicability to the host site, considering the potential of the design to achieve the Phase III and IV requirements of this project.

Subtask 4.1: Define Site-Specific Characteristics

The host site mill pulping and recovery process will be reviewed to identify any atypical operations which can affect liquor properties.

The host site boiler design will be reviewed to determine site-specific characteristics, including the ability to accept increased solids and heat input.

Subtask 4.2: Integrate High-Solids Concentrator into Steam Cycle

The host site's existing evaporator flowsheet and PI&D will be reviewed to determine how to integrate high-solids concentrator to make optimal use of the vent steam.

Subtask 4.3: Installation Review

The host site plot plan and building arrangement drawings will be reviewed to determine the preferred location of the concentrator and best access routes to the new boiler bottom.

Task 5: Prepare Advanced Combustor System Test Plan

A test plan for the high-solids, high-capacity Advanced Combustor furnace will be prepared based on the results of the baseline test and the advanced combustor conceptual design. The test plan to demonstrate the capability of the modified RFS to burn nominal 85% liquor at heat input rates above those obtained in the baseline tests will be prepared. The test plan will identify the number of tests, the objective of each test, measurements and samples to be taken and analytical methods to be used. The test plan will be approved by DOE before proceeding with the tests in Phase III. It is anticipated that up to ten tests will be required.

B&W will prepare a preliminary test plan for the advanced combustion system in the host site and show how achievement of the performance specifications will be verified. Since the host site advanced combustion system is a production unit only three tests will be planned.

Task 6: Numerical Model Studies of Advanced Combustor

Numerical models will be compared with RFS tests results and parameters adjusted if necessary to improve the ability to match the performance observed. This work will be based on RFS model developed previously in Phase I with updates to reflect the RFS arrangement as tested in Task 1 of this phase and will utilize numerical model improvements available at the time of this task. This work will proceed in concert with the Task 1 activities. The RFS numerical model will also support evaluation of the changes in the RFS design to accommodate the advanced combustion design modifications developed in Task 7. The RFS model results will also be compared with the results the advanced combustion design conducted under Task 9.

A numerical model of the commercial unit that is targeted for the high solids advanced combustor upgrade will be prepared to support evaluation of the conceptual designs that are considered in Task 2. This subtask will scheduled to proceed in concert with Task 2. The

commercial unit model will be updated if needed to include knowledge gained from the RFS testing in Task 9. The result will provide a more reliable model that can be used to scale the results obtained from the RFS testing to support the detailed design work for the first commercial unit modifications that are planned for Phase IV.

Task 7: Detailed Design of Advanced Combustor

The detailed mechanical design of the modifications to the base RFS will be completed. The modified furnace bottom will be designed to attach to the existing furnace below the tertiary air ports.

Task 8: Fabricate and Install High-Capacity Modifications

Upon Phase III approval, B&W will begin construction of the modifications of the RFS at ARC required to convert it to the high solids Advanced Combustion design.

Subtask 8.1: Fabricate and Install Advanced Combustor Modifications

The resources of the ARC will be used to fabricate and erect the modified bottom to the RFS and make any needed support equipment modifications. A critical path project management system will be used to manage the facility construction. Engineering, procurement, fabrication, and installation will be managed in a cost-effective and timely manner. Input and approvals will be obtained from the project technical leaders and staff.

Subtask 8.2: Remove and Store Low Capacity Furnace Bottom

The existing furnace bottom will be supported; disconnected from all lines, air ducts, and instrument connections; and removed. The removed component(s) will be prepared appropriately and placed in storage for possible later use.

Task 9: Conduct Test Program on Advanced Combustor (WBS 3.11)

The test plan prepared in Phase II, and approved by DOE will be carried out on the modified RFS. The plan will identify several test series as shown below.

Subtask 9.1: Shakedown Tests on New Equipment

The initial tests are short-term shakedown tests to establish that the new components of the system operate as designed.

Subtask 9.2: High-Capacity Tests with High-Solids Liquor

The modified RFS will be operated to demonstrate its ability to burn high-solids liquor at high input rates. The limiting and desired operating rates will be evaluated by checking performance at three loads. Up to ten tests are planned for this subtask.

Subtask 9.3: Model Verification

Numerical flow and combustion models will be verified by comparing results from Subtask 9.2 with pilot data for the high-solids RFS configuration. Refinements in the modeling parameters and methodology will be made to enhance agreement between data and predictions. Detailed predictions of three-dimensional flow, temperature, and species distributions will be used with pilot data to derive correlations for operation and performance of the advanced pilot-scale combustor.

Task 10: Project Management and Phase III Final Report

This task will provide for the supervision, planning, coordination and integration of research, engineering, construction and other technical activities.

Monthly cost, management and technical progress reports will be submitted as specified in the Reporting Requirements Checklist.

Meetings for consultation and review will need to be incorporated into Phase III to assure sponsor and peer review.

A technical paper describing the RFS test results and comparison with numerical modeling results will be submitted to an appropriate technical conference.

B&W will prepare a Final Report to document the results of the Phase III study. This report will include justification proceeding to Phase IV.

PHASE IV: ADVANCED COMBUSTOR VERIFICATION

Task 1: Confirm Host Site Selection

B&W will obtain the host site agreement, or make other arrangements for use of another host site, before proceeding any further work under Phase IV.

Task 2: Design Facility Installation

B&W will design the installation, including modifications necessary for incorporation of the advanced combustion system into the host facility for operational testing of the instrumented prototype combustion subsystem. This will include numerical modeling of the prototype using the models of the commercial unit developed in Phase III.

Task 3: Construct and Install Advanced Combustion

B&W will construct modifications and install the high solids advanced combustion system in the host site. The entire task will be conducted in close consultation with the host paper company and all changes will be orchestrated to minimize boiler downtime. Loss of production would be held to a minimum under the plan.

Task 4: Conduct Advanced Combustor Test

B&W will implement the approved test plan prepared under Phase III, Task 4.

Field service engineering, supervision, analyzers and other necessary equipment and manpower will be supplied by B&W. Performance testing will be conducted according to B&W standard procedures. Some specialized techniques utilized in Phase II may be applied for data acquisition.

Task 5: Project Management and Phase IV Final Report

This task is to provide for the supervision, planning, coordination, reporting, meetings and integration of research, engineering and other technical activities.

Monthly cost, management and technical progress reports will be submitted as specified in the reporting requirements checklist.

B&W will document the test program findings and disseminate the results to industry for encouragement of potential domestic users and suppliers. B&W will also conduct a seminar for an approximate 50-person group from industry and present an overview in a technical paper to an appropriate professional society.

The performance of the high-solids concentrator and combustion system should be well documented and disseminated to encourage widespread adoption of the technology. The results of the test program will be evaluated and compared with the predicted performance of a boiler of standard design firing normal 65% solids liquor. Dissemination can occur through publications and presentation in well established industry forums and through special industry seminars.

The work completed under Task IV will be documented in a Final Report.

(THIS PAGE LEFT INTENTIONALLY BLANK)

APPENDIX J

TECHNICAL PAPER

RECOVERY FURNACE SIMULATOR - DESIGN & MODELING

By

C. L. Verrill, W. T. Southards, R. A. McIlroy, R. A. Wessel, J. L. Clement

**Presented at the 1995 International Chemical Recovery Conference
Toronto, Ontario, Canada**

(THIS PAGE LEFT INTENTIONALLY BLANK)

RECOVERY FURNACE SIMULATOR — DESIGN AND MODELING

C. L. Verrill
Research Engineer

R. A. McIlroy
Sr. Principal Engineer

W. T. Southards
Sr. Research Engineer

R. A. Wessel
Principal Engineer

Babcock & Wilcox, Research and Development Division
Alliance, Ohio, U.S.A.

J. L. Clement
Sr. Technical Advisor
Babcock & Wilcox, Fossil Power Division
Barberton, Ohio, U.S.A.

ABSTRACT

The Recovery Furnace Simulator (RFS) is a proposed pilot-scale test facility that has been designed to burn kraft black liquor at a nominal rate of 11 metric tons of dry solids per day. Numerical modeling results demonstrate that the RFS would be well suited for experimental simulation of black liquor combustion because black liquor distribution, gas temperature, and gas residence time for the RFS and a commercial recovery boiler are similar. The proposed RFS would provide a unique, cost-effective means to evaluate significant changes to recovery boiler design and operating strategy, as well as a scientifically controlled environment to make measurements for validating computational models.

INTRODUCTION

A program incorporating construction and testing of an RFS as the principal means to develop advanced combustion technology for high-solids black liquor was proposed to the U.S. Department of Energy (DOE) in 1989, a revised proposal was provided in 1992, and the cooperative agreement that supported this work was executed in 1994. Prior work on a "red water" furnace test unit, designed to develop TNT by-product recovery processing, indicated that a furnace of this scale would be feasible for black liquor recovery processing research and development. This paper addresses development of the RFS preliminary design, which is a major objective of the first phase of the program. Numerical modeling evaluation of the design concepts substantially supported this effort.

Within the kraft process chemical recovery community, an increasing reliance is being placed on numerical modeling as a design tool and as a means to evaluate the impact of process changes on boiler operation. Currently the models can generate a detailed three-dimensional description of flow fields, species and temperature distributions, and black liquor particle trajectories [1]. However, the models rely on simplified engineering relationships to describe black liquor combustion [2,3]. These relationships have been derived from limited laboratory data. The RFS could provide a scientifically controlled environment to make measurements for validating the computational models at pilot scale (11 metric tons dry solids per day).

There is a need for a test facility to evaluate potential emissions control strategies and new lower furnace designs to

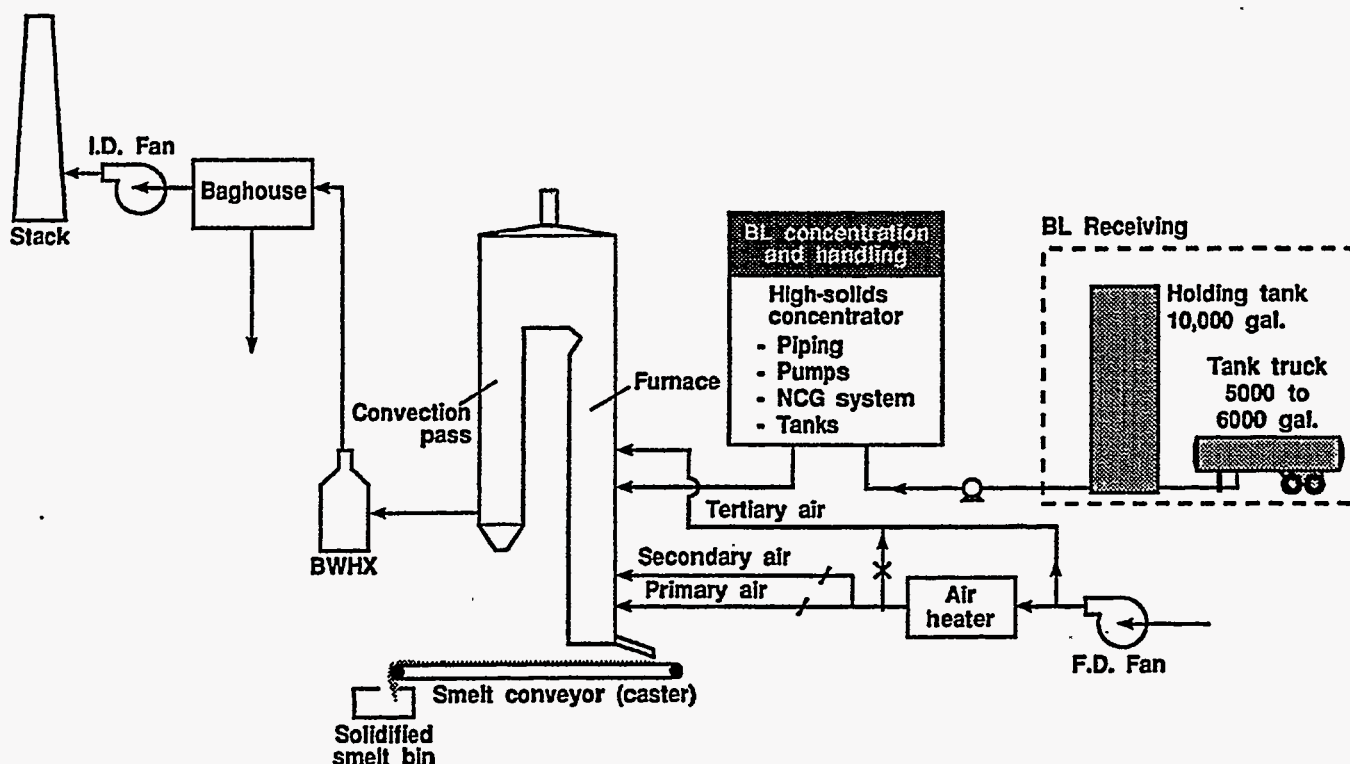

Figure 1. Pilot-scale kraft process Recovery Furnace Simulator concept.

offset the negative effects of high solids operation. One of the major recovery boiler problems facing the pulp and paper industry today is ash deposit buildup [4]. The trend of increasing black liquor solids concentration has contributed to this problem by increasing furnace combustion temperatures. Ash deposit growth and emissions chemistry would best be studied in the commercial boiler environment. However, field studies are constrained by costs, mill production requirements, and emissions regulations. To satisfy these needs, the RFS would be constructed to facilitate measurement of emissions and collection of ash samples.

FACILITY DESCRIPTION

The primary components of the proposed pilot facility are shown in Fig. 1. This section describes the unique features of each subsystem. A nominal heat input rate of 6.33×10^6 kJ/h (6.0 MBtu/h) was chosen as a practical value for handling black liquor at the pilot scale. The design assumes that liquor is supplied from a pulp mill at a nominal solids content of 50%. Liquor shipped by tank truck is transferred to a heated storage tank (Fig. 1). The combustion air is supplied by a single fan and air heater system. Suitable dampers and meters distribute the air to three levels of ports. Tertiary air is supplied at the forced draft (F.D.) fan discharge temperature but can also be preheated. The air heater is capable of heating the primary and secondary air streams to 260°C (500°F).

Liquor Handling System

The as-received liquor is concentrated to the desired firing solids value, 65 to 85%, in a single-stage, high solids concentrator. The concentrator is capable of evaporating up to 375 kg/h (825 lb/h) to supply 85% solids liquor at the design firing rate of 6.33×10^6 kJ/h. Concentrated liquor flows to a flash tank that controls the final liquor temperature. The tank has a high flow rate recirculation loop that contains instruments to continuously measure product liquor properties such as solids concentration, viscosity, and density. A small diameter feed line to the spray nozzle branches off this recirculation line.

Recovery Furnace

The RFS furnace has been designed as a refractory-lined, water-cooled chamber with a 2.32 m² (25 ft²) plan area to simulate the gas temperature profile of a commercial unit. Much like a small commercial recovery boiler, the furnace has a three-level air system and a single liquor port (Fig. 2). The primary air ports are located on all four walls at 15 cm (6 in) above the smelt spout. The secondary air ports are located on all four walls at 45 cm (18 in) above the smelt spout. Unlike the primary ports, only the secondary ports on two opposing walls would be operated during a given test. The tertiary port elevation is 3.35 m (11 ft) above the smelt spout to reproduce the gas residence time between the secondary and tertiary port levels found in a commercial unit. The nose is 5.5 m (18 ft) above the tertiary ports to maintain tertiary zone residence time.

The RFS furnace has a flat floor with a slightly elevated smelt spout to simplify construction and maintain uniform primary air elevation. The smelt spout opening is about 10 cm (4 in) above the refractory floor to provide a protective layer of frozen smelt. The height of the spray nozzle above the floor should be set so that the majority of the liquor drops dry in flight. This results in a liquor gun height of 1-3 m (3-10 ft) above the base, depending on the nozzle selection and the liquor solids concentration. To accommodate this wide variation, the liquor port is a slot, approximately 2 m (7 ft) tall, with sectional, refractory-lined plug covers that can be moved to adjust firing elevation.

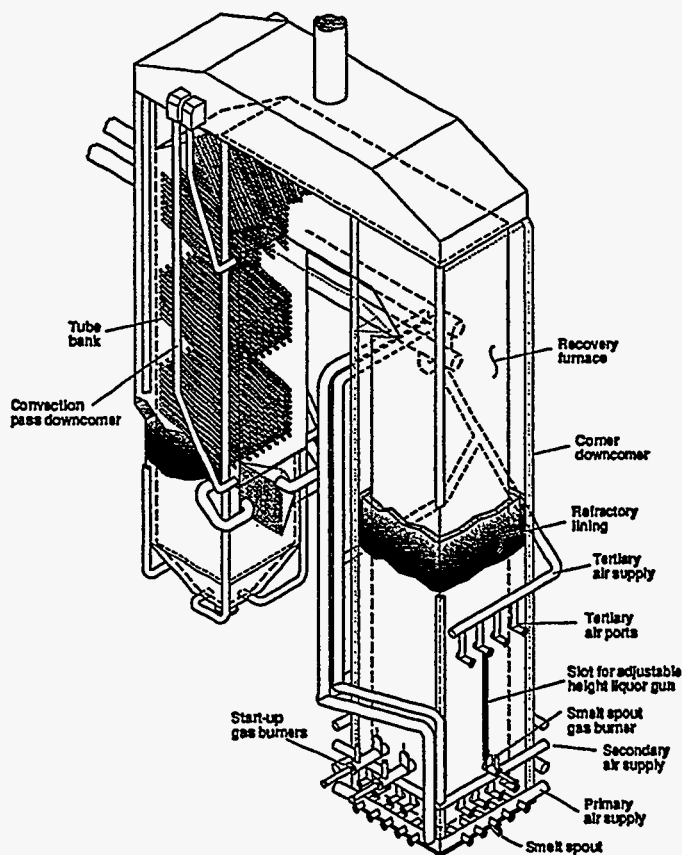

Figure 2. General arrangement of RFS furnace and convection pass.

The refractory lining in the lower furnace reduces heat loss to ensure that the char bed remains hot enough to drive endothermic reactions and cause smelt to tap easily. The refractory lining in the upper furnace controls heat loss so that the furnace exit gas temperature at the tip of the nose is similar to commercial designs at this location. A dense castable refractory, suitable for molten smelt contact, was selected in the initial design study. A practical thickness of 7-10 cm (3-4 in) would be used to line the furnace cavity.

Convection Pass

Flue gas leaving the furnace enters a convection pass that is

designed to be suitable for studying emission chemistry during gas cooling. The RFS convection pass consists of a number of carbon steel, water-cooled tube banks across the gas flow path. The tube spacing in each bank is uniform, but the bank depth and distance between banks can be adjusted in the final design to achieve the desired overall cooling rate. Tube spacing (side and back) was set according to commercial design practice to optimize heat transfer and minimize fouling. To allow extended operation of the test facility, the convection pass will be equipped with manually operated air lances to remove ash deposits from the tube banks.

The inlet to a commercial boiler convection pass is typically at the vertical plane extending upward from the tip of the furnace nose. In the RFS, the flue gas exits the furnace, passes through a horizontal duct, and turns into a vertical duct that contains the tube banks (Fig. 2). This design was chosen primarily for safety reasons to avoid placing the water-cooled tubes in a location where a leak could introduce water into the furnace.

The convection pass tubes are cooled with near ambient pressure boiling water, and therefore do not simulate tube metal temperatures typical of recovery boiler superheaters or boiler banks. However, air-cooled ash deposition probes can be inserted in the convection pass to study deposit formation at simulated recovery boiler flue gas conditions. Cooling air flow to the probes can be adjusted to match tube metal temperatures found in commercial units. Air-cooled probes have been used successfully in pilot-scale studies of coal-fired furnaces [5] and in field studies of kraft recovery boilers [6]. Sample ports are provided in the convection pass and furnace cavity for gas and particulate sampling and aspirated, high-velocity thermocouple traverses to investigate the effects of operating conditions on particulate and gas emissions in the furnace. Continuous on-line instruments would be included for O₂, SO₂, NO_x, and CO concentration measurement.

Smelt Handling System

Unlike a conventional pulp mill operation where smelt is dissolved to form green liquor for reuse in the pulping process, there would be no on-site use for green liquor at the RFS facility. Green liquor cannot be easily disposed of because of the high pH and reduced sulfur content. Shipping green liquor back to the pulp mill is impractical because a larger volume of green liquor would be produced from a given volume of black liquor (maximum soluble inorganic salt concentration of green liquor is less than 50% by weight). An alternate approach to safely handle smelt as a solid that can be returned to the mill is required.

A pan conveyor is used to cast smelt into ingots (Fig. 1); this technology has been demonstrated commercially at Millar Western's Meadow Lake pulp mill [7]. A series of shallow pans, attached to a chain conveyor, move under the smelt spout to receive the molten smelt. As the pans move away from the smelt spout, water is sprayed on the pan bottoms to

accelerate solidification. The length of the conveyor and the chain speed are set to ensure that the ingots will be solidified at the discharge point. The ingots would be collected in closed containers for return to the pulp mill that supplied the black liquor. At the mill site, the ingots would be dissolved in weak wash and added to the green liquor system.

Particulate Emission Control

A baghouse is used to remove particulate matter (fume and carryover) from the flue gas leaving the RFS convection pass. An existing boiling water heat exchanger (BWHX in Fig. 1) first cools the flue gas to below the temperature limitation of the baghouse filter media. Although baghouses are not normally used in commercial kraft recovery applications, they are very effective for collecting fine aerosols. The suitability of a baghouse for this type of service has been demonstrated by the high collection efficiencies, >99%, obtained by the University of Tennessee Space Institute on a similar fume, K₂SO₄, from the coal-fired magnetohydrodynamic process [8]. Particulate catch from the baghouse, anticipated to be 36-45 kg/h (80-100 lb/h), would be collected in dry bulk containers for return to the pulp mill supplying the liquor.

DESIGN APPROACH

The methodology used to arrive at a preliminary RFS design is described in this section. A large, single-drum recovery boiler was used as the basis of this design. The "Modeling Results" section demonstrates how numerical modeling was used to verify that the RFS would reproduce the following characteristics of the commercial reference unit:

- Gas residence time and temperature profile
- Air jet penetration and mixing patterns
- Black liquor distribution (fraction of fired black liquor burned in flight, amounts deposited on the walls and char bed, and the amount entrained in gas flow and carried into the convection pass)

Pilot Furnace Scaling

The elevations of primary and secondary air ports in commercial boilers are set according to established guidelines. For char bed control in the RFS, the elevations of the primary and secondary ports were geometrically scaled from the reference unit by the square root of plan area. It is expected that this design can maintain a stable char bed up to the height of the secondary air ports. Accumulation of char on the furnace floor to this elevation should simulate commercial operation by providing residence time for the relatively slow char carbon gasification and sodium sulfate reduction reactions to occur.

The elevations of the tertiary air ports and furnace nose in the RFS were set to reproduce the time-temperature profile of a commercial boiler. Much of the heat release, aerosol formation, and emissions reactions occur in this region of a recovery boiler. It is therefore important to accurately

reproduce the gas residence time and temperatures found in commercial units. Percent excess air and air distribution to each level of ports in the RFS were set equal to typical values of the reference commercial unit. A typical industrial liquor composition, solids content, and heating value were assumed to calculate the mass flows of gas above and below the tertiary air level. The mean gas temperatures in these regions were assumed to be equal for pilot and commercial scale. In practice, refractory thickness can be varied in the RFS to control heat absorption to the water walls to match average gas temperature at critical locations. The calculated distances between ports were summed to estimate total furnace height (Fig. 3). A structural limit of approximately 9 m (30 ft) to the furnace nose set the plan area at 2.32 m² (25 ft²).

Volumetric heat release is an indication of gas time-temperature profile; it is compared for the RFS and a number of commercial boilers in Fig. 4. As expected from its commercial design basis, the RFS at nominal load resembles large commercial units in terms of volumetric heat release. At maximum firing rate (1.27×10⁷ kJ/h), the furnace volume available for heat release is approximately that of a small two-drum unit. The results in Fig. 4 suggest that, by varying firing rate, the RFS can reproduce the time-temperature profiles for a wide range of boiler sizes.

At high firing rate, RFS heat input per plan area approaches that of small commercial units (Fig. 5). This suggests that combustion will be self-sustaining at high firing rates. According to modeling results, a suitable refractory lining can compensate for lower heat release per plan area at nominal load to maintain realistic combustion temperatures in the RFS. In practice, some auxiliary fuel firing may be required to support combustion at nominal load. It is not an objective of RFS operation to maximize liquor processing capability; it was therefore deemed unnecessary to achieve a commercial level of plan area heat input. Moreover, matching the heat input per plan area of a large recovery boiler would result in impractical constraints on the design, such as locating the liquor gun above the tertiary air level.

Primary air port size was estimated from standard design practice for small furnaces. For uniform air distribution, 20 ports were evenly spaced around the furnace perimeter. Secondary and tertiary air ports were sized to reproduce air jet penetration typical of the reference boiler. The methodology of Ivanov [9] was followed, whereby the depth of air jet penetration is related to the jet's vertical deflection in the upward-flowing furnace gases. The number and positioning of the secondary and tertiary air ports were specified according to commercial design practice to achieve bed control and minimize opposing air jet interference.

Preliminary Nozzle Selection

A critical element in RFS design was the selection of a liquor nozzle to give reasonable gun height and spray pattern to achieve in-flight drying without excessive carryover.

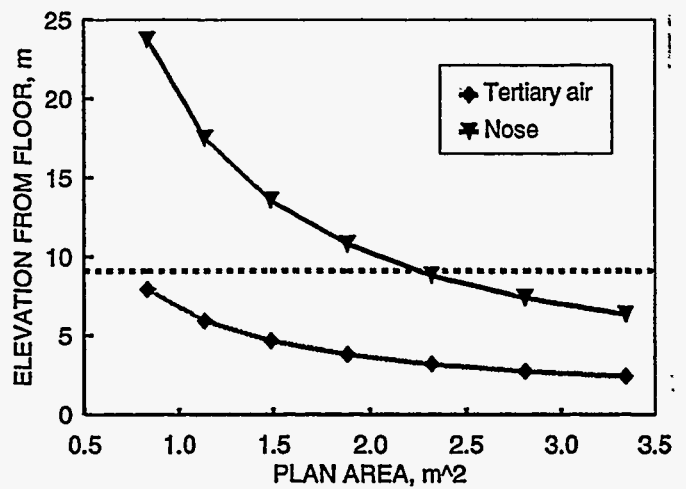

Figure 3. Tertiary air and furnace nose elevation as a function of RFS plan area.

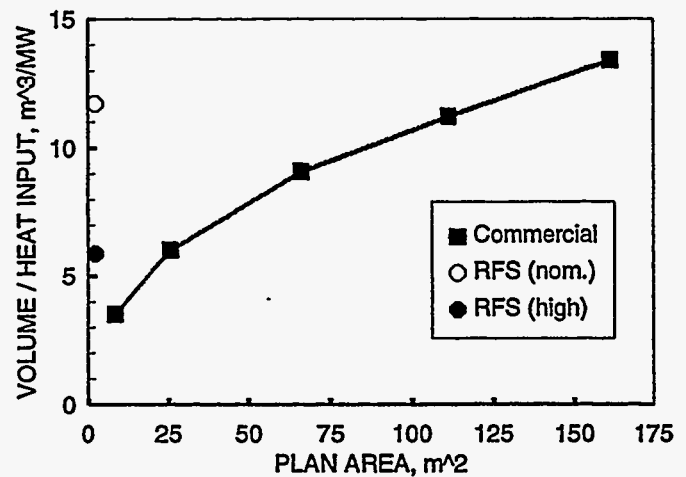

Figure 4. Furnace volume per net heat input for RFS and a range of commercial units.

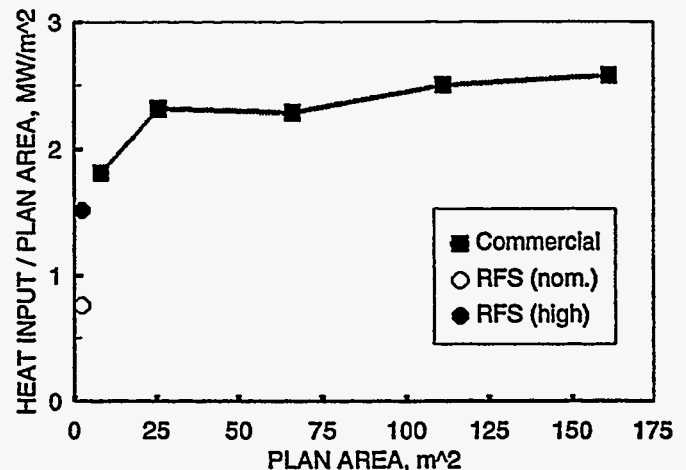

Figure 5. Heat input per plan area for RFS and a range of commercial units.

Reproducing the commercial time-temperature profile in a small furnace cross section requires a lower average gas velocity to maintain a practical furnace height. Black liquor drop size has to be reduced accordingly to simulate commercial liquor distribution. The standard splash plate nozzle used in recovery boilers will not work in the small cross section of the RFS; the wide spreading angle of the liquor spray would result in wet liquor impinging on the furnace walls.

Black liquor drop size distributions from a number of pressuring-atomizing nozzles have been shown to fit a square root normal distribution [10,11]. This distribution function was used to estimate the median drop size associated with a calculated minimum drop size for entrainment (specified to achieve a small amount of carryover in the RFS). The drying time for the median-sized drop was estimated by a simple heat transfer model [12]. Based on the drying time and aerodynamic trajectory of a median-sized drop, the elevation of the liquor gun was adjusted to reproduce the same amount of suspension drying as the reference commercial unit. The liquor gun firing angle was calculated to direct the center of the spray at the midpoint of the char bed (assumed to be at the secondary air port elevation).

The minimum flow opening for several commercially available nozzles were used in the liquor gun height calculation to check that excessive gun height would not be required to achieve drying, and that good coverage of the lower furnace would be possible from the predicted elevation. Numerical modeling was then used to simulate the distribution of the black liquor spray and the amount of carryover. This procedure identified the BETE® MP nozzle as the best choice for RFS operation. This nozzle produces a heavy-edged, full cone spray pattern with a fairly uniform mass distribution in the center of the cone. The nozzle can produce the desired drop size with a larger minimum flow opening than other designs; the larger opening reduces initial spray velocity which allows the gun to be located lower in the furnace. Moreover, the larger openings reduce the likelihood of nozzle pluggage by suspended solids.

Due to the uncertainty of how well the selected nozzle can atomize highly viscous black liquor, the spray pattern and drop size distribution is proposed to be measured in an atomization test facility prior to use in the RFS. The liquor mass distribution as a function of spray location for the BETE® MP nozzle would also be measured to validate the numerical modeling assumptions.

MODELING RESULTS

A three-dimensional numerical model, PR-FURMO, was used to simulate combustion in the RFS and a commercial-scale recovery boiler. The model is based on a fundamental mathematical description of various interacting processes which occur during combustion: turbulent flow, drop dispersion, gas and solid phase chemical reaction, and heat transfer. Details of the model are described elsewhere [1].

The model was used to screen preliminary designs of the air and liquor delivery systems for a pilot furnace of fixed size and shape.

- Flow predictions were used to verify design calculations and evaluate air system performance based on air jet penetration, mixing effectiveness, and upward flow uniformity. Optimal flow conditions are not difficult to achieve with the slender shape of the RFS furnace.
- The performance of the black liquor nozzle was evaluated to determine the distribution of black liquor spray and the amount of carryover (gas-entrained particulate leaving the furnace). Modeling results show that the black liquor spray distribution is sensitive to nozzle design and operating parameters.
- Heat transfer predictions were used to determine the refractory type and thickness necessary to achieve the desired gas temperature distribution in the RFS furnace.

Based on the modeling results, the optimal design of the RFS furnace is achieved with the three-level air system and a full-cone spray nozzle described in the previous section.

TABLE I. RFS OPERATING CONDITIONS

<i>Flow Rates</i>	
Air	0.553 kg/s (1.219 lb/s)
Liquor	0.191 kg/s (0.421 lb/s)
Solids	70.0 %
<i>Air Distribution & Temperature</i>	
Primary	40.0 % 154°C (310°F)
Secondary	30.0 % 154°C (310°F)
Tertiary	30.0 % 43°C (110°F)
<i>Black Liquor Solids</i>	
Volatile Matter	24.8 %
Fixed Carbon	20.9 %
Inorganic	54.3 %
Heating Value	13157 kJ/kg (5657 Btu/lb)
<i>Stationary Liquor Gun</i>	
Nozzle type	BETE® MP
Nozzle diameter	0.396 cm (5/32 inch)
Tilt angle	60° down
Nozzle conditions	115°C, 127 kPa gauge (238°F, 18.4 psig)

Comparison of Furnace Simulations

Another objective of the modeling study was to demonstrate the capability for scaling RFS experimental results to commercial unit performance. Model predictions for the RFS were compared to that of the reference commercial unit to verify that the thermal and chemical conditions in the furnaces

TABLE II. COMMERCIAL UNIT OPERATING CONDITIONS

	Case 1		Case 2	
<i>Flow Rates</i>				
Air	28.7 kg/s (63.2 lb/s)		26.2 kg/s (57.8 lb/s)	
Liquor	86.3 kg/s (190 lb/s)		81.9 kg/s (181 lb/s)	
Solids	71.6 %		70.2 %	
<i>Air Distribution & Temperature</i>				
Primary	32%	164°C (328°F)	42%	161°C (321°F)
Secondary	49%	159°C (318°F)	32%	172°C (342°F)
Tertiary	19%	62°C (144°F)	26%	66°C (150°F)
<i>Black Liquor Solids</i>				
Volatile Matter	24.9 %		22.3 %	
Fixed Carbon	20.8 %		18.6 %	
Inorganic	54.3 %		59.1 %	
Heating Value	13153 kJ/kg (5655 Btu/lb)		12430 kJ/kg (5344 Btu/lb)	
<i>Stationary Liquor Guns</i>				
Guns in Operation	6 (3 right, 3 left)		4 (one on each wall)	
Nozzle type	35° B&W splash plates		49° B&W splash plates	
Nozzle diameter	2.38 cm (15/16 inch)		2.06 cm (13/16 inch)	
Barrel angle	5° down		10° down	
Nozzle conditions	131°C, 106.2 kPa gauge (267°F, 15.4 psig)		113°C, 185.4 kPa gauge (235°F, 26.9 psig)	

are similar. The ability to achieve similar furnace conditions increases our confidence in the RFS design.

The furnace operating conditions of the RFS and reference commercial unit are given in Tables I and II. The RFS fires black liquor at the rate of 11 metric tons of dry solids per day as compared to that of the commercial unit which fires black liquor at a rate of 1700 metric tons (3.8 million pounds) of dry solids per day. Air distribution to the three level air system used in the RFS is similar to that of the commercial unit. Air and liquor inlet temperatures are also similar. Median drop size of the black liquor spray is 1.0 mm for the RFS as compared to 2.5 to 3.0 mm for the commercial unit. The differences in drop size are offset by roughly a factor of 3 increase in average vertical gas velocity from pilot to commercial scale. The modeling results for Case 1 of the commercial unit were described elsewhere [1]. The results of Case 2 are presented here for comparison with the RFS, because the operating conditions are more similar to the nominal values chosen for RFS design.

The design and operating conditions described above were used to set up the numerical model. The furnace enclosure was subdivided into control volumes and blockages were used to approximate the shape of the enclosure walls, char bed, and furnace nose. The superheater of the commercial unit was simulated with flow resistance and heat transfer boundary conditions representing the tube banks. The walls of the furnace were modeled with thermal boundary conditions to represent conduction heat transfer through a deposit layer and tube metal (commercial unit) or refractory (RFS) walls. Air flow was introduced to the model by specifying the mass flow

rate, velocity, and temperature at each inlet to the furnace. Black liquor properties (elemental analysis, heating value, and physical properties), combustion parameters (swelling characteristics, drying, devolatilization, and char burning rates), and operating parameters (temperature, pressure, and flow rate) are also provided as input to the model. Black liquor spray was introduced by specifying the drop size distribution and velocity distribution of the spray at the exit of each nozzle. Numerical results are achieved using a high-speed computer workstation which takes 5 to 7 days to solve the three-dimensional distribution of flow, temperature, and chemical species in the furnace.

The model produces a variety of three-dimensional output. Selected results are presented for comparison of the RFS and commercial unit:

Gas Flow Field. The gas flow field at a vertical plane at the center of each furnace is shown in Fig. 6. The RFS is shown on the left; the size of the RFS is exaggerated for comparison with the commercial unit. The arrows outside the furnace boundaries denote the elevation of primary, secondary, and tertiary air ports and black liquor guns. In the commercial unit, several jets of air are shown entering the furnace at the primary, secondary, and tertiary air levels. Primary and secondary air jets are not evident in the RFS because primary air ports were located off center and secondary ports on the front and rear walls were closed. In both units, the tertiary air jet on the rear wall penetrates approximately halfway into the furnace and interlaces with other jets on the opposite wall.

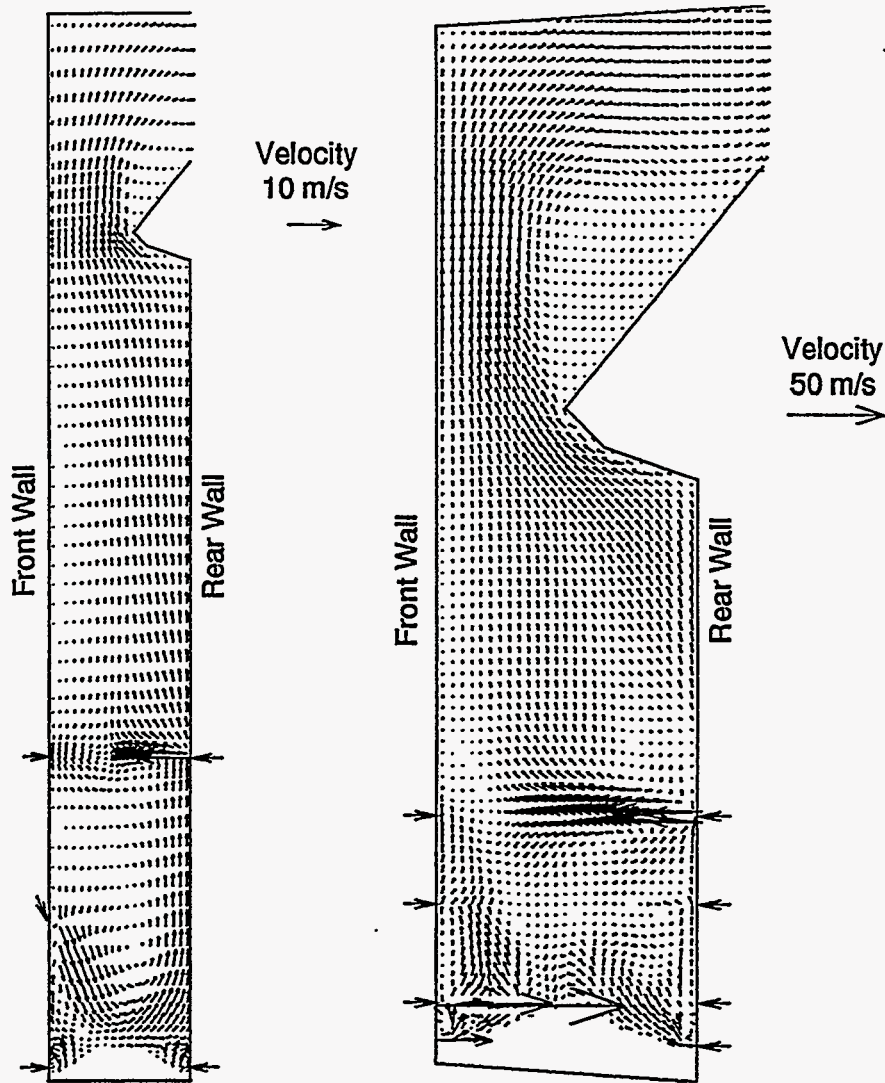

Figure 6. Gas flow patterns at center plane for RFS (left) and reference boiler (right). Dimensions are not to scale.

The most significant difference between pilot and commercial scale flow patterns occurs near the black liquor guns (Fig. 6). In the commercial unit, the gas flow is relatively unaffected by the black liquor spray; the gas flow is generally countercurrent with the particles which settle to the bottom of the furnace. However in the lower furnace of the RFS, the black liquor spray has a significant influence on the gas flow distribution. The spray entrains the gas, creating downward flow near the front wall and upward flow near the rear wall. There are two reasons for this behavior: 1) the momentum ratio between the spray and the gas is higher in the RFS, and 2) the exchange in momentum between particles and gas occurs more rapidly for the smaller drop size. Gas entrainment by the black liquor spray was minimized with the use of the BETE® nozzle, but cannot be eliminated.

The fraction of downward, recirculating gas flow is shown in Fig. 7 for the RFS and commercial unit at two operating

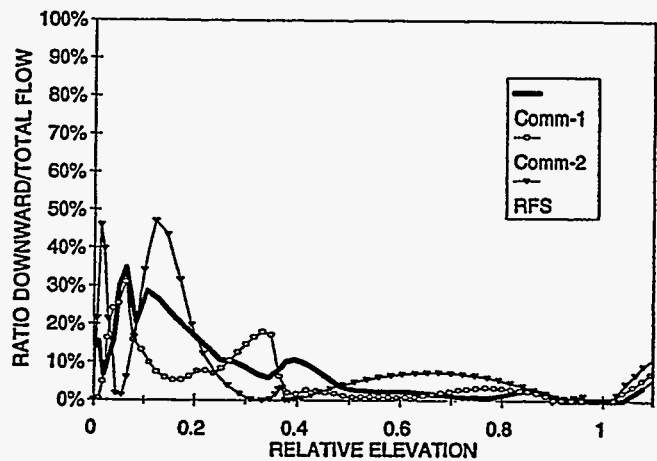

Figure 7. Gas recirculation (percentage of downward flow) as a function of relative elevation to furnace nose.

conditions. Furnace elevation is normalized in this figure with 0.0 representing the elevation of the primary air ports and 1.0 representing the tip of the furnace nose. Gas recirculation in the lower furnace can vary considerably as exhibited by the two operating conditions for the commercial unit. A greater amount of downward flow is present in the lower furnace of the RFS due to gas entrainment by the black liquor spray. However the location of the recirculation zone is similar to that of commercial scale. In the upper furnace, the upward flow is less uniform in the RFS and some recirculation exists along the front wall. An adjustment to the tertiary air flow could be made to correct this flow non-uniformity; however, this adjustment was not simulated in the model.

Black Liquor Spray Distribution. The drop combustion model calculates several thousand particle trajectories to represent the black liquor spray as it burns in flight. Particle trajectories are terminated when the particles strike the walls or surface of the char bed where they are assumed to stick until burning is completed. The fate of black liquor is summarized in Tables III and IV for the RFS and commercial unit. The columns represent where mass is evolved or deposited, while the rows represent the black liquor constituents: water, volatiles, char, and inorganics. Comparing the results in Tables III and IV suggests the distribution of black liquor in the RFS and commercial unit are similar. Taking water as an example, over 90% is evolved in flight a small percentage is deposited on the walls and bed, and nothing leaves the furnace exit. Volatiles that are not evolved in flight, are evolved from deposits on the furnace walls and char bed. Most of the char and inorganic material is deposited on the bed or the furnace walls, where the char continues to burn. Based on these results, the amount of suspension drying and burning of black liquor spray, and the amount of burning that occurs on the char bed of a commercial unit can be experimentally simulated in the RFS. The amount of carryover is lower in the RFS due to the narrower range of drop size produced by the smaller black liquor nozzle.

Thermal and Chemical Environment. The temperature distribution in the RFS and commercial unit are compared in Fig. 8. Gas temperature is highest near the char bed; it decreases with elevation as upward flowing gases lose heat by radiation to the furnace walls. The introduction of air to the furnace causes lower temperatures near these inlets. In the RFS, water evaporation from the black liquor reduces gas temperature in the vicinity of the spray. The effects of water evaporation are less evident for the commercial boiler because particle flow is generally countercurrent with the gas flow. Gas temperatures in the lower furnace can vary considerably as exhibited by the two operating conditions for the commercial unit (Fig. 9). In Case 1, the commercial unit is hotter near the liquor gun elevation because there is more black liquor burning in suspension than on the char bed. In Case 2, there is more combustion on the char bed and less suspension burning. Figure 9 demonstrates that gas temperatures in the RFS fall within the range of conditions predicted for commercial scale.

TABLE III. SUMMARY OF BLACK LIQUOR DROP FATE FOR RFS

	<i>Liquor Mass Fraction</i>	<i>In Flight</i>	<i>Walls</i>	<i>Bed</i>	<i>Exit</i>
Water, %	30.0	93.4	1.3	5.3	0.0
Volatiles, %	17.4	30.8	21.1	48.1	0.0
Char, %	14.6	6.2	38.6	54.7	0.5
Inorganic, %	<u>38.0</u>	<u>1.1</u>	<u>42.8</u>	<u>55.1</u>	<u>1.7</u>
	100.0	34.7	25.7	38.9	0.7

TABLE IV. SUMMARY OF BLACK LIQUOR DROP FATE FOR COMMERCIAL UNIT (CASE 2)

	<i>Liquor Mass Fraction</i>	<i>In Flight</i>	<i>Walls</i>	<i>Bed</i>	<i>Exit</i>
Water, %	29.9	92.8	5.3	1.9	0.0
Volatiles, %	15.6	39.8	9.3	50.9	0.0
Char, %	13.0	7.0	26.3	65.1	1.6
Inorganic, %	<u>41.5</u>	<u>1.3</u>	<u>28.8</u>	<u>65.7</u>	<u>4.2</u>
	100.0	35.4	18.4	44.3	1.9

The oxygen distribution in the RFS and commercial unit are compared in Fig. 10. The highest oxygen concentrations exist where primary, secondary, and tertiary air jets enter the furnace. In the lower furnace, an excess of black liquor burns with the primary and secondary air, creating reducing conditions with low oxygen concentrations (< 1%). Tertiary air penetrates and mixes with lower furnace gases to achieve oxidizing conditions in the upper furnace. Mixing is completed in the upper furnace and any remaining combustible gases are oxidized before the flow exits the furnace. The gas exits the furnace with 1.5 to 2% excess O₂. Based on predicted oxygen distributions, the chemical environment in the lower and upper furnace of the RFS is similar to that of commercial scale.

The gas residence time from the primary air ports (0.0) to the furnace nose (1.0) is approximately 8.2 seconds for both pilot and commercial scale (Fig. 11). The residence time between air levels is also well represented in the RFS design, due to the similarity in the residence time profile. Similarity in chemical and thermal environment, combined with gas residence time make the RFS design well-suited for experimental simulation of black liquor combustion in a kraft recovery boiler.

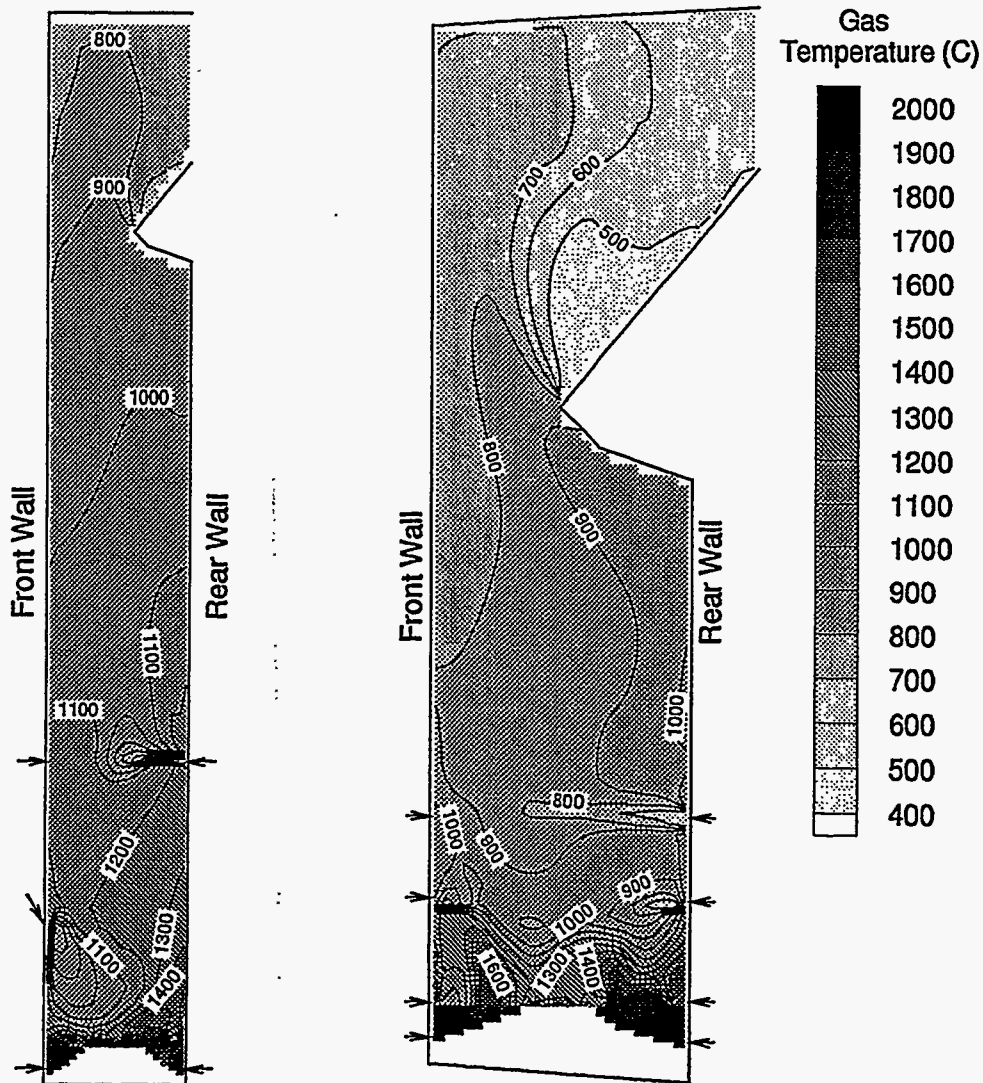

Figure 8. Temperature distributions at center plane of RFS and reference boiler.

Comparison of Convection Pass Simulations

The design objective for the RFS convection pass was to approximate the gas time-temperature history of a commercial unit. It is desired to simulate the thermal environment for studying chemical reactions such as sulfurization of inorganic aerosol (fume). The preliminary RFS convection pass design demonstrates that achieving a commercial gas cooling rate is feasible. However, for safety reasons, there is an additional 2.3-2.5 seconds of residence time in the RFS prior to entering the first tube bank.

The impact of the RFS horizontal cavity on gas time-temperature history is illustrated in Fig. 12. Residence time equal to zero for both the RFS and commercial unit is taken at the vertical plane extending upward from the furnace nose.

Field data indicate that the majority of sulfur capture by fume

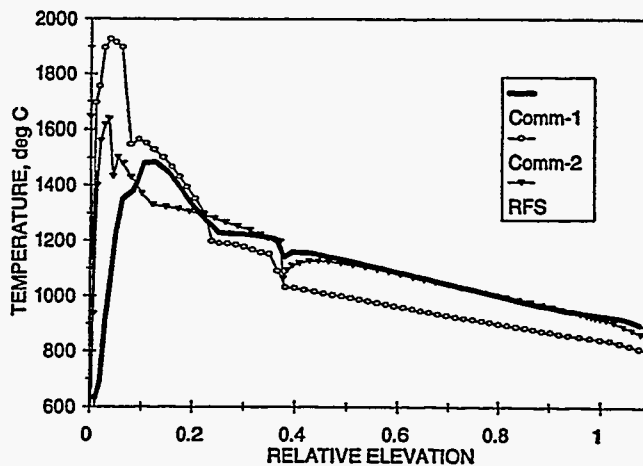

Figure 9. Average gas temperature as a function of relative elevation to furnace nose.

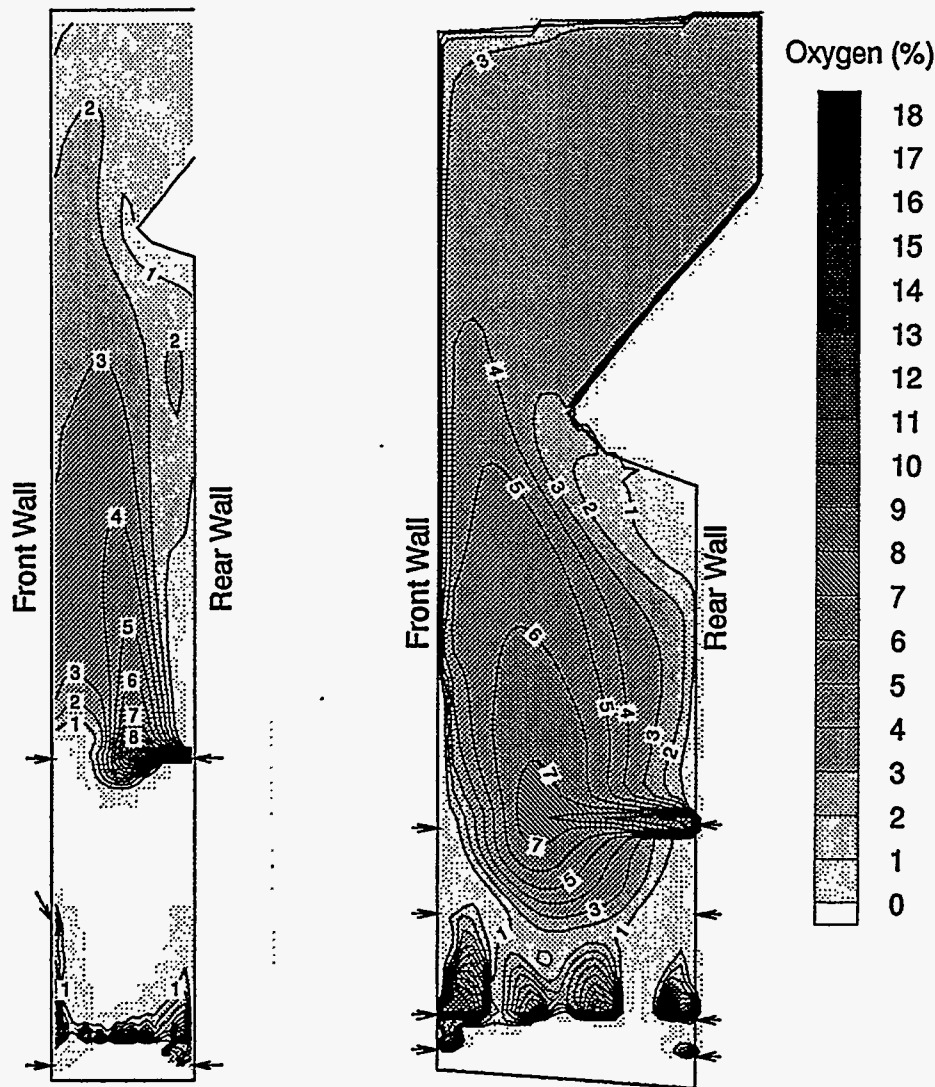

Figure 10. Oxygen concentration (percent by volume, wet basis) at center plane of RFS and reference boiler.

occurs while the aerosol is still in the liquid state [4,13]. Assuming a normal level of chlorine in the aerosol, fume is completely solid at a gas temperature of 630°C (1166°F) [12]. The calculated gas time-temperature profile across the superheater and generating bank of the commercial unit suggests that the flue gas temperature drops to 625°C (1157°F) in 2.0 seconds. The residence time in the insulated horizontal cavity of the RFS ("CAV 0 INS REF" profile in Fig. 12) is approximately 2.3 seconds with an exit temperature of 780°C (1436°F). Thus, there is sufficient time for sulfur capture while the fume is still in the liquid state.

A comparison of the slope of the "CAV 0 INS REF" curve from the entrance of the first RFS tube bank (780°C) in Fig. 12 and the point of equivalent gas temperature in the commercial unit (0.65 s) suggests that the gas cooling rate in the RFS convection pass closely matches that of the commercial unit.

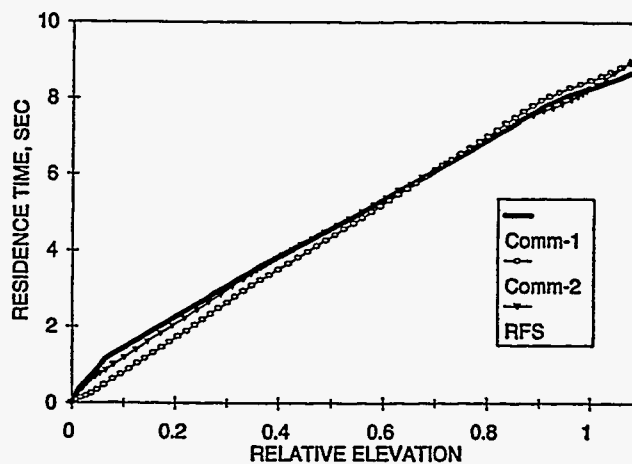

Figure 11. Residence time as a function of relative elevation to furnace nose.

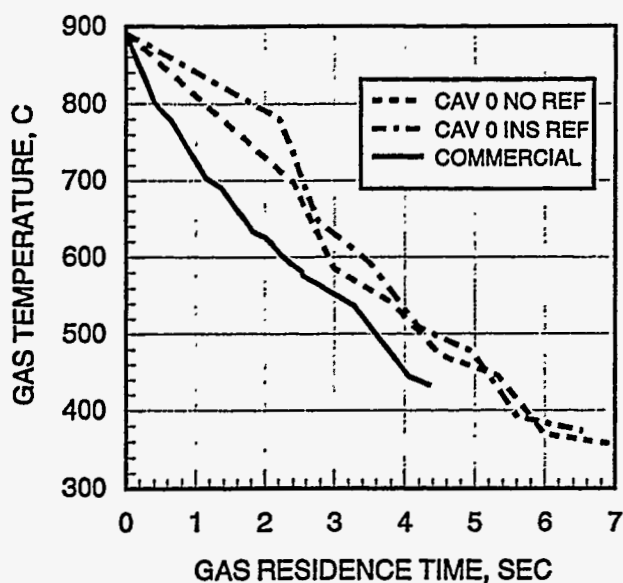

Figure 12. Convection pass time-temperature profiles for reference boiler and RFS (with and without refractory lining of horizontal cavity).

It is not expected that the delayed quenching of the flue gas would significantly affect emissions chemistry. However, if a more rapid quench is judged to be required, there are remedies to reduce the impact of the extended hot cavity without significantly changing the design of the RFS. One partial remedy is simply not to refractory line the cavity ahead of the convection pass; thus, utilizing the enhanced heat loss in the cold cavity to cool the gas. The result for this option is the "CAV 0 NO REF" profile in Fig. 12. The residence time in the unlined horizontal cavity is 2.4 seconds with an exit temperature of 700°C (1292°F). Further refinement of the convection pass design can improve the match of the gas time-temperature profile. These refinements would be made in the detailed design task specified for the next phase of the project.

PROJECT STATUS

The work on the first phase of this program, aside from any final report revisions, is scheduled to be completed in March 1995. Results of this phase include an RFS preliminary design, which along with the numerical modeling results that supported the design, are described in this paper. In addition, this phase includes economic evaluation of the program, revising the facility cost estimate, evaluating the effects of high-solids properties on the design, and identifying key suppliers and industry supporters.

Major objectives proposed for later phases include: completing the RFS detailed design, construction, and start up; characterizing the RFS performance relative to that expected in a commercial unit; and developing an advanced combustor design. The final proposed goal is the design, construction, and start up of the first commercial installation of a high-solids, advanced combustor. The results of the first phase will include the recommended direction of the future phases of the

program based on other inputs such as industry trends, DOE recommendations, and commercial business evaluations.

SUMMARY

There is a need for a facility to bridge the gap between existing bench-scale data and that required for commercial-scale advanced black liquor combustor design. Because of the investments involved, paper companies have been hesitant to depart from proven recovery technology. Therefore, recovery boiler design improvements have been limited to incremental changes from one generation of units to the next. The proposed RFS would provide a unique, cost-effective means to evaluate significant changes to recovery boiler design and operating strategy for optimization of high solids operation. The pulp and paper industry would benefit from this facility through increased operating efficiencies as well as lower capital and operating costs.

The preliminary design of the RFS was supported by using a three-dimensional numerical model of the kraft recovery boiler. The model was useful for screening preliminary designs of the air and liquor delivery systems and for determining the amount of refractory needed in the furnace. Agreement of predicted black liquor distribution, gas temperature, and residence time for the RFS and reference commercial unit suggests that the proposed RFS can simulate black liquor combustion in a kraft recovery boiler. Such a facility would provide a scientifically controlled environment to make measurements for validating computational models.

ACKNOWLEDGMENTS

The authors gratefully acknowledge the assistance of Mr. W. J. Oberjohn in modeling the RFS and generating many of the figures used in this paper. This work was funded in part by the U.S. Department of Energy, Office of Industrial Technology (contract number DE-FC36-95GO10002).

REFERENCES

1. WESSEL, R.A., PARKER, K.L., and AKAN-ETUK, A., "Three-Dimensional Flow and Combustion Model of a Kraft Recovery Furnace," Proc. TAPPI Eng. Conf., Orlando, FL (1993).
2. FREDERICK, W.J., "Combustion Processes in Black Liquor Recovery: Analysis and Interpretation of Combustion Rate Data and an Engineering Design Model," Report No. 1, U.S. Dept. of Energy DOE/CE/40637-T8 (DE90012712) (1990).
3. FREDERICK, W.J., and HUPA, M., "Combustion Properties of Kraft Black Liquors," report for U.S. Dept. of Energy, contract DE-FG02-90CE40936 (1993).
4. HINER, L.A., "Kraft Recovery Boiler Operation for Control of Ash Chemistry," Proc. TAPPI Eng. Conf., San Francisco, CA (1994).

5. MARINGO, G.J., HATFIELD, P.E., FARZAN, H., and RODGERS, L.W., "Furnace Sorbent Injection for SO₂ Reduction in Cyclone Equipped Boilers," EPRI CS-5855, Project 2533-5, Final Report (June 1988).
6. TRAN, H.N., THOMPSON, S.L., PRYKE, D.C., and REEVE, D.W., "On-Line Measurement of Fireside Deposit Accumulation in Kraft Recovery Boilers," Proc. TAPPI Pulping Conf., Toronto, Ontario (1986).
7. YOUNG, J.W., "Meadow Lake Enters Third Year of Zero-Effluent Pulp Production," *Pulp Paper* 68(3):56-61 (1994).
8. JOHANSON, N.R., ATTIG, R.C., MUEHLHAEUSER, J.W., CHAPMAN, J.N., and SANDERS, M., "2004 Hours of Proof-of-Concept Testing at the CFFF," Proc. 29th Symp. on Engineering Aspects of Magnetohydrodynamics, New Orleans, LA, p. 1.2.1 (1991).
9. IVANOV, Y.V., *Effective Combustion of Overfire Fuel Gases in Furnaces*. Tallinn: Estonian State Pub. House (1959).
10. SPIELBAUER, T.M., ADAMS, T.N., MONACELLI, J.E., and BAILEY, R.T., "Drop Size Distribution of Black Liquor Sprays," Proc. TAPPI/CPA Int. Chem. Recovery Conf., Ottawa, Ontario, p. 119-125 (1989).
11. EMPIE, H.J., LIEN, S.J., YANG, W., and ADAMS, T.N., "Spraying Characteristics of Commercial Black Liquor Nozzles," *Tappi* 78(1):121-128 (1995).
12. ADAMS, T.N., and FREDERICK, W.J., *Kraft Recovery Boiler Physical and Chemical Processes*. New York: American Paper Institute (1988).
13. BOONSONGSUP, L. IISA, K., FREDERICK, W.J., and HINER, L.A., "SO₂ Capture and HCl Release at Kraft Recovery Boiler Conditions," 1993 AIChE Forest Products Symp., AIChE Symp. Ser. 90(302):39-45 (1994).