

*Flat Panel Displays in Perspective*

September 1995

OTA-ITC-631

GPO stock #052-003-01438-6

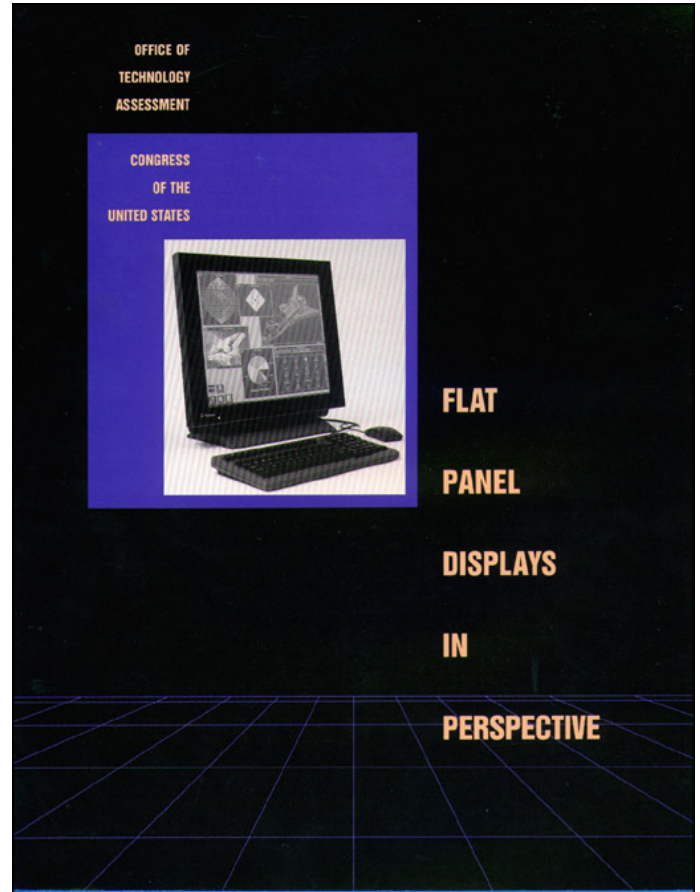

**Cover Photo Credit:** Plasmaco, Inc.

**Recommended Citation:** U.S. Congress, Office of Technology Assessment, *Flat Panel Displays in Perspective*, OTA-ITC-631 (Washington, DC: U.S. Government Printing Office, September 1995).

# Foreword

**F**lat panel displays (FPDs) are increasingly important in this information-intensive era. Compared with the cathode ray tube used in televisions, FPDs are thin, lightweight, and power efficient. These displays have enabled the development of portable computers and communication devices. Applications in automobiles and offices will increase, and FPDs may eventually result in the fabled television-on-the-wall. FPDs represent a large and rapidly growing industry worldwide, and are expanding into an increasingly diverse set of systems. American companies and researchers have made many of the key innovations in FPDs, but U.S. firms hold a very small share of the world market. Some observers have called for government intervention to strengthen the U.S. industry. One area of concern—access to displays for military use—has driven recent federal support for FPDs.

*Flat Panel Displays in Perspective* examines the potential benefits of a domestic, high-volume, FPD industry for the nation, and evaluates the role of government policies in developing it. The report concludes that such an industry would provide both economic and national security benefits. The extent of these benefits is difficult to determine, however, largely because trends in technology development and industry structure are resulting in more displays at declining prices. The barriers to establishing a high-volume FPD industry are formidable, and government tools to address them are limited. However, government funding can play a role by helping to build domestic sources for some displays, such as those used in military systems. An additional finding is that the Department of Defense already uses some foreign displays, but it could take better advantage of FPD sources worldwide.

This report was requested by the Senate Armed Services Committee. It was produced under the auspices of the Assessment on Innovation and Commercialization of Emerging Technologies, requested by the House Science Committee (formerly the Science, Space, and Technology Committee) and the Senate Commerce, Science, and Transportation Committee.

OTA would like to acknowledge the review comments and inputs from members of the Innovation and Commercialization of Emerging Technologies Advisory Panel, as well as experts from government, academia, and the FPD industry. However, the content of the report is the responsibility of OTA.



**ROGER C. HERDMAN**

Director

# Advisory Panel

**Avtar S. Oberai**

*Chairman*

Consultant

**Paul Brickmeier**

Vice President of Advanced  
Development  
SVG Lithography Systems, Inc.

**Linda A. Capuano**

Vice President  
Conductus, Inc.

**Sidney C. Chao**

Hughes Environmental Systems,  
Inc.

**Robert Cook-Deegan**

Director, Division of Behavioral  
Sciences and Mental Disorders  
Institute of Medicine  
National Academy of Sciences

**Mark Cunningham**

Oppenheimer and Co.

**Mark Eaton**

President  
JMC Ventures

**Robert T. Fraley**

Group Vice President and General  
Manager  
New Products Division  
Monsanto Co.

**Charles E. Harris**

Chairman and CEO  
Harris & Harris Group, Inc.

**Maryellen R. Kelley**

Visiting Professor  
Industrial Performance Center  
Massachusetts Institute of  
Technology

**Ken Kennedy**

Director  
Center for Research in Parallel  
Computation  
Rice University

**William G. Morin**

Director, Technology Policy  
National Association of  
Manufacturers

**Mark Myers**

Senior Vice President  
Xerox Corp.

**Walter H. Plosila**

Executive Director  
North Carolina Alliance for  
Competitive Technologies

**John T. Preston**

Director of Technology  
Development  
Massachusetts Institute of  
Technology

**Michael A. Rappa**

Associate Professor  
Sloan School of Management  
Massachusetts Institute of  
Technology

**Richard S. Rosenbloom**

David Sarnoff Professor of  
Business Administration  
Harvard Business School

**Maxine L. Savitz**

Garrett Processing Division  
Allied-Signal Aerospace

**Louis Tornatzky**

Director, Southern Technology  
Council  
Southern Growth Policies Board

**Stephen Turner**

CEO/President  
Oncor Inc.

**Les Vadasz**

Senior Vice President  
Intel Corp.

**Note:** OTA appreciates the valuable assistance and thoughtful comments provided by the advisory panelists. The panel does not, however, necessarily approve, disapprove, or endorse this report. OTA assumes full responsibility for the report and the accuracy of its contents.

# Project Staff

**Peter D. Blair**

Assistant Director, OTA  
*Industry, Commerce, and  
International Security Division*

**Audrey B. Buyrn**

Program Director<sup>1</sup>

**Andrew W. Wyckoff**

Program Director  
*Industry, Telecommunications,  
and Commerce Program*

**Julie Fox Gorte**

Project Director<sup>2</sup>

**Robert C. Weissler**

Project Director  
*Innovation and Commercialization  
of Emerging Technologies  
Project*

**PRINCIPAL STAFF****Paul D. Semenza**

Analyst

**David J. Eichberg**

Research Analyst

**Jean E. Smith**

Editor

**OTA CONTRIBUTORS****Jerry Sheehan****Jack Nunn****James W. Curlin****Gerald Epstein****ADMINISTRATIVE STAFF****Liz Emanuel**

Office Administrator

**Karry Fornshill**

Secretary

**Diane Jackson**

Secretary

**Karolyn St. Clair**

PC Specialist

**PUBLISHING STAFF****Mary Lou Higgs**

Manager, Publishing Services

**Chip Moore**

Production Editor

**Christine Onrubia**

Graphic Designer

**Bonnie Sparks**

Electronic Publishing Specialist

---

<sup>1</sup>Until August 1994.

<sup>2</sup>Until April 1995.

# Reviewers

**Richard Archambault**

Director, Computer Products  
Sourcing and Manufacturing  
AT&T

**Claude Barfield**

Director, Science and Technology  
Policy Studies  
American Enterprise Institute

**Arpad A. Bergh**

President  
Optoelectronics Industry  
Development Association

**Curtis Casey**

Vice President  
Optical Imaging Systems, Inc.

**Joseph Castellano**

President  
Stanford Resources, Inc.

**Michael Ciesinski**

Chief Executive Officer  
United States Display Consortium

**Steven Depp**

Director, Subsystem Technologies  
and Applications Laboratory  
IBM

**Daniel J. Devine**

Vice President, Technology  
Coloray Display Corp.

**Kenneth Flamm<sup>1</sup>**

Principal Deputy Assistant  
Secretary of Defense  
Department of Defense

**Roland Haitz**

Components Group  
Hewlett Packard

**Jeffrey Hart**

Professor of Political Science  
Indiana University

**Mark Hartney**

Advanced Research Projects  
Agency  
Department of Defense

**Heidi Hoffman**

Director, Industry/ Government  
Relations  
United States Display Consortium

**Darrel Hopper**

Wright Laboratory  
U.S. Air Force

**Joshua Lerner**

Assistant Professor of Business  
Administration  
Harvard University

**Susan MacKnight**

Chief Economist  
Japan Economic Institute

**Glenn McLaughlin**

Specialist  
Congressional Research Service

**David Mentley**

Director  
Display Industry Research  
Stanford Resources, Inc.

**Richard Nunno**

Analyst  
Congressional Research Service

**Steven Pederson**

Microelectronics and Computer  
Technology Corp.

**Roger Smith**

Manager, Government Business  
American Electronics Association

**Phil Spletter**

Microelectronics and Computer  
Technology Corporation

**Curtis M. Stevens**

Chief Financial Officer  
Planar Systems, Inc.

---

<sup>1</sup>Current Affiliation: Brookings Institution

**Rex Tapp**  
President & CEO  
Optical Imaging Systems, Inc.

**Richard Thayer**  
Director, Government Affairs  
AT&T

**Richard Van Atta**  
Special Assistant for Dual Use  
Technology  
U.S. Department of Defense

**Phillip Webre**  
Analyst  
Congressional Budget Office

**Charles Wessner**  
Program Director of Technology  
and Competitiveness  
National Research Council

**Robert A. Young**  
Vice President, Product  
Development  
Coloray Display Corp.

# Contents

<b>1</b>	<b>Summary and Policy Issues</b>	<b>1</b>
	Industry Overview	3
	The Domestic FPD Industry: Cause For Concern?	10
	Strategies and Policies for a Domestic FPD Industry	18
<b>2</b>	<b>The Domestic Flat Panel Display Industry: Cause for Concern?</b>	<b>25</b>
	Demand for Flat Panel Displays	26
	Supply of Flat Panel Displays	31
	Effects on Related Industries	42
	National Security Requirements	50
<b>3</b>	<b>Strategies and Policies for the Domestic Flat Panel Display Industry</b>	<b>61</b>
	Domestic Efforts to Commercialize FPD Technology	62
	Strategies for Market Entry	65
	Government Activity	75
<b>APPENDICES</b>		
<b>A</b>	<b>Flat Panel Display Technologies and Domestic Firms</b>	<b>89</b>
<b>B</b>	<b>List of Acronyms</b>	<b>105</b>





# Summary and Policy Issues | 1

**F**lat panel displays (FPDs) are thin electronic devices that present images without the bulk of a picture tube. FPDs have enabled the development of products from digital wristwatches to notebook computers, have improved videocameras and other consumer goods, and will be the heart of wide screen televisions that can hang on a wall. FPDs also present critical information to military forces; they are replacing older displays in aircraft, ships, and vehicles, and are allowing the development of new systems, such as head-mounted displays for individual soldiers.

FPD technology was largely developed in American laboratories, and much of the advanced research in new FPD technologies takes place in the United States. However, the United States has not had a significant capability to manufacture FPDs. Companies capable of manufacturing displays have either decided not to do so or, lacking the necessary financial resources, have been unable to persuade other organizations to fund their efforts. U.S. firms do not have an appreciable fraction of world market share.

Over the past few years, the size and scope of activities and sales in the FPD industry have grown. As market demand for FPDs has grown and the industry has moved into a more mature phase, the role of capital expenditures and manufacturing knowledge has become preeminent. As investment costs have increased and competition has intensified, entry into the mainstream market segments has become more problematic for U.S. firms. These firms continue to pursue established niche technologies and technologies that are not commercialized. However, the market segments for niche technologies remain a small part of the overall FPD market, and new technologies must compete against an increasingly dominant entrenched technology. This situation leads

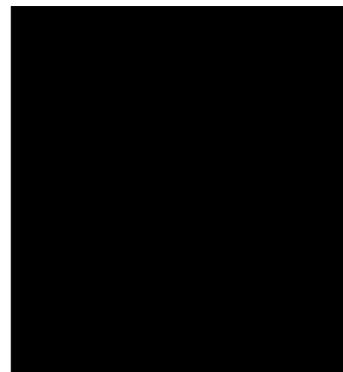

## 2 | Flat Panel Displays in Perspective

to the conclusion that successful entry into this market will be costly and difficult to achieve. This conclusion, however, is not sufficient to argue against a vigorous effort to enter into the FPD market; rather, it demands that the rewards should be large, given the risks to entry.

This report addresses two issues. First, is the lack of a high-volume domestic FPD industry a cause for national concern? Why might having such an industry be important for the good of the nation? Second, if the government wishes to foster such an industry, what policies might be most effective? In particular, how likely is the Clinton Administration's National Flat Panel Display Initiative to succeed? OTA finds:

1. *A high-volume FPD industry would confer a range of commercial and military benefits on the country. However, there is a good deal of uncertainty regarding the exact nature of these benefits, and it is difficult to weigh them against the costs necessary to establish such an industry (see chapter 2).*

Although FPDs are clearly important economically and militarily, having a high-volume domestic industry may not be as critical as some have asserted. An analysis of the economic benefits of such an industry indicates that some trends in technology development and industry structure may prove as beneficial to users of FPDs as they are to producers. FPDs comprise a diverse set of technologies and applications, however, and the picture remains a mixed one.

Furthermore, while the military importance of FPDs is not altered by changes in technology and markets, these changes may increase the choices available to the military in gaining access to FPD technologies. Specifically, changes in the global FPD industry present new sources of displays. In addition to efforts to develop a high-volume do-

mestic industry, the Department of Defense (DOD) could take advantage of these shifts and encourage the growth of existing FPD capabilities.

2. *The barriers to establishing a high-volume domestic FPD industry are formidable, and government tools to address them are limited (including those in the National Flat Panel Display Initiative). It will be difficult for even a vigorous government program to foster the development of a self-sustaining, domestic high-volume industry. However, government funding can play a role in developing domestic sources for some displays (see chapter 3).*

DOD states that its goal is to obtain early, assured, and affordable access to leading-edge display technologies. DOD's approach to reaching this goal is to encourage the development of a dual-use FPD industry that produces large volumes of displays for commercial markets and is also willing and able to give DOD early access to specialized display technology. DOD's own indicator of progress towards this goal—development of a domestic FPD industry equaling 15 percent of world production by the end of the decade—has a low probability of being achieved. However, DOD's approach does include elements that are likely to strengthen the domestic FPD industry. The difficulties inherent in DOD's approach do not discount that approach, but they provide incentive to consider other policies as well.

The weakness of the U.S. industrial base for FPDs has been a policy concern for several years, and display technology is consistently flagged as an area of concern in listings of critical technologies.<sup>1</sup> DOD has played the lead role in supporting the government's development of FPD technologies, largely through its Advanced Research Projects Agency (ARPA). In particular, ARPA's High

---

<sup>1</sup> The most recent report from the National Critical Technologies Review Group identified high definition displays as the only area within information and communication technologies—and one of only three among all technology areas—in which the U.S. technology position indicated a substantial lag relative to Japan or Europe; see *National Critical Technologies Report*, March 1995. Earlier reports (and the category related to FPDs) include Department of Commerce, *Emerging Technologies: A Survey of Technical and Economic Opportunities*, spring 1990 (digital imaging technology); Department of Defense, *Critical Technologies Plan*, Mar. 15, 1990 (photonics); *Report of the National Critical Technologies Panel*, March 1991 (high-definition imaging and displays); and Council on Competitiveness, *Gaining New Ground*, March 1991.

Definition Systems (HDS) program has drawn significant support from Congress.

The industry has attracted other government involvement in the form of: 1) antidumping tariffs; 2) research and development (R&D) programs under DOD and the Department of Energy (DOE), the National Aeronautics and Space Agency (NASA), and the National Science Foundation (NSF); and 3) a commercialization program under the Department of Commerce's Advanced Technology Program. OTA last investigated FPDs in the context of the high definition television (HDTV) debate of the late 1980s; since that report was prepared, circumstances have changed (see box 1-1).

## INDUSTRY OVERVIEW

It is estimated that worldwide sales of FPDs will total \$11.5 billion in 1995, and will double in value by the year 2000; some project the market will grow to \$40 billion by the end of the decade.<sup>2</sup> The largest demand for FPDs is for use in computers, mainly portable systems such as laptops, notebooks, and handheld devices. These applications use liquid crystal displays (LCDs), as does consumer electronics, the next largest category. The other large application areas are business and commercial systems, and industrial, communications, and transportation systems; both applications use electroluminescent (EL) displays and plasma displays, in addition to LCDs (see box 1-2 for a description of FPD types).

Military demand accounts for less than one percent of the global FPD market, and is expected to

stay relatively constant through the end of the decade.<sup>3</sup> Military displays use LCD, EL, and plasma technologies like the commercial markets, but often must satisfy rigorous performance specifications (for example, readability in bright sunlight, over wide viewing angles, and while subjected to a wide range of temperatures). Also, military displays often require size, packaging, and electronic interfaces that are different from displays used in the larger commercial markets. Military systems currently use a mix of custom FPDs and commercial FPDs, modified to military specifications.

The global FPD industry uses a diverse set of technologies to satisfy a broad array of applications (see appendix A). The dominant technology is the LCD, which itself comes in many forms; the primary variations are the active matrix LCD (AMLCD) and the passive matrix LCD (PMLCD). Measured by value of sales, LCDs account for approximately 87 percent of the FPD market in 1995, evenly divided between active and passive matrix types. By the year 2001, the share held by LCDs as a whole is projected to be about the same (88 percent), with AMLCDs accounting for 54 percent and PMLCDs for 34 percent.<sup>4</sup> As the FPD market as a whole is projected to double between 1995 and 2001, AMLCDs are expected to grow by a factor of 2.5 during that period. Smaller shares are accounted for by plasma and EL displays. In terms of value, these four FPD types make up the vast majority of the FPDs currently in use (see table 1-1).<sup>5</sup>

<sup>2</sup> Stanford Resources, Inc., projects that worldwide FPD market sales will be \$19.5 billion in the year 2000 and \$22.5 billion in 2001; David Mentley, Director, Display Industry Research, Stanford Resources, Inc., San Jose, CA, personal communication, Mar. 21, 1995. Projections made by Asian sources tend to be higher by as much as a factor of two; see "Scale of Liquid Crystal Industry Assessed," in *Flat Panel Display 1995*, *Nikkei Microdevices*, Dec. 9, 1994, pp. 74-80 (translation provided by Maurice Cloutier, Foreign Broadcast Information Service).

<sup>3</sup> Department of Defense, "Building U.S. Capabilities in Flat Panel Displays: The Flat Panel Display Task Force Final Report," October 1994, chapter III.

<sup>4</sup> Calculated from Stanford Resources, Inc., data, Mentley, op. cit., footnote 2.

<sup>5</sup> Two other types of FPDs—light emitting diodes and vacuum fluorescent displays—account for less than 10 percent of FPD sales. Although representing larger shares of the FPD market than plasma and EL displays, these are low-information-content displays, which present text and simple graphics in small display formats. These displays currently are not suitable for use in large and complex graphics applications, and are not discussed in this report.

## 4 | Flat Panel Displays in Perspective

### BOX 1-1: Flat Panel Display Policy In Historical Perspective

In 1990, the Office of Technology Assessment (OTA) released a report entitled *The Big Picture: HDTV & High-Resolution Systems*. The report came to the following conclusion regarding high resolution systems (HRS), which are primarily flat panel displays (FPDs):

A strong civilian HRS technology base is necessary if many HRS technologies are to be available for defense needs at all. The low costs realized for HRS technologies in the commercial sector, however, will not be automatically translated into low-cost HRS for defense applications. The complexity and specialized nature of defense systems result in long product cycles, high R&D and engineering costs, and stringent performance and reliability criteria that may have little relationship to commercial needs...<sup>2</sup>

Congress demonstrated its concern about the state of the domestic FPD industry by funding FPD R&D in the Department of Defense (DOD) at \$75 million in fiscal years 1991 and 1992. In fiscal year 1993, Congress appropriated nearly \$170 million.

In 1994, DOD announced the National Flat Panel Display Initiative (NFPDI). It continues existing FPD research, and introduces incentives for domestic firms to produce displays and for the armed services to purchase them. In light of this new policy, it is appropriate to revisit the FPD industry and relevant government policies, and to examine the current state of affairs. In the five years since OTA last studied FPD industry and policy, certain things remain unchanged. *The Big Picture* stated: "High Resolution Systems (HRS) and related technologies are likely to play an important role in future military systems. HRS technologies will, however, probably be driven primarily by the needs of the commercial sector."<sup>3</sup> This report confirms these findings, as does a separate OTA study.<sup>4</sup> However, three major changes have taken place that affect both the potential benefits of a domestic high-volume FPD industry and the costs of creating such an industry.

**Politico-Military Changes.** *The Big Picture* gave several reasons to be concerned about relying on foreign sources for advanced technology: 1) disruption of supply lines during a crisis, 2) pressure by U.S. adversaries on foreign suppliers to withhold critical components, and 3) ease of access by U.S. adversaries to foreign technology sources.<sup>5</sup> As indicated by the example given in that report (that of Soviet access to Japanese and Norwegian milling technology for making quiet submarine propellers), the concerns at that time were based on Soviet access to—or potential control over—foreign technology with military applications. In particular, the concern was over Soviet threats to Japanese FPD producers, the only overseas sources in 1990. Today, the tensions and concerns rising from the Cold War competition between the United States and the former Soviet Union have largely dissipated.

While the threats posed today by regional conflicts and terrorist groups are serious, it is not clear how adversaries (such as terrorist groups or nations such as Iraq or North Korea) would be able to obtain FPD technology ahead of, or even as soon as, DOD—from Japanese, Korean, or European firms, or even from the former Soviet Union. In February 1995, for example, a subsidiary of the Russian ener-

(continued)

<sup>1</sup>U.S. Congress, Office of Technology Assessment, *The Big Picture: HDTV and High Resolution Systems*, OTA-B P-C IT-64 (Washington, DC: U.S. Government Printing Office, June 1990)

<sup>2</sup>Ibid., p. 17

<sup>3</sup>Ibid., p. 16

<sup>4</sup>U.S. Congress, Office of Technology Assessment, *Assessing the Potential for Civil Military Integration: Selected Case Studies*, OTA-BP- ISS-158 (Washington, DC: U.S. Government Printing Office, September 1995)

<sup>5</sup>Office of Technology Assessment, op. cit., footnote 1, pp. 16-17

### BOX 1-1: Flat Panel Display Policy In Historical Perspective (Cont'd.)

gy company Gazprom announced a \$4-million investment in SI Diamond Technology, an FPD firm based in Houston, Texas.<sup>6</sup> A December 1994 report by the World Technology Evaluation Center described numerous other firms in Russia, Ukraine, and Belarus that are eager to collaborate with Western companies in FPD development.<sup>7</sup>

**Increased Diversity of Supply.** In 1990, large-scale production of FPDs was just beginning. There were few experienced suppliers, and the demand created by the portable computing market was in an early stage. The few companies with an operational large-scale FPD manufacturing capability were still struggling with low production yields, and were not interested in entering into any type of custom production. Currently, however, there are several high-volume FPD producers in Japan; investments made in Korea, Taiwan, and Europe will likely result in several more facilities within the next few years.

In addition, the domestic industry has improved its ability to meet DOD requirements over the past few years. This is largely due to investments made during the 1990s by DOD's Advanced Research Projects Agency (ARPA) High Definition Systems Program, the Commerce Department's Advanced Technology Program, and an increased level of cooperation and collaboration within Industry. DOD-funded companies such as OIS and Kopin have built capabilities for military display fabrication, Planar has expanded its electroluminescent display production, and several new firms are developing field emission displays.

The increasing diversity of high-volume FPD manufacturing (from a few Japanese producers in 1990 to many firms worldwide at present), plus the more advanced state of U.S. manufacturing, means that the risk of supply vulnerability has decreased. In evaluating the need for building a high-volume domestic industry to better satisfy the relatively small defense need, the trend toward FPD supply diversity, combined with the general openness in East-West relations detailed above, must be balanced against the cost of establishing a high-volume domestic FPD industry.

**Increased Barriers to Entry Into High-Volume FPD Production.** In 1990, Japan did not have the commanding lead it now has; since then, Japanese producers have invested several billion dollars in FPD production facilities. These investments have put Japanese producers well ahead of manufacturers in the United States, where investments have been in the hundreds of millions of dollars during this period. The emphasis on increasing manufacturing volumes, decreasing production costs, and concentrating on standardized products means that, in large segments of the market, competition is based on manufacturing, not design. In addition, the investment required to build a high-volume domestic FPD industry has greatly increased; capital expenditures required for one world-class plant to manufacture active matrix liquid crystal displays now approach half a billion dollars.

SOURCE: Office of Technology Assessment, 1995

<sup>6</sup>Agis Salpukas, "Russians Invest in High-Tech U.S. Venture," *New York Times*, Feb 11, 1995, p 35

<sup>7</sup>J William Deane (ed.), *WTEC Panel Report on Display Technologies in Russia, Ukraine, and Belarus* (Baltimore, MD: Loyola College in Maryland, December 1994)

### BOX 1-2: What Are Flat Panel Displays?

Flat panel displays (FPDs) are electronic displays that are much thinner than their screen size, measured diagonally. Like the most common type of electronic display, the cathode ray tube (CRT), FPDs visually present electronic information, including text, graphics, and video. FPDs are also used as displays for computers, cameras, televisions, and other video systems. The FPD presents information in a thin, lightweight package that can operate on a modest amount of power, whereas the CRT requires a large package—typically as deep as the display is wide—that is heavy and consumes large amounts of power.

FPDs have been available in various forms for several decades, but they are more expensive than CRTs for most sizes and they have been slow in replacing the established CRT. However, FPDs have enabled new portable electronics devices, such as laptop and notebook computers, pocket televisions, and personal communicators, that would not be possible using CRT displays. They also have improved other systems, such as aircraft cockpit displays, by replacing existing CRTs.

Unlike CRTs, which are all quite similar in terms of the basic operating principle, FPDs use several different technologies. Although they all serve the same function, and in some cases look very much the same, the different technologies have varied performance characteristics and limitations, and are manufactured using different materials and processes. However, most FPDs are generally comprised of a pair of glass plates surrounding a material that filters external light or emits its own light, and use manufacturing techniques closer to the production of semiconductor chips than televisions. Also, most FPDs operate by controlling the color and brightness of each picture element (or pixel) individually, rather than from one common source, as in the electron gun in a CRT, in general, FPDs can be categorized as follows,

**Liquid crystal displays LCDs** are the most prevalent type of FPD, and are used in notebook computers, pocket televisions, and personal digital assistants. LCDs use a material that acts like a shutter—blocking, dimming, or passing light unobstructed, depending on the magnitude of the electric field across the material. LCDs are lightweight and require little operating power. However, since LCDs only modify light, they require an external source of light; while ambient light is used in simple displays, complex, rapidly changing color displays require a bright light, typically mounted behind the LCD screen,

There are two primary types of LCDs *passive matrix* and *active matrix* LCDs (PMLCDs and AMLCDs, respectively). The PMLCD is the basic type of LCD; it is made by sandwiching liquid crystal material between two glass plates, each of which contains a parallel set of transparent electrical lines. The plates are arranged so that, looking through the display, the lines cross to form a checkerboard pattern, or matrix. Every intersection of two lines forms a pixel, and the voltage across that pixel determines the shade of that pixel. PMLCDs are commonly used for gasoline pump displays, pager screens, digital wristwatch readouts, and other applications that require a simple, inexpensive display; recent manufacturing improvements, however, have led to the application of PMLCDs to more complex display functions. AMLCDs use an electronic switch at every pixel, which provides faster switching and more shades. With the addition of filters that pass only certain colors, AMLCDs produce vivid color graphics in portable computer and television screens. The added complexity of manufacturing the switches results in a large, but diminishing, price premium compared with PMLCDs,

**Plasma displays** are used in systems that are viewed by many people, such as screens on the floor of stock exchanges. They can be manufactured in larger sizes than LCDs and, unlike LCDs are visible from angles far from straight-ahead viewing. Plasma displays use a gas trapped between the glass plates to emit light when electric current is passed through the matrix of lines on the glass, Mono-

(continued)

## BOX 1-2: What Are Flat Panel Displays? (Cont'd.)

chrome (single-color) displays use a gas that emits an orange color; full-color plasma displays use phosphors (similar to a CRT) that glow when illuminated by the gas. Plasma displays are heavy and require more power than LCDs, but may be more suitable for large screens to display high definition television broadcasts.

**Electroluminescent (EL) displays** are found in emergency rooms, on factory floors, and in commercial transportation vehicles. A phosphor film between glass plates emits light when an electric field is created across the film. EL displays are lightweight and durable, and recently have become available in full-color versions.

**Field emission displays (FEDs)** are not commercially available, but are anticipated to fill many display needs. An FED can be thought of as a flat CRT; as in the tube, electrons are emitted from one side of the display and energize colored phosphors on the other side. Unlike the CRT, which uses one source of electrons to sweep across the screen, FEDs have hundreds of emitters for each pixel. This allows for rapid changes of the image on the screen, and has the advantage of redundancy, in the event that some of the emitters fail, there are others to make up for it.

**Digital micromirror devices (DMDs)** are miniature arrays of tiny mirrors, built on a semiconductor chip. Each mirror can be tilted by changing the voltage at the location under that mirror. The DMD is used in a projector that shines light on the mirror array; depending on the position of a given mirror, that pixel in the display reflects the light either onto a lens that projects it onto a screen (resulting in a light pixel), or away from the lens (resulting in a dark pixel).

SOURCE Office of Technology Assessment, 1995

LCDs are the most prevalent display in computer and consumer electronics applications. In portable computers, 8- to 11-inch LCD screens currently share the market. AMLCD screens provide a brighter, faster, and sharper color display, but can increase the cost of a portable computer by several hundred dollars compared with a PMLCD. Consumer electronics devices, such as personal information and communication devices and electronic games, typically use low-cost PMLCDs.

Military display systems use a mix of custom-designed and -produced AMLCD, EL, and plasma displays, as well as modified commercial LCDs. Large plasma displays are used in applications where there are many viewers, such as financial trading floors, and EL displays are used in medical, industrial, and transportation equipment. Dig-

ital micromirror devices (DMDs) are just beginning to be used, and field emission displays (FEDs), which have shown promise for many FPD applications, are currently in the prototype stage.

The vast majority of investments in FPD manufacturing facilities have been made by private sources in East Asia to build LCD plants. One source estimates that publicly announced investments through the early 1990s totaled \$4.9 billion in Japan, \$2.0 billion in Korea, \$300 million in Europe, but only \$200 million in the United States.<sup>6</sup> Japanese producers account for most FPD production worldwide. In 1994, Japanese companies produced 98 percent of AMLCDs, 90 percent of PMLCDs, 65 percent of plasma displays, and 45 percent of EL displays, measured by market

<sup>6</sup>U.S. Display consortium, San Jose, CA, *Annual Report 1994*, p. 5.

## 8 | Flat Panel Displays in Perspective

**TABLE 1-1: Flat Panel Display Market Segments**

Application areas	Size (diagonal)	Technology	Basis of purchase	Segment size
Portable computers	8-11 inch	AMLCD, PMLCD	price, performance	large
Consumer electronics	<10 inch	PM LCD	price	medium
High performance products	2-10 inch	AMLCD, EL	performance	small
Multiviewer information screens	>20 inch	Plasma, LCD, and DMD projectors	performance	small
Medical, transportation, industrial products	various	EL	performance, price	small

KEY: AM LCD = active matrix liquid crystal display; DMD = digital micromirror device; EL = electroluminescent display, LCD = liquid crystal display; PMLCD = passive matrix liquid-crystal display

SOURCE: Office of Technology Assessment, 1995.

value.<sup>7</sup> Manufacturers in East Asian countries other than Japan account for seven percent of PMLCD production. In AMLCDs, one Korean firm has begun volume production, another is in the preliminary stages of production, and a third has invested in a U.S.-based operation. Firms in Taiwan and Europe are also investing in AMLCD production facilities.

To a great extent, the major AMLCD producers have settled on standard display sizes and types. The standard display was the 10.4-inch VGA (video graphics array) in 1994-95, and is now moving toward SVGA (super-VGA) screens larger than 11 inches; 13-inch XGA (extended graphics array) screens have also been developed.<sup>8</sup> One advantage of standard sizes and formats is that they allow manufacturers to produce large quantities of the same item, which is necessary to drive down manufacturing costs. One analyst estimates that 10-inch AMLCD manufacturing costs in Japan have declined from \$2,500 per finished display in 1991 to just over \$1,000 in 1993; during the same period, manufacturing yields—the fraction of acceptable displays produced—have increased from 10 percent to nearly 60 percent.<sup>9</sup>

Increases in production capacity also have created downward pressure on prices as displays become more widely available. One source estimates that Japan's total monthly LCD output increased 62 percent from 1994 to 1995, while the price of a laptop-size AMLCD fell 30 percent from mid 1994 to early 1995.<sup>10</sup> Price decreases in AMLCDs may increase sales in such end-products as portable computers, in which AMLCD screens are the costliest item. AMLCD producers have also felt price pressure from inexpensive PMLCDs, whose quality has improved.

For many computer purchasers, the main decision is between the two types of LCD screens, and is made by weighing display quality against price. Within each type, there are many similarities among the different screens, and there is less differentiation on the basis of brand name than in other components, such as microprocessors. The move toward standardized products and the continuous reduction in prices suggest that, in the large and increasing portable computer market segment, there will be commodity-like product competition based on manufacturing costs. In oth-

<sup>7</sup>Mentley, op. cit., footnote 2; production is measured by location of company headquarters.

<sup>8</sup>VGA is standard for computer displays that is an array of information comprised of 640 rows and 480 columns; the intersection of every row and column represents a pixel. SVGA is an 800- by 600-pixel array, and XGA is 1024 by 768 pixels.

<sup>9</sup>William C. O'Mara, "AMLCD Manufacturing," in *1994 SID International Symposium Seminar Lecture Notes* (Santa Ana, CA: Society for Information Display, 1994), vol. I.

<sup>10</sup>Estimates from Merrill Lynch Japan and *Nihon Keizai Shinbun*, quoted in Hisayuki Mitsusada, "Advanced LCD Makers Look Beyond PCs," *Nikkei Weekly*, Mar. 20, 1995, p. 8.



er parts of the market, applications demand more diversified FPD performance and size, so that design and customization will be as important as manufacturing costs, or perhaps more so.

An analogy can be made to the semiconductor industry: there are custom-designed, application-specific integrated circuit chips (ASICs), mass produced but design-intensive microprocessors, and commodity dynamic random access memory chips (DRAMs). AMLCDS for portable computers appear to be moving toward the commodity end, whereas other types of displays will demand diversified product designs.

There are no production facilities for portable computer displays in the United States. Several fledgling efforts produce, or are preparing to produce, AMLCDS for specialized applications, but the domestic industry is strongest in the smallest market segments—EL and plasma for military, medical, and industrial applications.

DOD has awarded funding to Optical Imaging Systems (OIS) to develop an AMLCD factory in Michigan, which will produce small volumes (relative to commercial-scale plants) of custom displays for military and civil avionics. DOD has also funded a consortium of Xerox, AT&T, and Standish Industries (the leading domestic PMLCD manufacturer) to develop AMLCD manufacturing capabilities; these firms have not announced plans to invest in a central production facility. Kopin has also been supported by DOD (and other government contracts), and has developed the capability to produce small, custom AMLCDS in limited quantities. Two other firms, ImageQuest (majority-owned by Hyundai) and Litton Systems Canada, have built facilities to produce AMLCDS for military use and commercial avionics. The largest display concern involving a U.S. firm is Display Technology, Inc. (DTI), a joint venture between IBM Japan and Toshiba that has built two plants in Japan.

A significant segment of the U.S. industry is pursuing FPD technologies other than AMLCDS. Planar is a world leader in electroluminescent

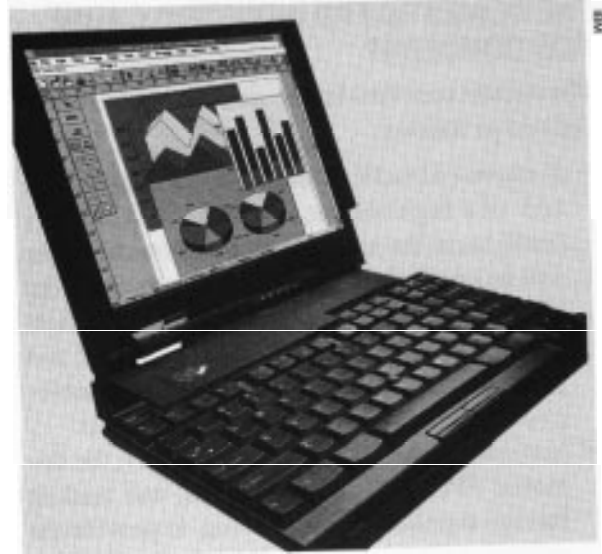

Probably the best known application of flat panel displays (FPDs), portable computers comprise the largest single market for high-resolution color FPDs.

FPDs, with more than half of the market. Photonics Imaging, Plasmaco, and Electro Plasma are competitive in plasma displays (display technologies and U.S. firms are described in appendix A). The U.S. industry has also been a leader in R&D on new types of displays, fueled in large part by the ARPA HDS program. ARPA grants have supported new technologies such as the DMD; ongoing programs support FED research. Both of these technologies have the potential to *leapfrog* the dominant AMLCD by offering superior performance and/or lower manufacturing costs.

The ARPA program has also been successful in funding universities and consortia to train researchers, develop new technologies, and foster the infrastructure needed to support a vibrant domestic industry. The U.S. Display Consortium, funded equally by ARPA and industry (FPD producers, defense contractors, and commercial FPD users), has been a cost-effective tool for infrastructure development, awarding contracts to small FPD equipment and materials suppliers who then create products available to the display manufacturers.

## THE DOMESTIC FPD INDUSTRY: CAUSE FOR CONCERN?

The current concerns for the nation can be broadly defined as follows:

- *Economic Benefit.* Some observers say that the lack of a high-volume domestic FPD industry could harm the nation because domestic firms will be unable to: 1) sell to a large and growing FPD market; 2) compete in product markets that rely on FPDs as a critical component; and 3) benefit from the spillovers of FPD technology to other semiconductor-based products.
- *National Security.* According to DOD, the domestic FPD industry is not able, and leading foreign suppliers are not willing, to provide the military with *early, assured, and affordable access* to leading-edge FPD technology, which DOD asserts is critical to national security.

These concerns can be analyzed separately, but are interrelated because a stronger domestic FPD industry could result in benefits for both military and economic security. DOD frames its FPD policy strictly in military terms, but both concerns are examined here because both have been raised in support of an expanded government role in FPD development.

In the past year, FPDs have attracted attention as a policy issue because of DOD's initiative to create a domestic industry that can satisfy military needs. In 1994, at the conclusion of an interagency task force study on FPDs, DOD determined that it requires early, assured, and affordable access to leading-edge FPD technology of all types, and that it did not have such access.<sup>11</sup> DOD found that even though it had supported FPD R&D for years, domestic companies have not developed capabilities to meet its needs. If the domestic industry remains small, DOD reasoned, firms would be unable to support the level of R&D necessary to keep up with technology developments worldwide; thus, there is no reasonable assurance that a

leading-edge domestic technological capability would be available to the military in the future.<sup>12</sup> Finally, DOD found that the leading sources of FPDs in Japan would not (based on corporate policy) or could not (based on interpretations of Japan's export ban on military items) work with DOD on its specialized requirements.

Because defense demand represents less than one percent of the total FPD market, DOD is pursuing a *dual-use* strategy: attempting to exploit commercial advances in R&D and manufacturing to meet defense needs. Because the technologies used in military displays are the same as those used in commercial products, DOD's approach is to bolster the ability of domestic firms to produce FPDs for both military and commercial markets. DOD then plans to take advantage of the economies of scale provided by the volumes demanded by commercial markets. Called the National Flat Panel Display Initiative (NFPDI), the policy increases funding for FPD manufacturing technologies and promotes insertion of displays into military systems, in addition to continuing an existing R&D program. A fourth part of NFPDI, designed to stimulate domestic and foreign demand for domestic FPDs, has not yet been implemented.

DOD justifies NFPDI solely in national security terms, as the most efficient method for meeting defense FPD needs. DOD states that it is not trying to build a domestic, high-volume commercial industry as an end in itself or to achieve broad economic benefit. However, the dual-use approach requires that a substantial commercial base exist to be integrated with the military base, and the commercial FPD base is currently inadequate. Thus, NFPDI aims to create a domestic base that can satisfy both military and commercial demands. This would likely create economic benefits as well, which could be regarded as spillovers from satisfying the national security goals.

It is possible to evaluate NFPDI as a method for meeting defense needs, and this report does so.

<sup>11</sup> Department of Defense, op. cit., footnote 3, chapter I.

<sup>12</sup> Department of Defense, *Dual Use Technology: A Defense Strategy for Affordable, Leading-Edge Technology*, February 1995, p. 12.

However, because some benefits would accrue to the domestic commercial base from a successful NFPDI, and many observers feel that the development of a high-volume domestic commercial FPD industry is desirable in its own right, these potential benefits should be included in an analysis of the NFPDI approach. Most of DOD's specific requirements for FPDs more closely resemble those for niche commercial market segments (such as civil avionics, industrial, and medical systems) than those for the largest commercial markets (in portable computer and communications systems and consumer electronics items). Thus, even if NFPDI is successful in meeting military needs, it may have limited impact on the largest commercial market segments.

There are also potential developments that could bolster capabilities in the domestic commercial FPD industry, while only indirectly improving the domestic capability to produce FPDs for military needs. An example would be an investment in a domestic FPD plant to produce displays for the portable computer market, the largest single FPD application.<sup>13</sup> Such a factory would likely be similar to current-generation factories in Japan and Korea that produce displays for notebook computers, typically at volumes of approximately one million displays annually.

This type of plant would represent a huge increase in the domestic FPD production capacity, providing a boost to domestic suppliers of materials and equipment. However, it would likely concentrate on producing large volumes of standard displays (e.g., 11-inch-screens with SVGA resolution), and might not have any direct effect on DOD's need for early, assured, and affordable access to leading-edge FPD technology for military systems. The indirect effects could, nonetheless, be substantial. The increased understanding of FPD manufacturing processes acquired at such a plant could benefit other domestic manufacturers, and the added demand for inputs to the FPD

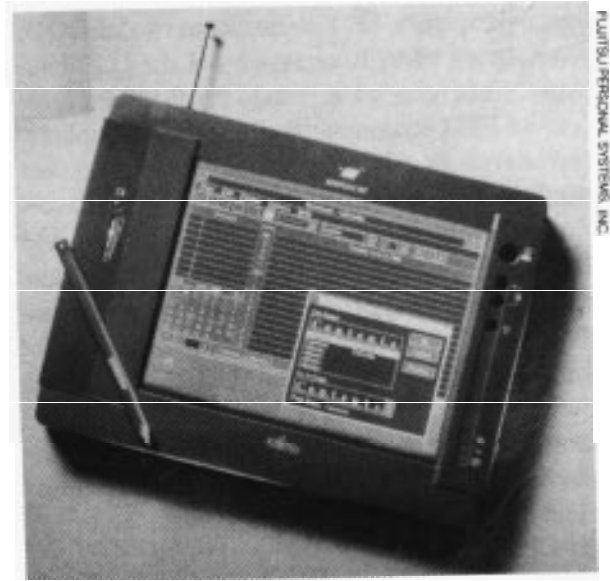

*Liquid crystal displays have enabled the development of handheld computer and communications devices, such as this pen-based computer.*

production process would benefit the domestic infrastructure, contributing to DOD's goal of developing a dual-use industry in the United States.

### ■ Economic Benefit

The economic benefits to the nation of having a high-volume domestic FPD industry present an uncertain picture. The benefits pertain to the FPD industry itself, which has undergone rapid growth in the past few years; U.S.-based users of FPDs, such as computer companies; and related industries, like semiconductor devices.

It is not clear how important these benefits are to downstream producers and related industries. They have not yet been great enough to induce firms such as computer or semiconductor manufacturers to make the investments necessary to create a high-volume, commercially oriented domestic FPD industry. However, some downstream firms have made some moves in that direc-

<sup>13</sup> To date, there has been no U.S.-based production of such FPDs. Sharp Corp. performs final assembly of portable computer screens at its wholly owned U.S. affiliate in Camas, Washington.

## 12 | Flat Panel Displays in Perspective

tion. Along with FPD manufacturers and DOD, downstream users have supported the U.S. Display Consortium, which funds development projects by FPD equipment and materials suppliers, and serves as a forum for communicating user needs to FPD manufacturers.

Some downstream firms, such as Compaq and Hewlett Packard, have also formed partnerships with nascent FPD producers, some of whom believe that DOD's support has created the climate for these investments. Finally, IBM has joined with Toshiba to create DTI, now one of the world's largest display-making operations. But DTI is located in Japan, and no firm has made the commitment to find a high-volume FPD plant located in the United States.

### **The FPD Industry**

The industry is currently valued at \$11.5 billion, and most forecasts put it at \$20 billion to \$40 billion by the year 2000. Having a substantial portion of that industry in the United States could provide high-value jobs. However, profitability may vary across the industry. The AMLCD industry structure has become less concentrated recently as more than 10 Japanese firms, three Korean firms, two Taiwanese firms, and one European firm have built, or are building, high-volume production facilities. If the pattern in other high-volume electronics industries is repeated here, entry by Korean and Taiwanese firms will drive down prices.

While product diversification exists in much of the FPD industry, AMLCDs for portable computers—a large part of the FPDs produced—are moving toward commodity goods; that is, products with similar core features that are produced by multiple sources and compete on the basis of price, rather than any distinguishing characteris-

tics. Commodities tend to command low profit margins unless the production capacity is insufficient to meet demand.

A recent report by a Japanese investment firm states that a typical firm that began production in 1992 did not reach profitability until 1994, is likely to show zero profits throughout the second half of 1995, and will return small profits in 1996 and 1997.<sup>14</sup> Although AMLCD manufacturers had been unable to keep up with demand during the early 1990s, the huge level of investment in AMLCD production in Japan and Korea appears to be more than sufficient to meet worldwide demand.<sup>15</sup>

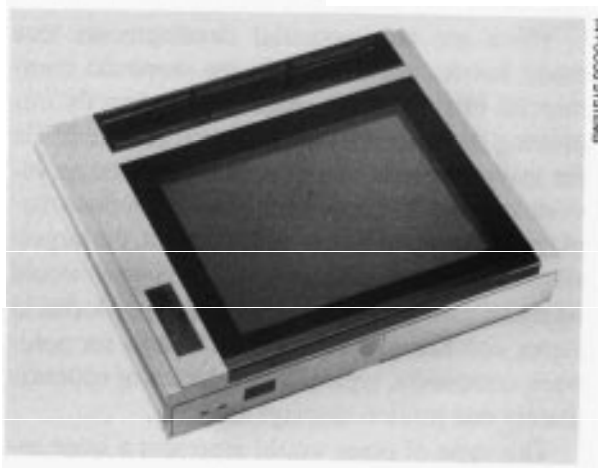

*Liquid crystal display projection panels can be used with overhead projectors to present high resolution computer graphics and video in group settings.*

However, other commercial market segments—such as commercial avionics and automotive displays—will involve specialized products, produced in lower quantities, that will probably command relatively high profit margins based on their particular features. FPD applications are quite diverse and have different demands

<sup>14</sup> Hideki Wakabayashi, "Is Confidence in the Growth Potential of the LCD Panel Market About to Collapse?" Nomura Research Institute, Tokyo, Japan, May 25, 1995.

<sup>15</sup> One market analyst has documented that announced capacity to produce portable computer screens is five times the demand for screens, although announced capacity is greater than actual capacity, which in turn is greater than actual output. See David Mentley, "The Notebook Computer Market and Display Manufacturing Capacity," *SEMI International Display Report*, vol. 4, No. 4, May 16, 1995.

with regard to display size, shape, resolution, power consumption, brightness, color, speed of switching, interface to other components, and tolerance of environmental stresses, such as sunlight readability, physical impact, acceleration, temperature, and electromagnetic energy.

These niche segments are likely to be more attractive to U.S. firms for two reasons: 1) the profits will likely be higher than for standardized displays, and 2) U.S. firms tend to compete better on the basis of improving product features than on the basis of cutting manufacturing costs. However, these markets will not be ceded to U.S. firms; some Japanese and Korean LCD producers are moving into this market to diversify their commercial markets, and firms such as Hosiden and Sextant Avionique are already established producers.

### ***Downstream Industries***

The commercial benefit of having a high-volume domestic FPD industry would extend beyond the FPD industry itself to include downstream U.S. industries such as computers, communications equipment, and consumer products. Often the display is the component that differentiates the downstream product; in such cases, it is important for the downstream firm to be able to purchase the best FPDs available. However, because many Japanese FPD producers are vertically integrated electronics companies, their first priority could be to supply displays needed for the firm's own end-products. As a result, the U.S. firms that make competing end-products might have to wait longer for the latest displays. Currently, large U.S. FPD purchasers can negotiate early access because of their buying power; however, this may not be the case for firms that require smaller volumes or more specialized products. A strong U.S. FPD industry would make downstream U.S. firms much less dependent on Japanese FPD producers.

However, even in the absence of a strong U.S. industry, the competition among FPD producers in Japan means that many producers want outside customers to provide assured orders for their products. Also, the entry of new FPD producers based

in Japan, Korea, Taiwan, and Europe will give U.S. display users more options, though many of these new producers are also integrated electronics firms that could give priority to in-house needs.

Access to the best off-the-shelf FPDs is not always enough. Sometimes U.S. end-product producers need displays customized to their specifications. The best product design might require, for example, a different size display, a new way of fitting the display into the product housing, or a special electronic interface between the display and other components. Here, too, Japanese dominance of the FPD industry could pose difficulties for U.S. firms. In many cases, Japanese FPD producers have not been interested in customizing displays to U.S. customers' specifications, particularly for small numbers of displays. This may change, however, as announced capacity increases are realized.

In addition, U.S. customers may hesitate to share sensitive product development information with Japanese display producers who might use that information to produce competing products. The often-cited example of this problem is Sharp Corp.'s Wizard personal digital assistant that Sharp introduced soon after the Apple Newton, which was produced by Sharp for Apple. Computer companies typically protect their designs by using rigorous nondisclosure agreements with their FPD suppliers. These agreements are designed to limit the flow of design information to competitors, including those within the same corporate group as the display manufacturer. This seems to provide a good deal of protection, but the possibility of integrating other functions onto the display (see below) heightens concerns among some of these companies. The appearance of new FPD suppliers will ease these concerns somewhat by giving U.S. firms more choices, though new suppliers could also limit supply or compromise designs.

The only domestic downstream firm that has moved to gain direct control over FPD production is IBM, whose Japanese subsidiary is a joint owner of DTI, a leading FPD manufacturer located in

## 14 | Flat Panel Displays in Perspective

Japan. This approach allows IBM some vertical integration of FPD production and computer manufacturing, but it has to cooperate in display design and production with its co-owner, Toshiba, a competitor in portable computers.

### *Integration*

A technical trend that involves building electronic components on the display itself could have serious implications for the end-users of displays in the future. By integrating some of an end product's nondisplay functions into the design and manufacture of the FPD, there may be savings in weight, power, number of components, and system costs. Such integration would add value to the display, and would likely shift profits from the end-product manufacturer to the FPD manufacturer. Integration would also lead to increased control over the system design and functionality by the FPD manufacturer, which would increase end-product producers' concerns about access to needed displays and control over product development.

There is a spectrum of integration possibilities, from a bare display to a computer on a display. The current level of integration in computer screens involves mounting on the display only the circuits that directly drive the display elements, along with a few associated integrated circuits. The level of integration could increase through advances in chip packaging and mounting, further development of emissive displays (in which electronics can be mounted on the back of the display without obstructing the light source), or advances in depositing semiconductor circuits onto display glass. Some experts predict that the next level of integration will include the set of chips that define the images to be displayed. The ability to integrate extensive circuits, such as memory or microprocessor functions, is much further off, and the reasons for doing so are not yet clear.

### *Spill over to Related Industries*

Another commercial benefit would be the spillover of manufacturing technology into the semiconductor industry. Production of semiconductor

chips and FPDs shares some materials, equipment, and processing techniques. Therefore, a high-volume domestic FPD industry could strengthen the base of materials and equipment suppliers for the semiconductor industry, and develop process expertise that can help semiconductor producers.

The spillover is most prevalent in the equipment and materials inputs. FPD manufacturing equipment leads some sectors of the semiconductor industry because it is designed to handle large substrates and minimize contamination over large areas during manufacturing. In the actual manufacturing process, differences in required linewidths, substrate size, output per substrate, and cost of materials limit spillover.

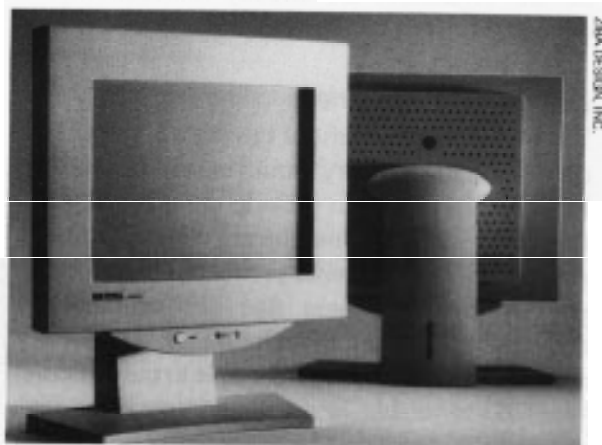

*Flat panel display desktop computer monitor offer compact design and low power consumption compared with cathode ray tube (CRT) monitors.*

Because the semiconductor industry is likely to remain much larger than the FPD industry, it could provide a strong incentive for the development of needed material and equipment inputs, even in the absence of a domestic FPD industry. However, for some equipment and materials suppliers, a high-volume FPD industry would probably represent a large portion of their business.

### ■ National Security

While FPDs are increasingly important to the information-driven military, the low volumes and nonstandard requirements of military FPDs make

defense contracts unattractive to many commercially oriented FPD producers. DOD's goal is to guarantee early, assured, and affordable access to FPD technology so it can design leading-edge technology into military systems. DOD states that investigations of Japanese display suppliers revealed that these firms will not provide it with early and assured access to leading-edge FPD technology. DOD also states that it cannot afford to purchase displays from a small, specialized domestic industry. Such an industry will have high unit costs and will require large R&D subsidies to keep up with the much larger commercial industry (and even then will likely lag behind commercial technologies).

However, the picture is not entirely clear. The military has a variety of FPD needs; some can be met by commercial displays, and others require custom-designed FPDs. DOD can use three complementary strategies to gain secure access to FPD technology and systems: 1) foreign FPD firms, 2) U.S. niche FPD firms serving defense and commercial needs, and 3) a possible future high-volume, commercially oriented U.S. FPD industry. The need for developing the third source depends on the adequacy of the first two, what the third would add, and what it would cost.

### ***Foreign Access***

In preparing its report on FPDs during 1993-94, DOD mainly investigated and/or held discussions with four firms based in Japan—Sharp, NEC, DTI, and Hosiden—that accounted for more than 90 percent of AMLCD sales in 1993.<sup>16</sup> DOD found that NEC and DTI were captive producers, not selling displays on the open market; and Hosiden was judged to be in a precarious financial state. Sharp, the leading FPD manufacturer, stated unequivocally that it would not directly supply

DOD with displays and would not make customized FPDs for DOD's use. Its stated reason was that, as a matter of corporate policy, it is a consumer firm and will not sell directly for military uses (some Japanese firms fear that selling in the military market will besmirch their reputation with Japanese consumers). Sharp may, in part, be concerned that Japanese export control laws could be interpreted to restrict selling even standard commercial displays to foreign defense forces.

There is also a fundamental business reason for Sharp's refusal. The small volumes, detailed specifications, and intrusive verification procedures demanded by military procurement are not attractive to a high-volume FPD producer. Such a company must concentrate on increasing the throughput and yield of existing product lines. Responding to detailed specifications for a few thousand displays is not justifiable for an operation that produces millions of displays per year. Such production economics will influence decisions regardless of location or ownership of the facility.

However, Sharp and other Japanese firms do supply off-the-shelf displays to DOD's contractors, who then customize the displays for military use. OTA interviews with these contractors have not revealed problems with timely supply of FPD technology; however, potential problems exist in adapting system designs to changes in FPD designs and ensuring an adequate supply of replacement displays after the systems are fielded and the original design is no longer manufactured. Also, while Sharp continues to be the leading AMLCD manufacturer, its share of Japanese LCD production has fallen recently. Sharp's share of Japanese AMLCD production fell from 42 percent in 1993 to 36 percent in 1994; during the same period, its share of PMLCD production fell from 24 to 20 percent.<sup>17</sup>

<sup>16</sup> DOD points out that it is continuously monitoring developments in Asia and is holding follow-on discussions with FPD producers. Richard Van Atta, Special Assistant, Office of Dual Use Technology Policy and International Programs, U.S. Department of Defense, personal communication, June 7, 1995.

<sup>17</sup> Market shares calculated from "Scale of Liquid Crystal Industry Assessed," op. cit., footnote 2, chart 2 for firms' production estimates, and figure 1 for estimates of total production; years cited are Japanese fiscal years, which begin on April 1.



*Flat panel displays present video and flight instrumentation data in cockpit avionics using a fraction of the space and weight of cathode ray tubes and electromechanical displays.*

There are numerous other suppliers in Japan, one established supplier in Korea, and a few other Korean, European, and Taiwanese firms now investing in AMLCD production. There is a possibility that ongoing production investments will result in large amounts of oversupply in the AMLCD market, which could give DOD's contractors more leverage over suppliers. The increasing application of AMLCDs to commercial avionics and automotive systems may also increase the availability of FPDs suitable for military systems.

Currently, commercial off-the-shelf displays are available to domestic integrators for as little as one-third the cost of comparable custom-made military displays.<sup>18</sup> Thus, foreign display producers are, and could continue to be, a promising source of low-cost displays for some of DOD's needs. The U.S. government could take measures

to enhance this source, for example, by seeking clarification of Japanese laws regarding export of dual-use products. It could also encourage Asian producers to invest in manufacturing sites in the United States. However, relying on foreign sources for certain types of FPDs could conceivably put the military in a vulnerable position, susceptible to interruptions of supply and to manufacturers not always willing to provide DOD with early and assured access to FPD technology.

### ***Niche Producers***

DOD could continue to build and sustain an FPD industry that concentrates on low-volume military and commercial applications. Because military needs are projected to remain small in volume for the next 15 years (in the low tens of thousands annually through the year 2009), those needs could be filled largely by a small domestic industry that would also concentrate on applications with similar requirements, such as commercial avionics. As in the previous approach, military demands would be met by off-the-shelf items wherever possible, and by custom production in selected critical applications. U.S. firms are relatively strong in niche technologies and applications, such as EL, plasma, and custom AMLCD displays for military, industrial, and medical applications. This is, to a large degree, the result of several years of investments by ARPA's HDS program. These technologies and applications are somewhat distinct from mainstream AMLCD application areas such as portable computers.

DOD has concluded that the small domestic capacity is not suitable for filling defense needs, and present trends will not lead to this capacity. In addition, DOD states that buying from low-volume domestic producers would mean high per-unit costs.<sup>19</sup> Another concern is that the industry's relatively small revenues could fund only limited

<sup>18</sup> OTA estimates based on interviews with military program offices.

<sup>19</sup> DOD estimates that the cost per unit for a small-scale defense unique producer is 100 times that of a larger, dual-use plant. Kenneth Flamm, Principal Deputy Assistant Secretary (Economic Security) and Special Assistant (Dual Use Technology Policy), U.S. Department of Defense, OTA briefing, May 18, 1995.



R&D, making it difficult to keep up with the much larger global industry in product development and manufacturing, and denying military planners the ability to utilize leading-edge display technologies. DOD argues that it would need to continually pump in massive amounts of R&D support to help the U.S. industry keep up and, even then, the U.S. industry would likely fall behind. The department has concluded that both high unit costs and the requirement for R&D subsidies would lead to high total costs to DOD for a domestic industry dependent on niche markets.

However, there are other possible outcomes. During fiscal years 1991-95, relatively modest R&D support (on average \$117 million per year from DOD and another \$10 million per year from other government agencies) has made the U.S. industry substantially better able to meet defense needs. For example, in AMLCDs, OIS has completed a pilot plant and Xerox and Planar have joined together to produce military displays. Litton Systems Canada and ImageQuest have also built low-volume AMLCD production facilities, and plan to compete in the military market.

DOD could also help the U.S. industry tap into developments abroad. As the Japanese have shown in many industries, following the technological leader closely need not cost nearly as much as blazing the technological trail. Being a follower might cause concerns for DOD's access to leading-edge displays. However, because the development cycle for military systems is several times longer than for commercial FPDs, any technology lags would likely be overshadowed by the development time of the system of which the FPD is a part. Nevertheless, it could be argued that the long development time increases the need for early access to display technology by military systems integrators. To address time lags, DOD is moving to accelerate the insertion of FPD technology into existing and planned military systems.

Another area in which the domestic FPD industry could take advantage of foreign investments is in manufacturing technology. Much manufacturing technology is embodied in materials and equipment used to manufacture FPDs, and the availability of this equipment outside of Japan has

allowed the development of FPD plants in Korea and Taiwan. It is reasonable to assume that Japanese equipment and materials suppliers would also sell to U.S. FPD manufacturers. However, as with finished displays, foreign materials and equipment suppliers might not always supply U.S. FPD firms in a timely manner. Also, tariffs on input materials, which are often higher than for finished displays, can put U.S. manufacturers at a disadvantage. Rationalizing the tariff structure could help domestic producers.

The lack of a high-volume U.S. FPD industry could cause the U.S. supply base for FPD materials and equipment to deteriorate, increasing U.S. dependence on foreign suppliers. Several U.S. firms have developed key inputs to the FPD production process, including Corning's glass substrate, Texas Instruments' driver chips, and MRS Technology's panel printer equipment. These firms are forced to concentrate their business—and in some cases production—in Japan where the bulk of FPD manufacturing occurs. They could be reliable domestic sources; some U.S. production facilities (including OIS and ImageQuest) have been equipped with mostly U.S.-made inputs.

### ***High-Volume Domestic Dual-Use Industry***

The U.S. FPD industry has less than three percent of the world market. Therefore, the domestic industry can fund only a small fraction of the world's R&D on FPDs, and could thus have trouble keeping up with the latest technology. DOD seeks to substantially increase the market share of domestic producers, which would greatly increase its ability to stay at the leading edge. Given the small military demand, a larger U.S. industry would have to serve primarily commercial markets.

However, to create a high-volume commercial FPD industry requires large investments. The capital investments in a world-class FPD manufacturing facility (close to half a billion dollars in capital costs for AMLCDs, less for other technologies) must be followed by a period during which an unknown investment of time and money must be made to develop a reliable manufacturing process. Because U.S. firms have not indicated a will-

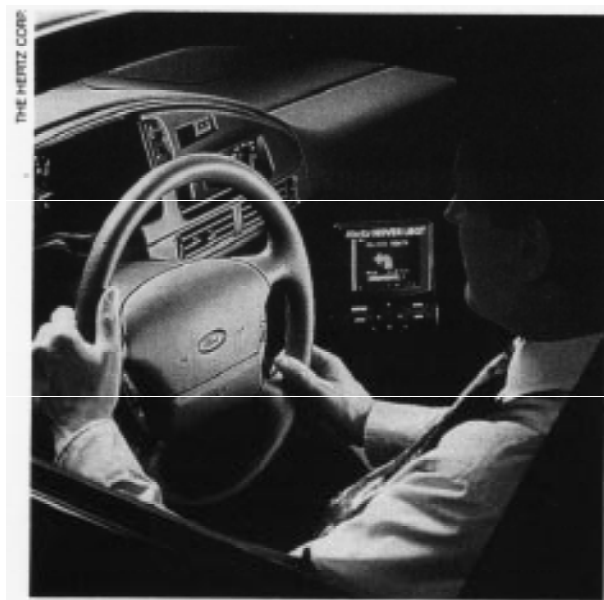

*Compact flat panel displays enable the use of global positioning system (GPS) data and electronic maps to help drivers find their way*

ingness to make such investments, the dual-use approach will likely require substantial government investment.

There is some tension between achieving a large U.S. industry and making that industry relevant to DOD's needs. The requirements of the largest applications-AMLCDs for portable computers and consumer electronics-are different from many military applications. Because much of the competition in FPDs is based on high-volume manufacturing, R&D done for these applications might not have great relevance to what DOD requires. Smaller commercial market segments, such as commercial avionics, more closely match military applications.

Also, it is not clear how much a large U.S. industry would reduce unit costs for custom military displays. A large commercial plant would likely produce displays for portable computers, which require large runs to increase production yield. Once volume commercial production had begun, it is likely that DOD would still face the problem of requiring small volumes of product whose specifications are different from most commercial products, requiring separate production runs or

separate lines. Although domestic manufacturers may be more willing than foreign firms to adapt commercial lines to fulfill such needs, the added cost due to tailored production would still result in military displays with relatively high unit costs.

## **STRATEGIES AND POLICIES FOR A DOMESTIC FPD INDUSTRY**

The second issue addressed by this report is an analysis of policies for fostering a high-volume domestic FPD industry. The discussion of military and economic benefits identified reasons why government has some interest in developing such an industry in the United States. In order to analyze existing or proposed policies seeking to address the weak state of the U.S. FPD sector, it is helpful to review the history of both private efforts to commercialize FPD technology, and government programs to support generic FPD R&D and product development for military requirements.

This examination reveals limitations to government influence in developing a high-volume FPD industry because: 1) U.S. firms have historically chosen not to enter into FPD production, and 2) the government's display requirements (to date, largely for military purposes) are small and somewhat different from mainstream commercial products. Nevertheless, government support has sustained the industry through difficult times, and could provide some incentives for broadening the current production base.

DOD's current policy, the National Flat Panel Display Initiative (NFPDI), has set a goal of securing early, assured, and affordable access to leading-edge FPD technology. DOD's plan for attaining this goal is to invest in dual-use FPD technologies, and to induce industry to invest in high-volume production capacity. However, DOD's goal could potentially be reached by taking advantage of existing commercial FPD sources (which are largely foreign) and custom military FPD capabilities in the United States.

### **I Commercialization History**

The majority of key FPD innovations were made in the United States. Demonstrations of the first

liquid crystal, active matrix, plasma, and electroluminescent displays were all made by the end of the 1970s at U.S. laboratories, often within large electronics corporations. None of these companies seriously tried to commercialize FPD technology; several Japanese firms did. The history goes through three time periods.

In the 1970s, as simple devices that could display text and numbers became available, many firms viewed FPDs as suitable mainly for low-cost, low-information-content displays for products such as watches and calculators—consumer markets that many U.S. firms were exiting at the time. Some firms decided that displays were important to their business, but opted to stay with the mature cathode ray tube or to adopt light-emitting diodes (which were initially competitive with LCDs, but were inferior for color or graphic displays). By the end of the decade, as FPD innovators such as Westinghouse and RCA were exiting consumer electronics altogether, they either closed down or sold off their FPD efforts. As these firms discontinued support for FPD research, a new group of startup FPD firms was formed.

In contrast, Japanese electronics firms were very interested in the watch and portable calculator markets, and developed LCDs as a way of differentiating their products. The first firm, Sharp Corp., took notice of the work in American laboratories and began its own research in 1973.

During the 1980s, U.S. startup firms ran up against an increasingly large development effort among Japanese firms that were moving from simple to complex FPDs. By the mid-1980s, several Japanese firms had developed portable television products using AMLCD screens. Aided by some government programs, low capital costs relative to the United States, and large amounts of internal capital, Japanese firms began to make investments in LCD production plants by the end of the decade. The small U.S. firms were able to secure startup and R&D funding, but very few were able to raise enough money to build the facilities required for FPD manufacturing. By the end of the decade, many of the nascent U.S. efforts had failed.

In the 1990s, earlier Japanese investments have resulted in the capacity to produce sophisticated FPDs for consumer markets, and the pace of investment has increased. Announced investments made by several firms are approximately \$400 million for each state-of-the-art AMLCD manufacturing line; some of the firms have built several lines. In this key FPD technology, Japanese firms have developed an impressive store of manufacturing expertise, the result of billions of dollars in manufacturing investments and several generations of display production.

The level of manufacturing sophistication, as well as the sheer volume of production capacity installed and announced in Japan, has created the latest barrier to volume production of FPDs in the United States. U.S. investments made during the last few years, primarily by DOD and other government agencies, have sustained the domestic R&D effort, and several promising technologies have been identified and, in some cases, taken to the prototype stage. But private sector commitments to large-scale production of FPDs have not yet materialized.

## ■ Strategies for Market Entry

There are several ways to develop a high-volume domestic FPD industry. The first is to increase the size of existing niche markets. By developing new product types and applications, the market share held by U.S. firms in LCD (including custom AMLCD), EL, and plasma technologies could be increased, even as the size of the overall market grows. The advantages of such an approach are: 1) it builds on existing strengths of the domestic industry, 2) it develops capabilities in technologies of use to military systems, 3) it does not require fundamental breakthroughs in technology, and 4) the minimum efficient scale for such an FPD plant is not large as in AMLCD plants for computer/consumer markets. This strategy is limited by projections that call for market shares of FPDs other than active matrix LCDs to diminish to a third of the market by the end of the decade; market shares of plasma and EL are projected to remain at a few

## 20 | Flat Panel Displays in Perspective

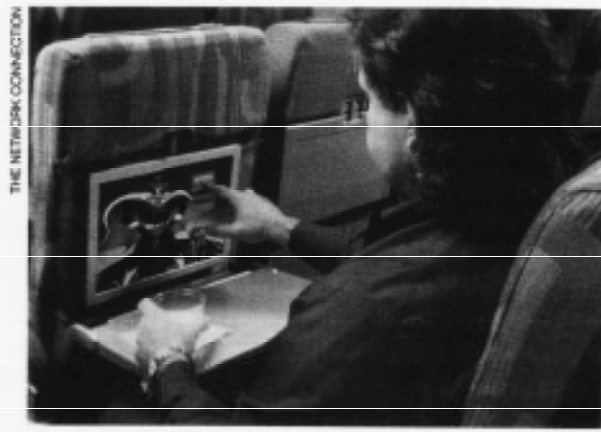

Flat panel displays in aircraft seat backs allow passengers to individually select information and entertainment choices.

percent. However, advances in HDTV could lead to a large demand for large-screen monitors, an application that some have advocated will be best filled by plasma displays.

Another approach would be to enter into high-volume production for the largest and fastest growing market segment—AMLCDs for computer and consumer goods. This would require large investments in the type of manufacturing technology used by East Asian companies in several large AMLCD plants, and would involve catching up to the market leaders by gaining experience in mass manufacturing. While it may be the only way to capture a large portion of the FPD market over the next several years, it would require a series of plant investments in the half-billion-dollar range, along with a variable amount of investment during the startup period at each facility. While such an approach would satisfy some of DOD's FPD needs, modification of many of the displays would still be required, and not all of DOD's requirements can be met by AMLCDs.

A final approach would be to exploit a *leapfrog* display technology that could either displace AMLCDs as the market leader or create significant new market niches. Ideally, such a technology would offer both relatively low manufacturing

costs and performance not offered by existing display technologies. Many analysts have suggested that field emission displays (FEDs) have the potential for unseating AMLCDs in the largest market segments. Several U.S. firms are at the forefront of FED research, but the performance and manufacturing costs of standard devices have yet to be determined. Another potential leapfrog device is the digital micromirror display (DMD), which could provide large-screen performance superior to any known FPD. However, the DMD is only suitable for projection display systems, and is not a candidate for direct-view or portable devices.

### ■ Government Activity

Government activity in the FPD industry has taken two principal forms: 1) R&D support for development of military and generic commercial FPD technologies, and 2) enforcement of U.S. antidumping laws. The support has largely come from DOD research grants and cost-shared manufacturing development contracts. The FPD antidumping case during 1990-93 served mainly to alienate FPD producers from end-users and to separate producers' interests by FPD technology, rather than providing an incentive for domestic production,

Government funding for FPD R&D has averaged more than \$100 million per year from 1991 to 1995. Most of this was through ARPA's HDS program, an outgrowth of the concerns in the late 1980s that the United States should have a domestic HDTV industry.<sup>20</sup> The ARPA HDS program has made progress in developing an infrastructure for FPD development by supporting equipment and materials vendors through efforts such as the U.S. Display Consortium and the Phosphor Technology Center of Excellence. It has also made grants-matched by private sector recipients—to build pilot facilities (called manufacturing testbeds) for domestic FPD manufacturing.

<sup>20</sup>See U.S. Congress, Office of Technology Assessment *The BigPicture:HDTV and High Resolution Systems*, OTA-BP-CIT-64 (Washington, DC: U.S. Government Printing Office, June 1990).

Smaller efforts have been funded by the National Institute of Standards and Technology in the Department of Commerce, under its Advanced Technology Program, for development of generic FPD manufacturing technologies. The Department of Energy's national laboratories have also funded FPD development work, and carry out a DOD-funded FPD manufacturing program in the National Center for Advanced Information Components Manufacturing. Basic research in FPD technology has been supported by the National Science Foundation, and NASA has funded the insertion of FPDs into its systems, most notably the Space Shuttle.

The experience of the FPD antidumping case demonstrated the limited utility of trade laws as a tool to foster a domestic industry. First, there were legal issues, such as the definition of the FPD industry, that were not addressed by the government in a coordinated manner. Second, there were limitations—such as application of the antidumping duty to FPDs only, and not to end-products containing FPDs—that made the antidumping duties less effective. Most importantly, the antidumping laws are not well suited to address the lack of a high-volume domestic FPD industry, something that was determined more by investment choices of U.S. firms than the pricing practices of Japanese firms.

### ■ The National Flat Panel Display Initiative (NFPDI)

DOD developed NFPDI because it concluded that maintaining the status quo of R&D and (since 1993) manufacturing testbed funding would not lead to the development of a domestic capability to guarantee early, assured, and affordable access to leading-edge FPD technology, and that foreign firms were not willing or able to offer such access. DOD believes that by investing in NFPDI now, it can provide incentives to the private sector to make the large investments required for high-volume commercial production, leading to a self-sustaining domestic industry that will allow the

military to buy cheaper FPDs in the future. DOD's target is for U.S. production of FPDs to comprise 15 percent of the global FPD market by the year 2000, from less than three percent in 1994.

NFPDI uses some of each of the strategies identified earlier: foreign access, niche markets, and developing higher volume production. DOD states that it will continue discussions with foreign producers over access to FPD technologies, and that the NFPDI grants are open to foreign-owned firms that commit to U.S. production. Other aspects of NFPDI continue previous programs that emphasize specialized defense needs, such as continued support of AMLCD manufacturing testbeds at OIS and at Xerox/AT&T/Standish, and the ARPA HDS core R&D program. However, the thrust—providing incentives for domestic commercial and military production—is to encourage higher volume, commercially oriented production. NFPDI is best understood as an umbrella program that includes the preexisting core R&D and manufacturing testbed programs funded through ARPA and two new elements:

1. a series of competitions that award R&D incentives to firms willing to commit to domestic production, and
2. purchase incentives for the armed services to insert FPDs into existing and future military systems.

The R&D incentives program has so far committed \$48 million overall to three teams that have presented the most credible business plans for moving from prototype versions of FPDs to domestic volume production. The incentives are in the form of government-funded R&D, matched by the firms, to be used on significant process or product technology improvements. In order to receive an incentive, a firm must have made a credible demonstration of its technological capabilities and have devised clear and feasible plans for moving the technology into military applications. In addition to matching the R&D funds from DOD, the firms are required to make a commitment to investing at least three times the



Medical, industrial, and transportation systems require the display of bright, sharp images in a rugged package, such as this electroluminescent display

amount of the R&D incentive in production plant and equipment.<sup>21</sup>

The purchase incentives are through the Defense Production Act's Title III program, and provide support to military system program offices in return for adoption, or acceleration of adoption, of domestically produced FPD technology. To date, the Title III program has funded AMLCD technology exclusively, partly through supporting the Xerox/AT&T/Standish manufacturing testbed and partly through incentives to military programs that use AMLCDs. Rationalization of purchases by the entire executive branch, although suggested by DOD, has not gone forward.

There are several concerns regarding DOD's approach. First, while NFPDI may assist in the creation of domestic FPD plants, the special nature of military displays will still raise the cost relative to commercial FPDs. Many of the specific attributes of military displays are in packaging, which requires external modifications to the raw display, and in the specific sizes or shapes required by military systems. Some types of military displays, such as head-mounted systems, have little commercial demand.

Second, it is not clear that the NFPDI funding level, timing, and point of application will result in a successful program. DOD has estimated that a 15-percent global market share by U.S. firms (up from less than 3 percent in 1994) would result in a sustainable domestic industry. This market share would have required approximately \$1.2 billion in sales by U.S. firms in 1994; the actual industry sales were less than \$200 million.<sup>22</sup> Projections for the year 2000 (DOD's target date for 15-percent market penetration), using growth trends in current applications only, are for global FPD sales of \$20 billion; more optimistic predictions that take into account predictions of new display applications go as high as \$40 billion. Thus, to reach DOD's target, domestic sales must reach \$3 billion to \$6 billion by 2000. Stanford Resources, Inc., has estimated the investment-to-revenue ratio for an AMLCD plant to be 1-to-1; by this estimate, \$3 billion to \$6 billion would be required in total investments in the next few years.<sup>23</sup>

DOD's program plan is to award less than \$200 million in R&D incentives, which require cost-sharing, to firms with credible plans for commer-

<sup>21</sup> Mark Hartney, Program Manager, ARPA/ESTOq, U.S. Department of Defense, personal communication, June 7, 1995; Richard Van Atta, Special Assistant, Office of Dual Use Technology Policy and International Programs, U.S. Department of Defense, personal communication, Aug. 2, 1995.

<sup>22</sup> Stanford Resources, Inc., estimates that the value of North American FPD production was \$197 million in 1994, out of a world market of \$8.2 billion; George Aboud, Stanford Resources, Inc., San Jose, CA, personal communication, June 12, 1995.

<sup>23</sup> This estimate is for AMLCD plants, and only covers the physical plant and equipment expenditures; it does not consider additional investment required during the startup period. Other types of plants may require less investment; for instance, field emission display developers anticipate that capital expenditures could be more than \$100 million less than AMLCD plants. The investment to revenue ratio for such a plant is uncertain at this time.

cial production using current generation technology. The cost-sharing will result in \$400 million in R&D spending, shared equally by DOD and firms. In addition, DOD requires that \$600 million (three times the DOD grants) in plant and equipment investments be committed by the firms. Thus, DOD anticipates at least \$1 billion in direct investment to result from NFPDI, which is one-third to one-sixth of the amount required to reach the target market share.

However, DOD makes two further assumptions. First, it estimates that the program will stimulate an additional \$600 million to \$1.4 billion in private sector investment in FPD manufacturing facilities. This additional investment would increase the total to a range of \$1.6 billion to \$2.4 billion. Second, DOD argues that, given an improved understanding of AMLCD manufacturing and the potential for lower cost approaches to FPD manufacturing, a more appropriate investment-to-revenue ratio would be in the range of 0.5-to-1 to 0.8-to-1.<sup>24</sup> If the investment-to-revenue ratio is relaxed by one-third, to 0.67-to-1, reaching 15 percent market share would require \$2 billion to \$4 billion in investments. With these two assumptions, the potential investment range straddles the low end of estimated requirements.

As foreign experience has shown, it takes several years of construction and trial manufacturing runs to bring a facility up to efficient, high-volume production. However, the construction of such plants has not yet begun in the United States. This also lowers the probability of developing a domestic industry with 15 percent of global FPD sales by the year 2000. DOD's plans for reaching this goal may need to be modified, or the goal may need to be changed. It will be important to monitor the progress of the first three recipients of the NFPDI R&D incentives toward high-volume pro-

duction; to date, none has announced plans for high-volume production.

Finally, the NFPDI funds that are directly aimed at providing incentives for production are primarily for next-generation products. However, discussions with industry indicate that funds for improving the current manufacturing process would probably be a more effective incentive.<sup>25</sup>

The goals for NFPDI could be realigned to be more realistic, while at the same time serving DOD's needs. By emphasizing technologies other than AMLCD, DOD could build on a solid foundation in EL and plasma production and in development of leapfrog technologies. Under this approach, DOD could try to increase the production volumes for non-AMLCD displays. For AMLCDs, DOD could rely on low-cost foreign suppliers for most applications and high-cost, domestic sources for custom applications. DOD may already be moving in this direction: although the manufacturing testbed awards made in 1993 and 1994 use AMLCD technology, the three NFPDI awards announced last fall went to EL and FED proposals. At the same time, if AMLCDs increase in market share as projected, it will be very difficult to capture an appreciable part of the overall FPD market without high-volume AMLCD plants.

In seeking to strengthen NFPDI, Congress could consider the following policy options:

- DOD could pursue relationships with foreign suppliers more seriously, including the possibility of U.S.-based production. One possibility for U.S. manufacturing is to transfer technology from Display Technology, Inc., via its American parent, IBM. Another possibility would be for Sharp Corp. to invest in AMLCD production at its plant in Camas, Washington,

<sup>24</sup> Flamm, *op. cit.*, footnote 19.

<sup>25</sup> DOD notes that there is not always a sharp distinction between current and next-generation production technology. Hartney, *op. cit.*, footnote 21.

where it currently performs final assembly of FPDs. The government could provide incentives for such technology transfers.

- The U.S. government could negotiate with the Japanese government to clarify Japan's export control laws for dual-use technology.
- The R&D incentive awards (which support next-generation R&D as an incentive to high-volume domestic manufacturing) could be replaced by either support for current-generation manufacturing technology development or guaranteed purchases (see below).
- The government could guarantee FPD purchases of certain quantities at certain prices. Such guarantees could encourage private equity investment and might allow firms to get bank loans. However, because U.S. military needs will only represent a few percent of the world

FPD market, guarantees of such purchases by themselves cannot induce investment sufficient to capture a substantial share of the world market. U.S. government civilian needs for flat panel displays or products incorporating them (e.g., computers) represent additional market share, but guaranteeing that business to U.S. FPD makers would likely run afoul of international trade rules.

- Congress could work with the Administration to broaden the DPA's Title III program to include technologies other than AMLCDs. This would give military planners more flexibility in choosing FPD technologies, and would support growth of niche markets in established technologies and, potentially, leapfrog approaches to FPDs.



# The Domestic Flat Panel Display Industry: Cause for Concern? 2

The lack of a strong domestic flat panel display (FPD) industry has led to two areas of concern for the nation: loss of economic benefits and threats to national security. This chapter examines the benefits that could accrue to the nation if a domestic high-volume FPD industry were developed. The economic benefits (or potential losses if such an industry is not developed) could come in three forms:

1. *Profits that could accrue to manufacturers.* Manufacturing displays for a large and rapidly growing market could be the source of profits and jobs for American companies and workers.
2. *Benefits to FPD users from having access to a domestic industry.* Diversification of FPDs and increasing integration of functions onto the display have the potential to put domestic FPD users at a disadvantage; developing a domestic capability could ameliorate such problems.
3. *Spillovers to related industries.* There are some spillovers between FPD and semiconductor manufacturing processes; a high-volume domestic FPD industry could help the materials and equipment infrastructure of the semiconductor industry.

The profits that might accrue to domestic producers are dependent on the structure of the world FPD industry and markets, future growth patterns, technology developments, and product uses. The potential benefits to downstream industries that use FPDs are dependent on the structure of worldwide supply and the development of display technology. Possible spillovers to related industries will be driven by developments in manufacturing technology and markets. All of these issues are investigated in the first three parts of this chapter.

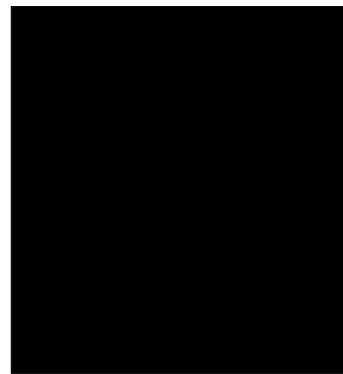

The second set of potential benefits from developing a high-volume domestic FPD industry applies to national security. FPD technologies will increasingly be used in the design, manufacturing, and retrofit of military systems. The Department of Defense (DOD) is concerned that it does not have early, assured, and affordable access to leading-edge FPD technology for these systems. There are three reasons for this concern:

1. Military demand is and will remain a small fraction of the world FPD market, thus limiting the effectiveness of DOD procurement in shaping the domestic industry;
2. Military display requirements are widely varying and often differ from commercial requirements in their final form; and
3. The concentration of FPD manufacturing capacity in Japan to date has raised concerns over U.S. military access to FPD technologies.

DOD has determined that the best way to meet its goal of early, assured, and affordable access to FPDs is through a dual-use strategy that relies on the development of a domestic high-volume FPD industry. In order to examine the benefits that would accrue to the military from the development of such an industry, it is instructive to examine the current status of the development and procurement process for military FPDs.

As the final section in this chapter illustrates, many military display requirements are currently filled through a combination of foreign-produced commercial displays and domestically produced custom displays. While foreign suppliers may not guarantee the timeliness and assured access that DOD desires, defense contractors that modify foreign-produced commercial displays deliver systems that perform adequately for many missions at a competitive price. Regardless of whether a display is produced domestically or abroad, and for both custom- and commercially manufactured displays, the cost of adapting displays for military systems is much higher than the cost of the display itself.

### DEMAND FOR FLAT PANEL DISPLAYS

The demand for FPDs is large and increasing by more than 10 percent annually (measured by value). There are numerous technologies available for creating an FPD. The demand is greatest for liquid crystal displays (LCDs), and, increasingly, for active matrix LCDs (AMLCDs) used in portable computing devices. The FPD market will exceed \$10 billion in 1995, and is expected to range from \$20 billion to \$40 billion by the turn of the century. One source of uncertainty in the estimates is the relationship between growing demand and falling prices: it is not clear how rapidly manufacturing costs (and thus prices) for FPDs will fall, which makes the increase in demand difficult to predict. While critical to the U.S. military, FPDs for military systems represent less than one percent of worldwide demand, and are not likely to grow as a share of the overall market.

### ■ Flat Panel Display Technologies and Markets

FPDs are electronic displays that present images in a thin package (see box 2-1). FPDs have been used in two ways. First, they have been widely adopted as replacements for mechanical or other types of electrical displays for indicators, gauges, and dials in numerous systems, such as watches, calculators, gas pumps, and test equipment. Second, more complex FPDs have enabled the development of laptop computers, notebook computers, personal digital assistants, and other handheld and portable computers. In the future, FPDs may begin to replace bulky cathode ray tubes (CRTs) in desktop computer monitors and home televisions, and may allow large-screen televisions thin enough to hang on a wall.

The world FPD industry has grown steadily since the early 1980s (see figure 2-1). Growth was fueled in the mid-1980s by the introduction of FPD-based pocket televisions, and in the early 1990s by the use of FPDs in the rapidly growing laptop computer market. Throughout the 1990s,

## BOX 2-1: Display Technologies

Flat panel display (FPD) is a term used to describe technology that presents visual information in a package with a depth much smaller than its horizontal or vertical dimensions. FPDs can be used in many applications that the cathode ray tube (CRT), the mainstay of video displays for five decades and used in most home televisions and desktop computer displays, cannot. The CRT is generally as deep as the width of the screen; because the entire CRT is glass, the package is both heavy and large.

In general, FPDs are constructed by sandwiching a material that is electro-optically active (one that—in response to an applied electric field—either modifies the transmission or reflection of an external light source, or emits light) between glass plates. Transparent horizontal and vertical electrical conductors are deposited on the plates, forming rows and columns in a grid pattern. Individual picture elements, or *pixels*, are defined by each intersection of a row and a column. The modulation or emission of light by each pixel is controlled through the application of voltage to the electrodes. In some displays (including passive matrix liquid crystal displays), the voltage difference between a pixel's row-and-column electrodes directly acts on the material between the glass plates; in other displays (including active matrix liquid crystal displays), the voltages on a pixel's row-and-column electrodes are used to set an electronic element such as a transistor, which in turn acts on the material between the glass plates. The latter approach gives better performance, but the added electronic elements make manufacturing more difficult.

Figures and text can be represented on FPDs by the application of electrical signals to the display matrix. The FPDs that account for the largest market share (measured by value), demonstrate the fastest predicted growth, and use the most challenging manufacturing process are high-information-content displays.<sup>1</sup> These displays are demanded by most computer, business, communications, and transportation applications, and a large fraction of consumer and industrial applications (see appendix A for a more detailed discussion of FPDs).

There are four types of commercially available high-information-content FPDs:

1. *Passive matrix liquid crystal displays (PMLCDs)* are one of the main types of transmissive displays. They use liquid crystal materials, controlled by electrical signals on a grid, to affect the transmission of light.
2. *Active matrix liquid crystal displays (AMLCDs)* are another type of transmissive display. The AM LCD builds on the PM LCD by using switching elements located at each pixel to control display performance.
3. *Electroluminescent displays (ELs)* are one type of emissive display currently available. EL FPDs use a solid phosphor material that glows when exposed to an electric field.
4. *Plasma displays*, another type of emissive display, use a gas to create a single color directly or to create multiple colors indirectly by energizing colored phosphors.

Other FPD technologies are being or have been evaluated and developed for high-information-content applications; the two most promising are: 1) the field emission display (FED), a type of emissive FPD that is a flat version of a CRT; and 2) the digital micromirror device (DMD), a reflective FPD that is an array of miniature mirrors whose positions can be electrically controlled to reflect light, forming an image on a screen. The four most common high-information-content FPD technologies can be compared with the CRT in terms of several performance criteria (see table below).

(continued)

<sup>1</sup>The U S Department of Commerce has defined any display with more than 120,000 pixels—corresponding to a full-page display, consisting of 25 rows by 80 columns, with 5 by 7 dot matrix characters—as high information content. A more typical format is VGA (video graphics adapter), comprised of 480 by 640 pixels, in a color display, there are three copies of each pixel, for nearly one million pixels.

BOX 2-1: Display Technologies (Cont'd.)

Flat Panel Display Technologies Performance Comparison

Feature	Passive matrix LCD	Active matrix LCD	Electro-luminescent	Plasma	Cathode ray tube
Resolution	medium	high	medium/high	medium/high	high
Luminance	medium	high	medium	medium	high
Contrast	medium	high	medium/high	low/medium	medium
Ambient contrast	medium	high	low/high	medium	low
Gray scale	low	high	medium	medium	high
Number of colors	medium	high	medium/high	medium/high	high
Viewing angle	low	medium	high	high	high
Screen update time	slow	fast	fast	fast	fast
Temperature range	narrow	narrow	wide	medium/wide	wide
Vibration capacity	high	high	medium	medium	low
Power	low	low	medium	medium	high
Volume	low	low	low	low	high
Weight	low	low	low	medium	high

KEY LCD = liquid crystal display

NOTE Shaded boxes indicate display technology weaknesses,

SOURCE Louis D. Silverstein, "Color in CRT and LC Displays," 1994 SID International Symposium Seminar Lecture Notes (Santa Ana, CA Society for Information Display, 1994), vol 2, p F-3/5.

- *Resolution* is a measure of the smallest detail that can be displayed, for computing tasks that use graphic Interfaces (such as Windows), high resolution is required,
- *Luminance* is a measure of brightness, *contrast* is a measure of the ratio of a light pixel to a dark pixel, and *ambient contrast* is a measure of contrast in the presence of ambient light Many applications, like portable devices, demand high luminance, contrast, and ambient contrast.
- Gray scale is the number of discrete levels (shades) to which a pixel can be set; this affects the degree of shading possible in a monochrome (black and white) display, and is a factor in the number of colors achievable by a color display.
- *Viewing angle* is the angular measure of the decrease in contrast that results in viewing the display from a position other than head-on, a low viewing angle means that the user must be directly in front of a screen in order to perceive a comfortable level of contrast
- Fast *screen update time* is required for the display of full-motion video, as from a television signal, and for the display of some computer tasks, such as rapid cursor movement,
- *Temperature range* is the breadth of ambient temperatures in which the display can effectively operate, some displays are adversely affected by exposure to temperatures outside of a set narrow range,
- Vibration capacity refers to the ability of a display to withstand external shocks without adverse effects on performance.
- Finally, *low power consumption*, *volume*, and *weight* are key attributes of portable displays

AMLCDs match or exceed the performance of CRTs in all categories except for viewing angle and temperature range. The AMLCD is the fastest growing type of display technology, and it is likely to surpass the PMLCD as the largest FPD market segment, in terms of value, in 1996. The reason that AMLCD technology has become the leading approach to FPD manufacturing is that the combination of high performance, low weight, and small volume it offers makes it well suited for use in portable computing devices, a fast-growing market, The main limitation to adopting AMLCD technology in other systems—such as home televisions and desktop computers—has been the high manufacturing costs relative to the

(continued)

**BOX 2-1: Display Technologies**

CRT, a mature and relatively inexpensive technology. EL and plasma displays match or exceed the performance of AMLCDs in some measures, and are used for military, industrial, medical, and other applications that demand high performance in viewing angle or temperature range. While offering the lowest overall performance, PMLCDs are a mature technology and are inexpensive to manufacture. PMLCDs offer adequate performance for applications such as simple text/numeric displays in equipment, appliances, and timepieces, and have also remained a low-cost alternative to AMLCD in less demanding portable computer applications.

The growing dominance of the AMLCD could be challenged by one of several FPD technologies in development. In particular, FEDs are anticipated to match or exceed the performance of AMLCDs, and may also have significantly lower manufacturing costs.

SOURCE Office of Technology Assessment, 1995

**FIGURE 2-1: Worldwide Flat Panel Display Market, All Sizes, Types, and Applications: 1983-2001**

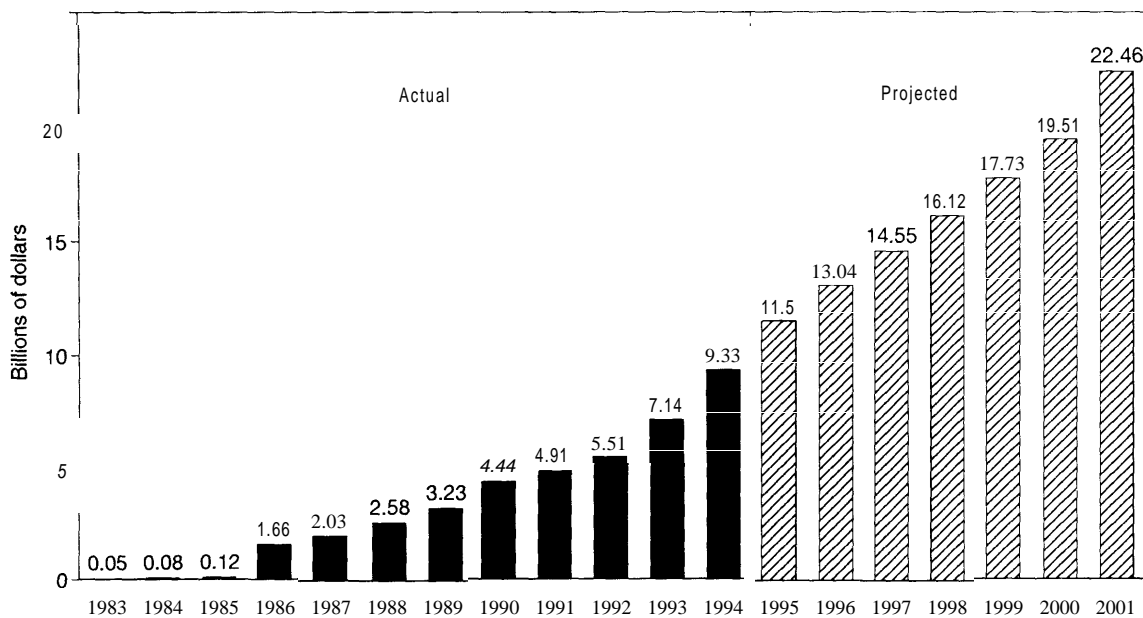

SOURCE David Mentley, Director, Display Industry Research, Stanford Resources, Inc., San Jose, CA, personal communication, Mar 21, 1995

**FIGURE 2-2: Projected Worldwide Flat Panel Display Market Shares by Application 1995 and 2001**

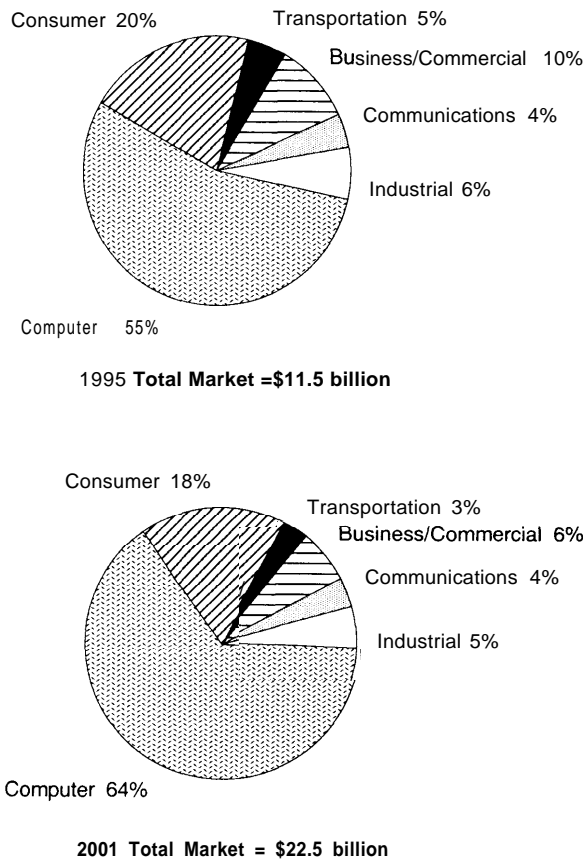

SOURCE: David Mentley, Director, Display Industry Research, Stanford Resources, Inc., personal communication, Mar 21, 1995

rapid growth in the market for portable computers has driven the demand for FPDs and provided a large application base for which standard types of FPDs have been developed. In this large portion of the market, manufacturing-based competition has emerged; profits are dictated by manufacturing costs rather than product design.

The projections in figure 2-1 represent an average annual growth rate of 12 percent between 1995, when the market is projected to be \$11.5 billion, and the year 2001, when it is projected to be \$22.5 billion. Other sources have used higher rates of growth in their projections. One source is the Japanese electronics magazine, *Nikkei Microdevices*, which calculated that the growth rate of LCD production from 1990 to 1995 has averaged 32 percent per year, with a predicted 1995 production value of 1.25 trillion yen (approximately \$15 billion at current exchange rates).<sup>1</sup> Projecting a continuation of this growth rate, the magazine has estimated that LCD production will exceed 4 trillion yen (approximately \$47 billion using current rates) by the turn of the century. The disparity in these estimates reflects the uncertainties in this growing industry. The more conservative estimate in figure 2-1 is based on projected growth rates in current applications; it does not include potential new FPD applications. The Japanese estimates are based on production plans; they do not take into account whether or not the displays will actually be purchased (see the following section on display supply).

The FPD technology projected to lead the market in growth is the active matrix liquid crystal display (AMLCD, see box 2-1), which is used in computers, the fastest growing application. Most computer applications are portable devices: laptops, notebooks, and handheld or pen-based computers that require light, compact, and low-power-consumption displays. Computers have been the largest FPD application for the past several years and demand is projected to grow faster—at an average annual growth rate of approximately 16 percent—than any other segment between 1995 and 2001 (see figure 2-2). Firms have manufactured notebook screens that are increasingly larger in diameter and higher in

<sup>1</sup>“Scale of Liquid Crystal Industry Assessed,” in *Flat Panel Display 1995*, *Nikkei Microdevices*, Dec. 9, 1994, pp. 74-80 (translation provided by Maurice Cloutier, Foreign Broadcast Information Service). The estimates were taken from a poll of Japanese and Korean LCD producers; the years are Japanese fiscal years, which begin on April 1. In an article in the same publication, Samsung predicted a \$28-billion LCD market by the year 2000.

resolution, and desktop PC and workstation FPDs are now appearing in the market.

Other applications include consumer items, industrial equipment, communication systems, business systems, and transportation systems. The consumer items that use FPDs include portable televisions, video games, camcorders, personal organizers, and memo devices; future applications may include high definition televisions. Industrial equipment includes test and analytical equipment, medical instrumentation, and factory/inventory control devices. Communications applications include portable phones, video phones, and pagers. Business systems incorporating displays include office equipment, overhead projectors, financial terminals, and large-screen public displays. Displays in transportation systems include instrumentation in pleasure boats, aircraft cockpits, and automobiles, as well as passenger entertainment systems in aircraft, trains, and, potentially, automobiles.

High-information-content displays (see box 2-1) account for more than 90 percent of the display market, measured by value. These FPDs are currently based on several technologies, and many more technologies are in the research and development stage. The leading technologies are the passive matrix liquid crystal display (PMLCD) and the AMLCD, each accounting for 43 percent of the market in 1995 (see figure 2-3). AMLCD technology is projected to grow at 16 percent annually between 1995 and 2001, far outpacing all other technologies. The growth of AMLCDs may be limited by new color PMLCDs using *dual-scan* technology, which approaches AMLCD performance at lower prices.

Much smaller shares are held by plasma displays (3 percent) and electroluminescent (EL) displays (1 percent), neither of which is expected to grow as a share of the market before 2001. Technologies that are only used for low-information-content applications, such as alphanumeric indicators on appliances, make up another 10 percent of the FPD market. The leading technologies in this market segment are light emitting diodes (LEDs) and vacuum fluorescent displays (VFDs),

which to date have not been suitable for high-information-content displays. There is also a possibility that technologies not yet in production, such as field emission displays (FEDs) and digital micromirror devices, may capture significant market share in coming years.

### ■ The Military Market

Current military applications include command and control systems, aircraft cockpits, ground vehicles, air traffic control, and portable and head mounted infantry systems. However, the military portion of the FPD market is quite small, and is not expected to exceed a few percent of the total world market in the foreseeable future (see figure 2-4). DOD's estimate of the military demand for FPDs over the next 25 years shows modest growth until 2009; projected annual demands range from 15,000 to 25,000 displays (see figure 2-5), compared to an overall market demand in the tens of millions. After 2010, when head mounted systems are expected to become standard equipment for soldiers, the annual requirements will increase sharply, but are not expected to exceed 100,000. The largest component of future military demand—displays from 0.5 to 5 inches in diameter used in projection and head mounted systems—is currently a small part of the commercial market, but may be used in the future for commercial projection displays and virtual reality systems.

### SUPPLY OF FLAT PANEL DISPLAYS

The FPD industry is diversified in terms of applications markets and technology types, but there is an increasing trend toward the use of LCDs, and particularly AMLCDs, in portable computer and communications devices. During the early 1990s, a few Japanese companies such as Sharp, Toshiba, and NEC dominated FPD production through large investments in LCD manufacturing.

More recently, however, large investments in LCD production have been made by many other Japanese companies, as well as a few Korean, Taiwanese, and European companies, thus decreasing the industry concentration. Although FPD demand growth rates are projected to be high, in-

**FIGURE 2-3: Projected Worldwide Flat Panel Display Market by Technology, 1995 and 2001**

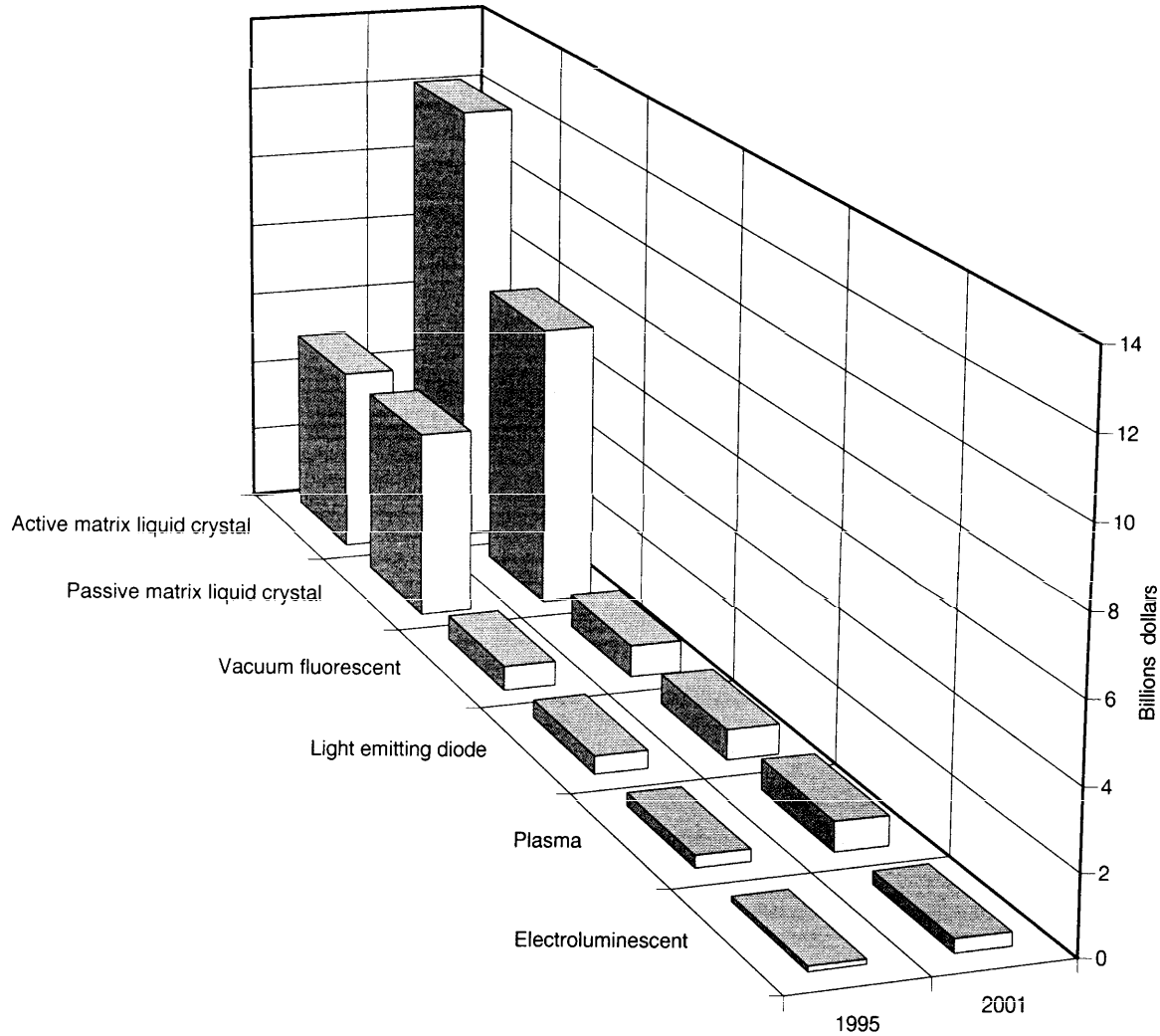

SOURCE: David Mentley, Director, Display Industry Research, Stanford Resources, Inc., personal communication, Mar. 21, 1995.

vestments announced worldwide in FPD manufacturing facilities will likely result in manufacturing capacity that will exceed demand. This will result in downward pressure on FPD prices (which could stimulate additional demand), and could also result in reduced profits for FPD manufacturers. A recent report states that profit

margins have deteriorated since the end of 1994 for leading AMLCD producers. The report asserts that a *typical firm* that began production in 1992 did not reach profitability until 1994; is likely to show zero profits throughout the second half of 1995; and will return small profits in 1996 and 1997.<sup>2</sup>

<sup>2</sup>Hideki Wakabayashi, "Is Confidence in the Growth Potential of the LCD Panel Market About To Collapse?" Nomura Research Institute, Tokyo, May 25, 1995.



**FIGURE 2-4: Military Flat Panel Display Sales: Total Sales and Percent of the World Market, 1991-2001**

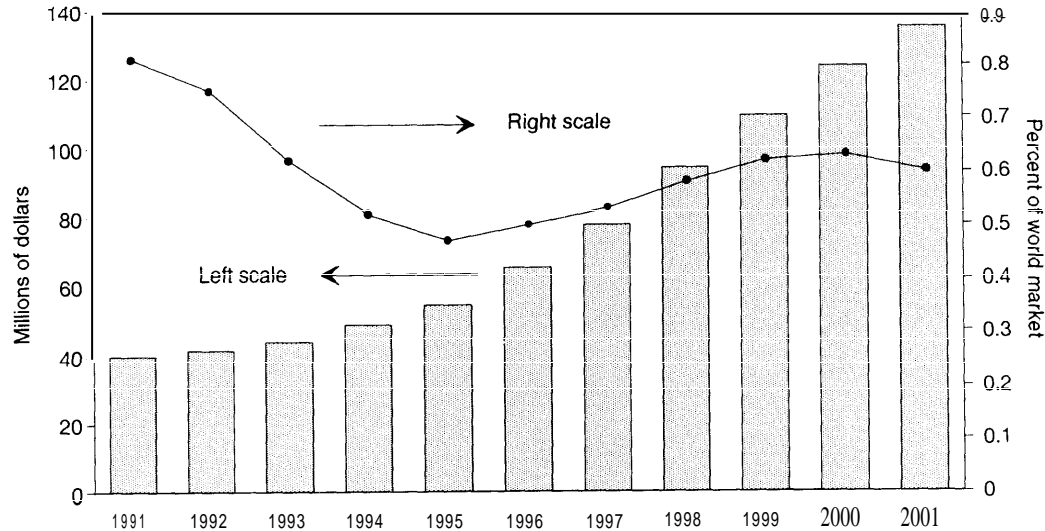

NOTE Values for 1995-2001 are projections

SOURCES Military market figures from Len Zuga, *U S Military Display Markets :New Technologies, Upgrades, and Government Funding Brighter? Market*, Report 5207-16 (Mountain View, CA Frost& Sullivan, 1995), figures 3-1 and 3-2, size of world market from figure 2-1 above

The large investments made by East Asian firms have created barriers to production for potential U.S. entrants, and the recent growth of investment in AMLCDs has made entry in that technology even less attractive. Taken as a whole, the small investment made by U.S. firms has been spread among several FPD technologies, and has not been sufficient to develop high-volume production capabilities.

**■ FPD Production in Japan**

Most current FPD production is in LCDs produced in Japan. During Japanese fiscal year 1994, LCD manufacturers planned to produce more than \$8 billion in displays (see table 2-1). Japanese manufacturers have made large investments in LCD manufacturing plant and equipment since the late 1980s. Definitive measures of investments are difficult to obtain because of difficulties in verifying whether announcements have been followed through, uncertainties in determining exactly what the investments were for (i.e., physi-

**FIGURE 2-5: Estimated Annual Defense Demand for FPDs, by Units and Size, 1995-2019**

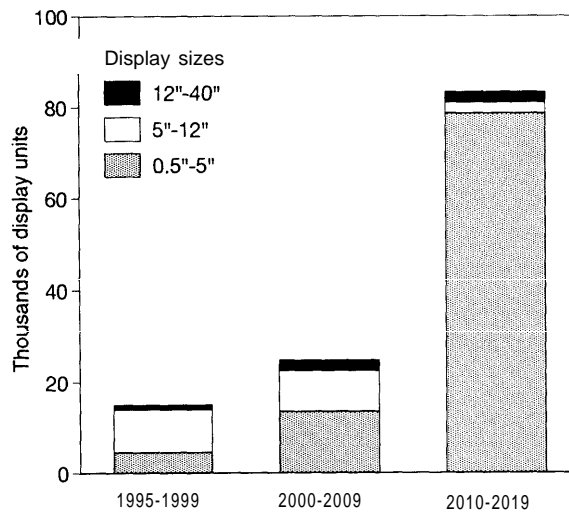

SOURCE :U.S. Department of Defense, *Building U.S. Capabilities in Flat Panel Displays: Report of the Flat Panel Display Task Force*, October 1994, figure 3-8

**TABLE 2-1: Announced Investment and Production by Japanese LCD Producers  
(in hundreds of millions of yen<sup>a</sup>)**

Company	FY 1989-93 <sup>b</sup> investment (reported)	FY 1994-95 <sup>b</sup> investment (planned)	FY 1994 <sup>b</sup> production value (forecast)
Sharp	1,600	870	2,300
Toshiba <sup>c</sup>	820	850	1,100
NEC	430	500	800
Seiko-Epson	535	180	700
Sanyo Electric <sup>d</sup>	270	300	630
Hitachi	250	200	550
Casio Computer	835	100	450
Optrex	170	100	430
Hosiden	380	190	350
Matsushita Electric	640	200	350
Kyocera	105	150	130
Mitsubishi Electric <sup>e</sup>	525	430	40
Fujitsu	290	230	20
Others <sup>f</sup>	640	200	400
Total	7,490	4,500	8,250

KEY: LCD = liquid crystal display

NOTES:

The values are reported in yen, because the Investments are given for multiple years in some cases, and there have been large fluctuations in yen/dollar exchange rates during that period, no conversion is made. At the 1994 exchange rate of 100 yen/dollar, the figures translate to millions of dollars.

<sup>a</sup>The Japanese fiscal year begins on April 1; FY 1994 ended March 31, 1995.

<sup>b</sup>Figures for Toshiba include its investment in and production share from Display Technology, inc., a joint venture with IBM Japan.

<sup>c</sup>Figures for Sanyo Electric include Tottori Sanyo.

<sup>d</sup>Figures for Mitsubishi Electric are mainly comprised of Advanced Display Inc., a joint venture with Asahi Glass.

<sup>e</sup>Alps Electric, Canon, Citizen Watch, Ricoh, Rohm, Seiko-Denshi Kogyo, Sony, and Stanley Electric.

SOURCES: "Scale of Liquid Crystal Industry Assessed," in *Flat Panel Display 1995*, *Nikkei Microdevices*, Dec. 9, 1994, pp. 74-80, chart 2 (translation provided by Maurice Cloutier, Foreign Broadcast Information Service), updates from H Wakabayashi, "IS Confidence in the Growth Potential of the LCD Panel Market About to Collapse?" Nomura Research Institute, May 25, 1995.

cal plant, capital equipment, or materials), and other uncertainties. However, announced capital expenditures are a reasonable guide to the order of magnitude of Japanese FPD investments.

Total investments made through 1993 resulted in roughly equal amounts of LCD output in 1994. The leading firms had lower ratios of investment to production than other firms; this is likely due to the weighting of investments by the leaders toward the beginning of the measurement period,

which has resulted in increased production capacity. If one equates the value of production with revenues, these estimates bear out an investment to revenue ratio of 1-to-1 made by one industry analyst.<sup>3</sup>

The top three producers of LCDs (and, more broadly, of FPDs) in 1995 are Sharp, Toshiba, and NEC. Sharp is the leading producer of both PMLCDs and AMLCDs (and is also a leading producer of EL FPDs). Sharp's dominance in

<sup>3</sup>See David Mentley, "Forecast Inflation," *International Display Report*, Stanford Resources, Inc., San Jose, CA (distributed electronically by SEMI Newsletter Service), Nov. 15, 1994. Announced production does not equal revenues, since some production may have gone unsold and some sales may be from preexisting inventory. These figures are for LCD plants only, and do not include investments in other FPD technologies such as plasma; for example, Fujitsu, NHK, and Matsushita are leading plasma manufacturers. Fujitsu recently announced that it will invest \$941 million in a plant to produce plasma screens measuring one meter in diagonal; see "Fujitsu Betting On Plasma Display s," *Electronic Engineering Times*, June 5, 1995, p. 28.

TABLE 2-2: Evolution in Japanese Active Matrix Liquid Crystal Display Production

Generation	Zero <sup>a</sup>	First	Second	Third	Fourth
Year begun	1987	1990	1993	1995	around 1997
Size of glass substrate	150x150 mm 150x200 mm	300x350 mm 300x400 mm 320x400 mm	370x470 mm 380x480 mm 400x500 mm	550x650 mm 500x600 mm 500x700 mm	560x720 mm
Displays per substrate (number and size)	1 (6-inch) or 1 (9-inch)	4 (6-inch), 4 (8-inch), or 2 (10-inch)	6 (7-inch), 4 (10-inch), or 2 (14-inch)	6(10-inch), 4 (14-inch), or 1 (30-inch)	9(10-inch), 4 (16-inch), or 2 (21-inch)
New applications	Portable TV	Laptop PC	Portable and desktop PCs	Engineering workstation	

## NOTE.

The first active matrix liquid crystal display fabrication lines used converted semiconductor equipment, dedicated lines were not built until the late 1980s

SOURCES: Tannas Electronics, cited in Pete Singer, "Flat Panel Displays: An Interesting Test Case for the U.S.," *Semiconductor International*, July 1994, p 78; Lawrence E Tannas and Robert A Burnmeister, "Electronic Display Forum& EDEX'95 at SEMICON/FPD Yokohama," ATIP95 20, Asian Technology Information Program, May 13, 1995

LCD production has led to concerns about the potential for monopolistic behavior. However, due to the continuing investments made by more than 15 other Japanese firms (see table 2-1) and other companies, Sharp's share of Japanese LCD production has fallen. In 1993, Sharp's share of Japanese AMLCD production value was 42 percent, but fell to 36 percent in 1994; in PMLCDs, its share fell from 24 percent to 20 percent.<sup>4</sup> Toshiba (including its share of Display Technology Inc., a joint production venture with IBM) is the third-largest producer of both AMLCDs and PMLCDs; most of its AMLCD production is used internally, but it sells PMLCDs and some AMLCDs on the merchant market. NEC is the second-largest AMLCD producer (it does not make PMLCDs); it has been increasing the share of its production sold on the merchant market, from 30 percent in 1994 to 50 percent by the end of 1995.<sup>5</sup>

AMLCD manufacturing has been through several stages or generations (see table 2-2). The early investments were devoted to funding the first two generations of AMLCD manufacturing technolo-

gy; present and planned investments are financing the third and fourth generations. As manufacturing processes have become more complex, the required investment has increased. However, capacity has increased in each generation, and as each firm increased its manufacturing experience, the yield (percentage of working displays) steadily improved. These two factors have brought down manufacturing costs. Existing LCD production lines are comprised of three generations; Sharp is the leading adopter of new production technology (see table 2-3). Actual output of working displays from existing plants varies with the number of displays per substrate and the yield rate.

Several government-supported consortia in Japan have conducted R&D on display technologies, and government corporations have also been involved. The leading government agencies for display research have been the Ministry of Trade and Industry (MITI) and the Ministry of Posts and Telecommunications (MPT). The primary government consortia and corporations are:

<sup>4</sup>Market shares calculated from "scale of Liquid Crystal Industry Assessed," op. cit., footnote 1, chart 2 for firms' production estimates and figure 1 for estimates of total production. Years cited are Japanese fiscal years, which begin on April 1.

<sup>5</sup>Charles L. Cohen, "Japan Puts More into LCD plants," *Electronic Buyers' News*, June 5, 1995, p. 1.

TABLE 2-3: Liquid Crystal Display Production Lines in Japan

Company	Generation	Plant	cost (¥100M <sup>a</sup> )	Substrate size (mm)	Date online	Initial capacity (substrates/ month) <sup>b</sup>	Full capacity (substrates/ month) <sup>b</sup>
Sharp	1	Tenri NF1	270	320 X 400	Fall 1991	n/a	30,000
	2	Tenri NF2	250	360 X 465	May 1994	n/a	15,000 <sup>c</sup>
	2	Tenri NF3	250	370 x 470	1994	n/a	15,000 <sup>c</sup>
	3	Mie 1	530	n/a	July 1995	n/a	5,000 <sup>c</sup>
	n/a	Mie 2	n/a	550 X 650	July 1995	10,000 <sup>c</sup>	n/a
DTI	1	Himeji	280	300 x 400	Oct. 1991	n/a	30,000
	2	Himeji	320	360 X 465	June 1994	n/a	30,000
	3	IBM Yasu	400	550 X 650	4th qtr. 1995	10,000	65,000 <sup>c</sup>
NEC	1	Kagoshima 1	200	300 x 350	Aug. 1990	n/a	22,000
	2	Kagoshima 2	330	360 X 465	Dec. 1993	15,000	30,000
	n/a	Akita	300	370 x 470	Late 1995	15,000	30,000
Hosiden	1	Kobe	180	270 X 320	Aug. 1993	n/a	60,000
	2	Kobe	200	400 x 500	Late 1995	10,000	25,000 <sup>c</sup>
Hitachi	1	Mobara	100	200 X 270	Late 1989	n/a	10,000
	2	Mobara	300	370 x 470	Late 1994	n/a	30,000
Casio	2	Kochi (2)	285	370 x 470	May 1994	n/a	12,000
Fujitsu	1	Yonago	205	300 x 400	Mar. 1994	n/a	8,000
	2	Yonago	180	370 x 470	1996	n/a	26,000
Mitsubishi	1	Kumamoto(1)	280	300 x 400	Feb. 1993	n/a	15,000
ADI	2	Kumamoto(2)	130	370 x 470	June 1995	10,000	25,000

## NOTES.

The values are reported in yen; because the Investments are given for multiple years in some cases, and there have been large fluctuations in yen/dollar exchange rates during that period, no conversion is made. At the 1994 exchange rate of 100 yen/dollar, the figures translate to millions of dollars.

<sup>a</sup>The actual number of displays varies; see table 2-2 for potential displays for each substrate size.

<sup>b</sup>Estimate made by *Nikkei Microdevices*

SOURCE: "Scale of Liquid Crystal Industry Assessed," in *Flat Panel Display 1995*, *Nikkei Microdevices*, Dec. 9, 1994, pp. 74-80, chart 3 (translation provided by Maurice Cloutier, Foreign Broadcast Information Service).

- *Giant Technology Corp. (GTC)*, a consortium organized by the Japan Key Technology Center (JKTC, a joint partnership between MITI and MPT) in 1989 to develop meter-sized AMLCD panels for high resolution displays and other applications, including printing, copying, and solar cells. This ambitious goal has since been scaled back and GTC has begun to emphasize AMLCD process technology and color plasma display research. GTC has a budget of approximately \$25 million, 70 percent of which comes from JKTC and the remainder from the 17 member companies, including Thomson and Hoescht.
  - *High Definition Television Engineering Corp. (HDTEC)*, also a JKTC-funded consortium.
- The program seeks to develop an LCD projector for high definition television (HDTV) applications. There are several companies participating in the \$30-million program, again with 70-percent funding from JKTC. The primary participants are NHK, Seiko-Epson, and NEC.
- *The Japan Broadcasting Co. (NHK)*, Japan's public broadcasting corporation, has been conducting research in HDTV for the past few decades. Its Science and Technical Laboratories have a \$60-million budget that funds nine research divisions, several of which involve display technologies. NHK has concentrated on large color plasma panels for HDTV monitors. It has a division dedicated to transferring

technology to the private sector, and carries out joint development projects with industry.

- *Nippon Telephone and Telegraph (NTT)*, which does not manufacture equipment, but conducts research and transfers it to the private sector. Traditionally the government telephone corporation, NTT is now partially privatized.

## ■ FPD Production in East Asia and Europe

In addition to Japanese FPD investments, firms in East Asia—led by Samsung of Korea—and in Europe—led by the consortium known as the Flat Panel Display Co.—are also adding to the global FPD production capacity.

### *Korea and Taiwan*

Throughout East Asia (outside of Japan), there are efforts to enter into the FPD industry; there is even assembly of simple LCDs in the People's Republic of China. In 1994, 7 percent of PMLCDs and 1 percent of AMLCDs were manufactured by East Asian firms based outside of Japan.<sup>6</sup> Especially in PMLCDs, manufacturing has matured to the extent that Japanese firms have moved production—28 percent in 1992—to foreign sites owned by Japanese firms.<sup>7</sup>

Japanese firms do not yet produce AMLCDs outside of Japan. However, firms in the Republic of Korea (South Korea)—Samsung in particular—are leading the race to develop AMLCD production capabilities, followed by companies in the Republic of China (Taiwan). Korean and Taiwanese firms have entered the FPD industry for differ-

ent reasons.<sup>8</sup> In general, Korean firms appear to view FPDs as an important industry on its own as a potential successor industry to CRTs. CRTs are a \$2-billion industry in Korea, but Samsung estimates that the value of LCD production will overtake that of CRTs in 1998.<sup>9</sup> FPDs are also viewed as a companion industry to semiconductors, one that could take advantage of the existing manufacturing infrastructure. It is also hoped that a strong FPD industry will create large amounts of export income; because the level of production for portable computers in Korea is low, firms plan to export the screens to U.S. computer companies.

The drive to develop FPD manufacturing capabilities in Taiwan appears to be related to its role as a home for personal computer manufacturers. Taiwanese companies have an even greater share of the world computer monitor market (approximately 50 percent) than do Korean firms, and have a growing share of the portable computer market. In 1993, earnings from notebook PC production exceeded those for desktop PC production, and one source estimates that one-quarter of all notebook computers produced in 1995 will be made in Taiwan.<sup>10</sup> However, during 1993, an insufficient supply of LCD screens meant that Taiwanese producers were unable to fill many orders; these firms appear determined to become more independent of FPDs supplied by Japan.

An issue that firms in both nations must address is the lack of a materials and equipment infrastructure; most inputs are imported from Japan. Acquiring such inputs from other nations allows the new producers to take advantage of the technology embodied in the inputs. However, it also keeps

<sup>6</sup> David Mentley, Director, Display Industry Research, Stanford Resources, Inc., San Jose, CA, personal communication, Mar. 21, 1995.

<sup>7</sup> Data from the Japanese Ministry of International Trade and Industry, cited in Department of Defense, "Building U.S. Capabilities in Flat Panel Displays: Report of the Flat Panel Display Task Force," October 1994, p. IV-2.

<sup>8</sup> Tomohaku Nakamori, "Korea and Taiwan Furiously Pursuing Japan in TFT-LCD," *Nikkei Electronics*, May 23, 1994, pp. 125-134 (translation in *JPRS Report: Science & Technology Japan*, Mar. 15, 1995).

<sup>9</sup> Yoichi Funaki and K. Nozaki, "Korean Yield Shows Remarkable Growth; Taiwan's Production Moves Toward Stable Supply," in *Flat Panel Display 1995*, op. cit., footnote 1, pp. 109-112.

<sup>10</sup> See David Lieberman, "Taiwan Lags in Active-Matrix LCDs," *Electronic Engineering Times*, Oct. 17, 1994, p. 27; Funaki and Nozaki, op. cit., footnote 9; and Scott McCartney, "Small Companies Gain Ground in Notebooks by Buying From Taiwan," *Wall Street Journal*, June 1, 1995, p. B1.

**TABLE 2-4: Announced Liquid Crystal Display Investments by Korean Firms (in millions of dollars)**

Company	Investment
Samsung	1,250
LG Electronics	875
Hyundai	575
Daewoo-Orion	550

SOURCES: Nikkei *Microdevices* data, cited in William C. O'Mara, "Active Matrix LCD Manufacturing," in *1994 SID International Symposium Seminar Lecture Notes* (Santa Ana, CA: Society for Information Display, 1994), vol. 1, p M-3/19; "South Korea. Industry Planning Major Drive Into LCD Market," *FBIS Science & Technology Perspectives*, Feb. 28, 1994, "ROK Moving 'Full Scale' Into Next-Generation Displays," *Pacific Rim Economic Review*, June 29, 1994, pp. 25-26; and Laxmi Nakarmi, "Look Out World—Samsung Is Coming," *Business Week*, July 10, 1995, p. 52

the cost of production high because spending on FPD manufacturing equipment and components (driver chips, color filters, and backlights) comprises the majority of FPD manufacturing costs.

To gain access to leading-edge technology, Korean firms have relied on technology transfer agreements with second-tier Japanese firms and some American firms. Samsung has taken several such steps, including forming an alliance with Toshiba in 1993 to develop LCD integrated circuits; signing a cross-licensing agreement with Fujitsu; and, through the joint venture Samsung-Corning, constructing a color filter factory expected to have an annual capacity of 1.5 million 10-inch filters.<sup>11</sup> Hyundai is a majority owner of ImageQuest, a California firm formed in 1992 with American researchers. LG Electronics (formerly Lucky-Goldstar) formed a \$100-million *joint research corporation* with the Japanese company Alps Electric in 1994, and also has a technology agree-

ment with Hitachi.<sup>12</sup> Orion Electric, a subsidiary of the Daewoo Group, has a technology transfer agreement with Toshiba for PMLCDs. Orion has announced plans to invest in AMLCDs in 1995.

Samsung is the most experienced LCD producer, having begun production of PMLCDs in 1984 and AMLCDs in 1993. It was the first Korean company to mass produce AMLCD screens for notebook computers, and has produced displays as large as 14 inches. LG Electronics and Hyundai began PMLCD production in 1988 and 1990, respectively; LG will begin mass production of AMLCDs later this year, and Hyundai is transferring AMLCD technology from ImageQuest to a line in Korea. Announced investments in LCD manufacturing by these firms exceed those of some of the lower tier Japanese firms (see table 2-4).

Monthly production of notebook-size AMLCDs in Korea (primarily by Samsung and LG Electronics) is expected to reach 150,000 screens by the end of 1995.<sup>13</sup> Hyundai expects to produce approximately 30,000 displays per month beginning in 1996. In Taiwan, mass production is scheduled to begin in 1997 (see table 2-5). There are several manufacturers of PMLCDs in Taiwan, including Picvue, Nan Ya Plastics, and Chung-Hua Picture Tubes. AMLCD production has been led by Unipac and PrimeView International, both of which are producing AMLCDs up to 6 inches in diagonal and are carrying out pilot production of notebook screens. There have been mixed reports on the progress of these firms toward volume production, citing difficulties in attracting skilled engineers and in maintaining access to components. \*4

<sup>11</sup>"ROK Moving 'Full Scale' Into Next-Generation Displays," *Pacific Rim Economic Review*, June 29, 1994, p. 26; "Fujitsu, Samsung Agree To Exchange LCD Technology," *Nikkei Weekly*, Apr. 17, 1995, p. 22.

<sup>12</sup>"Goldstar Signs New Foreign Technology Agreements," *Maeil Kyongje Sinmun*, June 21, 1994, pp. 1, 4 (summary in *Pacific Rim Economic Review*, Sept. 21, 1994); "South Korea: Liquid Crystal Display Assessed," *FBIS S&T Perspectives*, vol. 10, No. 3, Mar. 31, 1995, pp. 18-19.

<sup>13</sup>"South Korea's Top Three Device Makers Investing Heavily in TFT LCD Technology," *Channel*, vol. 8, No. 4, May 1995, p. 18.

<sup>14</sup>Mark Carroll, "Taiwan Displays LCD Woes," *Electronic Engineering Times*, May 29, 1995, pp. 18,22.

TABLE 2-5: Production Lines for 10-Inch Diagonal AMLCD Screens in Korea and Taiwan

Company	Plant location	Substrate size (mm)	Date operational	Initial capacity (substrates/month)	Full capacity (substrates/month)
Samsung	Kihung	370 x 470	Dec. 1994	15,000	80,000
LG Electronics	Kumi	370 x 470	Nov. 1995	40,000	80,000
Unipac	Taiwan	320 x 400	Mar. 1997	n/a	n/a
PrimeView International	Taiwan	370 x 470	Dec. 1997	24,000	n/a

KEY: AMLCD = Active Matrix Liquid Crystal Display

SOURCES: David Lieberman, "Taiwan Lags in Active-Matrix LCDs Electronic Engineering Times, Oct 17, 1994, p 27, "Scale of Liquid Crystal Industry Assessed," pp. 74-80, chart 3, and Funaki Yoichi and K. Nozaki, "Korean Yield Shows Remarkable Growth, Taiwan's Production Moves Toward Stable Supply," pp. 109-112, table 1, both in *Flat Panel Display 1995*, Nikkei *Microdevices*, Dec. 9, 1994 (translation provided by Maurice Cloutier, Foreign Broadcast Information Service), "South Korea's Top Three Device Makers Investing Heavily in TFT LCD Technology," *Channel*, May 1995, p 18

The Republic of Korea has designated displays a strategic industry, which allows tariff reductions on imported inputs and access to lower cost capital from abroad. The Ministry of Trade, Industry and Energy planned to fund display development through its Electro-21 program, but failed to do so; it has given only \$6 million to an industry research consortium.<sup>15</sup> However, in June 1994, the Korean government announced that it would fund a *thin-film LCD* research program at a level of \$156 million, and a program to develop *next-generation flat displays* at a level of \$21 million. Both programs are multiyear efforts, with private support exceeding government funding.<sup>16</sup> Taiwan's Electronics Research and Service Organization (ERSO) has worked with companies to develop prototype FPDs, and has also been a source of trained engineers for companies such as PrimeView. ERSO projects have included research on AMLCD, plasma, and FED.<sup>17</sup>

in total, Korean firms have set a goal of reaching a 10-percent share of the world AMLCD market by the year 2000. Taiwanese firms are trying to develop an indigenous supply of notebook screens to lessen their dependence on foreign-made displays. If successful, these efforts will put a consid-

erable amount of pressure on Japanese manufacturers to reduce prices.

### Europe

The European share of the FPD market has been marginal to date; only in the production of plasma displays does it have a significant presence (13 percent of world production in 1994). The largest European FPD initiative is the Flat Panel Display Co. (FPD Co.), a joint venture between the Dutch electronics firm Philips NV, the French companies SAGEM SA and Thomson Multimedia, and the German chemical firm Merck (see figure 2-6). The company was formed in 1992 and is based in Eindhoven, the Netherlands. FPD Co. has sold tens of thousands of units, and has a goal of \$100 million in global revenues in 1995.<sup>18</sup>

Philips is clearly the driver behind FPD Co., having built a pilot plant in Eindhoven in 1987 and planned for commercial production since 1991.<sup>19</sup> Philips has brought two assets to FPD Co.: 1) a process for using thin film diodes that it believes will provide better performance at a lower price than thin film transistor AMLCDs, and 2) a large integrated circuit fabrication plant near Eindhoven (the Maas facility), which had been

<sup>15</sup> Andrew Pollack, "From Korea, a Challenge to Japan," *New York Times*, May 12, 1994, p. D1.

<sup>16</sup> "Government-Supported Electronics Projects Outlined," *Pacific Rim Economic Review-South Korea*, July 28, 1994.

<sup>17</sup> Alan Patterson, "Taiwan Startups Eye LCDs," *Electronic Engineering Times*, Mar. 21, 1994, p. 26.

<sup>18</sup> Robert Gray, Product Engineer, FPD Co., San Jose, CA, personal communication, June 5, 1995.

<sup>19</sup> Ronald van de Krol, "Rival Systems Attack Japan's Dominance," *Financial Times*, May 3, 1995, p. VI.

FIGURE 2-6: Supply and Ownership Relationships Among European Active Matrix Liquid Crystal Display Producers

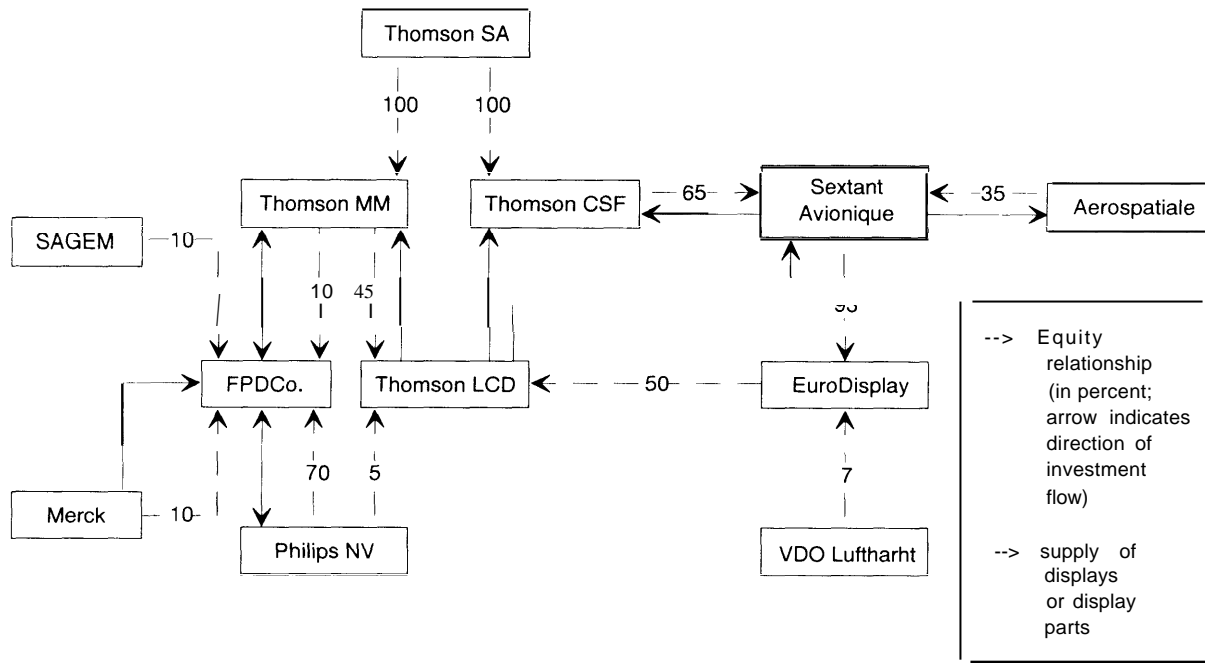

KEY: FPD Co = Flat Panel Display Co ; SAGEM = Societe d'Applications Generales d'Electricite et de Mechanique; Thomson CSF = Thomson's aerospace and defense systems divisions; Thomson LCD = Thomson Liquid Crystal Display; Thomson MM = Thomson's multimedia and consumer electronics divisions.

NOTES: All percentages are rounded, Thomson SA is the parent company of Thomson MM and Thomson CSF, Philips NV is the parent of all Philips divisions.

SOURCES: Office of Technology Assessment, 1995, based on information from trade press and industry representatives

unused since Philips' Megaproject bid in the late 1980s.<sup>20</sup> By the end of 1994, FPD Co. had invested nearly \$300 million for capital improvements to the plant. In 1994, the consortium announced that it was considering a second high-volume plant to be located in Taiwan, Singapore, or the United States.

The Maas facility's capacity has increased from 40,000 displays per month when commercial production began early in 1995 to 70,000 monthly;

FPD Co. hopes to increase production to 75,000 per month by the end of 1995.<sup>21</sup> Along with a small pilot plant in central Eindhoven, FPD Co. may have a capacity as high as 100,000 displays per month. It will produce both display components and finished displays; diagonal sizes range from 2.8 to 10.4 inches, and larger displays are being developed.<sup>22</sup> Initially, it is concentrating on automotive, commercial projection, and airline entertainment system applications. Between 25

<sup>20</sup>Ronald van de Krol, "Europe's Liquid Assets," *Financial Times*, Dec. 22, 1994, p. 10.

<sup>21</sup>van de Krol, op. cit., footnote 19; Gray, op. cit., footnote 18.

<sup>22</sup>Robert Hartman, Group Leader, FPD Co., Advanced Development Center, Eindhoven, Netherlands, personal communication, May 24, 1995; Leo Pekelharing, U.S. Representative, FPD Co., San Jose, CA, personal communication, Apr. 3, 1995.



and 30 percent of the displays are used internally by Philips and Thomson (primarily for HDTV and projection TV applications). The remainder of FPD Co.'s production is sold commercially in Europe, North America, and Asia.<sup>23</sup>

Although a distinct legal entity, FPD Co. receives significant administrative support from Philips, and shares research with all its parent companies. SAGEM has contributed technology to reduce the number of steps in thin film transistor (TFT) fabrication from between six and eight to two or three, thus allowing FPD Co. to develop TFTs in the future.<sup>24</sup> Merck supplies liquid crystals to the venture. Philips and Thomson are also important suppliers to, as well as customers of, FPD Co.; for example, Philips produces the backlight for FPD Co. displays.<sup>25</sup>

In addition to FPD Co., several Thomson SA enterprises are involved in FPDs (see figure 2-6). Sextant Avionique is Europe's leading manufacturer of avionic AMLCDs; its \$700 million in total revenues is split almost evenly between civil and military aerospace. Its military sales are all made in Europe or to European manufacturers; sales in the United States are limited to commercial avionics.

All of Sextant's LCDs are supplied by Thomson LCD. Building on the Thomson-GE work from the 1980s, Thomson moved LCD operations from the United States to Grenoble, France. A small plant (annual capacity in the thousands) produces 8- by 8-inch displays for use by Sextant, and a new facility was recently completed to build 14- by 14-inch AMLCDs; although monitor-sized

color prototypes have been built, the line has experienced production difficulties. In addition to supplying Sextant's needs, Thomson will use these displays internally.<sup>26</sup>

Thomson SA has expanded its plasma facility, which will have an annual capacity of approximately 5,000 displays. Although most panels are sold in France where they are used in police and military applications (rugged workstations), the company's U.S. operations sell plasma panels to equipment manufacturers and integrators, mostly small volumes (hundreds) of 13-inch displays for military, industrial, and medical applications. Thomson Multimedia has recently developed a 19-inch color plasma display prototype, with potential applications in professional workstations and HDTV.<sup>27</sup>

In FEDs, PixTech (formerly Pixel) of France is the leading firm. PixTech was formed in 1992 to commercialize developments in FED technology at the Laboratoire d'Electronique, de Technologie et d'Instrumentation (LETI), a research laboratory of the French atomic energy agency, which had built on work done at the American firm, SRI International. PixTech is pursuing spatial color FED technology and holds the rights to several cold cathode technology approaches. PixTech is planning to build a medium-volume production line (annual capacity of 50,000 or more) for 6-inch diagonal displays, and hopes to develop a 10.5-inch FED by the end of 1995. Completing the circle, PixTech has entered into alliances with Raytheon, Texas Instruments, Futaba, and Motorola, to share

<sup>23</sup> van de Krol, op. cit., footnote 19.

<sup>24</sup> SAGEM transferred this technology from the French national telecommunications laboratory, CNET; see Richard L. Hudson, "Philips Refits Dutch Plant in Bold Plan To Unseat Rivals," *Wall Street Journal*, July 28, 1993, p. B4.

<sup>25</sup> Gray, op. cit., footnote 18.

<sup>26</sup> Larry Webster and Willy Moses, U.S. Representatives, Sextant Avionique, Miami, FL, personal communication, May 19, 1995.

<sup>27</sup> Ernest Stern, President, Thomson Components and Tubes Corp., Totowa, NJ, personal communication, May 19, 1995.

experimental quantities and cross-license technology.<sup>28</sup>

The European Union (EU) has supported some FPD R&D.<sup>29</sup> As part of the Third European Research and Technology Development Framework Program, the European Strategic Programme for Research and Development in Information Technologies (ESPRIT) devoted less than \$50 million to cost-shared display research during the period 1990-94. The Fourth Framework Program, scheduled to last through 1998, has budgeted \$128 million for displays. The main thrust is the European Consortium Active Matrix (ECAM), an industry-led project focusing on AMLCDs. Started in January 1993, the ECAM project involves a total of 19 partners from the Netherlands (Philips is the lead partner), France, Germany, the United Kingdom, and Belgium, and is composed of 11 projects. The overall aim is to develop technologies and components that will make larger display sizes and/or higher resolutions feasible, increase the number of potential applications of LCD technology, and develop less complex designs and more cost-effective production methods. Smaller projects focus on FEDs and ferroelectric LCDs.

While European entities are currently niche players, the coordination provided by EU involvement and the interlocked investments by large electronics firms could allow European companies to increase their share in plasma and AMLCDs, and to lead the commercialization of FED.

## EFFECTS ON RELATED INDUSTRIES

Development of a domestic FPD industry could benefit related industries—both users and suppliers—but there is considerable uncertainty regarding the size of those benefits. The presence of

domestic sources could enable U.S. firms competing in industries that use FPDs in their products (so-called *downstream* industries such as portable computer manufacturers) to work more closely with suppliers of a critical component that accounts for a large fraction of the product's value and appeal to the customer. Collaborating with foreign-based suppliers is difficult for some firms, and there have been periods of undersupply of FPDs in the past. However, most firms have supply arrangements with several producers, and the current and proposed production capacity appears sufficient to meet demand in the near future.

Additional integration of system functions onto the display could also affect downstream industries by putting display manufacturers in a stronger position relative to the system manufacturers. There are several technical paths such integration could take, but to date there has been limited integration in high-volume production. Finally, related industries, such as semiconductor devices, could benefit from developments in a high-volume domestic FPD industry. There are several areas in common—largely in equipment and materials inputs—between FPD production and semiconductor device manufacturing. But significant differences in the actual production processes and in the size of the two industries will limit such effects.

## ■ Downstream Industries

Some observers argue that, for diversified products based on advanced FPDs, the lack of a domestic FPD manufacturing base could inhibit competitiveness. Sometimes, the FPD serves to differentiate the downstream product. In such cases, it is important for the downstream firm to be able to purchase the best FPDs available or to have custom designs made. Since many Japanese

<sup>28</sup> Bob Taylor, Manager, Flat Panel Displays, Texas Instruments, Dallas, TX, personal communication, Apr. 17, 1995; Hambrecht & Quist and Needham & Co., Inc., *PixTech Prospectus*, July 18, 1995.

<sup>29</sup> "Exploitation Within the ESPRIT Programme," *Euro Abstracts*, No 32, May 1994, p. 303, reprinted in *JPRS Science & Technology Europe/International Economic Competitiveness*, JPRS-EST-94-017-L, July 11, 1994; Ken Werner, "U.S. Display Industry: On the Edge," *IEEE Spectrum*, May 1995, pp. 62-69.

FPD producers are vertically integrated electronics companies, their first priority could be to supply displays needed for the firm's own end products, forcing U.S. firms that make competing end products to wait longer for the latest displays. A strong U.S. FPD industry would make downstream U.S. firms much less dependent on Japanese FPD producers.

In some products, the best design might require, for example, a different size display, a new way of fitting the display into the product housing, or a special electronic interface between the display and other components. Japanese dominance of the FPD industry could pose difficulties for U.S. firms. In many cases, Japanese FPD producers have not been interested in customizing displays to U.S. customers' specifications, particularly for small numbers of displays. This is particularly true in military displays, which are required in custom versions and in small quantities; Sharp Corp., for one, has refused to deal directly with DOD requirements for FPDs.

In addition, relying on Japanese display producers who might use display designs to produce competing products could put U.S. customers at a competitive disadvantage. In cases where specialized requirements must be designed into the display, U.S. firms may hesitate to share sensitive product development information with companies that are also downstream competitors. The best known example of this problem is the Wizard, a personal digital assistant (PDA) introduced by Sharp soon after Apple's Newton, which Sharp produced for Apple.

However, there are ways for downstream users to limit the flow of design information. Computer companies typically protect their designs by using rigorous nondisclosure agreements with their FPD suppliers. These are used to limit the flow of design information to competitors, including those within the same corporate group as the display manufacturer. This seems to provide adequate protection, and the growth in FPD manufacturing capacity will ease these concerns somewhat by giving U.S. firms more choices. Increasing competition in the market for standard-

ized FPDs could make some firms more willing to work on custom designs.

The only domestic downstream firm that has moved to gain direct control over FPD production is IBM, whose Japanese subsidiary is a joint owner of Display Technology Inc. (DTI), a leading FPD manufacturer located in Japan. This approach allows IBM to vertically integrate FPD production with portable computer manufacturing, but it has to cooperate in display design and production with its co-owner, Toshiba, a competitor in portable computers. Aside from IBM, leading U.S. portable computer manufacturers (such as Compaq, Apple, and Texas Instruments) rely on multiple sources of display manufacturers to supply relatively standardized computer screens.

These issues are of most concern in custom sectors of the FPD market. Sharp has been a pioneer in developing new applications for FPDs, utilizing its core capabilities in LCD production to create new products. Sharp used LCDs to create PDAs and a large-format videocamera viewfinder, as well as to enter the portable computer market. However, there are several characteristics of the largest segment of the FPD market—LCDs for portable information systems—that place it toward the commodity end of the spectrum. This suggests that although downstream users may benefit from the development of a domestic, high-volume, manufacturing capability, the benefits could be limited to the smaller segments of the market in which display customization is required.

In the market for portable computer displays, FPDs are becoming more like commodity items. The majority of FPD plants in operation or under construction are designed to produce screens suitable for notebook computers. While there have not been strict product definitions, the standard screen for this application has evolved from an 8.4-inch diagonal VGA (video graphics adapter, a standard for computer displays that is an array of information comprised of 640 rows and 480 columns) in the early 1990s, to a 10.4-inch VGA screen in 1994, to what is becoming the new standard, 10.4- or 11.3-inch SVGA screens (super-

VGA, 800 by 600 pixels) that display 16.7 million colors. Some XGA screens (extended graphics array, 1024 by 768 pixels) have also been produced. Other than screen size, resolution, and color palette, there do not appear to be any strong distinguishing characteristics from the consumer's perspective.

Manufacturing considerations reinforce the standardization of display types. Like integrated circuits (ICs), manufacturing costs for standardized displays decrease with increasing cumulative production of that item: the more screens produced, the less each costs to produce. The rate of cost reduction for AMLCDs has been estimated at half of that for ICs.<sup>30</sup> To a large extent, the slower rate of cost reduction in AMLCD production is attributable to the difficulty in producing what are effectively large-area ICs on glass substrates. Display production has proven more difficult than manufacturing semiconductor chips. Large amounts of production have brought the yield—percentage of useable displays—to 70 percent, compared with semiconductors, where yields are typically greater than 90 percent. Combined with the large capital costs required for a state-of-the-art production facility, this trend rewards high production volumes of a similar product; creating customized versions of a display increases the cost of manufacturing on that particular production line.

Manufacturing costs have been steadily reduced, however, and resulting decreases in display prices have reinforced the trend toward commodity displays. One analyst estimates that manufacturing costs in Japan for 10-inch AMLCDs declined from \$2,500 in 1991 to just over \$1,000 in 1993; during the same period, manufacturing yields increased from 10 percent to nearly 60 percent.<sup>31</sup> During 1993, AMLCD prices quoted by Japanese producers declined by approximately 17 percent; they fell by as much as 20 percent during the first three quarters of 1994, and by 25 percent during the last quarter.<sup>32</sup> In dollar terms, prices fell from \$1,200 in mid-1994 to \$830 in early 1995.<sup>33</sup>

The principal cause of the rapid decline in prices was the increase in productive capacity during 1994 as new manufacturing facilities were brought online by Sharp, NEC, DTI, and other firms; one source estimates that Japan's total monthly LCD output has increased 62 percent since 1994.<sup>34</sup> The increase in AMLCD production, combined with price pressure from improved PMLCD screens, has resulted in diminishing profits for AMLCD manufacturers.<sup>35</sup> Growing production capacity will drive the prices of standard displays down further. In the early years of mass production of AMLCDs, manufacturing was concentrated among a few firms in Japan.

<sup>30</sup> Historical estimates for integrated circuits show a 28-percent decrease in unit cost for each doubling of production volume. See U.S. Congress, Office of Technology Assessment, *International Competitiveness in Electronics*, OTA-ISC-200 (Washington, DC: U.S. Government Printing Office, November 1983), p. 76. DOD has estimated the slope for AMLCDs to be 14 percent; Kenneth Flamm, DOD, presentation to OTA, May 18, 1995.

<sup>31</sup> William C. O'Mara, "AMLCD Manufacturing," in *1994 SID International Symposium Seminar Lecture Notes* (Santa Ana, CA: Society for Information Display, 1994), vol. I. Another analyst estimates that yields are currently greater than 70 percent; Joseph Castellano, Stanford Resources, Inc., San Jose, CA, personal communication, Apr. 14, 1995.

<sup>32</sup> Japanese fiscal years; for historical prices, see "Scale of Liquid Crystal Industry Assessed," op. cit., footnote 1, figure 4A. For recent prices, see Wakabayashi, op. cit., footnote 2, figure 1. Also see estimates from *Nihon Keizai Shinbun*, quoted in Hisayuki Mitsusada, "Advanced LCD Makers Look Beyond PCs," *Nikkei Weekly*, Mar. 20, 1995, p. 8.

<sup>33</sup> U.S. prices from Brooke Crothers and Rob Guth, "Cheaper LCDs Spur Notebook Price Breaks," *InfoWorld*, Apr. 24, 1995, p. 1. Note that while displays represent the largest single component in a notebook computer, even as performance (resolution, size, and number of colors) has increased, screen prices have declined and are approaching those of microprocessors.

<sup>34</sup> Estimates from Merrill Lynch Japan, quoted in Mitsusada, op. cit., footnote 32.

<sup>35</sup> Wakabayashi, op. cit., footnote 2.

However, the industry structure is becoming less concentrated, and volume AMLCD production is being developed in Korea, Taiwan, and Europe.

In general, as products mature and become commodities, the basis for competition shifts from product innovation to reduction of manufacturing costs and incremental improvements to performance. As this happens, production moves to lowest-cost mass manufacturers that are most able to offer standardized goods at steadily decreasing ratios of price to performance. As with dynamic random access memory chips (DRAMs, see box 2-2), successful entry by Korean and other firms will likely have the effect of opening up competition on pricing and availability of AMLCDs, which will have a salutary effect from the perspective of U.S. display users.

### ■ Integration of Displays and Systems

FPDs could become critical to electronic products if they incorporate functions that are presently elsewhere in the systems that use displays. Known as *integration*, this technology path would involve building increasingly sophisticated system functions into the display itself, so that—in the extreme case—the display is the system. Under this scenario, the location of display production would be more important because, in many cases, it will be the end product with little value added elsewhere.<sup>36</sup> Product competition would be design intensive, rather than manufacturing intensive, and could result in a more diversified set of FPD products. In such a scenario, the inability to produce displays domestically would handicap U.S. competitiveness in systems like portable computers because the lack of an FPD manufacturing base would limit the ability to produce integrated systems.

Integration comprises a spectrum of design and manufacturing choices. The primary forms of integration are electronic, but there are also mechanical or functional forms; for example, designing the display frame and system cover in notebook computers as one structure to reduce weight and size.<sup>37</sup> The range of possibilities for electronic integration extends from complete integration at one end to a bare display, which has only the electrodes that supply current, at the other. In the latter case, there is no integration: circuitry that drives the display, as well as the circuitry and mechanical devices for the system of which the display is a part, is located elsewhere in the system.

Electronic integration can be achieved in two ways. One way is to mount IC chips onto the display glass. This method has been used for driver chips (ICs that are the first level of interface between the display and the system), which improves the manufacturing process. Using such a method to achieve higher levels of integration—such as integrating sophisticated ICs like microprocessors or memory chips—is complicated by limited space on the display glass, the complexity of interconnections for such chips, and differences in the product development cycles of ICs and FPDs. While these complications may be overcome, it is not clear that FPD manufacturers will have an advantage over computer manufacturers in the integration of nondisplay functions.

The second method of achieving integration is to extend the techniques used to build active matrix circuits—TFTs on glass—to more sophisticated circuits required by memory or microprocessor functions. There are several technical barriers to this approach, however, and the circuit density required may be hard to attain with TFTs. In addition, mastery of AMLCD manufacturing has been difficult for the leading firms, who

<sup>36</sup> For a discussion of the potential strategic implications of integration, see Michael Borras and Jeffrey A Hart, “Display’s the Thing: The Real Stakes in the Conflict Over High-Resolution Displays,” *Journal of Policy Analysis and Management*, vol. 13, No. 1, 1994, pp. 21-54.

<sup>37</sup> Steven Depp, Director, Subsystem Technologies and Applications Laboratory, Thomas J. Watson Research Center, IBM, Yorktown Heights, NY, personal communication, Apr. 11, 1995.

## BOX 2-2: Dynamic Random Access Memory (DRAM) Chips

in examining the potential effects of foreign dominance of flat panel display (FPD) production on related and downstream U.S. industries, it is instructive to consider experience with the semiconductor industry over the past decade, in particular, the movement of leadership in production of dynamic random access memories (DRAMs) from the United States to East Asia is relevant,

During the 1980s, declines in the competitiveness of U.S. DRAM producers relative to Japanese competitors led to concerns for the semiconductor industry. First, it was asserted that loss of dominance in DRAMs would harm manufacturing competitiveness in other integrated circuit (IC) products because DRAMs were thought to be a technology driver for IC manufacturing as a whole. Second, it was argued that declines in domestic DRAM market share would hurt the competitiveness of downstream industries, such as computers. Third, some observers were concerned that the shift in DRAM leadership to Japan would be followed by loss of leadership in production of semiconductor manufacturing equipment.

During the period from 1978 to 1986, Japanese firms' share of world DRAM production increased by roughly 60 percent, mostly at the expense of US firms; more recently, a large fraction of production has been captured by firms in South Korea and Southeast Asia. <sup>1</sup>Concerns over the loss of leadership in DRAM production led to a consortium (U.S. Memories) to offset the dominance of Japanese DRAM producers. However, the consortium was abandoned after the entry of low-cost Korean manufacturers caused a supply glut that resulted in multiple sources of supply and falling prices,

Although DRAM production for the merchant market (that is, through arms-length sales to electronics manufacturers) has largely moved to Japan and South Korea, captive production (to satisfy internal company demand) by firms such as AT&T and IBM has continued at a substantial level. As the capital investment required for a DRAM plant has increased, even these large firms have entered into joint production agreements; for example, IBM, Siemens, and Toshiba are collaborating on 256-megabyte DRAM production technology,

Concerns over the strategic nature of DRAMs also contributed to the creation of Sematech in 1987. Although the consortium abandoned its original goal to develop production processes for memory chips and other ICs, it moved to supporting the development of a semiconductor supplier base. While there is debate over the effectiveness of Sematech, most consider it to be successful, and the U.S. firms recently regained leadership of semiconductor production,<sup>2</sup> in the semiconductor supplier industry, domestic firms have also improved their position. After declining from 1981 to 1990, domestic equipment manufacturers have increased their share of the world market to nearly 54 percent in 1994.<sup>3</sup>

Although U.S. production of DRAMs has remained at roughly 20 percent market share since the late 1980s, U.S. producers regained the lead in worldwide semiconductor market share in 1993, largely by recapturing shares of expanding markets in products such as microprocessors and application-specific

(continued)

<sup>1</sup>For historical market shares, see U.S. Congress, Office of Technology Assessment, *Contributions of DOE Weapons Labs and NIST to Semiconductor Technology*, OTA-ITE-585 (Washington, DC: U.S. Government Printing Office, September 1993), figure 3-5. South Korean companies currently produce roughly 30 percent of DRAMs, and some analysts predict they will surpass Japanese production; see David Hamilton and Steve Glain, "Koreans Move To Grab Memory-Chip Market from the Japanese," *Wall Street Journal*, Mar. 14, 1995, p. A1.

<sup>2</sup>For a critical view of Sematech, see "Uncle Sam's Helping Hand," *The Economist*, Apr. 2, 1994, p. 77.

<sup>3</sup>Semiconductor Industry Association, *The Information Highway: Paved with Silicon*, March 1995, p. 5.

## BOX 2-2: Dynamic Random Access Memory (DRAM) Chips (Cont'd.)

integrated circuits (ASICs).<sup>1</sup> Despite initial fears, the wide availability of low-priced DRAMs in recent years demonstrates that end-users in the United States can benefit from increased international competition. For example, many U.S. firms are competitive in personal computer manufacturing. This may also be the case in the commodity segments of the FPD market.

FPDs and semiconductors both comprise a spectrum of device types that are typically sold to downstream users such as computer, communications, and consumer electronics manufacturers. The semiconductor industry produces a wide variety of integrated circuits (ICs), ranging from DRAMs—devices whose production requires a large capital investment, but are basically commodity items—to ASICs that are highly diversified products. Microprocessors—which are design-intensive and require large investments in manufacturing technology, but are produced in standard types within each product generation—fall somewhere between DRAMs and ASICs. An analogous description of the FPD industry would place standardized AMLCDs for notebook computers toward the commodity end, and complex custom AMLCDs, which have row-and-column drivers integrated onto the display, at the diversified product end. In between are the largest market segments (in value terms)—video displays for portable computers, communications devices, and games—that use both AMLCDs and PMLCDs.

There are limitations to the analogy, however. Perhaps the biggest difference is that in semiconductors, U.S. firms led the world in production before the loss of market share in commodity chips; in FPDs, the U.S. industry has lagged firms in Japan. Thus, rather than moving from commodity to higher value products, U.S. firms must either jump directly into production of diversified FPDs, or face entrenched competition in the large segments of the market moving toward commodities.

SOURCE Office of Technology Assessment, 1995

<sup>1</sup>For example, after declines in the early 1980s, U.S. share of the world market for microcomponents increased from approximately 50 percent in 1986 to just under 70 percent in 1992, and U.S. share of ASICs increased from less than 50 percent in 1988 to 53 percent in 1992, *ibid.*, p. 1, and U.S. Congress, Office of Technology Assessment, *op. cit.*, footnote 1, figures 3-6 and 3-7.

suffered through several years of production at low yield levels. There is reason to conclude that including extra components on the display will only diminish yields.

### ***Integrated Circuit Mounting Techniques***

in the original method for attaching driver chips, called *chip-on-board* (COB), they are mounted on printed wiring boards that are connected to the display by metallic electrodes printed on a flexible substrate. The connector is mechanically joined to the row-and-column electrodes. Currently, the most common technique is *chip-on-film* (COF), also called *tape automated bonding* (TAB), in which bare (unpacked) chips are mounted on a

flexible tape (often made of selectively conductive rubber that has electrodes printed on it) for connection to the rows and columns. COF/TAB enables narrower spacing than COB and, by eliminating the chip packages, reduces volume and weight.

in the most advanced method of attaching chips to the display, called *chip-on-glass* (COG), bare chips are mounted directly onto the edges of the display glass substrate and connected directly to the electrodes. This method is the ultimate form of integration using discrete driver chips; it can reduce the FPD volume and weight further, while increasing the reliability of the connections between the drivers and the electrodes. The tradeoff



Chip-on-glass technology as seen on the edges of this plasma display, reduces manufacturing costs, improves reliability and decreases package size.

with COG is that it is difficult to repair faulty chips once they are mounted, and space is required around the edge of the display glass to mount the chips (which is counter to the design trend of minimizing the area of the display glass).

Currently, the primary items mounted using COF/TAB and COG are driver chips. The potential exists for other components, such as graphics controller and power conversion circuits, to be mounted in a similar fashion, but this has not yet occurred.

In general, emissive displays offer greater potential for integration via COG techniques. The back surface of the display glass is not utilized (unlike transmissive displays such as LCDs, in

which the back surface of the glass must be left unobstructed so that light can pass through), thus providing a large surface for mounting chips; the difficulty is in making interconnections from the back. FED developers are also investigating multilayer ceramic modules that embed the display on one side of the substrate and chips on the other.

### **Depositing Silicon on Glass**

A higher level of electronic integration is to fabricate electronic devices on the periphery of the display using the same or similar techniques used to fabricate active matrix elements.<sup>38</sup>

As with mounting chips on the display glass, there are limitations to this type of integration. Amorphous silicon—the most commonly used material for TFTs—is not well suited to the high-speed operation required for driver circuits, although a research group recently produced an experimental version of an amorphous silicon AMLCD with integrated drivers.<sup>39</sup>

Use of polycrystalline silicon could allow devices to operate at higher speeds and enable the fabrication of denser circuitry along the periphery of the display. Although similar in some ways to amorphous silicon fabrication, polycrystalline silicon typically requires deposition temperatures of 600 °C or more, compared to the 450 °C maximum in amorphous silicon processing.<sup>40</sup> The higher temperatures require the use of quartz substrates rather than glass, which expands or breaks down at high temperatures. Quartz is more expensive than glass and limited in diameter to a few inches, thus limiting the application of polycrystalline silicon to small displays such as video-camera view finders and head-mounted displays. A new glass developed by Corning that can with-

<sup>38</sup> An early expression of the concept of display integration can be found in T. Peter Brody and Paul R. Malmberg, "Large Scale Integration of Displays Through Thin-Film Transistor Technology," *International Journal of Hybrid Microelectronics*, vol. 2, 1979, pp. 29-38.

<sup>39</sup> R. G. Stewart et al., "Circuit Design for a-Si AMLCDs with Integrated Drivers," p. 89, and H. Lebrun et al., "AMLCD with Integrated Drivers Made with Amorphous-Silicon TFTs," p. 403, in 1995 SID International Symposium Digest of Technical Papers, vol. 26 (Santa Ana, CA: Society for Information Display, May 1995).

<sup>40</sup> Recent research has demonstrated methods for reducing the deposition temperature for polycrystalline Silicon to the same as amorphous silicon; see "Hitachi Advances in Low-Temp TFTs" *Electronic Engineering Times*, Oct. 17, 1994, p. 20.



stand temperatures as high as 600 °C may enable polycrystalline silicon processes to be adopted more widely.<sup>41</sup>

Single crystal silicon can also be used for making TFTs and other circuit elements. This process, pioneered by Kopin Corp., has the highest electronic performance of all. A standard IC is fabricated on a silicon wafer, and then stripped off and reattached to the glass panel of an FPD. This allows the active matrix and other integrated elements to be fabricated using proven semiconductor techniques. The display size is currently limited to approximately one-inch diameter devices, used in head-mounted and projection systems, and production is still in the prototype stage.

### ■ Spillover to Semiconductor Manufacturing

Similarities between the semiconductor and FPD industries have led to some synergy between their associated materials and equipment suppliers. For example, Semiconductor Equipment and Materials International (SEMI), which represents a large part of the world industry, has an FPD division with over 100 member companies. Such synergy could result in spillover effects, especially if the FPD industry were to become large compared with semiconductors. Some aspects of FPD production will likely place demands on equipment and materials suppliers that exceed requirements posed by IC manufacturing.

In addition to common materials and equipment inputs—such as semiconductors, gases, and deposition and photolithographic systems—some aspects of FPD manufacturing have much in common with semiconductor fabrication; the creation of hundreds of thousands of switching transistors, involving the deposition of semiconductors, met-

als, and insulators in multiple, repeated photolithography steps onto a silicon substrate.<sup>42</sup> Indeed, the earliest AMLCD fabrication lines were modified semiconductor lines, and, initially, there were spillovers between IC and FPD manufacturing. IC producers in Japan and Korea leveraged their semiconductor production experience in entering AMLCD manufacturing. Due to growing differences in production and markets, however, spillovers are likely to be limited mostly to the supplier level of the two industries. Thus, IC manufacturers are not likely to face competition from FPD producers, but IC fabricators that purchase equipment from FPD suppliers will have access to leading-edge technology that may not otherwise be available.

Despite the strong current and projected AMLCD growth rates, the FPD industry as a whole will likely remain a fraction of the size of the semiconductor industry (although some equipment and materials suppliers rely on FPDs for a large fraction of revenues). Worldwide revenues for semiconductor sales were \$100 billion in 1994, compared with \$9.33 billion in FPD sales. Semiconductor sales are projected to reach \$200 billion by the year 2000, compared with the \$20 billion projected for FPDs.<sup>43</sup> Given the larger potential market, equipment and materials suppliers for the semiconductor industry will have incentive to develop the needed tools, whether or not there was an FPD industry driving some of the technological developments.

Even in the absence of a high-volume domestic FPD industry, firms that supply equipment and materials could sell to foreign FPD manufacturers. U.S. firms that supply FPD and semiconductor manufacturers have made inroads in supplying foreign-based producers in Asia, such as Applied

<sup>41</sup> The previous standard, Corning code 7059, has a strain point, or temperature limit, of 593 °C; the new glass, Corning code 1737, has a strain point of 666 °C. See Dawne M. Moffatt, "Flat Panel Display Substrates," in *Flat Panel Display Materials*, J. Batey, A. Chiang, and P. H. Holloway (eds.), Symposium Proceedings, vol. 345 (Pittsburgh, PA: Materials Research Society, 1994), p. 163.

<sup>42</sup> Borrus and Hart, *op. cit.*, footnote 36.

<sup>43</sup> Semiconductor sales data and projections from Semiconductor Industry Association, *The Information Highway: Paved with Silicon*, March 1995, p. 1.

Materials (chemical vapor deposition), Photon Dynamics (testing), Corning (glass), and Texas Instruments (driver chips).

### ***Spillover in Equipment and Materials***

There are several areas in which FPDs drive semiconductor manufacturing processes, such as large area substrates and contamination problems. FPD manufacturers must have the capability to handle and process large substrates, currently up to 24 inches on a side, all while minimizing contamination. Semiconductor manufacturers are currently planning to move to 300-millimeter wafers (approximately 12 inches in diameter) from which the individual chips are made. The increased diameter requires larger handling equipment and processing chambers, and the increased surface area requires more stringent control of contamination. Both have been concerns for FPD manufacturers and suppliers.<sup>44</sup>

Another example is research on TFTs that has resulted in the creation of memory devices made out of polycrystalline silicon, with the potential for application to ICs. Researchers have also investigated the use of amorphous silicon to fabricate ICs; and atomic layer epitaxy, a thin film process developed to build EL displays, has been suggested as an alternative to current semiconductor processes.<sup>45</sup>

In other areas critical to semiconductor manufacturing, such as research on increasing the resolution of lithography systems, FPDs are not likely to be a driver for manufacturing technology. Semiconductor chip design and manufacturing constantly move toward narrower linewidths (the minimum feature size that can be deposited using semiconductor processing techniques) to fit more circuits onto a given chip size. The size of FPD pixels is fixed by the resolving capability of the

human eye, and larger overall display sizes (containing more pixels) are the goal for FPD design and manufacturing.

### ***Spillover in Production***

While they share equipment, materials, and some process steps, the economics and market sizes of FPD manufacturing are different from those in semiconductor device manufacturing. Semiconductors are generally fabricated on silicon wafers in sets of roughly 100 chips. Each is about one centimeter across, can be tested before final packaging, and has little value in its unpackaged state. FPDs are fabricated on glass substrates that must have high surface quality and are larger, more fragile, and more temperature-sensitive than silicon. For laptop-size screens, six finished display panels are typically yielded from each substrate; each must be nearly completed before testing, and represents a significant investment in materials and process time. As the direct spillovers between the two types of manufacturing are limited, separate corporate divisions and facilities are used for FPD and semiconductor manufacturing.

One exception to the differences in the two manufacturing processes is the digital micromirror device developed by Texas Instruments. In this display, miniature mirrors that are deposited as a part of an IC chip reflect light to form an image. The device is fabricated on standard semiconductor lines, and circuit elements are created along with the mirror array. In this case, there are direct spillovers between IC and FPD production processes.

## **NATIONAL SECURITY REQUIREMENTS**

Although the military demand for FPDs comprises a small part of the overall display market, military applications use a variety of FPD technol-

---

<sup>44</sup> For example, Applied Materials Corp. developed a prototype production system for 300-millimeter integrated circuit substrates based on its FPD production tool. See Walter Andrews, "Equipment Vendors Gear Up for 300-Millimeter Wafers," *Electronic News/VLSI Research Report*, July 17, 1995.

<sup>45</sup> See Chappell Brown, "Polysilicon TFTs Used in E<sup>2</sup>PROM Operation," *Electronic Engineering Times*, Nov. 21, 1994, p. 37; "Amorphous Silicon Shows Promise," *Electronic Engineering Times*, June 5, 1995, p. 39; and "ALE Process Resurfaces," *Electronic Engineering Times*, Feb. 27, 1995, p. 37.

ologies and have a wide range of requirements. In many cases, intensive design and *ruggedization* of FPDs (see box 2-3) are necessary to assure adequate performance in military environments. For platforms facing less stringent environments, existing commercial products may offer sufficient performance.

In general, DOD has three options for acquiring displays. It can purchase custom FPDs from domestic producers, commercial FPDs from domestic producers, or commercial FPDs from foreign producers. Currently, DOD relies on a combination of domestic custom and foreign commercial displays. The commercial displays are much less expensive, but require more ruggedization than custom FPDs.

Military programs base their choices of display on mission requirements and available budgets. The tradeoffs between commercial and custom displays for military applications center on price and performance; this issue is of particular importance for AMLCDs used in aircraft cockpits.

There is a sharp debate over the suitability of commercial AMLCDs in DOD applications; while some see custom AMLCDs as prohibitively expensive, others are not convinced that commercial displays can provide adequate performance. Currently, several programs are using foreign-produced commercial AMLCDs. Cost constraints are the primary factor in these decisions. However, some programs have utilized greater flexibility in AMLCD selection by determining requirements from the specific operational environment of the application, rather than from Military Specifications.

As AMLCD technology is adopted for increasingly demanding commercial applications such as avionic and automotive displays, the performance of commercial products will be better suited for

military needs. As custom suppliers move into these markets and gain manufacturing experience, their costs will decrease. These two trends suggest a convergence of military and some commercial FPDs, particularly in AMLCDs.

## ■ Military FPD Applications

Military systems use several different FPD technologies (see table 2-6). To date, military FPDs have been used mostly in portable computers, handheld devices, and large area displays on submarines and surface ships. Cockpit avionics is likely to be the next major application for FPDs.<sup>46</sup>

The fundamental technologies used in military FPDs are the same as in the commercial market. However, military displays differ in the size and shape of the display, and the need to adapt the display to extreme operating environments, including a wide range of temperatures, ambient lighting, and shock. Military display manufacturers must produce design-intensive products specific to military systems. These characteristics do not give the manufacturer experience in commercial, large-scale manufacturing. Contractors that ruggedize and integrate standard commercial products into military systems perform very specialized steps to enhance and protect the basic display (see box 2-3).

### *Battlefield Systems*

One group of military display applications is portable battlefield information and communication systems, which include portable and vehicular applications. There are more than 25,000 AMLCD portable computers and PMLCD handheld devices in the military.<sup>47</sup> More than 5,000 handheld terminal units with alphanumeric PMLCDs are used by forward observers for targeting calcula-

<sup>46</sup> For purposes of this section, discussion of military FPDs is limited to applications in military systems, rather than in standard office equipment.

<sup>47</sup> Roger Johnson, Senior Vice President, Science Applications International Corp., San Diego, CA, personal communication, July 13, 1995; since the early 1990s, AMLCDs have increasingly displaced EL and PMLCDs in these portable systems.

**BOX 2-3: Ruggedization**

Converting a flat panel display for use in a military system—which involves enhancing the integrity of the display to withstand extremes of temperature, shock, and vibration—is called *ruggedization*. The nature of ruggedization depends on the display technology used, the nature of the system, and its operating environment. Electroluminescent and plasma displays, for example, are much more resistant to shock and temperature variations than are liquid crystal displays LCDs. Some systems, such as field-test equipment, are neither mission critical nor continuously exposed to strenuous conditions, others are, such as a tank commander’s tactical display. One of the most demanding applications is a cockpit avionics display.

Cockpit displays must be readable in direct sunlight and resistant to large variations in temperature. In addition, some applications require that the display be compatible with Night Vision Imaging Systems.<sup>1</sup> The active matrix LCD (AMLCD) is the primary type of cockpit flat panel display, due to its exceptional performance in direct sunlight. However, this performance comes with a tradeoff: LCDs only perform well in a limited temperature range, thus requiring additional ruggedization to allow them to operate under temperature extremes.<sup>2</sup>

Both commercial and custom AMLCDs require a large amount of ruggedization, typically including heaters, redundant backlights, electromagnetic interference filters, shock- and vibration-resistant packaging, and drivers, polarizers, and electronic connectors capable of withstanding wide variations in temperature and humidity (see table below).

**Means of Achieving Rugged Features in Active Matrix Liquid Crystal Displays**

<b>Feature</b>	<b>Achieved in display by</b>	<b>Achieved in external modification by</b>
Brightness	larger aperture design	brighter backlight
Redundant light source	n/a	redundant backlight
Sunlight readability	black matrix and AR coatings	antireflective coatings
Driver integrity	chip on glass	stronger driver interconnects
Viewing angle	thinner cell	collimators and diffusers
Shock resistance	unit integrity by design	reinforcing LCD unit; covering glass
Vibration resistance	unit integrity by design	reinforcing LCD unit; covering glass
Cold resistance	liquid crystal materials	heaters on glass
Heat resistance	liquid crystal materials and polarizers	thermal design and extended temperature polarizers
Humidity resistance	bonding	bonding
Sand/dust resistance	bonding	bonding, filters, housing

SOURCE: Office of Technology Assessment, 1995, based on interviews with manufacturers and Integrators

(continued)

<sup>1</sup>This feature requires that pilots using monochrome night vision be able to distinguish levels of shading. The current requirement is for 64 levels, most commercial and some military AMLCDs have achieved 256 levels.

<sup>2</sup>Low temperatures affect LCDs primarily in two ways: 1) a reduction in response time and color gamut shift necessitates the need for heaters and programmable look-up tables, and 2) the backlight required for an LCD-based display must incorporate heaters in order to turn on at cold temperatures. In addition, liquid crystal materials and polarizers often suffer irreversible damage at temperatures above 90 °C.

## BOX 2-3: Ruggedization (Cont'd.)

Ruggedizing a commercial AMLCD involves activities almost entirely external to the display itself.<sup>3</sup> Because many of the firms that ruggedize commercial displays use the same processes for military and commercial systems, they amortize costs across a large volume of units. For a custom AMLCD, ruggedizing is partially achieved through the design and fabrication process, but external modifications are still necessary. Although they use displays designed for military use, many firms that ruggedize custom displays do so in low volumes, resulting in higher costs for ruggedization for military use. Despite the greater amount of ruggedization necessary for a commercial display, the LCD unit itself accounts for between one-fifth and one-third of the finished display price in both custom and commercial displays, given the price premium for a custom display, ruggedized custom displays are quite expensive.<sup>4</sup>

However, custom AMLCDs are expected to deliver superior performance, largely through their ability to withstand extreme environments. Some in industry and the military argue that ruggedized commercial displays still will not withstand severe conditions experienced in some applications. The failures of polarizer adhesives in high humidity and liquid crystal materials in very high temperatures are the most frequently cited problems. Inexpensive commercial displays could have shorter life cycles, boosting costs for redesign and replacement over those of custom AMLCDs that are likely to last longer.<sup>5</sup>

However, some argue that extreme conditions are experienced only on rare occasions or only in high performance aircraft and can be addressed by modifications to operational procedures or system requirements. Many other military applications, in aircraft and other systems, do not have such severe operational environments and could use commercial off-the-shelf displays.<sup>6</sup> Commercial AMLCDs lead or equal their custom counterparts in several areas important to ruggedization, including use of a black matrix, chip-on-glass technology, and low-temperature-resistant liquid crystal materials.<sup>7</sup> In addition, a reduced design life using a ruggedized commercial display may actually be less costly and allow newer technology to be incorporated into platforms sooner. Finally, as the commercial market expands to address the needs and harsher conditions seen in the portable and automotive products, the level of ruggedization required for a commercial display will diminish.

SOURCE Office of Technology Assessment, 1995.

<sup>3</sup>Randall E. Orkis, "F-16 Retrofit Application Using a Modular Avionics System Architecture and Color Active Matrix Liquid Crystal Displays," *SPIE International Symposium on Optical Engineering in Aerospace Sensing, Cockpit Displays Conference*, April 1994, and "An Improved Full Color F-16 A/B and F-16 C/D Multi-Function Display Using a Ruggedized COTS Active Matrix Color Liquid Crystal Display," *SPIE International Symposium on Aerospace/Defense Sensing and Dual Use Photonics: Cockpit Displays II*, April 1995.

<sup>4</sup>Firms that ruggedize commercial AMLCDs available for \$1,000 to \$4,000 charge from \$5,000 to \$20,000 for the finished system. To ruggedize a custom display costing approximately \$12,000, the system price is in the range of \$35,000 to \$50,000. Increasingly, custom display manufacturers and integrators are pursuing commercial options to help reduce costs, Dan Doyle, Director of Display Products, Electronic Designs Inc., Westborough, MA, personal communication, Aug 3, 1995.

<sup>5</sup>James Moore, Naval Air Defense Center (Ret.), Warminster, PA, personal communication, July 5, 1995, Keith Toby, F/A-18 Avionics Team Leader, Naval Air Warfare Center, Indianapolis, IN, personal communication, July 5, 1995, and Curtis Casey, Vice President, Optical Imaging Systems, Northville, MI, personal communication, July 14, 1995.

<sup>6</sup>Donald Pinsky, Interstate Electronics (Ret.), Costa Mesa, CA, personal communication, May 2, 1995, Roger Johnson, Senior Vice President, Science Applications International Corp., San Diego, CA, personal communication, July 13, 1995, Gary Broderson, Senior Electrical Engineer, Advanced Concepts, Naval Air Systems Command, Arlington, VA, July 17, 1995, Dan Hamilton, Ogden Air Logistics Center, Hill AFB, UT, personal communication, June 27, 1995, and Randall E Orkis, Principal Research Scientist, National Security Division, Battelle Memorial Institute, Columbus, OH, personal communication, May 5, 1995.

<sup>7</sup>A black matrix within the LCD unit enhances sunlight readability, chip-on-glass technology improves line driver interconnects and active area size of the whole display. Automotive displays now available from Sharp Corp have these features, Randall E Orkis, Principal Research Scientist, National Security Division, Battelle Memorial Institute, Columbus, OH, personal communication, July 25, 1995.

**TABLE 2-6: Flat Panel Display Applications and Technologies in Military Systems**

<b>Military system</b>	<b>Display applications</b>	<b>Potential display technologies</b>
Avionics	Cockpit displays in fixed-wing and rotary aircraft	AM LCD
Vehicular/shipboard	Navigation, situation, and weapons displays in tanks, ground vehicles, ships, and submarines	AMLCD, EL, Plasma
Portable	Helmet mounted displays, laptops, handheld devices, test equipment, communications equipment	AMLCD, PMLCD, EL
Workstations and presentations	Command and control displays, large tactical and map displays, simulation and 3-D systems	AMLCD and DMD projectors, Plasma

KEY: AMLCD = active matrix liquid crystal display; DMD = digital micromirror device, EL= electroluminescent display; LCD = liquid crystal display, PMLCD = passive matrix liquid crystal display

SOURCES: Len Zuga, *U.S. Military Display Markets: New Technologies, Upgrades, and Government Funding Brighten Market*, Report 5207-16 (Mountain View, CA: Frost & Sullivan, 1995), and Office of Technology Assessment, 1995

tions and communication, for example.<sup>48</sup> Such devices are lightweight, consume little power, and are relatively inexpensive. AMLCDs are used in portable computers for test and maintenance equipment; the Army has used 13,000 ruggedized portable computers in its Lightweight Computer Unit (LCU) program, which provides test, maintenance, and diagnostic units for tanks and aircraft. A commercial AMLCD, purchased from a foreign manufacturer, is being used for the LCU screen.<sup>49</sup> Ruggedization appears to have been satisfactory for these LCUs; because field units can be replaced easily, there are no major concerns regarding their failure.<sup>50</sup>

Several programs have been examining the suitability of AMLCDs, plasma panels, and EL displays for vehicular applications. Mobile multiple launch rocket targeting systems, which require large, rugged screens, have used EL and plasma displays. In the future, vehicular FPDs will display various video motion and graphic images in trucks, tanks, and ships, including infrared vision enhancement, fire control, and targeting data.

Given the similarities to conditions that avionic systems are exposed to (high temperatures and bright ambient light), the AMLCD is currently the leading contender. Examples include the Driver Vision Enhancement and the Commander's Tactical Display for the Bradley Fighting Vehicle. Plans call for individual soldiers to wear helmet-mounted displays (HMDs) that use small, very-high-resolution AMLCDs or possibly active matrix EL displays. HMDs are high performance devices that will likely require custom manufacture; several domestic companies are developing this technology.

### ***Large Area Displays***

Large area workstation displays in aircraft, surface ships, submarines, and stationary positions (such as the Airborne Warning and Command Systems (AWACS) situation displays and Sea-wolf submarine sonar displays) are used for a wide range of logistical, tactical, and surveillance tasks.<sup>51</sup> There are approximately 15,000 large area displays, typically 20 inches or larger; these

<sup>48</sup> Al Rodriguez, product Manager, LCU Program, Fort Monmouth Army Base, NJ, personal communication, July 28, 1995.

<sup>49</sup> Ibid.; the first 3,000 units used monochrome PMLCDs; the remainder have used color AMLCDs.

<sup>50</sup> Ibid., and Johnson, op. cit., footnote 47.

<sup>51</sup> With 14 CRTs on each plane, the AWACS fleet alone constitutes approximately 500 displays; Robert Zwitich, System Engineer, Product Support Division, Warner Robins Air Logistics Center, Warner Robins AFB, GA, personal communication, June 28, 1995.



*Military flat panel displays, such as this tactical map display must be designed or modified to withstand the adverse conditions imposed by military environments.*

displays could use several different FPD technologies.<sup>52</sup> Replacing bulky CRTs with FPDs in these platforms will reduce weight, space, and costs. To date, several hundred large area FPDs have been fielded; these have mostly employed EL and plasma displays because of their light weight, compact design, scalable screen sizes, and high resolution, although projection displays are also used.

Very large area displays are used for presentations, briefings, and strategic map displays in command and control rooms like those at the North American Air Defense Command (NORAD). Direct view plasma panels and projection systems, using small FPDs such as Kopin's Smart Slide

AMLCD or Texas Instrument's Digital Micromirror Device (DMD), are contending technologies for this group.

### ***Cockpit Avionics***

Military avionics demands higher performance and greater reliability than most other applications. Avionic displays present critical flight, targeting, and communications information to the pilot in harsh environments. As FPDs enable multiple functions to be performed by a single display, their performance becomes even more crucial to mission success and pilot survival. Even within avionics, however, the variety of platform types creates a range of operational environments and necessary display features. High performance, bubble canopy fighters require displays that: 1) can be read in very high ambient light; 2) are exposed to very high, direct sunlight heat (over 90 °C); and 3) can endure the shock, vibration, and stress of high altitudes, radical maneuvering, and combat. Transport planes and many helicopters operate in much less demanding environments; lower ambient light, altitudes, and temperature ranges relax conditions imposed on the display. Wider viewing angles for side-by-side pilots in such platforms are more important than in fighter aircraft.

The services have nearly 7,000 existing fixed wing aircraft and about 2,000 helicopters, each with multiple displays. In total, the potential market for retrofits exceeds 25,000 displays. Sincerefitting an aircraft is usually spread out over several years, this may result in an annual demand of a few thousand displays.<sup>53</sup> Given the high ambient light conditions in cockpits-and the requirement for video rate, full color, and high

<sup>52</sup>Randall E. Orkis et al., "A Full Color, High Resolution, 21" Common Large Area Display Set To Replace 19" CRTs in Several USAF<sup>4</sup> Applications," *1995 SPIE International Symposium on Aerospace/Defense Sensing and Dual Use Photonics Cockpit Displays II*, April 1995; Ted Klapka, Deputy Assistant Program Manager for Systems Engineering for P-3C, Maritime Surveillance Aircraft Program Office, Arlington, VA, personal communication, July 13, 1995.

<sup>53</sup>David E. Mentley, "Flat Panel Displays for Military Airplanes," *International Display Report*, Stanford Resources, Inc., San Jose, CA (distributed electronically by SEMI Newsletter Service), July 15, 1994; Darrel G. Hopper and Daniel D. Desjardins, "Requirements for AMLCDs in U.S. Military Applications," *SPIE International Symposium on Aerospace/Defense Sensing and Dual Use Photonics: Cockpit Displays II*, vol. 2462, April 1995, table 1.

TABLE 2-7: Examples of Active Matrix Liquid Crystal Displays in Current Military Programs

Military platform	Ruggedizer/ integrator	AMLCD source	Program status
Portable Systems			
Light computer unit (Army)	SAIC	Hitachi	approximately 13,000 delivered
Helmet mounted display (ARPA)	Hughes	Kopin	prototype
Vehicular/Shipboard			
Aegis fire control (Navy)	EDI	Sharp	approximately 25 delivered
Commander's tactical display (Bradley, Abrams)	Litton	Litton	prototypes
Driver vision enhancement (Bradley)	Interstate	Hosiden	operations testing
Avionics			
F-1 8 (Navy)	Kaiser	OIS	engineering/development
V-22 (Navy)	Kaiser	OIS	engineering/development
CH-46 (Marines)	Allied-Signal	OIS	operations testing
C-130H CGR (Air Force)	Grimes	Sharp	approximately 300 produced
UH-1 N (Navy)	Grimes	Sharp	operations testing
SH-60B (Navy)	Loral	DTI	n/a
F-1 6 CGR (Air Force)	EDI	Sharp	operations testing
RAH-66 (Army)	Litton	Litton	operations testing

KEY: AMLCD = active matrix liquid crystal display; ARPA = Advanced Research Projects Agency; CGR = Combined Air National Guard and Reserve; DTI = Display Technology, Inc.; EDI = Electronic Designs, Inc.; OIS = Optical Imaging Systems; SAIC = Science Applications International Corp.

SOURCE: Office of Technology Assessment, 1995, based on personal communications with defense contractors and military program offices

resolution avionics displays—AMLCDs appear to be the best technology currently available to replace aging CRTs and electromechanical instruments.

### ■ Custom and Commercial AMLCDs: Choices and Convergence

There is much debate over the cost of custom AMLCDs and the suitability of commercial products for military applications, particularly in avionics. Custom FPDs offer reliable, high-quality performance in severe environments. However, commercial displays offer an affordable and often adequate solution for many programs, given sufficient ruggedization (see box 2-3). Although prices vary across applications, finished displays manufactured specifically for high performance avionics applications typically cost roughly three

times as much as ruggedized commercial displays.<sup>54</sup> in many instances, custom AMLCDs offer superior performance: greater resolution, wider viewing angle, and greater environmental integrity. in others, commercial technology is still ahead—in areas such as grayscale and chip-on-glass interconnects—although custom units do conform to military requirements. in general, custom displays deliver greater performance and reliability than commercial units, but at a much higher price. This is the basic tradeoff faced by military programs. The choices made differ from program to program (see table 2-7).

Program choices reflect immediate needs, budgetary constraints, and operational missions and environments of their platform. Many older aircraft, especially those in the Air Force Reserve and Air National Guard (known as the Combined

<sup>54</sup> Johnson, op. cit., footnote 47; Randall E. Orkis, Principal Research Scientist, National Security Division, Battelle Memorial Institute, Columbus, OH, personal communication, May 5, 1995; Dan Doyle, Director of Display Products, Electronic Designs Inc., Westborough, MA, personal communications, May 22-24, 1995; and Klapka, op. cit., footnote 52.



## BOX 2-4: Commercial Avionics and Automotive Displays

With niche markets in avionics and automotive displays emerging, commercial manufacturers are developing active matrix liquid crystal displays (AMLCDs) distinct from those used in consumer products such as notebooks and personal digital assistants (PDAs). In order to operate under conditions including high ambient light, vibration, shock, and extreme temperature variations, displays for avionics and automotive applications must perform at higher levels than commercial off-the-shelf versions. Several Japanese manufacturers are selling AMLCDs specifically designed for these applications. Sharp produces a 4-inch automotive display that is being used in Delco products for police vehicles.<sup>1</sup> This AMLCD offers an operational temperature range from -30°C to +85 °C, a black matrix to improve sun-light readability, and vibration and shock resistance superior to its other displays.<sup>2</sup> FPD Co. of Europe is selling automotive displays to BMW.<sup>3</sup> Hyundai's investment in ImageQuest of California may allow it to offer AMLCDs in its automobiles.

Commercial avionics producers also use commercial AMLCDs. Hosiden supplied most of the displays to Honeywell for the Boeing 777 cockpit, and several firms, such as Toshiba, supplied the 3-inch AMLCDs for Traffic Collision Avoidance Systems required by the Federal Aviation Administration on all commercial jets.<sup>4</sup> Optical Imaging Systems has worked with several avionics companies, including Allied-Signal and Meggitt of Britain, to develop commercial avionics; its 5ATI (4- by 4-inch active area Air Transport Indicator) is used in several hundred Federal Express aircraft. Litton Systems of Canada is supplying multifunction AMLCDs for the Lockheed C-130J, an aircraft designed for commercial and military use.<sup>5</sup>

SOURCE: Office of Technology Assessment, 1995.

<sup>1</sup>Steven Shields, Senior Scientist, Hughes Aircraft Co., Carlsbad, CA, personal communication, May 10, 1995, Sharp Electronics Exhibition, Society for Information Display (SID) Conference, Orlando, FL, May 22-24, 1995

<sup>2</sup>Sharp Electronics, *ibid.*; Randall E. Orkis, "An Improved Full Color F-16 A/B and F-16 C/D Multi-Function Display Using a Ruggedized COTS Active Matrix Color Liquid Crystal Display," *SPIE International Symposium on Aerospace/Defense Sensing and Dual Use Photonics: Cockpit Displays II*, April 1995, p. 5.

<sup>3</sup>Robert Gray, Product Engineer, FPD Co., San Jose, CA, personal communication, June 5, 1995

<sup>4</sup>James Byrd, Technical Specialist, Cockpit Control Displays, Aeronautical Systems Center, Wright-Patterson AFB, OH, personal communication, June, 19, 1995; Curtis Casey, Vice President, Optical Imaging Systems, Northville, MI, personal communication, July 14, 1995.

<sup>5</sup>Van Angelo, Manager, Business Development, Displays, Litton Systems Canada Ltd., Etobicoke, Ontario, personal communication, May 4, 1995.

Guard Reserve, or CGR), face reliability and maintainability problems; these programs need immediate (often stop-gap) replacements to keep their planes operational. Such programs also have small budgets for these retrofits. In reserve, defensive, and transport missions, aircraft are not as likely to face intense battle or flight conditions as

are active duty and combat aircraft. High costs and the lack of certain features (such as gray levels sufficient for contrast in night vision conditions) dissuaded the CGR from using custom FPDs for its recent retrofit. Ruggedized automotive displays from Sharp Corp. (see box 2-4) are currently in operational testing and evaluation for the CGR.<sup>55</sup> At

<sup>55</sup>The Combined Guard Reserve has chosen a ruggedized commercial AMLCD for several F-16 and C-130H air wings; Dan Hamilton, Ogden Air Logistics Center, Hill AFB, UT, personal communication, June 27, 1995, and Orkis, *op. cit.*, footnote 54; Randall E. Orkis, "An Improved Full Color F-16 A/B and F-16 C/D Multi-Function Display Using a Ruggedized COTS Active Matrix Color Liquid Crystal Display," *SPIE International Symposium on Aerospace/Defense Sensing and Dual Use Photonics: Cockpit Displays II*, April 1995, p. 4.

least two other programs, the Navy's UH-1N and the P-3C, have also selected ruggedized commercial AMLCDs.<sup>56</sup> Rockwell-Collins, the only contractor to bid on the UH-1N using a custom domestic FPD, was informed that it lost the contract because of price.<sup>57</sup>

Other programs, such as the F-22, RAH-66, and F-18, involve both new and retrofitted aircraft whose operational environments impose adverse conditions. Aircraft with bubble canopies that fly high altitude combat missions place high demands on display integrity and performance. Programs with these requirements and—for new aircraft—larger development budgets have chosen custom displays. The foreign sales program of F-16s to Europe and Taiwan is currently undergoing a mid-life upgrade and is evaluating custom AMLCDs produced by Optical Imaging Systems (OIS); this evaluation may impact the choice for the Air Force's active duty F-16s and F-15s.<sup>58</sup>

Some high performance aircraft programs are also drawing on trends in the commercial avionics

market. The CH-46 program took advantage of a commercial avionics display developed by OIS and Allied-Signal (see box 2-4); redesign costs were limited to driver attachment, bonding, and packaging.<sup>59</sup> As more standard commercial products emerge, military programs that make use of them will save thousands of dollars by avoiding nonrecurring engineering costs for unique designs and production.<sup>60</sup> The military increases these benefits by designing and adapting common display units and requirements for multiple platforms.<sup>61</sup>

AMLCD choices available to military programs have been facilitated by DOD initiatives and supporting legislation. The Perry Memo of June 29, 1994, and the Federal Acquisition Streamlining Act (FASA) of 1994 require program offices to justify the use of military specifications and afford them more freedom to draw from industry design, standards, and products when procuring display systems.<sup>62</sup> The Active Matrix Liquid Crystal Cockpit Display project,

<sup>56</sup> Bob Lehman, Naval Air Warfare Center, Warminster, PA, personal communication, June 27, 1995. The 6- by 8-inch display for the P-3 is one of many retrofits to that aircraft, several of which are using domestic custom displays; Klapka, op. cit., footnote 52.

<sup>57</sup> Michael McDonald, Marketing Manager, Rockwell-Collins Avionics and Communications, Cedar Rapids, IA, personal communication, July 14, 1995; recognizing that, for many programs, the primary constraint is on price, Rockwell-Collins has decided to switch to commercial FPDs for future bids.

<sup>58</sup> Tom Liberio, Avionics Engineer, F-15 Program Office, Avionics Systems Center, Wright-Patterson AFB, OH, personal communication, July 20, 1995; James Byrd, Technical Specialist, Cockpit Control Displays, Aeronautical Systems Center, Wright-Patterson AFB, OH, personal communication, June 19, 1995; Orkis, op. cit., footnote 54.

<sup>59</sup> Bob Mack, Naval Air Warfare Center, Warminster, PA, personal communication, June 26, 1995; Chris Mulford, Marketing Department, Commercial Avionics Systems, Allied-Signal Inc., Miami, FL, personal communication, July 12, 1995; Curtis Casey, Vice President, Optical Imaging Systems, Northville, MI, personal communication, July 14, 1995. The display may also be used in a P-3 retrofit; Klapka, op. cit., footnote 52.

<sup>60</sup> Dimensions of 6- by 8-inches, 4- by 4-inches, and 3- by 3-inches are becoming standard sizes for commercial avionics; McDonald, op. cit., footnote 57.

<sup>61</sup> The CGR hopes to use avionics developed for its F-16 retrofits for its A-10s and C-130s; Hamilton, op. cit., footnote 55. The Common Displays Program, part of the Air Combat Electronics Program Office, works jointly with program offices (currently with the AV-8 and F-18) to acquire common avionics for multiple platforms; Harlan Smith, Air Combat Electronics Program Office, Common Displays Program, Naval Air Warfare Center, Indianapolis, IN, personal communication, July 17, 1995. See also Darrel G. Hopper et al., "Draft Standard for Color Active Matrix Liquid Crystal Displays (AMLCDs) in U.S. Military Aircraft: Recommended Best Practices," WL-TR-93-1177, Avionics Directorate, Wright Laboratory, Air Force Materiel Command, Wright-Patterson AFB, OH, June 1994.

<sup>62</sup> William Perry, Secretary of Defense, *Memorandum for the Secretaries of the Military Departments, Subject: Specifications and Standards—A New Way of Doing Business*, June 29, 1994; Federal Acquisition Streamlining Act, Public Law 103-355 (Oct. 13, 1994); see also U.S. Congress, Office of Technology Assessment, *Assessing the Potential for Civil-Military Integration: Technologies, Processes, and Practices*, OTA-ISS-611 (Washington, DC: U.S. Government Printing Office, September 1994).

under Title III of the Defense Production Act (see chapter 3), provides funds to program offices to offset the cost of custom AMLCDs.

Another trend that blurs the distinction between custom and commercial displays is the emergence of niche markets for higher performance commercial AMLCDs. Increasingly, FPD manufacturers that sell to low-volume avionics markets, such as OIS and Litton Systems Canada, are working more closely with commercial manufacturers and markets to reduce the cost of custom units (see box 2-4). While some unit prices of custom displays in production volume have dropped nearly 50 percent, they are still at least twice the price of commercial displays.<sup>63</sup> Concomitantly, several high-volume producers are developing displays specifically for more rugged automotive and avionics environments. As custom producers look for commercial opportunities and solutions—and as commercial producers look to niche markets—the products, their performance, and their suitability for applications will converge.

The fact that programs have arrived at divergent solutions to meet their display requirements suggests that no FPD exhibits superiority. Very high performance platforms, such as the F-22 and the Space Shuttle, require very durable displays with redundant features and custom design; commercial displays may be adequate for reserve aircraft and transports. Yet the vast majority of military aircraft—fighter jets, bombers, and helicopters—lies between these two extremes. The

distinction is not unique to aircraft. The Driver Vision Enhancement Program plans to introduce an inexpensive, infrared video display system for tanks and trucks. Contractors have been encouraged to keep costs low and use commercial products.<sup>64</sup> The Commander's Tactical Display for the Bradley Fighting Vehicle, however, is a high performance, multifunction display providing the user with crucial mission information; to date, this program has considered only a custom display.<sup>65</sup>

Custom manufacturers and some program offices are concerned that although ruggedized commercial FPDs have low up-front costs, their performance may not hold up, potentially imposing greater costs through shorter life cycles.<sup>66</sup> Others counter that, with ruggedization and maintenance, commercial displays provide excellent performance without the high cost of custom units.<sup>67</sup> Shorter life cycles, coupled with modular architecture, could allow for less expensive retrofits to introduce newer display features, which continue to be led by the commercial sector.<sup>68</sup>

Military programs are testing and evaluating both commercial and custom AMLCDs. At the same time, niche markets in avionics are pursued by both custom and commercial manufacturers. Over the next few years, DOD will be able to determine how well commercial displays hold up in military platforms, and custom manufacturers such as OIS, Litton, and ImageQuest will compete in commercial markets with high-quality displays.

<sup>63</sup> OTA interviews with program officers revealed that during 1994, the unit price (in production volumes) of custom avionics FPDs from a domestic manufacturer was approximately \$10,000 to \$12,000, while a commercial off-the-shelf unit cost between \$3,000 and \$4,000; by mid-1995, some custom FPDs cost approximately \$6,500, while commercial prices vary between \$1,000 and \$4,000 (prices do not include ruggedization and integration costs).

<sup>64</sup> Chuck Daz, DVE Program Representative, Texas Instruments, Dallas, TX, personal communication, July 28, 1995.

<sup>65</sup> *Ibid.*; Van Angelo, Manager, Business Development, Displays, Litton Systems Canada Ltd., Etobicoke, Ontario, personal communication, May 4, 1995.

<sup>66</sup> Casey, *op. cit.*, footnote 59; James Moore, Naval Air Defense Center (Ret.), Wallington, PA, personal communication, July 5, 1995.

<sup>67</sup> Doyle, *op. cit.*, footnote 54; Hamilton, *op. cit.*, footnote 55; Orkis, *op. cit.*, footnote 54.

<sup>68</sup> Orkis, "An Improved Full Color F-16 A/B and F-16 C/D Multi-Function Display Using a Ruggedized COTS Active Matrix Color Liquid Crystal Display," *op. cit.*, footnote 55.

# Strategies and Policies for the Domestic Flat Panel Display Industry 3

The U.S. flat panel display (FPD) industry is currently comprised of a number of relatively small and innovative firms that carry out leading-edge research, some prototype development, and manufacturing for niche and custom markets. With the exception of some low-information-content FPD manufacturing, however, there is no domestic mass manufacturing for commercial markets.

U.S. firms have developed many of the basic FPD technologies. The innovations in product development and manufacturing processes, however, have come largely from Japan, where large electronics firms have led in the commercialization of the FPD. Historical factors loom large in the domestic FPD industry's weak presence in manufacturing, largely in the form of decisions made by U.S. firms (mostly to stay out of manufacturing) and Japanese companies (to invest heavily in manufacturing). Another factor has been the role of government programs, which have sustained an innovative industry, but oriented it toward technologies and market sectors outside the commercial mainstream.

Some observers advocate public and private investments in active matrix liquid crystal display (AMLCD) manufacturing to catch up to Japanese companies. However, the enormous capital costs required by AMLCD manufacturing, and the commanding lead Japanese firms have in production technologies, lead others to suggest a leapfrog approach that entails pursuing a technology that can displace AMLCDs. Still others argue that many FPD types will become commodities, and, like dynamic random access memory chips, will be plentiful on the world market. They advocate placing an emphasis on technologies that are established and in which U.S. firms are already competitive in small,

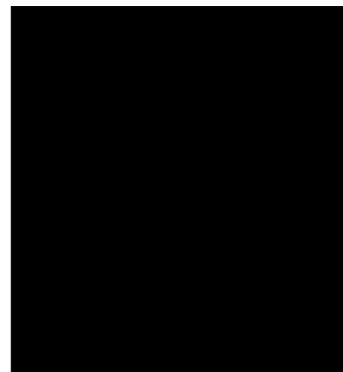

niche markets. These approaches—emphasizing catch-up, leapfrog, or established technologies—are based on different assumptions and imply different roles for the private sector and government.

Three decades of research into display technology by U.S. companies and laboratories have led to numerous approaches to displaying electronic information on a flat screen. The U.S. government, mainly through Department of Defense (DOD) research and development (R&D) programs, has been a source of support and a market for these innovations. Despite this activity, there has been limited manufacturing and few attempts to commercialize FPDs in the United States during the past 15 years. While U.S. companies have a presence in the defense and avionics markets, no firms manufacture FPDs domestically for the largest portion of the world market—portable computer displays—primarily because no firms have made the capital investments for large-scale FPD production.

The issues surrounding government support of FPD R&D and production have been debated in Congress and the executive branch for several years. A contentious trade case during 1990-93 created divisions within the industry and also drew attention to its condition. Previous Congresses have shown strong support for FPD research within DOD's Advanced Research Projects Agency (ARPA) High Definition Systems (HDS) program. In 1994, the Clinton Administration created the National Flat Panel Display Initiative, consolidating ongoing display R&D programs and offering cost-shared R&D support to firms that present a credible plan to manufacture displays for the commercial and defense markets. This initiative has drawn the FPD

issue into the larger debate over the role of government in technology commercialization.

## DOMESTIC EFFORTS TO COMMERCIALIZE FPD TECHNOLOGY

The commercialization of the AMLCD in the 1980s resulted from a convergence of two technologies that were several decades old. First, the existence of the liquid crystal phase of matter was identified in organic compounds by European scientists in the late 19th century; second, the concept of a switching device, constructed by layering thin films of semiconductors, was patented in the early 20th century. These ideas were ultimately combined in American laboratories in the 1970s in the form of an AMLCD. It was not until the 1980s, however, that the AMLCD was commercialized by a Japanese company.<sup>1</sup>

The liquid crystal state was first observed by the Austrian botanist Reinitzer in 1888, and named soon after by the German physicist Lehmann. They discovered that certain compounds had a transition state between the solid and liquid states that took the form of a cloudy liquid containing areas with crystal-like molecular structure. In 1911, the twisted-nematic structure, later to become the basis for the liquid crystal display (LCD), was described by the French scientist Mauguin. Work was carried out in the following decades in Europe and the Soviet Union, reaching a peak in the 1930s. The Marconi Wireless Telephone Co. received the first patent for a liquid crystal device—a light valve, or switch—in 1936. In the late 1950s, a research group led by James Fergason at the Westinghouse Research Laboratories discovered that liquid crystals could be used as temperature sensors. Finally, in the 1960s, the

<sup>1</sup> Useful references on the history of FPD development include: T. Peter Brody, "The Thin Film Transistor—A Late Flowering Bloom," *IEEE Transactions on Electron Devices*, vol. ED-31, No. 11, November 1984, pp. 1614-1628; David E. Sanger, "Invented in U.S., Spurned in U.S., A Technology Flourishes in Japan," *New York Times*, Dec. 16, 1990, p. 1; Richard Florida and David Browdy, "The Invention That Got Away," *Technology Review*, August/September 1991, p. 42; Joseph A. Castellano, *Handbook of Display Technology* (San Diego, CA: Academic Press, 1992); George H. Heilmeyer, "Reflections on Innovation and Invention," *The Bridge*, winter 1992, pp. 12-16; and Damian Saccocio, "Strategy & New Business Development: The Case of the Missing U.S. Display Industry," unpublished Ph.D. thesis, Rensselaer Polytechnic Institute, Troy, NY, May 1994.

accumulated scientific knowledge was put to use in electronic displays, leading to large amounts of new research in the field.

The concept for the thin film transistor (TFT) was patented in the United States in 1933, preceding the now-dominant field effect transistor. The TFT is a solid state device that allows current to flow in proportion to a control voltage; it is an amplifier. The TFT uses layers of thin film materials, rather than the bulk single crystal silicon of which integrated circuits are made. The first working device was developed in 1962 at RCA Laboratories, using a cadmium selenide semiconductor. In addition to RCA, groups at GE, Hughes, IBM, Raytheon, Zenith, Westinghouse, and Philips were devoted to TFT research in the 1960s. By 1970, partly due to the immature state of TFT technology, the field effect transistor became the dominant approach applied to integrated circuits, and only Westinghouse pursued research on TFT devices and applications.

At RCA, George Heilmeier and Richard Williams led research into the use of liquid crystal materials in electronic displays beginning in the early 1960s. The group discovered many of the basic principles underlying liquid crystals currently in use, and fabricated crude alphanumeric, graphic, and television displays. Active matrix displays, in which switches (typically TFTs) are deposited on the display glass to control individual picture elements (or pixels), were announced by another RCA group in 1971.

But translating research breakthroughs into products was much more problematic. While the central laboratory pursued basic research, the researchers failed to sell their discoveries to the application-oriented engineers and managers elsewhere in the company. The near-term markets were simple display applications in calculators, watches, and other commodity products that RCA and other large U.S. electronics firms were moving away from. Corporate management did articulate a vision of a “picture-on-the-wall” display. However, this was a distant goal and, to the extent it was possible, it may have threatened divisions

whose product expertise was based on the cathode ray tube (CRT). The product divisions did not support the research effort, and RCA canceled its efforts to commercialize LCD technology in the 1970s.

Westinghouse became involved in LCDs through the application of its thin-film transistor research and made a more extensive effort to commercialize LCD technology. As with RCA, however, the crucial commitment to manufacturing did not materialize. As a manufacturer heavily involved in both the semiconductor and television industries in the 1960s, Westinghouse had the right mix of capabilities to pioneer AMLCDs. It also had a vigorous proponent of AMLCDs in T. Peter Brody, whose research group was the first to report construction of a thin-film transistor AMLCD in the early 1970s. Demonstrations of active matrix electroluminescent (EL) panels followed the LCD work. A fully operational alphanumeric panel was developed in 1974, and a simple video display in 1978.

Internal support for display research was transferred several times during the 1970s. As the semiconductor devices groups at Westinghouse fell under the weight of competition from integrated circuits, they pulled support from the TFT research. Support was acquired from the consumer electronics divisions, which viewed LCDs as a way to reverse Westinghouse’s losses in television market share, until the firm left the television market in the early 1970s; another patron was found in the electron tube division, which was closed later in the 1970s. In 1979, the company shut down TFT and active matrix display research altogether.

The 1970s also saw the inception of firms dedicated solely to the development of liquid crystal and other display technologies. In 1969, James Fergason left Westinghouse and formed the International Liquid Crystal Co. There he invented the twisted nematic field effect (TN) LCD, which was to become the most common type of LCD. After delays in the filing, Fergason eventually received a patent for the invention in 1973. However, researchers at the Swiss firm, F. Hoffmann

LaRoche, had been carrying out similar work and published their results in 1971.<sup>2</sup> Finding it difficult to interest electronics companies that were using light emitting diodes for displays, and facing a court battle over ownership of the invention, Ferguson sold his patent to the Swiss firm.<sup>3</sup> During the 1970s, other companies formed to work with liquid crystal materials, including Optel, Princeton Materials Science, Microma, and Micro Display Systems, manufacturing such items as digital watch displays.

Japanese LCD production also began in the 1970s, following a path similar to their entry into electronics—from simple, low-cost devices to more complex systems, backed by consistent manufacturing investment. Starting with simple low-information-content displays, firms like Sharp Corp. (which began research on liquid crystals in 1968 and produced the first liquid crystal calculator display in 1973) learned how to manufacture more complicated matrix displays. They were then well positioned to capitalize on the growing demand for FPDs created by the development of portable computers and televisions in the 1980s.

The 1980s witnessed a rapid increase in AMLCD development. Several startup firms in the United States emerged as spinoffs of the canceled display programs of the large firms, but the activity was primarily among Japanese electronics firms. In 1983, Seiko-Epson demonstrated the first prototype AMLCD in a pocket television. The quality of the display triggered great interest in active matrix technology: more than 20 companies around the world demonstrated AMLCD prototypes in the period 1984 to 1991.<sup>4</sup> In addition to AMLCD developments, alternatives to the pas-

sive matrix LCD (PMLCD) were being developed that improved display performance without the use of active elements. In the early 1980s, researchers at the Brown Boveri Research Center in Sweden developed the supertwisted nematic (STN) LCD, which greatly improved the contrast and viewing angle of PMLCDs.<sup>5</sup>

Peter Brody left Westinghouse in the wake of the LCD program cancellation, and was able to attract enough venture capital to start a firm called Panelvision in 1980. Panelvision bought equipment from Westinghouse's TFT labs, and began developing a process for AMLCD production. In 1984, Panelvision became the first U.S. company to sell AMLCDs. However, it was unable to build a high-volume production capability, and thus could not make enough sales to break even. Panelvision raised \$13 million in venture capital during the early 1980s, which was not enough to build a plant. The firm's efforts to raise more capital were hindered by doubts among investors as to the company's ability to compete with the Japanese in manufacturing. In 1985, Panelvision's board of directors sold the firm to Litton Industries, which turned it into an aircraft cockpit display division and moved it to Canada.

Brody then sought support from U.S. computer companies for a startup to produce AMLCDs. While Apple showed interest, no computer company wanted to provide funding for such a costly undertaking, although IBM began funding internal R&D in AMLCDs in 1985. Most computer manufacturers did not consider it necessary to create a domestic base for display manufacturing; they were able to depend on Japanese firms, which were rapidly developing production capabilities for LCDs. In 1987, Brody turned to the idea of

<sup>2</sup> M. Schadt and W. Helfrich, "Voltage Dependent Optical Activity of a Twisted Nematic Liquid Crystal," *Applied Physics Letters*, vol. 18, No. 4, Feb. 15, 1971, pp. 127-128.

<sup>3</sup> Kathleen K. Wiegner, "It's a Damned Shame," *Forbes*, July 23, 1990, p. 277.

<sup>4</sup> W. E. Howard, "Thin Film Transistor/Liquid Crystal Display Technology: An Introduction," *IBM Journal of Research and Development*, vol. 36, No. 1, January 1992, pp. 3-10.

<sup>5</sup> T. J. Scheffer, and J. Nehring, "A New, Highly Multiplexable Liquid Crystal Color Display," *Applied Physics Letters*, vol. 45, No. 10, Nov. 15, 1984, pp. 1021-1023.

creating large (20- to 40-inch diagonal) AMLCD displays for the military market, with an eye toward future high definition television (HDTV) markets. The approach was to tile small AMLCDs together in a display larger than the current 10-inch models.

With funding from well-known technologists and the venture capital arm of Westinghouse, Brody founded Magnascreen in 1988. The firm marketed its technology to defense customers and, in 1988, was awarded a contract by ARPA (at that time DARPA) to develop a 45-inch display. Technical difficulties in creating tiled displays made progress difficult in this type of FPD. In addition, the growing presence of Japanese manufacturers in the LCD market, and their announcement of the Giant Technology Corp. effort to build a 40-inch AMLCD display by 1995 (later scrapped), deterred venture capital support for the Magnascreen project, and it has not entered commercial production.

The Panelvision and Magnascreen FPD programs were not the only ones to fall short in pursuit of commercial success during the 1980s. Small firms, many started by veterans of the canceled programs at the large electronics firms, opened and closed during the decade; among them were Alphasil, Crystal Vision, LC Systems, Plasma Graphics, and Sigmatron Nova. Many large companies closed or sold off flat panel programs, including AT&T, Control Data, Exxon's EPID and Kylex, GE, GTE, IBM, NCR, and Texas Instruments.<sup>6</sup>

Some of the closures resulted in successful startups. The closure of the Owens-Illinois plasma effort resulted in Electro-Plasma and Photonics Systems, both of which produce plasma displays; IBM's former plasma display division became Plasmaco; and Tektronix spun off Planar, a successful electroluminescent display firm. But none of these small companies has the financial resources and manufacturing experience of a major

electronics concern, and none has developed high-volume production of FPDs. Other domestic FPD operations were bought by foreign firms and transferred abroad: in addition to Panelvision (now part of Litton Systems Canada), GE's AMLCD operation was sold and moved abroad, and is now part of the French firm, Thomson LCD.

The commercialization of LCD technology demonstrates a pattern of early innovations and initial commercialization efforts at large electronics firms, followed by closure and/or spinoff of display operations to startup firms that encountered competition from large, integrated Japanese manufacturers. Domestic efforts to commercialize plasma displays (see box 3-1) and electroluminescent displays (see box 3-2) have been somewhat more successful. U.S. firms have a stronger position in these technologies than in the LCD-based displays, partially due to military demand, but neither technology accounts for more than a small part of the commercial market.

### STRATEGIES FOR MARKET ENTRY

At the beginning of the 1990s, the U.S. FPD industry consisted mainly of small, research-oriented firms that produced, if anything, small volumes of displays. The FPD market was still largely low-information-content devices, though screens for portable televisions and computers were being produced in Japan. FPD sales began to grow strongly in 1990, spurred by the boom in portable computers. The vast majority of this business was captured by Japanese FPD producers. A divisive dumping case caused further fragmentation within the U.S. FPD industry because it pitted different technical approaches to manufacturing FPDs—and the companies that championed the technologies—against each other. The case also drove a wedge between the fledgling domestic FPD industry and display users (computer

<sup>6</sup> U. S. Congress, Office of Technology Assessment, *The Big Picture: HDTV and High Resolution Systems*, OTA-BP-CIT-64 (Washington, DC: U.S. Government Printing Office, June 1990), table 5-1, p. 71.



## BOX 3-1: Commercialization of Plasma Displays

The use of the gas discharge effect for display purposes goes back as far as early demonstrations of television in 1927. The modern history of plasma displays began in the 1950s with the development of the Nixie tube, which displayed a single digit or character, and was the first nonmechanical electronic display device. The first demonstration of a plasma display was an alternating current (AC) display developed in 1964 at the University of Illinois. By the end of the 1960s, Owens-Illinois had commercialized the AC plasma display, which it called Digivue. Burroughs and Fujitsu made key innovations in AC plasma during the 1970s. The first direct current (DC) plasma displays were segmented displays developed in the 1970s to replace the Nixie tube. Later in the decade, dot-matrix versions were developed.

Military support of plasma research and development led to the first large displays (greater than one meter in diameter), developed by Photonics Imaging (a spinoff of the Owens-Illinois effort) in the early 1980s. Several large companies made attempts to produce plasma displays during the 1970s and 1980s, including IBM, Texas Instruments, and AT&T. The difficulties in making AC plasma displays at a low cost have shifted some of the emphasis in plasma R&D to DC versions. In 1993, the value of U.S.-produced plasma displays accounted for 22 percent of the world total; however, the entire plasma market accounts for approximately three percent of the overall flat panel display market.

SOURCES: Larry Weber, "Plasma Displays," in *Flat Panel Displays and CRTs*, Lawrence E. Tannas, Jr. (ed.) (New York, NY: Van Nostrand Reinhold, 1985); Larry Weber, "Plasma Displays," 1994 *SID International Symposium Seminar Lecture Notes* (Santa Ana, CA: Society for Information Display, 1994), vol. 1; and Damian Saccocio, "Strategy & New Business Development: The Case of the Missing U.S. Display Industry," unpublished Ph.D. thesis, Rensselaer Polytechnic Institute, Troy, NY, May 1994.

manufacturers) by forcing a choice over which industry to support—displays or computers.

The tensions over the dumping case did not begin to subside until 1993, when the last remaining FPD antidumping tariff was dropped and the United States Display Consortium (USDC) was formed (see box 3-3). Since that time, the trend has been toward greater cooperation among the industry (including FPD equipment and materials suppliers, manufacturers, and users), government agencies (primarily DOD), and academia. This cooperation has been a means by which the relatively small domestic display efforts can be combined. However, the domestic industry is still comprised of many small producers pursuing a host of display technologies, and there are no commercial high-volume manufacturing plants in the United States.

Appendix A gives a sense of the breadth of current FPD efforts in the United States. The industry is diverse and not easily categorized. In general, however, it is comprised of firms that are divisions of, or owned by, diversified firms and small firms that are dedicated to display production. Some of

these firms produce high- and low-information-content displays, but most pursue research or are in the development stage. What many companies do have in common, especially firms at the leading edge of technology, is support provided by government R&D contracts, primarily from ARPA, and involvement in display consortia (see box 3-3).

In general, the strategies used by or available to domestic FPD firms can be described by some combination of approaches that emphasize technologies to: 1) catch up, 2) increase established niches, or 3) leapfrog. Catch-up involves investing in and gaining manufacturing experience in AMLCDs. Several technologies are currently used to serve niche markets, such as plasma, EL, and some types of LCDs. Current candidates for leapfrog technologies are led by field emission displays and digital micromirror devices.

Regardless of the strategy, any attempt to enter into commercial high-volume manufacturing of FPDs will involve significant investment. If the investments made in Korea and Japan are an indication, the initial investment for an AMLCD

## BOX 3-2: Commercialization of Electroluminescent Displays

Electroluminescence was first observed by the French scientist Destriau in 1936, but did not attract much attention until the 1950s when lighting and display researchers began investigating the phenomenon. The difficulties of making bright, reliable electroluminescent (EL) displays caused most research groups to abandon EL research in the 1960s. A concerted effort to commercialize EL displays was made by Sigmatron. Despite having demonstrated several products, the company attracted little investment or market interest, and went out of business by the end of the 1960s. As with liquid crystal displays LCDs the 1970s saw dedicated efforts by Japanese firms to commercialize EL technology, and Sharp was a leader. Sharp's work resulted in a monochrome EL television demonstrated in 1978, spurring U.S. firms to revisit EL displays—with the support of Army research laboratories at Fort Monmouth, New Jersey, and Fort Belvoir, Virginia.

The year 1983 was a milestone in EL development. Sharp introduced the first commercial EL display product; Grid Computer introduced one of the first portable computers, which used a six-inch diagonal, 320- by 240-pixel EL display; and Planar was spun off from the Tektronix display division. EL displays are one of the few success stories for the U.S. flat panel display industry; in 1994, Planar held over 50 percent of the world market for EL displays. As a share of the total flat panel display market, however, EL displays are even smaller than plasma, accounting for only one percent.

SOURCES Joseph A. Castellano, *Handbook of Display Technology* (San Diego, CA Academic Press, 1992), p. 6, and Christopher N. King, "Electroluminescent Displays," 1994 *SID International Symposium Seminar Lecture Notes* (Santa Ana, CA Society for Information Display, 1994), vol. 1.

plant—the catch-up strategy—will entail at least \$400 million in capital costs, plus additional funding for upgrades. Since there is no manufacturing experience in leapfrog technologies, the investment required is difficult to estimate; however, some have estimated the cost of a field emission display plant to be \$300 million. The established technologies also appear to require lower outlays than AMLCDs, with one recent exception: Fujitsu has announced that it will invest \$941 million in a plant to produce plasma screens that are one meter in diagonal.<sup>7</sup>

Any U.S. entrant would face tough competition. Japanese firms have spent years moving from simple, low-information-content FPD manufacturing to the complex AMLCDs now made in large volumes for commercial markets. Some of these firms are entering their third generation of AMLCD manufacturing (see chapter 2). This experience has enabled them to reduce

manufacturing costs, and a well-developed FPD materials and equipment infrastructure exists—largely in Japan—to supply the manufacturers.

Until U.S. firms gain experience, following a catch-up strategy means competing directly with experienced manufacturers who can set a price based on a much lower manufacturing cost. Without government intervention, these firms are likely to lose money initially in order to compete in world markets. With a strategy based on established technologies, U.S. firms face the challenge of expanding their current market niches. To leapfrog the AMLCD (assuming the manufacturing cost is competitive), the new entrants will be forced to compete with an established technology, possibly requiring user education. One approach using established or leapfrog technologies would be to target markets in which AMLCD is not currently established, such as large-screen televisions or computer workstation monitors.

<sup>7</sup>"Fujitsu Betting On Plasma Displays," *Electronic Engineering Times*, June 5, 1995, p. 28.

**BOX 3-3: Display Consorti**

Display consortia have developed as a means of addressing the disadvantages of an industry comprised mainly of small firms, and as a vehicle for presenting a unified position to government agencies in dealing with trade cases, R&D funding, and design of government programs. The United States Display Consortium (USDC), formed by industry and the Defense Department's Advanced Research Projects Agency (ARPA) in 1993, has been the most active in trying to bring together the disparate industry players into a critical mass. A conclusion reached by many in the flat panel display (FPD) industry during the dumping case of 1990-93 was that ties were needed within and between the various levels of the industry, and that the weak infrastructure for FPD manufacturing was both a result of the low level of FPD production and a barrier to increasing that level. Using experience from Sematech as a model (and hiring a former Sematech executive as its first CEO), the USDC has focused its efforts on improving the infrastructure for display manufacturing in the United States. It has gone about this task by creating links between the three main segments of the industry: equipment and materials suppliers, FPD manufacturers, and display users (see figure below),

**USDC: A Vertically Integrated Approach**

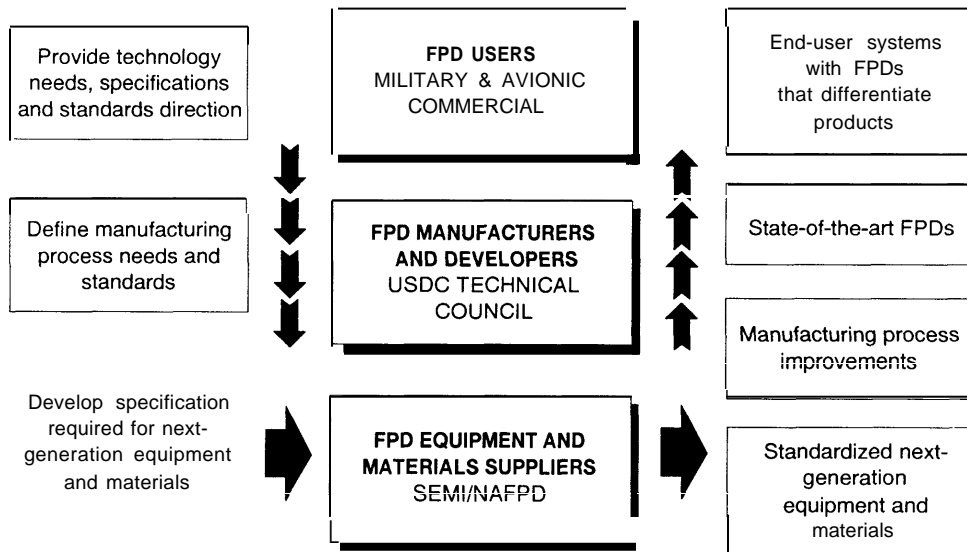

KEY: FPD = flat panel display; SEMI/NAFPD = Semiconductor Equipment and Materials International, North American Flat Panel Display Division; USDC = U S Display Consortium

SOURCE: U.S. Display Consortium, 1995

By coordinating the flow of information—requirements and standards—and funding from users and manufacturers to equipment and materials suppliers, USDC aims to foster the development of a more robust manufacturing infrastructure. This will improve and standardize FPD manufacturing, and lead to high-quality production of FPDs to meet users' needs. As neither the infrastructure nor the manufacturing base is well developed, the USDC sees its challenge as "the unprecedented task of developing two industries concurrently."<sup>1</sup> This is in contrast to Sematech's challenge, which was to improve the infrastructure for a mature manufacturing industry. USDC members participate at three levels 1) users, 2) manufacturers and developers, and 3) equipment and materials suppliers. Membership at the end of the consortium's first year of operation represented a large segment of display manufacturers and suppliers, and several large users of displays (see table below).

(continued)

<sup>1</sup>Annual Report, U S Display Consortium, San Jose, CA 1994, p. 5.

BOX 3-3: Display Consortia (Con)

USDC Membership

Manufacturers and developers	AT&T	Photonics imaging	
	Coloray	Planar Systems	
	Electro-Plasma	Plasmaco	
	Kent Display Systems	Silicon Video	
	Kopin	Standish Industries	
	Motif	SI Diamond Technologies	
	Norden Systems-Westinghouse	Three-Five Systems	
	Optical Imaging Systems	Xerox Palo Alto Research Center	
	Commercial users	Apple Computer	Delco Electronics
		AT&T	IBM
Chrysler		in Focus Systems	
Compaq Computer		Sun Microsystems	
Military users	Allied Signal	Lithographics Ltd.	
	Honeywell Defense Avionics Systems	Rockwell International	
	Hughes Electronics	Science Applications International Corp.	
	Kaiser Aerospace and Electronics	Smiths Industries Aerospace	
Equipment and materials suppliers	Over 100 members of the North American Flat Panel Display Division of Semiconductor Equipment and Materials International (SEMI-NAFPD)		

NOTE Texas Instruments announced its intention to join USDC in 1995  
 SOURCE U S Display Consortium Annual Report, 1994

USDC's activities have been coordinated closely with ARPA's display programs, and ARPA has been instrumental in initiating and sustaining the consortium. ARPA awarded a \$20-million grant for that purpose in 1993, and an additional \$25 million in 1995. All grant money is matched with member funds that, in the first year of operation, reached 51 percent of the USDC's budget. Most of the USDC's expenditures fund development contracts for FPD materials and equipment suppliers; 12 such contracts were initiated in the first year, funding development in areas such as color filters, testing, coating, etching, glass inspection and handling, lithography, and optical films.

The earliest display group was the Advanced Display Manufacturers of America (ADMA), formed to petition the government on the dumping charge, and its affiliated research arm, the American Display Consortium (ADC, formerly the ADMA Research Consortium). Currently comprised of 17 U.S. FPD developers and manufacturers, the ADC works to advance the industry by supporting research and development on several generic, precompetitive FPD manufacturing technologies. The ADC has won two National Institute for Standards and Technology Advanced Technology Program (NIST ATP) awards. A 1991 grant of \$7.3 million, combined with cost sharing by ADC participants, created a five-year, \$14.9-million program for the development of automated inspection and repair technologies, and advanced electronic interconnection and packaging technologies. A \$6.4-million grant awarded in 1993 has funded a three-year, \$13-million program for the development of color FPD manufacturing technologies, including etching and exposure tools and alignment and masking methods. ADC members perform the program research at their own facilities. Results, sometimes patented and licensed, are shared through quarterly technical reports.

The ADC is also a charter member of the Phosphor Technology Center of Excellence (PTCOE) at the Georgia Institute of Technology. This ARPA-funded, three-year, \$10-million program involves the PTCOE, several universities, research centers, and the ADC in improving phosphors for use in plasma, electroluminescent, and field emission displays (initially, phosphors for liquid crystal display backlighting were on the research agenda, but have been dropped). The ADC does not financially contribute to the center, although its members receive funding for participating in phosphor research. The ADC is also closely affiliated with the USDC; two member companies represent the ADC on the USDC Governing Board, and ADC members who choose to participate in the USDC sit on its Technical Council, enabling communication and coordination of the two consortia's efforts and activities.

SOURCE: Office of Technology Assessment, 1995

### ■ Catch-Up Approaches

The catch-up strategy advocates moving down the path of the dominant technology for producing flat panel displays—AMLCD—because it represents the best combination of manufacturing experience, materials and equipment infrastructure, suitability for important commercial applications, and capability for integration with existing semiconductor manufacturing. With this strategy, U.S. firms—perhaps with government assistance—would make the required investments to enter into volume manufacturing of AMLCDs, for which there is a large and growing demand. Firms could use a combination of existing domestic technology and technology transferred from foreign manufacturers.

Catch-up entails risks that have so far proved overwhelming. First, the investment required for a state-of-the-art AMLCD manufacturing facility is on the order of \$400 million. Substantial further investment would be required to cover initial losses because it is very difficult to bring manufacturing lines to an acceptable yield of workable displays. Because the leading Japanese firms have had several years and two to three generations of manufacturing experience in AMLCD technology, new entrants would immediately be subjected to pricing at or below their initial manufacturing costs.

U.S. firms could accelerate the learning process by tapping into the AMLCD manufacturing expertise of the leading Japanese FPD manufacturers. This could be accomplished by licensing agreements, joint ventures, or involvement of Japanese companies in U.S. FPD public-private consortia. The only current example is the IBM-Toshiba joint venture, Display Technology, Inc. (DTI), but all of its operations are in Japan. Sharp Corp. has initiated some FPD development at its plant in Camas, Washington, but most activity is limited to assembly of foreign-made components.

The only continuous production of AMLCDs in the United States has been at Optical Imaging Systems (OIS), which has been a low-volume supplier of displays for military and commercial

avionics markets. It received a \$48-million matching ARPA grant in 1993 to build a new facility, designed as a pilot plant for developing higher volume manufacturing techniques. OIS has developed plans for migrating its current manufacturing process to high-volume production in a proposed adjoining facility.

Kopin Corp., with some assistance from DOD, has begun production of small format (approximately one inch in diameter) high resolution AMLCDs for head-mounted and projection systems. Xerox Palo Alto Research Center, long a pioneer in AMLCD technology, is working with Standish and AT&T on a \$50 million ARPA contract, matched dollar for dollar by the firms, to evaluate manufacturing techniques. Xerox fabricates the active matrix, Standish assembles the LCD, and AT&T packages the displays in systems. To date, these firms have not announced any plans to develop a central, high-volume facility.

Two other firms also have or are developing capabilities for domestic production. ImageQuest, a California-based firm that is majority owned by the Korean conglomerate Hyundai, is building an AMLCD production facility with the goal of competing in military and civilian avionics markets. Litton Systems Canada, which bought the U.S. firm Panelvision, has a limited AMLCD production capacity and is building a low-volume production line. Although located in Canada, it is considered a domestic firm (North American) for the purposes of DOD's Defense Production Act Title III program to foster local production of AMLCDs (see "Government Activity" below).

The large capital investments required by high-volume AMLCD manufacturing demand the participation of entities larger than any U.S. firm currently manufacturing FPDs. Several large firms could potentially play such a role. One obvious candidate is IBM, which is half-owner of DTI, one of the largest producers of AMLCDs. Others include AT&T and Motorola. All of these firms have large internal demand for FPDs and manufacturing experience in electronics. Other U.S. computer companies have been involved in FPD development (Compaq, Hewlett-Packard,

and Apple are all sources of capital, and Texas Instruments is carrying out internal development); these firms could also provide large internal demand for FPDs. To date, none of these firms has announced plans to enter into domestic FPD manufacturing.

Materials suppliers such as Corning could also play a role. Corning is a leading supplier of LCD glass substrates, has established joint ventures to produce display glass in Japan and Korea, and is pursuing (with support from ARPA) a new method for fabricating color filters. Corning states that it would build a plant to finish glass (and potentially add color filters to the substrates) in the United States if sufficient demand existed.<sup>8</sup>

A successful catch-up would require perseverance to lower the manufacturing cost of a standardized product over several generations. An example is the videocassette recorder (VCR): while a U.S. firm pioneered video-recording technology, Japanese firms developed the technology into a low-cost consumer product (see box 3-4). Multiple generations of design, production, and market testing, together with strong attention to the development of manufacturing skills, were essential to progress from a breakthrough technology to a low-cost product. This points out some of the difficulties involved in a catch-up strategy.

### ■ Niche Market Approaches in Established Technologies

As discussed earlier, U.S. firms are strongest in niche markets that use established technologies, such as EL and plasma. Several U.S. firms have also made a good business in PMLCDs. The niche market approach would use the existing strengths of the domestic industry to increase market share in niche technologies, by both increasing shares of existing applications and creating new applications. Some of the established technologies are well suited to military, industrial, medical, and transportation market segments. Some may also

be critical to development of new products, such as high definition televisions. By enhancing current efforts in known areas, the niche strategy seeks to build the domestic industry by avoiding the large investments and increasing price competition in the mainstream computer and consumer display markets.

U.S. firms are competitive in plasma and EL display production. Some firms, including Babcock, Cherry, and Dale, manufacture low-information-content displays in volume, but use plasma technology similar to that used in high-information-content FPDs. Others, such as Photonics, Plasmaco, and Electro Plasma, are producing large-format, high-information-content displays for military and specialized commercial markets, and have plans to manufacture for larger commercial markets, such as HDTV. Planar, the largest manufacturer of EL displays worldwide, is also the largest U.S. FPD firm, and has entered into alliances with AMLCD developers. Photonics and Planar have received numerous DOD R&D contracts to extend the capabilities of plasma and EL technology.

The leading PMLCD producer in the United States is Standish Industries, which manufactures low-information-content displays for commercial markets, and more complex displays—often using active matrix components produced by other companies such as Xerox—for military programs. Several firms, including In Focus Systems, Nview, Positive Technologies, and Proxima, repackage (usually imported) displays for commercial applications. Another leading PMLCD firm, Three-Five Systems, is moving from integrating imported LCDs to manufacturing its own domestically.

The difficulty inherent in the niche strategy is that, by definition, it does not attempt to compete in the largest segments of the market; without large markets in future applications, it is limited in growth potential. However, firms such as Planar have exploited segments that, while small relative

<sup>8</sup> Bob Yard, Corning Worldwide Marketing, Corning, NY, personal communication, June 21, 1995.

## BOX 3-4: VCR Case Study

The commercialization of videocassette recorder (VCR) technology for the consumer market is often viewed as a classic case of U.S. firms inventing a technology, only to have Japanese firms copy it and reap the benefits of market dominance. Upon further inspection, this case points to other issues related to the gap between initial technological breakthroughs and large-scale production of a product for a mature market. Successful firms did not merely replicate an invented artifact in large quantities. Multiple generations of iterated design, production, and market testing, as well as strong attention to the development of manufacturing skills, were essential to win.

Ampex made the first video tape recorder (VTR) breakthrough in 1956 and cross-licensed it with RCA. Ampex then grew fearful that RCA would be first to introduce a solid-state VTR, and collaborated with Sony (also intending to gain access to the Japanese market). Ampex marketed a solid-state VTR in 1962 and had a dominant share of the market, but then decided to pursue markets far from its core capability in magnetic recording technology. Japan's national broadcasting corporation, NHK, imported an Ampex VTR, invited engineers from electronics firms to examine it, and provided data to a VTR research group funded by the Ministry of International Trade and Industry (MITI). Rather than doing market research, Japanese firms emphasized the development of innovative electronics products that they believed would create future markets. Forced by Ampex's refusal to grant further patent rights to develop its own technology, the Victor Company of Japan (JVC, half owned by Matsushita) was the first to release a two-head (rather than four) VTR, in 1960.

When Sony demonstrated the first solid-state VTR in 1961, using a two-head helical scan technique, Ampex did not believe it would be commercially successful. Instead, Ampex tried to leapfrog Japanese efforts with its portable Instavideo. It was well received, but never reached production because of the firm's doubts about mass production capabilities. Instead, Ampex turned to Toamco, its joint venture with Toshiba, to produce the product, but they never solved the production problems. RCA, having similar production doubts (about the scanner heads), turned to Bell & Howell, which also failed in production. Matsushita faced production problems also, but, despite cutbacks, kept its main cadre of manufacturing engineers intact, preserving a capability for the future by temporarily assigning them to research. Sony's approach was one of systematic manufacturing efforts iterated with market tests of product generations. The company had its VCR design team build several prototypes, put them in competition with each other, selected the best, worked for 18 months on pilot models, and followed it into production. JVC also kept the design and production staffs in close contact, and selected staff with expertise in design, manufacturing, and marketing. Sony selected the losing approach (Betamax), but had built up production capabilities through production of U-Matic and Beta-max lines.

What really mattered in the race to commercialize VCR technology was not the precise sequence of entry into the R&D competition, but which firms possessed the right technological capacity when the window of opportunity opened. Since product performance was bound up in manufacturing technique, the path to competitive advantage lay in incremental design improvements and the integration of design and manufacturing. Learning by trying was the central task of being a pioneer in VCRs.

But the Japanese firms also possessed a strategic clarity that was lacking in the U.S. firms. Ampex and RCA were more opportunistic, looking for breakthroughs that were elusive. The bold technical stroke was lacking because the firms had not developed the manufacturing skills that the Japanese had acquired through incremental progress. U.S. firms also viewed shortcomings as failures rather than as learning experiences. Japanese firms had a high degree of organizational consistency and management with technical understanding during the development of VCR technology. The Japanese did not simply copy U.S. technology. They entered the field early and persisted, similar to their efforts in compact cars, digital computers, numerically controlled machine tools, semiconductor memories, and computer printers.

SOURCE: Richard S. Rosenbloom and Michael A. Cusumano, "Technological Pioneering and Competitive Advantage: The Birth of the VCR Industry," *California Management Review*, vol. 29, No. 4, summer 1987, pp. 51-76.

to the overall FPD market, are large absolutely; other firms, such as plasma producers, hope to exploit demand for screens that are too large for current AMLCD manufacturing capacity. Growth areas for niche technologies could be in large-screen displays, such as HDTV applications.<sup>9</sup>

### ■ Leapfrog Efforts in New Technologies

Like the niche approach, the leapfrog strategy argues that the Japanese lead in AMLCD production is insurmountable, and that other technologies could provide a lower ratio of price to performance than the AMLCD. This approach relies on U.S. strengths in breakthrough innovations to develop a new technology with characteristics superior to the AMLCD. Leapfrog technology would shift FPD technology to a new learning curve, rather than have U.S. firms follow Japanese firms down the existing AMLCD curve. By producing a product comparable or superior to the AMLCD at a comparable or lower manufacturing cost, the leapfrog approach would position domestic firms to capture a large share of a growing market.

A growing number of firms are pursuing R&D in technologies that have the potential to leapfrog the dominant AMLCD by providing equivalent performance at a lower production cost. The leading candidate is the field emission display (FED), developed at SRI decades ago but commercialized only recently by the French company, PixTech. Texas Instruments (TI) and Raytheon (which are assisted by an ARPA contract) and, more recently, Motorola, have licensed PixTech's technology, as has the Japanese firm, Futaba. The agreements provide for cross-licensing between PixTech and FED technology developed by each of the other firms.

Other FED approaches are being pursued by U.S. firms, including Coloray Display, Crystal-

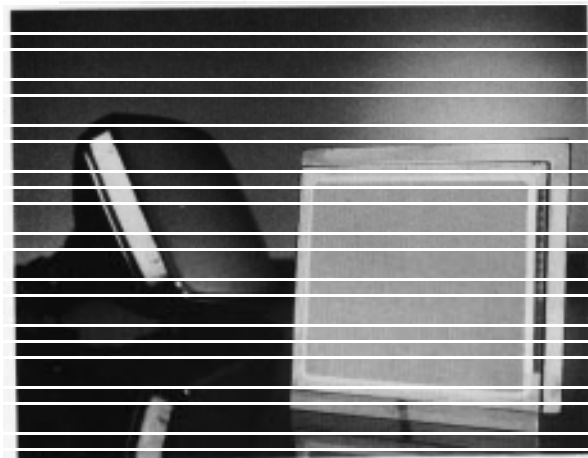

*Field emission displays use technology similar to cathode ray tubes (CRTs) in a thin, lightweight package and could offer performance superior to AMLCDs at lower cost.*

lume, FED Corp., Micron Display Technology, S1 Diamond Technology, and Silicon Video Corp. Many of these firms have also received government support in the form of ARPA, Advanced Technology Program, and Small Business Innovative Research grants. While some of these firms envision competing with AMLCDs in the laptop display market, a more suitable application may be in large (greater than 20-inch diagonal) displays for television and computer monitors, a size to which producers have been unable to extend AMLCD technology. FED has the potential to outperform AMLCDs in terms of most viewing characteristics and to offer a lower manufacturing cost. It should be noted, however, that very few working FEDs have actually been made and production experience with these displays is very limited.

Another leapfrog candidate is the digital micro-mirror device (DMD), pioneered during the early 1990s by TI with support from ARPA. TI has not yet produced the display in commercial quantities, although it has entered into product development agreements with In Focus, Nview, Proxima,

<sup>9</sup> Fujitsu plans to produce 42-inch Plasma screens in time for the 1998 Winter Olympics in Nagano, Japan; see "Fujitsu Betting On Plasma Displays," *op. cit.*, footnote 7.



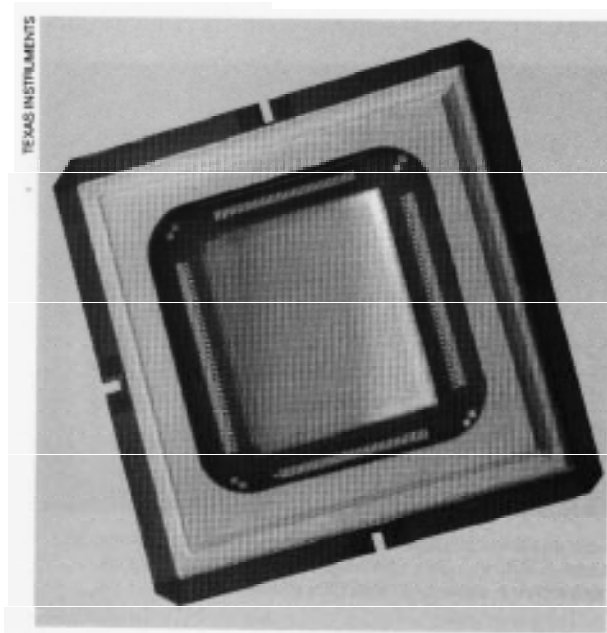

*Texas Instruments has adapted standard semiconductor manufacturing techniques to build its digital micromirror device, a miniature array of over 400,000 mirrors, for use in projection display systems.*

Rank Brimar, and Sony.<sup>10</sup> Aura Systems is also pursuing a similar technology. The limitation of this technology is that it can only be used in projection systems, a much smaller part of the market than direct-view displays.

The leapfrog strategy has often been viewed as entailing little risk and perfectly suited to the innovative culture exemplified by Silicon Valley. But this view obscures the risks and costs this strategy entails. First, mass manufacturing of displays using a leapfrog technology could involve many unforeseen problems not encountered by the small-scale efforts to date. All of the proposed technologies require substantial investments in order to scale up from current capabilities to commercial volumes, and they require significant experience in the specifics of mass manufacturing. If history is any guide, the weaknesses of the U.S. FPD industry lie not in any lack of innovative technologies, but in the lack of access to long-term, patient capital and the willingness to tackle

manufacturing challenges, which require continuous and incremental process innovations. Their dedication to solving manufacturing problems, rather than their breakthrough technology developments, has brought Japanese firms to the forefront of FPD technology.

A second concern is that the AMLCD is becoming entrenched and difficult to dislodge, barring any large differences in cost or performance. Once the supply structure has developed around a dominant technology, suppliers, producers, and users resist adopting a new one.

A final risk is that the trend toward integration of functions such as computing onto the display (see chapter 2) is accelerating, and it could favor AMLCDs. The transistors used in AMLCDs are similar to semiconductor devices, which operate on modest voltages. However, many of the emissive technologies require high voltages to operate. These voltages are not compatible with standard integrated circuit levels (although FED voltages are moving toward chip voltage levels, and the DMD is similar to a semiconductor chip). This could present difficulties for integrating circuitry onto the display.

The leapfrog approach requires a technical breakthrough, as well as honing the manufacturing process for an alternative technology. Both involve risks, including technical hurdles in large-scale production for a technology that has not been identified. Leapfrog approaches have a mixed record of success. While Japanese companies devoted their efforts to an analog HDTV standard, U.S. firms, first in competition and then in a collaborative effort, developed a more capable digital HDTV standard. This has given U.S. firms new opportunities to compete. However, in VCRs (see box 3-4), RCA attempted to leapfrog analog magnetic tape recorders with video disks read by lasers. Now common in stereo and computer systems, such technology was not well developed at the time (too expensive to produce), and lost out to the established video tape.

<sup>10</sup> Ronnie Dunn, Program Manager, Digital Imaging Venture Projects, Texas Instruments, Dallas, TX, personal communication, May 24, 1995; "Sony, TI Team Up in New Display Technology," *Nikkei Weekly*, Mar. 6, 1995, p. 1.

TABLE 3-1: Federal Spending on Flat Panel Displays by Fiscal Year and Agency (in millions of dollars)

Agency	FY1991	FY1992	FY1993	FY1994	FY1995	FY 91-95
Defense	77.0	79.5	167.1	173.0	100.7	597.3
Commerce	1.8	5.3	6.0	5.2	4.3	22.6
Energy	0.3	1.0	3.5	6.0	7.0	17.8
NASA	1.3	1.3	1.3	1.3	1.3	6.5
NSF	0.0	0.3	0.4	0.4	0.4	1.5
Total	80.4	87.4	178.3	185.9	113.7	645.7

KEY NASA = National Aeronautics and Space Administration, NSF = National Science Foundation

SOURCES For Department of Defense spending, see table 3-2 below; for other agencies, see U.S. Congress, Congressional Research Service, *Flat Panel Display Technology: What is the Federal Role?* (Washington, DC Mar 24, 1995), table 1

## GOVERNMENT ACTIVITY

U.S. government funding for FPDs, including R&D and insertion programs, has been dominated by DOD (see table 3-1). Prior to 1989, a small amount of display R&D was funded by the individual services' laboratories for their individual mission needs. Since 1989, ARPA has been the driving force in display R&D, prompted first by congressional interest and, since 1994, by Administration programs. In the Department of Commerce, the National Institute of Standards and Technology's Advanced Technology Program (ATP) has made several awards to FPD consortia for precompetitive research. The Department of Energy funds some display research in its multi-program laboratories, and coordinates the National Center for Advanced Information Components Manufacturing (NCAICM). The National Science Foundation (NSF) also supports some FPD R&D, and the National Aeronautics and Space Administration (NASA) is retrofitting systems such as the Space Shuttle with FPDs.

### ■ ARPA-Funded Programs

In 1989, in the wake of concerns over domestic display capabilities for competition in HDTV, ARPA initiated the High Definition Systems (HDS) program, originally called High Definition

Display Technology. Program funding in the first two years was \$5 million and \$30 million, respectively. In fiscal years 1991 and 1992, Congress appropriated \$75 million for HDS. In 1993, Congress increased the HDS funding to \$161 million, including \$25 million designated specifically for "AMLCD Technology,"<sup>11</sup> and \$60 million to fund NCAICM at Sandia National Laboratories. It also appropriated just under \$10 million for the Tactical Display Systems program (TDS), which includes the Head Mounted Display program (HMD). Outlays were slightly less, due to a reduction in appropriations (see table 3-2).

In 1994, the Clinton Administration requested \$57 million, which Congress increased to \$85 million. In addition, ARPA funded \$9.3 million for display R&D through the TDS program, and \$25 million through the Technology Reinvestment Project. Another \$40 million in DOD funds was used by authority of Title III of the Defense Production Act (see below for description), which included \$30 million to partially fund the Xerox/AT&T/Standish manufacturing testbed, and \$10 million for purchase incentives to the military services.<sup>12</sup> In 1995, the Administration requested \$68 million for the ARPA HDS program, which Congress increased to \$82 million. In addition, another \$15 million was requested for the TDS program.

<sup>11</sup>As OIS was the only domestic manufacturer of AMLCDs at the time, it was widely regarded that this appropriation was earmarked for the Troy, Michigan firm. See Douglas Harbrecht, "Did Commerce Pull the Plug on Flat-Screen Makers?" *Business Week*, July 5, 1993, p. 32; and John B. Judis, "Flat Panel Flop," *The New Republic*, Aug. 9, 1993, pp. 16-21. OIS notes that they were awarded the contract based on a competition with numerous respondents; Curtis Casey, Vice President, OIS Northville, Michigan, personal communication, Apr. 17, 1995.

<sup>12</sup>An additional \$10 million in fiscal year 1994 appropriations is being spent in fiscal year 1995.

TABLE 3-2: DOD Flat Panel Display Funding, By Source and Fiscal Year (in millions of dollars)

Program	FY1991	FY1992	FY1993	FY1994	FY1995
ARPA High Definition Systems	74.4	75.0	152.2	84.5	81.6
ARPA Tactical Display Systems*			10.1	9.3	14.7
ARPA Technology Reinvestment Project				25.0	
DOD Services	2.6	4.5	4.8	4.2	4.4
Defense Production Act Title III <sup>b</sup>				50.0	
Total	77.0	79.5	167.1	173.0	100.7

KEY ARPA = Advanced Research Projects Agency; DOD = Department of Defense

NOTES

\*ARPA's Tactical Display Systems Program is made up of the Head Mounted Displays (HMD) and Tactical Information Assistants (TIA) Programs,

only the HMD Program is directly related to flat panel displays

<sup>b</sup>At the time of this writing, the Title III Program was expecting an additional \$10 million in funding

SOURCES: U.S. Department of Defense, Advanced Research Projects Agency, *Research, Development, Test and Evaluation, Project Level Summary Reports*, various years; U.S. Department of Defense, *Budding U.S. Capabilities in Flat Panel Displays: Report of the Flat Panel Display Task Force*, October 1994, table 71, Mark Hartney, Program Manager, Advanced Research Projects Agency, Electronic Systems Technology Office, personal communications, July 1995.

### High Definition Systems

ARPA's HDS program was initiated in 1989 to develop the domestic capability to manufacture FPDs by bringing together firms from the three levels of the FPD industry: 1) materials and equipment, 2) display manufacturers, and 3) end-users. The first phase, from 1990-92, focused on building up the capability of the materials and equipment sector of the industry, and also supported research in advanced display technologies. The first phase resulted in a series of technical breakthroughs in display R&D (see table 3-3).

Phase Two of HDS, begun in 1993, added support of FPD manufacturing testbeds to the ongoing R&D programs. The first manufacturing testbed award, for \$48 million, was made to OIS which matched the grant. The plant, located in Northville Township, Michigan, is scheduled to begin production in 1995. The planned production capacity is 160,000 AMLCD displays annually.<sup>13</sup> OIS estimates that one-quarter of this capacity will be devoted to military needs.<sup>14</sup> In 1994, a \$50-million award was made to a partnership consisting of AT&T, Xerox, and Standish Industries, also matched by the companies. This testbed is distributed at four sites among the firms, and will

develop high resolution displays and advanced packaging for intelligence applications. In addition to meeting defense needs, the testbed will allow AT&T and Xerox to develop the capacity to supply internal display needs for market testing. Another aspect of HDS Phase Two has involved support for the domestic display manufacturing infrastructure. For that purpose, ARPA awarded \$20 million to the U.S. Display Consortium (USDC; see box 3-3) in 1993, and an additional \$25 million in 1995. Both awards were matched by the consortium's member companies.

ARPA HDS also funded NCAICM, a cooperative research program in FPD and microelectronics technologies operated by Sandia National Laboratories in conjunction with Los Alamos and Lawrence Livermore National Laboratories, with facility and personnel contributions from the Department of Energy (DOE). A one-time appropriation of \$60 million was made for NCAICM in the 1993 Defense Appropriations Bill. Approximately \$48 million is used for joint industry-lab projects, one-half involving FPDs and one-half for manufacturing other information technology components (e.g., electronics and photonics). Sandia is spending \$12 million to administer the

<sup>13</sup>This assumes four displays are produced from every set of substrates; the line will be able to handle substrates up to 17 inches in diameter. Vincent Cannella, "Made in the USA: High Volume AMLCDs," *Semiconductor International*, February 1995.

<sup>14</sup>Casey, op. cit., footnote 11.

**TABLE 3-3: Selected Technical Accomplishments from Phase One of ARPA's High Definition Systems Program**

Company	Achievement
Xerox Corp.	13-inch diagonal AM LCD with 6.3 million pixels (most to date)
Texas Instruments	Full color HDTV format digital micromirror display (first of its kind)
Planar Systems	Full color, 10-inch diagonal EL display with VGA resolution (first color)
Photonics Imaging	Full color, 30-inch diagonal high resolution plasma monitor
Micron Display Technology	Full color, 0,7-inch FED head mounted display
Kent State University	8.5- x 1 1-Inch, 120 dots per inch reflective display with image memory
Standish Industries	Manufacturing facility for STN LCD and color filters

KEY: AMLCD = active matrix liquid crystal display, ARPA = Advanced Research Projects Agency, EL = electroluminescent, FED = field emission display, HDS = High Definition Systems, HDIV = high definition television, LCD = liquid crystal display, STN = super twisted nematic, VGA = video graphics adapter

SOURCE Department of Defense, Advanced Research Projects Agency, Electronic Systems Technology Office, "High Definition Systems Program Fact Sheet," Mar 8, 1995

center, move facilities outside of the laboratory secure area, and carry out several precompetitive research projects approved by an oversight board (composed of national laboratory, ARPA, and industry representatives).

The goal of the display portion of the NCAICM program is to develop flexible manufacturing technologies that can be applied to low-cost, high-volume production of large area emissive FPDs, mainly plasma, FED, and EL.<sup>15</sup> The emphasis on non-AMLCD technologies reflects an assessment that LCDs will be limited to medium area (less than 20-inch diagonal) displays. These technologies also match the technical capabilities of the participating national laboratories.

The projects are organized into two phases. Phase I projects involve research on precompetitive materials, processes, and equipment, utilizing NCAICM staff and facilities; the results are in the public domain. Phase II projects are joint industry/lab efforts performed at the industry sites, NCAICM facility, or other DOE labs as appropriate; the resulting intellectual property rights may be claimed by the firms. Phase I projects include development of an economic model of a flat panel display factory, construction of metrology equip-

ment for FEDs, and construction of a phosphor characterization facility. There are 13 Phase II FPD projects, including support of color plasma development at Photonics Imaging; EL development at Planar and UNIAX Corp.; FED development led by FED Corp., Micron Display Technology, SI Diamond Technology, and Silicon Video Corp.; and development projects in areas common to all FPD technologies.

Finally, the Phosphor Technology Center of Excellence, led by the Georgia Institute of Technology, has been funded under HDS to train scientists and engineers for research and development of phosphor technologies. Five universities, the American Display Consortium, and the David Sarnoff Research Center are also founding members. The research emphasis is on emissive FPDs, since phosphors are a key component in all types of emissive displays. Originally the center planned to investigate improved phosphors for LCD backlighting, but this goal has been set aside by the member companies.<sup>16</sup>

### **Head Mounted Displays**

in 1992, ARPA established the HMD program to create small, high resolution FPDs that can be mounted in military helmets. Table 3-4 lists some

<sup>15</sup>"Program Status Report," National Center for Advanced Information Components Manufacturing, February 1995.

<sup>16</sup>Paul H. Holloway et al., "Blue and Yellow Light Emitting Phosphors for Thin Film Electroluminescent Displays," in *Flat Panel Display Materials*, J. Batey, A. Chiang, and P. H. Holloway (eds.), Symposium Proceedings, vol. 345 (Pittsburgh, PA: Materials Research Society, 1994), pp. 289-298.

TABLE 3-4: Selected Results from the ARPA Helmet Mounted Display Program

Company/Team	Achievement
Kopin Corp., Planar Systems, David Sarnoff Research Center, and Standish Industries	AM LCD and AMEL displays using single crystal silicon, with 1.3 million pixels on a square-inch display
Displaytech	Low voltage reflective FLCDD color display

KEY: AMLCD = active matrix liquid crystal display, AMEL = active matrix electroluminescent, ARPA = Advanced Research Projects Agency, FLCDD = ferroelectric liquid crystal display

SOURCE: Department of Defense, Advanced Research Projects Agency, Electronic Systems Technology Office, "Head Mounted Displays Program Fact Sheet," Mar 9, 1995.

of the HMD results in small displays. The program has also developed several approaches to integrating FPD technology into soldier systems.

### ■ The National Flat Panel Display Initiative

in 1993, the Clinton Administration's National Economic Council (NEC) and Council of Economic Advisors identified the U.S. FPD industry as an example of the need to coordinate the commercial and defense development and production of technology-intensive systems. The NEC asked DOD to conduct a study to determine whether FPDs were important to military security, and if so, what should be done about the weakness of the domestic industry. In April 1994, after a year-long multiagency study, the National Flat Panel Display Initiative (NFPDI) was announced.<sup>17</sup> NFPDI seeks to apply three policy tools to help develop a domestic industry that can provide DOD with early, assured, and affordable access to FPD technologies: 1) continuation of ARPA R&D and manufacturing testbed programs, 2) awarding R&D grants to firms planning to manufacture FPDs, and 3) applying DOD funds to procurement programs if they use domestic FPDs.

NFPDI was developed to meet defense needs by fostering a high-volume commercial FPD industry.<sup>18</sup> The primary justification for NFPDI relates to national security: if the government cannot be assured of an unimpeded flow of a criti-

cal component, U.S. national security capabilities may be damaged. The rationale is that without a capability for volume production in the United States, the technology base for displays (i.e., what DOD has traditionally supported) is in jeopardy, regardless of the amount of R&D. The initiative comes under the Administration's dual-use policy, which calls for DOD to use commercial capabilities wherever possible and to focus on capabilities that will support both defense and commercial technology bases. The Administration has stated that national security requirements will not be met by current foreign or domestic suppliers; the leading display manufacturer (Sharp Corp.) will not make custom displays for U.S. defense needs; and U.S. firms are behind in FPD manufacturing technology.

Another rationale is related to linkages between the defense and commercial technology bases. DOD's argument is that the concentration of the display industry in Japan is a threat to the military's ability to procure advanced technology, and Japanese control over materials and equipment supplies could impede the access of U.S. display firms to those critical inputs. If a high-volume domestic FPD industry were created, larger amounts of R&D could be conducted by corporations, supported by revenue streams; ultimately, display R&D could be funded by industry at a higher level than the current government funding. To the extent that other industries draw from the same base of technology as FPDs, the lack of a U.S. research

<sup>17</sup>Department of Defense, "National Flat Panel Display Initiative," Apr. 28, 1994.

<sup>18</sup>Department of Defense, "Building U.S. Capabilities in Flat Panel Displays: Report of the Flat Panel Display Task Force." October 1994.

TABLE 3-5: Spending Plan for the National Flat Panel Display Initiative by Fiscal Year (in millions of dollars)

Program Element	FY1994	FY1995	FY1996	FY1997	FY1998	Total
Core R&D	50	82	48	68	68	316
Manufacturing testbeds	75	0	0	0	0	75
R&D Incentives	25	0	50	50	74	199
Purchase incentives	20					20
Total	170	82	98	118	142	610

## NOTE

At the time of this writing, the Active Matrix Liquid Crystal Cockpit Display Project of the Title III Program was expecting an additional \$10 million in funding for purchase incentives

SOURCES: *Electronic Engineering Times*, May 2, 1994, p 1, Mark Hartney, Program Manager, Advanced Research Projects Agency, Electron/c Systems Technology Office, personal communications, July 1995

and manufacturing base for FPDs could impede the competitiveness of those industries, and their ability to meet military needs.

The goal of the initiative is to use ongoing DOD investments in FPD research to encourage the development of a domestic capability for manufacturing FPDs in commercial volumes, which DOD expects will better serve defense needs than the current U.S. industry can. The initiative is comprised of four main elements (see table 3-5).

NFPDI can be viewed as an umbrella program consisting of: 1) existing ARPA R&D programs (including HDS and HMD); 2) ongoing ARPA manufacturing testbeds; 3) R&D incentives funded via ARPA's Technology Reinvestment Project (TRP) and the Defense Production Act, Title 111 (DPA); and 4) purchase incentives funded via DPA. Approximately two-thirds of NFPDI funding is devoted to ongoing ARPA HDS programs in R&D projects and manufacturing testbed awards, discussed previously. The two new aspects of NFPDI are the R&D and purchase incentives programs.

### R&D Incentives

NFPDI awards R&D grants to firms that: 1) have demonstrated prototype or pilot production of

leading-edge FPD technologies, and 2) make commitments to invest in high-volume FPD manufacturing. The awards are based on a firm's commitment to high-volume production (for commercial and defense markets), the quality of the proposed research, and a commitment to match the government R&D support. The exact type of technology is not a determining factor in the awards. The goal is to induce companies to begin manufacturing based on current technology by awarding support for follow-on or next-generation R&D.

The NFPDI awards will provide R&D grants, matched dollar for dollar by the firms; the awards are predicated on commitments by the firms to make capital investments of at least three times the government contribution. DOD estimates that private investments could total as much as 10 times the R&D grants.<sup>19</sup> In October 1994, DOD announced three winners in the first competition, funded by ARPA's Technology Reinvestment Project (see table 3-6). The method of indirectly funding production through the promise of R&D subsidies is designed to comply with restrictions on government production subsidies, ratified in the final version of the Uruguay Round treaty of the General Agreement on Tariffs and Trade.\*\*

<sup>19</sup>Mark Hartney, Program Manager, ARPA/ESTO, Arlington, VA, personal communication, June 7, 1995.

<sup>20</sup>DOD notes that the policy was cleared with the Office of the U.S. Trade Representative; however, some observers have made the case that NFPDI may violate the subsidies rules. See George Kleinfeld and David Kaye, "Red Light, Green Light? The 1994 Agreement on Subsidies and Countervailing Measures, Research and Development Assistance, and U.S. Policy," *Journal of World Trade*, December 1994, p. 43.

TABLE 3-6: First Round of National Flat Panel Display Initiative R&amp;D Incentive Awards (in millions of dollars)

Team leaders/members	Funding <sup>a</sup>	Description
Planar Systems Advanced Technology Materials, Allied-Signal, Boeing, Computing Devices Canada, Georgia Institute of Technology, Hewlett-Packard, Honeywell, Lawrence Livermore National Laboratory, Los Alamos National Laboratory, Oregon Graduate Institute, Positive Technologies, University of Florida	29.2	Thin film and active matrix EL display research for head mounted applications
Silicon Video Accufab Systems, Advanced Technology Materials, Lawrence Livermore National Laboratory, Planar Systems	67.2	Development of manufacturing technology for FEDs
Texas Instruments, Raytheon EG&G Power Systems, Georgia Institute of Technology, Lockheed Sanders, MRS Technology	25.5	Manufacturing research for FED production, based on technology from PixTech

KEY: ARPA = Advanced Research Projects Agency, EL = electroluminescent, FED = field emission display

NOTE:

Total project cost; ARPA and team contributions subject to negotiations, ARPA plans to spend a total of \$48 million on these projects

SOURCE: Advanced Research Projects Agency, 1995

### **Purchase Incentives**

Title III of the Defense Production Act of 1950, as amended in 1992, authorizes the President to enter into procurement of “industrial resources or critical technology items essential to the national defense” outside of the normal government procurement rules. Such procurement is authorized in the absence of a declared national emergency if the President determines that “the combination of the United States national defense demand and foreseeable nondefense demand is not less than the output of domestic industrial capacity” for the industrial resources or critical technology items, including the output that would be created by the procurement.<sup>21</sup>

The current Title 111 certification covers AMLCD technology exclusively, and is called the Active Matrix Liquid Crystal Cockpit Display (AMLCCD) project.<sup>22</sup> Through qualifications and accelerated procurement, the AMLCCD project is designed to: 1) accelerate the insertion of AMLCD technology into military avionics; 2) create cost savings through volume purchases; and 3) boost domestic manufacturing capabilities.

To date, the AMLCCD project has received \$20 million.<sup>23</sup> The funding is used as an incentive for military programs that are designing new aircraft, designing retrofits, or procuring aircraft to consider and purchase AMLCDs for the cockpit avionics. Military programs receive project fund

<sup>21</sup> Defense production Act Amendments of 1992, Public Law 102-558.

<sup>22</sup> This specification appears to have emerged from work on a draft standard guideline for cockpit AMLCDs at Wright-Patterson AFB, the initiation of the NFPDI as a whole, and specific congressional reference to AMLCD technology in several DOD appropriations reports. See Darrel G. Hopper and Daniel D. Desjardins, “Requirements for AMLCDs in U.S. Military Applications,” Cockpit Displays 11, *Proceedings of the SPIE*, vol. 2462, April 1995; Department of Defense Appropriations Bill, 1993, 102d Congress, Report 102-627, Report of the Committee on Appropriations (to accompany H.R. 5504), June 29, 1992, p. 203; Department of Defense Appropriations Act 1995, 103d Congress, H.R. 4605, Section 8119.

<sup>23</sup> A total of \$50 million was budgeted for Title III; \$30 million was used to help fund ARPA’s second cost-sharing grant for an AMLCD manufacturing testbed. An additional \$10 million for the AMLCCD project has been approved by DOD.

TABLE 3-7: Title III Active Matrix Liquid Crystal Cockpit Display Project

Military program	Number of AMLCDs	Funding (\$ millions)	Funding for	Program status
AH-64 Longbow	over 4,000 <sup>a</sup>	7.60	qualification	qualifications testing
DVE	over 2,500 <sup>a</sup>	0.75	qualification	qualifications testing
P-3C (two programs)	500 <sup>b</sup>	1.59	purchases	production in 1996
	280 <sup>b</sup>	0.70	qualification	qualifications testing
CH-46	665 <sup>b</sup>	4.23	purchases	low rate initial production
C-141	376 <sup>b</sup>	3.39	purchases	production in 1996
Common Display Program (AV-8B, F-18)	2,500 <sup>a</sup>	1.25	qualification	qualifications testing

KEY: AMLCD = active matrix liquid crystal display, DVE = driver vision enhancement

NOTES

<sup>a</sup>Potential number of displays required for retrofit or upgrade of existing platforms

<sup>b</sup>Actual number of displays under contract for platform retrofit.

SOURCES "Active Matrix Liquid Crystal Cockpit Display Project," DOD briefing slides received June 7, 1995, John Blevins, Active Matrix Liquid Crystal Cockpit Display project office, Wright-Patterson AFB, personal communication, July 21, 1995; Darrel G Hopper and Daniel D Desjardins, "Requirements for AMLCDs in U S Military Applications," Cockpit Displays II, Proceedings of the SPIE, vol 2463, April 1995, table 1

ing to defray the cost of qualifying (that is, testing in the operating environment) and for accelerated and volume purchases of AMLCDs.<sup>24</sup> In return, the program must require, and the contract must use, a domestic AMLCD manufacturer.<sup>25</sup> Programs are selected for funding based on their requirements, planned procurement, and potential impact on the industry. Seven programs currently participate in the project (see table 3-7).

DOD believes the Title III project could stimulate demand by more than 4,000 AMLCDs and boost domestic sales by as much as 400 percent in fiscal year 1996.<sup>26</sup> This could help low-volume manufacturers to develop production experience and help military programs extend limited resources. Title III has the additional benefit of fostering display commonality across programs.

For instance, the Common Displays Program of the Naval Air Warfare Center is helping the AV-8B and F-18 programs qualify the same display, accelerating insertion by almost a year.<sup>27</sup>

Participating program offices receive several benefits from taking part in Title III. It enables them to procure high performance AMLCDs for new and retrofitted systems that operate in strenuous environments; these include bubble-canopy and high-altitude aircraft such as F-22s and F-18s. By supporting qualification activity, Title III funding introduces FPD technology to programs that otherwise might not consider it; for example, the AH-64 Longbow program will upgrade its cockpit design from CRTs to AMLCDs.<sup>28</sup> Although Title III purchase incentives reduce the cost of domestic, custom-made AMLCDs, there

<sup>24</sup>The AMLCCD project only provides funding for purchases of unfinished AMLCDs; the basic unit includes the glass substrates, active matrix array and color filters, and row-and-column drivers. For a description of AMLCDs, see appendix A.

<sup>25</sup>For the purposes of the Title III program, *domestic* refers to any business that performs research, development, and manufacturing in the United States or Canada. The program's contract with the prime contractor will typically have a separate line item that stipulates the amount that the prime contractor is to use for a domestic display manufacturer, and another that requires that products delivered under the contract make use of that display.

<sup>26</sup>U.S. Department of Defense, "Active Matrix Liquid Crystal Cockpit Display Project," briefing material received June 7, 1995.

<sup>27</sup>John Blevins, AMLCCD Project Office, Wright-Patterson AFB, OH, personal communication, July 21, 1995. The Common Displays Program develops common avionics requirements across platforms by promoting communication between users and suppliers to define performance specifications and leveraging these specifications for use in other platforms. Harlan Smith, Air Combat Electronics Office, Naval Air Warfare Center, Indianapolis, IN, personal communication, July 17, 1995.

<sup>28</sup>Frank Bick, Army Aviation Troop Command, personal communication, June 26, 1995.



continues to be a large cost differential between commercial and custom displays (see chapter 2). For some programs, even Title III funding cannot bridge the gap between the cost of custom AMLCDs and the programs' limited budgets. Instead, these programs relax some performance requirements, and use less expensive, commercial AMLCDs.<sup>29</sup> Price reductions in domestic AMLCDs for commercial avionics are closing this gap.<sup>30</sup>

The Title III requirement for domestic manufacturers excludes some defense integrators that purchase commercial AMLCDs from foreign sources and ruggedize them (see box 2-3). These firms argue that such requirements prevent programs from considering their lower cost products. Others argue that the domestic requirement puts all integrators on an equal footing; even using a domestic source, the integrators could draw on their ability to ruggedize inexpensively to produce a high performance, lower cost product.<sup>31</sup>

Partly as a result of congressional interest, Title III funding is limited to AMLCDs (unlike the rest of NFPDI). However, AMLCDs are not a good match for all of the wide range of DOD's FPD needs; for instance, large area displays in Airborne Warning and Command Systems planes could use plasma or projection FPDs to replace existing CRTs. Broadening Title III projects to other FPD technologies could bring these incentives to other applications, further equip DOD with state-of-the-art technology, and bolster the domestic FPD industry.

## ■ Trade Policy

Trade policy can also affect the incentives for investment in FPD manufacturing. One area is tariffs. Tariffs on imported FPDs are low—zero on FPDs for computer applications with a diagonal screen size up to 12 inches, 3.7 percent on FPDs for computer applications with larger screens, and 5 percent on FPDs for televisions. In comparison, FPD tariffs are zero in Japan, 4.4 to 4.9 percent in the European Union (EU), 5 to 7.5 percent in Taiwan, and 9 percent in Korea. FPD parts and components imported into the United States often face higher tariffs, discouraging domestic FPD manufacturing.

### *Antidumping Duties*

Another possible trade policy tool is the imposition of antidumping duties when imports are sold at less than fair value. Such duties are permitted under the rules of international trade, though recent changes in these rules narrow their permitted application somewhat. Formally, and as a matter of expressed Administration policy, antidumping cases are legal proceedings, to be decided on legal rather than policy grounds; in practice, policy concerns sometimes enter into dumping determinations.

The FPD industry has already tried to use antidumping duties as a weapon against imports. While substantial duties were placed on AMLCDs from Japan from 1991 to 1993, the result of those duties was to drive some computer manufacturing offshore rather than to encourage U.S. AMLCD

<sup>29</sup> Colonel Dan Hamilton (Ret.), Combined Air National Guard and Air Force Reserve F-16 Program, Ogden Air Logistics Center, Hill AFB, UT, personal communication, June 27, 1995; Frank McKinney, Assistant Program Manager for Systems Engineering, Naval Air Systems Command, Arlington, VA, personal communication, June 28, 1995; and Bob Lehman, Team Leader, Navy UH-1N Program, Naval Air Warfare Center, Warminster, PA, personal communication, July 5, 1995.

<sup>30</sup> One Program Officer found that Title III funding helped bridge the remaining price gap; Commander Ted Klapka, Deputy Assistant Program Manager for Systems Engineering, P-3C, Maritime Surveillance Aircraft Program Office, Arlington, VA, personal communication, July 13, 1995. For discussion of commercial avionics, see box 2-4.

<sup>31</sup> Defense integrator, personal communications, June 5 and July 24, 1995.

production; no new producer emerged, and no existing producer substantially increased production. The case also engendered friction by pitting U.S. FPD producers against U.S. computer manufacturers, and some FPD producers against others. This conflict had to be overcome before U.S. industry could work cooperatively (see box 3-3).

### ***The FPD Antidumping Case***

In the early 1990s, the FPD market grew sharply and Japanese FPD producers reaped the rewards. As miniaturized disk drives, keyboards, and other components became available at reasonable prices, computer manufacturers developed the first truly portable computer, the laptop. Laptops required FPDs; the CRTs used in desktop computers were too heavy and bulky and used too much power. Early laptops used EL and plasma displays, but the desire for high-resolution color graphics led manufacturers to the LCD. U.S. laptop manufacturers (primarily IBM, Apple, Compaq, and Tandy) required thousands of displays per month. U.S. FPD producers had never produced such volumes, and lacked the capital to ramp up for such production.

Many Japanese FPD producers, in contrast, had experience in volume manufacturing, ready access to capital, and internal demand for displays. While orders from U.S. laptop manufacturers to U.S. display producers might have enabled the latter to get financing to ramp up production, U.S. laptop manufacturers did not want to rely on unproved suppliers. Instead, the orders went to Japanese display producers, helping them to increase their already superior manufacturing capacity.

As one weapon against imports, in July 1990, several American FPD producers filed a joint anti-

dumping petition with the U.S. Department of Commerce's International Trade Administration (ITA) and with the U.S. International Trade Commission (ITC), an independent government agency whose commissioners are appointed to long terms by the President, but who are not otherwise responsible to the President. The petition alleged that high-information-content FPDs from Japan were being sold in the U.S. market at less than fair value (i.e., *dumped*), and that the sales at below fair value had caused material injury to the U.S. industry that produced such displays.<sup>32</sup> Under U.S. law, if these allegations were found to be true, the government would levy antidumping duties on those imports in an amount sufficient to bring the price up to the imports' fair value.

Antidumping investigations proceed as follows. The ITA divides the imports in question into one or more *classes* or *kinds* of merchandise. For each class of merchandise, ITA determines whether any petitioners produce a *like product* in the United States; if not, that class of merchandise is removed from the investigation. For each remaining class, the ITA determines whether U.S. sales at less than fair value have occurred and, if so, what the dumping margins are (i.e., the percentages by which the sale prices need to be increased by antidumping duties to bring them up to fair value). For each class in which sales at less than fair value have occurred, the ITC defines which domestic industry produces like products, and determines whether the dumped imports in that class have been a cause of material injury to the corresponding U.S. industry. (The ITC's definition of like products need not agree with the ITA's definition.)<sup>33</sup> The purpose behind the notions of *class of merchandise* and *like product* is that antidumping duties are justified only if U.S. producers and for-

<sup>32</sup> U.S. Department of Commerce, International Trade Administration, Import Administration, "High Information Content Flat Panel Displays and Display Glass Therefor From Japan," *Federal Register* 55(142):30042-30043, July 24, 1990. High-information-content flat panel displays were defined as having at least 120,000 pixels, with or without color, and using liquid crystal, plasma, or electroluminescent technologies.

<sup>33</sup> 19 U.S.C. 1673, 1677(4)(A); see *Hosiden Corp. v. United States*, United States Court of International Trade, Case No. 91-10-00720, Slip Op. 92-229 (Goldberg, J.), Dec. 29, 1992.

eign producers of dumped imports actually compete.

Formally, the FPD antidumping case was decided by applying the legal concepts of class of merchandise, fair value, like products, material injury, and causation to the facts at hand. However, both the legal concepts and the facts were sufficiently ambiguous that, in practice, both the ITA and the ITC, if they wished, had plenty of flexibility to let their decisions be influenced by political views that legally had no weight. Such views include whether the country needed a commercial FPD industry, what responsibility laptop manufacturers had to support a domestic FPD industry, and to what extent antidumping duties would harm U.S. laptop manufacturers and/or force their operations offshore (see box 3-5). It is difficult to say to what extent such political considerations influenced the decisions of the ITA and ITC.

Initially, the ITA defined all high-information-content FPDs as being in one class of merchandise, and the ITC defined the corresponding U.S. industry as all producers of high-information-content FPDs. Late in the process, however, ITA reversed its decision and found four classes of merchandise—PMLCDs, AMLCDs, EL displays, and plasma displays—on the grounds that the classes had different functional capabilities (e.g., power consumption, viewing angle, brightness, and weight) that “establish the boundaries of the FPD’s ultimate use and customer expectations.”<sup>34</sup>

This change profoundly affected the investigation’s results. No petitioner produced PMLCDs; therefore, ITA removed PMLCDs from the investigation.<sup>35</sup> The ITA found dumping margins of under half a percent for plasma displays, which, under U.S. law, are regarded *de minimus*, and the products are considered not to be dumped. Thus, PMLCDs and plasma displays—which accounted for over 75 percent of the value of high-information-content FPDs imported from Japan in 1990—could continue to be imported as before.<sup>36</sup> The ITA found dumping margins of 62 percent for AMLCDs and 7 percent for EL displays.<sup>37</sup> In 1990, AMLCDs accounted for only about 15 percent by value of Japanese high-information-content FPDs, and EL displays accounted for under 5 percent.<sup>38</sup> (In contrast, U.S. production of high-information-content FPDs was predominantly ELs.<sup>39</sup>) In order for antidumping duties to be levied against these imports, the ITC had to find that, though relatively modest in amount, these imports had caused material injury to U.S. manufacturers of like products.

Despite ITA’s switch, the ITC found that all types of high-information-content FPDs were *like* both the imported AMLCDs and the imported EL displays, based on “overlaps in physical characteristics and uses.”<sup>40</sup> Thus, the ITC considered injury to the U.S. high-information-content FPD producers as a whole. In August 1991, the ITC deemed it appropriate to consider the injury from

<sup>34</sup> U.S. Department of Commerce, International Trade Administration, Import Administration, “High Information Content Flat Panel Displays and Display Glass Therefor From Japan: Final Determination; Rescission of Investigation and Partial Dismissal of Petition,” *Federal Register* 56(136):32376-32402, July 16, 1991, p. 32379.

<sup>35</sup> *Ibid.*, pp. 32380-32382.

<sup>36</sup> U.S. International Trade Commission, *Certain High-Information Content Flat Panel Displays and Display Glass Therefor From Japan: Determination of the Commission, Investigation No. 731-TA-469*, USITC Publication 2413, August 1991, p. 9.

<sup>37</sup> U.S. Department of Commerce, *op. cit.*, footnote 34, p. 32401.

<sup>38</sup> U. S. International Trade Commission, *op. cit.*, footnote 36, p. 9, fn. 1.

<sup>39</sup> U.S. International Trade Commission, *Certain High-Information Content Flat Panel Displays and Display Glass Therefor From Japan: Views on Remand in Investigation No. 731-TA-469 (Final)*, USITC Publication 2610, March 1993, p. 1-22.

<sup>40</sup> *Ibid.*, p. 1-12; see also U. S. International Trade Commission, *op. cit.*, footnote 36, pp. 7-12.

## BOX 3-5: The Effects of FPD Tariffs on Domestic Computer Production

An issue of great importance hovered over the public debate concerning the flat panel display (FPD) dumping case: to what extent would the imposition of tariffs on FPDs negatively impact the domestic production of laptop computers? Specifically, what was the impact of the tariffs on domestic computer manufacturing employment? The computer industry asked the Commerce Department to carry out a balancing test, in which jobs in the small FPD industry would be weighed against jobs in the computer industry. By statute this consideration was irrelevant; however, some believe that the Commerce Department did informally consider such downstream effects.

Since displays represented a large fraction of the cost of producing laptops, in some cases making up half of the production cost, U.S. manufacturers of laptop computers (Apple, Compaq, IBM, and Tandy) argued that imposition of any substantial duties on active matrix liquid crystal displays (AMLCDs) would force them to move domestic production offshore. It should be noted, however, that there were no tariffs imposed on passive matrix liquid crystal displays (PMLCDs) or plasma displays, which together accounted for over 98 percent of laptop displays in 1991. The AMLCD market was growing rapidly at the time, however.

Japanese computer manufacturers (many of which manufactured displays, and were thus named in the dumping case) had recently begun moving final assembly operations to the United States. This was partly in response to the 100-percent duty levied on laptops imported from Japan in 1987, in retaliation for Japan's slowness in opening its semiconductor market. After a semiconductor agreement was reached in 1991, the duty was revoked, removing the penalty for assembling laptops offshore and importing them to the United States. With the imposition of stiff tariffs on the single most expensive component of laptops, assembly in the United States became much more costly (and dumping duties were not assessed on finished products containing AMLCDs, such as laptops).

After the antidumping duties were imposed, the Japanese company, NEC, canceled plans to assemble laptops in Massachusetts. <sup>1</sup>in September 1991, Toshiba announced that its American subsidiary would cease assembling laptops with AM LCD screens, moving operations back to Japan. Hosiden Corp., supplier for the Apple PowerBook series, stopped shipping screens soon after duties were imposed, diverting shipments instead to Apple's plant in Ireland.<sup>2</sup>in addition, Dolch Computer Systems moved its laptop production from California to Germany, and Compaq shifted production abroad from Texas <sup>3</sup>

in October 1991, IBM and Apple unsuccessfully petitioned the Commerce Department for permission to set up foreign trade subzones, which would allow them to import AMLCDs duty-free for assembly at their U S laptop manufacturing sites. The completed laptops would then be subject only to the four-percent U S computer tariff, or duty-free export <sup>4</sup>in November 1991, IBM's chairman, John Akers, stated that the computer-maker might be forced to move assembly of laptops containing AMLCDs offshore because the displays, imported from the IBM-Toshiba joint venture Display Technology Inc. , were subject to the AM LCD tariff <sup>5</sup>IBM closed its North Carolina assembly plant in 1992

(continued)

<sup>1</sup>Douglas Harbrecht, "Did Commerce Pull the Plug on Flat-Screen Makers?" *Business Week*, July 5, 1993, p 32

<sup>2</sup>David E. Sanger, "U.S. Tariff Appears To Backfire," *New York Times*, Sept 26, 1991, p. D. 1 The Commerce Department has estimated that Apple imported 70,000 laptops from its Ireland facility in the first year of the antidumping order

<sup>3</sup>Lisa Picarille, "Government Color LCD Tariffs Hurt Companies," *Infoworld*, Nov 18, 1991, p S83, John M Gleason and Muthu Karuppan, "Folly in Trade and Technology Policy," *IEEE Technology and Society Magazine*, summer 1993, pp. 6-7

<sup>4</sup>Jack Robertson, "IBM, Apple Computer Seek Trade Zone for Displays," *Electronic News*, Oct. 28, 1991, p 1

<sup>5</sup>David E Sanger, "IBM Chief Issues Threat on U S Tariff," *New York Times*, Nov. 8, 1991, p D4.

## BOX 3-5: The Effects of FPD Tariffs on Domestic Computer Production (Cont'd.)

Ultimately, the effects of the tariff may have been limited by the fact that, in many cases, only final assembly of laptop computers was taking place in the United States; many components, in addition to displays, are manufactured offshore. As a result, the jobs lost due to moving assembly offshore may be few and of a nature that added little value. Finally, lost assembly jobs probably were relatively few compared with the across-the-board layoffs by computer-makers in the 1990s.<sup>6</sup>

In principle, the antidumping duties could have induced Japanese AMLCD manufacturers to transfer production to U.S. sites. However, officials from Toshiba and NEC attested to the difficulties of increasing production yields in their Japanese plants. The immense difficulties manufacturers were having ruled out transfer of technology to the United States.<sup>7</sup> Sharp opened an AMLCD facility in Camas, Washington, in 1992; however, only final assembly work is done at this facility.

The effect of dumping duties on downstream (or upstream) industries is not currently a factor in the deliberations of the International Trade Administration or the International Trade Commission because the trade laws do not provide for such consideration. But it may be crucial to gauge the effects of trade decisions on related industries. Many proposed remedies for enhancing the international competitiveness of domestic manufacturers include a revamping of trade laws or an increased coordination of technology and trade policies.<sup>8</sup>

SOURCE: Office of Technology Assessment, 1995

<sup>6</sup>Neal Boudetta, "Battle Heats Up Over Flat-Panel Tariff," *PC Week*, February 1993

<sup>7</sup>Shin Kusunoki, "Japan to the Rescue?" *Electronics*, October 1991, pp. 27-28

<sup>8</sup>For an example, see Council on Competitiveness, "The Flat Panel Display Antidumping Decision," in *Road map for Results Trade Policy, Technology and American Competitiveness*, (Washington, DC: July 1993), pp. 23-38.

both AMLCD and EL imports together, and found that the combined imports were a cause of material injury to the U.S. FPD producers.<sup>41</sup> As a result, antidumping duties were initially levied on both AMLCDs and EL displays from Japan.<sup>42</sup> However, on appeal, the Court of International Trade found that the ITA's determination that AMLCDs and EL displays constituted separate classes of merchandise compelled the ITC to consider separately the injury from each class of imports, and remanded the case to the ITC with instructions to do so.<sup>43</sup>

On remand, the ITC found, in March 1993, that the AMLCD imports, while modest, were a cause of material injury to the U.S. industry, especially by making it harder for U.S. firms to get investment capital needed to gain production experience and realize economies of scale. However, the ITC found that the smaller EL imports were not a cause of material injury. Thus, antidumping duties were levied only on AMLCD imports.<sup>44</sup> However, these duties were removed shortly thereafter. In November 1992, OIS the only petitioner to produce AMLCDs, and under new ownership, had re-

<sup>41</sup>U.S. International Trade Commission, op. cit., footnote 36, pp. 23-27.

<sup>42</sup>U.S. Department of Commerce, International Trade Administration, Import Administration, "High Information Content Flat Panel Displays and Display Glass Therefor From Japan: Antidumping Duty Orders," *Federal Register* 56(171):43741-43742, Sept. 4, 1991.

<sup>43</sup>Hosiden v. United States, Op. cit., footnote 33, p. 18.

<sup>44</sup>U.S. International Trade Commission, op. cit., footnote 39, pp. I-1; I-1, fn. 3, I-15 through I-22; II-1; and VI-1 through VI-9.

quested that the duties be removed. In March 1993, the ITA removed the duties on the grounds that no domestic producer of like products supported retaining the duties.<sup>45</sup>

This history does not mean that antidumping duties could never be a part of a U.S. policy to foster an FPD industry. In the antidumping case, the Commerce Department seemed hostile to the domestic FPD industry and seemed to work at cross-purposes with the ITC. If the Commerce Department had handled the case differently, which it had discretion to do, different FPD manufacturers would not have been pitted against

each other, and duties would likely have been imposed on more types of FPDs and been in force longer. However, several cautions would apply to any use of antidumping proceedings as a policy tool. First, there are ramifications in terms of international trade rules and international goodwill. Second, antidumping duties would hurt downstream industries, such as computers, that might then need some offsetting government help. Third, antidumping duties by themselves, as was shown, are no guarantee that domestic production will start; if at all, such duties can be effective only as a supplement to domestic programs.

---

<sup>45</sup> U.S. Department of Commerce, International Trade Administration, Import Administration, "High Information Content Flat Panel Displays and Display Glass Therefor From Japan: Final Results of Changed Circumstances Administrative Review, Revocation of the Order and Termination of Administrative Review," *Federal Register* 58(121):34409-34414, June 25, 1993.

# Appendix A: Flat Panel Display Technologies and Domestic Firms

# A

**M**any technologies are used to create flat panel displays (FPDs). Some were developed years ago and fill small market niches; others have been brought to the stage of mass manufacturing and are now mature products; still others have yet to be commercialized, but promise superior performance and lower costs, compared with current technology. Numerous domestic firms are pursuing FPD technologies; most are small firms that focus on one or a few display approaches, but larger firms have also expressed interest. The distinguishing characteristic of the domestic FPD industry is the absence of high-volume manufacturing (see table A-1 for an overview of FPD technologies and domestic firms).

Chapter 3 outlined three potential strategies available to domestic FPD firms seeking a larger role in the global industry: 1) expand niche markets using established technologies; 2) catch up to leading-edge active matrix liquid crystal display (AMLCD) production; and 3) develop new leapfrog technologies. The following sections describe the technology choices associated with each approach, and place the activities of domestic firms into this framework.

## **ESTABLISHED TECHNOLOGIES: LCD, EL, PLASMA**

Two of the oldest FPD technologies are liquid crystal displays (LCDs) and emissive displays. LCDs are the primary example of transmissive FPDs, which modulate an external light source. Emissive flat panel displays use materials that emit light when an electric field is applied, through phenomena that include gas discharge, phosphorescence, fluorescence, and semiconductor photoemission.



**TABLE A-1: Flat Panel Display Technologies and Their Status in U.S. Firms**

<u>Technology</u>	<u>Leading U.S. firms</u>	<u>Production capacity</u>	<u>Strengths</u>	<u>Weaknesses</u>	<u>Foreign competition</u>
Passive matrix LCD: TN and STN	Standish Three-Five	2,3 million 2 to 3 million	low cost, simple manufacturing	response time, slow (TN) medium (STN); viewing angle limited; not scalable (TN); poor color	many firms in Japan, Taiwan, Korea, China, and Southeast Asia
Electroluminescent	Planar Norden Systems	120,000 5,000	bright; low power; simple manufacturing	no full color yet	Sharp
Gas plasma	Electro Plasma Plasmaco Photonics	6,000 15,000 5,000	bright, multicolor; scalable	high voltage; limited gray scale	Fujitsu, Matsushita/ NHK, Plasma Display Technical Forum, Thomson
Active matrix LCD: amorphous silicon TFT	<b>OIS</b> ImageQuest Xerox PARC	40,000 4,000 low quantities	excellent color, resolution	expensive; some yield problems; power hungry back-light, limited size	many firms in Japan; several in Korea and Taiwan
Active matrix LCD: other TFT and thin film diodes	Xerox PARC, David Sarnoff Research Center, Kopin	low quantities; (Kopin: 200,000 displays less than one inch)	high resolution	new technology; expensive substrate; difficult to scale up	Sony, Flat Panel Display Co., Litton Systems Canada
Field emission display	SI Diamond, FED, Coloray, Silicon Video, Raytheon, Micron Display, TI, Motorola	experimental quantities only	may be scalable	new technology	PixTech Japanese, Korean firms
Digital micromirror device	TI, Aura Systems	experimental quantities only	uses semiconductor processing	large-screen projection applications only	
Active addressed LCD	Motif, Positive Technologies	low quantities, external producers	high resolution; video rate; wide viewing angle	new technology; needs special drivers; not scalable	Optrex

KEY LCD = liquid crystal display, OIS = Optical Imaging Systems, PARC = Palo Alto Research Center, STN = supertwisted nematic, TFT = thin film transistor, TI = Texas instruments, TN = twisted nematic.

SOURCES: U.S. Department of Defense, *Building U.S. Capabilities in Flat Panel Displays. Report of the Flat Panel Display Task Force*, October 1994, table 2-1 (using Department of Commerce data), company reports, Office of Technology Assessment interviews with companies,



## ■ Passive Matrix Liquid Crystal Displays

Liquid crystal (LC) materials are organic substances that flow like liquids, but possess the ordered physical properties of crystalline solids. The type of liquid crystal materials used most often in displays is the nematic LC, which consists of rod-like molecules. Weak intermolecular forces in the nematic LC tend to make the molecules align themselves parallel to each other along the long axis, similar to the schooling of fish. However, the molecules are not ordered in well-defined layers, and electromagnetic forces can rotate and translate the molecules relative to each other. The method by which LC materials modulate light is by altering the *polarization* of light as it passes through the LC layers.

An LC *cell* is fabricated by enclosing LC material between two glass plates, each with transparent metallic electrodes deposited on its inside surface. To control the orientation of the molecules, the electrode layers are coated with a polymer deposited in a hard varnish form, which is then brushed in a straight line. The rod-like molecules tend to align themselves parallel to the direction of brushing on the glass. Polarizer sheets (which pass only light that is polarized parallel to the lines on the sheet) are attached to the outside of each glass plate, with the polarization direction oriented parallel to the alignment direction.

In the typical application of nematic LC materials, the *twisted nematic* (TN) liquid crystal display, each polarizer is oriented parallel to the direction of brushing on the adjacent glass plate, and the polarizer/glass plate pair is placed orthogonal (at a right angle) to the other pair. Since the alignment axes at the two LC-glass boundaries are now rotated 90 degrees relative to each other, the LC molecules align themselves in a spiral configuration within the cell, forming a helix (about an axis orthogonal to the cell faces) from one glass plate to the other. The LC molecules form layers parallel to the glass plates; each successive layer has a preferred direction rotated slightly from adjacent layers.

In the most common TN LCD configuration, called the *normally white* mode, the polarization

of light entering the LC layer is twisted 90 degrees as it passes through the LC material, and is transmitted by the second polarizer (see figure A-1). Thus, with no applied field—the *off* state—the cell is light. When an electric field is applied across the cell, the LC molecules rotate parallel to the field, perpendicular to the faces of the LC cell. In this configuration—the *on* state—the polarization of the light is unaltered as it passes through the LC material. Because the polarization direction of the light as it exits the liquid crystal layer is oriented orthogonal to the second polarizer, the light is blocked, and the cell appears dark.

A TN LCD is made by creating a matrix of row and column electrodes; each intersection of a row and a column defines a *pixel*. Each pixel is selected to be on or off (light or dark) through application of an electrical signal to a given row, and an additive or subtractive signal to each of the columns along that row. This produces relatively large voltages across the *on* pixels and smaller voltages across the *off* pixels. The entire matrix is scanned on a row-by-row, or *multiplex*, fashion, which means that each pixel is *refreshed* once per scanning period, typically one sixtieth of a second (16.7 milliseconds). Since LC materials typically remain in the untwisted state for hundreds of milliseconds after being refreshed, there is not a noticeable decay in pixel brightness between scans. Multiplex addressing allows a matrix of x rows and y columns to be addressed with a total of x plus y electrodes, rather than the x times y that would be required with direct addressing, in which each pixel has an electrode dedicated to it alone. Thus addressing a color VGA (video graphics array) display through multiplexing requires just over 2,000 electrodes, compared with nearly 1,000,000 electrodes that would be required to directly address each pixel. Gray levels—intermediate pixel brightness between light and dark—can be created by turning the pixel on and off either within a pulse or from frame to frame.

The performance of the TN LCD is limited by an inherent tradeoff between contrast and the number of pixels, or resolution. Since both the electrode voltage and the rate at which the display

FIGURE A-1: Twisted Nematic Liquid Crystal Cell

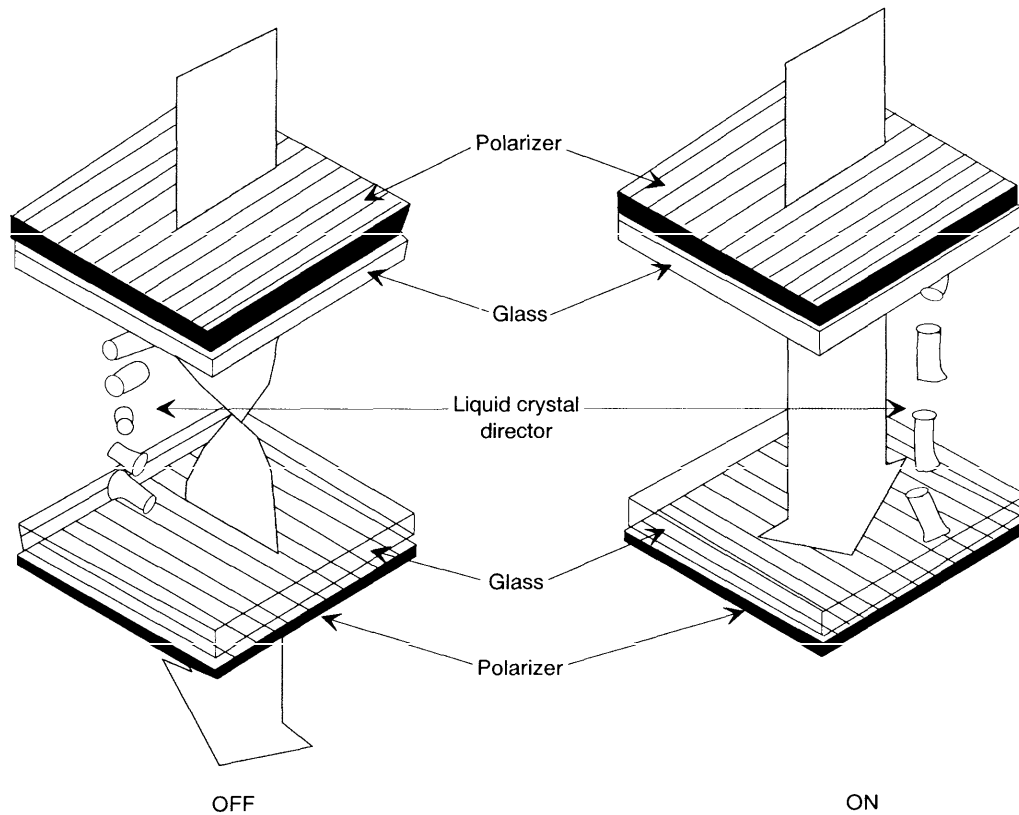

SOURCE: Terry Scheffer and Jurgen Nehring, "Supertwisted Nematic (STN) LCDs" in 1994 *SID International Symposium Seminar Lecture Notes* (Santa Ana, CA: Society for Information Display, 1994), vol. 1, seminar M-1, figure 1

pixels are updated (the *refresh rate*) are fixed, increasing the number of pixels decreases the difference between on and off signals and the amount of time that a voltage is applied to each pixel. Passive matrix schemes thus work well only for small numbers of rows in a TN LCD matrix, after which off pixels accumulate enough voltage to turn on partially. This effect, called *crosstalk*, increases with increasing numbers of rows in an array; for array sizes large enough to display television and computer images at an acceptable speed, the contrast between pixels becomes unacceptably low. This tradeoff between contrast and number of lines in the matrix has limited the use of TN LCDs to simple text and numeric displays in which the LC cells are arranged in fixed segments and are

addressed directly, instead of through a matrix (for instance, watch and calculator displays).

The most effective method for enhancing the performance of a multiplexed LCD is to increase the amount of twist in the LC cell above the 90 degrees used in the TN LCD. When the twist angle within the LC layer is increased to 270 degrees, the transmission of the LC becomes more sensitive to differences in voltage. Higher contrast ratios can be obtained through this technique, and larger numbers of pixels can be addressed compared with the TN LCD. The introduction of such *supertwisted* nematic (STN) LC displays enabled the use of LCDs in computer displays.

Although they perform better than TN LCDs in large displays, STN LCDs still suffer from cross-

talk and, thus, from the tradeoff between contrast and array size, or resolution. The scan time for a frame is too slow for full motion video display. Another limitation is that the large amount of twist results in separation of the color spectrum, called *birefringence*, producing nonuniform colors across the display. By using a second STN display with the opposite twist (double STN) or a layer of birefringent retardation film (film-compensated STN), true black and white displays can be fabricated. The latter approach is preferred because of its thin profile and light weight, and can be modified to display color through the placement of red, green, and blue color filters on one of the glass plates.

Despite these limitations, and the narrow viewing angle that limits most STN displays to single-person viewing, STN LCDs have found wide use as displays in portable computer screens and handheld electronic devices, and are the most common choice for passive matrix LCDs (PMLCDs). A recent innovation, called *dual-scan*, improves PMLCD performance by splitting the display horizontally and addressing each half independently. This reduces the effective number of rows in the display and, thus, the amount of crosstalk.

Standish Industries (Lake Mills, Wisconsin) is one of the most experienced American producers of PMLCDs. With \$25 million in annual sales, Standish produces more than two million displays per year. These are mostly low-information-content displays for commercial and industrial applications, such as tractors, gas pumps, and office equipment. Standish also makes some customized military applications and collaborates with other firms on AMLCD development (see next section).

Three-Five Systems (Phoenix, Arizona), a manufacturer of passive matrix LCDs, had sales growth of 125 percent in 1994, to \$85.5 million. Three-Five sells nearly five million LCDs per year (mostly manufactured in Asia) for use in handheld telecommunications, medical devices, and some military devices. Most of Three-Five's LCDs are low-information-content, alphanumeric displays, although a small portion are 1/4 VGA in resolution. In 1995, a new manufacturing facil-

ity opened in Phoenix. The facility, which has a capacity of over 280,000 square feet of LCDs per year, will produce more than 50 percent of Three-Five's LCDs; the remainder will continue to be purchased from Asian suppliers.

## ■ Electroluminescent Displays

Electroluminescence is the nonthermal emission of light generated by the application of an electric field to a material. Common arrangements use copper sulfide particles in a zinc sulfide lattice to serve as conductive or semiconductive inhomogeneities, ejecting electrons into a phosphor where they recombine to activate the emission process.

Electroluminescent displays (ELs) can be fabricated using a powder suspended in an insulator or, in the thin film EL (TFEL), using a thin (typically 0.5 microns) continuous film prepared by sputtering or vacuum evaporation (see figure A-2). The phosphor film is enclosed between two thin, transparent, insulating films, which are, in turn, sandwiched by transparent conductors. This conductor-insulator-phosphor-insulator-conductor stack acts as a capacitor; no light is emitted until the voltage reaches a threshold determined by the properties of the insulator and phosphor films. At the threshold voltage, electrons trapped at the insulator-phosphor interface are released into the phosphor film, activating luminescence. After passing through the phosphor, the electrons are re-trapped at the second insulator-phosphor boundary; on reversal of polarity, the action is repeated and the electrons return to the original interface. Above the threshold voltage, the brightness increases steeply with applied voltage, until a saturation voltage is reached.

The phosphor film often used is manganese-doped zinc sulfide, which emits yellow light. Other phosphors that have been developed emit blue, green, red, and white light, with varying brightness. The development of phosphors with adequate brightness in these colors has enabled the fabrication of full-color TFEL displays. ELs can be constructed to operate at video rates, have good brightness characteristics, and are thin and reliable. Like plasma, EL displays are limited by high

FIGURE A-2: DC and AC Electroluminescent Displays

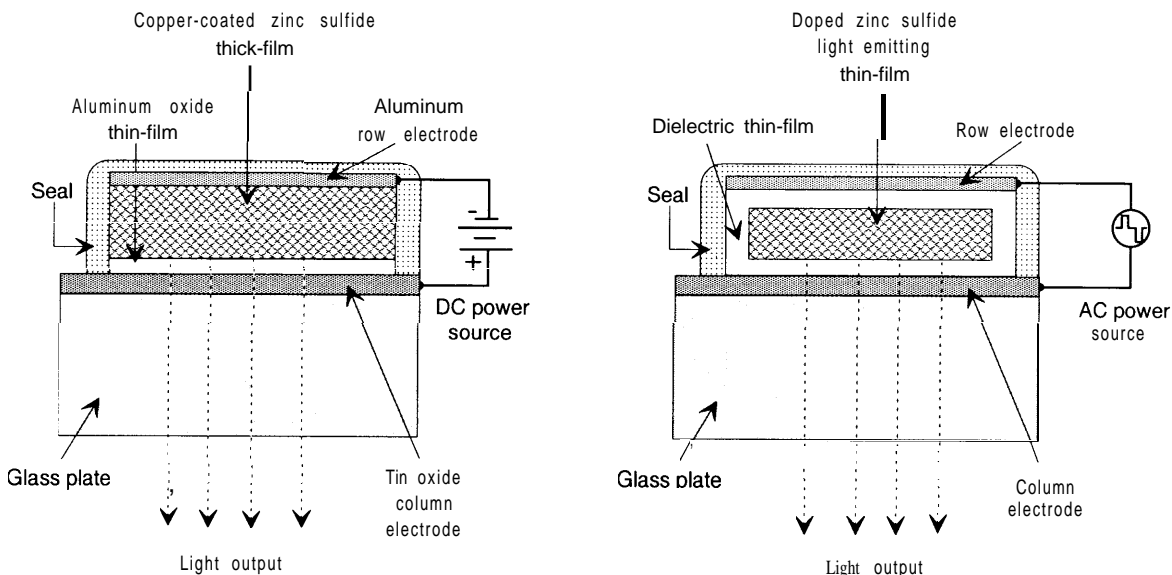

SOURCE Joseph A Castellano, *Handbook of Display Technology* (San Diego, CA: Academic Press, 1992), figures 61 and 62

power requirements and difficulties controlling gray levels.

Planar (Beaverton, Oregon) is the world leader in EL manufacturing. Roughly half of Planar's annual production of 120,000 displays are manufactured in the United States, and half at its plant in Finland. Most of its \$60 million in 1994 sales were in medical and industrial high-information-content displays. About 12 percent of sales were derived from military markets. Planar Advance, an avionics division recently acquired from Tektronix, is conducting cooperative R&D with Xerox on AMLCDs. Planar is leading a project funded by the Department of Defense's Advanced Research Projects Agency (ARPA) on thin film and active matrix EL technology for head-mounted displays.

Norden Systems (Norwalk, Connecticut), a subsidiary of Westinghouse, has produced EL displays since the early 1980s. Its plasma display plant in Connecticut was refitted in 1983 to manufacture EL displays. Norden earns most of its sales from customized, rugged, high performance military applications. The company plans

to pursue more commercial and industrial markets, including transportation applications.

## ■ Plasma Displays

Plasma devices operate on the principal of gas discharge. When subjected to an electric field, certain gases ionize, or break down into electrons and ions, causing the gas to glow. Plasma display fabrication is similar to LCD and EL manufacturing: glass plates with electrical conductors arranged orthogonal to each other encase the active material (typically a neon mixture) in a vacuum. The intersections of the row- and column- electrodes define the display pixels, effectively creating an array of miniature neon lamps. The characteristic color of plasma discharge is orange; in order to create color plasma displays, an ultraviolet-emitting gas is used to cause phosphorescent cell coatings—arrayed in sets of red, green, and blue—to glow.

The ability to fashion plasma display panels with high resolution (greater than 50 pixels per inch) in sizes greater than one meter in diameter has led some to consider using plasma technology

for high definition television displays. However, plasma systems have some drawbacks, including high power requirements; high cost and electronics complexity; and generally thick display panels.

Plasma displays use either direct current (DC) or alternating current (AC) drive schemes. By supplying a voltage level equal to half of the threshold ionization voltage for the gas to both a row electrode and a column electrode, the gas in the pixel at the crossover point will discharge, emitting light. Since each pixel is emitting for only a fraction of the time, the display is somewhat dim. DC plasma displays can use batteries as power sources, which allows for portability, but the low efficiency of plasma systems requires large amounts of power, limiting such applications.

To enhance the brightness of plasma displays, a method of keeping the pixels glowing for a longer period of time is necessary. This can be accomplished by using AC as the energizing source. The fluctuations of the AC signal cause charge to be added to existing charge on the electrodes, triggering another discharge. The pixels fire every time the voltage reverses, which is a greater proportion of the time, and the effect is a brighter display.

Photonics Imaging, a subsidiary of Photonics Systems (Northwood, Ohio), manufactures both monochrome and color AC plasma displays. Its facility has a capacity of 5,000 displays per year, which are mostly used in military applications. Photonics recently demonstrated a prototype of a 21-inch, 1280- by 1024-pixel, full-color, video rate display.

Plasmaco (Highland, New York) manufactures high-information-content AC plasma displays. Its plant has a capacity of 15,000 monochrome displays per year. Plasmaco recently developed a 21-inch, 640- by 480-pixel color prototype. Although all of the work on monochrome units is completed internally, Plasmaco purchases some of its color display subassemblies, including glass substrates, from foreign producers. Plasmaco sells mostly to business and commercial markets, and some to the military.

Electro Plasma (Milbury, Ohio) has been producing AC plasma displays since the mid-1970s. Its facility produces between 5,000 and 7,000 displays per year, mostly for military and medical applications. Electro Plasma is working on a color plasma display.

Other manufacturers, such as Babcock, Cherry, and Dale Electronics, produce low-information-content plasma displays for industrial controls, medical devices, and arcade games. Annual display revenues for these firms is in the range of \$10 million to \$15 million.

### ■ Other Emissive Displays

Two other types of FPDs are commonly used in low-information-content applications, such as appliance indicators and simple text or numeric displays. Vacuum fluorescent displays (VFDs) operate on a principle similar to cathode ray tubes. A wire filament (cathode) is heated, creating thermal emission of electrons. The electrons accelerate past a grid structure and land on an anode, which is covered with a phosphor that emits light in response to the incident electrons. The VFD is in essence a flat cathode ray tube (CRT), but, unlike the CRT, is used only in small, simple displays. It is a mature and inexpensive technology, however, and is used widely in products such as videocassette recorders. The dominant producers are Japanese companies, including Futaba, NEC, and Ise.

Light emitting diodes (LEDs) are solid state devices typically fabricated from single crystal gallium-based semiconductors. Light emission is created at the junction of two materials having different concentrations of available electrons, causing flow across the junction. When electrons are combined with holes, light is emitted as a by-product. Hewlett Packard (Palo Alto, California) is a leading manufacturer of LEDs. Although LEDs are very inexpensive and reliable, the difficulty of constructing large arrays has limited display applications to simple indicators and gauges.

**TABLE A-2: Comparison of Passive and Active Matrix Liquid Crystal Displays**

Feature	Passive matrix	Active matrix
Liquid crystal mode	supertwisted nematic	twisted nematic
Contrast ratio	10-20:1	>100: 1
Viewing angle (degrees) <sup>a</sup>	horizontal: ±30 vertical: ±25	horizontal ±60 vertical +45, -30
Gray scale	16	256
Response time (milliseconds)	100-200	30-50
Multiplex ratio <sup>b</sup>	480	>1000
Size (Inches diagonal)	17	<14
Manufacturing cost	simple moderate	complex high

**NOTES**

<sup>a</sup>Viewing angle is defined as the angle from the perpendicular to the display within which the image is visible at a contrast ratio greater than 5  
<sup>b</sup>Multiplex ratio determines the limit of addressable Pixel rows for the display.

SOURCES: Thomas L. Credelle, "Passive Matrix Liquid Crystal Displays, in *JTEC Panel Report on Display Technologies in Japan*, Lawrence E Tannas and William E. Glenn (eds.) (Baltimore, MD: Loyola College in Maryland, June 1992), table 4 2: F C Luo, "Active Matrix LC Displays," in *Liquid Crystals: Applications and Uses*, Vol. 1, Birendra Bahadur (ed.) (Singapore: World Scientific, 1990), table 151

Several research groups have experimented with organic polymers that emit light (as opposed to LEDs, which are made from inorganic substances). Such materials could be used in the future to create low-cost, flexible displays.

**THE LEADING COMMERCIAL TECHNOLOGY: ACTIVE MATRIX LIQUID CRYSTAL DISPLAYS**

The tradeoff between contrast and resolution in PMLCDs is a result of requiring the LC to handle both transmission modulation and addressing tasks. Active matrix addressing provides away of avoiding this tradeoff through the use of nonlinear switching elements at each pixel. Table A-2 compares passive and active matrix technologies in terms of several performance and production characteristics,

By addressing each pixel via a semiconductor switch and holding it in a steady state until addressed during the next scan, the active matrix allows for control over the transmission function of each pixel individually and independent of all other pixels. Since there is no crosstalk to limit the number of available pixels, AMLCD technology allows large, high-resolution displays. Since color displays require a threefold increase in the number of pixels, active matrix addressing has enabled

high performance LCDs for computer and television screens.

in an AMLCD (figure A-3), there is one switching element per pixel; this is typically a thin film transistor (TFT), but diodes have also been used in some AMLCDs. The TFTs in each row have one terminal connected to a row-addressing electrode (figure A-4). When a pulse is applied to a row

**FIGURE A-3: Cross-Section of Active Matrix Liquid Crystal Display**

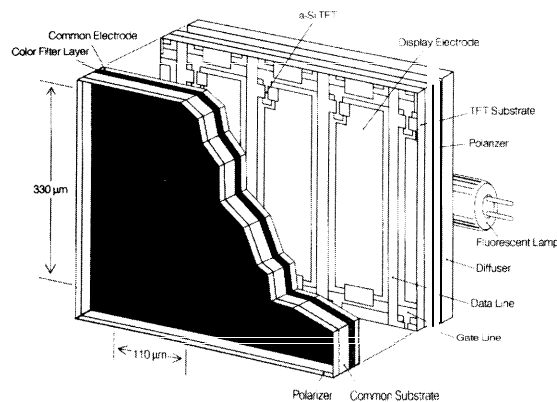

SOURCE: Steven W Depp, Director, Subsystem Technologies and Applications Laboratory, Thomas J. Watson Research Center, IBM, 1995

FIGURE A-4: Thin Film Transistor Active Matrix Array

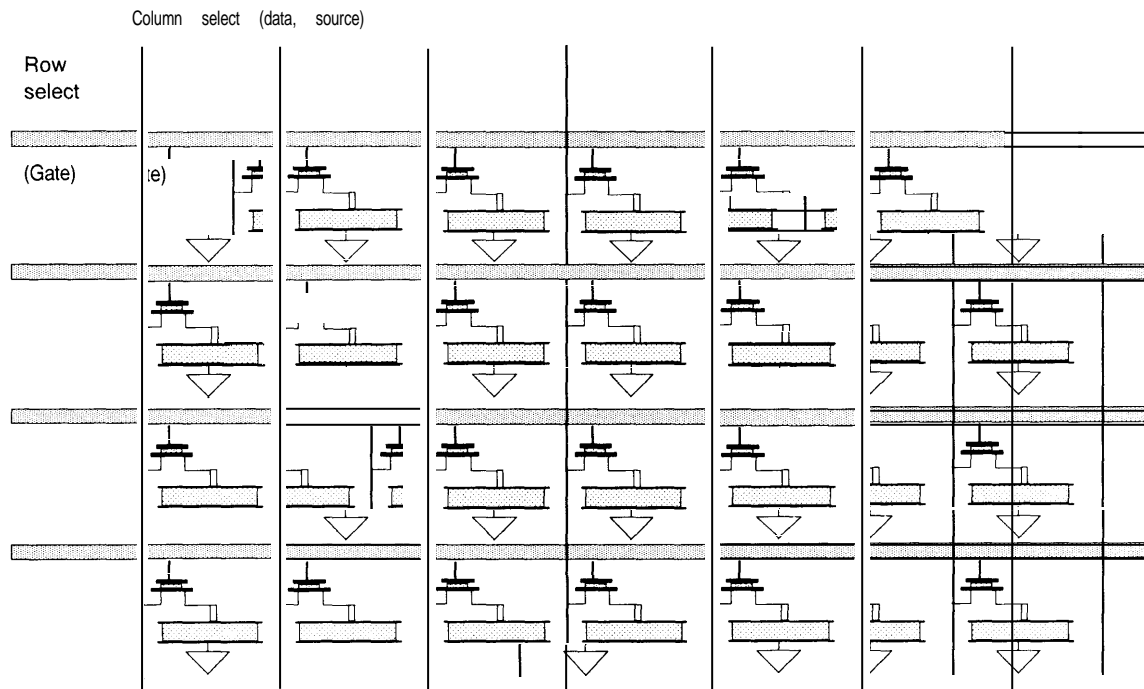

SOURCE. Arthur H Firester, "Active Matrix Technology," in *JTEC Panel/ Report on Display Technologies in Japan*, Lawrence E Tannas and William E Glenn (eds.) (Baltimore, MD Loyola College in Maryland, June 1992), figure 51.

electrode, each of the TFTs in the row is turned on, and the pixels in that row are ready to be addressed. The column electrodes, connected to a second terminal on the TFT, provide the appropriate voltage to set the gray level for each pixel. The third terminal of each TFT is connected to the active area of the LC cell. The LC material acts as a charge-storing capacitor, sandwiched between the TFT and a common electrode deposited on the other glass plate (a thin-film capacitor that stores charge is often added to each pixel). Each pixel can only be addressed when its TFT is on, thus eliminating pixel crosstalk; when the TFT is off, the charge is held in the LC capacitor until the next scan cycle, eliminating any effects due to relaxation of the LC material.

By allowing for many more pixels and using them in a redundant fashion, the AMLCD can produce better quality color than the PMLCD. Each pixel in a color display is made up of three or four

subpixels, filtered in the additive primary colors (red, green, and blue; often with an additional white or redundant color pixel), which are combined to create other colors. Multiple gray levels, combined with additive color, produce a large color palette. The use of absorptive color filters makes color AMLCDs quite robust to use under conditions of bright ambient light (such as encountered in aircraft cockpits), since most of the ambient light is absorbed by the color filters and not reflected back to the observer (as with a cathode ray tube).

Color displays also increase the power required to produce a given screen brightness, as color filters typically absorb 75 percent of the incident light. Together with the polarizers, which absorb about 60 percent, and the nontransmitting portions of the LC layer, which absorb roughly 50 percent, the overall transmission of a color AMLCD is about 5 percent. The fluorescent

lamps used in backlighting are efficient sources; even considering losses due to the diffusing plate used to smooth out the light from the narrow tubes, the backlight systems have efficiencies of 15 to 35 lumens per watt of electrical power. Accounting for the display transmission, the overall efficiencies for color AMLCDs are typically in the range of 1 to 2 lumens per watt. This is superior to the efficiency of cathode ray tubes, which are in the range of 0.5 to 3 lumens per watt.

Several types of nonlinear devices are used in AMLCDs to select and isolate individual cells for active matrix LCDs. The most common are amorphous silicon, polycrystalline silicon, and cadmium selenide TFTs. Due to several decades of solar cell research, amorphous silicon (a:Si) has the advantage of being the best understood material, and is used by most of the leading producers of AMLCDs.

### ■ Amorphous Silicon Thin Film Transistor AMLCDs

The predominant AMLCD TFT technology is the hydrogenated amorphous silicon thin film transistor (a:Si TFT). The a:Si TFT can be deposited at temperatures below 400 °C, allowing for the use of inexpensive glass substrates. While a:Si is well suited for the pixel elements, it has a low electron carrier mobility, limiting its use in fabricating row- and column-driver circuits. Column drivers must rapidly send data to all the pixels in a row during a row scan, and operate at frequencies greater than 10 megahertz in large arrays (row drivers are less demanding, operating in the kilohertz, because each row is held on while all the column data lines are pulsed). Unless the device features are 5 microns or less, a:Si cannot be used to fabricate display driver circuitry, which must be implemented in integrated circuits.

Optical Imaging Systems (OIS, Troy, Michigan) has built a medium-volume AMLCD manufacturing facility in Northville, Michigan, with a capacity of 40,000 displays per year. The majority of OIS's revenues comes from military programs. OIS produces customized FPDs for military systems and also sells displays to defense

contractors, who then further modify the displays. OIS also produces some displays for commercial systems, such as avionics, and is developing standard displays for such applications. In a cooperative development agreement with Apple, OIS has agreed to provide limited quantities of 10.4-inch displays for portable computer replacements. OIS is considering construction of a high volume (as large as 1 million displays per year) plant to supply such a market.

AT&T High Resolution Technologies (Berkeley Heights, New Jersey), Standish Industries, and Xerox Palo Alto Research Center (Palo Alto, California) are working together in the American Display Manufacturing Partnership (ADMP), which received an ARPA grant to develop manufacturing processes for AMLCDs. In addition to Standish's LCD fabrication capability, Xerox's AMLCD development and AT&T's packaging capabilities will be used to develop product prototypes. Although the ADMP began in 1991, the three firms have made no decision yet to move forward with any joint manufacturing operations.

ImageQuest Technologies (Fremont, California) is majority-owned (60 percent) by Hyundai, and works closely with Kent State's Liquid Crystal Institute. Its first product, a 6- by 8-inch AMLCD, is undergoing evaluation for a military display program. By 1997, ImageQuest expects its manufacturing facility to have a capacity of 4,000 displays per year.

Sharp Microelectronics Technologies (Camas, Washington) is a wholly owned subsidiary of Sharp Corp. of Japan. Over 300,000 AMLCDs and PMLCDs are assembled at the facility each year. Complete LC glass cells, backlights, and printed wiring boards are imported from Asia (mostly Japan). Sharp Microelectronics provides these standard LCDs for original equipment manufacturers of laptop computers in the United States.

### ■ Other AMLCDs

Polycrystalline silicon (p:Si) is similar to a:Si, but is deposited and annealed at a higher temperature



(above 600 °C) to give it a quasi-crystalline structure and higher electron mobility. The high temperature required for this process has limited production device sizes to approximately five inches in diagonal on quartz or high-quality glass substrates. The high electron mobility of p:Si allows the fabrication of drivers with the speeds necessary for large arrays on the same substrate as the TFTs. As the driver electronics (which are external to the display in a:Si AMLCDs) comprise much of the cost in AMLCD production, this could reduce manufacturing costs. The p:Si TFT was used in the first commercial LCD display, a 2-inch pocket television offered by Seiko-Epson in 1984. Expansion of the technique to larger displays has been slow, however. At present, the p:Si process has a market niche in projection displays and videocamera viewfinders that use AMLCDs of a few inches or smaller. Xerox's Palo Alto Research Center and SRI's David Sarnoff Research Center (Princeton, New Jersey) are developing p:Si displays.

One of the first materials used in TFTs was cadmium selenide (CdSe), which outperforms a:Si in several ways. Because of difficulties in handling CdSe and the dominance of silicon materials, it has only been used in a limited number of custom displays. Litton Systems Canada (Etobicoke, Ontario) uses CdSe for AMLCDs in its cockpit avionics systems.

Single-crystal silicon (X:Si) processing involves fabricating circuitry on a conventional silicon substrate, removing the circuit, and bonding it onto a display substrate (glass or plastic) that is then used to assemble an AMLCD. Active matrix circuits using x:Si have higher electron mobility than p:Si, and higher optical transmission than other AMLCDs.

Kopin Corp. (Taunton, Massachusetts), with assistance from DOD, developed the x:Si technique for producing AMLCDs. To date, the company has been successful in using the process to build a high resolution display on small (1/2-inch or 1-inch) squares. Kopin's facility has a capacity of 200,000 displays per year, but has only produced small quantities to date. These small

AMLCDs are used in helmet or head mounted displays (HMD) and in projection systems.

WAH III Technology (Novato, California) is also developing single-crystal silicon AMLCDs. Rather than peeling the etched circuitry from the silicon wafer, the WAH III process leaves the matrix and incorporates a reflective surface between the wafer and the active matrix. This small reflective AMLCD is currently used only for spatial light-modulating applications, but could develop into HMD and projection technology.

Future TFTs may be fabricated from organic polymers using simple printing techniques. Research groups have fabricated such devices and are developing production techniques. Unlike current TFTs, which use metals and semiconductors in a complex process, transistors made from organic polymers would be flexible. This would allow for plastic displays, which would be less costly to produce and lighter than glass displays.

Since transistors require connections between the row, column, and LC electrode at each pixel (figure A-4), TFT arrays must be fabricated by depositing the row- and column-electrodes and the TFTs on the same glass substrate. This has caused manufacturing problems because any deposition defects at the multiple crossover points lead to short circuits, creating bad individual pixels, rows of pixels, or columns of pixels. These problems have led to use of switching devices that only require connection to the column electrodes, thus separating the electrode sets onto separate substrates; semiconductor diodes have been used in this role, typically using metal-insulator-metal (MIM) fabrication techniques. The production process is simple, uses low-cost glass substrates, and can be done at temperatures below 300 °C. Diode arrays can be produced more reliably than TFT arrays because the row electrodes are fabricated on one glass substrate and the diodes and column electrodes are fabricated on the other, avoiding the possibility of crossed electrodes on either layer. MIM devices do suffer from limited nonlinearity and strong temperature sensitivity, resulting in gray scale nonuniformities. In terms of manufacturing cost and complexity, and device

**FIGURE A-5: Plasma Addressed  
Liquid Crystal Display**

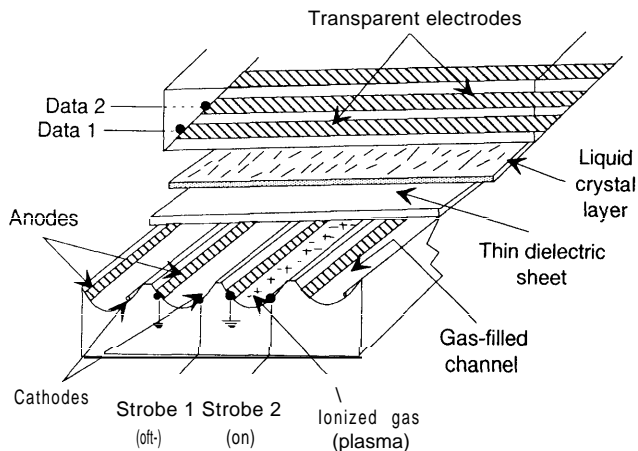

SOURCE: Joseph A Castellano, *Handbook of Display Technology* (San Diego, CA Academic Press, 1992), figure 812

performance (contrast ratio and color display), MIM technology falls between the TFT AMLCD and passive matrix LCDs. The leading firms in this area are Seiko-Epson of Japan and FPD Co. of Europe.

Another hybrid approach to AMLCDs involves using channels of ionized gas instead of rows of TFTs as the switching mechanism, combining gas plasma and LCD technologies. In plasma-addressed LC (PALC) displays, the channels are etched into the glass substrate, filled with an inert gas such as helium or neon, and sealed (figure A-5). The channels make up the rows of the array, and are fitted with two electrodes. When a voltage is applied to the electrodes, the gas in the channel becomes ionized and conducts current. The columns run perpendicular to the gas channel rows, and supply the analog pixel data. The LC is sandwiched between the row electrode array and the gas channels. Because the ionized gas is needed to complete the LC charging circuit, the column data voltages only have an effect on the pixels in a row for which a plasma channel is switched on. Thus, by charging the channel rows in sequence and sending data signals during the time the gas is switched on, the display is addressed row by row.

Unlike AMLCDs that use TFTs, this technology is not limited in size by the semiconductor deposition process, and thus could potentially allow for low-cost production of large displays. PALC technology was developed by Tektronix (Beaverton, Oregon), which spun off a firm called Technical Visions, Inc. to pursue it; the new firm has developed a 16-inch prototype and signed a development agreement with Sony.

### LEAPFROG TECHNOLOGIES: FED, DMD, and OTHER LCDs

Several FPD approaches currently underdevelopment could result in displays that produce higher quality images, require less power, and cost less to produce than commercially available FPDs. The two leading technologies are the field emission display and the digital micromirror device. While these technologies could leapfrog the AMLCD, they are closely related to established technologies such as the cathode ray tube and the semiconductor chip.

#### ■ Field Emission Displays

The field emission display (FED) is similar to the cathode ray tube in that it aims beams of electrons at phosphors deposited on the inside of a glass screen that emit light. Rather than one large electron gun, however, the FED uses arrays of *microemitters* in a flat display matrix. Each pixel consists of a large number of microemitters (often thousands), each about 1 micron in size and made of metal (such as molybdenum), silicon, or diamond, sealed in a vacuum (see figure A-6). Electrons are ejected from the microemitters under a high electrical field, and are accelerated onto the opposing phosphor. The redundancy of emitters for each pixel allows for failures of individual emitters without performance degradation, and the proximity of the microemitters to the phosphors provides sharp focusing. Production difficulties can arise from nonuniformities in the microemitters (resulting in brightness variation) and loss of vacuum (reducing microemitter performance). By replacing the microemitters with a thin diamond film, deposited by a silk-screening

FIGURE A-6: Field Emission Display Microemitter

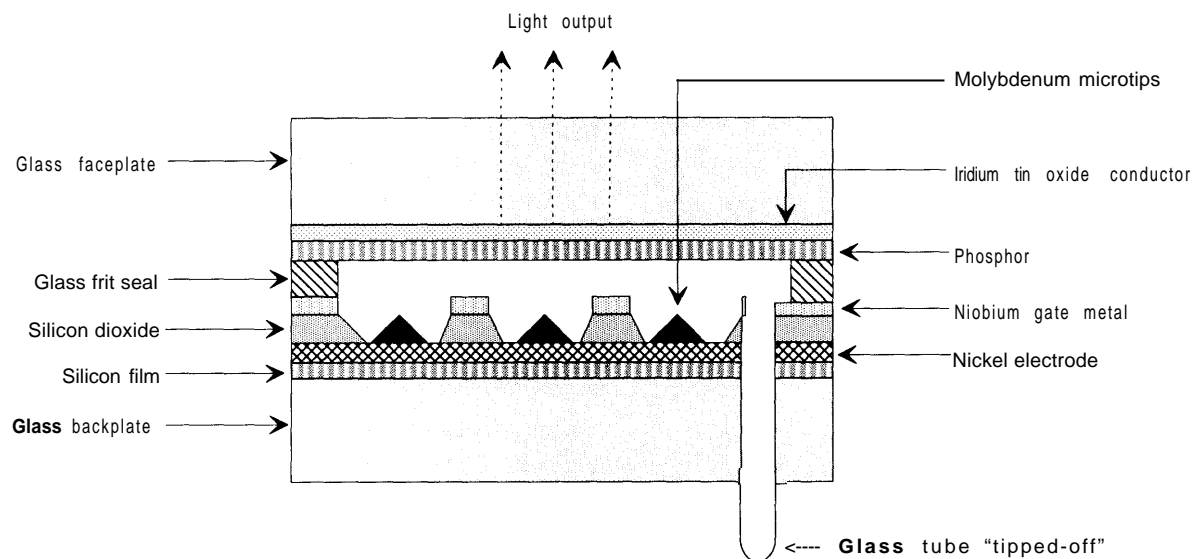

SOURCE: J.A. Castellano, *Handbook of Display Technology* (San Diego, CA: Academic Press, 1992), figure 91

process, some of the fabrication difficulties can be mitigated.

PixTech of France was formed in 1992 to commercialize developments in FED technology at the Laboratoire d'Electronique, de Technologies et d'Instrumentation (LETI), a research laboratory of the French atomic energy agency that had built on work done at the American firm, SRI International. PixTech holds the rights to several FED approaches, and produced the first 6-inch diagonal FED. PixTech has formed alliances to accelerate the commercialization of FED; in addition to the Japanese firm Futaba, PixTech has signed bilateral cross-licensing agreements with Texas Instruments (TI; Dallas, Texas), Raytheon (Quincy, Massachusetts), and Motorola Corp. (Schaumburg, Illinois). Under the agreements, PixTech licenses FED technology developed at LETI, in return for the technology developed by each of the U.S. firms as it existed at the time of the agreement, and as it is subsequently developed over the period of the agreement, expected to be three years.

Raytheon, TI, and Motorola have also collaborated with the government to develop FED technology; Raytheon and TI are leading an ARPA project, and Motorola has worked with Sandia National Laboratories.

Coloray Display Corp. (Fremont, California) is also developing FEDs, and plans to begin pilot manufacturing in 1997 or 1998. Coloray is concentrating R&D efforts on low-voltage phosphors, glass sealing, electron optics, and lithography to improve manufacturing processes. Current R&D work is focusing on a process to construct larger FEDs.

FED Corp. (Hopewell Junction, New York) is developing a 7-inch, high-resolution FED for customized military applications. The company began building production facilities in 1994; the facility has a capacity of 10,000 plates per month. It has also worked with Zenith on large screen applications and with two other U.S. firms on a 10.5-inch prototype.

Micron Display Technology (Boise, Idaho) is a subsidiary of Micron Technologies, a leading U.S.

**FIGURE A-7: Digital Micromirror Device, Individual Pixel**

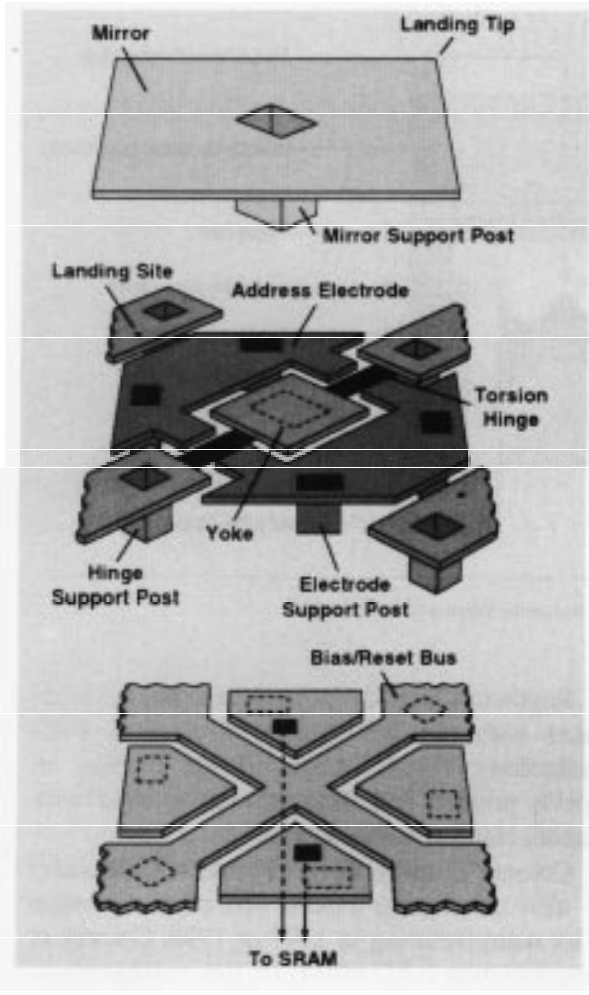

**SOURCE:** Gary Feather, Marketing Manager, Digital Imaging Venture Projects, Texas Instruments, 1995.

producer of memory chips. Micron has produced high-resolution, 1-inch FEDs for head-mounted displays, and has plans to produce FEDs of 10 inches and larger for portable computers.

SI Diamond Technology (Houston, Texas) has pioneered the use of thin diamond films instead of microemitters, with the assistance of several government grants. The company has developed a monochrome prototype, and initial production is planned for 1996. In work with the Phosphor Technology Center of Excellence, SI Diamond

has devised and is patenting a means to extend the lifetime of low-voltage color phosphors to 25,000 hours. The company is also working with Russian partner, DiaGasCrown, on thin film diamond technology.

Silicon Video Corp. (Cupertino, California) is building prototypes and plans for full volume production in 1997. It is the leader of an ARPA-funded project to develop FED manufacturing technology. The company has strong corporate backing and the cooperation of Compaq and Hewlett Packard.

### ■ Reflective Displays

Reflective devices form images by controlling individual mirror elements in an array. Since an image cannot be viewed directly from a mirror array, reflective systems operate in projection mode, in conjunction with a high-intensity light and optical system. The image is projected onto a translucent screen from behind, or an opaque screen from the front, and allows large groups to view computer or television images.

The primary technique under investigation is called the digital micromirror device (DMD), developed by TI. The DMD is an electromechanical structure that is deposited using conventional semiconductor materials, processes, and fabrication lines in a standard integrated circuit chip package. The device contains an array of transistors over which an aluminum layer (etched into an array of square micromirrors) is deposited. Each mirror corresponds to a transistor, and is attached at two diagonally opposing corners to support pillars with torsion bars (figure A-7). Current passing through a transistor creates an electrostatic field, causing the mirror to tilt in response. In one position (the light state), the mirror reflects light from an illumination source to a projection system; in the other position (the dark state), the light is reflected away from the projection system. By flipping the mirror between light and dark states, continuous gray levels may be produced—the more often the mirror is in the light state, the brighter the corresponding pixel. By combing the reflection from three different colored light

sources, a full-color display can be created. The response time of the device is very fast, and displays of 442,000 mirrors have been fabricated with scan rates of 100 per second. TI has not yet produced the display in commercial quantities, although it has entered into product development agreements with In Focus, Nview, Proxima, Rank Brimar, and Sony. Aura Systems (El Segundo, California) is developing a similar technology, but one that uses an analog, as opposed to digital, scheme.

### ■ Other LCD Materials and Addressing Schemes

LCDs made from ferroelectric liquid crystals (FLCs) exhibit switching speeds that are much faster than nematic LCDs, and have inherent memory: once set, the FLC remains in the same state, even after the electric field is removed. This memory property provides a method for getting around the tradeoff between contrast and resolution because, even in large arrays, individual cells remain at a constant state indefinitely. Since FLCs only have two states, however, they are not capable of displaying gray scales—and thus full color—which is a barrier to their use in computer and television displays. FLCs use a thin LC layer, producing wide viewing angles, because viewing angle increases with decreasing LC thickness. However, the tight assembly tolerances required by the thin layer make them hard to produce and sensitive to shock and vibration.

As yet, FLCs have not been produced in any large amounts, but Canon of Japan has developed several prototypes. In the United States, Displaytech and Boulder Nonlinear Systems (both of Boulder, Colorado) produce custom FLCs for research applications.

Another material in the research stage is the polymer-dispersed liquid crystal (PDLC)—also referred to as nematic curvilinear aligned phase (NCAP)—which scatters light at rest and transmits light under the presence of an electric field. The PDLC/NCAP display is made by encapsulating LC material in a transparent polymer, which is then sandwiched between layers of plastic coated

with a transparent conducting film. The walls of the capsules do not alter the random alignment of the LC, causing scattering and an opaque appearance in the off state. The application of an electric field causes the LC molecules to be aligned with the field. The LC material then appears transparent and the pixel is on. Since they do not require the use of polarizers (which account for a large share of transmission loss in LCDs), PDLC displays have high transmittance. In addition, PDLC materials can be deposited on flexible plastic substrates. This could allow for high volume production runs on equipment used for handling polymer film. Due to difficulties in addressing arrays of pixels, however, PDLC cannot currently be multiplexed into high-information-content displays.

Raychem Corp. (Menlo Park, California) is currently developing PDLC displays, which are used with a reflective backing in a projection system. Kent Display Systems (Kent, Ohio) has developed a polymer-stabilized cholesteric-texture LCD; this LCD transmits as much as 90 percent of incident light, and is targeting low-information-content applications such as highway signs.

The response time of STN LCDs is just fast enough to follow cursor movement on a computer display, but too slow to display full motion video images. In an effort to improve video performance, several methods—referred to variously as active addressing, adaptive scanning, or multiline selection—have been developed to replace the common multiplex technique. These approaches use algorithms, hard-coded into electronic circuits off of the display, to drive the rows and columns in complex ways. Instead of sending a high voltage pulse down the rows, a set of predetermined signals (in the case of active addressing, based on Walsh functions) are applied to multiple rows simultaneously and a voltage, whose value depends on the state of the pixels in that column, is applied to the columns. The algorithms determine which rows need which signals, and calculate the proper column voltage within the timeframe allotted. In addition, the LCD has to be capable of switching at video rates; this means decreasing the cell thickness and using fast LC material. The active ad-

addressing approach allows for any number of lines (currently up to 255) to be addressed simultaneously.

In Focus Systems (Tualatin, Oregon) developed the active addressing technique, and is the world market leader in PMLCD projection systems. Although their products use both AMLCDs and PMLCDs, these displays are acquired externally, mostly imported, and incorporated into their systems. In Focus has invested this know-how in Motif (Wilsonville, Oregon). Motif is a \$21-million joint venture between In Focus and Motorola to produce PMLCDs using the active addressing technique for use in commercial and communications applications. Initial plans to build a pilot

manufacturing plant were scrapped in 1994, and the development of the application-specific integrated circuit (ASIC) prototype needed for active addressing was 18 months behind schedule. In March 1995, Motorola announced its intention to drop its share in the venture. Positive Technologies (San Diego, California) has developed the adaptive scanning technique for PMLCD performance enhancement. Although the technology has been provided to other producers of LCDs for business, transportation, and military applications, volumes have remained small. Multiline selection has been developed by Optrex of Japan, and is used in commercially available displays.

# Appendix B:

## List of

# Acronyms

# B

a:Si	amorphous silicon	DC	direct current
AC	alternating current	DMD	digital micromirror device
ADC	American Display Consortium	DOC	Department of Commerce
ADMA	Advanced Display Manufacturers of America	DOD	Department of Defense
ADMP	Advanced Display Manufacturing Partnership	DPA	Defense Production Act
AFB	Air Force Base	DRAM	dynamic random access memory
AMLCCD	Active Matrix Liquid Crystal Cockpit Display project (DOD)	DTI	Display Technology, Inc.
AMLCD	active matrix liquid crystal display	DVE	Driver Vision Enhancement program (U.S. Army, DOD)
ARPA	Advanced Research Projects Agency (DOD; formerly DARPA)	ECAM	European Consortium Active Matrix
ASIC	application-specific integrated circuit	EDI	Electronic Designs, Inc.
ATI	air transport indicator	EL	electroluminescent
ATP	Advanced Technology Program (NIST, DOC)	ERSO	Electronics Research and Service Organization (Taiwan)
AWACS	Airborne Warning and Command Systems	ESPRIT	European Strategic Programme for Research and Development in Information Technologies
CGR	Combined Guard and Reserve (U.S. Air Force, DOD)	ESTO	Electronics Systems Technology Office (ARPA, DOD)
COB	chip-on-board	EU	European Union (formerly European Community)
COF	chip-on-film	FASA	Federal Acquisition Streamlining Act of 1994
COG	chip-on-glass	FBIS	Foreign Broadcast Information Service
CRT	cathode ray tube	FED	field emission display
DARPA	Defense Advanced Research Projects Agency (DOD; now ARPA)	FLC	ferroelectric liquid crystal
		FPD	flat panel display

## 106 | Flat Panel Displays in Perspective

GATT	General Agreement on Tariffs and Trade	NORAD	North American Air Defense (Strategic Air Command, DOD)
GTC	Giant Technology Corp. (Japan)	NSF	National Science Foundation
HDS	High Definition Systems program (ARPA, DOD)	NTT	Nippon Telephone and Telegraph (Japan)
HDTEC	High Definition Television Engineering Corp. (Japan)	OEM	original equipment manufacturer
HDTV	high definition television	OIS	Optical Imaging Systems
HMD	helmet/head mounted display; also Helmet Mounted Display program (ARPA, DOD)	PALC	plasma-addressed liquid crystal display
HRS	High Resolution Systems program (ARPA, DOD)	PDA	personal digital assistant
IC	integrated circuit	PDP	plasma display panel
ITA	International Trade Administration (DOC)	PDLC	polymer dispersed liquid crystal display
ITC	International Trade Commission	PMLCD	passive matrix liquid crystal display
JKTC	Japan Key Technologies Center	p:Si	polycrystalline silicon
LC	liquid crystal	PTCOE	Phosphor Technology Center of Excellence
LCD	Liquid crystal display	R&D	research and development
LCU	Lightweight Computer Unit program (U.S. Army, DOD)	SAGEM	Societe d'Applications Generales d'Electricite et de Mechanique (France)
LED	light emitting diode	SAIC	Science Applications International Corp.
LETI	Laboratoire d'Electronique, de Technologie et d'Instrumentation (a research laboratory of the French atomic energy agency)	SID	Society for Information Display
MIM	metal-insulator-metal	STN	supertwisted nematic
MITI	Ministry of International Trade and Industry (Japan)	SVGA	super video graphics adapter
MPT	Ministry of Posts and Telecommunications (Japan)	TAB	tape automated bonding
NASA	National Aeronautics and Space Administration	TDS	Tactical Display Systems program (ARPA, DOD)
NCAICM	National Center for Advanced Information Components Manufacturing	TFEL	thin film electroluminescent display
NCAP	nematic curvilinear aligned phase	TFT	thin film transistor
NFPDI	National Flat Panel Display Initiative	TI	Texas Instruments
NHK	Nippon Hoso Kyokai (Japan's national broadcasting company)	TN	twisted nematic
NIST	National Institute of Standards and Technology (DOC)	TRP	Technology Reinvestment Project (DOD)
		USDC	U.S. Display Consortium
		VCR	video cassette recorder
		VTR	video tape recorder
		VFD	vacuum fluorescent display
		VGA	video graphics adapter
		x:Si	single crystal silicon
		XGA	extended graphics array