

San Jose State University
SJSU ScholarWorks

Faculty Publications

Electrical Engineering

11-30-2010

Error Correcting Codes for Cooperative Broadcasting

Robert H. Morelos-Zaragoza

San Jose State University, robert.morelos-zaragoza@sjsu.edu

Follow this and additional works at: https://scholarworks.sjsu.edu/ee_pub

 Part of the [Electrical and Computer Engineering Commons](#)

Recommended Citation

Robert H. Morelos-Zaragoza. "Error Correcting Codes for Cooperative Broadcasting" *Faculty Publications* (2010).

This Presentation is brought to you for free and open access by the Electrical Engineering at SJSU ScholarWorks. It has been accepted for inclusion in Faculty Publications by an authorized administrator of SJSU ScholarWorks. For more information, please contact scholarworks@sjsu.edu.

Error Correcting Codes for Cooperative Broadcasting

Robert Morelos-Zaragoza
Electrical Engineering Department
San José State University

Presented at the ISL Symposium
Stanford University
November 30, 2010

Outline

1. Motivation
2. Related work
3. Broadcast channels
4. Multilevel codes and the $|u|u+v|$ construction
 - Time sharing $|u|v|$ versus $|u|u+v|$ construction
 - Decoding for $|u|u+v|$ construction: Two stages versus single state
5. Demapping and decoding performance
 - BPSK and QPSK modulations
 - 4-PAM modulation: Hierarchical mapping
6. Conclusions and future work

1. Motivation

- Background on ***unequal error protection (UEP) codes***:
Ph.D. thesis on multilevel error-correcting codes
- UEP codes are based on the idea of ***superposition coding*** proposed in Cover's paper (1972) on broadcast channels
- The nodes of a wireless network (cooperative or not) always broadcast information (i.e., every node, in principle, receives this information)
- ***Cooperative broadcasting*** paper (Bergmans and Cover ,1974)
"Superposition coding always outperforms orthogonal (time-division or frequency-division) schemes"

Broadcasting in a Wireless Network

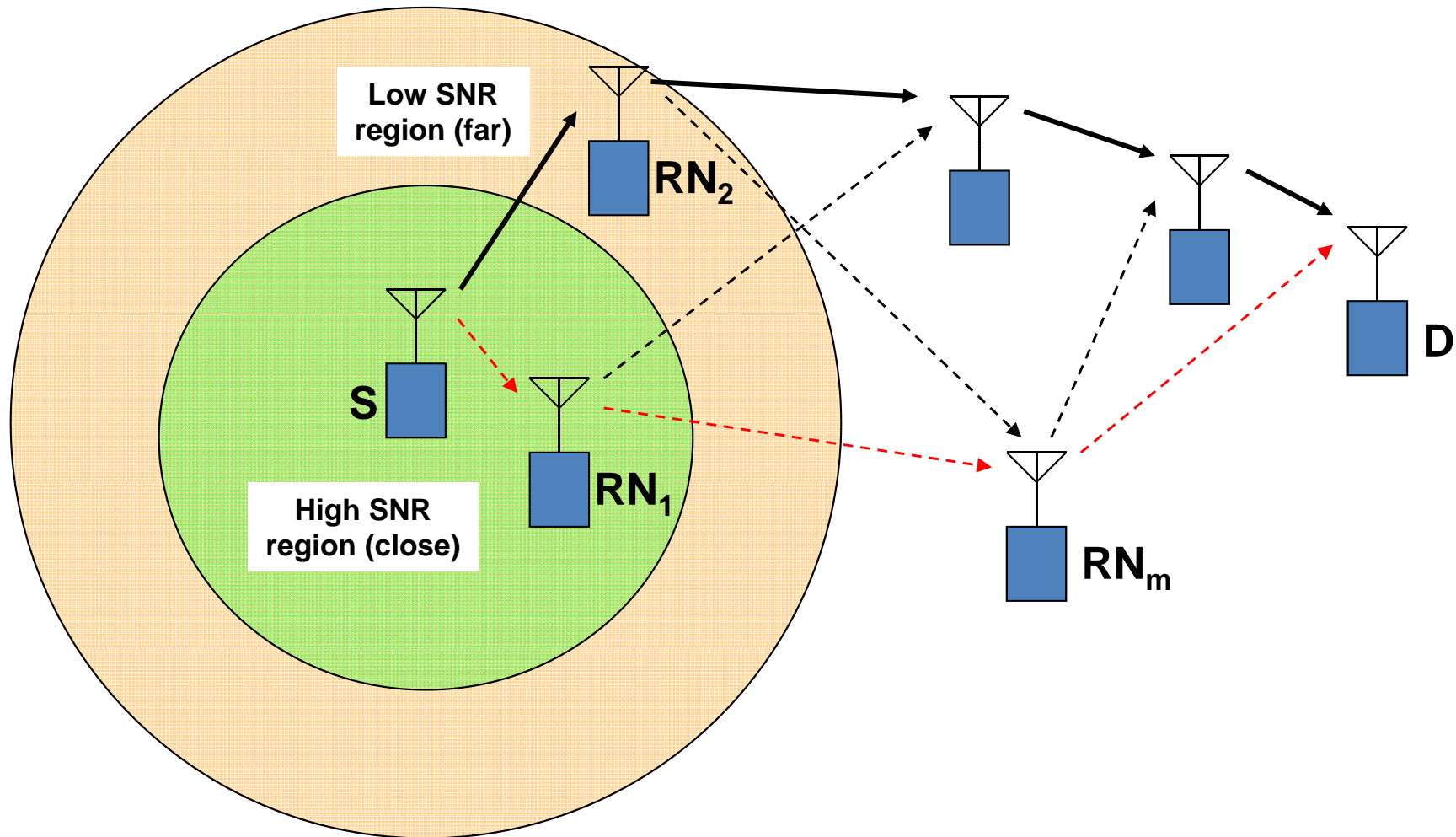

1. Relay RN_1 has higher SNR compared to $RN_2 \rightarrow C_1 > C_2$
2. "Shortest path" (smallest number of hops) not always most reliable

2. Related work

- Cover (1972): “Broadcast Channels”
 - Cloud structure of capacity-achieving superposition codes
- Bergmans and Cover (1974): “Cooperative Broadcasting”
 - Superposition codes always outperform orthogonal assignment
- Laneman, Tse and Wornell (2004): “Cooperative Diversity in Wireless Networks: Efficient Protocols and Outage Behavior”
 - Amplify-and-forward, decode-and-forward, adaptive relaying, incremental relaying
- Stefanov and Erkip (2004): “Cooperative Coding for Wireless Networks”
 - Propose superposition coding. Do not refer to Cover!!?
- Yi, Azimi, Kalyanaraman and Subramanian (2005): “Error Control Code Combining Techniques in Cluster-based Cooperative Wireless Networks”
 - Use Chase code-combining with hybrid ARQ

Related work (cont.)

- S. Katti, H. Rahul, W. Hu, D. Katabi, M. Medard, and J. Crowcroft,: XORs in The Air: Practical Wireless Network Coding,” (2006)
 - Opportunistic coding
- Chen and Ahmed (2008): Throughput Enhancement in Cooperative Diversity Wireless Networks using Adaptive Modulation
 - Feedback CSI and adapt constellation accordingly
- Li, Ge, Tang and Xiong (2008): Cooperative Diversity Based on Alamouti Space-Time Code
 - Multiple-access stage of relay nodes achieved with Alamouti’s scheme
- L. Xiao, T.E. Fuja, J. Klierer and D.J. Costello (2009): Error Performance Analysis of Signal Superposition Coded Cooperative Diversity
 - Consider superposition coding performed at a single source, metrics
- H.J. Yang, Y. Choi and J. Chun (2010): Modified High-Order PAMs for Binary Coded Physical-Layer Network Coding
 - Constellation design for superposition (physical layer) network coding

3. Broadcast Channels

- Thomas Cover (1972) – Gaussian broadcast channel with one source broadcasting information to two users: User 1 has a larger signal-to-noise ratio (SNR) than User 2 ($N_1 < N_2$):

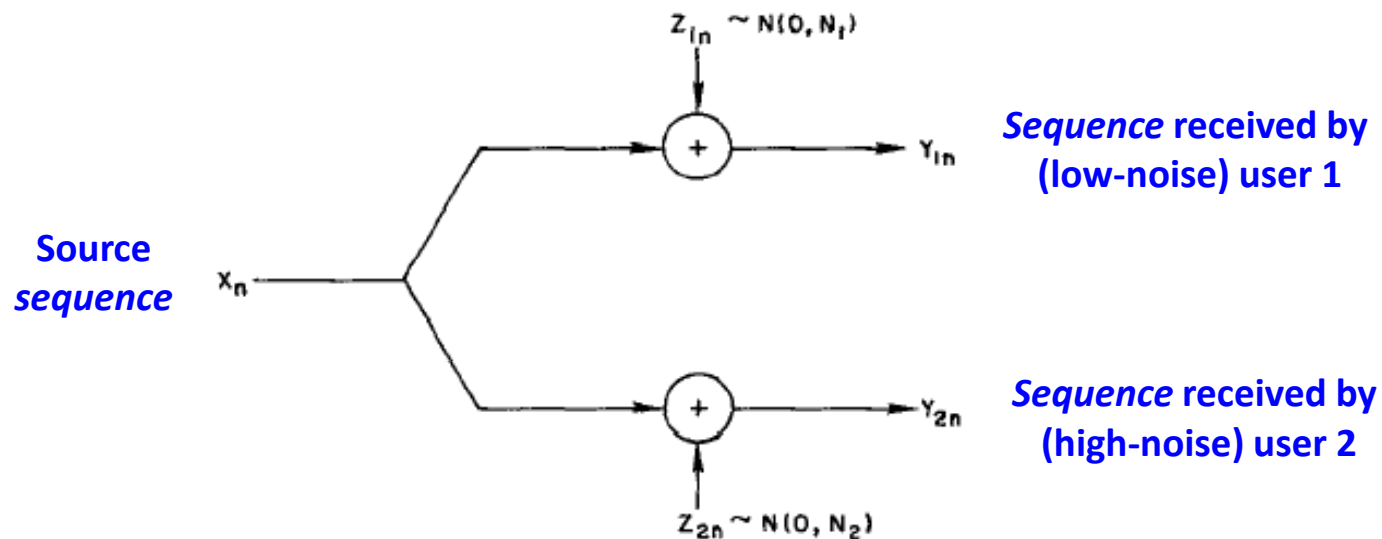

Fig. 16. Gaussian broadcast channel.

From: T. Cover, "Broadcast Channels," *IEEE Trans. Info. Theory*, vol. IT-18, no. 1, pp. 2-14, Jan. 1972

Coding for broadcast channels: Cloud concept

- Cover showed that a channel code achieving capacity has a **cloud structure**, shown below for a binary symmetric broadcast channel:

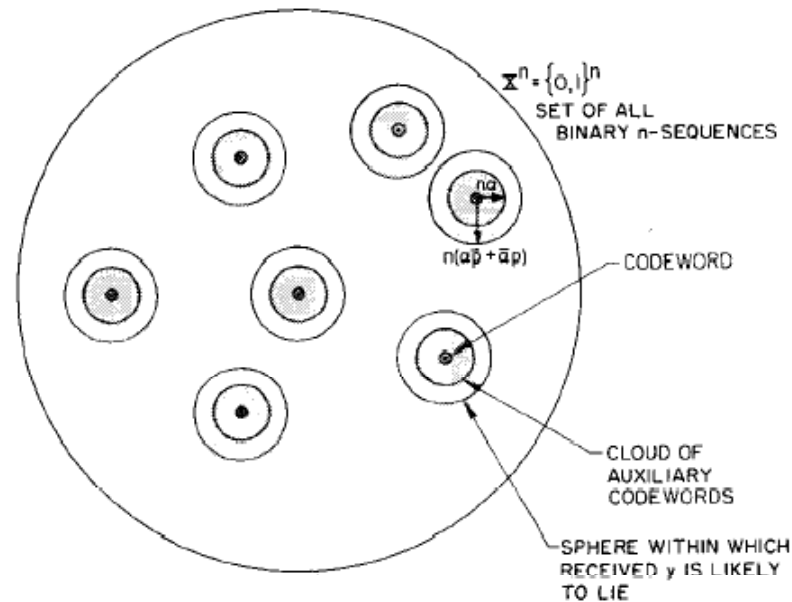

Fig. 4. Space of codewords for BSC.

From: T. Cover, "Broadcast Channels," *IEEE Trans. Info. Theory*, vol. IT-18, no. 1, pp. 2-14, Jan. 1972

- A cloud is a set of codewords (or sequences) that is selected with the information bits (most important or MSB) to be transmitted to the high-noise user

Cooperative Broadcasting (1974)

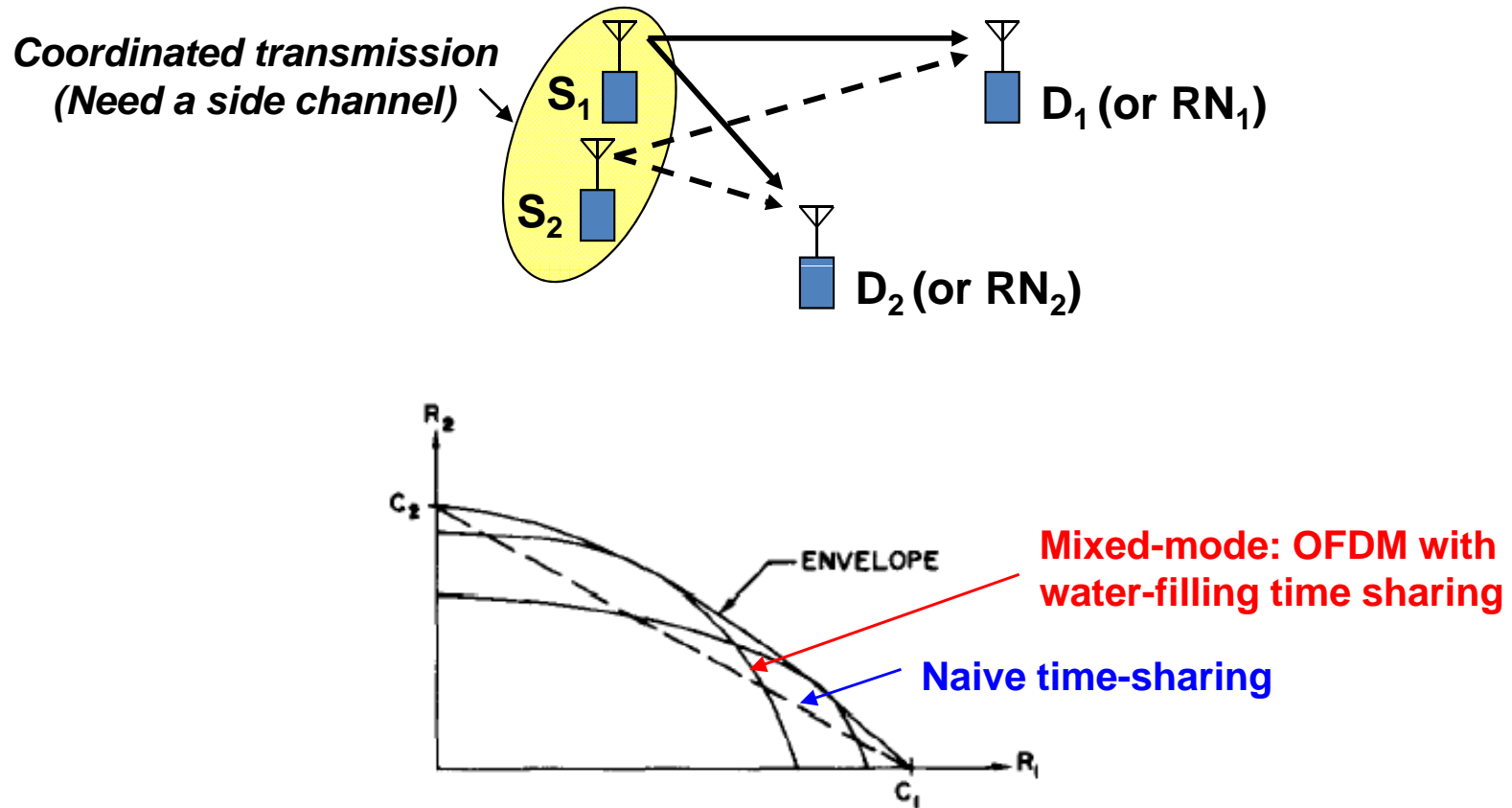

Fig. 3. Rates achievable by frequency division and variable power time sharing.

From: P. Bergmans and T. Cover, "Cooperative Broadcasting," *IEEE Trans. Info. Theory*, vol. IT-20, no. 3, pp. 317-324, May 1974.

4. Multilevel LUEP codes and $|u|u+v|$ construction

- An LUEP code has subcode partition-chain $C \supset C_1 \supset \dots \supset C_L$ with

$$G = \left(\begin{array}{c} G_1 \\ G'_2 \\ \vdots \\ G_L \end{array} \right), \quad G_2 = \left(\begin{array}{c} G'_2 \\ G'_3 \\ \vdots \\ G_L \end{array} \right), \quad \dots, \quad G_L,$$

and $d_1 > d_2 > \dots > d_L$.

- Practical *two-level LUEP codes* can be constructed based on *block, convolutional or LDPC codes* and Plotkin's (or $|u|u+v|$) construction:

$$G = \left(\begin{array}{cc} 0 & G_1 \\ G'_2 & G'_2 \end{array} \right),$$

← Cloud centers (coset leaders)
← Cloud (subcode) codewords

where $d_2 = 2d'_2 < d_1$.

Time-sharing ($|u|v|$) versus Plotkin ($|u|u+v|$)

- Time-sharing:

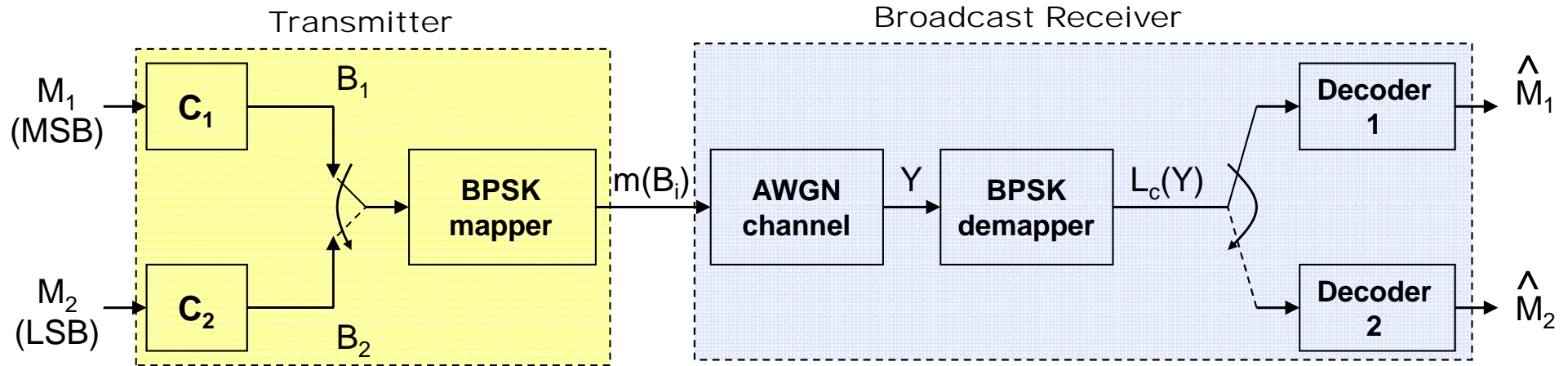

- Plotkin:

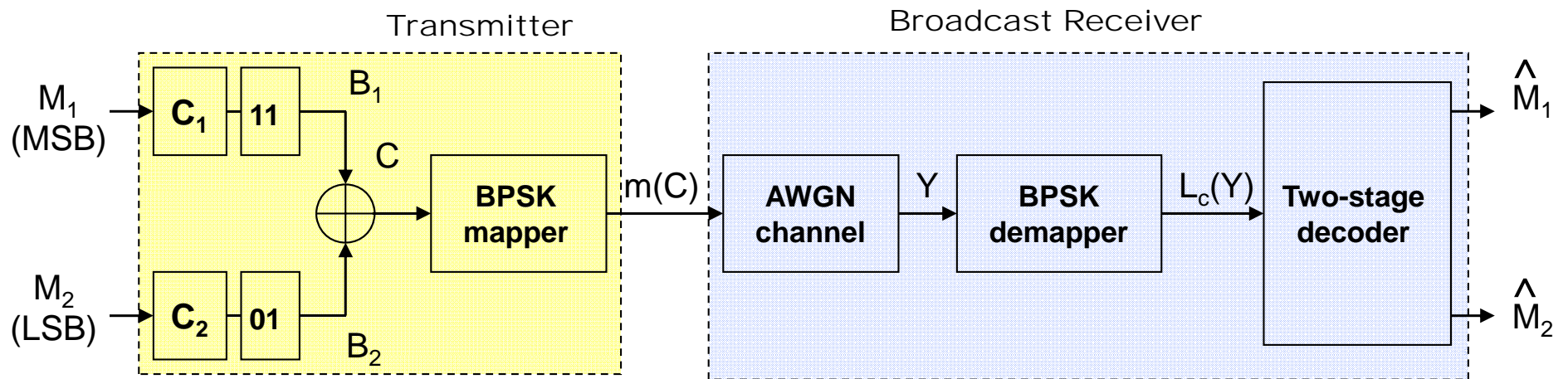

Performance of $|u|v|$ vs. $|u|u+v|$: short LDPC codes

C_1, C_2 : LDPC (96,50) codes of degrees (3,6) and (4,8)

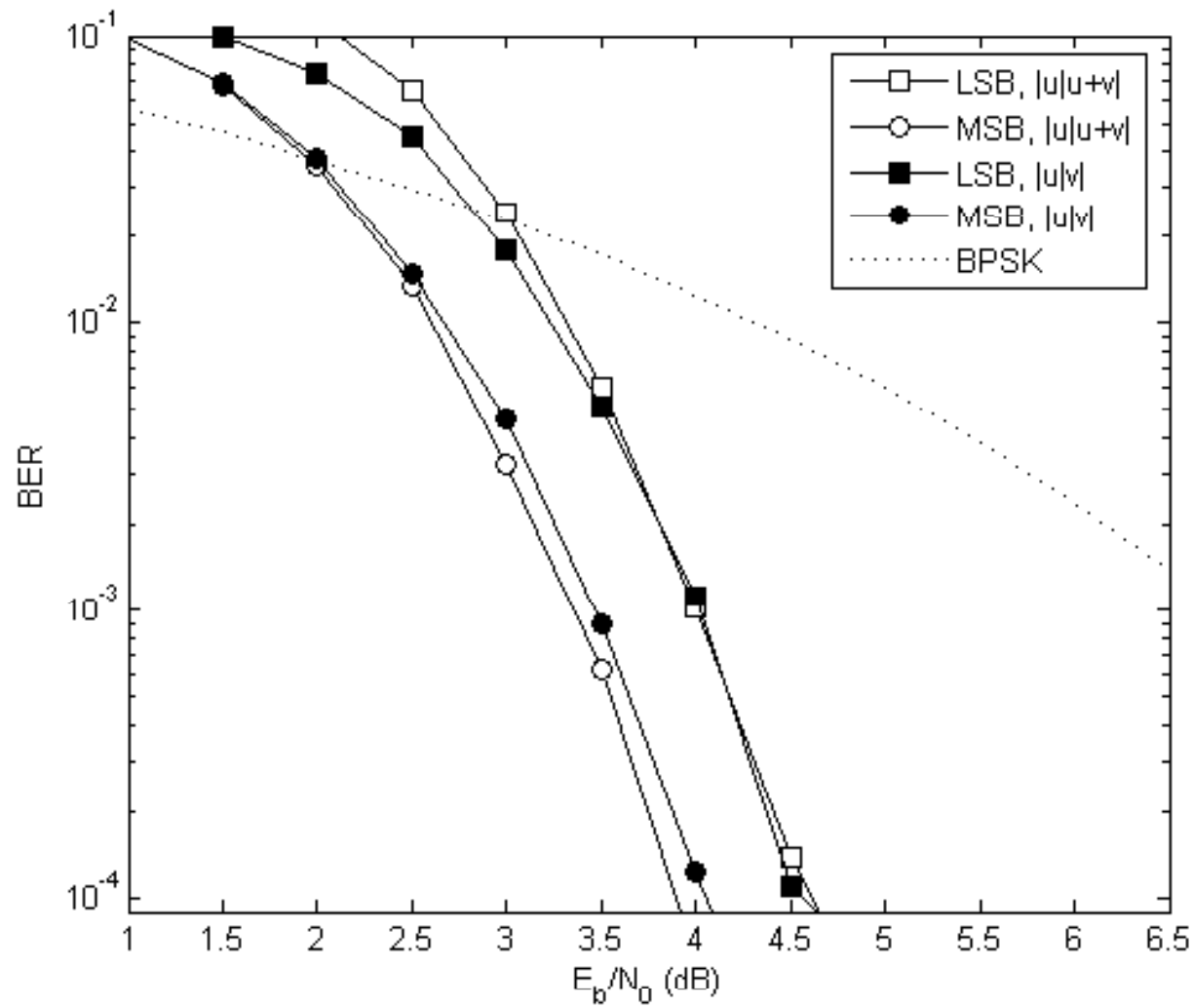

A Plotkin $|u|u+v|$ coding scheme

- Multilevel codes *always improve the throughput* over any orthogonal (time- or frequency-division) approach
- Follow Bergmans' and Cover's idea: Design an “*over-the-air*” $|u|u+v|$ (Plotkin) coding scheme:

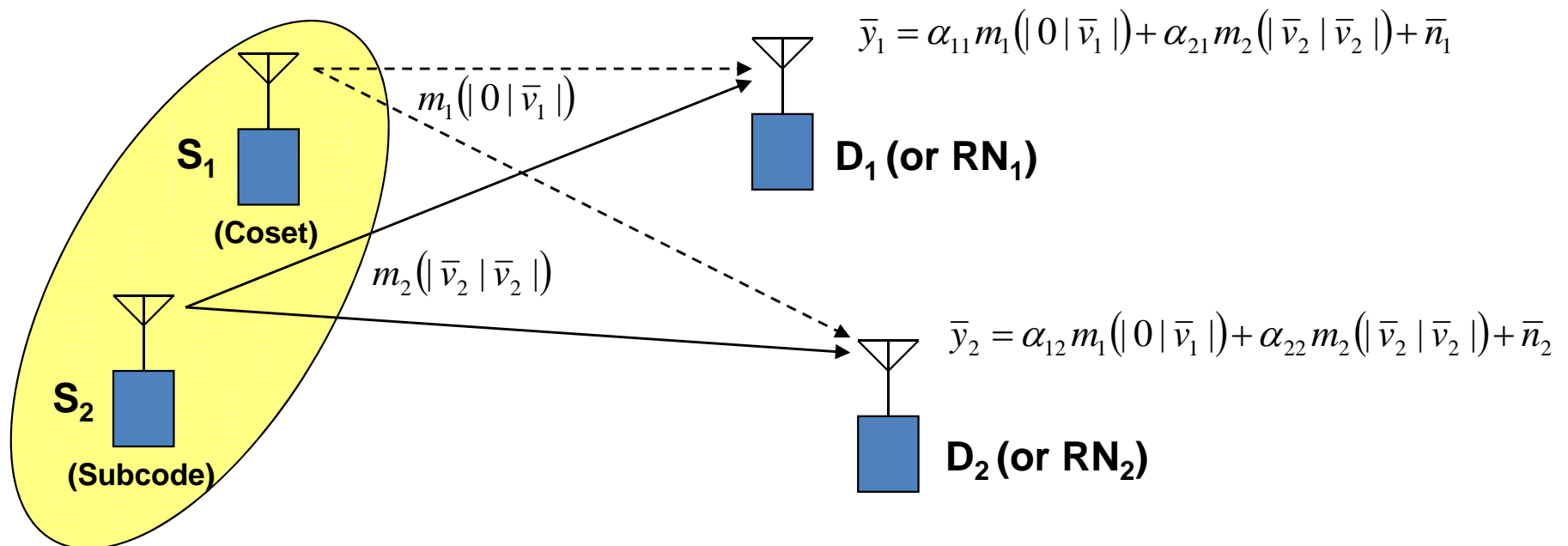

Two sources with BPSK mapping

- **BPSK Mapping** m_i from a bit to a signal set M_i , $i=1,2$. Assume $\alpha_{i1}=\alpha_{i2}$
- $M_1=\{s_{11},s_{12}\}$ and $M_2=\{s_{21},s_{22}\}$:

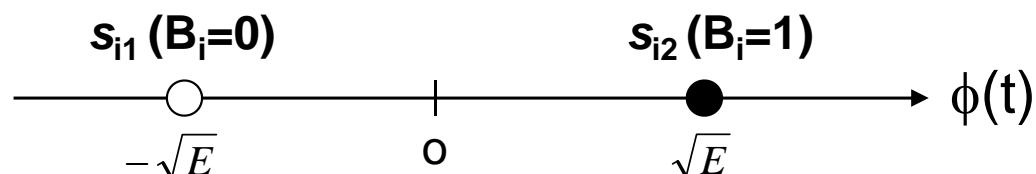

- At the receiver, the **direct-sum** M_1+M_2 is equal to a ternary signal set:

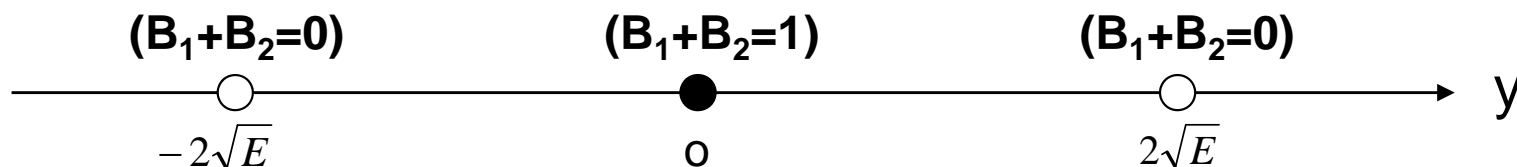

Single-source and cooperative broadcasting

- Single source:

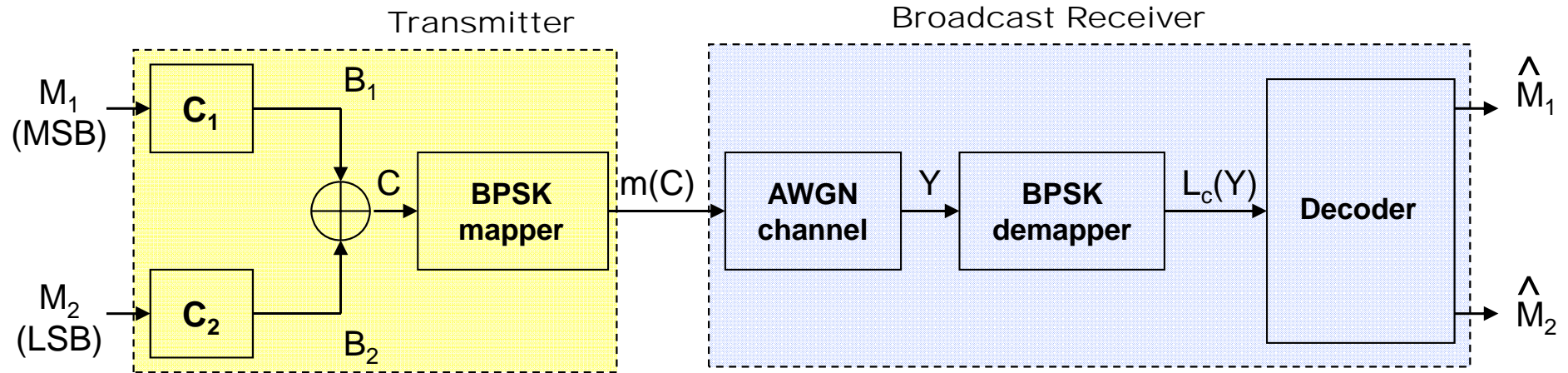

- Cooperative (two sources):

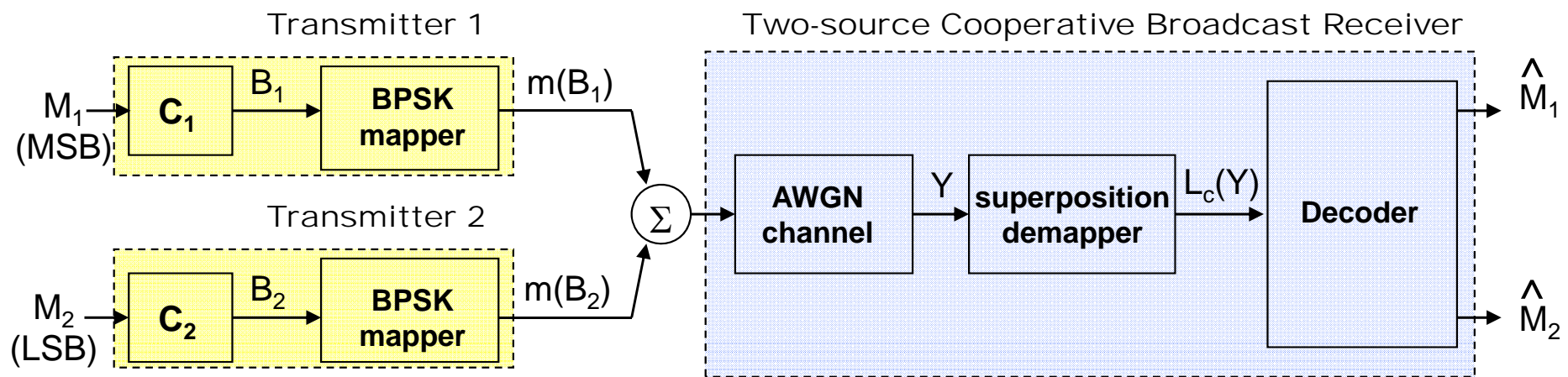

Decoding for $|u|u+v|$ construction

Two stages (Kumar-Milenkovic, 2006)

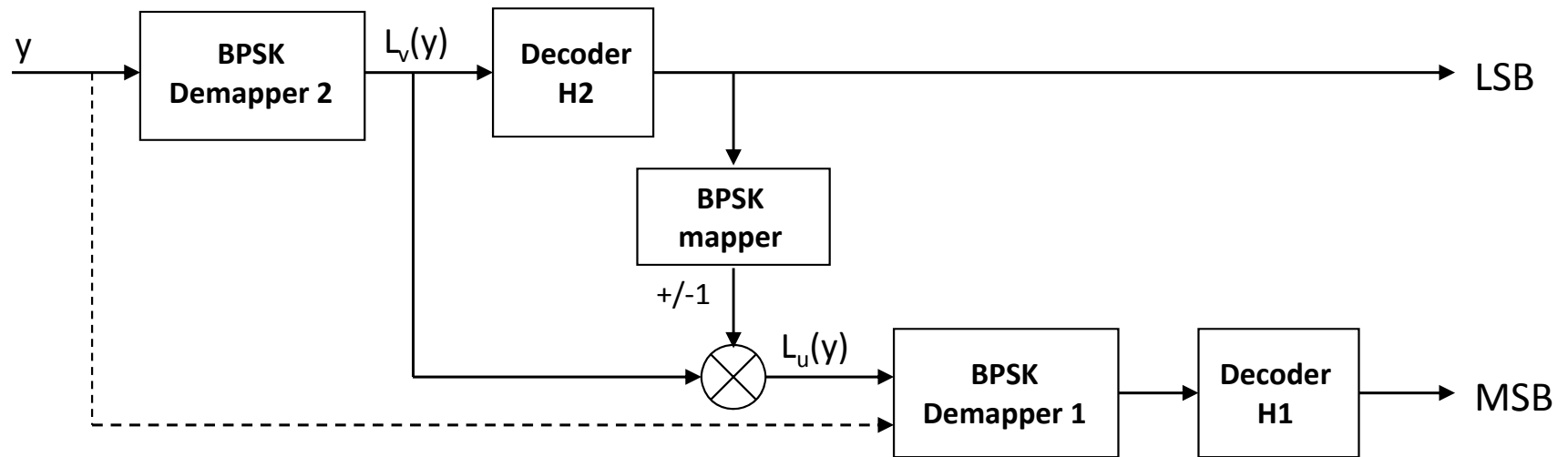

Single stage (SJSU, 2009)

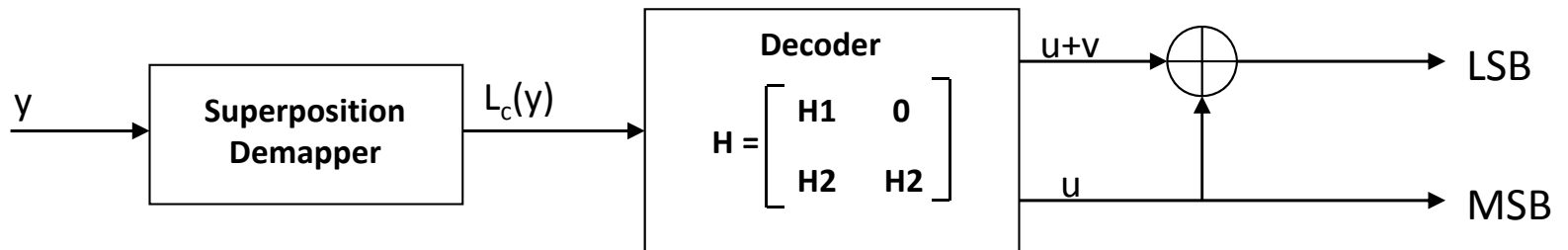

$|u|u+v|$ decoding: Simulation results

C_1 : Regular (96,50) LDPC code with degrees (3,6); C_2 : Regular (96,49) LDPC codes with degrees (4,8)

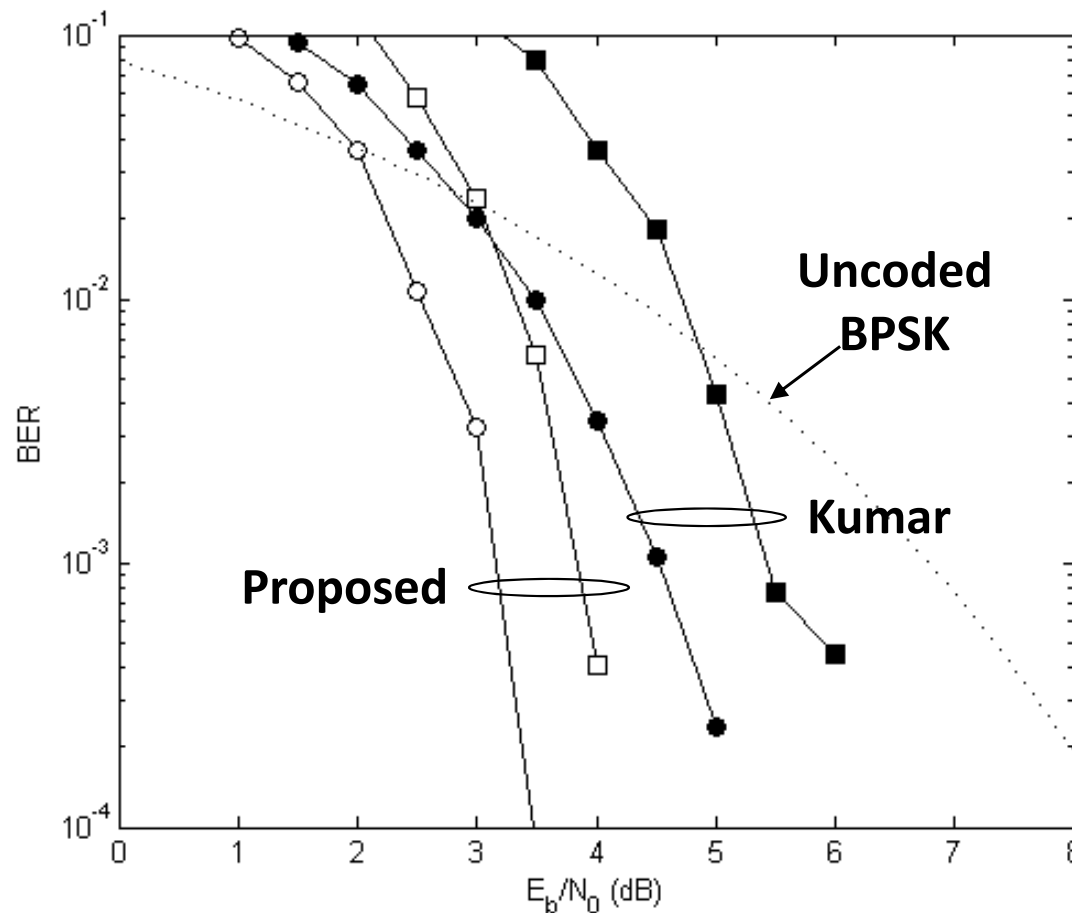

H matrix used in $|u|u+v|$ construction with LDPC codes of length 96

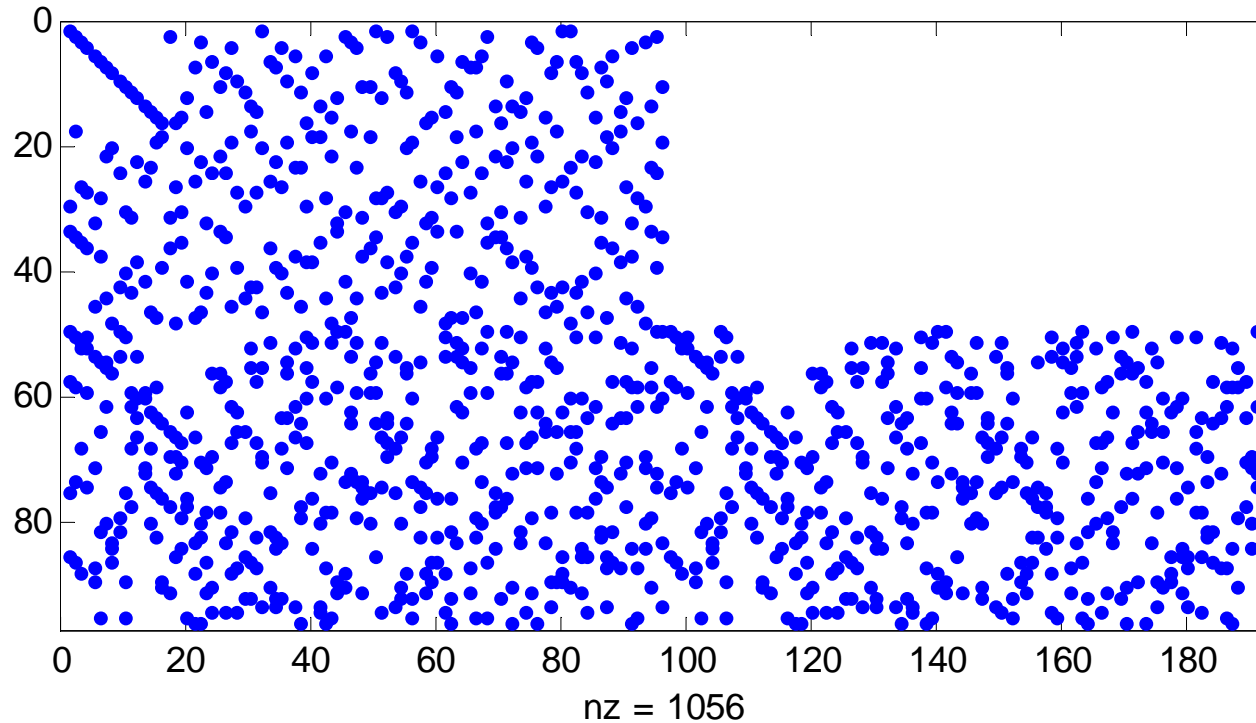

H matrix used in $|u|u+v|$ construction with LDPC codes of length 204

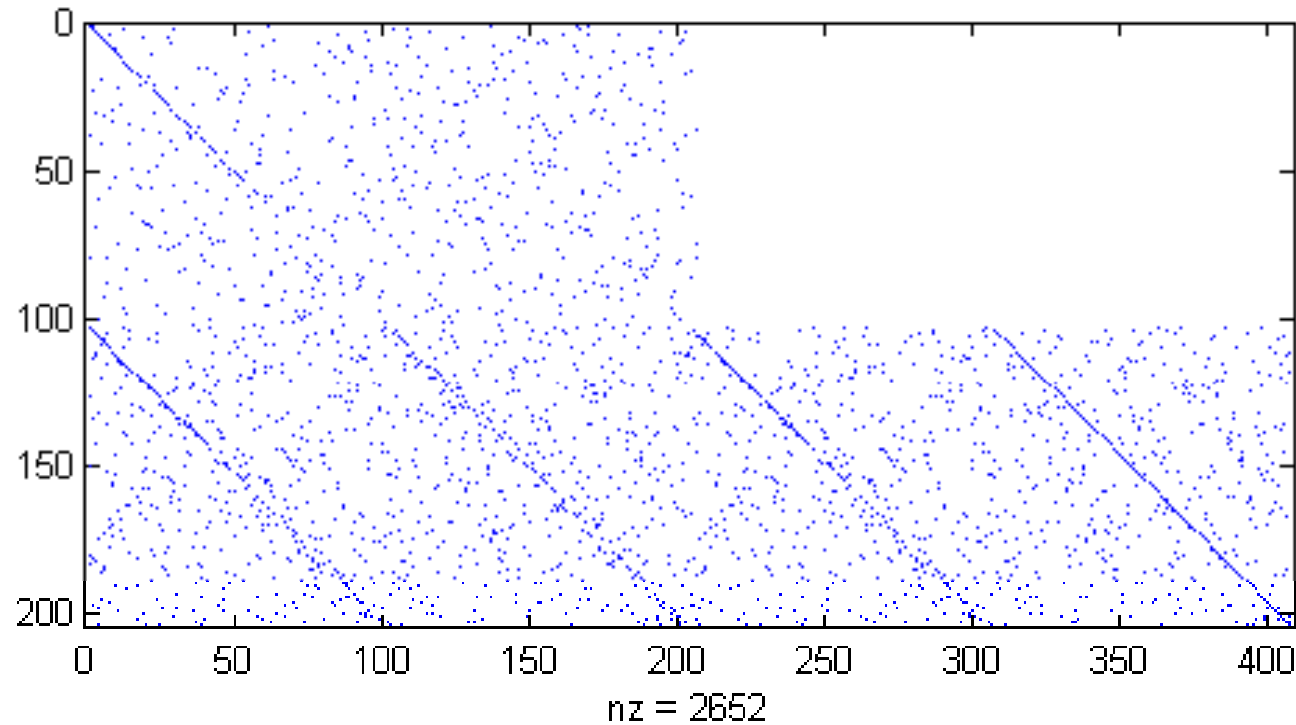

Systematic encoding

- Use Gaussian elimination to produce systematic generator matrices and a permutation:

Length 96:

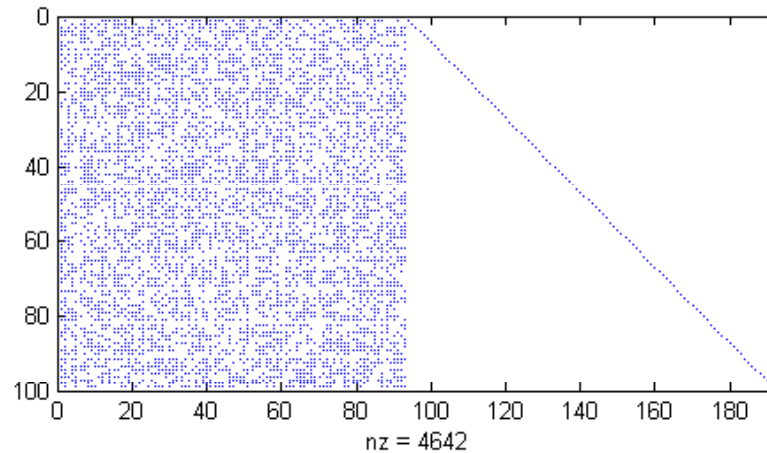

Length 204:

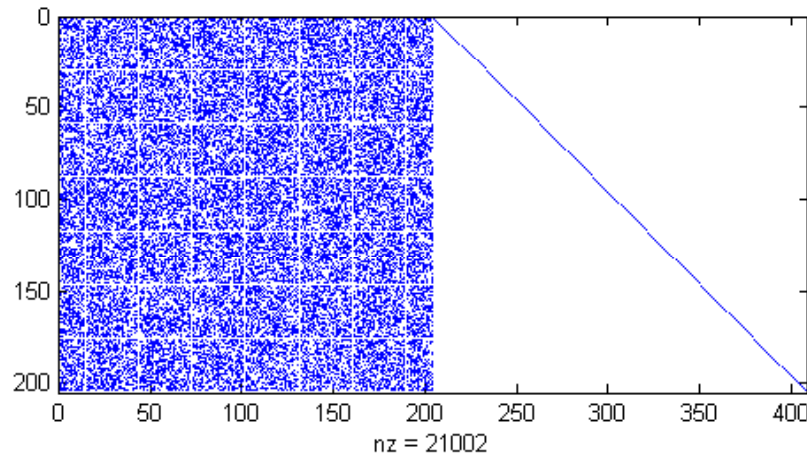

Single-source versus cooperative: BPSK Metrics

Single source

B_1	B_2	$C=B_1+B_2$	y
0	0	0	-1
0	1	1	+1
1	0	1	+1
1	1	0	-1

Cooperative (dual source)

B_1	B_2	y
0	0	-2
0	1	0
1	0	0
1	1	-2

Log-likelihood ratio (LLR) metric:
$$L_c(y) = \frac{\Pr\{c = 1|y\}}{\Pr\{c = 0|y\}}$$

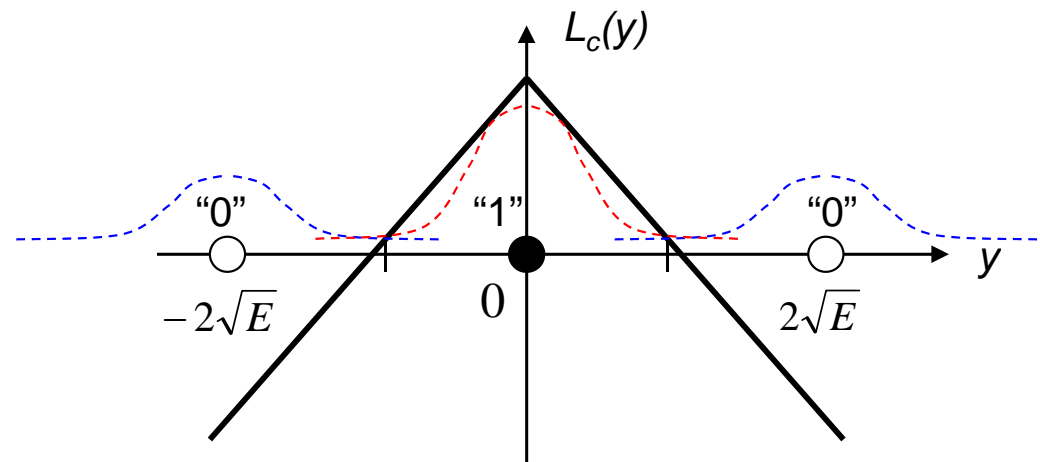
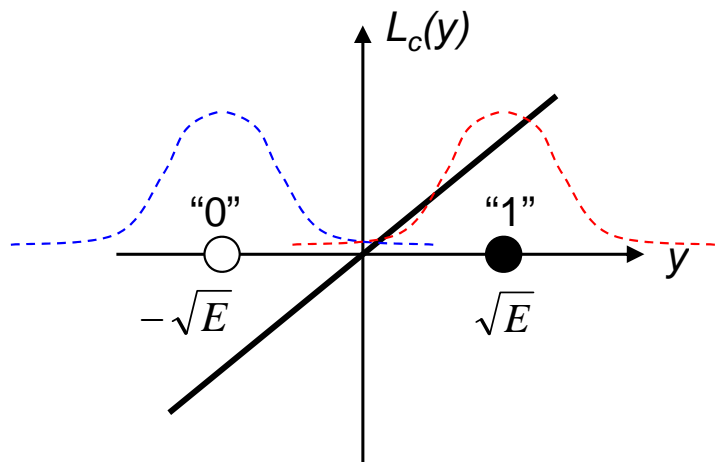

LLR metrics for cooperative broadcasting and BPSK modulation ($E/N_0=10$ dB)

B	m(B)
0	-1
1	1

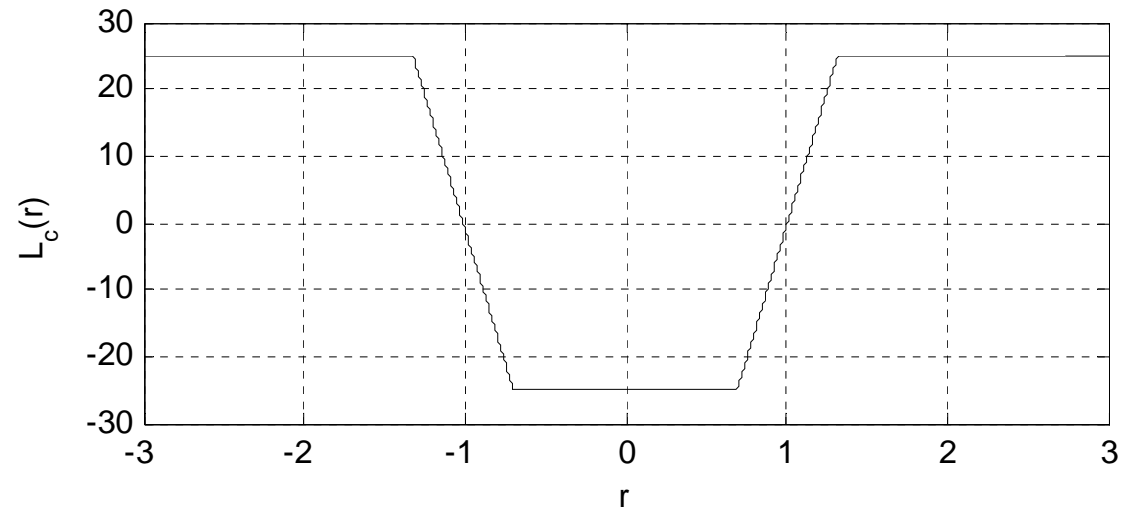

Cooperative $|u|u+v|$: Lengths 96 and 204 AWGN channel

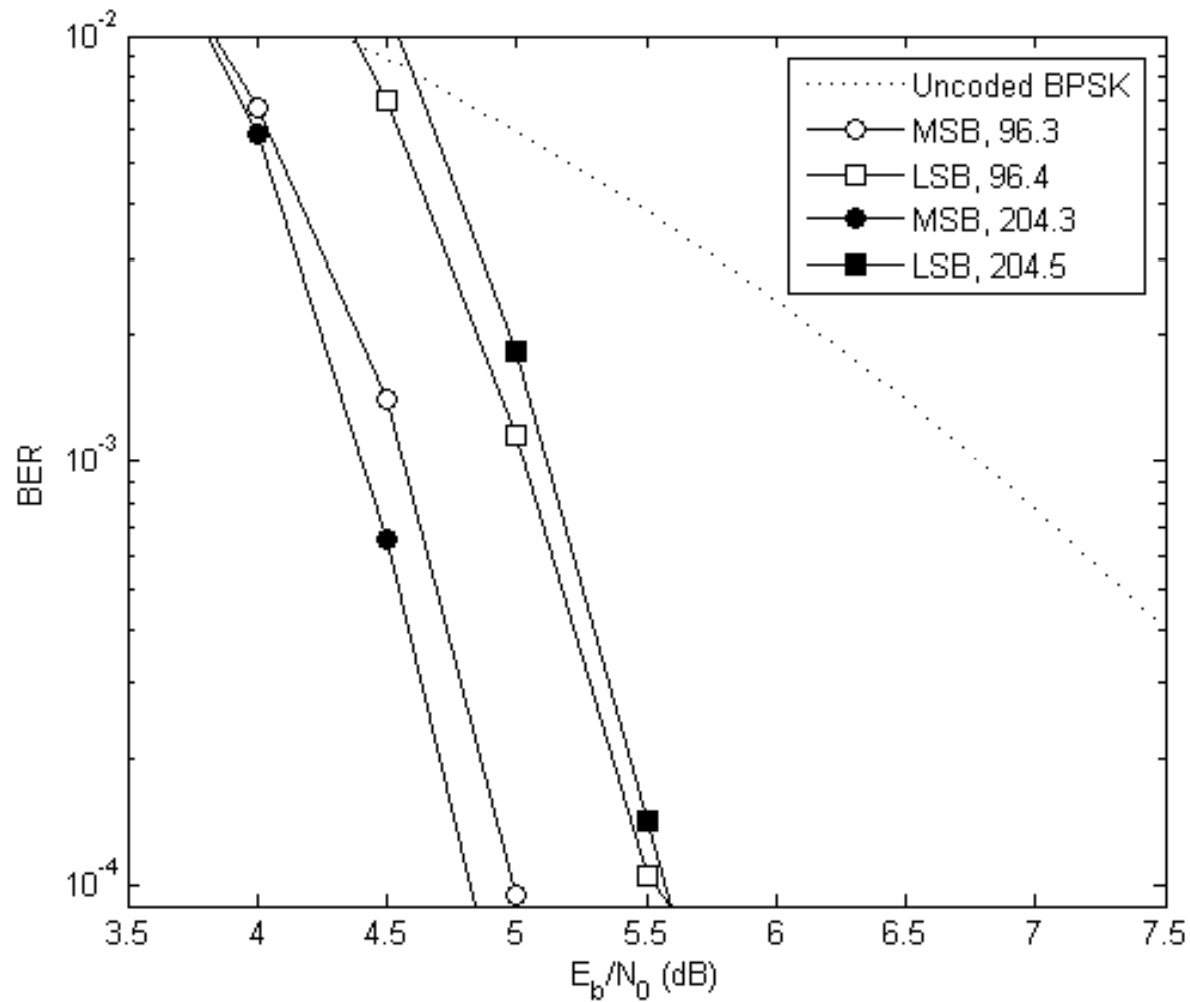

Cooperative $|u|u+v|$: Length 96

Flat Rayleigh fading channel

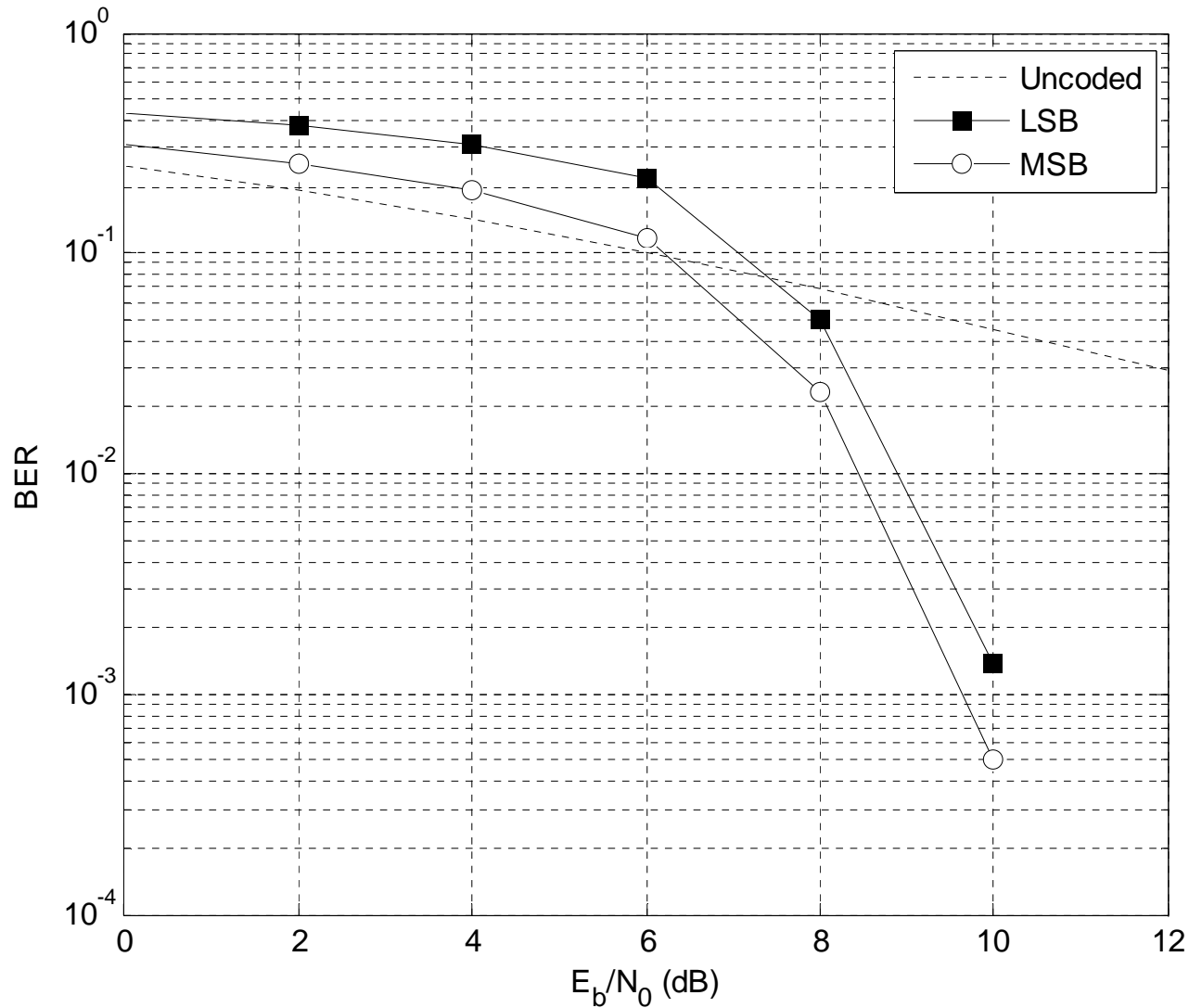

Cooperative $|u|u+v|$: Length 204

Flat Rayleigh fading channel

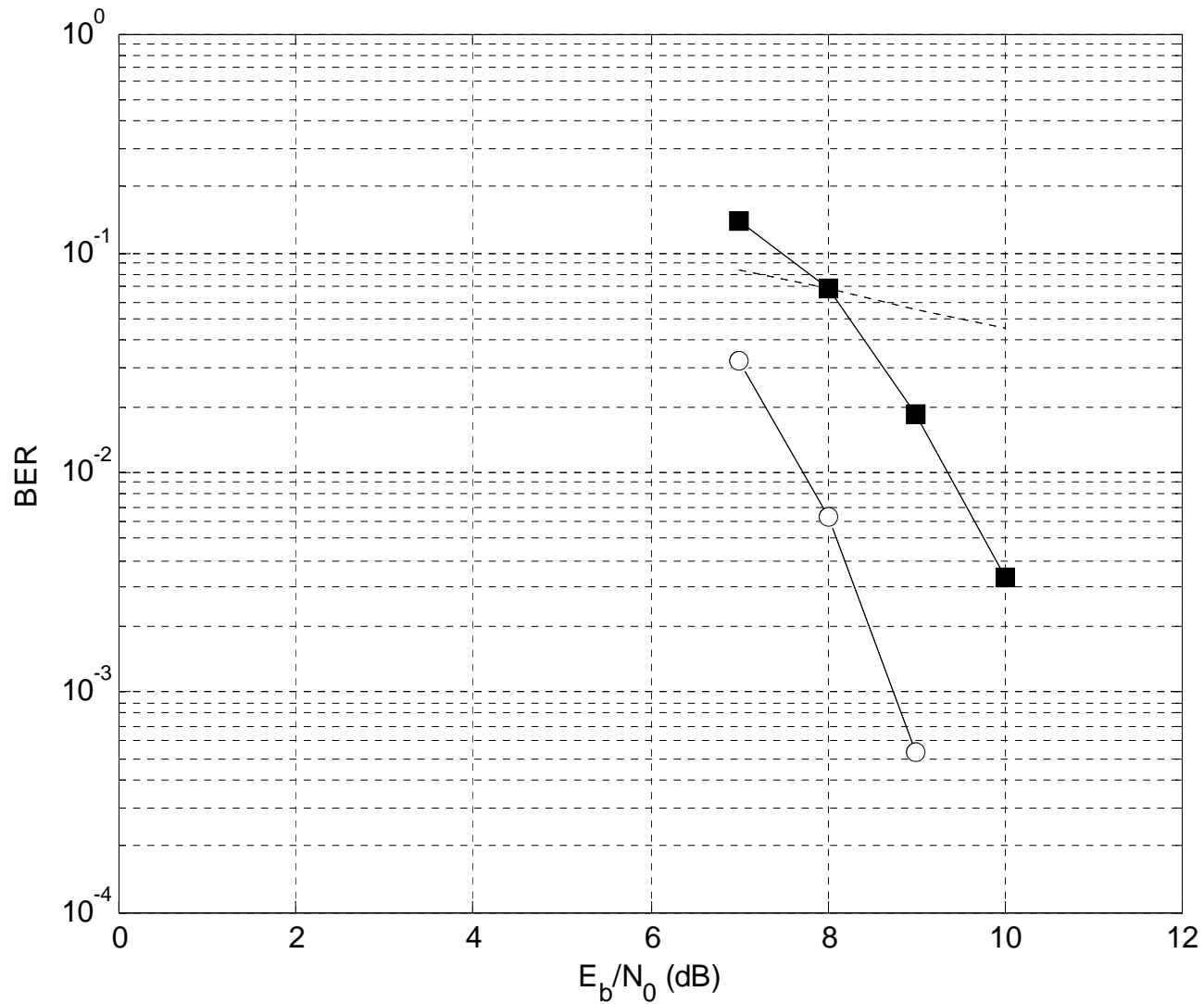

Results are applicable to QPSK modulation

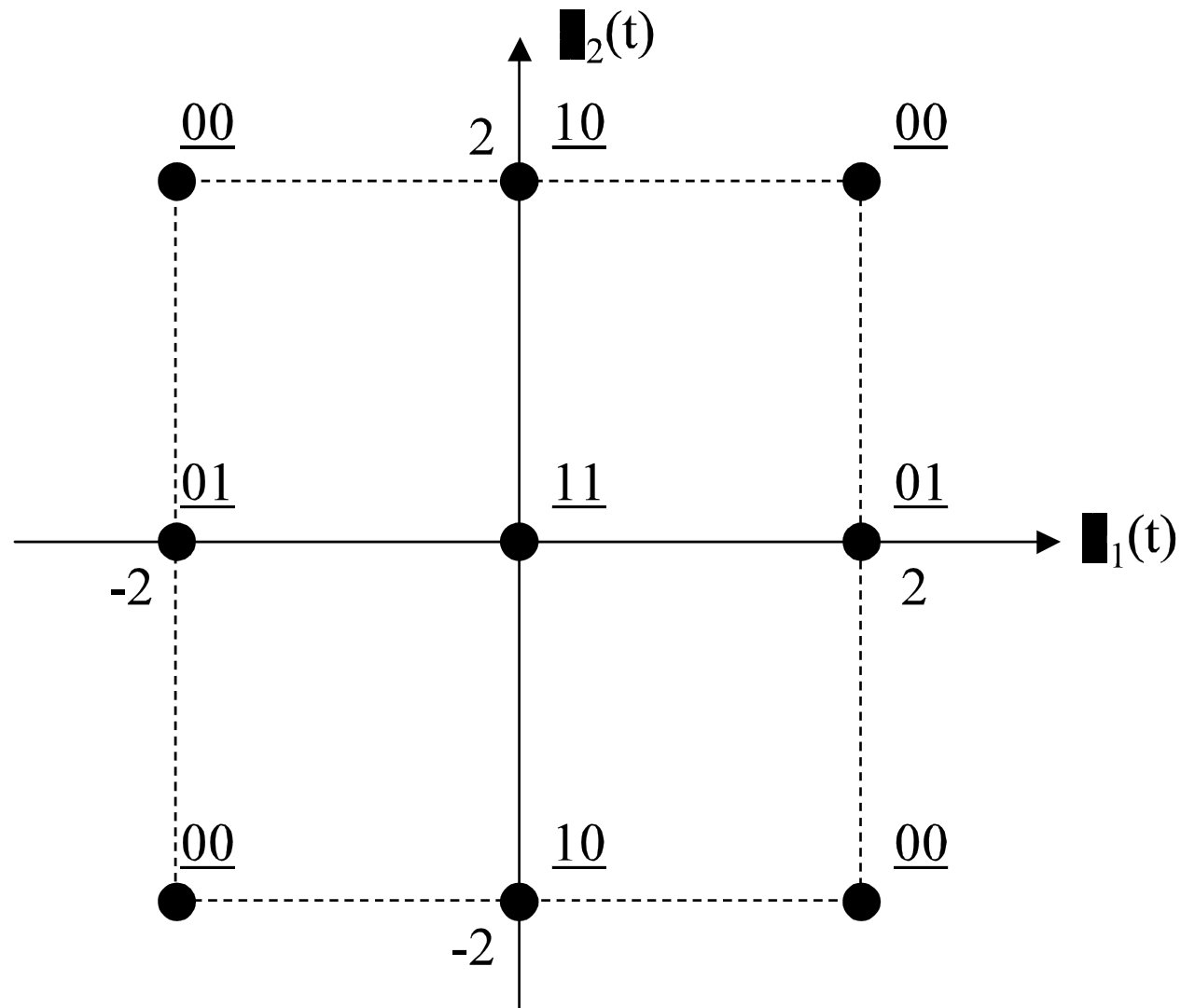

QPSK = BPSK x BPSK: Subset mapping

- Two basis functions: $\phi_1(t), \phi_2(t)$.
- Basic idea: Quadrature multiplexing
- Source i : BPSK mapping with $\phi_i(t), i=1,2$
- Receiver processes two BPSK sequences in parallel branches

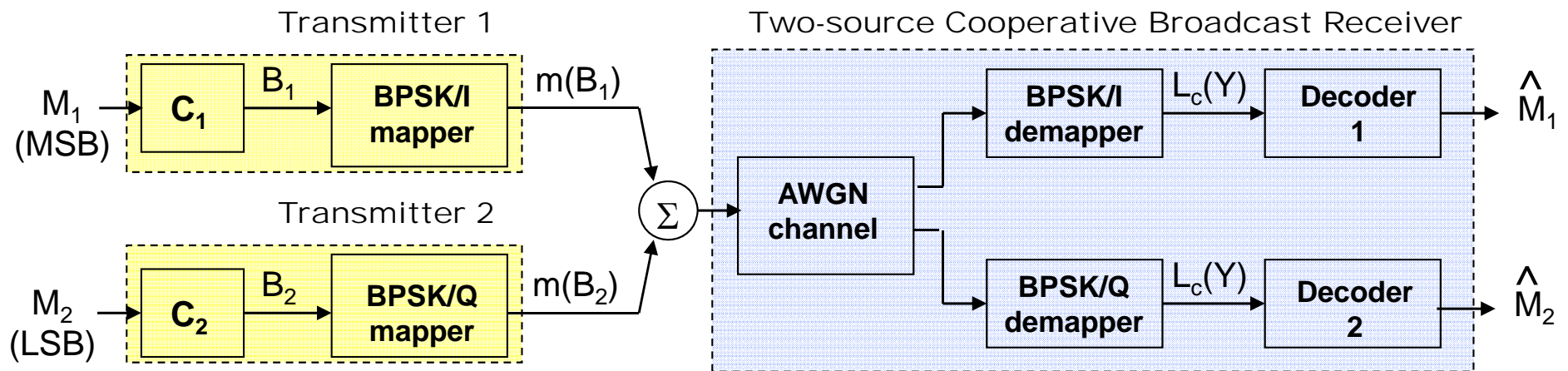

QPSK subset vs Cooperative $|u|u+v|$ BPSK

C_1, C_2 : LDPC (204,102) codes of node degrees (3,6) and (5,10)

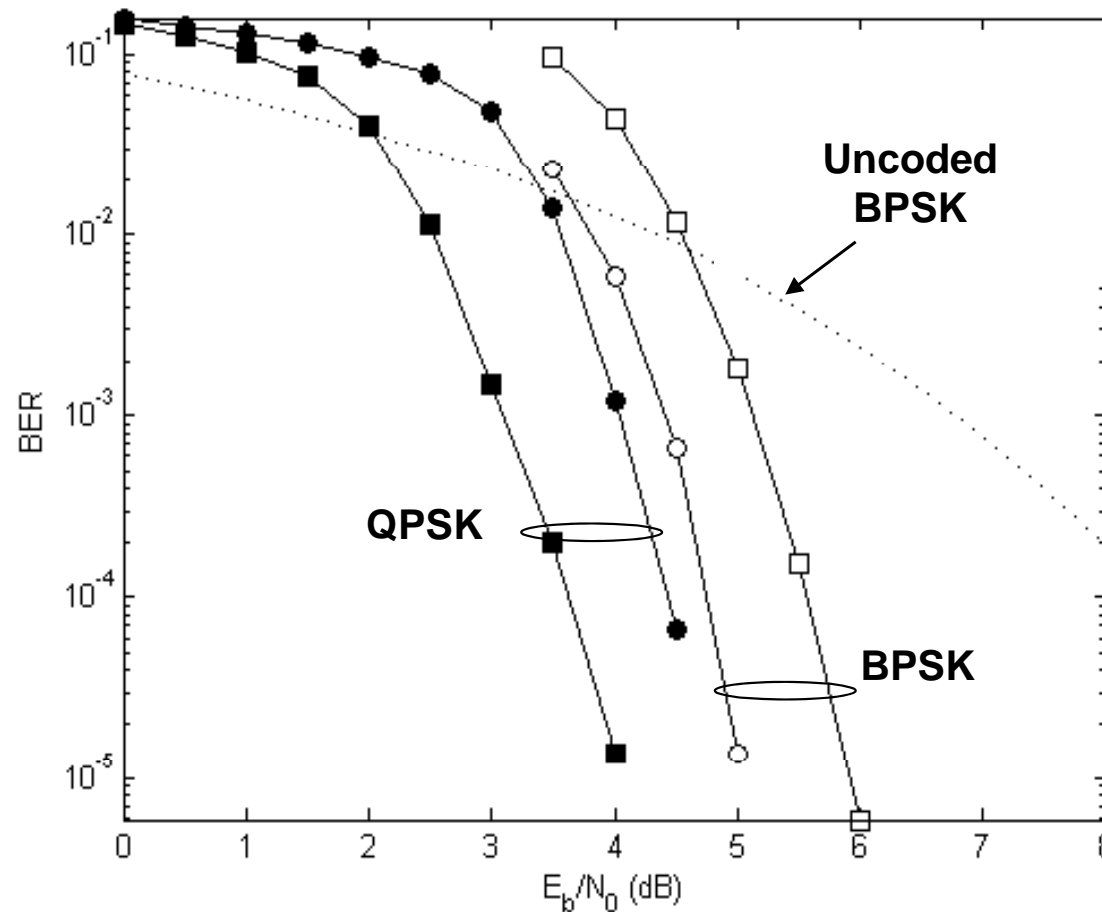

Cooperative $|u|u+v|$ with 4-PAM and natural mapping

- **4-PAM Mapping** m_i from two bits to a signal set M_i , $i=1,2$. Assume $\alpha_{i1}=\alpha_{i2}$
- $M_1=\{s_{11},s_{12},s_{13},s_{14}\}$ and $M_2=\{s_{21},s_{22},s_{23},s_{24}\}$:

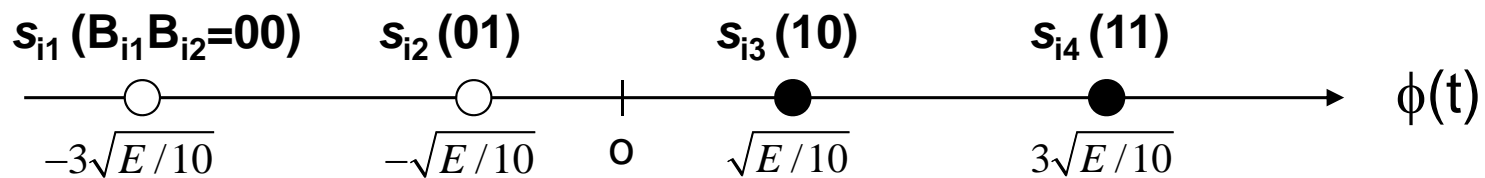

- At the receiver, the **direct-sum** M_1+M_2 is equal to a 7-ary signal set:

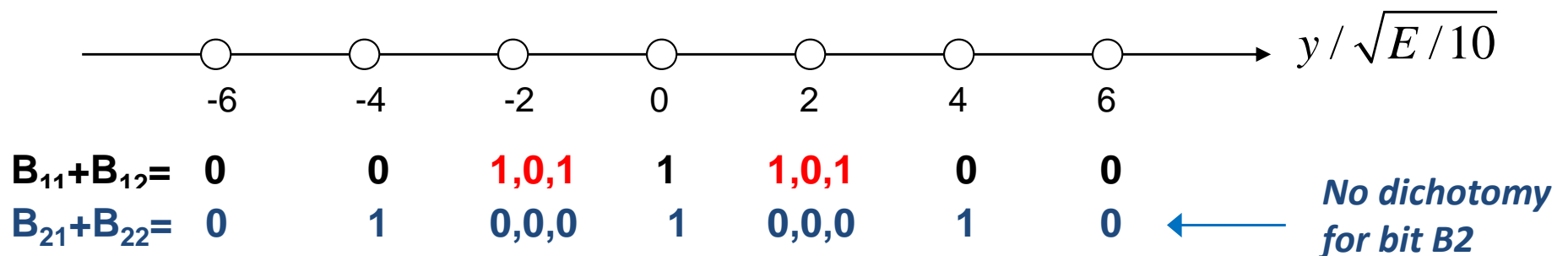

LLR metrics for cooperative broadcasting and 4-PAM modulation with natural mapping ($E/N_0=10$)

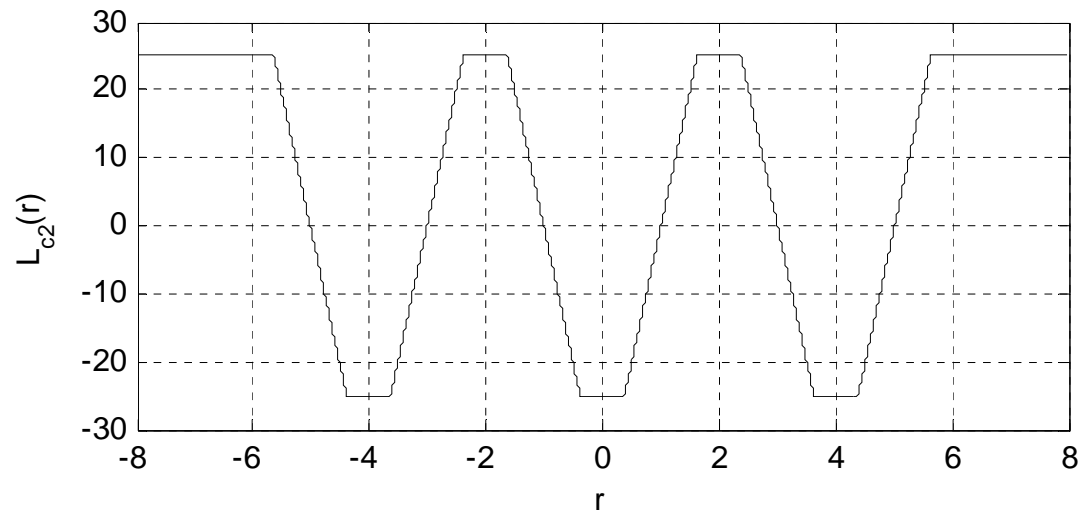
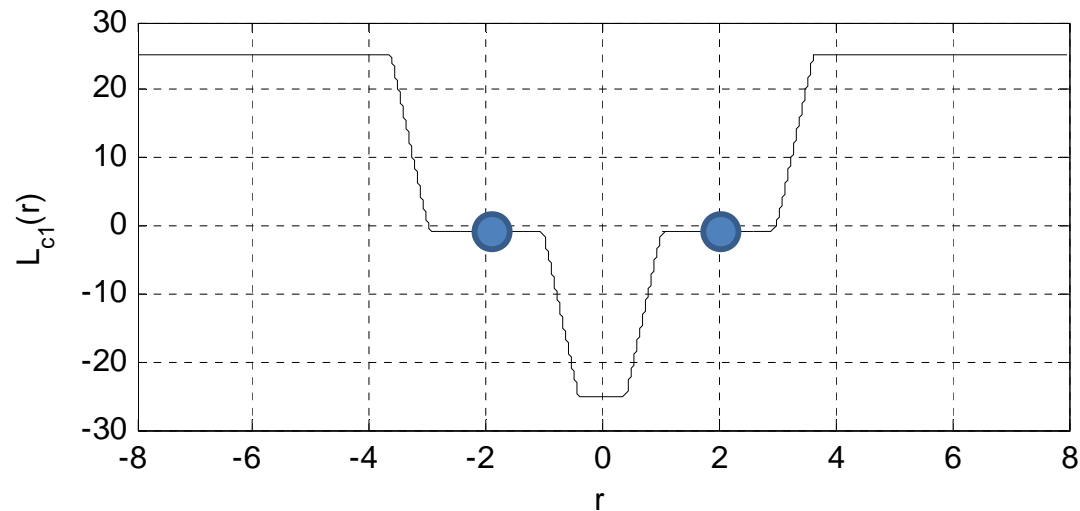

Metrics for cooperative broadcasting and 4-PAM modulation with Gray mapping ($E/N_0=10$)

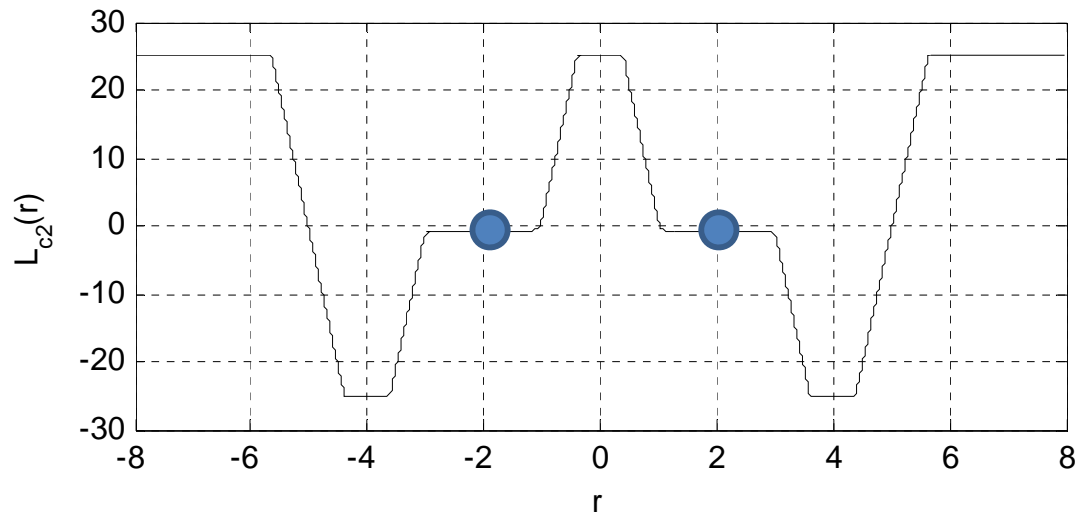
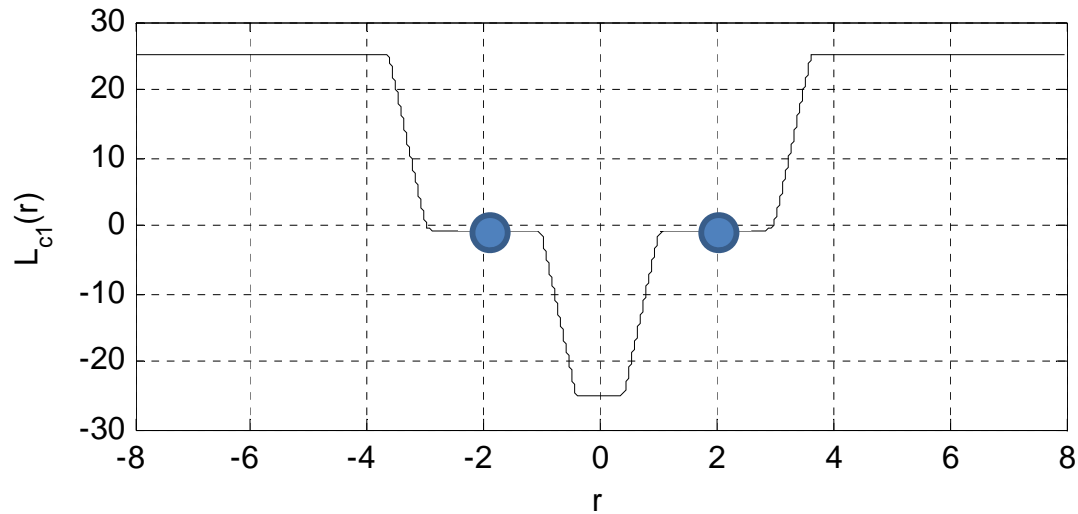

Cooperative $|u|u+v|$ with 4-PAM and hierarchical mapping

- **4-PAM Mapping** m_i from two bits to a signal set M_i , $i=1,2$. Assume $\alpha_{i1}=\alpha_{i2}$
- Again, two sets: $M_1=\{s_{11},s_{12},s_{13},s_{14}\}$ and $M_2=\{s_{21},s_{22},s_{23},s_{24}\}$ with **two power levels**
- At the receiver, the **direct-sum** M_1+M_2 is equal to a 28-ary signal set:

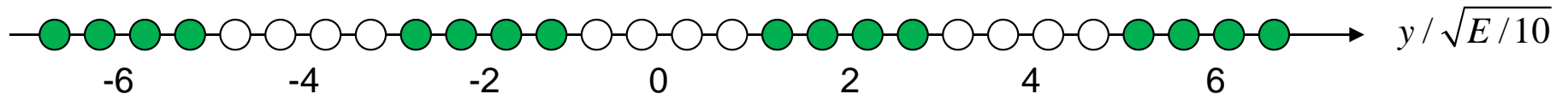

This idea was proposed by L. Xiao, T.E. Fuja, J. Kliewer and D.J. Costello (2009)

Note: In their scheme, superposition takes place at the transmitter ...

- All dichotomies (i.e., metric $L_c=0$) are removed, in exchange for decreased error performance
- **Results are applicable to 16-QAM modulation**

Metrics for cooperative broadcasting with 4-PAM modulation and hierarchical mapping

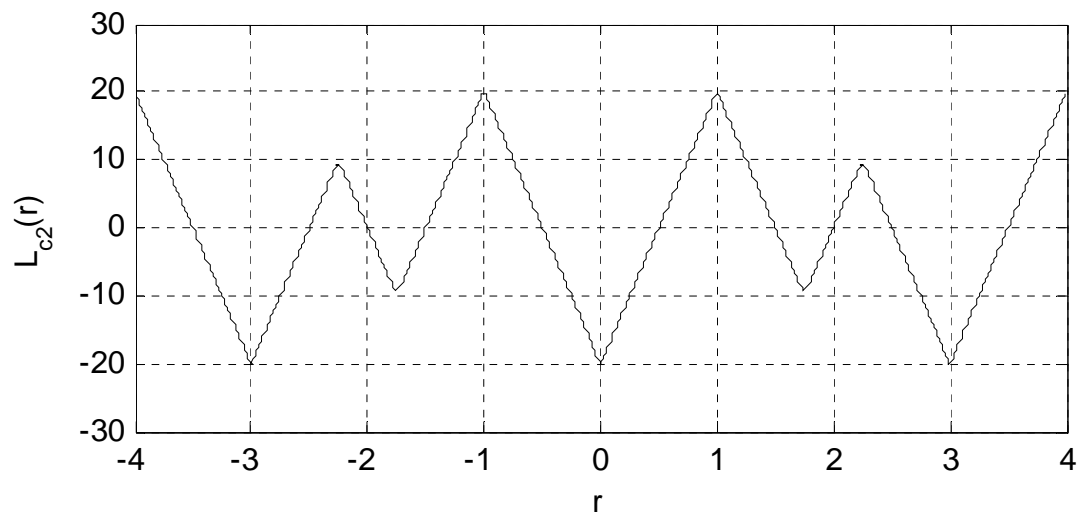
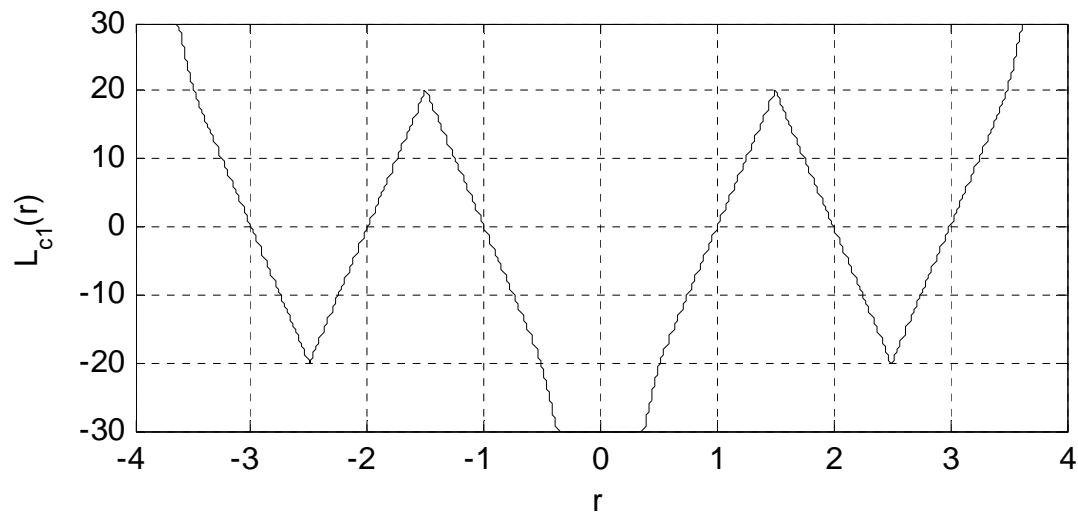

Performance of 4-PAM with hierarchical mapping. Length 96 LDPC codes

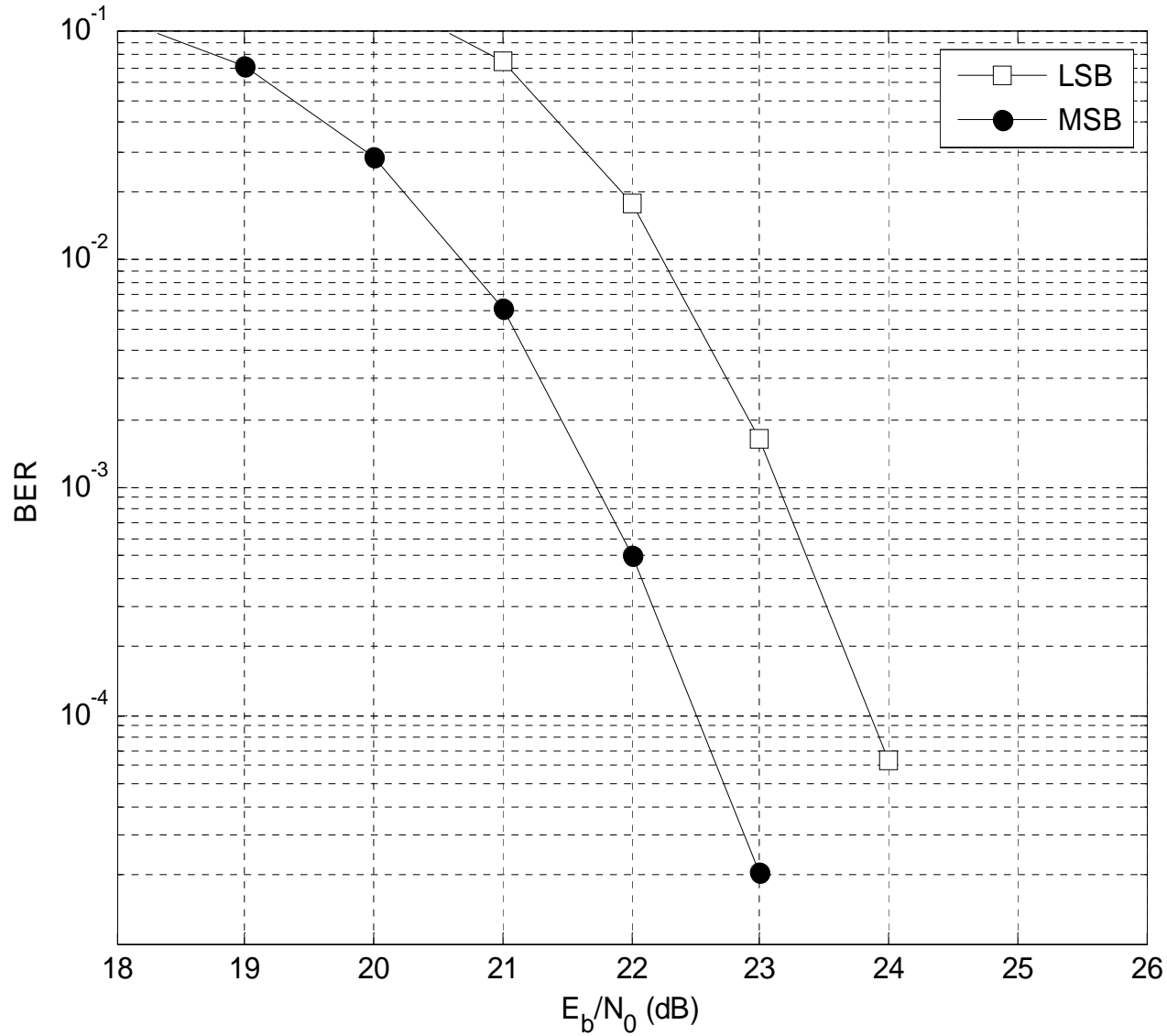

Performance of 4-PAM with hierarchical mapping. Length 204 LDPC codes

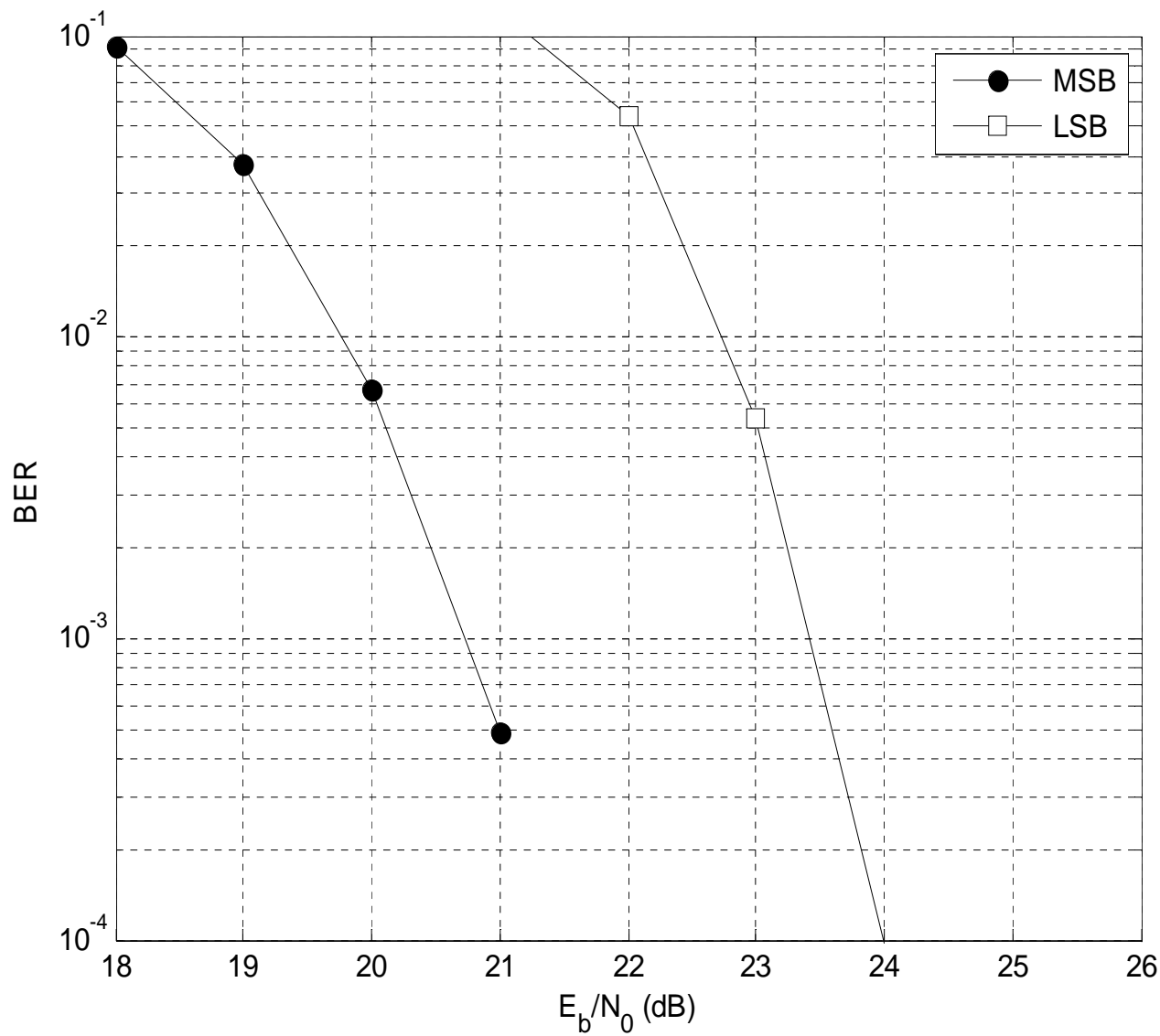

Conclusions and future work

- Proposed a coding scheme for two-user cooperative broadcasting (“over-the-air mixing”), based on Plotkin’s $|u|u+v|$ construction using BPSK, QPSK, 4-PAM and 16-QAM modulations
- ***Cooperative broadcasting = Network coding over physical layer***
MILCOM 2010 presentation, comment from Matthew C. Valenti: (His paper was on “Receiver Design for Noncoherent *Digital Network Coding*”)
- Future directions
 - Performance with ***longer LDPC codes*** (such as those used in WiMax)
 - Design rules based on LDPC code parameters (minimum distance, node distributions) versus proportion of MSB and performance
 - Use ***a software radio*** platform to study
 - Synchronization techniques for over-the-air mixing
 - Effect of channel estimation errors
 - Error performance over realistic (frequency-selective) wireless channels
 - Noncoherent modulation: Differential encoding, FSK (as in Valenti’s paper)

Supporting slides

Performance of WiMax codes

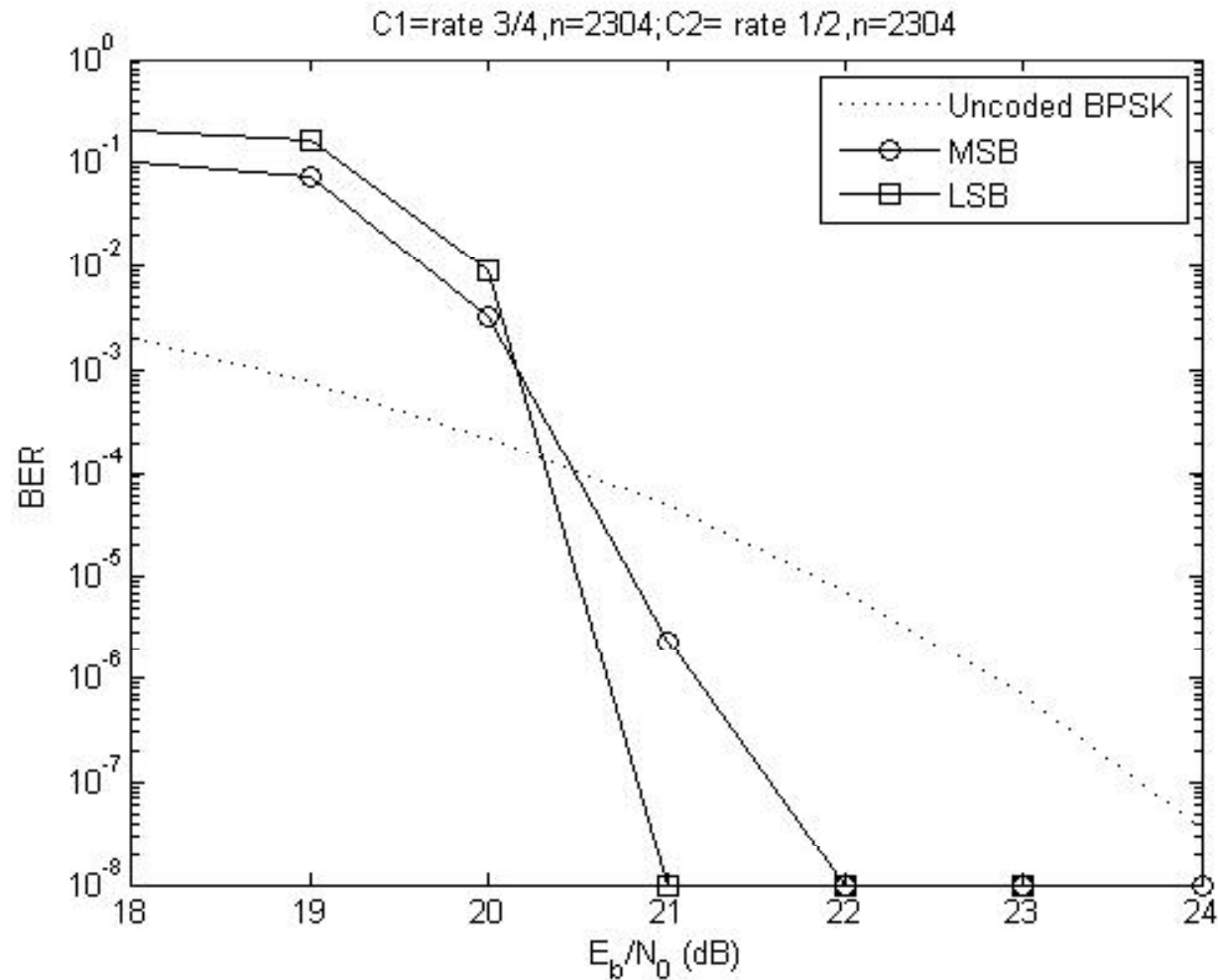

Combining cooperative $|u|u+v|$ with Alamouti: Length 96 codes

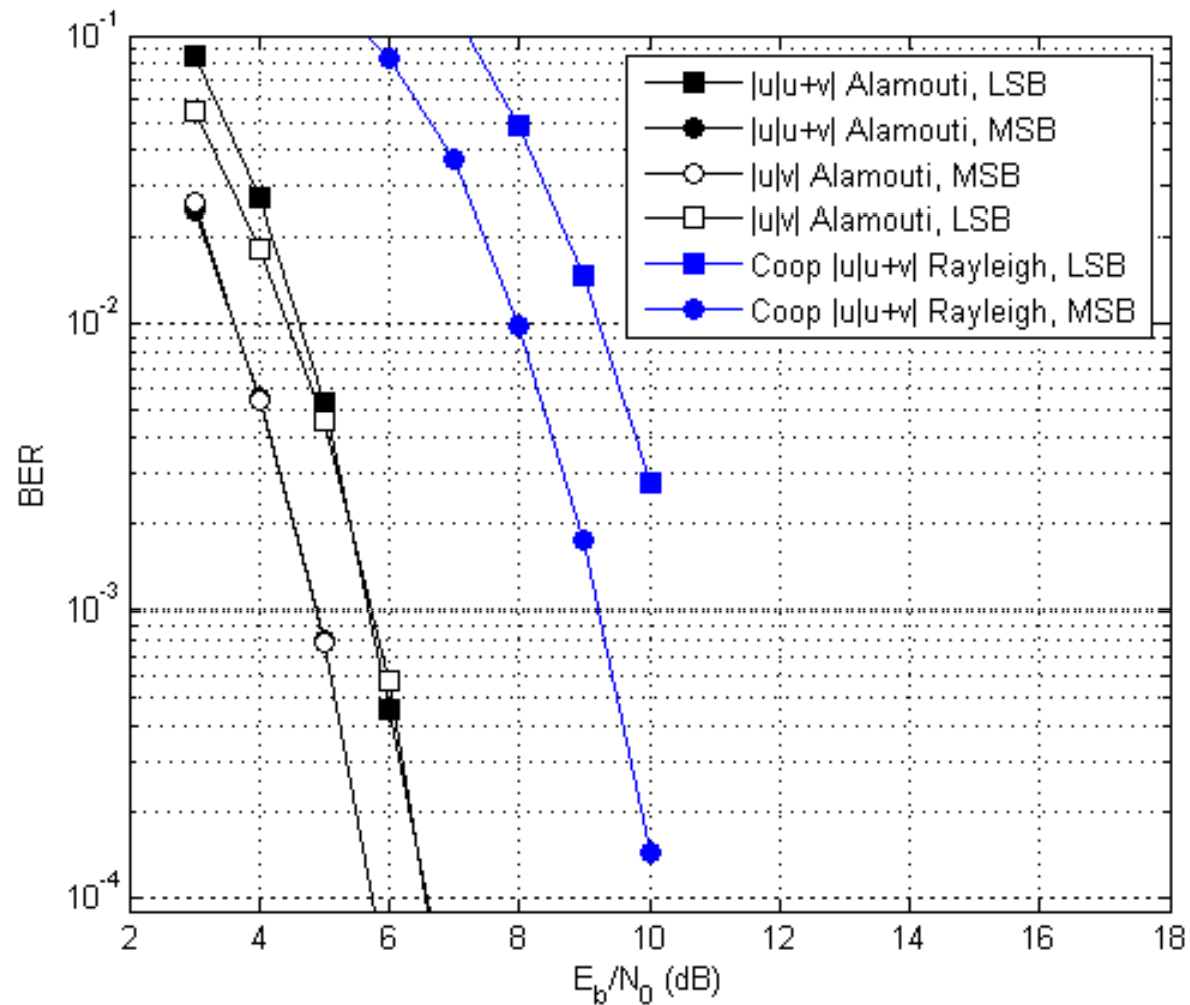

Combining cooperative $|u|u+v|$ with Alamouti: Length 204 codes

