

2009

Performance study of FMIPv6-based cross-layer WiMAX handover scheme for supporting VoIP service

Heejung Kim
San Jose State University

Follow this and additional works at: https://scholarworks.sjsu.edu/etd_projects

Part of the [Computer Sciences Commons](#)

Recommended Citation

Kim, Heejung, "Performance study of FMIPv6-based cross-layer WiMAX handover scheme for supporting VoIP service" (2009).
Master's Projects. 87.

DOI: <https://doi.org/10.31979/etd.t44f-tym7>

https://scholarworks.sjsu.edu/etd_projects/87

This Master's Project is brought to you for free and open access by the Master's Theses and Graduate Research at SJSU ScholarWorks. It has been accepted for inclusion in Master's Projects by an authorized administrator of SJSU ScholarWorks. For more information, please contact scholarworks@sjsu.edu.

**Performance study of FMIPv6-based cross-layer
WiMAX handover scheme for supporting VoIP service**

CS 298 Report

Heejung Kim

Department of Computer Science

San Jose State University

id4hjkim@gmail.com

Advisor: Dr. Melody Moh

Department of Computer Science

San Jose State University

moh@cs.sjsu.edu

April, 2009

Approved For _____

Department of Computer Science

Prof. Melody Moh, Advisor

Prof. Suneuy Kim, Committee Member

Prof. Teng Moh, Committee Member

Acknowledgement

This project could have not been possible without the wonderful advising from Prof. Melody Moh. I also would like to thank to my little daughter Herin Kang and my husband Brian Kang.

Abstract

This report presents performance study of the FMIPv6-based cross-layer handover scheme for VoIP supports over mobile WiMAX network. For this performance validation and evaluation, the handover delays for four different handover mechanisms are formulated and ns2 based simulation module has been developed. The handover delay, the total delay, and the R factor representing VoIP quality are measured to evaluate the VoIP support characteristics of the FMIPv6-based cross-layer scheme. Simulation results verified that the proposed FMIPv6-based cross-layer handover scheme, compared to the non-cross-layer scheme, successfully reduces total handover delay by almost 50% for the case of layer-3 handover. Further, simulation was also evaluated in terms of R factor indicating voice quality level, of which 70 is a minimum value of a traditional PSTN call to be considered as the lower limit of a VoIP call quality [6]. Through the simulation in this study, the result revealed that the proposed scheme effectively improves VoIP call quality from unacceptable quality to acceptable quality (R factor of 75). Based on these simulation results, it was found that the proposed FMIPv6-based cross-layer handover scheme is an adequate protocol for supporting VoIP services in mobile WiMAX environment.

List of Acronyms

ARQ	Automatic Retransmission Requests
ASN	Access Service Network
BS	Base Station
CoA	Care-of-address
CSN	Connectivity Service Network
DL	Downlink
ertPS	extended real-time Polling Service
FEC	Forwarded Error Correction
FMIPv6	Mobile IPv6 Fast Handover protocol
HHO	Hard Hand Over
HMIPv6	Hierarchical MIPv6
HO	Hand Over
MN	Mobile Node
MPDUs	MAC protocol data units
MS	Mobile Subscriber
QoS	Quality of Service
SHO	Soft Hand Over
SS	Subscriber station
UL	Uplink
UL-MAP	Uplink Map
VoIP	Voice Over IP
WiMAX	Worldwide Interoperability for Microwave Access

Table of contents

1. Introduction.....	7
2. Background and related studies	9
2.1 Overview of WiMAX handover scenarios	9
2.2 The IEEE802.16e handover procedures.....	10
2.3 Introduction of the FMIPv6.....	12
3. VoIP supporting WiMAX mobility module.....	14
3.1 The FMIPv6 based cross layer WiMAX HO scheme.....	14
3.2 The VoIP supporting WiMAX mobility module	18
4. Performance Evaluation	22
4.1 Simulation settings	22
4.2 Performance metrics	28
4.3 Simulation Results	33
5. Conclusion	41
References.....	42
Appendix: NS2 WiMAX extensions and simulator setup	45

1. Introduction

A newly emerging telecommunication technology, WiMAX (Worldwide Interoperability for Microwave Access), supports broadband wireless networks standardized on the IEEE (Institute of Electrical and Electronics Engineers) 802.16 [9]. One of the IEEE 802 standard's amendments, 802.16e defines mobility supports and some other extensions [2]. The major premises of the standard are to provide followings: IP (Internet Protocol) network with open architecture, high bandwidth corresponding to wire-line xDSL (Extended Digital Subscriber Line), mobility supports, QoS (Quality of Service) supports, and relatively low cost for deployment and maintenance [10].

VoIP (Voice over IP) is the one of the key application that can take advantage of the aforementioned standard's characteristics. Because of the scale and the complexity of the IEEE802.16e standard and the increasing demand of the VoIP services, extensive research efforts on VoIP services for WiMAX networks have been made. Focus of such research has been on efficient scheduling methods for enhanced QoS support, bandwidth allocation algorithms [1, 18], retransmission mechanisms in the link layer using ARQ (Automatic Retransmission Requests) [9, 17] and FEC (Forwarded Error Correction), and mobility supporting schemes [6]. Through the careful assessment of those schemes during CS297 course, it was found that providing stable mobility is the key technical issue for the handling of VoIP services in the mobile WiMAX networks.

When a MN (Mobile Node) changes its location, the MN moves the point of attachment to the network. In such situations, providing continuous network connectivity is essential to satisfy high level of VoIP service quality [7]. In such message, disruptions or intermittent discontinuation of transmission due to excessive

HO (Hand Over) processing time degrade voice quality. Therefore, guaranteeing certain level of minimum HO delay is a major challenge to provide VoIP services with good voice quality [7].

Various HO enhancement approaches have been proposed for mobility supports in mobile WiMAX network [3, 4, 6, 7, 12, 13, and 15]. Those schemes provide MAC layer or IP layer HO support. It is considered that the IEEE 802.16e WiMAX MAC layer HO procedures are more complicated than 802.11 WLAN (Wireless Local Area Network) HO procedures [14]. This is because the WiMAX HO support flexibility of the parameter adjustments and procedures itself [14].

In the original WiMAX network design, relatively long MAC layer HO procedures carried out separately from the IP layer HO procedures and the entire HO procedure's delay far exceeded HO requirements for the real-time applications such VoIP. Therefore, cross-layer HO schemes have been proposed later to accelerate the HO processes [5, 8, and 11]. These schemes are designed to process MAC layer and IP layer HO procedures concurrently and aim to reduce the total HO latency. This report introduces one of such promising cross-layer WiMAX HO schemes. The cross-layer WiMAX HO scheme used the FMIPv6 (Mobile IPv6 Fast Handover protocol) [14] and originally proposed by Jang, et al [8, 11]. The scheme interleaves MAC layer and IP layer HO procedures without unnecessary delay between those procedures by adding several triggering messages. Previous studies on the scheme up to now have not included sufficient test results or performance evaluation of the original proposal [11]. Therefore, this report aims to provide a software module simulating the cross-layer WiMAX HO scheme based on the FMIPv6 [8, 11, and 14]. This WiMAX mobility module is to evaluate 1) the support of mobile VoIP service through the HO delay and 2) R-factor measuring voice quality.

This report is organized as follows. First, background and related studies are overviewed in Section 2. Next, the cross-layer WiMAX HO scheme based on the FMIPv6 [14] is introduced in Section 3 with the detailed design of the VoIP supporting WiMAX mobility module. In the Section 4, simulation details and the performance evaluation are presented. Finally, a conclusion is drawn in Section 5.

2. Background and related studies

Understanding the existing mobility supports for the mobile WiMAX network is an important first step of this project. The rest part of this section is organized with following sub sections: Section 2.1 Overview of WiMAX handover scenarios, Section 2.2 The IEEE802.16e handover procedures and Section 2.3 Introduction of the fast Handover for Mobile IPv6 (FMIPv6).

2.1 Overview of WiMAX handover scenarios

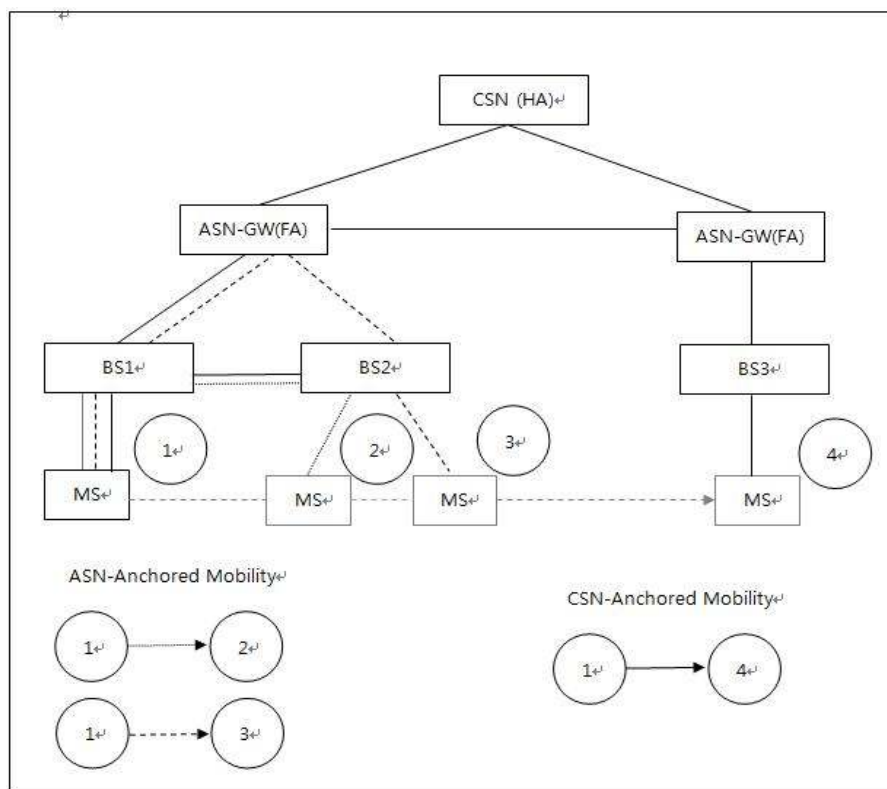

Figure 1. Handover scenarios supported in WiMAX [22]

There are two kinds of mobility in the mobile WiMAX network. One is ASN (Access Service Network)-anchored mobility and the other one is CSN (Connectivity Service Network)-anchored mobility [22]. The various HO scenarios supported in mobile WiMAX networks are depicted in figure 1 [22].

ASN-anchored mobility is also called intra, micro, or layer-2 (L2) mobility. This type of mobility supports scenarios where the MS changes its air interface attachment between the BSs under the same ASN. In this case, the MS' movement does not affect at the network or IP layer and keep the IP attachment intact. The ASN-mobility process starts when signal fading is detected or interference level is increased between BSs. This mobility process is invisible to the network or IP layer, thus such mobility process results in comparatively low HO delay.

CSN-anchored mobility is also referred to as inter, macro, or layer-3 (L3) mobility. This type of mobility supports handover scenarios with moving MS across different IP sub networks. The IETF (Internet Engineering Task Force) mobile IP protocols, such as MIP4, MIP6, and FMIPv6 [14] perform updating the HA (Home Agent) with moving MS' Care-of-Address (CoA) when the MS changes its location between different ASN GWs (Gate Way). In this case, the entire HO procedures is typically exposed to significant extra HO delay, because such procedure requires changes in IP layer address and the HA is generally resides far away from the MS and source ASN-GW [22].

2.2 The IEEE802.16e handover procedures

The IEEE802.16e [10] standard provides MAC layer L2 HO. The HO is performed when the MS needs to change the BS because of signal fading or interference due to node movement. Also it can be used when the MS detect the other BS provide higher quality of service [10].

The HO procedure is comprised with network topology acquisition parts and actual HO process. The network topology acquisition part can be divided into 3 sub procedures, which are network topology advertisement, MS scanning of neighbor BSs, and association procedure. These procedures are executed through the backbone network. When the actual HO process is initiated, data transmission can be paused until the new connection is established. In some cases, this transmission interruption causes service disruption. To prevent this, the IEEE 802.16e standard recommends that the neighboring BS scanning procedure be performed before the actual HO process. Thus, the data transmission would not be dropped while scanning procedure is conducted with the neighboring BS. However, the neighboring BS scanning procedure has to share the same wireless resource with current BS for data transmission and the overall system throughput can be negatively affected [5]. The basic IEEE802.16e handover operation is shown in Figure 2.

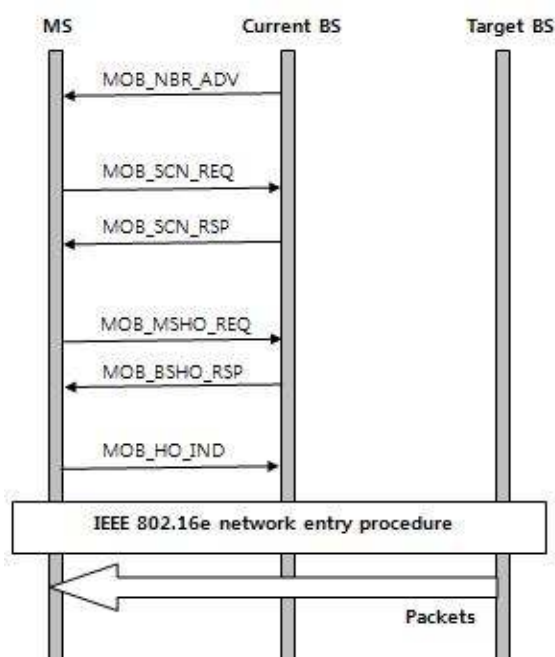

Figure 2. The IEEE 802.16e handover procedure [10]

After the acquisition process described above, the standard then defines several steps of

the actual HO process as following [10].

- Cell re-selection: MS selects target BS according to neighbor BS information, such as signal strength and other QoS level parameters. This information comes from the periodic neighbor advertisement notification (MOB_NBR_ADV) or scanning requests.
- HO decision and initiation: MS can then make HO decision with MOB_MSHO_REQ or BS performs the same process with BS MOB_BSHO_REQ. According to this HO decision, an MS starts the handover procedure from a serving BS to a target one.
- Synchronization with new down link and parameters acquisition: MS needs to be synchronized with target BS downlink and obtain UL and DL transmission parameters. If the previously sent MOB_NBR_ADV includes needed parameters for this job, this process can be shortened.
- Ranging and uplink parameter adjustment: MS and the target BS do initial or handover ranging.
- Ending with the serving BS: Serving BS terminates all contexts of the connections with the MS.

2.3 Introduction of the fast handover for mobile IPv6 (FMIPv6)

If an MS moves to a different IP sub network, the MS must re-configure a new IP address and re-establish its IP connection. Hence, MS needs to perform a network layer handover. Mobile IPv6 (MIPv6) supports the session continuity in this network layer handover [8]. This protocol enables IP handover between different IP subnets without affecting the upper layer connection. However, the handover delay due to MIPv6 is considered too big for supporting real-time service data such as VoIP [14]. The primary

goal of FMIPv6 [14] is to reduce such handover delay through the prediction of handover and preparation beforehand [8, 11]. Figure 3 shows the basic FMIPv6 handover procedure [8, 11].

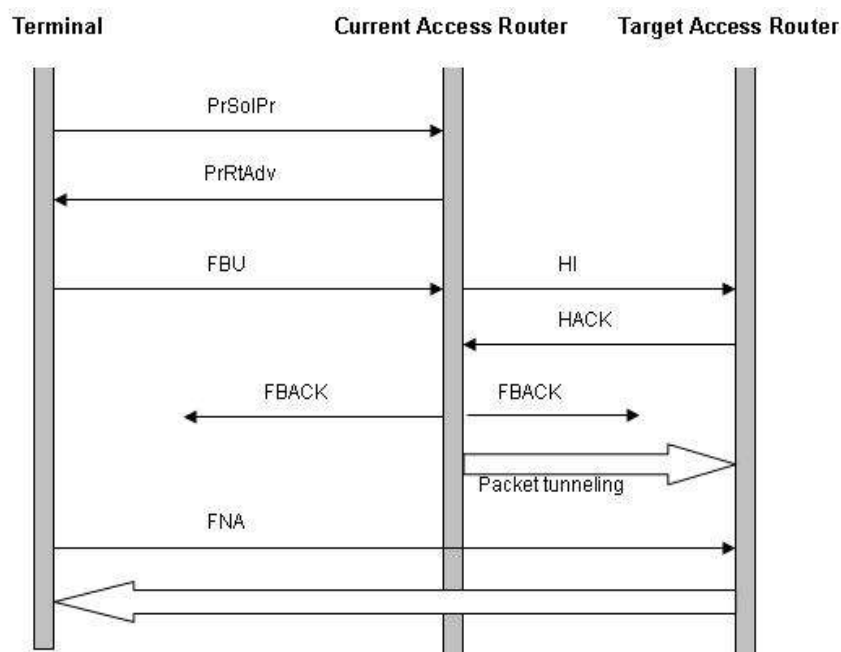

Figure 3. The FMIPv6 handover procedure [8, 11]

In the event FMIPv6 [14] is applied to the IEEE802.16e based mobile WiMAX network; the mobile terminal scans to find the available target base stations. The scan results inform the available base station lists and their physical layer information such as strength of signal. The terminal selects one candidate base station and exchanges the router solicitation for proxy (RtSolPr) [14] and proxy router advertisement (PrRtAdv) [14] with current access router. When the terminal receives PrRtAdv message, it may configure its new IP address, referred as care-of-address (CoA). A fast binding update (FBU) [14] will be transmitted when the terminal indicated a handover. Sending of FBU activates the handover initiation (HI) [14] process and waiting FBACk process. When the target access router receives HI, it confirms the procedure and send HAcK message. Packet tunneling then is established and the first message, fast neighbor advertisement

(FNA) [14] will be sent to inform the target router of the terminal's existence [8, 11].

3. VoIP supporting WiMAX mobility module

In this section, the design of VoIP supporting WiMAX mobility simulation module is presented. This module is designed to create simulation of the FMIPv6-based cross-layer HO scheme [11] and typical non-cross-layer HO scheme with FMIPv6.

The proposed mobility simulation module aims to evaluate and compare the performance of those two types of HO mechanisms' supports for VoIP service over WiMAX network. This module basically combines the IEEE802.16e [10] MAC layer handover mechanism and FMIPv6 [14] IP layer handover mechanism.

The rest part of this section is organized with following sub sections; 3.1 the overview of FMIPv6-based cross-layer WiMAX handover scheme, 3.2 design of a VoIP supporting WiMAX mobility module, and 3.3 handover delay and R-factor.

3.1 The FMIPv6 based cross layer WiMAX HO scheme

Figure 4 illustrates the overall HO procedures using the FMIPv6 [14] based cross layer WiMAX HO scheme [11]. When comparing with the original FMIPv6 HO procedures (shown in figure 3), one can notice that the cross layer scheme combines the IEEE 802.16e WiMAX HO procedures (shown in figure 2) with the FMIPv6 HO procedures. Compared with the 802.11 WLAN (Wireless Local Area Network) HO process, the 802.16e WiMAX HO process is more complicated with extra procedures. This is because the IEEE802.16e standard calls for flexibility of the HO procedures and parameters [14]. If such complicated and relatively long MAC layer HO procedures work separately from the IP Layer HO procedures, total delay of entire HO procedures will be substantially affected and may not meet the minimum requirement for real time services such as VoIP service. The cross layer HO scheme, on the other hand, processes

MAC layer and IP layer concurrently and would save total latency. The FMIPv6 –based cross-layer WiMAX HO scheme was originally proposed by Jang, et al [8, 11] and has been submitted to be a part of IETF draft [11]. The FMIPv6 –based cross-layer WiMAX HO scheme uses certain message interaction between the layer-2 and layer-3 handover procedures. These interaction messages are required not only to accelerate the entire handover procedures but also to ensure each handover messages’ order. These interaction messages are bidirectional in contrast to the traditional schemes with the one-way signaling between layers, typically from the MAC layer to the IP layer [8]. Figure 4 shows how these interaction messages aid cross-layering predictive handover. The detailed definition and usage of those trigger messages will be discussed later.

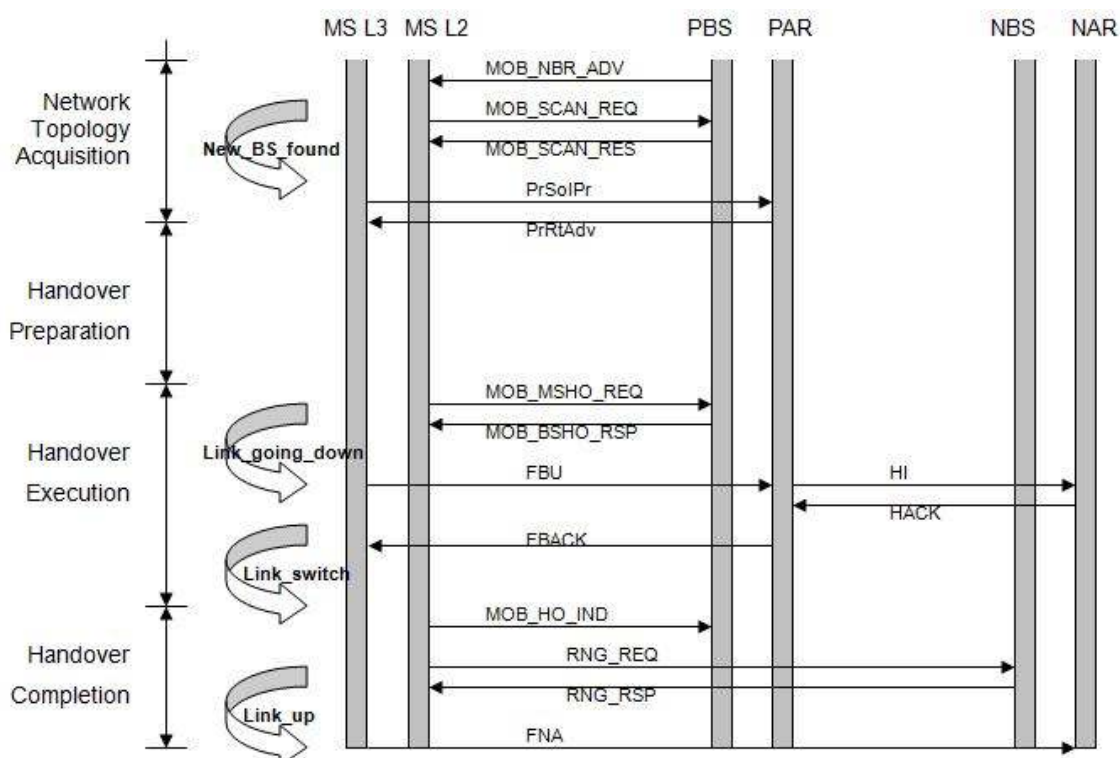

Figure 4. The FMIPv6-based Cross-layer WiMAX Handover Procedure [8, 11]

The Figure 4 also shows four major handover stages, which are network topology acquisition, handover preparation, handover execution and handover completion. Each stage of cross-layer handover procedure includes one interaction message between

IEEE802.16e based MAC layer and FMIPv6-based IP layer. The interaction messages are illustrated with the curved arrows in the figure 4. The four major cross-layer handover stages and four interaction messages are:

Network topology acquisition [8, 10, and 11]

BS periodically broadcast MOB_NBR_ADV messages to the all MSs under its subnet. MOB_NBR_ADV message delivers network topology information. MN sends MOB_SCN_REQ to get the channel information of the neighboring BSs. BS responds with MOB_SCN_RSP and MS synchronizes with neighboring BS with the channel information. To notify the associated AR information as soon as possible, the IP layer trigger message, new_BS_found, is used. When the MS discover new BS, it notifies the information to the IP layer with the first triggering message depicted in the figure 4. Once the link layer receives the new_BS_found message the IP layer exchanges RtSolPr and the PrRtAdv messages with the PAR (Previous Access Router).

Handover preparation [8, 10, and 11]

When an MS decides to make a handover between its serving BS and new target BS, the handover procedure is initiated. Alternatively, the serving BS can also initiate handover decision. In either case, MOB_MSHO-REQ from an MS or MOB_BSHO-REQ from BS processes handover. Once the handover request message is received from MS or BS, reception of such messages is notified to the IP layer with link_going_down message. This message prevents the malfunction of separated two layers' message handling. For example, IP layer FBU message could be sent before MAC layer MOB_BSHO-RSP or MOB_MSHO-RSP message or the blank time is possible between the reception of either MOB_BSHO-RSP or MOB_MSHO-RSP and delivery of FBU. When the IP layer receives the link_going_down message, it sends FBU to the PAR.

PAR establish tunnel between PCoA (Previous Care-of-address) and NCoA (New Care-of-address) by HI and HACK message exchanges, and forwards the data packets destined for the MN to NCoA.

Handover execution [8, 10, and 11]

If the MS successfully received the FBAck message including NCoA information, the MS process the next step of MAC layer handover as soon as possible. The link_switch message help to MAC layer send the MOB_HO_IND without unnecessary delay. Otherwise, the trigger message can work for holding the MAC layer MOB_HO_IND message handling until the FBAck message is received in IP layer. In this case, the possibility of processing with the predictive mode can be higher.

Handover completion [8, 10, and 11]

When MS move to the new subnet, it synchronized with new BS and process network entry procedure. In this stage, MS exchange RNG-REQ/RNG-RSP messages with new BS. As soon as the MAC layer network entry procedure is completed, link_up message notify this to IP layer. Once IP layer receive the link_up message, it deliver FNA to NAR (New Access Router). Receiving the FNA on NAR, the NAR deliver buffered data packets to the MN.

Table 1 shows aforementioned four interaction messages between IP layer and MAC layer.

Message Name	Sender	Receiver	Triggered when	Effect of receipt
new_BS_found	MAC layer	IP layer (the FMIPv6	New BS(s) is found	FMIPv6 RtSolPr message is Sent to the PAR

		module)		
link_going_down	MAC layer	IP layer (the FMIPv6 module)	Reception of MOB_BSHO_RSP	FMIPv6 FBU message is snt to the PAR
link_switch	IP layer (the FMIPv6 module)	MAC layer	Reception of FBBack	MOB_HO_IND message is Sent to the BS
link_up	MAC layer	IP layer (the FMIPv6 module)	Completion of IEEE802.16e Network entry procedure	FNA message is Sent to the NAR

Table 1. Interaction Messages between layers and its usages [11]

3.2 The VoIP supporting WiMAX mobility module

This section presents the implementation details of the proposed VoIP supporting WiMAX mobility module. The module aims to simulate the FMIPv6-based cross layer HO scheme. However, it only includes the predictive mode procedures of the cross layer HO scheme needed for the VoIP testing.

Some HO preparation processes of the IEEE 802.16e MAC layer HO procedure, such as MS scanning of neighbor BSs or association process, are still ambiguous. This is because of the insufficient specifications of exact usage of optional processes and duplication of unnecessary steps. Due to aforementioned reason, performance of each handover initialization procedure in the IEEE802.16e is needed to be examined for supporting VoIP services. As the simplest yet effective handover initialization procedure [6], IEEE802.16e association level-0 mechanism is selected to implement

VoIP supporting WiMAX mobility module. The major design decisions and development challenges are discussed as follow.

Design Decisions:

- NS-2[23] version2.28 is selected as main simulator. NS-2 is considered as the standard like simulation tool in network community. NS2 is an open-source simulator, continuously improved by network researchers. The simulator includes a lot of protocols, algorithms and applications for wired and Wireless network [23].
- The WiMAX mobility module utilized the NS2 WiMAX mobility extensions developed by NIST (National Institute of Standards and Technology) [19]. The NIST module consists of the OFDM (Orthogonal frequency-division ultiplexing) physical layer, TDD (Time-division duplex) MAC layers and layer-2 handovers. The MAC (medium access connection) layer implementation of the NIST module also includes messages that handle network entry procedure. However, these management messages do not typically include authentication. The bandwidth allocation scheduler based on the round robin algorithm is provided for the module [19].
- MobiWAN, an NS2 extension, is adopted to simulate Mobile IPv6 [16]. On top of the MobiWAN module, the FMIPv6 IP layer HO procedures are implemented.

Development Challenges:

- Wireless MAN-OFDMA and FDD is not implemented in NIST module [19].
- ARQ (Automatic Repeat Request) is not implemented in NIST module [19].
- QoS scheduling and service flows are not implemented in NIST module [19].
- Periodic ranging and power adjustments are not implemented in NIST module [19].
- Packing is not implemented in NIST module [19].
- Error Correction is not implemented in NIST module [19].

- NIST [19] module's MAC layer handover scheme is incomplete
- Service flow and QoS scheduling is not implemented in NIST module [19].
- NIST module and MobiWAN are not developed on the same version of NS2. To combine two different NS2 extensions, environmental tune up is needed.

WiMAX MAC layer HHO procedure with association level0:

An association is performed for initial ranging at the scanning procedure. Through the association, an MS sets the parameters used to select candidate BSs [10]. This procedure uses the contention-based initial ranging [6, 10]. NIST WiMAX mobility module includes this simplest MAC layer HO procedure [19].

FMIPv6 HO implementation on top of Mobiwan

NS2 supports only MIPv4 officially [23]. To utilize the MIPv6 or the other mobility protocols, Mobiwan NS2 extension [16] is needed. Mobiwan is officially developed for ns-21b6. However ns-21b6 is not compatible with NS2 WiMAX mobility module. There are some Mobiwan patches supporting relatively recent version of NS2 (ns-2.28) developed by individual users. Following internet sites provides those patches:

- <http://www.ti-wmc.ns/mobiwan2>
- <http://www.kolonianet.pl/przemac/ns/ns-228-mobiwan-102.diff.gz>

Detailed procedures adopting the new Mobiwan patch are described in appendix.

On top of the new Mobiwan package, the FMIPv6 module is implemented as follows:

Class:: function ()	Description
MIP_Agent::command()	Binding with existed Mobiwan MIPv6 objects and execute the send_packet() function
FMIP_Agent::send_packet()	Deliver messages between MS and BS

FMIP_Agent::print_info()	Print out trace information according to each the message's format
FMIP_Agent::get_name()	Find out the message name from the message structure
FMIP_BSAgent::command()	Binding with existed Mobiwlan MIPv6 objects and execute the send_packet() function
FMIP_BSAgent::send_pradv()	Construct PrRtAdv message body and save the current status
FMIP_BSAgent::send_hi()	Construct HI message body and save the current status
FMIP_BSAgent::send_hack()	Construct HACK message body and save the current status
FMIP_BSAgent::send_fback()	Construct FBACK message body and save the current status
FMIP_BSAgent::make_packet()	Construct message packets and save the current status
FMIP_BSAgent::flush_buffer()	Deliver buffered packets to MS and save the current status
FMIP_BSAgent::transit ()	Deliver messages between MS and BS
FMIP_BSAgent::print_info()	Print out trace information according to each the message's format
FMIP_BSAgent::print_status()	Return the process status
FMIP_MSAgent::send_prsol()	Construct RtSolPr message body and save the current status
FMIP_MSAgent::send_fbu()	Construct FBU message body and save the current status

Table 2. FMIPv6 mobility implementation on NS2

The Implementation will be added on the NIST WiMAX NS-2 Module as follows:

Class :: fuction ()	Description
----------------------------	--------------------

Mac802_16SS::receive ()	Detect link status If ‘the link going down’ status is detected Call send_scan_req ()
Mac802_16SS::send_scan_request ()	Set Association duration and Interleaving intervals
Mac802_16BS::process_scan_request ()	If Scanning Type = 0b001, Association 0 procedures can be used. If Scanning Type = 0b010, Association 1 procedures can be used. If Scanning Type = 0b011, Association 2 procedures can be used.
Mac802_16BS::send_scan_response()	If the scan duration parameter is set to zero in MOB_SCN-RSP message, the scanning request is denied [10].
Mac802_16SS::send_msho_request()	
Mac802_16BS::send_msho_response()	Set List of Recommended BSs
Mac802_16SS::process_bsho_response()	List of Recommended BSs Send MOB_HO_IND message
Mac802_16BS::process_ho_ind()	

Table 3. WiMAX mobility implementation on NS2 [19]

4. Performance Evaluation

This section presents performance evaluation of the cross-layer scheme for supporting VoIP service. Section 4.1 includes descriptions about the simulation settings and topology used for the experiments. Section 4.2 evaluates the simulation results mostly with two major performance metrics, handover delay and VoIP service user satisfaction using R-factor. The simulation tests two different protocols, the cross-layer FMIP-based WiMAX HO (CLHO) and the non-cross-layer FMIPv6-based WiMAX HO (N-CLHO).

4.1 Simulation settings

The simulation software module is built on simplified but typical network topology. For the physical layer, NIST WiMAX module [19] supports OFDM/TDD with 5ms OFDM frame duration. Figure 6 illustrate the simple network topology with 4 base stations. It is assumed that the 4 access routers are coexisting with the 4 base stations. There are 3 gateways connecting each access routers, home agent, and correspond node (all so called sink node). A Mobile Node (MN) having wireless attachment to BS1 communicates with corresponding node (CN) and home agent (HA) attached GW1. The MN is assumed to move around each base station with default 20m/s speed.

To evaluate the performance of the cross-layer scheme for supporting VoIP service, VoIP traffic using constant bit rate (CBR) traffic over user datagram protocol (UDP) is used. This simulation assumes that it use G.729a as a bandwidth efficient codec commonly used for VoIP application. Typical codecs generally consume 64Kbps of voice bandwidth. G.729a reduces the bandwidth into 8Kbps. Total algorithmic delay for the coder is 15 milliseconds [21]. The codec would produce payload 60 bytes, total 114 bytes packet with 60 milliseconds interval according to the figure 5 and table 4.

Ethernet (14B)	IP (20B)	UDP (8B)	RTP (12B)	Voice Payload
-------------------	-------------	-------------	--------------	---------------

Figure 5. Determination of Packet Size for Voice Codec [24]

G.729a Codec			
Bit-rate (Kbps)	Payload (Bytes)	Packet Size(Bytes)	Interval (ms)
8	20	74	20
	40	94	40
	60	114	60

Table 4. Parameters of G729a Codecs [24]

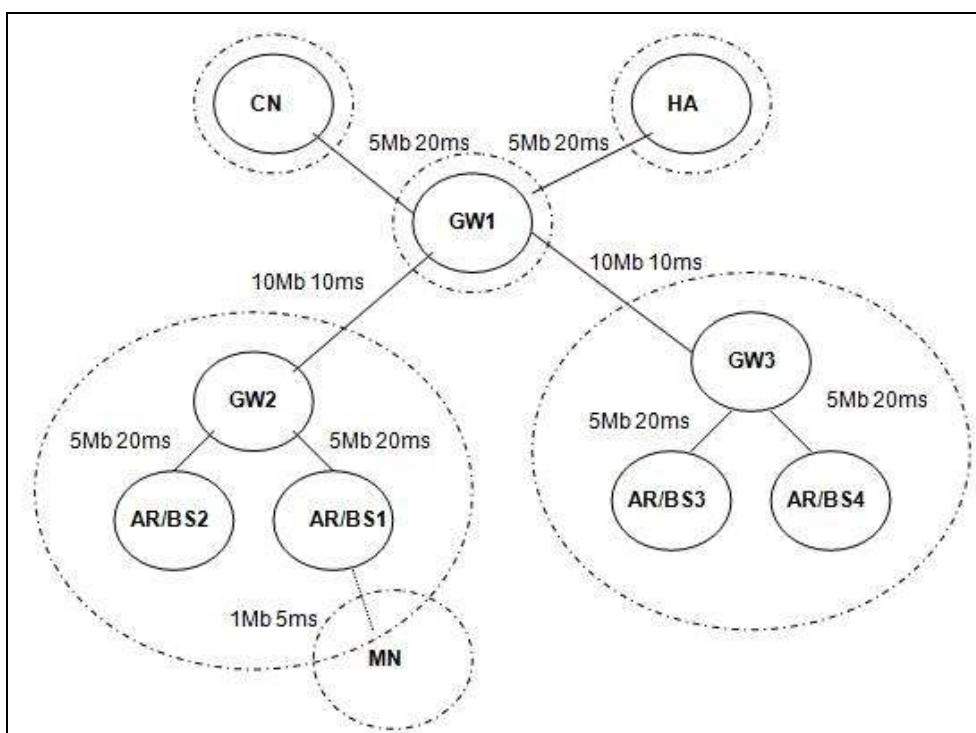

Figure 6. Simulation network topology

Table 5 explains the input parameters related to WiMAX MAC layer and its usages. Most of those parameters are defined by NIST WiMAX module [19] and are mostly used as default values.

Parameters	Example value	Explain
frame_duration	0.005 (s)	Frame duration
queue_length_	50 (packets)	Maximum number of packets
fbandwidth_	5 (MHz)	Frequency bandwidth
propagation	Two_ray_ground	Propagation model
antenna	Omni antenna	Antenna model
highestAntennaZ_	1.5 (m)	Antenna height
lgd_factor_	1.8	Set the factor used to generate a link going down. When the received power is less than $factor * RXThresh_$, a trigger is generated to initiate scanning. The higher the factor, the

		<i>sooner the trigger is generated.</i>
scan_duration_	5 (frames)	<i>Set the number of frames to perform scanning.</i>
interleaving_interval_	1 (frames)	<i>The number of frames exists during two scanning times</i>
scan_iteration_	1	<i>Set the number of iterations to perform scanning.</i>
nbr_adv_interval_	0.5 (s)	<i>The interval time(s) between two MOB_NBR-ADV messages</i>
scan_req_retry_	3	<i>Set the number of retransmissions for MOB_SCAN-REQ</i>
debug_	0	<i>Indicates if debug information must be printed regarding the scanning controller.</i>
adv_interval_	1.0 (s)	<i>Set the interval time between the exchanges of DCD/UCD information between neighboring BSs. This exchange is done using the backbone network.</i>
default_association_level_	0	<i>Set the scanning level to use. The information is embedded in the MOB_SCAN-RSP message sent by the BS to the MS.</i>
synch_frame_delay_	0.005 (s)	<i>Processing delay between the reception of a MOB_SCAN-REQ and the sending of the MOB_SCAN-RSP when</i>

		<i>synchronization with target BSs is needed.</i>
--	--	---

Table 5. WiMAX parameters [19]

Table 6 explains other major input parameters and their usages. Most of these parameters are newly defined for this simulation and their values vary in each test. Thus, these parameters are set by not only input script files but also command line inputs.

Main parameters	Example value	Explain
packetsize	114 (bytes)	Simulation assumes that it use G729a codec[5]
interval	0.06 (s)	60ms interval[5]
mn_movement_from	1	1 means MS' serving BS is BS1
mn_movement_to	2	2 means MS's target BS is BS2
mn_speed	20 (m/s)	MN's moving speed[2]
handover	fmip	Handover schemes: cross_fmip, fmip, mipv6
simulation_stop	60 (s)	Simulation duration
Traffic_start	5 (s)	Communication starting time between CN and MN
Traffic_stop	55 (s)	Communication ending time between CN and MN
mn_movement_start	30 (s)	MN movement start time

Table 6. Additional Input parameters

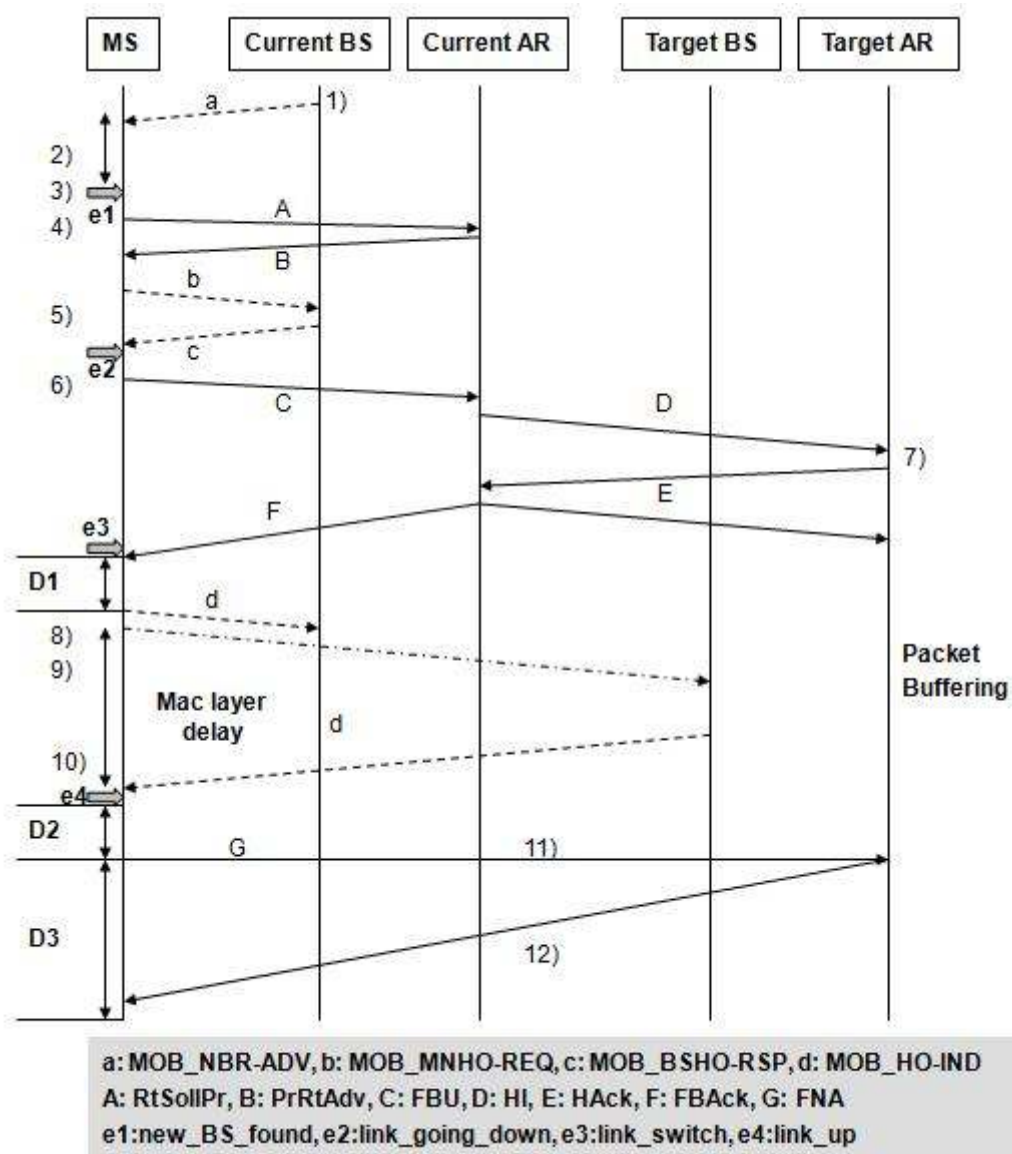

Figure 7. The cross-layer handover scenario [8, 11]

Figure 7 illustrates the cross-layer handover scenarios with utilization of the triggering messages between layer-2 and layer-3. The description of the cross-layer HO procedures illustrated in figure 7 is following:

- 1) MOB_NBR_ADV messages are broadcasted from the current BS periodically.
- 2) MS sends a scan request to its serving BS1 with association parameter set as level 0 (with scanning type=0b001). The current BS and the MS negotiate about the association duration and intervals via MOB_SCN_REQ and MOB_SCN_RSP.

- 3) After the scanning is successfully done, new_BS_found message will be triggered from layer-2 to layer-3.
- 4) When new BS is detected in order that the MS starts the new target AR discovery by exchanging the RtSolPr and PrRtAdv.
- 5) MS begins handover through the MOB_MSHO-REQ transmission to the current BS. Then, the current BS would response with MOB_MSHO-RSP to the MS.
- 6) After the layer-2 HO request message exchange, link_going_down will be delivered to layer-3.
- 7) On receiving link_going_down, MS sends FBU to the current AR.
- 8) When FBAck message arrives, layer-3 of MS issues link_switch message to layer-2 of MS. As soon as layer-2 of MS gets the trigger message, it transmits MOB_HO_IND to the target BS.
- 9) MS performs handover to target BS and conducts “the IEEE 802.16e network re-entry procedure”.
- 10) As soon as completing “the IEEE 802.16e network re-entry procedure”, the layer-2 of MS informs its layer-3 link_up message.
- 11) When link_up message is received, the layer3 of MS sends FNA to the Target AR.
- 12) When FNA is received, the Target AR starts to send the buffered packet to the MS.

4.2 Performance metrics

This section discusses two performance metrics evaluating the FMIPv6-based cross-layer handover scheme. Those metrics are handover delay and voice quality level, so-called R factor, defined in E-model [24]. The E-model is a computational model predicting the quality of voice using parameters of a phone call transmission and provides overall rating for voice quality.

4.2.1 Hand over delay

To evaluate the handover delay, some parameters related to the HO procedures need to be defined. Hand over delay can be defined as the elapsed time from a mobile node receiving the last packet through its previous access router to the first packet through the new access router. Previous figure 7 showed the whole procedures of the cross layer WiMAX HO scheme with the handover latency parameters [11]. The description of the parameters in the Figure 7 follows:

MAC layer delay: The elapsed time between processing of MOB_HO-IND message and completing the IEEE 802.16e network re-entry process.

D1: The elapsed time between the reception of the last packet (FBAck processing) and MOB_HO-IND message

D2: The elapsed time between the link_up message and an FNA message.

D3: The elapsed time between an FNA message and the first packet from the target access router.

Roughly, the handover latency for the cross-layering handover can be expressed as follows:

$$\text{Total handover latency} = \text{MAC layer delay} + D1 + D2 + D3.$$

Here, the *MAC layer delay* can be calculated with following equation [6]:

$$\text{MAC layer delay} = Tc_req + Trsp + Tau + Treg + Tsync.$$

Where, Tc_req is the average time required for the contention-based RNG-REQ message transmission; $Treg$ is the average time required for non-contention-based RNG-REQ message transmission; $Trsp$ is the average time required for waiting for RNG-RSP message after transmitting RNG-REQ message; Tau is the average time required for reauthorization process; $Treg$ is the average time required for re-registration

process; T_{sync} is the average time required for synchronizing with down link[6].

Following table 7 listed the simulation parameters for MAC layer HO and their typical values [25].

Simulation Parameter	Default values (ms)
T_{sync}	10ms
$Tc_{req} + Trsp$	5ms
$\tau + Treg$	50ms in modest load, 100ms in heavy load

Table 7. A default values of simulation parameters [25]

4.2.2 R-factor

There are two classic ways to evaluate voice quality, which is Mean Opinion Factor (MOS) and ITU-T E-model. MOS depend on human experts involved in the evaluation. Thus, it is time consuming, not cost effective, and not repeatable.

On the other hand, E-model predicts voice quality using a computational model with network measurement values. The R factor, the output of the E-model, can be a value from 0 to 100, where 0 represents the poorest possible level and 100 represents the best possible quality level [20]. R factor, 70 is considered a minimum value of a traditional PSTN call and would also be considered as the lower limit of a VoIP call quality [15].

The R-factor applies voice quality impairments as follows [20]:

$$R = 100 - I_s - I_e - I_d + A$$

Where, I_s means the signal-to-noise impairment factor, I_e is an equipment impairment factor (loss), I_d represents the impairment factor (delay), A , also called expectation factor, is a constant compensating aforementioned impairment factors in many other user conditions.

The bonus factor A 's typical range is 0 to 20 and the example values are as shown Table 8.

Communication System	A factor value
Wired phone	0
Cellular in building	5
Cellular in moving vehicle	10
Access to hard to reach geographical zones	20

Table 8. A factor values proposed by the ITU [24]

In the typical VoIP simulation, only l_e and l_d are considered variables. Using implicit default values of recommendation ITU-T G.107 which are $R_o=947688$, $I_s=14136$, $A=0$, for all other factors than loss (l_e) and delay (l_d), the R-factor can be expressed to the following [7, 20]:

$$"R = 94.2 - l_e - l_d"$$

Effect of delay (l_d):

The delay impairment, l_d , is dependent on "the one-way mouth-to-ear delay" [7]. This "one-way mouth-to-ear delay" is consisted of codec delay, network delay, and play out delay. The total delay, d , can be expressed to the following [7]:

$$d = d_{codec} + d_{network} + d_{layout}.$$

This "one-way mouth-to-ear delay" impacts the voice quality. Following equation show the effect of this delay [20]:

$$"l_d = 0.024d + 0.11(d - 177.3) H(d - 177.3)"$$

"Where, $H(x)$ is an indicator function. $H(x) = 0$ if $x < 0$; otherwise, this is 1. [20]"

In wire-line networks, transmission delays are usually constant and below 30 milliseconds. In the internet, delays are generally larger. Moreover, they are variable, resulting in *jitter* (see below). Delay in VoIP-transmission results from several factors: Firstly, the speech signal has to be recorded and coded. Secondly, it is packetized in IP

packets. Thirdly, routing and transmission delays on the network have to be taken into account. Finally, the packets are buffered in the *jitter buffer* (see below) and have to be decoded again. These factors add up to a total between 150 and 400 ms according to Table 9 [26].

Delay parameters	Values(ms)
Recording	10–40
Coder	10–20
Internet delivery	70–120
Jitter buffer	50–200
Decoder	10–20
Total	150–400

Table 9. End-to-end VoIP packet delay [10].

For the simulation, it is assumed that the VoIP traffic data is generated by G729a codec.

Under the assumption, delay parameters are presented as below.

Delay parameters	Values
<i>d</i> codec	25ms
<i>d</i> network	82.3ms
<i>d</i> playout	70ms

Table 10. Delay parameters, codec G.729a [20]

Effect of loss (le):

Delay is consisted of codec delay, network delay, and play out delay and the total delay can be expressed to the following [20]:

Table 11 shows the packet loss via matching equipment impairment factor I_e values when codec G.729a is used.

% Packet Loss	G729a
0	11
0.5	13
1	15

1.5	17
2	19
3	23
4	26
8	36
16	49

Table 11. Ie under conditions of packet loss, codec G.729a [27]

4.3 Simulation Results

This section presents the performance evaluation result for two different HO schemes. The first scheme is the FMIPv6-based cross-layer WiMAX HO scheme (CLHS) and the other one is the conventional non-cross-layer WiMAX HO scheme (N-CLHS). Both handover schemes are based on usage of IEEE 802.16e based layer-2 HO procedures and FMIPv6 based layer-3 procedures. This performance evaluation is measured in terms of two major metrics, HO delay and R-factor, explained in Section 3.3. Accordingly, later part of this section is organized with three sub parts; the HO delay evaluation, the R-factor evaluation, and the additional tests evaluation.

4.3.1 The HO delay evaluation

As described in the simulation section 4.1, the simple network topology with 4 base stations (BS), a mobile node (MN), and 2 sink nodes (SN) are applied in this simulation. To measure handover delay, MN is assumed to move around each base station with default 20m/s speed. To assess VoIP service user satisfaction, MN node communicates with SN through the VoIP traffics, which is modeled with constant bit rate (CBR) traffic over user datagram protocol (UDP).

Simulation duration is set to 60 seconds and VOIP traffic starts at the first 5 seconds and ends at the 55 seconds. MN starts to move at the 30 seconds. 4 different simulations are carried out for HO delay comparisons which are inter CLHS, intra CLHS, inter N-

CLHS and intra N-CLHS. Layer-2 handover (L2HO) is called to as “intra” HO and Layer-3 handover (L3HO) is referred to as “inter” HO. Intra HO only changes the air interface attachment point but keeps IP attachment unchanged. In the intra HO tests for CLHS and N-CLHS, MN moves from serving BS to target BS, which belong to the same gateway. In contrast, for the inter HO tests, MN required to change the IP attachment point from serving AR to target AR. During inter HO, the FMIPv6 protocol updates HA with the MN’s CoA. In the inter HO tests, MN moves from serving BS belonging to serving gate way (SGW) to target BS belonging to target gateway (TGW). Hand over delays for different handover mechanisms can be presented by the following equations in the table 12.

Handover Mechanism	Handover delay
CLHS-inter	$D = Trnq + Tau + Treg + Tsync + Tcross_FMIPv6$
CLHS-intra	$D = Trng + Tau + Treg + Tsync$
N-CLHS-inter	$D = Tng + Tau + Treg + Tsync + TFMIPv6$
N-CLHS-intra	$D = Trng + Tau + Treg + Tsync$

Table 12. Handover delays

Where, $Trng$ is the time duration for the RNG-REQ transmission; Tau is the time duration for reauthorization process; $Treg$ is the time duration for re-registration process; $Tsync$ is the time duration for synchronizing with down link [6, 12].

$Tcross_FMIPv6$ can be calculated with following equation [8]:

$$Tcross_FMIPv6 = D1 + D2 + D3$$

Where, $D1$ is the elapsed time between the reception of the last packet and MOB_HO-IND; $D2$ is the elapsed time between the link_up message and FNA; $D3$ is the elapsed time between FNA message and the first packet released from the target AR.

$TFMIPv6$ can be calculated with following equation:

$$TFMIPv6 = DFNA_FBACK + D3$$

Where, $DFNA_FBACK$ is the elapsed time between the reception of FBACK and FNA.

Table 13 includes simulation results of four different handover mechanisms.

HO Mechanism	<i>MAC layer</i>	<i>Tcross_FMIPv6</i>	<i>TFMIPv6</i>	<i>Total HO Delay</i>
CLHS-inter	55ms	16ms	N/A	71ms
CLHS-intra	65ms	N/A	N/A	65ms
N-CLHS-inter	65ms	N/A	65ms	130ms
N-CLHS-intra	65ms	N/A	N/A	65ms

Table 13. HO Delays for CLHS, N-CLHS

The four different mechanism's MAC layer HO delays are same except CLHS-inter mechanism. Because CLHS-inter mechanism saves 10ms of average synchronizing time, its MAC layer HO delay is 10 milliseconds shorter than the other mechanisms. Table 13 describes overall HO delay measured for four different HO mechanisms.

N-CLHS, FMIPv6-inter HO delay is almost twice the time of the other HO mechanisms' delay. As suspected, this delay is due to the fact that FMIPv6-inter mechanism processes layer-2 and layer-3 HO separately in sequential order. Whereas, CLHS, Cross-inter HO reduces almost HO delay by fifty (50) percent from the N-CLHS, FMIPv6-inter HO by carrying layer-2 HO and layer-3 HO concurrently. The total delay (known as "one-way mouth-to-ear delay" [7]) can be expressed to the following [20]:

$$d = d_{codec} + d_{network} + d_{payout}.$$

For the simulation of this project, VoIP streams are generated by G729a codec. Under this assumption, typical values of 25ms d_{codec} and 70ms d_{payout} were selected for carrying out the simulation [21]. Total delay values for different HO mechanisms are shown in the table 14.

HO Mechanism	Total Delay
CLHS-inter	166
CLHS-intra	160

N-CLHS-inter	225
N-CLHS-intra	160

Table 14. Total delay for HO mechanisms

The HO delay in Mobile WiMAX is an issue that may affect real-time application's session continuity. The result indicates that N-CLHS-inter HO delay far exceed the requirement of typical real-time services (e.g., 150 ms for Voice over IP) [20]. The result also shows that CLHS-inter mechanism saves approximately 26% delay from NCLHS-inter mechanism's excessive delay.

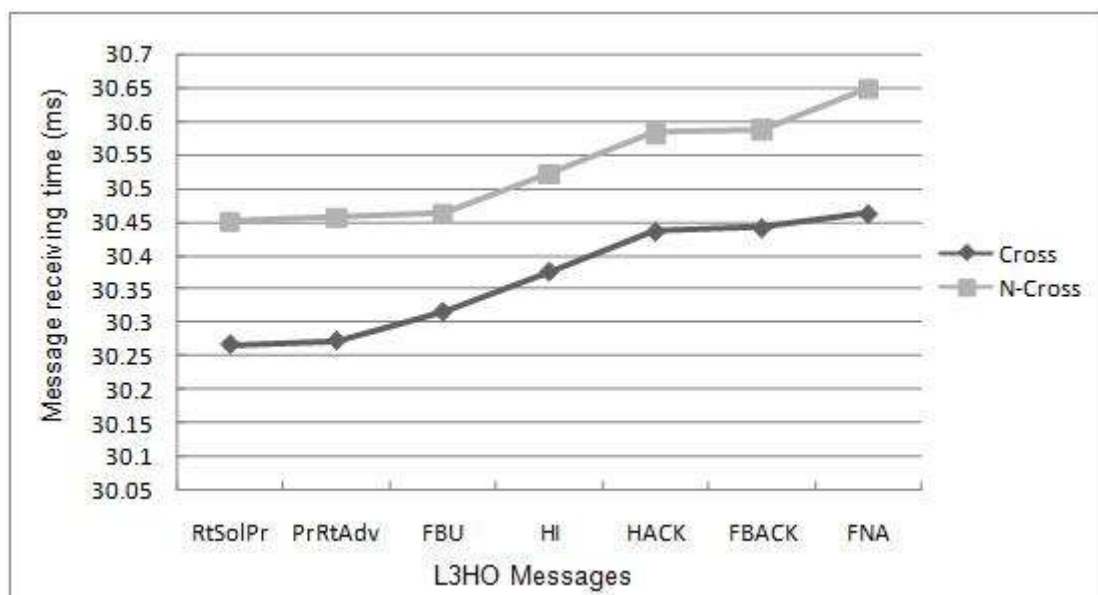

Figure 8. Layer-3 HO messages for CLHS and N-CLHS

Figure 8 illustrates L3HO messages of CLHS-inter HO and N-CLHS-inter HO via simulation time. CLHS's RtSolPr messages get processed faster than NCLHS. This is possible because of the *new_bs_found* L2 trigger message. The trigger message notifies that L2HO's scanning BS work is completed. Compared to N-CLHS, CLHS used longer time between PrRtAdv and FBU. This is because CLHS's L3HO process cooperates with L2HO. In CLHS, FBU message couldn't carry out until it receives the *link_going_down* trigger message notifying reception of L2HO's MOB_BSHO_RSP

message. The *link_going_down* trigger message works for holding the L3HO process until necessary L2HO's process is completed. Compared to N-CLHS, CLHS used shorter time between FBACK and FNA. This is also because CLHS's L3HO process cooperates with L2HO. In CLHS, FBU message can be processed faster than N-CLHS because *link_up* trigger message inform earlier that the L2HO is processed.

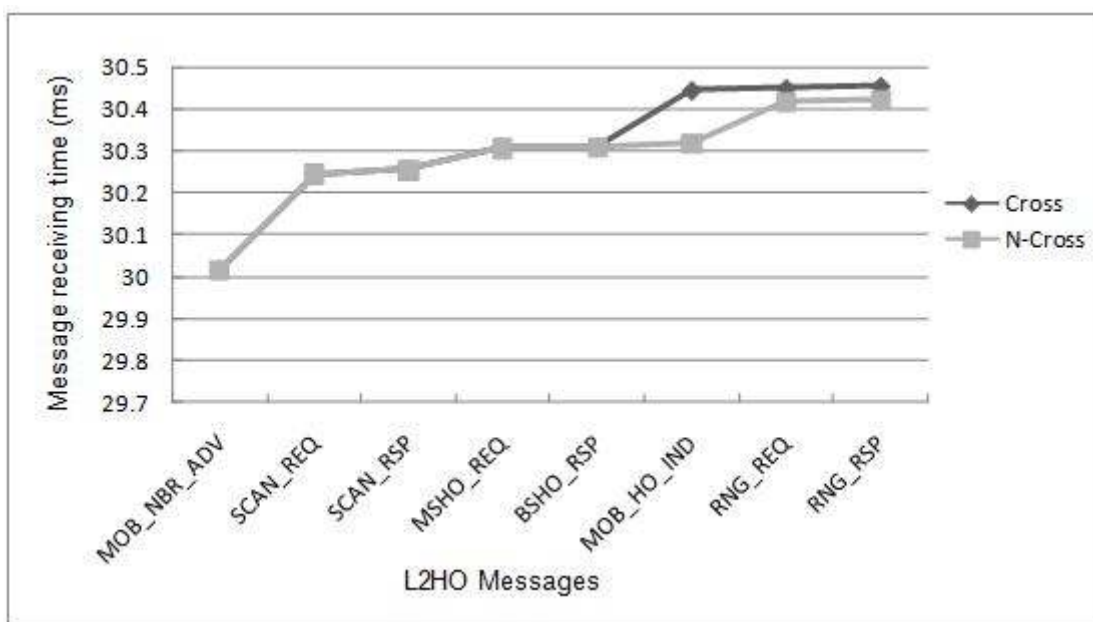

Figure 9. Layer-2 HO messages for CLHS and N-CLHS

Figure 9 illustrates L2HO messages of CLHS-inter HO and N-CLHS-inter HO via simulation time. Compared to N-CLHS, CLHS spends more time between BSHO_RSP and HO_IND message. This is because CLHS's L3HO procedure cooperates with L2HO. In CLHS, MOB_HO_IND message couldn't carry out until it gets *link_switch* trigger message notifying reception of L3HO's FBACK message. The *link_switch* trigger message works for holding the L2HO procedures until necessary L3HO's procedures are completed.

4.3.2 The R-factor evaluation

R factor, one of the major voice quality performance metrics, is selected to determine

how much the CLHS affects to voice quality of VOIP service. R factor is defined from the ITU-T E-model and it predicts voice quality using a computational model with network measurement values such as impairment, loss, and delay. Table 15 presents R-factor value to the qualitative categories. If R factor value is below than 50, the connection is not recommended to run.

R-factor range	Voice quality	Users' satisfaction
90 R < 100	Best	Very satisfied
80 R < 90	High	Satisfied
70 R < 80	Medium	Some are satisfied
60 R < 70	Low	Many are not satisfied
50 R < 60	Poor	All are not satisfied

Table 15. Assigning R-factor on the base of the quality [20]

For the simulation comparing R factor between different HO mechanisms, it is assumed that the VoIP streams are generated by G729a codec. Under the assumption, the loss rate is set to 1%. Table 16 shows calculated R factor values from the simulation results of different HO mechanisms.

HO Mechanism	Total Delay	<i>Id</i>	<i>Ie</i>	R Factor
CLHS-inter	166	3.984	15	75.216
CLHS-intra	160	3.84	15	75.36
N-CLHS-inter	225	255.6819	15	-176.4819
N-CLHS-intra	160	3.84	15	75.36

Table 16. R factor values for CLHS, N-CLHS

Except N-CLHS-inter mechanism, all mechanism's R factor is acceptable, where the minimum value of a traditional PSTN call is 70. To get acceptable R factor, total delay should not exceed 183ms. Because N-CLHS-inter mechanism has far exceeding total HO delay, its R factor also belong unacceptable region.

4.3.3 The additional tests evaluation

In the previous sections, CLHS and NCLHS modules with default setting are simulated for the major performance metrics; R factor and HO delay. This section performs some additional simulations with input parameters variation such as mobile node's moving speed, number of mobile nodes, and packet loss. This evaluation is to demonstrate the validity of input parameters selection in the previous sections and examine if change of such input parameters would result in material differences in the simulation.

Figure 10 illustrates the HO delay of 4 different HO mechanisms when the number of mobile nodes is increased 1 to 20. The number of mobile nodes does not affect the HO delay. This is because each mobile node is assumed to use only VoIP service, not various kinds of wide-bandwidth services. VoIP service require relatively very small amount of bandwidth and the introduction of 20 simultaneous mobile nodes in the simulation does not affect the result significantly.

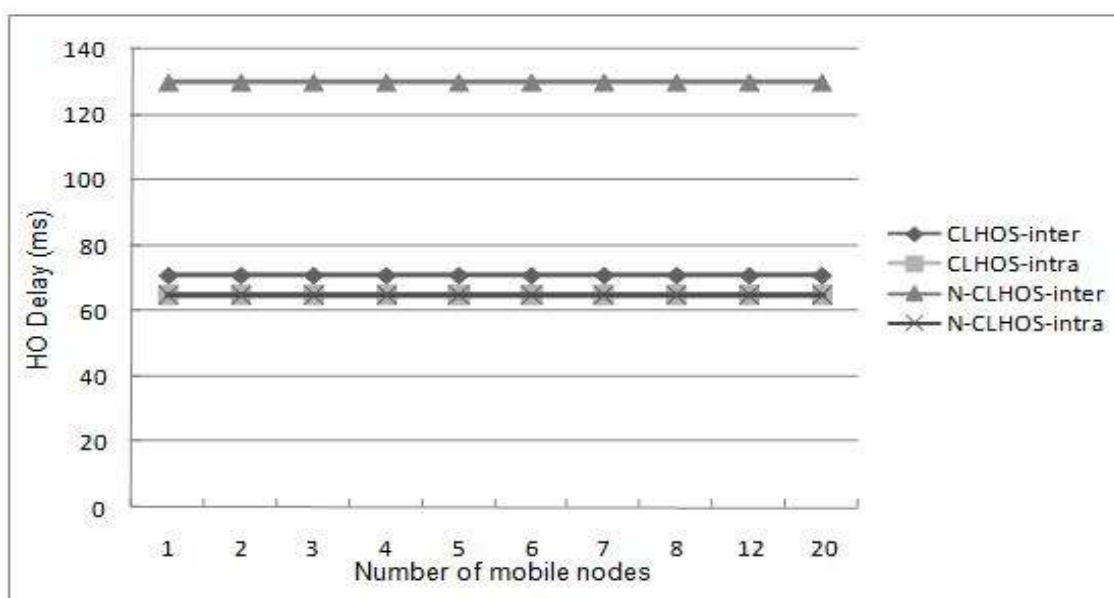

Figure 10. HO Delay via number of mobile nodes

Figure 11 shows the R factors of 4 different HO mechanisms when the packet loss rate is increased 0 to 16. Except the NCLHO-inter mechanism, all mechanism has

acceptable R score values when the packet loss rate is less than 2 %.

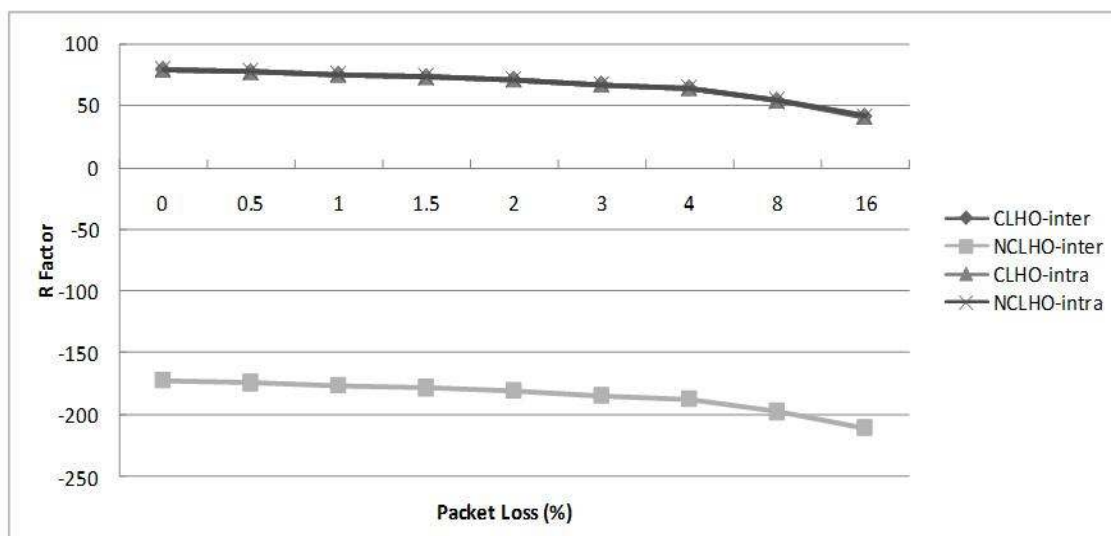

Figure 11. Packet loss rate via R factor

Figure 12 shows the HO delay of 4 different HO mechanisms when the mobile node's speed is increased default value 20 to 100. The mobile node's speed does not affect the HO delay. The result is considered consistent with conventional assumption as such moving speed characteristics are typically defined in lower physical layer and would not affect HO in layer-2 and layer-3.

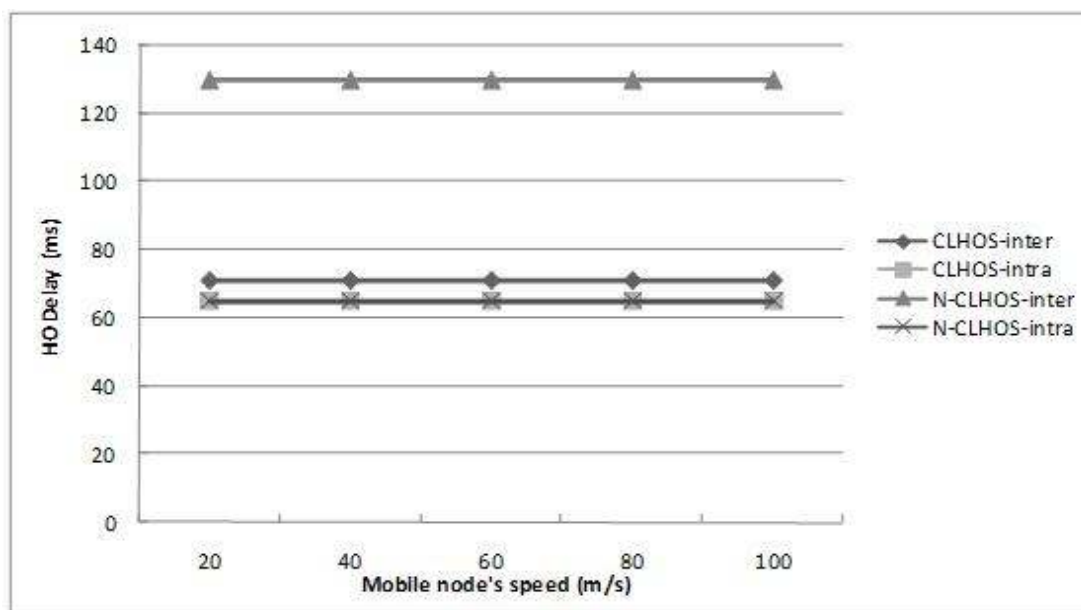

Figure 12. Mobile node's speed via HO delay

5. Conclusion

In this study, a WiMAX mobility simulation module has been proposed and implemented to validate and evaluate the cross-layer scheme for the support of mobile VoIP services. Evaluation based on 2 key metrics; HO delay and R factor were performed and effect of other input parameters was also measured to validate assumptions of the evaluation. Through the rigorous simulations, it was found that the cross-layer scheme has successfully combines layer-2 and layer-3 procedures and shortens HO delays by almost fifty percent in layer-3 HO procedure. The R-factor result also demonstrated that the cross scheme is adequate to support mobile real-time application. In conclusion, it was found that FMIPv6-based cross-layer WiMAX HO scheme [11] would contribute a meaningful improvement on HO performance in mobile WiMAX networks. In the future, additional study could be made in the area of 1) enhancement of the WiMAX mobility module together with the WiMAX QoS classes' supports and 2) optimization of the scheme for other existing and upcoming mobile wireless services.

References

- [1] O. Alanen, "Multicast polling and efficient VoIP connections in IEEE 802.16 networks", *Proceedings of the 10th ACM Symposium on Modeling, analysis, and simulation of wireless and mobile systems*, 2007, pp. 289-295.
- [2] Ana Flávia M. de Lima, Leandro S. G. de Carvalho, José Neuman de Souza, and Edjair de Souza Mota, "A framework for network quality monitoring in the VoIP Environment," *The Proc.s of Int. Journal of Network Management, Vol.17 Issue 4*, July 2007
- [3] B. Chellappan, M. Moh , T.-S. Moh, and S. Venugopal, "Handoff mechanisms for IEEE 802.16 networks supporting intelligent transportation systems," book chapter accepted to appear in *Wireless Technologies for Intelligent Transportation Systems*, Nova Science Publishers, Inc., Spring 2009.
- [4] B. Chellappan, T.-S. Moh, and M. Moh, "On Supporting Multiple Quality-of-Service Classes in Mobile WiMAX Handoff," *IEEE Int. Conf. on Computing, Engineering and Information Systems (ICCEIS)*, Fullerton, CA, Apr 2009.
- [5] Y. Chen and F. Hsieh, "A Cross Layer Design for Handoff in 802.16e Network with IPv6 Mobility," *Wireless Communications and Networking Conference*, 2007, pp. 3844-3849.
- [6] G. Dong and J. Dai, "An Improved Handover Algorithm for Scheduling Services in IEEE802.16e," *Proceedings of Mobile WiMAX Symposium*, IEEE, March 2007, pp. 38-42.
- [7] H. Fathi, S. Chakraborty, and R. Prasad, "Optimization of Mobile IPv6-Based Handovers to Support VoIP Services in Wireless Heterogeneous Networks," *IEEE Transactions on Vehicular Technology*, Volume 56, Issue 1, Jan 2007, pp. 260-270.
- [8] Y.-H. Han, H. Jang, J. Choi, B. Park, and J. McNair, "A Cross-Layering Design for

IPv6 Fast Handover Support in an IEEE 802.16e Wireless MAN Network”, *IEEE Network*, Volume 21, Issue 6, Nov 2007, pp. 54-62.

[9] IEEE 802.16 Working Group on Broadband Wireless Access. *Part 16: Air Interface for Fixed Broadband Wireless Access Systems*, 2004.

[10] IEEE 802.16e EEE Standard for Local and metropolitan area networks. *Part 16: Air interface for fixed broadband wireless access systems – amendment for physical and medium access control layers for combined fixed and mobile operation in licensed bands*, Dec 2005.

[11] H. Jang, J. Jee, Y. Han, S. Park, and J. Cha, “Mobile IPv6 Fast Handovers over IEEE 802.16e Networks,” *RFC 5270*, June 2008.

[12] W. Jiao, P. Jiang, and Y. Ma,” Fast Handover Scheme for Real-Time Applications in Mobile WiMAX,” *IEEE Int. Conf. on Communications, ICC '07*, June 2007, pp. 6038-6042.

[13] D.-G. Kim, H.-J Shin, and D.-R. Shin, “A Network-based Handover Scheme for Hierarchical Mobile IPv6 over IEEE 802. 6e,” *10th Int. Conf. Advanced Communication Technology, ICACT 2008. 10th Volume 1*, Feb 2008, pp. 468-472.

[14] R. Koodli, "Fast Handovers for Mobile IPv6," *RFC 4068*, July 2005.

[15] D.H. Lee, K. Kyamakya, and J.P. Umondi, “Fast Handover Algorithm for IEEE 802.16e Broadband Wireless Access System,” *1st Int. Symp. Wireless Pervasive Computing*, Jan 2006, pp. 6.

[16] MobiWAN: NS-2 extensions to study mobility in Wide-Area IPv6 Networks, <http://www.inrialpes.fr/planete/MobiWAN/>

[17] M. Moh, T.-S. Moh, and Y. Shih, "On Enhancing WiMAX HARQ: A Multiple-Copy Approach," *5th IEEE Consumer Communications and Networking Conf. (CCNC)*, Las Vegas, NV, January 2008.

- [18] C. Nie, V.M., and X. Yang, “Adaptive Polling Service for Next-Generation IEEE 802.16 WiMAX Networks”, *IEEE Global Telecommunications Conf, GLOBECOM '07*, pp. 4754 – 4758, Nov 2007.
- [19] NIST Seamless and Secure Mobility tool suite,
<http://w3.antd.nist.gov/seamlessandsecure/toolsuite.html>
- [20] S. Sengupta, M. Chatterjee, and S. Ganguly, “Improving Quality of VoIP Streams over WiMAX,” *Proceeding of Computers*, IEEE Transactions on Volume 57, Issue 2, Feb. 2008, pp. 45-156.
- [21] Wikipedia.org, <http://en.wikipedia.org/wiki/G.729aa>
- [22] J. G. Andrews, A. Ghosh, R. Muhamed, “Fundamentals of WiMAX: understanding broadband wireless networking,” *Upper Saddle River, N.J.: Prentice Hall*, 2007.
- [23] NS2 network simulator, <http://nsnam.sis.edu/nsnam/>
- [24] C. Bacioccola, G. Cicconetti, “User-level performance Evaluation of VoIP Using ns-2, ” *Proceedings of the 2nd international conference on Performance evaluation methodologies and tools*, Oct. 2007.
- [25] L. Chen, X. Cai, R. Sofia, Z. Huang, “A Cross-layer Fast Handover Scheme For Mobile WiMAX,” *Proceedings of Vehicular Technology Conference*, pp. 1578–1582, 2007 Fall.
- [26] G. Thomsen, Y. JANI, 2000 Internet telephony: going like crazy. *IEEE Spectrum*, pp. 52–58.
- [27] ITU-T G.113, *Transmission impairments due to speech processing*, 2001.

Appendix: NS2 WiMAX extensions and simulator setup

Examined NS2 WiMAX extensions:

Module name / author	Source	Supported Functions	Limitations
WiMAX module for the ns-2 simulator / members of the Computer Networks Laboratory (LRC), Institute of Computing, UNICAMP	http://www.lrc.ic.unicamp.br/wimax_ns2/	Mechanisms for bandwidth request and allocation, QoS provision.	Mobility functions are not supported
WiMAX Module for ns-2 Simulator / Netowrks& Distributed Systems Laboratory(NDSL) members, Computer Science and Information Engineering, Chang Gung University, Taoyuan, Taiwan	http://ndsl.csie.cgu.edu.tw/wimax_ns2.php	Basic functions of the service-specific convergence sub-layer, the MAC common part sub-layer, PHY layer, Simple call admission control mechanism and scheduler	Mobility functions are not supported
NIST Seamless and Secure Mobility tool suite	http://w3.antd.nist.gov/seamlessandsecure/toolsuite.html	PHY layer functions, Time Division duplexing (TDD), Network entry functions without authentication Round robin scheduler IEEE802.16e extensions to support scanning and handovers	QoS functions are not supported. Layer-3 mobility is not supported.
a QoS-included WiMAX Module for	http://perso.telecom-	The QoS classes the management of the QoS requirements,	Hard to apply the

NS-2 Simulator	bretagne.eu/ outfinuaymi/ wimax_slides /	unicast and contention request opportunities mechanisms, and scheduling algorithms for the UGS, rtPS and BE QoS classes It is based on the NIST WiMAX module	module into NS2
----------------	---	---	--------------------

Simulator Setup for the Project:

1. Install NS2 version 2.28

```
$ wget http://www.isi.edu/nsnam/dist/ns-allinone-2.28.tar.gz  
$ tar xzf ns-allinone-2.28.tar.gz  
$ cd /home/any/ns-allinone-2.29  
$ ./install
```

2. Applying Mobiwan NS2 2.28 Patch

```
$ zcat <patchfile.gz> | patch -pl  
$ ./configure  
$ make clean
```

3. Applying NIST WiMAX module for NS2 2.29

Unfortunately, there is no NIST module for NS2-2.28. The most similar version is NS2-2.29. Thus, NIST WiMAX module for NS2-2.29 carefully combined to NS2-2.28.

To do so, files inside the following directories “common, MAC, tcl, wimax” of the NIST WiMAX module is added. Also “Makefile.in”, a file in the NS2 2.29 module, combined with the one in the NS2-2.28.