

2009

# Expression of *Kingella kingae* type IV pili is regulated by $\sigma$ 54, PilS, and PilR

Thomas E. Kehl-Fie

*Washington University School of Medicine in St. Louis*

Eric A. Porsch

*Duke University Medical Center*

Sara E. Miller

*Duke University Medical Center*

Joseph W. StGeme III

*Duke University Medical Center*

Follow this and additional works at: [http://digitalcommons.wustl.edu/open\\_access\\_pubs](http://digitalcommons.wustl.edu/open_access_pubs)

---

## Recommended Citation

Kehl-Fie, Thomas E.; Porsch, Eric A.; Miller, Sara E.; and StGeme, Joseph W. III, "Expression of *Kingella kingae* type IV pili is regulated by  $\sigma$ 54, PilS, and PilR." *Journal of Bacteriology*.191,15. 4976-4986. (2009).  
[http://digitalcommons.wustl.edu/open\\_access\\_pubs/2441](http://digitalcommons.wustl.edu/open_access_pubs/2441)

## Expression of *Kingella kingae* Type IV Pili Is Regulated by $\sigma^{54}$ , PilS, and PilR<sup>∇</sup>

Thomas E. Kehl-Fie,<sup>1,2,3</sup> Eric A. Porsch,<sup>2,3</sup> Sara E. Miller,<sup>3,4</sup> and Joseph W. St. Geme III<sup>2,3\*</sup>

Department of Molecular Microbiology, Washington University School of Medicine, 660 S. Euclid Ave., St. Louis, Missouri 63110,<sup>1</sup> and Department of Pediatrics,<sup>2</sup> Department of Molecular Genetics and Microbiology,<sup>3</sup> and Department of Pathology,<sup>4</sup> Duke University Medical Center, Durham, North Carolina 27710

Received 29 January 2009/Accepted 13 May 2009

*Kingella kingae* is a member of the *Neisseriaceae* and is being recognized increasingly as an important cause of serious disease in children. Recent work has demonstrated that *K. kingae* expresses type IV pili that mediate adherence to respiratory epithelial and synovial cells and are selected against during invasive disease. In the current study, we examined the genome of *K. kingae* strain 269-492 and identified homologs of the *rpoN* and the *pilS* and *pilR* genes that are essential for pilus expression in *Pseudomonas aeruginosa* but not in the pathogenic *Neisseria* species. The disruption of either *rpoN* or *pilR* in *K. kingae* resulted in a marked reduction in the level of transcript for the major pilus subunit (*pilA1*) and eliminated piliation. In contrast, the disruption of *pilS* resulted in only partial reduction in the level of *pilA1* transcript and a partial decrease in piliation. Furthermore, the disruption of *pilS* in colony variants with high-density piliation resulted in variants with low-density piliation. Mutations in the promoter region of *pilA1* and gel shift analysis demonstrated that both  $\sigma^{54}$  and PilR act directly at the *pilA1* promoter, with PilR binding to two repetitive elements. These data suggest that the regulation of *K. kingae* type IV pilus expression is complex and multilayered, influenced by both the genetic state and environmental cues.

*Kingella kingae* is a gram-negative bacterium that belongs to the *Neisseriaceae* family. Improvements in diagnostics have led to the increased recognition of *K. kingae* as an important cause of a number of pediatric diseases, including septic arthritis, osteomyelitis, and endocarditis (10, 27, 32, 37, 39). Several studies have shown that *K. kingae* is a leading etiology of septic arthritis and osteomyelitis, with one study reporting that *K. kingae* accounts for the majority of osteoarticular infections in children younger than 36 months of age (5, 10, 27, 32, 38).

*K. kingae* is believed to initiate infection by colonizing the pharynx, a conclusion supported by the isolation of the same strain of *K. kingae* from both the respiratory tract and the blood of individuals with invasive disease (40). Following colonization, the organism breaches the epithelium, potentially by means of an RTX toxin (19), and then enters the blood and disseminates to deeper tissues, such as bones and joints. Recent work has shown that *K. kingae* expresses type IV pili that are essential for mediating adherence to respiratory epithelial and synovial cells (18), presumably facilitating the colonization of the respiratory tract and the seeding of joints. These fibers have been demonstrated previously to vary in density, with a correlation between the number of pili and the colony type (8, 13). Variants that express high levels of pili have a spreading/corroding colony type, while variants expressing low levels of pili have a nonspreading/noncorroding colony type (8). Interestingly, the likelihood of any level of piliation is much lower in invasive isolates than in respiratory tract isolates of *K. kingae*,

suggesting a loss of piliation during the pathogenesis of invasive disease (T. E. Kehl-Fie et al., unpublished data).

Given the difference in piliation between respiratory tract isolates and invasive isolates, we set out to develop a better understanding of the factors controlling pilus expression. In this work, we provide evidence that the expression of *K. kingae* type IV pili is regulated by  $\sigma^{54}$  and by a two-component regulatory system with significant homology to the PilR/PilS system involved in *Pseudomonas aeruginosa* pilus regulation (3, 14, 16). The loss of  $\sigma^{54}$  or PilR resulted in the complete elimination of pilus expression, while the loss of PilS resulted in only a partial reduction in piliation. The introduction of the *pilS* mutation into variants with the spreading/corroding colony type converted them to the nonspreading/noncorroding colony type. The analysis of the *pilA1* promoter revealed a  $\sigma^{54}$  binding domain that is upstream of the transcriptional start site and is required for pilus expression. Additional work established that PilR binds to two repetitive elements in the *pilA1* promoter.

### MATERIALS AND METHODS

**Bacterial strains and eukaryotic cell lines.** Strains used in this study are listed in Table 1. *K. kingae* strains were stored at  $-80^{\circ}\text{C}$  in brain heart infusion broth with 30% glycerol. *Escherichia coli* strains were stored at  $-80^{\circ}\text{C}$  in Luria-Bertani (LB) broth with 15% glycerol. *K. kingae* strains were grown at  $37^{\circ}\text{C}$  with 5%  $\text{CO}_2$  on TSA II chocolate agar (BD Biosciences, San Jose, CA) supplemented with 50  $\mu\text{g/ml}$  kanamycin as appropriate. *E. coli* strains were grown in LB broth or on LB agar at  $37^{\circ}\text{C}$  supplemented with 50  $\mu\text{g/ml}$  kanamycin or 100  $\mu\text{g/ml}$  ampicillin as appropriate. Chang cells (ATCC CCL-20.2; human conjunctiva) and Hg-82 cells (ATCC CRL-1832; rabbit synovial cells) were cultured at  $37^{\circ}\text{C}$  with 5%  $\text{CO}_2$  as previously described (19).

**Generation of *K. kingae* mutants.** To create gene disruptions in *K. kingae*, the relevant gene was cloned into pUC19 and then interrupted with an antibiotic cassette. The disrupted gene then was transformed into *K. kingae* by natural competence (19), and transformants were selected for by plating on agar supplemented with the appropriate antibiotic. To disrupt *pilS*, a fragment containing *pilS* was amplified from *K. kingae* strain 269-492 by PCR using the primers

\* Corresponding author. Mailing address: Department of Pediatrics, Duke University Medical Center, Children's Health Center, Room T901, DUMC 3352, Durham, NC 27710. Phone: (919) 681-4080. Fax: (919) 681-2714. E-mail: j.stgeme@duke.edu.

<sup>∇</sup> Published ahead of print on 22 May 2009.

TABLE 1. Strains used in this study

Strain	Description	Reference or source
269-492	<i>K. kingae</i> isolate from St. Louis Children's Hospital	19
KK01	Nonspreading/noncorroding variant of strain 269-492	19
KK03	Spreading/corroding variant of strain 269-492	19
269-492 <i>pilF</i>	Strain 269-492 with an <i>aphA3</i> insertion in <i>pilF</i>	19
269-492 <i>pilA1</i>	Strain 269-492 with an <i>aphA3</i> insertion in <i>pilA1</i>	18
269-492 <i>recJ</i>	Strain 269-492 with an <i>aphA3</i> insertion in <i>recJ</i>	18
KK01 <i>recJ</i>	Strain KK01 with an <i>aphA3</i> insertion in <i>recJ</i>	This work
KK03 <i>recJ</i>	Strain KK03 with an <i>aphA3</i> insertion in <i>recJ</i>	This work
269-492 <i>rpoN</i>	Strain 269-492 with an <i>aphA3</i> insertion in <i>rpoN</i>	This work
269-492 $\Delta$ -12	Strain 269-492 with an <i>aphA3</i> insertion in <i>recJ</i> and replacement of the $\sigma^{54}$ -12 DNA GC binding region with AA	This work
269-492 <i>pilS</i>	Strain 269-492 with an <i>aphA3</i> insertion in <i>pilS</i>	This work
KK01 <i>pilS</i>	Strain KK01 with an <i>aphA3</i> insertion in <i>pilS</i>	This work
KK03 <i>pilS</i>	Strain KK03 with an <i>aphA3</i> insertion in <i>pilS</i>	This work
269-492 <i>pilR</i>	Strain 269-492 with an <i>aphA3</i> insertion in <i>pilR</i>	This work
KK01 <i>pilR</i>	Strain KK01 with an <i>aphA3</i> insertion in <i>pilR</i>	This work
KK03 <i>pilR</i>	Strain KK03 with an <i>aphA3</i> insertion in <i>pilR</i>	This work
269-492/ACA#1 <sup>-</sup>	Strain 269-492 with an <i>aphA3</i> insertion in <i>recJ</i> and replacement of ACA#1 repetitive element with random DNA	This work
KK01 ACA#1 <sup>-</sup>	Strain KK01 with an <i>aphA3</i> insertion in <i>recJ</i> and replacement of ACA#1 repetitive element with random DNA	This work
KK03 ACA#1 <sup>-</sup>	Strain KK03 with an <i>aphA3</i> insertion in <i>recJ</i> and replacement of ACA#1 repetitive element with random DNA	This work
269-492/ACA#2 <sup>-</sup>	Strain 269-492 with an <i>aphA3</i> insertion in <i>recJ</i> and replacement of ACA#2 repetitive element with random DNA	This work
KK01 ACA#2 <sup>-</sup>	Strain KK01 with an <i>aphA3</i> insertion in <i>recJ</i> and replacement of ACA#2 repetitive element with random DNA	This work
KK03 ACA#2 <sup>-</sup>	Strain KK03 with an <i>aphA3</i> insertion in <i>recJ</i> and replacement of ACA#2 repetitive element with random DNA	This work
269-492/ACA#1 <sup>-</sup> /ACA#2 <sup>-</sup>	Strain 269-492 with an <i>aphA3</i> insertion in <i>recJ</i> and replacement of ACA#1/ACA#2 repetitive elements with random DNA	This work
KK01 ACA#1 <sup>-</sup> /ACA#2 <sup>-</sup>	Strain KK01 with an <i>aphA3</i> insertion in <i>recJ</i> and replacement of ACA#1/ACA#2 repetitive elements with random DNA	This work
KK03 ACA#1 <sup>-</sup> /ACA#2 <sup>-</sup>	Strain KK03 with an <i>aphA3</i> insertion in <i>recJ</i> and replacement of ACA#1/ACA#2 repetitive elements with random DNA	This work
DH5 $\alpha$	<i>E. coli</i> F <sup>-</sup> $\phi$ 80dlacZ $\Delta$ M15 $\Delta$ ( <i>lacZYA-argF</i> )U169 <i>deoR recA1 endA1 hsdR17</i> ( $r_K^- m_K^+$ ) <i>phoA supE44 thi-1 gyrA96 relA1</i>	29
DH5 $\alpha$ MalC2	DH5 $\alpha$ containing pMalC2, which expresses MBP	This work
DH5 $\alpha$ MAL-PilR	DH5 $\alpha$ containing pMalC2: <i>pilR</i> , which expresses MBP-PilR	This work
DH5 $\alpha$ <i>pilA1</i> : $\Delta$ SS	DH5 $\alpha$ containing pHAT10/ <i>pilA1</i> : $\Delta$ SS, which expresses HAT-PilA1 $\Delta$ SS	This work

PilSk/ofwd and PilSk/orev and ligated into BamHI-digested pUC19, creating pUC19/*pilS*. The *aphA3* cassette was released from pFalcon2 (12) by digestion with PvuII and was ligated into SpeI-digested/T4 polymerase-treated pUC19/*pilS*, creating pUC19/*pilS*:kan. To disrupt *pilR*, a fragment containing *pilR* was amplified using the primers pilRRev and pilRFwd and was ligated into EcoRI/SalI-digested pUC19, creating pUC19/*pilR*. An MluI site was introduced into pUC19/*pilR* using PCR primers pilRk/ofwd and pilRk/oRev, generating pUC19/*pilR*:MluI. The *aphA3* cassette was released from pFalcon2 and ligated into MluI-digested pUC19/*pilR*:MluI, creating pUC19/*pilR*:kan. The *K. kingae* *rpoN*:kan mutant was isolated in a screen of a mariner transposon library for nonadherent mutants (T. E. Kehl-Fie, unpublished data).

To create mutations in the promoter region of *pilA1*, the plasmid pPRBK was created (18), containing *pilA1* and the upstream *recJ* gene interrupted by the *aphA3* cassette. To replace the  $\sigma^{54}$ -12 binding region with nonhomologous sequence, the QuikChange II XL kit (Stratagene, La Jolla, CA) and PCR primers  $\Delta$ pilA-12 fwd and  $\Delta$ pilA-12 rev were used, creating plasmid pPRBK: $\Delta$ -12. Following transformation into *K. kingae*, the presence of the mutation was confirmed by DNA sequencing. To replace the ACA#1 and ACA#2 repetitive elements with random DNA, pPRBK and derivatives were amplified with primers  $\Delta$ ACA#1Fwd and  $\Delta$ ACA#1Rev or primers  $\Delta$ ACA#2Fwd and  $\Delta$ ACA#2Rev, producing linear fragments lacking the ACA repeats and containing either a BglII site (ACA#1) or a SpeI site (ACA#2). The products then were treated with DpnI to remove parental DNA and digested with either BglII (ACA#1) or SpeI (ACA#2). The digested fragments were circularized by ligation, creating pPRBK: $\Delta$ ACA#1, pPRBK: $\Delta$ ACA#2, and pPRBK: $\Delta$ ACA#1/#2.

After transformation into *K. kingae*, the  $\Delta$ ACA#1,  $\Delta$ ACA#2, and  $\Delta$ ACA#1/#2 mutations were confirmed by PCR and restriction digestion.

**Generation of anti-PilA1 antibody.** To purify PilA1 for antibody production, an N-terminal His affinity tag (HAT) fusion was created. A fragment containing *pilA1* lacking the coding region for the predicted signal sequence was amplified by PCR from *K. kingae* strain 269-492 using primers pilinF $\Delta$ SS and PilinR. The *pilA1* fragment was ligated into BamHI/EcoRI-digested pHAT10, creating pHAT10/*pilA1*: $\Delta$ SS. The HAT-PilA1 $\Delta$ SS fusion was purified by affinity chromatography using Talon resin (Clontech, Mountain View, CA) and then was resolved on an sodium dodecyl sulfate-polyacrylamide gel electrophoresis (SDS-PAGE) gel and excised. Antiserum GP65 was raised against HAT-PilA1 $\Delta$ SS in guinea pigs (Cocalico Biologicals, Reamstown, PA).

**Purification of type IV pili.** *K. kingae* pili were purified using a modification of the method described for the purification of *Eikenella corrodens* type IV pili (15). *K. kingae* strain 269-492 was grown for 18 h on 20 TSA II chocolate agar plates, and bacterial growth was scraped from the plates and suspended in 20 ml of 150 mM ethanalamine, pH 10.5 (EA buffer). Pili were sheared from the bacterial surface by subjecting the bacterial suspension to a handheld homogenizer for 2 min. To remove bacterial cells and debris, the suspension was centrifuged for 10 min at 10,000  $\times$  g and then for 30 min at 10,000  $\times$  g. The resulting supernatant was subjected to precipitation with 10% ammonium sulfate. The precipitated pili were resuspended in EA buffer to 1/10 of the original volume and then dialyzed overnight in 2 liters of EA buffer. The suspension again was subjected to precipitation with 10% ammonium sulfate, and the purified pili were examined by SDS-PAGE and by transmission electron microscopy.

TABLE 2. Primers used in this study

Name	Sequence <sup>a</sup>
PilSk/orev	GCATGGATCCGTCGTTGGCTTGGCGCATGGC
PilSk/ofwd	GCATGGATCCGCGAGCCTGCAACATTTGTTAGCCG
pilRRev	ACGTGTCGACCATATTGATTATTCATATTCAAGCGTTCC
pilRFwd	ACGTGAATTCATGACCAAAACACAGTTTGAATCGCC
pilRk/oFwd	ACGTACGCGTGCAGAAAGCGGTTCCGGTAAAGAG
pilRk/oRev	ACGTACGCGTCCGAAATATAGACAGGCACAACGGC
ΔpilA-12fwd	CAAATGGCATGCACCTAATAACCAAGTAAGGCAAGTAACACAGC
ΔpilA-12rev	GCTGTGTTACTTGCCTTACTTGGTATTAGAGTGCATGCCATTTG
ΔACA#1Fwd	ATCGTGAGATCTGTGACTGAGGTCTTGGCATGCACTCTGCTACCAAGTAAGGCAAGTAAC
ΔACA#1Rev	ATCGTGAGATCTGTGGATCGGCTAGAATGGTATTTTATTAACACTGCCTTTTTTTGTGTCAGTCGCAC
ΔACA#2Fwd	ATCGTGACTAGTGCACCTGCGTCCGGCGGCACGTTGATAAGCGAATTGCACCCAAATTG
ΔACA#1Rev	ATCGTGACTAGTGGTCTAGCGTCAAAAATAGCGCGTATTGAAGCCTGCAATCTG
SRLFwd	ATGCATGGTACCAGAAAAGCGAATTGAACGCGTTGC
SRLRev	ATGCATGTCGACGCTTTCACGTCTTCGGGCAGC
pilRDSBF	ATCGGGATCCTTTTTGATTTGGGTATAAAAAGGGTATGCCGTAGG
pilRDSBR	ATCGGGATCCTTTGGACAAAAGGGCAAAAAGCAGCC
PilinFΔSS	TACGGGATCCAGATTACACCAAACGTTACGCGTATCTGA
PilinR	TACGGAATCTTAGCCACCATTGGTAGCGGTAGTAGTGCC
pilA1pdr-6fam	FAM-CTCAGTCAAAGCACTTTTCACG
pilA1pdr	CTCAGTCAAAGCACTTTTCACG
pilA1pdf	GAGCAGGGAACAGATTGCAGG
Pilin Region Fwd	ACGTGAATTCAGCGCGTATGCCGTGCGAC
Pilin Region S3	GCCGATTATGATGCCGATGGC
<i>pilA1</i> RT-left	CAAACGTTACGCGTATCTG
<i>pilA1</i> RT-right	GGCCATGCATTGTTAGAAGC
<i>ftsZ</i> RT-left	CCAGAGCGAACC AAAAGTCTC
<i>ftsZ</i> RT-right	AAGCTATACTCGCCCTGCTG
<i>pillR</i> RT-left	GTTGATGTCCGCATTGTGTC
<i>pillR</i> RT-right	GGCGATAGAACAGGTCTTGG
<i>moxR</i> RT-left	TTTATGTTGGCGGACGAAAT
<i>moxR</i> RT-right	CGTCCACCGATACTTGACCT
<i>raiA</i> -right	GCGGTTACCTTGTGCGGTAGA
<i>raiA</i> -left	TCTTCCACTGCTTCAACGTG

<sup>a</sup> FAM, 6-carboxyfluorescein.

**Analysis of adherence, pilus expression, pilin production, and transcript levels.** The adherence of *K. kingae* to respiratory epithelial and synovial cells was assessed using quantitative adherence assays. Briefly, bacteria were incubated for 17 to 18 h overnight on chocolate agar and resuspended in brain heart infusion broth to an optical density at 600 nm of 0.8. Approximately  $6.5 \times 10^6$  CFU were inoculated onto fixed confluent cell monolayers in 24-well plates. Monolayers were fixed with 2% glutaraldehyde in 0.1 M sodium phosphate buffer, pH 7.4, for 2 h at 4°C with gentle rocking and then were washed three times with 1× Tris-buffered saline and replenished with fresh tissue culture media. Following the inoculation of bacteria, the 24-well plates were centrifuged for 5 min at 1,000 rpm and then were incubated for 25 min at 37°C. Monolayers were washed four times with phosphate-buffered saline (PBS) to remove nonadherent bacteria and then treated with 1× trypsin-EDTA (Sigma-Aldrich, St. Louis, MO) for 20 min at 37°C to release adherent bacteria. Appropriate dilutions were prepared and spread on agar plates, and the percent adherence was determined by dividing the number of adherent CFU by the number of CFU in the inoculum. Each sample was assayed in triplicate.

To assess PilA1 production, *K. kingae* strains were grown for 17 to 18 h on chocolate agar and resuspended to an optical density at 600 nm of 0.8 and then analyzed by Western blotting using antiserum GP65. To confirm equal loadings and uniform transfer, all membranes were stained with Ponceau S prior to Western blotting. The surface expression of pili was assessed by negative staining transmission electron microscopy as described previously (19), with the following modifications. Bacteria were resuspended in 0.2 M ammonium acetate, pH 7.4, instead of PBS, and the grids were not washed before examination using a Philips CM-12 electron microscope (FEI, Hillsboro, OR).

To perform quantitative real-time PCR, RNA and cDNA were prepared. Briefly, RNA was extracted using TRIreagent (Sigma, St. Louis, MO) and the RNeasy minikit following the lipid-rich tissue protocol (Qiagen, Valencia, CA). Residual DNA was removed with RQ1 DNase (Fisher Scientific, Pittsburgh, PA), which was inactivated prior to generating cDNA with random hexamers and Superscript II (Invitrogen, Carlsbad, CA). The primer sets used for quantitative real-time PCR are listed in Table 2.

To perform primer runoff analysis, cDNA was created using the primer pilA1pdr-6fam, which anneals at the 5' end of *pilA1*, and either Superscript II (Invitrogen, Carlsbad, CA) or Transcriptor (Roche Applied Sciences, Indianapolis, IN). Samples were electrophoresed on an Applied Biosystems 3100 genetic analyzer and analyzed using Applied Biosystems Genescan v3.7.1 software (Applied Biosystems, Foster City, CA).

**Gel shift.** To assess the binding of PilR to the *pilA1* promoter, we employed a maltose-binding protein–PilR (MBP–PilR) fusion protein and an ~500-bp fragment containing the *pilA1* promoter. To generate the MBP–PilR protein, the *pilR* gene was amplified from strain 269-492 using the primers pilRRev and pilRFwd and was ligated into EcoRI/SalI-digested pMalC2 (New England Biolabs, Ipswich, MA), creating pMalC2:*pilR*. To express MBP–PilR or MBP, overnight cultures were back diluted 1/50 into fresh LB and grown at 37°C for 2 h and then induced with 0.1 μM isopropyl-β-D-thiogalactopyranoside (IPTG) for an additional 3 h. Bacteria were harvested by centrifugation, and the pellet then was resuspended in suspension buffer (20 mM HEPES, pH 7.5, 0.1 M NaCl, 1 mM EDTA) and lysed via sonication. Following sonication, the lysate was clarified by centrifugation and then incubated overnight at 4°C with amylose resin. The resin was washed four times with 10 bed volumes of suspension buffer. Protein was eluted from the resin in suspension buffer supplemented with 10 mM maltose. The *pilA1* promoter was amplified from either pPRBK or pPRBK containing the ACA mutations using the primers pilA1pdf and either pilA1pdr or pilA1pdr-6fam. A nonspecific competitor fragment was amplified using the primers Pilin Region Fwd and Pilin Region S3. Binding reactions were performed as described previously (28), with the exception that the volume was increased to 30 μl. Samples were separated on a 4% native polyacrylamide gel prepared with 0.5× Tris-borate-EDTA (TBE) and were visualized using a Typhoon 9410 (GE Bioscience, Piscataway, NJ).

**Transmission electron microscopy.** Piliated bacteria and dilutions of purified pili were examined by negative staining transmission electron microscopy using uranyl acetate.

**MS analysis.** The gel slice corresponding to purified pili was subjected to in-gel trypsin digestion (the detailed protocol is at <http://www.genome.duke.edu/cores>



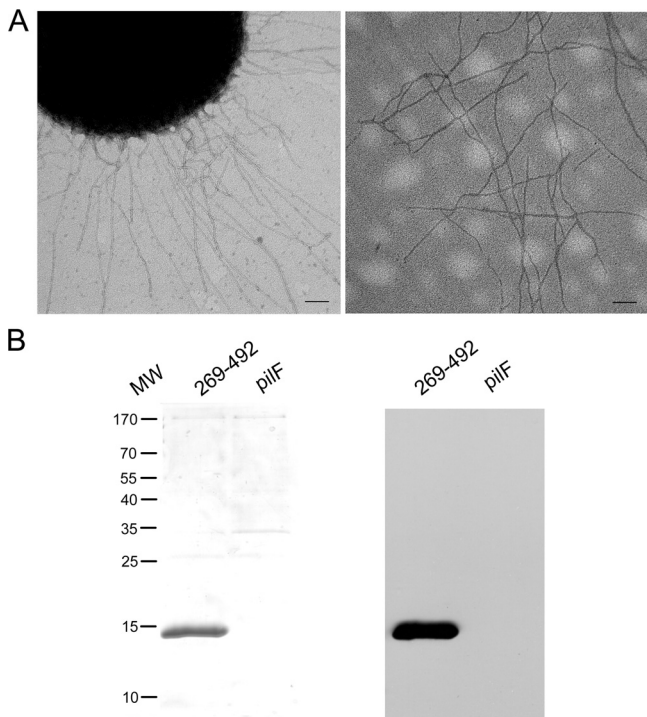

FIG. 1. Evidence that *K. kingae* surface fibers are type IV pili. (A) Fibers on the surface of *K. kingae* strain 269-492 (left) and the preparation of purified pili (right) after staining with uranyl acetate and examining by transmission electron microscopy. Scale bars represent 100 nm. (B) Coomassie blue-stained SDS-PAGE gel of purified pili (left) and a Western blot of purified pili (right) using the antiserum GP65 directed against PilA. Strain *K. kingae* 269-492 *pilF* (*pilF*) is unable to assemble pili and served as a control. MW, molecular size in kilodaltons.

/proteomics/sample-preparation/), followed by liquid chromatography-mass spectrometry-mass spectrometry (LC-MS/MS) analysis using a nanoAcquity liquid chromatograph (Waters Corp) coupled to an LTQ-Orbitrap XL (Thermo Scientific). The top three most intense multiply charged ions were interrogated by tandem MS with product ion detection in the Orbitrap. Raw data were processed using Mascot Distiller v2.0 and were searched using the Mascot v2.2 search engine against *K. kingae* protein sequences, with 10 ppm precursor and a 0.02-Da product ion tolerance.

**Nucleotide sequence accession numbers.** The *pilSR* and *rpoN* loci were deposited in GenBank under accession numbers EU930332 and EU930331, respectively. The accession numbers for *Pseudomonas aeruginosa* PilR, PilS, and  $\sigma^{54}$  are AAP81269, NP\_253236.1, and NP\_253152.1, respectively.

RESULTS

**Confirmation that *Kingella kingae* surface fibers are type IV pili.** In initial experiments, we set out to confirm that *K. kingae* surface fibers are type IV pili and contain PilA1. Fibers were sheared from the surface of *K. kingae* strain 269-492 and then were precipitated with ammonium sulfate. *K. kingae* strain 269-492 *pilF* was used as a control and was subjected to the same protocol, taking advantage of the fact that this strain makes PilA1 but is unable to assemble surface fibers (PilA1 accumulates in the cell) (18). As shown in Fig. 1A, the examination of the purified material from strain 269-492 by negative staining transmission electron microscopy revealed abundant fibers that were identical to the fibers on the surface of whole bacteria. As shown in Fig. 1B, the examination of the purified fibers by SDS-PAGE revealed a major band ~15 kDa in size, in agreement with the predicted molecular mass of PilA1, and examination by Western analysis with antiserum GP65 directed against PilA1 demonstrated strong reactivity with the ~15-kDa band. The 15-kDa band was excised from the gel and subjected to LC-MS/MS, revealing the sequence for PilA1 and confirming that the surface fibers are type IV pili.

**$\sigma^{54}$  regulates *pilA1* transcription.** To develop a better understanding of the regulation of *K. kingae* type IV pili, we began by analyzing the promoter region of *pilA1* (the gene encoding the major pilus subunit) (18) (Fig. 2). Western blotting and quantitative real-time PCR demonstrated that spreading/corroding and nonspreading/noncorroding colony types express *pilA1* at different levels (Fig. 3A and B). The sequencing of the region between *recJ* and *pilA1* revealed no differences between a spontaneous stable spreading/corroding colony variant of *K. kingae* strain 269-492 (strain KK03) and a spontaneous stable nonspreading/noncorroding colony variant of *K. kingae* strain 269-492 (strain KK01) (19), arguing that the *pilA1* promoter region does not differ between spreading/corroding and nonspreading/noncorroding colony types. Primer runoff analysis indicated that the *pilA1* transcriptional start site is 88 bp upstream of the putative *pilA1* start codon in strains 269-492, KK03, and KK01 (Fig. 2). These data suggest that the conversion between spreading/corroding and nonspreading/noncorroding colony types is mediated by changes outside the *pilA1* promoter region.

The examination of the *pilA1* promoter region revealed the minimal consensus sequence for the alternative sigma factor

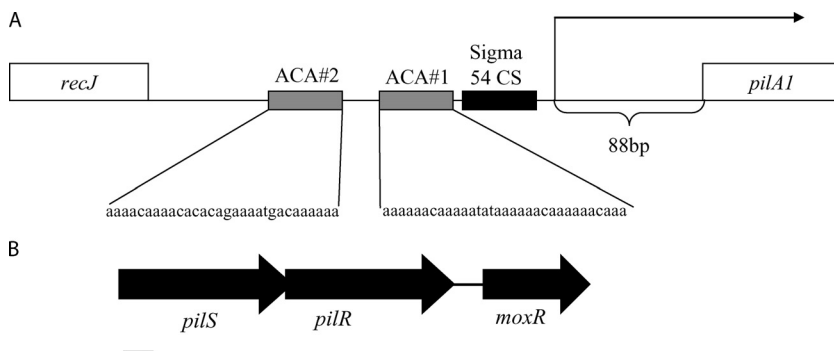

FIG. 2. Diagram of the *pilA1* promoter region and the PilS and PilR region. (A) *pilA1* promoter region and the locations of the transcriptional start site,  $\sigma^{54}$  binding region, and ACA#1 and ACA#2 repeats. (B) *pilS/pilR* locus. The bar equals 200 bp.

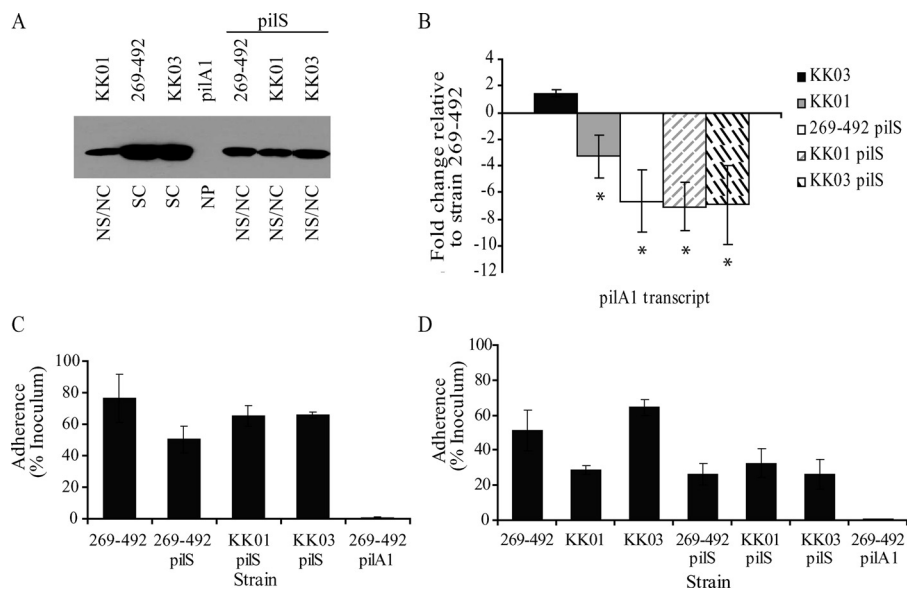

FIG. 3. Contribution of PilS to *K. kingae* PilA1 expression and adherence. (A) Western blot for PilA1 in *K. kingae* strains KK01, 269-492, KK03, 269-492 *pilA1*, 269-492 *pilS*, KK01 *pilS*, and KK03 *pilS*. NS/NC, nonspreading/noncorroding; SC, spreading/corroding; NP, nonpiliated. (B) Levels of *pilA1* transcript measured by quantitative real-time PCR in *K. kingae* strains KK03, KK01, 269-492 *pilS*, KK01 *pilS*, and KK03 *pilS* relative to that of strain 269-492 (\*,  $P \leq 0.05$  using the unpaired *t* test compared to results for the parental strain). (C) Adherence to Chang respiratory epithelial cells by *K. kingae* strains 269-492, 269-492 *pilS*, KK01 *pilS*, KK03 *pilS*, and 269-492 *pilA1*. (D) Adherence to Hig-82 synovial cells by *K. kingae* strains 269-492, KK01, KK03, 269-492 *pilS*, KK01 *pilS*, KK03 *pilS*, and 269-492 *pilA1*.

$\sigma^{54}$  (CAAATGGCATGCACTCTGCTACCAAGTA) (underlining indicates the conserved -12 and -24 bases) (1) upstream of the transcriptional start site (Fig. 1), and a review of the *K. kingae* genome (Kehl-Fie et al., unpublished) identified a gene that encodes a homolog of  $\sigma^{54}$ , a gene that we have designated *rpoN* by analogy to other species. *K. kingae*  $\sigma^{54}$  is 45% similar and 30% identical to  $\sigma^{54}$  from *Pseudomonas aeruginosa*. To assess whether *rpoN* contributes to *K. kingae* type IV pilus expression or is a pseudogene, as it is in *Neisseria* species (20), we disrupted *rpoN* in strain 269-492 and assessed the resulting mutant for pilus expression and adherence. The examination of a whole-cell lysate of the *rpoN* mutant by Western blotting revealed no PilA1 (Fig. 4A). The colony morphology of the *rpoN* mutant changed from the spreading/corroding morphology of the parent strain to the morphology observed with nonpiliated clinical isolates (data not shown). Consistent with this observation, the *rpoN* mutant had no pili when examined by negative staining electron microscopy (data not shown) and was nonadherent in assays with Chang cells (Fig. 4B), similar to *K. kingae* strain 269-492 *pilA1*, a nonpiliated control (18). The further analysis of the *rpoN* mutant revealed that the level of *pilA1* transcript was approximately 1/3,000 that of the parent strain (Fig. 4C). As a control, we performed quantitative real-time PCR on the gene downstream of *rpoN* and found no effect of the insertion in *rpoN*, arguing against a polar effect of the insertion (data not shown). Taken together, these data suggest that *pilA1* expression is regulated by  $\sigma^{54}$ .

To assess whether  $\sigma^{54}$  acts directly at the *pilA1* promoter, the  $\sigma^{54}$  minimal consensus sequence was mutated by converting the GC nucleotides at the -12 position to AA, generating strain  $\Delta$ -12. The characterization of the  $\Delta$ -12 mutant revealed no detectable PilA1 by Western blotting (Fig. 4A), no visible pili by electron microscopy (data not shown), and no

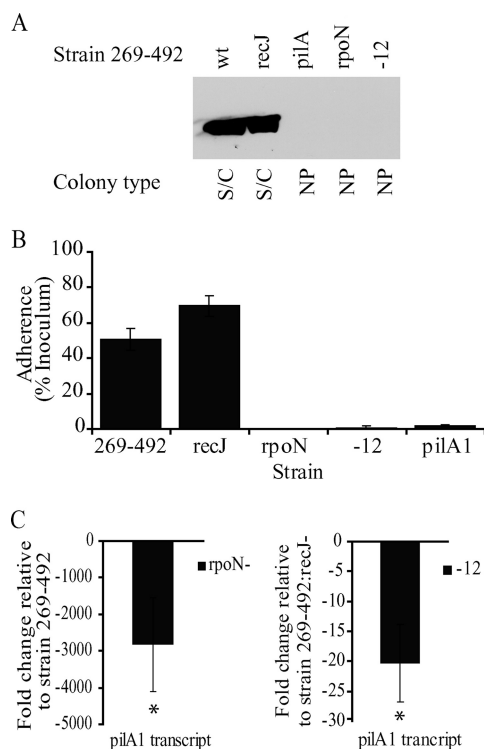

FIG. 4. Contribution of  $\sigma^{54}$  to *K. kingae* PilA1 expression and adherence. (A) Western blot for PilA1 in *K. kingae* strains 269-492, 269-492 *recJ* (*recJ*), 269-492 *pilA1* (*pilA1*), 269-492 *rpoN* (*rpoN*), and 269-492  $\Delta$ -12 ( $\Delta$ -12). wt, wild type; S/C, spreading/corroding; NP, nonpiliated. (B) Adherence to Chang respiratory epithelial cells by *K. kingae* strains 269-492, 269-492 *recJ*, 269-492 *rpoN*, 269-492  $\Delta$ -12, and 269-492 *pilA1* (*pilA1*). (C) Levels of *pilA1* transcript measured by quantitative real-time PCR in *K. kingae* strains 269-492 *rpoN* and 269-492  $\Delta$ -12 relative to those of strains 269-492 and 269-492 *recJ*, respectively (\*,  $P \leq 0.05$  using the unpaired *t* test compared to results for the parental strain).

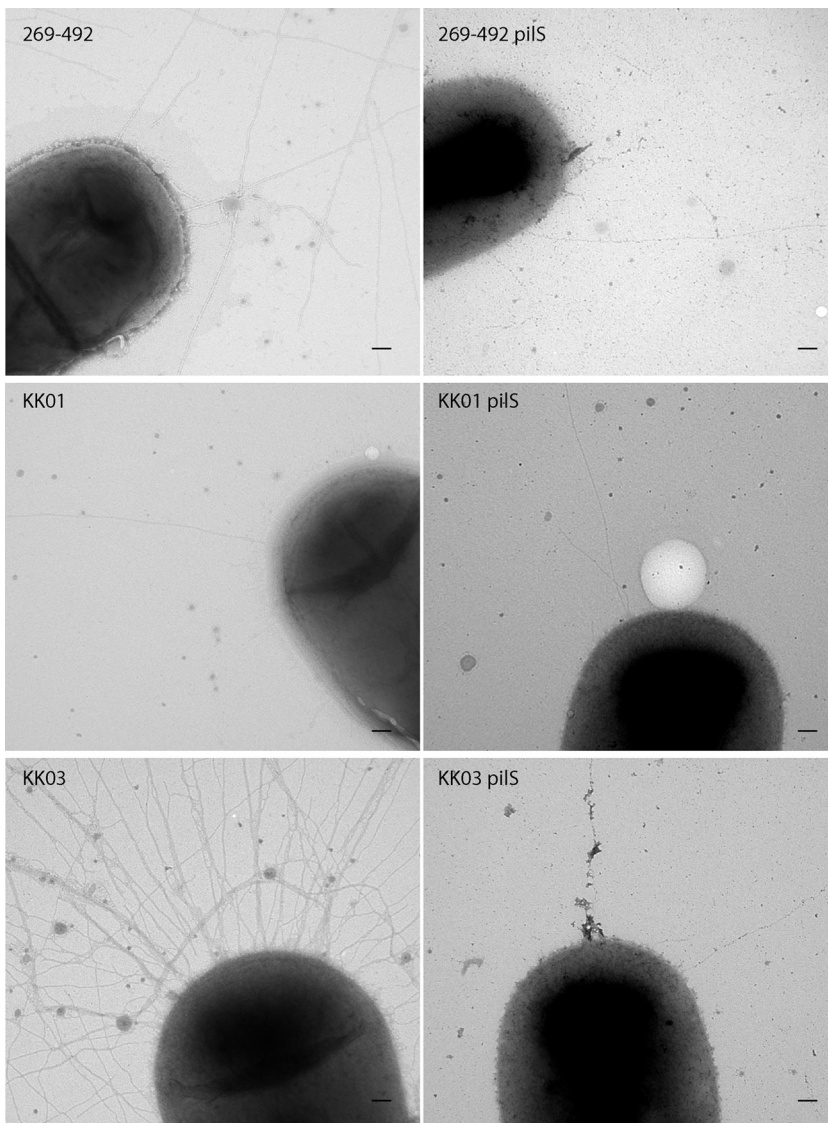

FIG. 5. Contribution of PilS to *K. kingae* piliation. Negative staining transmission electron microscopy of *K. kingae* strains 269-492, KK01, KK03, 269-492 *pilS*, KK01 *pilS*, and KK03 *pilS*. The scale bar represents 100 nM.

adherence to Chang cells (Fig. 4B). As shown in Fig. 4C, the  $\Delta-12$  mutant also had reduced levels of *pilA1* transcript. These data suggest that  $\sigma^{54}$  acts directly on the *pilA1* promoter.

**PilS and PilR regulate *pilA1* transcription.** In other organisms that express type IV pili and utilize  $\sigma^{54}$  to regulate pilin expression, regulation also requires a two-component regulatory system consisting of PilS, the sensor kinase, and PilR, the response regulator (14, 16, 22, 28, 36). Along these lines, the examination of the *K. kingae* genome identified tandem genes encoding proteins with homology to PilS and PilR (Fig. 2). *K. kingae* PilS is 42% similar and 26% identical to PilS from *Pseudomonas aeruginosa* and contains a conserved histidine kinase domain (residues 321 to 388) and a conserved ATP binding domain (residues 435 to 535). Interestingly, while the *P. aeruginosa* PilR protein and most PilR homologs are approximately 50 kDa in size, the *K. kingae* PilR protein has a predicted molecular mass of 61 kDa. The difference in molec-

ular mass is due to an insertion in *K. kingae* PilR (residues 138 to 228) between the conserved receiver domain (residues 11 to 123, including a predicted phosphorylation site) and the conserved  $\sigma^{54}$ -interacting domain (residues 231 to 399). Excluding the insertion between the receiver domain and the  $\sigma^{54}$ -interacting domain, *K. kingae* PilR and *P. aeruginosa* PilR are 74% similar and 44% identical. To assess the roles of the PilS and PilR homologs in *K. kingae* pilus expression, we disrupted *pilS* and *pilR* in *K. kingae* strains 269-492, KK03, and KK01. Real-time quantitative PCR confirmed that the *pilS* disruption did not affect *pilR* or *moxR* (downstream of *pilR*) transcript levels, and that the *pilR* disruption did not affect *moxR* transcript levels (data not shown).

As shown in Fig. 3A, the examination of the *pilS* mutants by Western blotting revealed a decrease in the levels of PilA1 in the 269-492 and the KK03 derivatives comparable to the level of PilA1 in KK01. When assessed for adherence, the *pilS* mu-



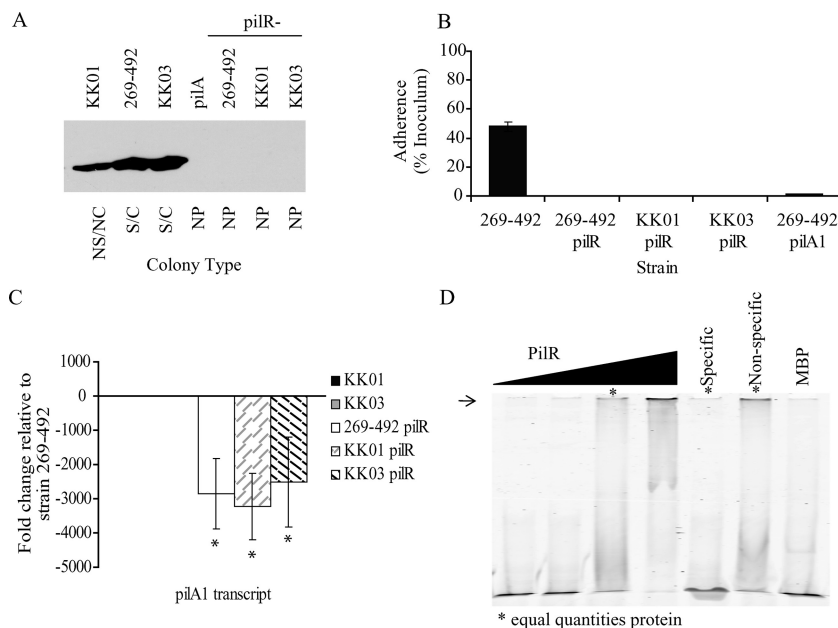

FIG. 6. Contribution of PilR to *K. kingae* PilA1 expression and adherence. (A) Western blot for PilA1 in *K. kingae* strains KK01, 269-492, KK03, 269-492 *pilA1* (*pilA1*), 269-492 *pilR*, KK01 *pilR*, and KK03 *pilR*. NS/NC, nonspreading/noncorroding; S/C, spreading/corroding; NP, nonpiliated. (B) Adherence to Chang respiratory epithelial cells by *K. kingae* strains 269-492, 269-492 *pilR*, KK01 *pilR*, KK03 *pilR*, and 269-492 *pilA1*. (C) Levels of *pilA1* transcript measured by quantitative real-time PCR in *K. kingae* strains KK01, KK03, 269-492 *pilR*, KK01 *pilR*, and KK03 *pilR* relative to those of strain 269-492 (\*,  $P \leq 0.05$  using the unpaired *t* test compared to results for parental strain). (D) Gel shifts with MBP-PilR. Lanes 1 to 4 contain increasing quantities of MBP-PilR (0, 0.3, 3, and 30  $\mu$ g) incubated with 50 ng of labeled probe. Lanes 5 and 6 show 3  $\mu$ g of MBP-PilR incubated with 50 ng of labeled probe and either 400 $\times$  specific competitor (specific) or 400 $\times$  nonspecific competitor (nonspecific). Lane 7 shows 30  $\mu$ g of MPB with 50 ng of labeled probe. The arrow highlights the shifted DNA band at the top of the gel, indicating interaction with PilR.

tants adhered to Chang respiratory epithelial cells at levels comparable to those of wild-type strain 269-492 (Fig. 3C). Previous work established that the level of adherence to synovial cells correlates with the density of piliation (18). To assess whether the reduction in PilA1 correlated with a reduction in piliation, we examined the *pilS* mutants for adherence to Hig-82 synovial cells. As shown in Fig. 3D, adherence by the three *pilS* mutants was comparable to adherence by KK01 (a nonspreading/noncorroding colony type). Consistent with this result, when the three *pilS* mutants were examined by electron microscopy, all three had levels of pili that were comparable to the levels in strain KK01 (Fig. 5). Interestingly, the mutation of *pilS* in strains 269-492 and KK03 also resulted in a shift from a spreading/corroding colony type to a nonspreading/noncorroding colony type (data not shown). As shown in Fig. 3B, all three *pilS* mutants had levels of *pilA1* transcript that were slightly lower than the levels in KK01. These data suggest that PilS enhances PilA1 expression but is not absolutely required.

As shown in Fig. 6A, the examination of the *pilR* mutants by Western blotting revealed no detectable PilA1. In all three strain backgrounds, the colony morphology of the *pilR* mutants shifted to the morphology observed with nonpiliated clinical isolates. Consistent with these results, the *pilR* mutants were nonpiliated when examined by negative staining electron microscopy (data not shown) and were nonadherent in assays with Chang cells (Fig. 6B). Further analysis revealed that the level of *pilA1* transcript was approximately 1/3,000 that of strain 269-492 in all three mutants (Fig. 6C). Taken together, these data suggest that PilR is required for *pilA1* transcription.

To assess if PilR acts directly on the *pilA1* promoter, PilR was expressed as an MBP fusion protein, and gel shift assays with the *pilA1* promoter region were performed. As shown in Fig. 6D, PilR retarded the migration of an ~500-bp fragment containing the intergenic region between *pilA1* and *recJ*, supporting the conclusion that PilR acts at the *pilA1* promoter and regulates *pilA1* transcription.

**Two repetitive elements facilitate binding of PilR to the *pilA1* promoter.** Based on work in *P. aeruginosa*, a 5'-(N)<sub>4-6</sub>C/GTGTC-3 motif has been suggested to be a PilR binding sequence. This motif also is present upstream of the major pilin gene in other organisms that have been suggested to regulate pilus expression using the PilS/PilR two-component response regulator (11, 17). Interestingly, the examination of the *K. kingae pilA1* promoter region revealed no evidence of the 5'-(N)<sub>4-6</sub>C/GTGTC-3 motif. However, as shown in Fig. 2, the *pilA1* upstream sequence contains repetitive elements that we have designated ACA#1 and ACA#2 and are located 117 and 228 bp upstream of the predicted *pilA1* start site. These repetitive elements contain three to five degenerate repetitive units consisting of 5'-(A)<sub>1-6</sub>C(A)<sub>1-6</sub>-3' and are upstream of the  $\sigma^{54}$  DNA binding region. To assess whether these repetitive units contribute to *pilA1* transcription, we replaced them individually and in combination with random DNA in *K. kingae* strains 269-492, KK01, and KK03.

When the ACA mutants were examined by Western blotting, all were found to have substantially decreased levels of PilA1 (Fig. 7A). As shown in Fig. 7B, in strains 269-492 and KK01, the loss of either ACA#1 or ACA#2 resulted in a



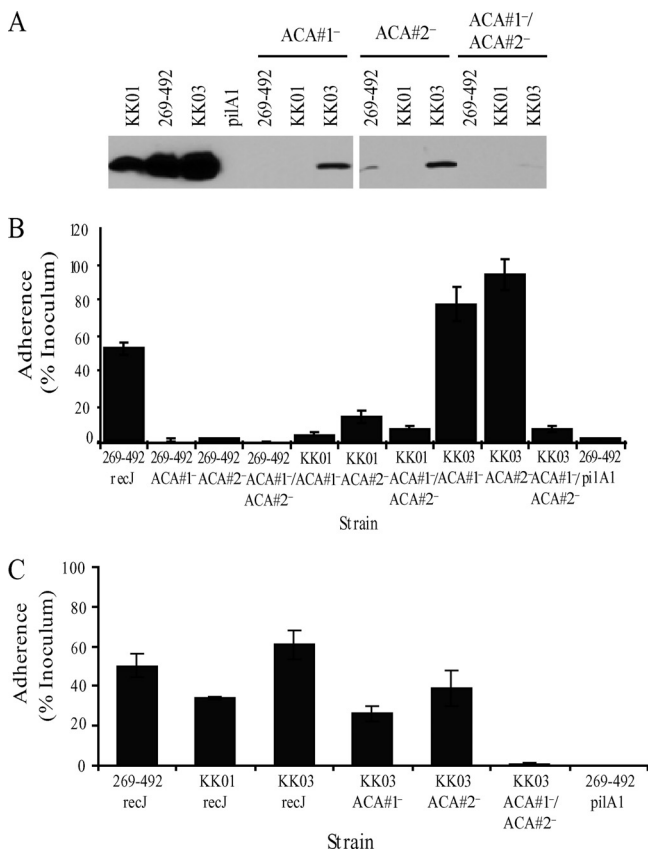

FIG. 7. Contribution of ACA repetitive elements to *K. kingae* adherence. (A) Western blot for PilA1 in *K. kingae* strains KK01, 269-492, KK03, 269-492 *pilA1* (*pilA1*), 269-492 ACA#1<sup>-</sup>, KK01 ACA#1<sup>-</sup>, KK03 ACA#1<sup>-</sup>, 269-492 ACA#2<sup>-</sup>, KK01 ACA#2<sup>-</sup>, KK03 ACA#2<sup>-</sup>, 269-492 ACA#1<sup>-</sup>/ACA#2<sup>-</sup>, KK01 ACA#1<sup>-</sup>/ACA#2<sup>-</sup>, and KK03 ACA#1<sup>-</sup>/ACA#2<sup>-</sup>. (B) Adherence to Chang respiratory epithelial cells by *K. kingae* strains 269-492 *recJ*, 269-492 ACA#1<sup>-</sup>, 269-492 ACA#2<sup>-</sup>, 269-492 ACA#1<sup>-</sup>/ACA#2<sup>-</sup>, KK01 ACA#1<sup>-</sup>, KK01 ACA#2<sup>-</sup>, KK01 ACA#1<sup>-</sup>/ACA#2<sup>-</sup>, KK03 ACA#1<sup>-</sup>, KK03 ACA#2<sup>-</sup>, KK03 ACA#1<sup>-</sup>/ACA#2<sup>-</sup>, and 269-492 *pilA1*. (C) Adherence to Hig-82 synovial cells by *K. kingae* strains 269-492 *recJ*, KK01 *recJ*, KK03 *recJ*, KK03 ACA#1<sup>-</sup>, KK03 ACA#2<sup>-</sup>, KK03 ACA#1<sup>-</sup>/ACA#2<sup>-</sup>, and 269-492 *pilA1*.

substantial reduction in adherence to Chang epithelial cells. In contrast, in strain KK03 a reduction in adherence was observed only when both the ACA#1 and the ACA#2 repeats were replaced. To assess whether the decreased level of PilA1 correlated with a decrease in piliation in the KK03 ACA#1 and ACA#2 single mutants, we examined these mutants for adherence to Hig-82 cells and by electron microscopy. As shown in Fig. 7C, the KK03 ACA#1 and ACA#2 single mutants adhered at levels comparable to adherence by KK01 and decreased compared to adherence by the KK03 parent, suggesting a reduction in piliation. Consistent with the diminished adherence to Hig-82 cells, the examination of the KK03 ACA single mutants by electron microscopy revealed a reduction in the number of pili to levels slightly lower than those in strain KK01 (data not shown). The examination of the 269-492 and KK01 ACA#1 and ACA#2 single mutants and the 269-492, KK01, and KK03 ACA#1/ACA#2 double mutants revealed a majority of bacteria with no pili and rare bacteria with short pili (data

not shown), in agreement with the low levels of PilA1 that were detected by Western blotting. The analysis of *pilA1* transcript levels revealed decreased *pilA1* transcript in all three KK03 ACA mutants, with the greatest decrease observed in the KK03 ACA double mutant (Fig. 8A). Similar results were obtained when the 269-492 and KK01 ACA mutants were examined for the level of *pilA1* transcript (data not shown). These data suggest that both ACA repeats contribute to *pilA1* transcription.

Given the absence of the conserved PilR DNA binding sequence found in *P. aeruginosa* and other species upstream of *pilA1*, we examined whether the ACA repeats contribute to the binding of PilR to the *pilA1* promoter. To perform this analysis, a 500-bp fragment corresponding to the native *pilA1* promoter lacking ACA#1, ACA#2, or both ACA#1 and ACA#2 repetitive elements was amplified and assessed by gel shift. As shown in Fig. 8B, the loss of either ACA element resulted in a decreased affinity of PilR for the *pilA1* promoter. Interestingly, the loss of the ACA#1 repetitive element resulted in only a small decrease in affinity. These results suggest that the ACA repetitive elements contribute to the expression of PilA1 by promoting PilR binding to the *pilA1* promoter.

DISCUSSION

*K. kingae* is being recognized increasingly as a common cause of septic arthritis, bacteremia, and osteomyelitis in young children. Previous work demonstrated that type IV pili are essential for *K. kingae* adherence to respiratory epithelial cells (16) and generally are absent from isolates recovered from joint fluid or bone samples (Kehl-Fie et al., unpublished). To develop a better understanding of the clinically relevant transition between piliated and nonpiliated organisms, we undertook studies to identify the factors controlling pilus expression. Initial observations demonstrated that the highly piliated spreading/corroding colony type expresses PilA1 at higher levels than the sparsely piliated nonspreading/noncorroding colony type. Additional experiments established that the variation in piliation between spreading/corroding and nonspreading/noncorroding colony variants (KK01 and KK03, respectively) is not due to changes in the intergenic region between *pilA1* and *recJ*. Further analysis revealed that PilA1 expression is regulated by the alternative sigma factor  $\sigma^{54}$  and the PilS/PilR two-component regulatory system, with both  $\sigma^{54}$  and PilR acting at the *pilA1* promoter and being necessary for wild-type levels of *pilA1* transcript. The involvement of  $\sigma^{54}$  and the PilS/PilR two-component system in *K. kingae* type IV pilus expression suggests that both genetic elements and environmental signals influence *K. kingae* piliation.

The analysis of the *K. kingae* genome identified genes encoding homologs of  $\sigma^{54}$ , PilS, and PilR, which have been shown to be essential for type IV pilus expression in *P. aeruginosa* and a variety of other organisms (14, 16, 22, 28, 36). In contrast to *P. aeruginosa*, *Neisseria gonorrhoeae* and *Neisseria meningitidis* contain only remnants of the *rpoN*, *pilS*, and *pilR* genes and use  $\sigma^{70}$  to drive pilus expression (4, 9, 20). In our studies, we found that the disruption of *rpoN* and *pilR* in *K. kingae* resulted in the complete loss of PilA1 production, piliation, and adherence, indicating that  $\sigma^{54}$  and the PilS/PilR two-component regulatory system are required for *K. kingae* pilus expression. In

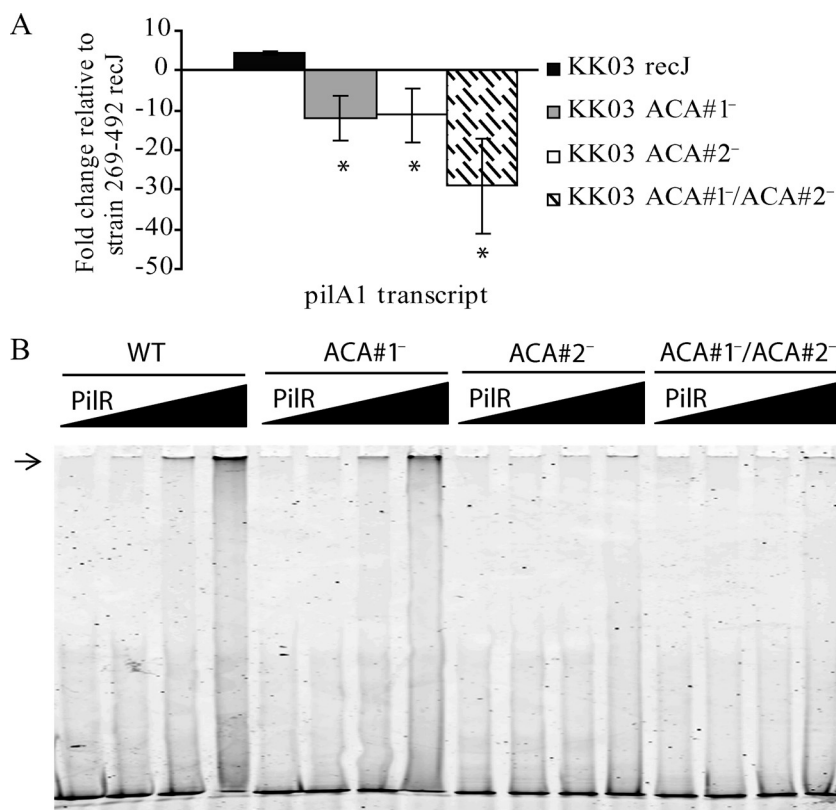

FIG. 8. Contribution of ACA repetitive elements to *K. kingae* pilus expression. (A) Levels of *pilA1* transcript measured by quantitative real-time PCR in *K. kingae* strains KK03 *recJ*, KK03 ACA#1<sup>-</sup>, KK03 ACA#2<sup>-</sup>, and KK03 ACA#1<sup>-</sup>/ACA#2<sup>-</sup> relative to the levels for strain 269-492 *recJ* (\*,  $P \leq 0.05$  using the unpaired *t* test compared to results for the parental strain). (B) Gel shifts with increasing concentrations of MBP-PilR (0, 0.03, 0.3, and 3  $\mu\text{g}$ ) with 50 ng of labeled wild-type probe (WT) or probe lacking repetitive element ACA#1, repetitive element ACA#2, or both ACA#1 and ACA#2. Lanes 1 to 4 contain wild-type probe. Lanes 5 to 8 contain probe lacking the ACA#1 element. Lanes 9 to 12 contain probe lacking the ACA#2 element. Lanes 13 to 16 contain probe lacking both the ACA#1 and ACA#2 elements. The arrow highlights the shifted DNA band at the top of the gel, indicating interaction with PilR.

addition, disruptions of *rpoN* and *pilR* resulted in a colony morphology that was similar to the colony morphology of non-piliated clinical isolates, regardless of the colony morphology of the parental strain. Primer runoff analysis demonstrated that spreading/corroding and nonspreading/noncorroding colony types have the same transcriptional start site located 88 bp upstream of the predicted *pilA1* start codon. The mutation of a conserved minimal  $\sigma^{54}$  DNA binding element (1) resulted in a reduction in PilA1 levels, the loss of piliation, and the loss of adherence, suggesting that  $\sigma^{54}$  acts directly at the *pilA1* promoter.

The examination of the *pilA1* promoter revealed no evidence of the motif corresponding to the reported DNA binding domain of *P. aeruginosa* PilR (17). Instead, the *pilA1* promoter contains two ACA repetitive elements that are necessary for the efficient binding of PilR and the expression of pili. While the mutation of both ACA repetitive elements resulted in undetectable levels of PilA1 in the 269-492 and KK01 backgrounds and barely detectable levels in the KK03 background, as well as substantially reduced *pilA1* transcript levels in all three backgrounds, the reduction in *pilA1* transcript was not as great as that observed in the *pilR* mutants. Despite the fact that our gel shift assays demonstrated no clear PilR binding to the *pilA1* promoter lacking both ACA#1 and ACA#2, we specu-

late that there is residual PilR binding to the mutated *pilA1* promoter in whole bacteria. Interestingly, 27 additional ACA repetitive elements are scattered throughout the genome, suggesting that the *K. kingae* PilS/PilR system regulates additional factors involved in pathogenesis. Of note, the *Dichelobacter nodosus* PilS/PilR two-component system regulates type IV pili and several non-pilus genes, including an RTX-like gene (28).

In contrast to our findings with  $\sigma^{54}$  and PilR, the loss of PilS resulted in only a partial reduction in *pilA1* transcript level, piliation, and adherence. Interestingly, when the *pilS* mutation was introduced into strain 269-492 (a strain with an intermediate number of pili), strain KK03 (an isogenic variant with a high number of pili), and strain KK01 (an isogenic variant with a low number of pili), the level of *pilA1* transcript was reduced to the same level in all cases. In strains 269-492 and KK03, the *pilS* mutation resulted in a shift from spreading/corroding colonies to nonspreading/noncorroding colonies. These data suggest that spontaneous mutation in *pilS* is one mechanism that is responsible for the switch from spreading/corroding colonies to nonspreading/noncorroding colonies.

The transcription of *pilA1* when PilS is lacking raises several interesting questions regarding the activity of PilR and suggests similarities to other systems. In *Helicobacter pylori*, the response regulator Hp166 has been shown to have activity in

the absence of the cognate sensor kinase Hp165. The binding of Hp166 to essential genes in the absence of Hp165 and canonical phosphorylation has been suggested to be due to a higher affinity of Hp166 for promoters in front of essential genes than nonessential genes, allowing transcription in the absence of phosphorylation (2, 6, 7, 26, 30). In *P. aeruginosa*, the AlgR response regulator is capable of activating a subset of the genes it regulates in the absence of its cognate sensor, FimS, and canonical phosphorylation (24, 34). Similarly, the *P. aeruginosa* AlgB response regulator has been shown to have activity in the absence of phosphorylation (21, 24, 35). While *K. kingae* PilR clearly retains activity in the absence of PilS, it is not clear whether this activity is phosphorylation dependent or phosphorylation independent. If the residual PilR activity is phosphorylation dependent, another histidine kinase could be serving as a phosphodonor (31, 33), or PilR could be phosphorylated by a high-energy small molecule, such as acetyl phosphate (23, 25). If the residual *K. kingae* PilR activity is phosphorylation independent, the mechanism responsible for the activity is less apparent. Regardless of whether the residual activity of *K. kingae* PilR in the absence of PilS is phosphorylation dependent or phosphorylation independent, it is intriguing to speculate that the 91-amino-acid insertion between the receiver domain and the  $\sigma^{54}$  binding domain is responsible for the residual activity.

In this study, we demonstrate that the expression of *K. kingae pilA1* is regulated by  $\sigma^{54}$  and a two-component response regulator. Our results indicate that *K. kingae* type IV pilus expression is complex and multilayered and involves both genetic and biochemical components, suggesting that *K. kingae* combines aspects of regulation from both *P. aeruginosa* and the pathogenic *Neisseria* species. The further study of *K. kingae* type IV pilus regulation provides an opportunity to develop a better understanding of a presumed key virulence factor and may lead to the discovery of additional factors that are involved in pathogenesis. Furthermore, the continued study of *K. kingae* PilS and PilR may provide insights into the growing number of species known to contain two-component response regulators with atypical activity, including *H. pylori* and *P. aeruginosa*.

#### ACKNOWLEDGMENTS

This work was supported by NIH training grant T32-GM07067 to T.E.K.-F.

We thank the Duke Proteomics Core Facility and staff for assistance with mass spectrometry.

#### REFERENCES

- Barrios, H., B. Valderrama, and E. Morett. 1999. Compilation and analysis of  $\sigma^{54}$ -dependent promoter sequences. *Nucleic Acids Res.* **27**:4305–4313.
- Beier, D., and R. Frank. 2000. Molecular characterization of two-component systems of *Helicobacter pylori*. *J. Bacteriol.* **182**:2068–2076.
- Boyd, J. M., T. Koga, and S. Lory. 1994. Identification and characterization of PilS, an essential regulator of pilin expression in *Pseudomonas aeruginosa*. *Mol. Gen. Genet.* **243**:565–574.
- Carrick, C. S., J. A. Fyfe, and J. K. Davies. 2000. The genome of *Neisseria gonorrhoeae* retains the remnants of a two-component regulatory system that once controlled piliation. *FEMS Microbiol. Lett.* **186**:197–201.
- Chometon, S., Y. Benito, M. Chaker, S. Boisset, C. Ploton, J. Berard, F. Vandenesch, and A. M. Freydiere. 2007. Specific real-time polymerase chain reaction places *Kingella kingae* as the most common cause of osteoarticular infections in young children. *Pediatr. Infect. Dis. J.* **26**:377–381.
- Dietz, P., G. Gerlach, and D. Beier. 2002. Identification of target genes regulated by the two-component system HP166-HP165 of *Helicobacter pylori*. *J. Bacteriol.* **184**:350–362.
- Forsyth, M. H., P. Cao, P. P. Garcia, J. D. Hall, and T. L. Cover. 2002. Genome-wide transcriptional profiling in a histidine kinase mutant of *Helicobacter pylori* identifies members of a regulon. *J. Bacteriol.* **184**:4630–4635.
- Froholm, L. O., and K. Bovre. 1972. Fimbriation associated with the spreading-corroding colony type in *Moraxella kingii*. *Acta Pathol Microbiol. Scand. B Microbiol. Immunol.* **80**:641–648.
- Fyfe, J. A., C. S. Carrick, and J. K. Davies. 1995. The *pilE* gene of *Neisseria gonorrhoeae* MS11 is transcribed from a  $\sigma^{70}$  promoter during growth in vitro. *J. Bacteriol.* **177**:3781–3787.
- Gené, A., J. J. Garcia-Garcia, P. Sala, M. Sierra, and R. Huguet. 2004. Enhanced culture detection of *Kingella kingae*, a pathogen of increasing clinical importance in pediatrics. *Pediatr. Infect. Dis. J.* **23**:886–888.
- Heinrich, D. W., and A. C. Glasgow. 1997. Transcriptional regulation of type 4 pilin genes and the site-specific recombinase gene, *piv*, in *Moraxella lacunata* and *Moraxella bovis*. *J. Bacteriol.* **179**:7298–7305.
- Hendrixson, D. R., B. J. Akerley, and V. J. DiRita. 2001. Transposon mutagenesis of *Campylobacter jejuni* identifies a bipartite energy taxis system required for motility. *Mol. Microbiol.* **40**:214–224.
- Henriksen, S. D. 1969. Corroding bacteria from the respiratory tract. 1. *Moraxella kingii*. *Acta Pathol. Microbiol. Scand.* **75**:85–90.
- Hobbs, M., E. S. Collie, P. D. Free, S. P. Livingston, and J. S. Mattick. 1993. PilS and PilR, a two-component transcriptional regulatory system controlling expression of type 4 fimbriae in *Pseudomonas aeruginosa*. *Mol. Microbiol.* **7**:669–682.
- Hood, B. L., and R. Hirschberg. 1995. Purification and characterization of *Eikenella corrodens* type IV pilin. *Infect. Immun.* **63**:3693–3696.
- Ishimoto, K. S., and S. Lory. 1992. Identification of *pilR*, which encodes a transcriptional activator of the *Pseudomonas aeruginosa* pilin gene. *J. Bacteriol.* **174**:3514–3521.
- Jin, S., K. S. Ishimoto, and S. Lory. 1994. PilR, a transcriptional regulator of piliation in *Pseudomonas aeruginosa*, binds to a cis-acting sequence upstream of the pilin gene promoter. *Mol. Microbiol.* **14**:1049–1057.
- Kehl-Fie, T. E., S. E. Miller, and J. W. St. Geme III. 2008. *Kingella kingae* expresses type IV pili that mediate adherence to respiratory epithelial and synovial cells. *J. Bacteriol.* **190**:7157–7163.
- Kehl-Fie, T. E., and J. W. St. Geme III. 2007. Identification and characterization of an RTX toxin in the emerging pathogen *Kingella kingae*. *J. Bacteriol.* **189**:430–436.
- Laskos, L., J. P. Dillard, H. S. Seifert, J. A. Fyfe, and J. K. Davies. 1998. The pathogenic neisseriae contain an inactive *rpoN* gene and do not utilize the *pilE*  $\sigma^{54}$  promoter. *Gene* **208**:95–102.
- Leech, A. J., A. Sprinkle, L. Wood, D. J. Wozniak, and D. E. Ohman. 2008. The NtrC family regulator AlgB, which controls alginate biosynthesis in mucoid *Pseudomonas aeruginosa*, binds directly to the *algD* promoter. *J. Bacteriol.* **190**:581–589.
- Li, Y., G. Hao, C. D. Galvani, Y. Meng, L. De La Fuente, H. C. Hoch, and T. J. Burr. 2007. Type I and type IV pili of *Xylella fastidiosa* affect twitching motility, biofilm formation and cell-cell aggregation. *Microbiology* **153**:719–726.
- Lukat, G. S., W. R. McCleary, A. M. Stock, and J. B. Stock. 1992. Phosphorylation of bacterial response regulator proteins by low molecular weight phospho-donors. *Proc. Natl. Acad. Sci. USA* **89**:718–722.
- Ma, S., U. Selvaraj, D. E. Ohman, R. Quarless, D. J. Hassett, and D. J. Wozniak. 1998. Phosphorylation-independent activity of the response regulators AlgB and AlgR in promoting alginate biosynthesis in mucoid *Pseudomonas aeruginosa*. *J. Bacteriol.* **180**:956–968.
- McCleary, W. R., J. B. Stock, and A. J. Ninfa. 1993. Is acetyl phosphate a global signal in *Escherichia coli*? *J. Bacteriol.* **175**:2793–2798.
- McDaniel, T. K., K. C. Dewalt, N. R. Salama, and S. Falkow. 2001. New approaches for validation of lethal phenotypes and genetic reversion in *Helicobacter pylori*. *Helicobacter* **6**:15–23.
- Moumille, K., J. Merckx, C. Glorion, P. Berche, and A. Ferroni. 2003. Osteoarticular infections caused by *Kingella kingae* in children: contribution of polymerase chain reaction to the microbiologic diagnosis. *Pediatr. Infect. Dis. J.* **22**:837–839.
- Parker, D., R. M. Kennan, G. S. Myers, I. T. Paulsen, J. G. Songer, and J. I. Rood. 2006. Regulation of type IV fimbrial biogenesis in *Dichelobacter nodosus*. *J. Bacteriol.* **188**:4801–4811.
- Sambrook, J., E. F. Fritsch, and T. Maniatis. 1989. Molecular cloning: a laboratory manual, 2nd ed. Cold Spring Harbor Laboratory Press, Cold Spring Harbor NY.
- Schär, J., A. Sickmann, and D. Beier. 2005. Phosphorylation-independent activity of atypical response regulators of *Helicobacter pylori*. *J. Bacteriol.* **187**:3100–3109.
- Stock, A. M., V. L. Robinson, and P. N. Goudreau. 2000. Two-component signal transduction. *Annu. Rev. Biochem.* **69**:183–215.
- Verdier, I., A. Gayet-Ageron, C. Ploton, P. Taylor, Y. Benito, A. M. Freydiere, F. Chotel, J. Berard, P. Vanhems, and F. Vandenesch. 2005. Contribution of a broad range polymerase chain reaction to the diagnosis of osteoarticular infections caused by *Kingella kingae*: description of twenty-four recent pediatric diagnoses. *Pediatr. Infect. Dis. J.* **24**:692–696.
- Wanner, B. L. 1992. Is cross regulation by phosphorylation of two-compo-

- nent response regulator proteins important in bacteria? J. Bacteriol. **174**:2053–2058.
34. **Whitchurch, C. B., T. E. Erova, J. A. Emery, J. L. Sargent, J. M. Harris, A. B. Semmler, M. D. Young, J. S. Mattick, and D. J. Wozniak.** 2002. Phosphorylation of the *Pseudomonas aeruginosa* response regulator AlgR is essential for type IV fimbria-mediated twitching motility. J. Bacteriol. **184**:4544–4554.
35. **Wozniak, D. J., and D. E. Ohman.** 1991. *Pseudomonas aeruginosa* AlgB, a two-component response regulator of the NtrC family, is required for *algD* transcription. J. Bacteriol. **173**:1406–1413.
36. **Wu, S. S., and D. Kaiser.** 1997. Regulation of expression of the *pilA* gene in *Myxococcus xanthus*. J. Bacteriol. **179**:7748–7758.
37. **Yagupsky, P.** 2004. *Kingella kingae*: from medical rarity to an emerging paediatric pathogen. Lancet Infect. Dis. **4**:358–367.
38. **Yagupsky, P., R. Dagan, C. W. Howard, M. Einhorn, I. Kassis, and A. Simu.** 1992. High prevalence of *Kingella kingae* in joint fluid from children with septic arthritis revealed by the BACTEC blood culture system. J. Clin. Microbiol. **30**:1278–1281.
39. **Yagupsky, P., N. Peled, and O. Katz.** 2002. Epidemiological features of invasive *Kingella kingae* infections and respiratory carriage of the organism. J. Clin. Microbiol. **40**:4180–4184.
40. **Yagupsky, P., N. Porat, and E. Pinco.** 2009. Pharyngeal colonization by *Kingella kingae* in children with invasive disease. Pediatr. Infect. Dis. J. **28**:155–157.