

2013

Thesis for doctoral degree (Ph.D.) 2013

# TP53 mutations in myelodysplastic syndromes with deletion of 5q

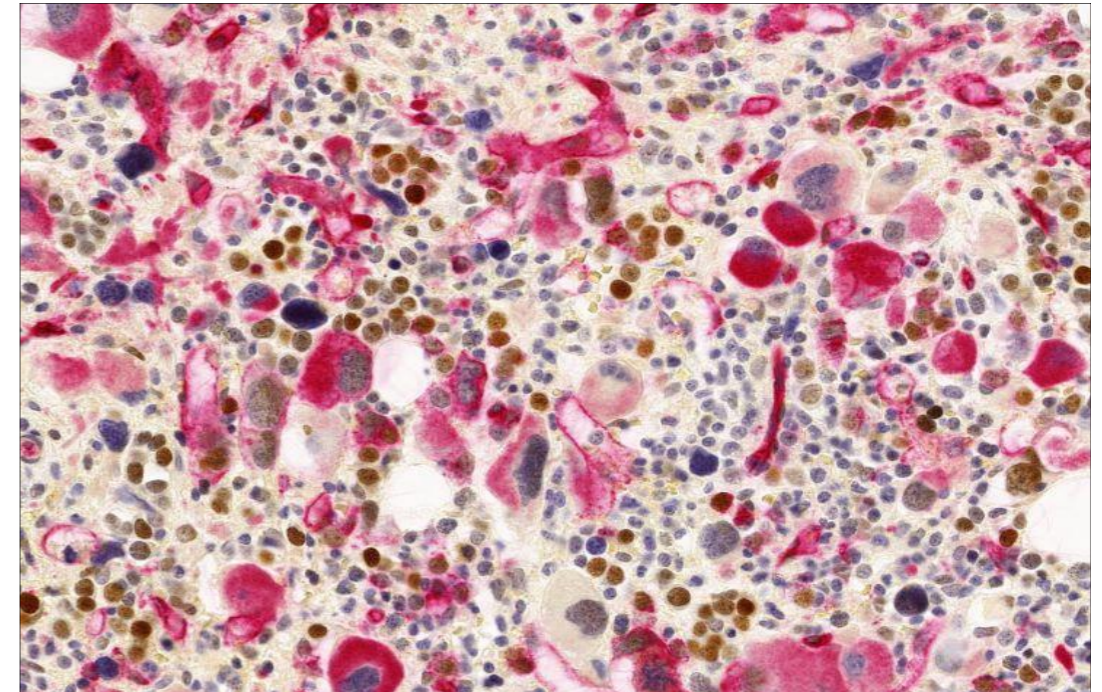

TP53 mutations in myelodysplastic syndromes with deletion of 5q

Leonie Saft

Leonie Saft

From the Division of Hematology, Department of Medicine,  
Karolinska University Hospital, Huddinge,  
Karolinska Institute, Stockholm, Sweden

**TP53 MUTATIONS  
IN MYELOYDYSPLASTIC SYNDROMES  
WITH DELETION OF 5Q**

Leonie Saft



**Karolinska  
Institutet**

Stockholm 2013

*Cover:* The heterogeneity of del(5q) MDS

All previously published papers were reproduced with permission from the publisher.

Published by Karolinska Institutet. Printed by larserics.

© Leonie Saft, 2013

ISBN 978-91-7549-137-0

*"Was ist das Schwerste von allem? Was Dir das Leichteste dünket:  
Mit den Augen zu sehn, was vor den Augen dir lieget."*

J.W. von Goethe, Xenien aus dem Nachlass 45

*To Tobias, Niklas and Sofia*



## ABSTRACT

The myelodysplastic syndromes (MDS) constitute a heterogeneous group of malignant bone marrow disorders characterized by peripheral cytopenia(s) and increased risk of progression to acute myeloid leukemia (AML). International Prognostic Scoring system (IPSS) Low- or Intermediate (INT)-1 risk MDS with a deletion of 5q (del5q) were considered to have an indolent course and a low risk for progression to AML as compared to other MDS subtypes. However, more recent studies have shown that overall survival (OS) and risk for AML progression vary greatly in del(5q) MDS patients indicating that factors beyond established risk scoring systems impact patient outcome. Molecular abnormalities have emerged as putative prognostic markers.

We performed molecular studies in a patient with classical 5q- syndrome who unexpectedly evolved to high-risk MDS with complex karyotype (*Paper I*). Immunohistochemistry (IHC) of pre-treatment marrow biopsies revealed a small fraction of progenitors with strong p53 expression and sequencing confirmed a *TP53* mutation. *TP53* mutated subclones had not been described in MDS with isolated del(5q) and indicated a previously unknown heterogeneity. In a subsequent study of 55 patients with lower-risk del(5q) MDS, 18% of the patients were found to have *TP53* mutated subclones at diagnosis which rendered them at higher risk for progression (*Paper II*). Interestingly, the association with outcome was even stronger for p53 IHC indicating a high sensitivity of this method for early identification of patients with adverse outcome. As a next step, we assessed p53 protein expression in a cohort of 85 lower-risk del(5q) MDS patients treated with lenalidomide within a clinical trial (*Paper IV*). P53 IHC positive patients showed significantly shorter overall survival, higher risk for leukemic transformation, and lower cytogenetic response rate to lenalidomide, hence validating the results from Paper II. Importantly, pyrosequencing analysis of microdissected IHC stained cells confirmed that cells with strong staining carried *TP53* mutations, while moderate staining reflected wild-type *TP53*.

Due to the apparently exquisite sensitivity of the del(5q) clone to len, we hypothesized that higher doses of lenalidomide may induce cytogenetic and clinical responses also in patients with high-risk MDS/AML with chromosome 5 abnormalities who were refractory or ineligible for standard treatment (*Paper III*). In this study, we demonstrated that treatment was able to inhibit the del(5q) tumor clone in a cohort of patients with extremely advanced disease, which suggests that the selective inhibitory effect of len *in vitro* may be translated into a therapeutic response *in vivo*. Importantly, *TP53* mutations were common (62%) in this cohort, and uniformly associated with treatment failure. Altogether, our findings suggest an important role of the p53 pathway in both low- and high-risk del(5q) MDS, and in relation to treatment with lenalidomide. These findings will have major implications for risk stratification and the choice of therapy.

# LIST OF PUBLICATIONS

This thesis is based on the following papers:

- I. Clonal heterogeneity in the 5q- syndrome: p53 expressing progenitors prevail during lenalidomide treatment and expand at disease progression**  
Martin Jädersten, Leonie Saft, Andrea Pellagatti, Gudrun Göhring, James S. Wainscoat, Jacqueline Boulwood, Anna Porwit, Brigitte Schlegelberger, and Eva Hellström-Lindberg. *Haematologica* 2009; 94(12):1762-6
- II. TP53 Mutations in Low-Risk Myelodysplastic Syndromes with del(5q) predict disease progression**  
Martin Jädersten\*, Leonie Saft\*, Alexander Smith, Austin Kulasekararaj, Sabine Pomplun, Gudrun Göhring, Anette Hedlund, Robert Hast, Brigitte Schlegelberger, Anna Porwit, Eva Hellström-Lindberg\*, and Ghulam J. Mufti\*. *Journal of Clinical Oncology* 2011; 29 (15): 1971-9
- III. Clinical effect of increasing doses of lenalidomide in high-risk myelodysplastic syndrome and acute myeloid leukemia with chromosome 5 abnormalities**  
Lars Möllgård, Leonie Saft, Marianne Bach Treppendahl, Ingunn Dybedal, Jan Maxwell Nørgaard, Jan Astermark, Elisabeth Ejerblad, Hege Garelius, Inge Høgh Dufva, Monika Jansson, Martin Jädersten, Lars Kjeldsen, Olle Linder, Lars Nilsson, Hanne Vestergaard, Anna Porwit, Kirsten Grønbæk, and Eva Hellström-Lindberg. *Haematologica* 2011; 96 (7): 963-71
- IV. P53 protein expression predicts outcome and cytogenetic response in patients with Low-/INT-1 risk myelodysplastic syndromes treated with lenalidomide**  
Leonie Saft, Mohsen Karimi, Mehran Ghaderi, Andrés Matolscy, Ghulam Mufti, Aristoteles Giagounidis, Dominik Selleslag, Petra Muus, Guillermo Sanz, Moshe Mittelman, David Bowen, Anna Porwit, Tommy Fu, Jay Backstrom, Pierre Fenaux, Kyle J. MacBeth, and Eva Hellström-Lindberg. *Manuscript submitted.*

\*L.S. and M.J. contributed equally to this work. E.H.-L. and G.J.M. are senior co-authors.

**Related publications not included in the thesis:**

**I. Bone marrow dendritic cells are reduced in patients with high-risk myelodysplastic syndromes**

Leonie Saft, Elisabet Björklund, Elisabeth Berg, Eva Hellström-Lindberg, Anna Porwit. *Leukemia Research* 2013; 37(3): 266–73

**II. The AML–MDS interface—leukemic transformation in myelodysplastic syndromes**

Anna Porwit and Leonie Saft. *Journal of Hematopathology* 2011, 4: 69-79

**III. Multicenter validation of a reproducible flow cytometric score for the diagnosis of low-grade myelodysplastic syndromes: results of a European LeukemiaNET study**

Matteo G. Della Porta, Cristina Picone, Cristiana Pascutto, Luca Malcovati, Hideto Tamura, Hiroshi Handa, Magdalena Czader, Sylvie Freeman, Paresh Vyas, Anna Porwit, Leonie Saft, Theresia M. Westers, Canan Alhan, Claudia Cali, Arjan A. van de Loosdrecht, and Kiyoyuki Ogata. *Haematologica* 2012;97(8):1209-17



# TABLE OF CONTENTS

<b>1. ABBREVIATIONS .....</b>	<b>11</b>
<b>2. THE MYELODYSPLASTIC SYNDROMES (MDS) .....</b>	<b>13</b>
<b>2.1. Definition .....</b>	<b>13</b>
<b>2.2. Epidemiology .....</b>	<b>13</b>
<b>2.3. Clinical and morphological diagnosis .....</b>	<b>14</b>
2.3.1. Clinical features.....	14
2.3.2. Cytological features .....	15
2.3.3. Histology and Immunohistochemistry .....	17
2.3.4. WHO Classification .....	18
2.3.5. Cytogenetics .....	20
2.3.6. Prognosis, risk assessment and follow-up.....	22
2.3.7. Flow cytometry – detection of aberrant patterns beyond the microscope .....	24
<b>2.4. Pathogenesis .....</b>	<b>24</b>
2.4.1. A stem cell disease .....	24
2.4.2. Gene mutations.....	25
2.4.3. Epigenetics .....	28
2.4.4. The role of the immune system .....	28
2.4.5. The bone marrow microenvironment – a disease driver in human MDS?.....	29
<b>2.5. The "5q- syndrome" .....</b>	<b>30</b>
<b>2.6. Treatment and predictors of response .....</b>	<b>32</b>
2.6.1. Supportive care.....	32
2.6.2. Erythropoietin.....	33
2.6.3. Immunosuppressive therapy .....	34
2.6.4. Azacytidine.....	34
2.6.5. Induction chemotherapy.....	34
2.6.6. Allogeneic stem cell transplantation.....	35
2.6.7. Lenalidomide in del(5q) MDS.....	35
2.6.8. Predictors of response .....	37

<b>3. THE TP53 GENE .....</b>	<b>38</b>
3.1. A brief history .....	38
3.2. Structure and function of p53.....	39
3.3. TP53 mutations in cancer.....	41
3.4. Immunohistochemistry.....	42
3.5. Targeting p53 in the clinic.....	45
<b>4. THE TP53 PATHWAY IN DEL(5Q) MDS.....</b>	<b>46</b>
4.1. Activation of the TP53 pathway.....	46
4.2. TP53 mutations.....	48
<b>5. AIMS OF THE THESIS.....</b>	<b>49</b>
<b>6. MATERIALS AND METHODS .....</b>	<b>50</b>
6.1. Paper I, II and VI.....	51
6.2. Paper III.....	52
<b>7. RESULTS AND DISCUSSION .....</b>	<b>53</b>
7.1. Paper I, II and IV.....	53
7.2. Paper III.....	55
<b>8. CONCLUSIONS .....</b>	<b>57</b>
<b>9. FUTURE PERSPECTIVES.....</b>	<b>58</b>
<b>10. ACKNOWLEDGEMENTS .....</b>	<b>60</b>
<b>11. APPENDIX: TP53 mutations in MDS (Table) .....</b>	<b>62</b>
<b>12. REFERENCES .....</b>	<b>66</b>



# 1. ABBREVIATIONS

AA	Aplastic anemia
ALIP	Abnormal localization of immature precursors
ANC	Absolute neutrophil count
AML	Acute myeloid leukemia
ALIP	Abnormal localization of immature precursors
Aza	Azacytidine
BM	Bone marrow
CDR	Commonly deleted region
CMML	Chronic myelomonocytic leukemia
CyR	Cytogenetic response
ELN	European Leukemia Network
EMA	European Medicines Agency
Se-EPO	Serum-Erythropoietin
FCM	Flow cytometry
FFPE BM	Formalin-fixed paraffin-embedded bone marrow
G-CSF	Granulocyte colony-stimulating factor
Hb	Hemoglobin
HSC	Hematopoietic Stem Cell
IHC	Immunohistochemistry
IPSS	International Prognostic Scoring System
IPSS-R	Revised IPSS
RA	Refractory anemia
Len	Lenalidomide
LCM	Laser cell microdissection
MDS	Myelodysplastic syndrome
MPN	Myeloproliferative neoplasm
OS	Overall survival
PB	Peripheral blood
RAEB	Refractory anemia with excess of blasts
RARS	Refractory anemia with ringsideroblasts
RCMD	Refractory cytopenia with multilineage dysplasia
RCMD-RS	Refractory cytopenia with multilineage dysplasia and ringsideroblasts
t-AML	Therapy-related AML
TP53	Tumor protein p53
WBC	White blood count
WHO	World Health Organization
WPSS	WHO-based Prognostic Scoring System



## 2. THE MYELODYSPLASTIC SYNDROMES (MDS)

### 2.1. Definition

The myelodysplastic syndromes (MDS) constitute a heterogeneous group of clonal hematopoietic stem cell (HSC) disorders characterized by cytopenia(s), dysplasia in one or more of cell lineages, ineffective hematopoiesis, and increased risk of progression to acute myeloid leukemia (AML). MDS can arise *de novo* or as a consequence of previous chemotherapy or radiation. Although the majority of MDS are characterized by progressive bone marrow (BM) failure, the clinical course varies substantially in the different subtypes with survival ranging from a few months to decades<sup>(1)</sup>.

### 2.2. Epidemiology

MDS is a disease of the elderly and one of the most common hematologic cancer in patients over the age of 70 years, among which the annual incidence exceeds 20 per 100,000 persons<sup>(2)</sup>. Since January 2009, all newly diagnosed cases of MDS in Sweden are registered in a national cancer registry as part of the INCA-platform ([www.incanet.se](http://www.incanet.se)). The number of registered MDS diagnoses was 265 patients for 2009 and 309 patients for 2010 with a crude incidence of 4 cases/100.000 inhabitants/year. Thus, the incidence for this time period is in line with previous Swedish and international reports<sup>(3-5)</sup>. However, there are indications that MDS may be underreported to cancer registries, in part due to the lack of formal diagnostic testing in this patient population<sup>(3, 6)</sup>. In a recent regional Australian study the incidence was almost twofold higher as compared to data from central cancer registries in Australia (for 2007 9.6 per 100.000/year vs. 4.8 per 100.000/year). In two other studies using US Medicare data for patients  $\geq 65$  years up to 4-fold incidence rates for MDS were reported<sup>(3, 6)</sup> as compared to US cancer registry data with 3.3 per 100 000 persons/year during 2001-2004 and an estimated prevalence of 55 000 persons in the US<sup>(7)</sup>. One possible explanation for the discrepancy could be due to the way MDS was registered. For example, it was found that many cases were linked to individuals already registered for another cancer, and existing guidelines recommended the removal of MDS as a separate primary tumor<sup>(3)</sup>. The incidence of MDS may also be underreported because of failure to recognize the diagnosis. For example, given the

chronic nature of disease, a possible MDS patient may be asymptomatic or incompletely investigated and diagnosed as unspecified anemia.

The median age at diagnosis in the INCA cohort was 75 years (range, 17-94 years) and 70% of the patients were >70 years old. There was a slight male predominance (56%). MDS was related to previous cytostatic treatment or radiotherapy in 10% of the cases.

Risk factors for MDS include cytostatic treatment and in particular alkylating agents, radiation therapy, and to a lesser extent, tobacco use and occupational exposure to solvents and agricultural chemicals<sup>(8)</sup>. The risk of MDS is markedly increased in certain genetic syndromes and in context of inherited bone marrow failure syndromes (i.e. Fanconi anemia, Shwachman-Diamond syndrome, severe congenital neutropenia, Dyskeratosis congenita, Diamond-Blackfan anemia).

## **2.3 Clinical and morphological diagnosis**

Diagnostic work-up of MDS is well described in the Nordic guidelines for MDS ([www.nmds.org](http://www.nmds.org)) and includes detailed clinical information with family history, relevant laboratory data, cytomorphologic evaluation of peripheral blood and bone marrow aspirate smear, bone marrow biopsy, cytogenetic analysis, and molecular analysis, if relevant. Using this integrated approach, an MDS diagnosis can be made in most cases and non-malignant causes of cytopenia can be excluded.

However, the standard diagnostic criteria for MDS and its various subtypes using the World Health Organization (WHO) classification rely heavily on the (subjective) morphologic evaluation of bone marrow cells. In spite of recent advances in the understanding of the pathogenesis of the disease, these disorders remain among the most challenging of the myeloid neoplasms in terms of proper diagnosis and classification<sup>(9, 10)</sup>.

### **2.3.1. Clinical features**

MDS patients typically present with symptoms related to persistent (>6 months) refractory cytopenia: more than 80% of patients have anemia, 40% neutropenia and 30-40% thrombocytopenia. The thresholds for cytopenias as recommended in the International Prognostic Scoring System (IPSS) for risk stratification in MDS are hemoglobin of <10g/dl, absolute neutrophil count (ANC) <1.8x10<sup>9</sup>/L and platelets

<100x10<sup>9</sup>/L. However, levels above these thresholds do not exclude the diagnosis of MDS if definitive morphological and cytogenetic findings are present. Macrocytosis is a common laboratory finding and may be an early sign even without associated anemia. Significant cytopenia is associated with higher morbidity and mortality in MDS<sup>(11)</sup>.

### 2.3.2. Cytological features

The morphological classification of MDS is based on the percentage of blasts in the BM and PB, the degree of dysplasia and the number of dysplastic cell lineages as well as the presence of ring sideroblasts<sup>(12)</sup>. Minimal diagnostic criteria for MDS have been proposed (Table 1) which allow discrimination of MDS from other neoplastic or reactive disorders associated with cytopenia and/or dysplasia<sup>(13, 14)</sup>. In patients who do not fulfill these minimal criteria, a provisional diagnosis of idiopathic cytopenia or dysplasia of undetermined significance/uncertain significance (ICUS/IDUS) may be considered<sup>(15-17)</sup>.

<b>Table 1. Minimal diagnostic criteria for MDS (adapted from Valent et al., 2009)</b>	
<b>Criteria</b>	<b>Major (diagnostic) test</b>
<p><b>Prerequisite criteria (both must be fulfilled)</b></p> <ul style="list-style-type: none"> <li>• Constant cytopenia</li> <li>• Exclusion of other diseases as primary cause of cytopenia/ dysplasia</li> </ul>	<p>Blood counts (over 6 months)            BM smear and histology, cytogenetics, FCM, molecular markers, other relevant investigations*</p>
<p><b>MDS-related criteria (one of these must be fulfilled)</b></p> <ul style="list-style-type: none"> <li>• Morphological dysplasia in one of the three myeloid cell lineages</li> <li>• Blast cell count ≥5%</li> <li>• Ring sideroblasts ≥15%</li> <li>• Typical karyotype anomaly</li> </ul>	<p>BM and PB smear, in certain situations:            BM histology            BM smear and BM histology, cytogenetics, FCM, molecular markers, other relevant investigations*            Iron stain            Conventional karyotyping and FISH</p>
<p><b>Co-criteria</b></p> <ul style="list-style-type: none"> <li>• BM stem cell function</li> <li>• Abnormal immunophenotype</li> <li>• Monoclonality of myeloid cells</li> <li>• Abnormal gene expression profile</li> </ul>	<p>Circulating CFC, reticulocytes            Flow cytometry, Immunohistochemistry            Molecular markers, mutations            mRNA profiling assays</p>
<p>*Investigations depend on the case history and overall situation and should include a complete chemistry profile with inflammation parameters, immunoglobulins, S-EPO level, S-tryptase level. FCM, flow cytometry; CFC, colony-forming progenitor cells</p>	



The cytopenias may correspond to the dysplastic cell lineage, however, in a recent study including 2032 MDS patients from the Düsseldorf Registry, no association between the type of cytopenia and dysplasia was found <sup>(18)</sup>. In addition, patients with borderline features may have normal peripheral blood status. The recommended requisite percentage of cells with dysplasia is  $\geq 10\%$  for each cell lineage; megakaryocytic dysplasia should be assessed on at least 30 megakaryocytes in smears or bone marrow sections.

**Figure 1. Morphological features of dysplasia**

Dyserythropoiesis	Dysgranulopoiesis	Dysmegakaryocytopoiesis
<b>Nuclear</b> Nuclear budding Hyperlobation Internuclear bridging Karyorrhexis Multinuclearity Megaloblastic changes  <b>Cytoplasmatic</b> Ring sideroblasts Vacuolization Periodic acid-Schiff positivity	Small or unusual large size Nuclear hypolobation (pseudo Pelger Huët; pelgeroid) Irregular hypersegmentation Decreased granules Agranularity Pseudo Chediak-Higashi granules Auer rods	Micromegakaryocytes Nuclear hypolobation Multinucleation

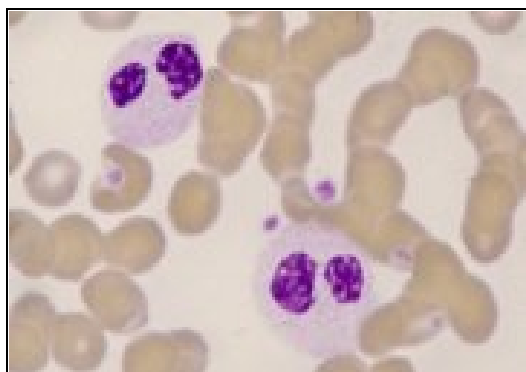
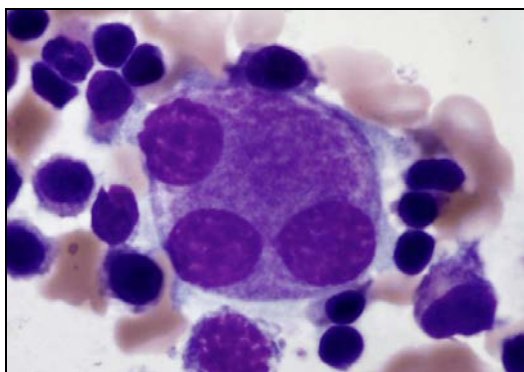

The enumeration of blasts in bone marrow aspirate and peripheral blood smear is essential in the diagnostic work up, and for the classification and prognostication of MDS. To determine the blast percentage in the BM, a 500-cell differential of all nucleated cells in a smear or trephine imprint is recommended and in the PB, a 200-leukocyte differential. Assessment of blast percentage and degree of dysplasia can be problematic, especially when samples are hemodiluted or when the quality of the

smear is 'suboptimal'. In addition, smears may be hypocellular in hypoplastic or fibrotic BM, not allowing an adequate quantitative and qualitative assessment. Overall, the necessity of high quality slide preparations cannot be overemphasized, and results should always be correlated to the histological assessment. Also, differential counts should not be substituted with the enumeration of blasts by flow cytometry since the difference in sample quality and sample processing may lead to over- or underestimation of blast percentage by flow cytometry.

### 2.3.3. Histology and Immunohistochemistry

The histological and immunohistochemical examination of BM biopsies contributes essentially to the diagnosis, classification and prognostication of suspected MDS<sup>(19, 20)</sup>. Standards and guidelines in the evaluation of MDS by histology and IHC have recently been proposed by a consortium of US and EU experts at a Working Conference<sup>(21)</sup>. The biopsy allows for precise assessment of marrow cellularity, fibrosis and architectural features (Figure 2). BM cellularity and grade of fibrosis should be assessed according to the European Consensus Grading System<sup>(22)</sup>. The presence of marrow fibrosis has been identified as independent prognostic risk factor in several studies<sup>(23-26)</sup>. Significant myelofibrosis (grade 2-3) is observed in approximately 10% of MDS and often associated with multilineage dysplasia, high transfusion requirement, and poor prognosis. The biopsy helps to distinguish hypoplastic MDS from aplastic anemia or hypoplastic AML<sup>(20)</sup>, however, several biopsies may be required before a final diagnosis can be made. Moreover, it is clinically relevant to distinguish hypoplastic from normo- or hyperplastic and fibrotic MDS, since treatment approaches may differ. In addition, histology may reveal an unrelated or co-existing hematopoietic neoplasm.

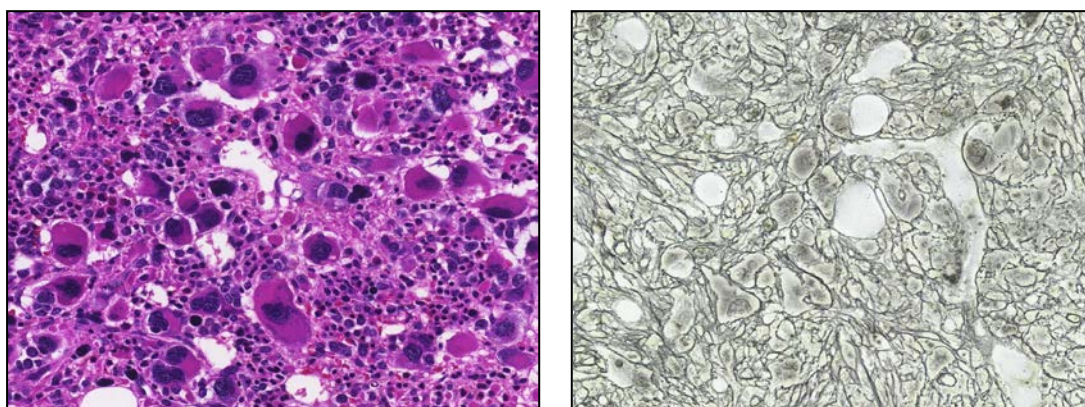

**Figure 2.** BM histology in a patient with MDS shows megakaryocytic hyperplasia, dysplasia and fibrosis (Hematoxylin-eosin and Gomori Silver stain, 40x objective).

Immunohistochemistry has been proposed in patients with (suspected) MDS <sup>(15, 19, 27)</sup> using a minimal IHC panel; additional (lineage-specific) markers may be used when the diagnosis MDS is in question or another co-existing neoplasm is suspected <sup>(21)</sup>. The CD34 stain is useful for the enumeration of CD34+ blasts in the biopsy, and also for the detection of CD34+ clusters which has been suggested as an independent prognostic marker in MDS <sup>(24, 28, 29)</sup>. In situations where blast cells are CD34-negative, CD117/KIT has been recommended as an additional marker <sup>(21)</sup>. However, since CD117/KIT is also expressed by a proportion of proerythroblasts <sup>(30)</sup> evaluation may be difficult in some cases. There is generally good correlation between the percentage of myeloblasts as determined by cytology and histology, however, discordant results may be seen both with and without the presence of marrow fibrosis. In addition, the CD34 antigen may be detectable in immature megakaryocytes and megakaryoblasts in MDS (Figure 3), and increased CD34 expression has been associated with advanced disease <sup>(31)</sup>. However, CD34-expression is not a specific feature of MDS-megakaryocytes.

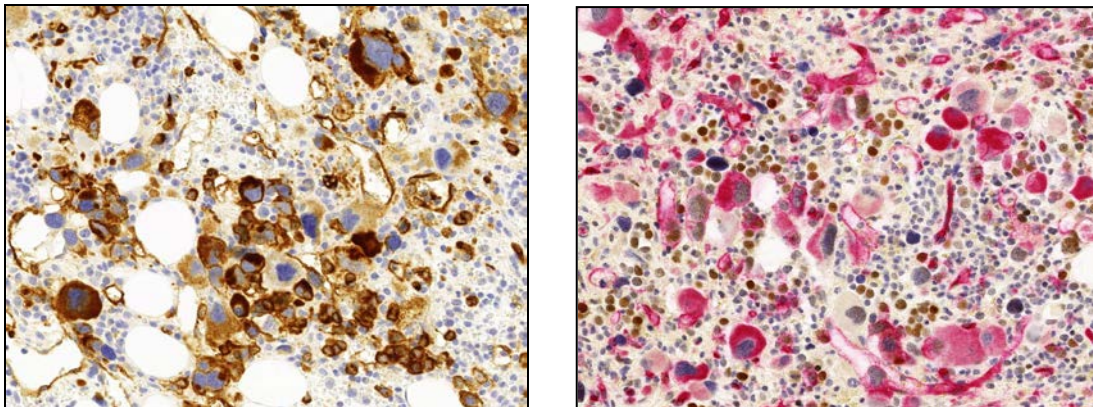

**Figure 3.** IHC demonstrates an increase in CD34+ blast cells, aberrant expression of CD34 in megakaryocytes and microvascular hyperplasia. A fraction of BM progenitor cells shows strong p53 staining (brown nuclei; right plot).

#### 2.3.4. WHO Classification

The World Health Organization (WHO) classification of MDS was updated in 2008 and provides at date the best diagnostic approach to MDS (Table 2)<sup>(12)</sup>. The WHO classification has considerable prognostic relevance <sup>(32)</sup>, and its implementation into clinical practice is mandatory for optimal management of MDS.

<b>Table 2. WHO 2008 Classification of Myelodysplastic Syndromes (ref. 12)</b>		
<b>WHO subtype</b>	<b>Peripheral blood</b>	<b>Bone marrow findings</b>
<b>Refractory cytopenias with unilineage dysplasia (RCUD)</b> Refractory anemia (RA) Refractory neutropenia (RN) Refractory thrombocytopenia (RT)	Unicytopenia or bicytopenia* No or rare blasts (<1%) **	Unilineage dysplasia: $\geq 10\%$ of the cells in one lineage <5% blasts <15% of erythroid precursors are ring sideroblasts
<b>Refractory anemia with ring sideroblasts (RARS)</b>	Anemia, no blasts	$\geq 15\%$ of erythroid precursors are ring sideroblasts, Erythroid dysplasia only <5% blasts
<b>Refractory cytopenia with multilineage dysplasia (RCMD)</b>	Cytopenia(s) No or rare blasts (<1%) No Auer rods <1x10 <sup>9</sup> /L monocytes	Dysplasia in $\geq 10\%$ of the cells in $\geq 2$ myeloid lineages <5% blasts in BM No Auer rods, +/- 15% ring sideroblasts
<b>Refractory anemia with excess blasts-1 (RAEB-1)</b>	Cytopenia(s), <5% blasts, no Auer rods <1x10 <sup>9</sup> /L monocytes	Unilineage or multilineage dysplasia 5-9% blasts** No Auer rods
<b>Refractory anemia with excess blasts-2 (RAEB-2)</b>	Cytopenia(s) <5% blasts Auer rods +/-*** <1x10 <sup>9</sup> /L monocytes	Unilineage or multilineage dysplasia 10-19% blasts Auer rods +/-
<b>Myelodysplastic syndrome-unclassified (MDS-U)</b>	Cytopenia(s)  $\leq 1\%$ blasts**	Unequivocal dysplasia in <10% of cells in $\geq 1$ cell lines accompanied by a cytogenetic abnormality; considered as presumptive evidence for MDS, <5% blasts
<b>MDS associated with isolated del(5q)</b>	Anemia; usually normal or increased platelet count No or rare blasts (<1%)	Normal to increased megakaryocytes with hypolobated nuclei; <5% blasts Isolated del(5q) abnormality No Auer rods
*Bicytopenia may occasionally be observed. Cases with pancytopenia should be classified as MDS-U; **If the marrow blast percentage is <5% but there are 2-4% myeloblasts in the blood, the diagnostic classification is RAEB 1. Cases of RCUD and RCMD with 1% myeloblasts in the blood should be classified as MDS-U; ***Cases with Auer rods and <5% myeloblasts in the blood and <10% in the bone marrow should be classified as RAEB-2		

However, the WHO 2008 classification was critically reassessed in a recent study based on a large number of patients with prolonged follow-up from the Düsseldorf MDS Registry, which led to the proposal of various modifications <sup>(18)</sup>. For example, the separation of RCUD into RA, RT and RN was found to be of questionable value due to the difficulties of separating these three subcategories on the basis of hematological and/or morphological characteristics, but also due to the fact that they were similar in terms of prognosis. The same was found for RCMD and MDS-unclassified.

Therefore, a simplified classification for MDS without excess of blasts was proposed including the consolidation of RA, RT and RN into RCUD and the elimination of MDS-unclassified as a distinct subcategory.

The “5q- syndrome” is the only subtype of MDS, which is defined by cytogenetics in addition to specific pathogenetic and morphologic characteristics. However, given its heterogeneous clinical course, it has become questionable whether it really represents a single true subcategory of MDS. The “5q- syndrome” is further discussed in section 2.5. In addition, it is possible that multilineage dysplasia, a morphological parameter that is important from a prognostic point of view, can be better defined using molecular criteria. A recent study found that MDS patients with RARS, RCMD and RCMD-RS subtypes displayed comparable clinical and cytogenetic profiles<sup>(33)</sup>. Yet, cytogenetics enabled a differentiated risk stratification within these morphologically defined “good-risk” subtypes. It is likely that molecular markers may become an important part of future classification systems within the frame of the WHO classification.

### **2.3.5. Cytogenetics**

Cytogenetic abnormalities are major determinants in the pathogenesis, diagnosis, and prognosis of MDS and have major impact on therapeutic decision-making in individual patients<sup>(34-36)</sup>. Chromosomal abnormalities are detected in approximately 50% of patients with de novo MDS (Figure 4) and in up to 80% in therapy-related MDS<sup>(37-40)</sup>. Aberrations are most common in the RAEB-subtypes.

In MDS, unbalanced chromosomal abnormalities reflecting gain or loss of chromosomal material are more prevalent in comparison to AML, while balanced translocation are rare<sup>(38)</sup>. The most frequently observed chromosomal abnormality in de novo MDS is the interstitial deletion of the long arm of chromosome 5, with or without additional karyotypic abnormalities<sup>(37, 38, 41)</sup>.

Certain cytogenetic abnormalities in MDS patients are associated with a characteristic morphology and clinical phenotype: the “5q- syndrome” is associated with the presence of hypolobated megakaryocytes and the del(17p) has been associated with the presence of Pseudo-pelger cells containing small vacuoles, a deletion of *TP53* and a high risk of leukemic transformation<sup>(42)</sup>.

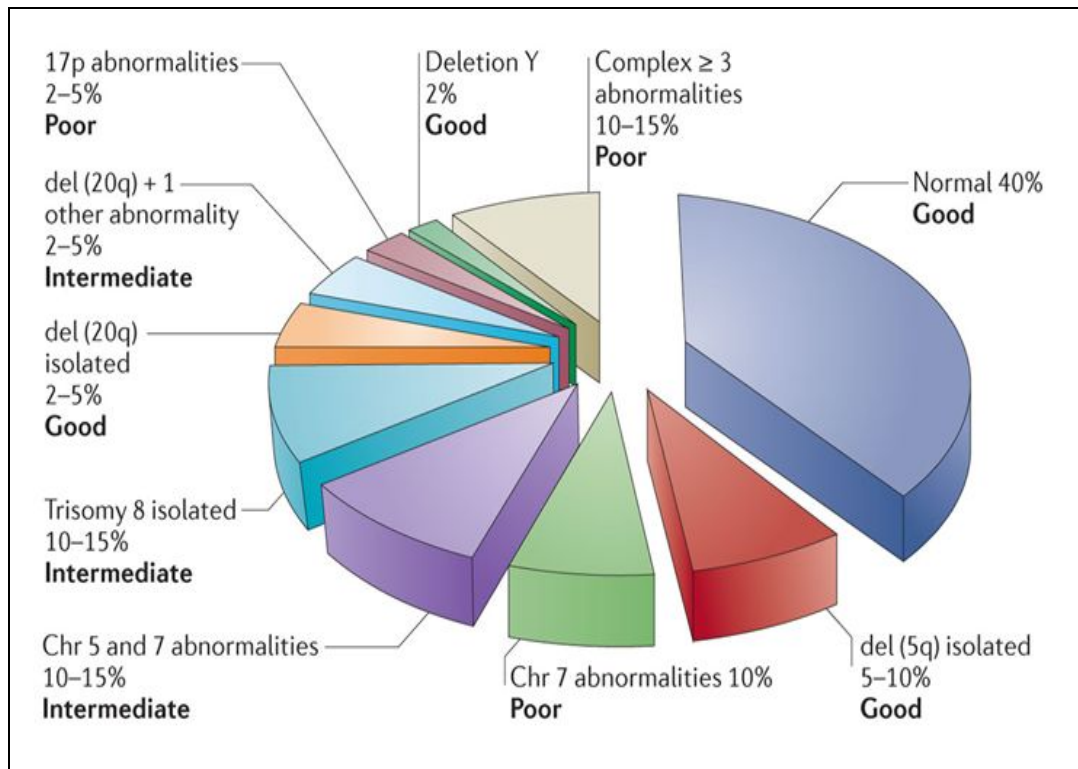

**Figure 4.** Common chromosomal abnormalities in MDS including International Prognostic Scoring System predictions. Reprinted by permission from Nature Publishing Group. (Raza et al, Nature Reviews Cancer 2012, 12: 849-59)

Recently, a new and comprehensive cytogenetic scoring system based on an international data collection of 2,902 patients was proposed<sup>(40)</sup>. Schanz *et al.* defined 19 cytogenetic categories, providing clear prognostic classification in 91% of all patients (Figure 5). The abnormalities were classified into five prognostic subgroups: very good, good, intermediate, poor, and very poor ( $>3$  abnormalities). In addition, a number of new single abnormalities (*inv(3)/t(3q)/del(3q)*, +8, *del(11q)*, *del(12p)*, *i(17)(q10)*, +19, and +21) were newly integrated into the scoring system.

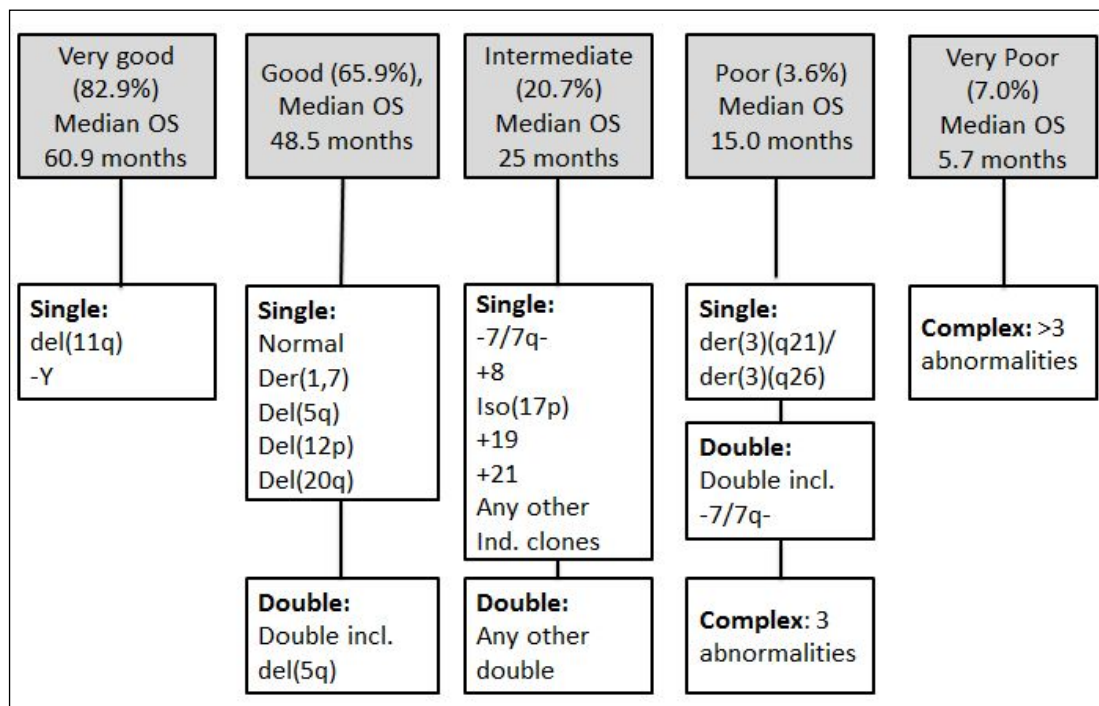

**Figure 5.** New cytogenetic classification of MDS (adapted from Schanz *et al.*, 2011).

The study revealed that deletion of chromosome 7 (del(7q) was more favorable than monosomy 7 with regard to OS and AML risk, a finding that had also been described in previous studies<sup>(43, 44)</sup>. Consequently, deletion of 7q was classified as intermediate, whereas the loss of the whole chromosome 7 was associated with worse prognosis. The data from this large study contributed to the update of the revised IPSS<sup>(45)</sup> by refining the cytogenetic risk categories as presented in the following section.

### 2.3.6. Prognosis, risk assessment and follow-up

The natural history of MDS varies considerably; while some patients experience an indolent course, others show short overall survival and rapid transformation to AML. Therefore, risk stratification is critical for both prognostic assessment and formulating treatment goals. Several prognostic scoring systems have been developed to identify MDS subtypes with different outcomes and to stratify patients into lower and higher risk subgroups. These schemes are based on morphology and clinical variables such as cytopenias and cytogenetics. The most commonly used prognostic tool is the International Prognostic Scoring System (IPSS) from 1997<sup>(46)</sup>. The original IPSS was recently revised. The updated IPSS-R uses five instead of three cytogenetic prognostic

subgroups, splits marrow blast percentage <5% into two groups, and introduces more levels of cytopenia (Table 3)<sup>(45)</sup>. However, the distinction of blast percentages between <2%, ≥2%-<5%, and ≥5% is critical in terms of reproducibility and needs to be validated. Interestingly, fibrosis was not confirmed as an independent prognostic marker in the IPSS-R, which could partly be due to the low frequency of samples that were assessed but it may also reflect differences in methodology.

<b>Table 3. Revised IPSS (adapted from Greenberg <i>et al.</i>, Blood 120, 2012)</b>							
<b>Prognostic variable</b>	<b>0.0</b>	<b>0.5</b>	<b>1.0</b>	<b>1.5</b>	<b>2.0</b>	<b>3.0</b>	<b>4.0</b>
Cytogenetics	Very good		Good		INT	Poor	Very poor
BM blasts, %	≤2%		>2-<5%		5-10%	>10%	
Hemoglobin (g/dl)	≥10		8-<10	<8			
Platelets (x10/L)	≥100	50-<100	<50				
ANC (x10/L)	≥0.8	<0.8					
<b>Risk category</b>	<b>Risk score</b>						
Very low	≤1.5	<b>Prognostic subgroups:</b> <b>Very good:</b> del(5q), -Y <b>Good:</b> normal, del(5q), del(12p), del(20q), double including del(5q) <b>Poor:</b> Inv(3)/t(3q)/del(3q), double including -7/del(7q), Complex karyotype: 3 abnormalities, -7 <b>Very poor:</b> complex karyotype (>3 abnormalities)					
Low	>1.5-3						
Intermediate	>3-4.5						
High	>4.5-6						
Very high	>6						

The WHO classification-based prognostic system (WPSS) is a modification of the IPSS and includes multilineage dysplasia and transfusion dependency as additional adverse prognostic variables<sup>(47)</sup>. Although the prognostic value of the latter has been validated in several studies<sup>(6, 48)</sup>, it has been considered to be too subjective<sup>(49)</sup>. In the refined WPSS model, severe anemia defined as hemoglobin levels lower than 9 g/dl in males and 8 g/dl in females, was found to be as effective as transfusion-dependency in the prognostic assessment<sup>(50)</sup>. Finally, somatic mutations have emerged as fundamental determinants for outcome in MDS, it is likely that some of these in the future may be incorporated into existing models.



### **2.3.7. Flow cytometry – detection of aberrant patterns beyond the microscope**

Flow cytometry (FCM) has been recognized as additional tool in the diagnosis and prognosis of MDS. The current WHO 2008 classification recognizes multiple flow cytometric aberrancies (>3) in maturation patterns as indicative of MDS.

FCM allows the identification of specific aberrations on both immature and mature compartments in the different hematopoietic lineages<sup>(51-53)</sup>. Different groups have designed scoring systems for the diagnosis and prognosis of MDS<sup>(52,54-60)</sup>. However, so far, the only validated prognostic flow score is the FC scoring system designed by Wells et al.<sup>(61)</sup>. In addition, validation of current assays and agreement on the techniques are prerequisites for its widespread acceptance and application in clinical practice. Therefore, the European Leukemia Network (ELN) working group was initiated to discuss and propose standards for FCM in MDS and to define minimal FC parameters to enable the categorization of FCM results as “normal”, “suggestive of”, or “diagnostic of” MDS<sup>(51,62)</sup>. Further studies have been initiated by this working group for the establishment of diagnostic and prognostic FC panels in MDS. Recently, a multicenter validation confirmed the ability to distinguish low risk MDS without other specific markers (i.e. cytogenetics and ring sideroblasts) from non-clonal cytopenias<sup>(52)</sup>. These findings were confirmed in a previous study, which demonstrated the utility of a FCM-score for the detection of marrow dysplasia based on four highly reproducible parameters<sup>(63)</sup>. However, it should be stressed that FCM should only be used as part of an integrated diagnosis in MDS.

## **2.4. Pathogenesis**

### **2.4.1. A stem cell disease**

The MDS clone has its origin in the hematopoietic stem cell compartment. Previous studies using transgenic MDS mouse models demonstrated that MDS HSCs can be transplanted to recipient mice who displayed all of the critical features of MDS, including peripheral blood cytopenias, dysplasia and transformation to AML<sup>(64-66)</sup>.

Fluorescence in situ hybridization (FISH) and gene expression data from purified HSCs from 5q- MDS patients have suggested a hematopoietic stem cell origin for MDS<sup>(67-71)</sup>.

In a recent study, Tehranchi et al identified rare and phenotypically distinct MDS stem cells in patients with del(5q) MDS <sup>(69)</sup>. These MDS stem cells were selectively resistant to therapeutic targeting by lenalidomide at the time of complete clinical and cytogenetic remission, indicating their importance not only in the pathogenesis of MDS but also for treatment. Moreover, it was found that a large fraction of these stem cells were in the G0 phase of the cell-cycle and quantitative gene-expression analysis demonstrated increased expression of the cyclin-dependent kinase inhibitor1C (CDKN1c) gene (p57KIP2) which has been implicated in stem-cell quiescence <sup>(72)</sup>. In addition, the expression of several genes (HOXA9, MEIS1, MCL1, BMI1, and MycN) linked to stem-cell function and leukemic transformation was up-regulated in the stem cells <sup>(73-76)</sup>. Will *et al.* demonstrate that stem and progenitor cells in MDS are characterized by stage-specific expansion and contain epigenetic and genetic alterations <sup>(70)</sup>. Moreover, longitudinal analysis in a patient treated with 5-azacytidine revealed that karyotypically abnormal HSCs persist even during complete morphologic remission and that expansion of clonotypic HSCs precedes clinical relapse. By transplanting purified human HSCs from MDS samples into immunodeficient mice, Pang et al provided direct evidence that HSCs are the disease-initiating cells in MDS <sup>(77)</sup>. Additionally, MDS bone marrow samples harboring a clonal cytogenetic marker, contained immunophenotypic HSCs that were composed almost entirely of the MDS clone suggesting that MDS HSCs are expanding at the expense of normal HSC.

Recent studies have linked p53 to the process of stem cell self-renewal <sup>(78-83)</sup>, and suppression of p53 or the p53 pathway enhanced the production of pluripotent stem cells, suggesting that p53 limits the reprogramming of differentiated cells into a self-renewing state <sup>(84-86)</sup>. The role of the *TP53* pathway in MDS is discussed in detail in section 4.

#### **2.4.2. Gene mutations**

MDS consists of several molecularly distinct entities. Gene expression studies of progenitor cells from patients with MDS have underlined the heterogeneity of the disease at the molecular level <sup>(87-89)</sup>, including difference in gene expression between low-risk and high-risk disease <sup>(88, 90)</sup>, and between specific cytogenetic subcategories <sup>(91, 92)</sup>. The compendium of genes carrying recurrent somatic mutations in MDS has grown dramatically over the last few years with the application of single nucleotide

polymorphism (SNP) arrays, whole exome and genome sequencing. Over 70% of MDS patients harbor somatic mutations or clonal cytogenetic abnormalities, and more than 50% of MDS patients carry at least one somatic mutation<sup>(93)</sup>. The genes mutated in MDS can be grouped into several categories: transcription factors (e.g., TP53, RUNX1, ETV6, WT1)<sup>(94-99)</sup>, epigenetic regulators and chromatin remodeling factors (e.g. TET2, DNMT3A, ASXL1, IDH1/2, EXH2)<sup>(100-110)</sup>, pre-mRNA splicing factors (U2AF35, ZRSR2, SRSF2, SF3B1)<sup>(111-116)</sup>, and signaling molecules (NRAS, JAK2, NPM1)<sup>(94, 117) (118-121)</sup>. Table 4 lists frequently found molecular aberrations in de novo MDS and their suggested role in MDS progression.

A recent work studied the clinical impact of point mutations in a cohort of 439 patients with MDS<sup>(94)</sup>. Somatic mutations of TP53, EZH2, ETV6, RUNX1, and ASXL1 were found to be independent predictors of decreased survival and to improve the risk stratification provided by the IPSS. The phenotypic heterogeneity within MDS is likely to be driven by these genetic changes and their interaction with therapeutic options. The identification of somatic mutations may aid in diagnosis and follow-up of MDS<sup>(98)</sup>. Therefore, testing for the presence of some of these mutations in PB or BM using deep sequencing is likely to become a clinical routine in the future.

A next-generation sequencing study recently addressed and characterized parts of the clonal architecture in MDS, and subsequent progression to secondary AML<sup>(122)</sup>. More than 90% of BM cells carried clonal somatic mutations at the time of MDS diagnosis, even in subtypes without excess of blasts. The percentage of cells with somatic mutations did not increase significantly with progression from MDS to AML, but the dominant clone did. These results indicate that clonal hematopoiesis is present at an early stage of the disease. In addition, it was found that the dominant secondary-AML clone was derived from a MDS founding clone in all cases, suggesting that therapies targeting these early mutations might be the most effective strategy for eliminating disease-propagating cells and improving the rate of response to chemotherapy for patients with secondary AML<sup>(123, 124)</sup>.

<b>Table 4. Common gene mutations in MDS</b>					
<b>Gene</b>	<b>Chromosome</b>	<b>Frequency</b>	<b>Prognostic impact</b>	<b>Protein function</b>	<b>Ref</b>
<b>Oncogenes and tumor suppressor genes</b>					
RUNX1	21q22	15%	Poor	Transcription factor important in hematopoiesis	95,97, 99
TP53	17p13	5-10%	Poor	Tumor suppressor gene	See appendix
NRAS	1p13.2	7-20%	variable	GTPase, oncogene when mutated	94, 121
KRAS	12p12.1	2-5%	Poor	GTPase, oncogene when mutated	121
ETV6	12p13.2	2-5%	Poor	Transcription factor important in hematopoiesis	104
EVI1	3q26	1-2%	Poor	Transcriptional regulator and oncoprotein involved in hematopoiesis and apoptosis	104
WT1	11p13		Poor		98
<b>Methylation of CpG islands</b>					
TET2	4q24	20%	unclear	Methylation of CpG islands; methylcytosine required for myelopoiesis	100,101, 105,106
IDH1/2	2q33.3 and 15q26.1	5-10%	unknown	regulates TET2 activity	107-110
DNMT3A	2p23.2	5-10%	Poor	DNA methyltransferase	102,111
<b>Histone modification</b>					
ASXL1	20q11.1	10-15%	Poor	Histone binding protein	103
EZ2H	7q36.1	5%	Poor	Histone methyltransferase	112
<b>Spliceosome</b>					
SF3B1	2q33.1	20% in MDS; 65% in MDS-RS	variable	spliceosome protein	115,116, 113
U2AF1	21q22.3	not known	None	spliceosome protein	118
ZRSR2	Xp22.1	not known	None	spliceosome protein	114,115
<b>Others</b>					
JAK2	9p24.1	50% in RARS-T	unknown	Protein tyrosine kinase	
CBL	11q23.3	2-5%	unknown	E3 ubiquitin ligase; negative regulator of transduction in haematopoietic cells	
RPS14	5q33.1	5q- syndrome	unknown	Ribosomal protein of the 40S subunit	
AML-1/ RUNX1	21q22		Poor	Transcription factor, regulates differentiation of hematopoietic cells	95,97,99
NPM-1	5q35		unknown	Cell growth and proliferation, genomic stability	122,123

### 2.4.3. Epigenetics

Epigenetic alterations have profound effects on gene expression and may cause tumor suppressor gene silencing (reviewed in <sup>(125)</sup>). Hypermethylation of genes involved in cell cycle control and apoptosis is commonly observed in MDS progenitors, in particular in high-risk disease <sup>(126)</sup>. Important genes for cell cycle regulation are the cyclin-dependent kinase inhibitors p15 (INK4b) and p16 (INK4b). These two genes are rarely mutated or deleted, but transcription of the p15 gene is often silenced owing to abnormal methylation of its promoter region, and several studies indicate that approximately 50% of MDS show this alteration <sup>(127, 128)</sup>.

In contrast to changes in DNA sequence, silencing of genes by DNA methylation is a reversible process, and the introduction of demethylating agents (e.g. azacitidine and decitabine) in the treatment of high-risk MDS, have yielded encouraging results <sup>(129, 130)</sup>. Moreover, both drugs have shown to slow the progression of MDS to AML, which underlines the suggested role of hypermethylation in the progression of MDS into AML <sup>(131-133)</sup>.

Given the success of these DNA methyltransferase inhibitors in the treatment of MDS, multiple studies have been undertaken to better define the epigenetic landscape of MDS <sup>(125, 133-135)</sup>. However, it is still unclear whether abnormal methylation patterns are driven by somatic mutations that alter the epigenetic state (such as DNMT3A, IDH1/2 and TET2 mutations), or whether epigenetic abnormalities per se are primary drivers of the disease.

### 2.4.4. The role of the immune system

Clinical and laboratory studies suggest that BM failure in MDS may, at least in part, be immune-mediated <sup>(136-138)</sup>. Improvement of hematopoiesis has been seen following treatment with immunosuppressive regimens including anti-thymocyte globulin (ATG) and cyclosporine <sup>(139-144)</sup>. Immunosuppressive therapy appears to be most effective early in the disease course of WHO RA/RCMD <sup>(145)</sup>. Suggested immune-mediated mechanisms include targeting of BM precursors by cytotoxic T lymphocytes or natural killer (NK) cells <sup>(136, 146)</sup>, defects in immune tolerance <sup>(147)</sup>, and the presence of a pro-inflammatory microenvironment in the BM <sup>(148)</sup>.

T cells are thought to play an important role in BM failure in MDS. Recent research suggests that T regulatory cells (Tregs) are involved in the negative control of the

immune response which could promote the immune-mediated damage of normal BM precursors <sup>(149, 150)</sup>. The role of T cells in the process of BM failure may be deduced from the therapy response seen to immunosuppressive agents which mainly target activated T cells <sup>(139, 151, 152)</sup>. Furthermore, the expression of apoptotic molecules and the activation of enzymes involved in apoptosis was shown to be increased in MDS T cells <sup>(153)</sup>. Other studies have reported on an increase in the number of cytotoxic T cells <sup>(137)</sup>, whereas the function of NK cells was found to be significantly reduced in patients with high-risk MDS <sup>(154)</sup>. Moreover, numerical and functional alterations of blood dendritic cells have been described in MDS <sup>(155-157)</sup>. Recently, we showed that bone marrow dendritic cells (DC) were markedly reduced in all subtypes of MDS in comparison to a control group, indicating that the DC compartment may be involved in the pathobiology of MDS <sup>(158)</sup>. Taken together, T-cell and NK-cell defects, decreased functional abilities of neutrophils and antigen-presenting cells, altered antibody and cytokine production appear to play a role in the pathophysiology of MDS.

#### **2.4.5. The bone marrow microenvironment – a disease driver in human MDS?**

Disruption of the BM microarchitecture is a common finding in MDS encompassing altered localization of hematopoietic cells within the BM (“topography”) and alterations in components that comprise the microenvironment. All hematopoietic lineages in MDS may be affected, including megakaryocytopoiesis (i.e. clusters of micromegakaryocytes, paratrabecular localization), granulopoiesis (i.e. clusters of immature precursors, “ALIPs”) and erythropoiesis (expansion or severe reduction). Alterations of the microenvironment include edema, fibrosis, vascular proliferation <sup>(159)</sup>, lymphoid aggregates and inflammatory changes. These findings indicate that MDS is not only a disease of hematopoietic cells but also of the tissue. However, whether these BM stromal changes are an epiphenomenon or a pathogenetically important element of the disease itself remains unclear. It appears that the proliferative advantage and the progressive nature of MDS involve the interaction of hematopoietic stem cells (HSC) with their microenvironment. In human MDS, xenotransplant models using immunodeficient mice have consistently shown poor engraftment of myelodysplastic cells and failure to confer the clinical hematopoietic phenotype of human MDS <sup>(66, 160)</sup>. These observations have sparked the debate about a potentially causative or permissive role of the microenvironment and the question in how far components of the HSC niche

are implicated in MDS <sup>(161-166)</sup>. Several groups have reported that abnormalities in stromal cells can induce MDS (or AML) in otherwise normal bone marrow cells <sup>(167-170)</sup>. Moreover, it was shown that dysfunction of bone progenitor cells can initiate myelodysplasia and leukemia predisposition in mice <sup>(167)</sup>. Taken together, data from different animal models have suggested that cells within the BM microenvironment may have importance for the behaviour of HSC, regulating their maintenance, quiescence, self-renewal and differentiation. On the basis of these studies, a “niche-based” model of leukemogenesis in MDS has been proposed <sup>(170)</sup>.

## 2.5. The “5q- syndrome”

The “5q- syndrome” refers to a unique subtype of MDS and was first described by Van den Berghe et al in 1974 who reported five patients with macrocytic anemia, normal to elevated platelet count, dyserythropoiesis, hypolobulated megakaryocytes and an interstitial deletion of the long arm of chromosome 5 <sup>(171)</sup>.

The presence of del(5q), either in isolation or in combination with additional cytogenetic aberrations, is the most frequently reported cytogenetic abnormality in MDS and is described in up to 15% of cases <sup>(38, 172)</sup>, while the incidence of the 5q- syndrome is much lower <sup>(173)</sup>. In comparison to other subtypes of MDS, the 5q- syndrome is characterized by isolated del(5q), <5% BM blasts, female preponderance and a favorable prognosis with low risk of leukemic transformation. Indeed, the WHO classification of MDS identified the 5q- syndrome as a distinct clinical entity owing to its characteristic clinical and morphological features.

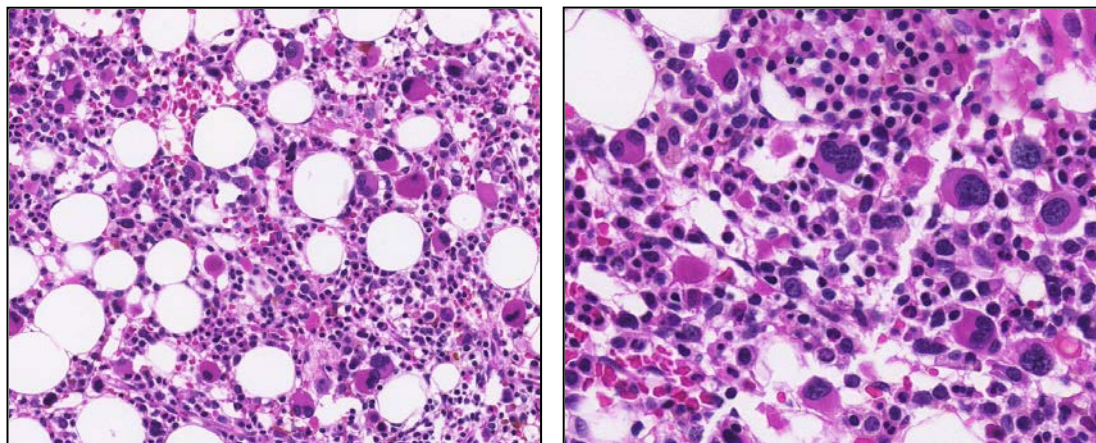

**Figure 6.** BM histology in a patient with classical 5q- syndrome (H&E, 20x/40x objectives).

The 5q- phenotype is believed to be a manifestation of multiple allelic deletions located within a common deleted region (CDR). Initial work by Zhao *et al.* (1997) localized the CDR to a 1–1.5 Mb region on 5q31 in del(5q) patients with MDS and acute myeloid leukemia (AML) <sup>(174)</sup>. Subsequent studies investigated the interstitial deletion on chromosome 5 in patients with the bona fide 5q- syndrome <sup>(175-177)</sup>. The current accepted CDR was elucidated in a study involving sixteen 5q- syndrome patients with del(5q) as the sole karyotypic abnormality <sup>(178)</sup>. Using FISH analysis, the CDR in the 5q- syndrome was delineated to a 1.5 Mb interval located on 5q32 between the D5S413 marker and GLRA1 <sup>(178)</sup>. This region included 44 genes such as phosphodiesterase 6A (PDE6A), CSF1R, CD74 molecule (CD74), Treacher Collins-Franceschetti syndrome 1 (TCOF1), annexin A6 (ANXA6), SPARC and FAT tumor suppressor homolog 2 (FAT2) genes among others.

Subsequent studies aimed at identifying and confirming the tumor suppressor gene associated with 5q- syndrome by global gene expression patterns. Using Affymetrix platform, Pellagatti *et al* (2006) identified unique gene expression signatures and down regulation of genes mapped to the CDR which separated patients with del(5q) from other MDS cases <sup>(148)</sup>. Down-regulated genes encompassed the tumor suppressor gene *SPARC*. Interestingly, only *SPARC* was overexpressed in response to lenalidomide in a previous study from our group <sup>(179)</sup>. However, the hematopoietic profile of 5q- syndrome patients is not reflected in *SPARC* null mice suggesting that it may not be the key gene responsible for the 5q- syndrome phenotype. An important study to further identify candidate genes in the “common deleted region” was undertaken by Boulwood *et al* (2007) who demonstrated that *RBM22* and *CSNK1A1* were the two most significantly downregulated genes in the 5q- syndrome <sup>(180)</sup>. Moreover, the ribosomal gene *RPS14*, mapping to this interval, showed haploinsufficiency in hematopoietic stem cells (HSC) from these patients.

Ebert *et al* demonstrated that haploinsufficiency of *RPS14* plays a critical role in the development of the anemia that characterizes the 5q- syndrome <sup>(181)</sup>. Haploinsufficiency of *RPS14* in normal HSC resulted in a block in erythroid differentiation and forced expression of an *RPS14*cDNA in BM cells from patients with 5q- syndrome “rescued” the phenotype, strongly suggesting that *RPS14* is a “5q- syndrome” gene <sup>(181)</sup>. Pellagatti *et al* found defects in several other genes involved in ribosomal biogenesis <sup>(182)</sup>. The similarity of the genetic mechanism between the 5q- syndrome and other congenital



bone marrow disorders (Diamond-Blackfan anemia, Shwachman-Diamond syndrome) is remarkable and suggests a link between these two conditions.

The recent production of a knockout mouse model displaying a phenotype consistent with 5q- syndrome, in which the CDR was narrowed down to *RPS14* and seven other genes, added to the evidence that *RPS14* is a strong candidate for haploinsufficiency in human 5q- syndrome <sup>(183)</sup>. However, this mouse model does not explain all characteristic features of the 5q- syndrome, as for example thrombocytosis, neutropenia and clonal dominance. Starczynowski *et al.* (2010) evaluated the expression of miRNAs located on chromosome 5q and found lower expression of miR-145 (5q33.1) and miR-146a (5q33.3) in individuals with del(5q) <sup>(184)</sup>. Knockdown of miR-145 and miR-14a together recapitulated some features of the 5q- syndrome, such as increased platelet counts. From these two studies it may be speculated that del(5q) results in thrombocytosis and clonal dominance through reduction of miR-145 and miR-146a levels, whereas the haploinsufficiency of *RPS14* explains the macrocytic anemia. Since the *RPS14* and miR-145 are closely related within the CDR, the combined loss may be sufficient to recapitulate the major features of the 5q- syndrome.

## **2.6. Treatment and predictors of response**

The choice of treatment in MDS is based on clinical symptoms, risk groups and age. Whereas some patients may not require any treatment, others will need supportive care, chemotherapy or be eligible for allogenic stem cell transplantation. The Nordic MDS group has established guidelines for the treatment of MDS which are published at the website [www.nmds.org](http://www.nmds.org). The different treatment options for MDS are as follows:

### **2.6.1. Supportive care**

Supportive care includes red blood cell (RBC) transfusions for symptoms of anemia. The decision for transfusion should be made on an individual basis by the patient and the physician, taking into account co-morbidities and quality of life issues. No definite value for the requirement of RBC transfusions has been defined. Platelet transfusions are recommended in thrombocytopenic patients with moderate or severe bleeding.

Protracted anemia requiring transfusion therapy can be expected in 40–80% of patients <sup>(185)</sup> with secondary iron overload and associated increased morbidity and

mortality<sup>(186)</sup>. Retrospective studies have indicated survival benefit and decreased transfusion requirement in low-risk MDS patients who received adequate chelation therapy<sup>(187-189)</sup>. Although the exact mechanism is not clear yet, improvement of hematopoiesis might be due to a reduction of oxidative stress in hematopoietic progenitors in general and erythropoietic progenitors in particular<sup>(190, 191)</sup>. A recent study demonstrated an iron overload dependent suppression of erythropoiesis in MDS patients and showed that the negative impact of toxic iron on the proliferation of erythroid progenitor cells may be in part reversible<sup>(191)</sup>. There are no studies providing evidence of the effect of iron chelation on long-term outcome in MDS. Transfusion dependent patients with MDS should be treated according to international recommendations as established by a consensus working group on the basis of previous studies<sup>(192-194)</sup>.

Patients with MDS have an increased risk for infections due to neutropenia and this should be treated promptly and with follow-up of outcome. The routine use of prophylactic antibiotic treatment is not recommended as a rule but may be considered if infections start to occur. In addition, treatment with G-CSF can be considered as prophylaxis for severely neutropenic patients with recurring, serious infections or during infectious episodes.

### **2.6.2. Erythropoietin**

Treatment with erythropoietin (Epo) may improve hemoglobin levels and alleviate transfusion need in MDS patient with anemia<sup>(195, 196)</sup>. The effect of Epo may be enhanced by G-CSF<sup>(197-200)</sup>. A large phase 3 prospective randomized trial with prolonged follow-up evaluated the efficacy and long-term safety of erythropoietin (EPO) with or without granulocyte colony-stimulating factor plus supportive care (SC) versus SC alone for the treatment of anemic patients with lower-risk myelodysplastic syndromes<sup>(201)</sup>. The response rates in the EPO versus SC alone arms were 36% versus 9.6%, respectively. No differences were found in OS or in the incidence of transformation to acute myeloid leukemia<sup>(201)</sup>.

Taken together, there is no doubt that a major portion of patients with MDS and symptomatic anemia may have substantial clinical benefit from treatment with hematopoietic cytokines without evidence of enhanced adverse consequences. Patients should be evaluated according to a predictive model including S-erythropoietin and level of transfusion need before a final decision about treatment is made<sup>(202, 203)</sup>.

### **2.6.3. Immunosuppressive therapy**

The current data on immune suppressive therapy (IST) indicate that these drugs, as a class, are effective in a specific subgroup of MDS; younger low-risk MDS with normal karyotype and no ring sideroblasts. In this rare subgroup, 30-50% of patients respond to this treatment <sup>(139, 142, 143, 204-210)</sup>. IST is most effective in the early phase of lower-risk MDS, and HLA-DR 15 positivity, young age and short duration of RBC transfusion dependence seem to predict for treatment response, although this is based on limited material <sup>(211) (145, 212, 213)</sup>. The administration of IST in MDS does not appear to increase the risk of disease progression <sup>(145)</sup>.

### **2.6.4. Azacytidine**

Treatment with demethylating agents (e.g., azacytidine and decitabine) is today first-line treatment in most patients with higher-risk MDS and results in better response rates as compared to supportive care <sup>(129, 214, 215)</sup>. In a recent randomized study that compared Azacytidine treatment with conventional care in patients with high-risk disease, the median survival was 24 months in the Aza-treated patients as compared to 15 months in the conventional-care group and leukemic transformation was delayed <sup>(214)</sup>. Other studies found that the combination of azacitidine and lenalidomide was highly effective and well-tolerated in patients with higher-risk MDS <sup>(216, 217)</sup>. The rationale for this therapy is suggested to rest on the complementary action of these two compounds. Lenalidomide works through inhibition of phosphatase activity in the CDR of chromosome 5 leading to a stabilization of Mdm2 and p53 degradation <sup>(218, 219)</sup>, via the upregulation of mir145 <sup>(220)</sup>, direct cytotoxic mechanisms and through effects on the BM microenvironment, whereas AZA inhibits methyltransferase activity and acts via direct cytotoxicity.

### **2.6.5. Induction chemotherapy**

There is no evidence that AML-like chemotherapy alters the natural history of MDS, i.e. long-term survival is not affected by the treatment. In addition, there are no data to support that high dose chemotherapy with autologous stem cell transplantation is superior to AML-like chemotherapy. AML like chemotherapy may be considered in younger patients with high-risk MDS (IPSS INT-2 or HR) and MDS-AML, prior to allogeneic SCT, and in selected patients not eligible for allogeneic SCT. In elderly

patients with high-risk MDS (IPSS INT-2 or HR) and MDS-AML (<30% blasts), azacytidine is recommended as first choice.

### **2.6.6. Allogeneic stem cell transplantation**

The only curative therapy for MDS is allogeneic stem cell transplantation (SCT) <sup>(221)</sup> <sup>(222-225)</sup> which is first-line therapy for patients with INT-2 and high-risk MDS with an available donor, if age and co-morbidities allow for the risk of the procedure. Since the intensity of transplant conditioning contributes to non-relapse mortality, the development of reduced-intensity conditioning (RIC) regimens and the use of alternative donor sources have allowed for SCT also in older patients. Nevertheless, cumulative mortality rates after SCT are still considerable <sup>(226)</sup>, predominantly due to graft-versus-host disease (GVHD) and relapse. Available data suggest that only one third of older patients experience long-term disease-free survival <sup>(227, 228)</sup>. Therefore, allogeneic HCT in its current form needs to be further developed and improved. With the help of novel molecular markers and improved prognostic scores, patients may be better stratified according to the disease risk and potential benefits of allogeneic HCT.

### **2.6.7. Lenalidomide in del(5q) MDS**

Lenalidomide (len) represents the first targeted therapy for MDS and is approved by the Food and Drug Administration (FDA) for red blood cell (RBC) transfusion dependent patients with lower risk MDS and an interstitial deletion of a segment of the long arm of chromosome 5 (del(5q)). The specific activity in del(5q) MDS was first observed in the MDS-001 study <sup>(229)</sup> in which 12 of 43 low-risk patients had del(5q) and 83% of these responded. The unique activity in lower-risk del(5q) MDS was confirmed in a subsequent MDS-003 study <sup>(230)</sup> which led to the FDA approval. By contrast, EMA did not approve the drug as they could not exclude an association between treatment and leukemic transformation. The randomized double-blind phase III MDS-004 trial aimed to validate the finding from MDS-001 and MDS-003 studies <sup>(231)</sup>; 205 patients were randomized to either 10 mg lenalidomide days 1-21 every 28 days, 5 mg daily, or placebo. The RBC-transfusion independence rate ( $\geq 26$  weeks) was 56%, 42% and 6% for lenalidomide 10 mg, 5 mg and placebo, respectively, with corresponding cytogenetic response rates of 29%, 15% and 0%. Median duration of transfusion independency in the 004 study was approximately two years, and the three year overall

survival and AML risk were 56% and 25%, respectively in the lenalidomide cohorts combined.

Patients with del(5q) MDS and an increase of medullary blasts up to 10% were eligible, as long as they fulfilled the criteria of intermediate-1 risk disease. It was shown that patients with an increased blast count had similar response rates to patients with <5% blasts and consequently, additional attempts to treat patients with del(5q) MDS and  $\geq 5\%$  BM blasts were carried out <sup>(232)</sup>. The first study using the same doses as for lower-risk del(5q) confirmed efficacy also in this population with similar cytogenetic response rate of 67% as for low- and INT-1 risk del(5q) patients, but only in patients with isolated del(5q), while patients with del(5q) + 1 additional abnormality had a response rate of 9% and patients with complex karyotype did not respond at all <sup>(232)</sup>.

The use of lenalidomide in non-del(5q) lower-risk, transfusion dependent MDS was examined in the MDS-002 clinical trial <sup>(233)</sup>. This study had similar inclusion criteria and treatment schedule as the MDS-003 trial apart from the exclusion of patients with a del(5q) cytogenetic abnormality. The study enrolled 214 patients; 40% had RARS, and the majority of patients were low or INT-1 IPSS risk. The overall response rate was 43%, 26% of patients became transfusion-independent and 17% had a  $\geq 50\%$  reduction in transfusion requirements with a median response duration of 41 weeks.

The observed difference in clinical responses between patients with del(5q) and non-del(5q) MDS led to the understanding of a karyotype-specific mechanism of action. In del(5q) MDS, lenalidomide exhibits actions on both the benign and the malignant progenitor population. The ability to induce apoptosis of progenitors harboring the del(5q) abnormality is thought to be linked to the haploinsufficiency of one or several genes on the long arm of chromosome 5. The fact that patients usually achieve TI within 4-5 weeks, before achieving cytogenetic remission, supports the concept of activation of residual normal erythropoiesis. Lenalidomide has also anti-angiogenic and anti-inflammatory properties <sup>(234, 235)</sup>. In non-del(5q) disease, lenalidomide seems to enhance response of erythroid precursors to different stimuli, including erythropoietin. This is supported by the fact that lenalidomide promotes erythroid progenitor formation and expansion in CD34+ cells from healthy donors *in vitro* <sup>(236)</sup>.



selecting MDS patients eligible for EPO/G-CSF treatment <sup>(240)</sup>. In addition, somatic mutations may serve as such biomarkers if they can be shown to consistently predict response to treatment. For example, in a recent phase II study of Len and Aza combination in patients with higher-risk MDS, the presence of TET2, DNMT3A, IDH1 or IDH2 mutations was predictive of complete response, even in the presence of other somatic mutations that ordinarily carry a bad prognosis in MDS <sup>(217)</sup>. In another retrospective study of 86 patients with MDS treated with Aza, the presence of a TET2 mutation was associated with an 82% response rate, compared to a 45% response rate in TET2 wild-type patients <sup>(241)</sup>. Additional studies designed to identify genetic predictors of response to different treatment modalities in both low- and high-risk MDS will be critical for tailoring appropriate therapy to each patient.

### **3. THE TP53 GENE**

#### **3.1. A brief history**

In 1979 several groups reported on a protein (p53) that formed a complex with the SV40 tumor-virus oncoprotein, the large T-antigen <sup>(242, 243)</sup>. The p53 protein was initially considered as tumor antigen, eliciting an antibody response, when transformed mouse cells produced tumors in mice <sup>(244)</sup>. It was postulated that p53 might be a cellular oncogene product linked to the viral transformation process <sup>(243)</sup>. Further studies revealed the p53 protein was involved in viral replication and tumorigenesis by small DNA tumor viruses <sup>(245-247)</sup>. Isolation of p53 DNA clones and the demonstration that many of these cDNAs could transform cells in combination with the Ras oncogene <sup>(248-250)</sup> established p53 as an “oncogene”. Later, it became clear that these transforming DNA clones contained a mutation and that the wild-type DNA in fact was capable of suppressing tumor growth in vivo. Indeed, mutations in both p53 alleles were found in mouse tumors <sup>(251)</sup>, human cell lines <sup>(252)</sup> and in the DNA from human colon cancers <sup>(253)</sup>. In 1990 alterations of p53 were detected in Li-Fraumeni syndrome, a disease characterized by the early onset of cancers <sup>(254)</sup>. Researchers also found that p53 knockout mice were prone to cancer <sup>(255, 256)</sup>. Together, these findings led to the assumption that p53 was the ultimate tumor suppressor gene <sup>(257)</sup>. P53 is now recognized as a pivotal regulatory protein that reacts to a variety of signals and recruits an array of biochemical activities to trigger diverse biological responses, most notably cell-cycle arrest and apoptosis. P53 is also known to be involved in differentiation and

development, DNA repair, DNA replication and transcription, senescence and cell-cycle checkpoints<sup>(258)</sup>.

### 3.2. Structure and Function of p53

The *TP53* gene is located on the short arm of chromosome 17 (17p13), and spans 20 kbases with 11 exons. Its protein is organized into five domains (Figure 8), each corresponding to specific functions: the amino-terminus contains the acidic transactivation domain, the mdm2 protein binding site, and the Highly Conserved Domain I (HCD I); region 40-92 contains repeated proline residues and a second transactivation domain; the central region (101-306) contains the DNA binding domain and is target of 90% of *TP53* mutations found in human cancers; the oligomerization domain (307-355, 4D), the carboxy-terminus of p53 (356-393) and a non-specific DNA binding domain that binds to damaged DNA.

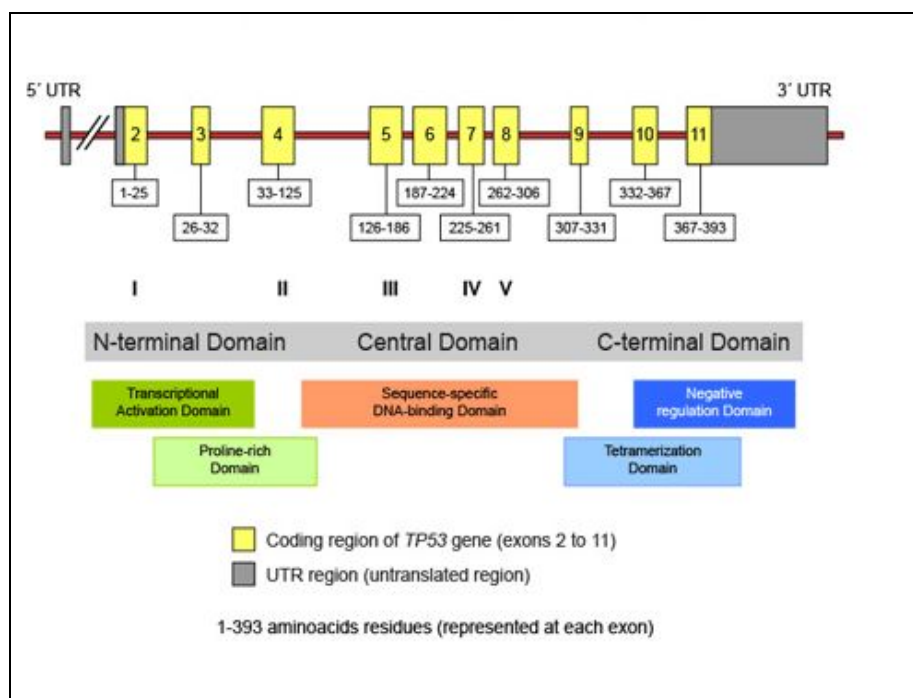

**Figure 8.** Structural organization of the TP53 gene and protein (<http://p53.free.fr>).

The p53 pathway (reviewed in<sup>(259)</sup>) may be divided into five parts: the stress signals that activate the pathway, upstream mediators that detect and interpret those signals, the core regulation of p53 through its interaction with several proteins, downstream events composed of a set of genes and their proteins that are regulated by p53, and final outcome including cell cycle arrest, cellular senescence, apoptosis or DNA



repair. Briefly, under normal cellular conditions p53 is held in an inactive state and maintained at a low level by rapid degradation <sup>(260)</sup>. In response to a range of cellular stresses, including DNA damage, p53 expression is upregulated and acts as a transcription factor for a number of genes that induce cell cycle arrest, apoptosis, senescence or DNA repair <sup>(261-266)</sup>. The discovery of the MDM-2 oncogene, a p53 binding protein and major negative regulator of p53 levels, provided insights in how p53 was regulated by these diverse stress signals <sup>(267-270)</sup>. For instance, p53 may be activated by various perturbations of ribosomal biogenesis including reduced levels of ribosomal proteins <sup>(271)</sup> or by the release of ribosomal proteins from the nucleolus, most notable RPL11, during ribosomal stress <sup>(272)</sup>. The ribosomal proteins then bind MDM2 which leads to the accumulation of p53 protein via inhibition of MDM2 <sup>(273, 274)</sup>. Activated p53 then promotes the transcription of its target genes resulting in p53-dependent cell cycle arrest, senescence, or apoptosis <sup>(275)</sup>. Thus, p53 and MDM2 are linked in an autoregulatory feedback loop in which p53 induces the transcription of MDM2 while MDM2 promotes p53 degradation <sup>(276)</sup>. More recently, p53 was found to counteract the rate of and the efficiency of reprogramming differentiated cells by adding transcription factors into more pluripotent stem cells <sup>(277)</sup>, indicating the influence of the p53 protein on developmental decisions.

The functions of the p53-response genes fall into several categories, including genes involved in cell cycle arrest (p21, 14-3-3 sigma, GADD-45) and intrinsic (bas, noxa, puma) and extrinsic (Fas, DR5) apoptotic pathways.

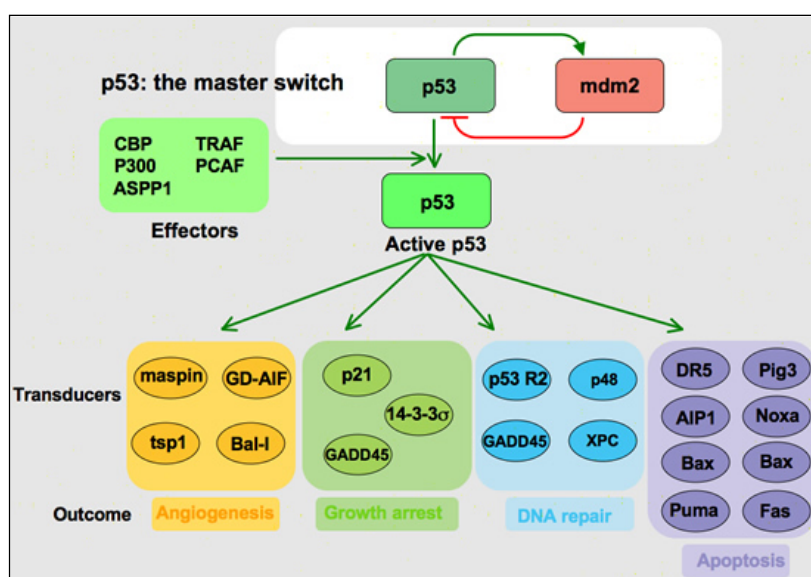

**Figure 9.** The p53 pathway with its core regulation through interaction with proteins that modulate its stability, downstream events and final outcome. (<http://p53.free.fr>)

Several other p53-regulated genes have been implicated in the enhancement of apoptosis, but their mechanisms of action remain to be elucidated. One of the main unanswered questions is how p53 “decides” to trigger the pro-survival or cell death responses. It has been documented that depending on the tissue and cell type, the nature and intensity of the stress signal, and the extent of cellular damage, p53 would favor one response to another<sup>(278-280)</sup>.

### 3.3. TP53 mutations in cancer

Mutations of the *TP53* gene are the most common and most frequently studied molecular alterations in human cancer<sup>(281, 282)</sup>. In hematological malignancies, *TP53* mutations have been reported to occur at frequencies ranging from 5% to 50%<sup>(283, 284)</sup>. Data on mutation prevalence including *TP53* gene variations found in human cancers are compiled in the IARC *TP53* database (<http://www-p53.iarc.fr/>).

Mutations in the *TP53* gene or inactivations of its signaling pathway result in altered and stable p53 proteins that function as dominant negative with “gain-of-function” properties, including drug resistance, and contribution to malignant progression<sup>(256, 285, 286)</sup>. Most mutations occur within the central DNA binding domain (exon 5-8) and, in particular, at specific amino acids required for DNA binding. Inactivation of the p53 gene is essentially due to small mutations (missense and nonsense mutations or insertions/ deletions of several nucleotides), which lead to either expression of a mutant protein (90%) or absence of protein (10%). Thus, *TP53* mutations may confer loss of function whereas others have a dominant negative effect, and still others are classified as wild-type like protein and represent mutant forms with a limited biological effect<sup>(287, 288)</sup>. In addition, various proteins acting upstream of or downstream from p53 in its signaling networks are frequently mutated in human cancers. Indeed, mutational disruption of the p53 network may occur in most aggressive endstage cancers<sup>(289)</sup>.

Inactivation of p53 gene expression by hypermethylation of transcription promoters has not been demonstrated, which supports the hypothesis of a function for p53 mutants. Mutations in the p53 pathway, inherited single-nucleotide polymorphism (SNP) and copy-number variations are continuously uncovered and may add useful clinical information.

### 3.4. Immunohistochemistry

Detection of *TP53* mutation is a complex, relatively expensive method, which currently is difficult to integrate into daily routine practice. In comparison, p53 IHC is a ready available, inexpensive and easy technique used in many pathology laboratories.

Monoclonal antibodies (mAbs) directed against the p53 protein have been invaluable tools for both clinical and basic research. In the area of basic research, these mAbs have permitted detailed studies of the various conformations of the p53 protein. More than 95% of the various mAbs recognize epitopes which are localized in the amino, or (to a lesser extent) in the carboxy terminus of the protein. Table 5 lists commercially available human p53 mAbs out of over 100 anti-p53 mAbs described in the literature<sup>(290-297)</sup>.

<b>Table 5. Human p53 Monoclonal antibodies</b>				
<b>Name</b>	<b>Epitope</b>	<b>Localization</b>	<b>Antigen used for immunization</b>	<b>Reference</b>
DO2	10-16	Amino-terminus	human p53	296, 297
DO7	21-25	Amino-terminus	human p53	
DO1	21-25	Amino-terminus	human p53	
BP53-12	20-25	Amino-terminus	human p53	295, 297
PAb1801	6-55	Amino-terminus	human p53	298, 294
Pab240	213-217	Central region	murine p53	299, 297
HO8.1	306-361	Carboxyterminus	human p53	301
Pab122	371-380	Carboxy-terminus	mouse p53	300
Pab421	371-380	Carboxy-terminus	mouse p53	300, 297

#### Scoring of p53 and Reproducibility

The vast majority of p53 immunohistochemical studies have been performed on epithelial cancers. Immunohistochemical staining for protein expression analysis in formalin-fixed tissue is usually scored manually and semi-quantitatively. However, the lack of uniform scoring systems, failure to use a consistent definition of what constitutes p53 “overexpression” and the use of different protocols for IHC make data from these studies difficult to compare and interpret. In addition, the readout may be

influenced by the type and length of tissue fixation, the age of the fixed tissues and slides before staining, the method of antigen retrieval, and the type of antibody used. Whereas some studies simply used a cut-off of 10% or more for defining p53 positivity, others employed complicated scoring systems, which take into account both the quantity of positive cells, as well as the staining intensity<sup>(298-304)</sup>. One study assessed the interobserver reproducibility by using the 0% cutoff (0% staining vs. any staining), the 10% cut-off ( $\leq 10\%$  nuclear staining vs.  $>10\%$  staining) and a three-category scoring system consisting of 0%, 1-50% and  $>50\%$  staining<sup>(305)</sup>. Excellent agreement was achieved when no positivity (0%) vs any positivity was calculated (light's kappa coefficient  $k=0.831$ ), whereas the three-category scoring system produced the lowest amount of agreement between observers. In another study, p53 expression was simply measured as the percentage of tumor cells with any positive nuclear staining since moderate-to strong staining intensity was observed in a very large fraction of tumor cells, and the inclusion of staining intensity would not have improved performance of the test at the chosen cut-off level<sup>(306)</sup>. The assessment of staining intensity can be problematic as it may be difficult to reproduce and it can vary with different protocols. However, the presence of strong nuclear staining has in several studies been associated with higher tumor grade and aggressiveness<sup>(304, 307, 308)</sup>. By contrast, the presence of weakly positive nuclei (a pattern commonly associated with wild type *TP53*) can serve as internal positive control.

Known *TP53* polymorphisms do not represent gene mutation and most of them are expected to be phenotypically silent<sup>(302, 309)</sup>. However, it is not entirely clear whether *TP53* polymorphisms may or may not result in conformational changes leading to altered immunoreactivity of p53<sup>(310)</sup>.

### **Computer-assisted immunohistochemical scoring**

The introduction of the high-throughput method of tissue microarrays<sup>(311)</sup> has spurred the need for automated image analysis and quantification methods for scoring of stains.<sup>(312-314)</sup> Computer-assisted immunohistochemical scoring could be used as alternative to manual scoring with possible benefits including reproducibility, reliability and time-effectiveness, but are still relatively uncommon in routine laboratory practice<sup>(315, 316)</sup>.

A number of studies have compared manual and computer assisted scoring and found good levels of agreement between both techniques, however, automated image analysis showed higher sensitivity in some studies<sup>(317, 318)</sup>.

## **P53 protein expression as a prognostic marker**

A large number of studies have found p53 overexpression to be a strong prognostic marker in human cancer <sup>(303, 304, 319-329)</sup>, although this result has not been obtained uniformly <sup>(330-333)</sup>. There are a number of possible explanations for these inconsistencies, including small numbers of patients drawn from patient populations with varying treatments and clinical characteristics, the use of different IHC protocols and p53 antibodies, and different scoring criteria.

## **P53 protein expression and TP53 mutation**

Unlike wild-type p53, mutated p53 has a prolonged intracellular half-life and therefore becomes detectable by IHC <sup>(334-336)</sup>. Thus, IHC detection of p53 has been considered a surrogate marker of p53 gene mutation <sup>(335, 337)</sup>. A number of studies have shown a strong correlation between p53 protein expression by IHC and mutation by DNA sequencing <sup>(338-342)</sup>. However, identification of p53 nuclear accumulation in tumor cells in the absence of gene mutation has been noted, indicating alternative mechanisms of acquiring a p53 positive phenotype <sup>(343-345)</sup>. One of the major factors contributing to p53 stabilization is via expression of p14ARF <sup>(346-348)</sup>. Alternatively, inhibition of MDM2-mediated degradation of p53 could block the degradation of p53 protein <sup>(349-351)</sup>. Other possible explanations could be that mutational analysis often evaluates codons 4 through 9, which would identify most, but not all possible mutated loci. In addition, the sample on which mutational analysis is carried out may not be the same used for IHC, and it is conceivable that tumor heterogeneity or the heterogeneity of the population itself could account for discordant findings. The lack of immunohistochemical expression may result from a nonsense mutation leading to formation of a truncated, non-immunoreactive protein. Indeed, tumors with no p53 expression have been shown to have a higher frequency of protein-truncating *TP53* mutations compared with p53-positive tumors <sup>(352, 353)</sup>. This is important to recognize because some studies demonstrated worse prognosis for patients with this finding compared to patients with missense mutations <sup>(354) (355)</sup>. Consequently, p53 IHC detects a large fraction of *TP53* mutations, but not all <sup>(356-358)</sup>. It is therefore not surprising that studies in various human cancers correlating *TP53* gene status and/or p53 overexpression with clinical outcome and response to chemotherapy have reported conflicting results <sup>(300, 326, 357, 359-362)</sup>.

In summary, the use of p53 in clinical practice, as a marker for cancer progression and therapeutic target, calls for a need for validation of IHC <sup>(363, 364)</sup>. In addition, immunohistochemical staining patterns of p53 expression should be correlated with mutational analysis in order to establish practical cut-offs for different tumor types and tissues which can be used to infer the presence of a *TP53* mutation.

### 3.5. Targeting p53 in the clinic

The high frequency of *TP53* mutations in human tumors and the often observed increased resistance of mutant p53-expressing tumors to conventional chemotherapy makes mutant p53 an attractive target for novel cancer therapy <sup>(365)</sup>. In addition, there are a number of studies demonstrating that the type and position of a p53 mutation in the DNA binding domains of the p53 gene in cancers has prognostic value <sup>(286)</sup>. Drugs that act preferentially on cells with certain *TP53* missense mutations have been identified and represent a new approach for treatment. An animal model showed the reactivation of wild-type p53 to result in efficient tumor regression, including regression of lymphoma <sup>(366, 367)</sup> and liver carcinoma <sup>(368)</sup>. There is a class of small molecules that reactivate the wild-type functions of mutant p53 <sup>(369)</sup>. Bykov et al. identified PRIMA-1 and the structural analog PRIMA-1Met, also named APR-246 <sup>(370, 371)</sup>. These compounds restore wild type conformation to mutant p53 and have shown to inhibit tumor growth in a mutant p53-dependent manner <sup>(372)</sup>.

PRIMA-1 and PRIMA-1Met/APR-246 induce p53 targets such as p21, MDM2, Bax, Noxa, Puma, 14-3-3, GADD45, and PIDD according to several studies <sup>(373-375)</sup>, and have been tested in primary leukemic cells from AML and CLL patients <sup>(376, 377)</sup>, and in a recent phase I clinical trial in patients with hematological malignancies and prostate cancer <sup>(378)</sup>.

Many tumors, even those without *TP53* mutations, overexpress MDM2, making targeting of MDM2 for p53 stabilization another promising approach for cancer therapy. For example, the nutlins are compounds that act as antagonists of the MDM2-p53 interaction. Analysis of the crystal structure showed that nutlin binds in the pocket of MDM2 to prevent the p53-MDM2 interaction. Nutlin can activate the p53 pathway, thereby inducing cancer cells and xenograft tumors in mice to undergo cell cycle arrest, apoptosis, and growth inhibition <sup>(379, 380)</sup>. Issaeva *et al.* screened a chemical library and found the small molecule RITA (reactivation of p53 and

induction of tumor cell apoptosis), which binds to p53 and inhibits the p53-MDM2 interaction both in vitro and in vivo <sup>(381)</sup>. RITA induced apoptosis in various cancer cells that retained wild type p53. It was also found that p53 released from MDM2 by RITA promotes p21 and hnRNP K (a p53 cofactor), implying that p21 plays a major role in regulating the cancer cell fate after p53 reactivation <sup>(382)</sup>. Recent reports have shown that p53 regulates the process of self-renewal of neural stem cells <sup>(383)</sup> and hematopoietic stem cells <sup>(80)</sup>.

In view of the cancer stem model, proposing that tumors are maintained by a small population of cancer stem cells that can divide both symmetrically and asymmetrically, further investigation of the link between the p53 function and cancer stem cells may therefore be one of the most important research fields for new paradigms in cancer therapy.

## **4. THE TP53 PATHWAY IN DEL(5Q) MDS**

### **4. 1. Activation of the TP53 pathway**

Several studies have demonstrated an important pathophysiologic role for p53 in the 5q- syndrome where haploinsufficiency of the RPS14 ribosomal protein appears to drive the anemia of this disease <sup>(181, 183, 384)</sup>. It was shown by several groups that BM progenitor cells in 5q- patients show an accumulation of p53 protein reflecting increased apoptosis <sup>(92, 183, 218)</sup>. Using mouse models, it was demonstrated that the progenitor cell defect in “5q- mouse” was rescued by crossing them with p53 deficient mice <sup>(183)</sup>. This important finding was supported also by studies in human 5q- syndrome <sup>(92)</sup>, and suggested that a p53 dependent mechanism underlies the pathophysiology of the 5q- syndrome. By using gene expression profiling, it was shown that ten genes in the p53 pathway (*FAS*, *CD82*, *WIG1*, *CASP3*, *SESN3*, *TNFRSF10B*, *MDM4*, *BAX*, *DDB2* and *BID*) were significantly deregulated <sup>(92)</sup>. All these genes (with the exception of MDM4, a negative regulator of p53) were expressed at higher levels in the 5q- syndrome compared to healthy controls. Moreover, 5 of the 8 most significantly up-regulated known genes in 5q syndrome are p53 targets, including WIG1 and BAX 8.

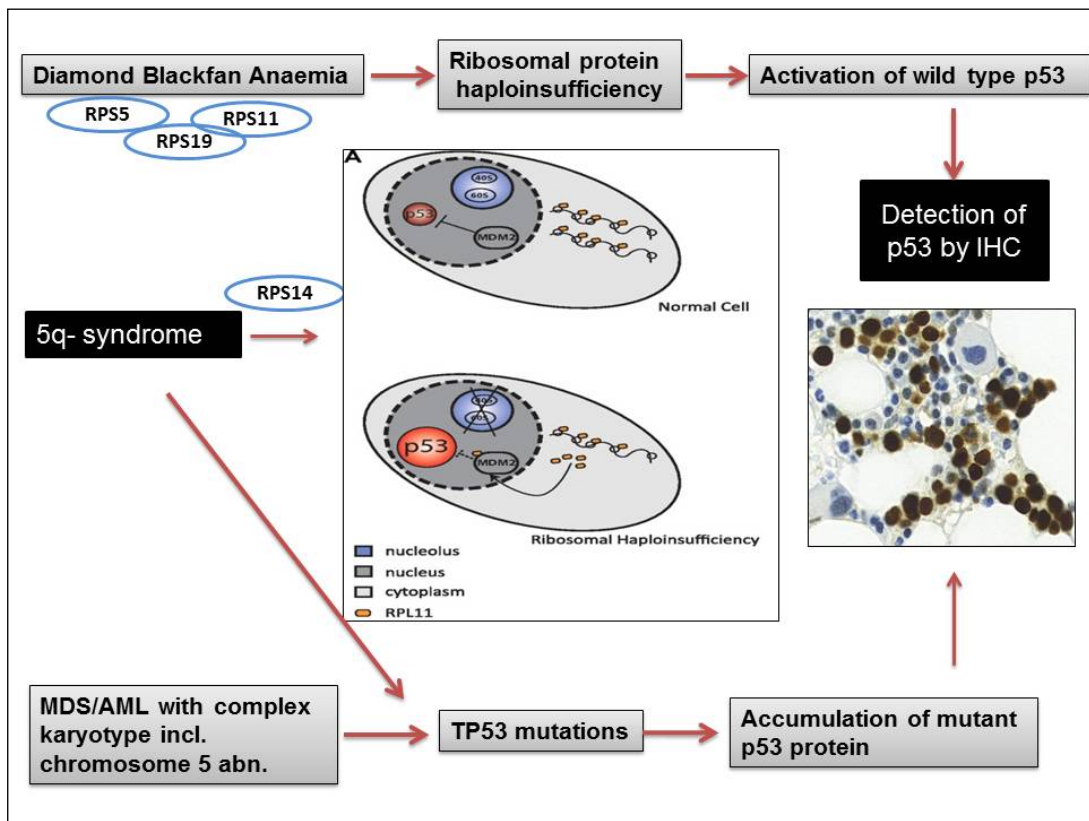

**Figure 10.** Activation of the TP53 pathway by haploinsufficiency of the RPS14 ribosomal protein or TP53 mutation in del(5q) MDS – both resulting in p53 protein accumulation.

In another recent study, it was shown that p53 activation occurred selectively in erythroid progenitor cells resulting in the accumulation of p53 protein in erythroid precursors, cell cycle arrest and apoptosis<sup>(384)</sup>. Moreover, pharmacologic inhibition of p53 by the p53 inhibitor PFT-alpha rescued the erythroid defect. In comparison, Xu et al found that by treating NHD13(+) Tg MDS mice with the p53 inhibitor Pifithrin-alpha (PFT), the myeloid and lymphoid lineage differentiation defects were partially rescued, however with only temporarily improvement of hematopoiesis<sup>(385)</sup>. Instead, chronic deficiency in p53 function accelerated ineffective hematopoiesis and progression to AML indicating that rather than blocking p53 function, promoting its function, or triggering its downstream effects, may help eliminate MDS clones. The findings are significant since they indicate that patients may benefit from pharmacological manipulation of the p53 pathway - in one way or the other.

A recent study by Zhao et al (2010) showed that loss of p53 in myeloid progenitor cells established aberrant self-renewal, paving the way for AML development<sup>(386)</sup>. Although it could not be ruled out that additional functions of p53 contributed to tumor suppression in this context, the de novo acquisition of self-renewal in cells that



normally lack this capability could be a key function of p53 mutations in MDS and AML. Accordingly, loss of p53 might contribute to the formation of leukemia-initiating cells, which by definition have maintained or reacquired the capacity for indefinite self-renewal through accumulated mutations and/or epigenetic changes<sup>(387)</sup>. These cells have properties reminiscent of cancer stem cells, which are considered to be inherently more aggressive and refractory to chemotherapy<sup>(388, 389)</sup>.

Thus, p53 plays a pivotal role in the development and progression of del(5q) MDS including both p53 wild type activation - leading to increased apoptosis and defective erythropoiesis – and *TP53* mutation.

## 4.2. TP53 mutations

*TP53* mutations occur primarily in high-risk/therapy related MDS, MDS-derived leukemia and in context of complex chromosomal abnormalities including del(17p)<sup>(390-403)</sup>. These studies reported also on the poor prognostic impact of *TP53* mutations and the association with poor therapy response. The Appendix (11.) lists references from a literature review. *TP53* mutations in lower-risk MDS are only rarely reported in these previous studies<sup>(400, 404)</sup>, which may be explained by the use of conventional sequencing techniques with a lower sensitivity level but also that fewer studies investigated *TP53* mutations in this subgroup of MDS patients. The development of deep-sequencing has made it possible to screen for mutations at greater depth. Interestingly, a high frequency of chromosome 5 and 7 abnormalities was found in patients with *TP53* mutations<sup>(395, 399, 403, 405, 406)</sup>. Some studies assessed both *TP53* mutation status and p53 by IHC<sup>(335, 404, 407)</sup> with generally good concordance between the two methods. Lepelley et al compared the value of immunocytochemistry on blood and BM slides with Sanger mutation analysis and found that immunocytochemistry allowed detection of mutation in a smaller percentage of cells<sup>(335)</sup>.

Recently, Machado-Neto et al investigated the frequency of MDM2 SNP309 and *TP53* Arg72Pro polymorphisms in de novo MDS and the association of these polymorphisms with clinical characteristics. It was shown that the frequencies of genotypes for MDM2 SNP309 and *TP53* Arg72Pro did not differ between MDS and healthy controls, and were not associated with clinical and laboratory parameters, disease progression and overall survival. This suggests that MDM2 and *TP53* polymorphisms are not involved in the pathogenesis or in the clinical and laboratory characteristics of MDS<sup>(408)</sup>.

## 5. AIMS OF THE THESIS

The purpose of this thesis was to study the role of *TP53* mutations in myelodysplastic syndromes with a deletion of chromosome arm 5q.

Specific aims were:

- I. To assess p53 protein expression as a marker for outcome in lower-risk del(5q) MDS
- II. To investigate the correlation between p53 expression measured by immunohistochemistry and *TP53* mutation
- III. To assess the impact of p53 protein expression in bone marrow cells on treatment response to lenalidomide
- IV. To determine the effect of lenalidomide monotherapy in higher-risk MDS and AML with del(5q) abnormality in relation to molecular markers

## 6. MATERIALS AND METHODS

Paper I was a hypothesis-generating case observation, which was followed by two subsequent studies including 55 and 85 low-/INT-1 risk del(5q) MDS patients, respectively. Paper III was a prospective phase II multicenter trial which enrolled 28 patients with high-risk MDS and AML from three participating countries within the Nordic MDS group.

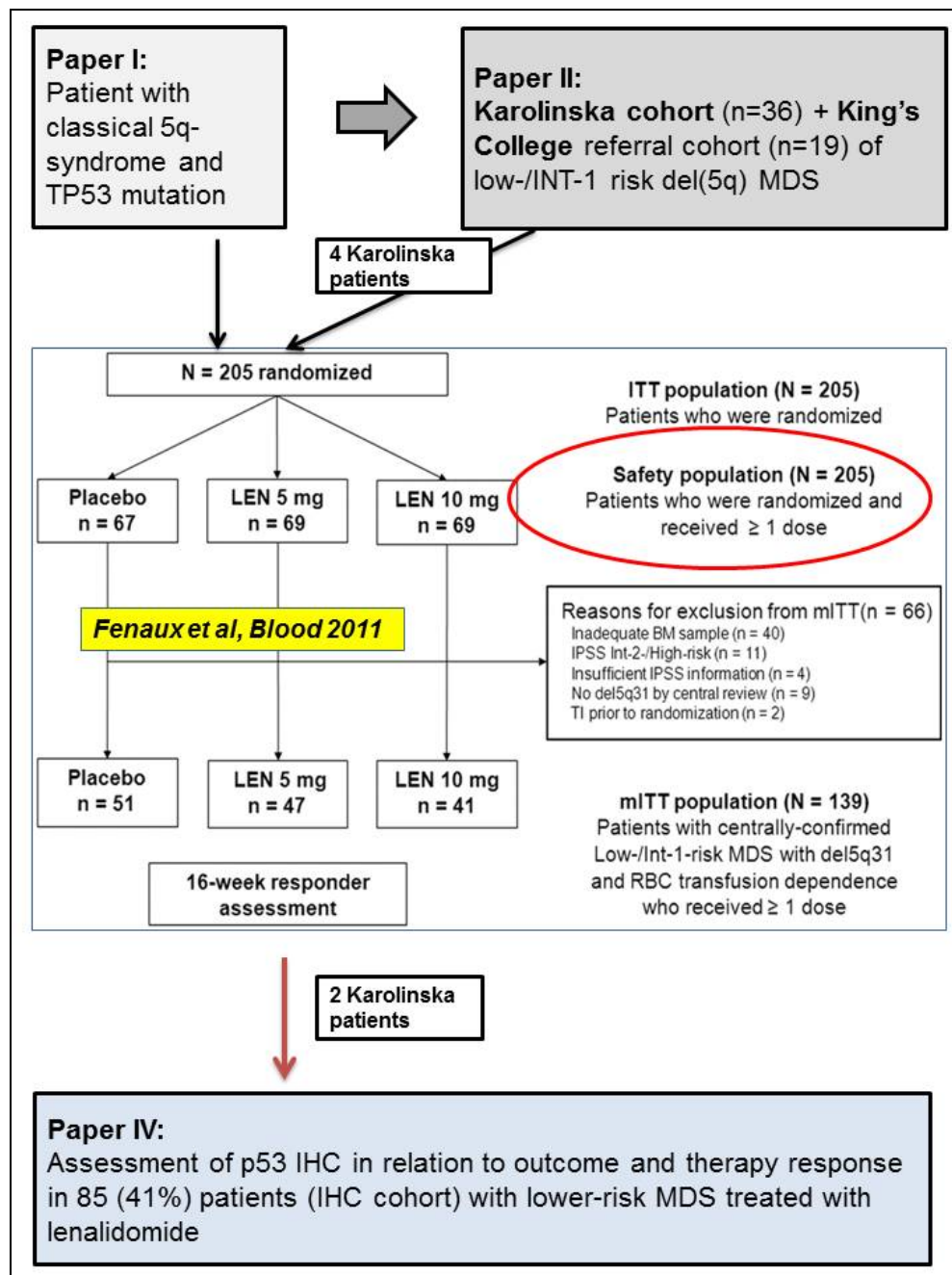

## 6.1. Paper I, II and IV

Paper I describes the clinical course of a patient with classical 5q- syndrome who, after complete erythroid and partial CyR to lenalidomide, evolved to high-risk MDS with complex karyotype after 22 months from start of treatment. The clinical course of this patient was unexpected, however cases with similar features have been observed by us and others (personal communication and ref. <sup>(409)</sup>) which raised the question whether “good-risk” del(5q) MDS really represented a uniform subgroup as proposed by the WHO classification. We therefore aimed to identify additional markers beyond established risk score parameters, which may have contributed to disease progression in this patient. We reviewed BM and PB samples from the entire clinical course and performed IHC. Cytogenetic and molecular studies included chromosome banding analysis and FISH using probes for the locus 5q31, the MLL-locus (11q23), RB1-locus (13q14), *TP53*-locus (17p13), *bcl2*-locus (18q21), and AML1-locus (21q22). CD34+ progenitors were selected from BM mononuclear cells and gene expression profiling analysis was performed as previously described <sup>(148, 179)</sup>. *TP53* mutation analysis was performed by polymerase chain reaction (PCR) using published primer sequences.

In a subsequent study (Paper II), we investigated the frequency of *TP53* mutations in a cohort of 55 patients with low-/INT-1 risk del(5q) MDS (Manuscript p. 1974, Table 1). All patients were risk-classified (IPSS/WPSS) and followed until February 2010 for survival, disease progression, and treatment. BM samples (n=148) were reviewed and stained for p53. *TP53* mutations were analyzed from DNA isolated from archived BM smears (n=89) or BM Ficoll-separated mononuclear cells (n=16) using the Roche GS FLX sequencing platform (Roche, Indianapolis, IN).

The primary objective in paper IV was to validate p53 IHC as an independent prognostic marker for outcome in MDS as indicated by previous findings (Paper I and II). This was a retrospective correlative study for which 131 FFPE BM trephines were retrieved from 85 of the 205 patients (IHC cohort), who had been enrolled in the recently published, phase III randomized, double-blind MDS004 clinical trial <sup>(231)</sup>.

The BM biopsies were assessed in a blinded fashion for the percentage of p53 staining cells, and the intensity of p53 nuclear staining was graded as 0 (negative), 1+ (weakly positive), 2+ (moderately positive) and 3+ (strongly positive). A computerized automated imaging system was used to measure p53 positive stained nuclei/total scanner cell count for comparison with manual counts.

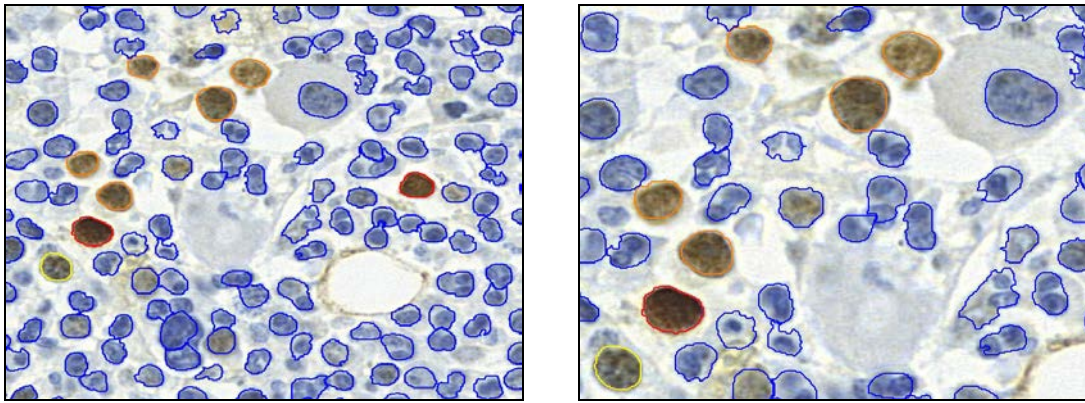

**Figure 11.** p53 score by automated image analysis; strong (red circle, 3+), moderate (orange circle, 2+), weak (yellow circle, 1+), negative nuclear staining (blue circle, 0)

*TP53* deep-sequencing mutation analysis was possible only in a subset of nine (11%) consenting patients using DNA from FFPE BM tissue. Laser-assisted microdissection of p53 immunolabeled cells was performed to study the relation between protein expression and *TP53* mutation by pyrosequencing analysis.

## 6.2. Paper III

This prospective phase II multicenter trial enrolled 28 patients with high-risk MDS and AML with chromosome 5 abnormalities who were not eligible for standard therapy (Manuscript p. 966, Table 1). The majority of patients had failed 1 or 2 previous lines of therapy. The patients were treated with increasing doses lenalidomide to a maximum dose of 30 mg daily. The total study period was 16 weeks. Three patients had isolated del(5q), six had del(5q) plus one additional aberration, 14 had del(5q) as part of a complex karyotype, four had monosomy 5, and one had del(5q) identified by FISH only. The main objective of the trial was to study the efficacy of len to inhibit the tumor clone containing del(5q) or monosomy 5. Primary endpoint was major CyR (assessed by FISH) after 16 weeks treatment. Secondary objectives were safety of increasing doses of len, other hematologic responses and the predictive value of a series of biomarkers for response to treatment. BM histology and cytological preparations from BM and PB were centrally reviewed at inclusion and week 16; IHC was performed on all samples. Genetic markers were assessed including the WT1 transcript and *P21* expression in relation to *P53* mutational status (exons 5-9). FISH analysis was used to establish the baseline percentage of del(5q) cells.

## 7. RESULTS AND DISCUSSION

### 7.1. Paper I, II and IV

The clinical course with results from serial BM assessment and *TP53* mutation analysis of the patient described in Paper I is shown in Figure 12A. In the same manner, we assessed the association between p53 IHC, *TP53* mutation and outcome in three other patients who were enrolled in the MDS004 clinical trial (Figures 12 B-D). Briefly, two patients (A and B) had small *TP53* mutated subclones already at initial diagnosis which remained initially stable but increased as the patients progressed to high-risk MDS. The *TP53* mutation was reflected by the presence of BM progenitors with strong p53 staining at the corresponding time points. The other two patients (C and D) acquired *TP53* mutations at 52 and 75 months, respectively, associated with an increase in p53 by IHC. The acquisition of *TP53* mutations was associated with rapid disease progression.

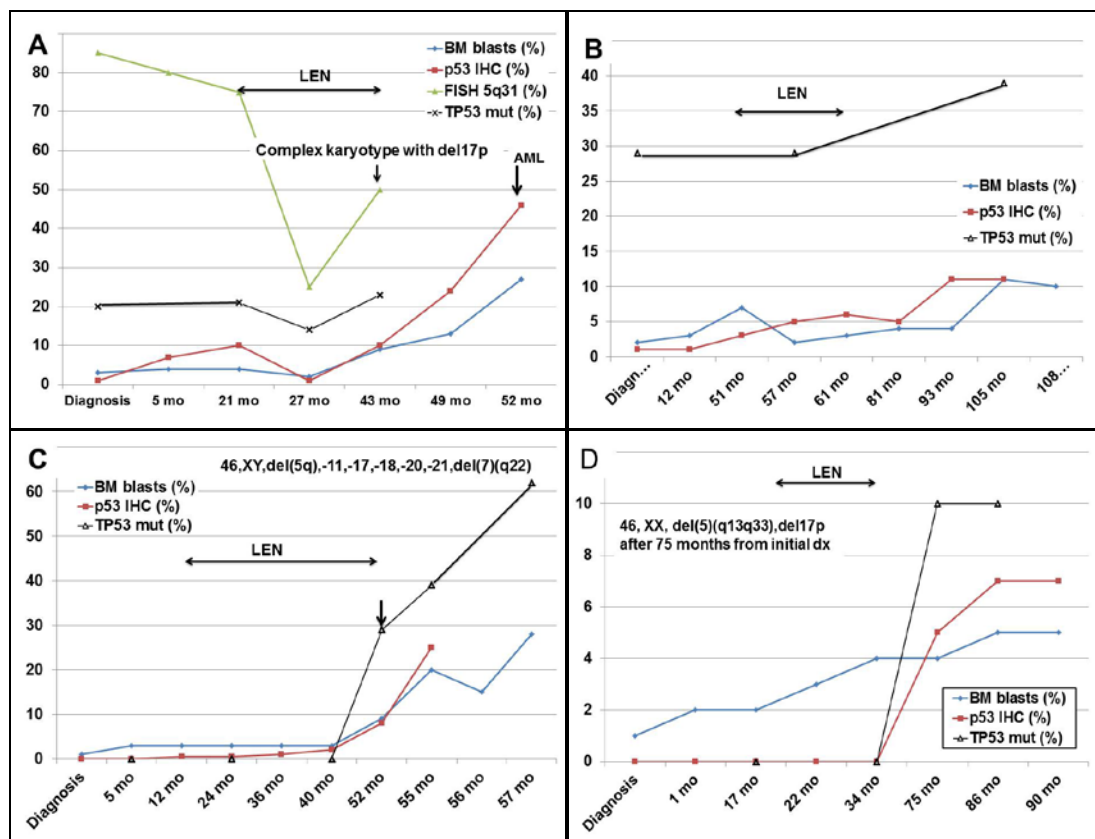

**Figure 12.** Clinical course of four patients with classical 5q- syndrome and *TP53* mutations

Serial BM samples were then assessed in a subset of 21 patients (25%) from the IHC cohort (Paper IV). At the scheduled 12 week's assessment, an increase in p53 expression was seen in eight patients which was associated with cytogenetic evolution, increased AML risk ( $p < 0.01$ ) and shorter OS ( $p = 0.0005$ ) compared to patients who remained negative for p53.

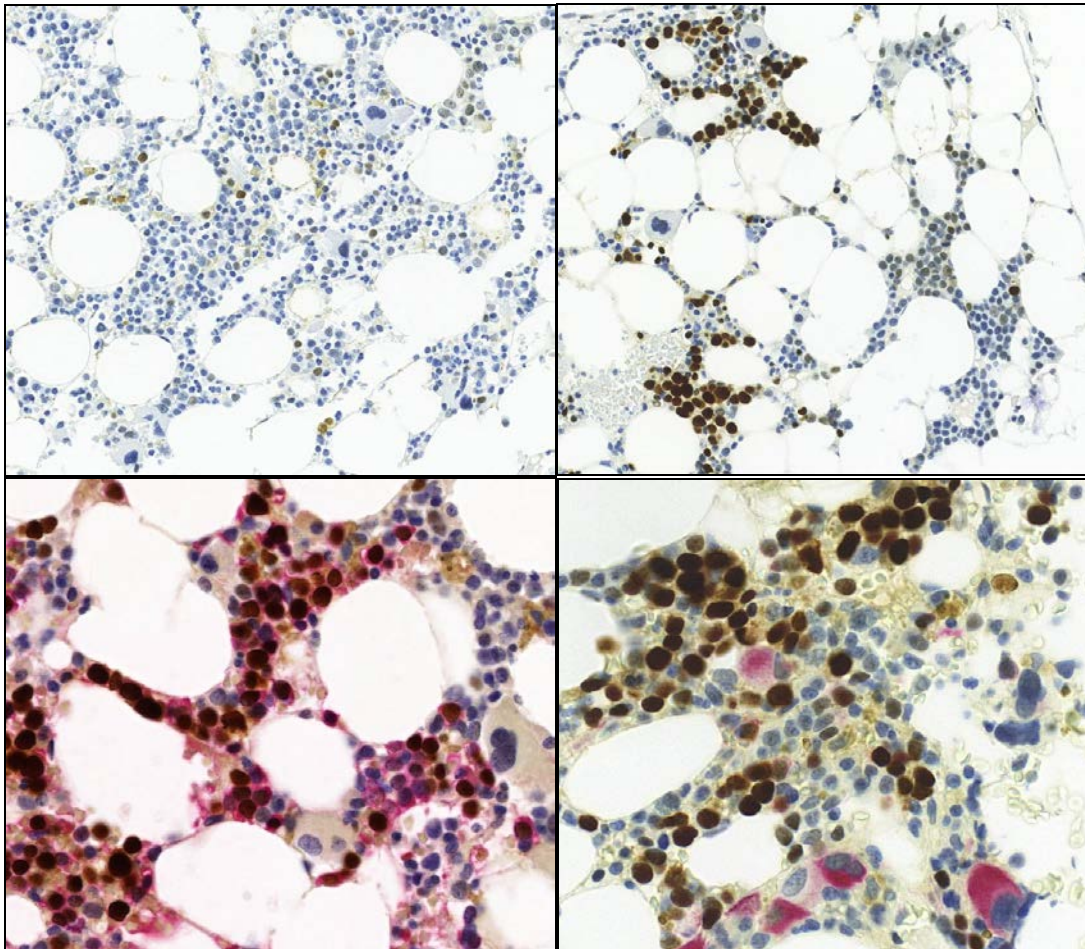

**Figure 13.** p53 stain at diagnosis (upper left) and follow-up (upper right) in a patient with cytogenetic evolution after 12 months from randomization date (20x objective). Cells with strong nuclear p53 expression are positive for Hemoglobin (lower left) and mostly negative for CD34; aberrant CD34 expression in megakaryocytes (lower right).

Single cell laser-microdissection of p53-immunolabeled cells was performed to study the relation between strong p53 protein expression and mutation. Indeed, the mutant allelic burden in micro-dissected cells with strong p53 staining was around 45% indicating that 90% of the cells carried the mutation (Manuscript, Figure 1). By contrast, cells from the same sample with moderate (2+) p53 staining were predominantly wild-type *TP53* (allelic burden around 16%).

*TP53* deep sequencing analysis detected mutations in 10 of 55 (18%) (Paper II) and in 3 of 9 evaluable patients (Paper IV). Nine of 10 patients with *TP53* mutation had  $\geq 2\%$  of p53 strong cells, and all four patients with  $\geq 5\%$  p53 were mutated. By comparison, 2 of 3 patients with *TP53* mutation had strong p53 expression ( $< 2\%$ ) while the other patient carried a K291 nonsense mutation and was negative by IHC, as expected.

The presence of a *TP53* mutation was significantly associated with outcome (Paper II, p.1977, Figure 2). In addition, we found a strong correlation between p53 protein expression by IHC and outcome using both  $\geq 1\%$  and  $\geq 2\%$  cut-off levels (Manuscript, Paper IV).

In summary, we were first to show that *TP53* mutated subclones occur in a subset of lower-risk MDS with isolated del(5q), and that these may be an important driver of leukemic transformation. A recent study described *TP53* mutation at a similar frequency in this subgroup of patients<sup>(410)</sup>. Another study found that *TP53* mutations occurred exclusively in MDS (and AML) with an associated del(5q) but not in other MDS subtypes<sup>(406)</sup> which is in line with previous observations in higher-risk MDS (see Appendix). Moreover, *TP53* mutations and strong p53 protein expression predict for shorter survival, higher risk for AML transformation, and a lower CyR in lower-risk MDS treated with lenalidomide. We demonstrate that IHC can identify small populations of *TP53* mutated cells and assessment of p53 protein expression should therefore be integrated in the routine diagnostic work- and follow-up of MDS patients. Finally, the *TP53* mutation status should be included in current risk assessment systems of MDS patients.

## **7.2. Paper III**

The study was closed after enrollment of 28 patients and the approval of azacytidine by the EMA as first line treatment for high-risk MDS. The overall response rates in this cohort with extremely advanced disease was 20% (3/15) in AML and 36% (4/11) in MDS, respectively. All responders completed 16 weeks of treatment. The median OS time for the whole cohort was 5.6 months (range, 0.4-30.9+ months), while it was 19.0 months (range, 4.8-30.9+ months) in responding patients. This response rate was encouraging considering the risk profile of the cohort.

Paraffin blocks were available for 24 patients at inclusion; strong p53 expression was seen in 15/24 (62%) patients before treatment start. The percentage of cells with



strong p53 expression was 1-2% in five patients and >10% in the other ten patients. A cut-off of 10% was therefore used when comparing IHC results and *TP53* mutational status. In six of the nine patients who responded to treatment, p53 protein expression was absent or low. *TP53* mutations were detected in 15 of 24 (62.5%) patients. The results of p53 by IHC correlated well with *TP53* mutational status: 12/15 patients with a mutation had  $\geq 10\%$  p53 staining cells by IHC; two patients had a frame shift mutation leading to a premature stop codon and were negative by IHC and one patient had a G266V mutation. The *TP53* mutational status was significantly associated with treatment response ( $p=0.047$ ).

In this study, we showed that monotherapy with higher doses of lenalidomide than conventionally used for low-risk del(5q) MDS was able to inhibit the del(5q)- clone in patients with extremely advanced del(5q) MDS or AML. This indicates that lenalidomide given upfront together with azacytidine or induction chemotherapy could potentially lead to higher response rates. In a recent phase 1 and subsequent phase 2 clinical trial of azacitidine in combination with lenalidomide in patients with higher-risk MDS the combination therapy was well-tolerated with sustained therapy responses<sup>(216, 217)</sup>.

Our study is presently followed-up by a multicentre open randomized phase II study comparing the efficacy and safety of azacitidine alone or in combination with lenalidomide in high-risk myeloid disease (high-risk MDS and AML) with a karyotype including del(5q) (NMDSG10B study).

## 8. CONCLUSIONS

- *TP53* mutations occur at an early stage in approximately one fifth of lower-risk MDS patients with deletion of chromosome arm 5q
- *TP53* mutations are significantly associated with shorter OS, higher AML risk and failure to cytogenetic response to lenalidomide
- Strong p53 protein expression by IHC is an independent prognostic marker and associated with poor cytogenetic response but not with transfusion independency in patients treated with lenalidomide
- Strong p53 protein expression is a sensitive biomarker for disease progression and cytogenetic evolution and should be integrated in the diagnostic work up and follow-up of all lower-risk del(5q) MDS
- Strong p53 protein expression reflects *TP53* mutation while moderate staining predominantly reflects wild-type *TP53*
- Monotherapy with higher doses of lenalidomide can inhibit the del(5q)- clone in advanced MDS or AML and a karyotype involving deletion of 5q

## 9. FUTURE PERSPECTIVES

The findings presented in these thesis, in particular the role of *TP53* mutations and IHC for p53 in lower-risk del(5q) MDS, has already generated significant response among clinical hematologists due to their potential impact on current risk stratification and choice of treatment for this so called “low-risk” MDS subgroup.

The survival curve of *TP53* mutated patients is comparable to that of INT-2 risk MDS, and the question is how *TP53* status will influence risk stratification in the future. In light of the ongoing discussion regarding the approval of lenalidomide (len) by the European Medical Association (EMA), our findings have generated interest also outside the clinical setting. Therefore, an Advisory board meeting with experts in the field took place in March 2013 in Paris with the aim to further develop strategies for validating the role of *TP53* mutations and the use of IHC as a biomarker for mutations in lower-risk MDS. There was an agreement that *TP53* mutations and p53 IHC are independent prognostic markers for outcome in del(5q) MDS. However, it has to be further investigated to what extent this can be used as a basis for clinical decision making and choice of optimal therapeutic strategy. To further proceed in this effort and to define the role of len in both mutated and unmutated patients, an international, multicenter prospective, diagnostic study on behalf of the Advisory Board will be conducted with the aim to assess different methods for p53 protein detection in correlation with mutational analysis for *TP53*.

In addition, the role of wild type *TP53* and mutant *TP53* as a key regulator of hematopoietic stem cell (HSC) behavior in terms of HSC quiescence, self-renewal, and apoptosis should be further studied in context of del(5q) MDS. A beneficial effect of lenalidomide in patients with 5q- syndrome has been demonstrated in both lower- and higher risk del(5q) MDS. However, len does not eradicate the del(5q) stem cells, possibly because HSC are typically dormant, arrested by non-p53 dependent mechanisms. Moreover, the suggested mechanism of action of lenalidomide in del5q MDS may be hampered by the presence of *TP53* mutations. Thus, future research needs to address therapy resistance or failure in this group of patients; p53 could be a potential target in this setting. The use of lenalidomide in del(5q) higher risk MDS and AML needs to be further studied and optimized. A combination study with chemotherapy is ongoing in the Nordic countries (NMDSG10B clinical trial) including the assessment of p53 IHC and mutation status.



## 10. ACKNOWLEDGEMENTS

I would like to express my sincere gratitude to everyone who contributed to this thesis and who supported me during my research studies, in particular to:

**Eva Hellström-Lindberg**, for being my supervisor, for introducing me to the MDS community and including me in your research team, for sharing your clinical experience and teaching me the way of scientific thinking, for inviting me to actively participate in national and international meetings, hereby increasing my knowledge and experience as a researcher and clinician, for your genuine interest and engagement and for always providing feed-back. Finally, for trusting and believing in me.

**Anna Porwit**, co-supervisor and clinical tutor, for teaching me clinical hemato-pathology and for encouraging me to initiate research studies, for your great support and personal engagement. I am extremely grateful for the many years we have been working together and hope that we will continue to do so even across the Atlantic.

**Catharina Larsson**, my research mentor, for providing help and precious advice during the course of my PhD studies whenever needed.

**The Karolinska Institute**, and in particular the **Institution of Medicine, Huddinge** and the **Institution of Oncology and Pathology, Solna**. I feel grateful and proud for having had the opportunity to perform research studies at this Medical University which also enabled me to participate in a large number of fantastic research courses some of which I would like to take twice if I had the opportunity.

I wish to thank the above named Institutions at KI for excellent organization and student care, and in particular, **Jan Bolinder**, head of the **Department of Medicine, Karolinska Institute, Huddinge**, for creating excellent opportunities for research.

All the members of the **Nordic MDS Group** – a large family of people who share the same interest - I am grateful to be member of this group.

The Research Team at **HERM** (Professor Hellström-Lindberg's Group), in particular: **Monika Jansson**, technician and laboratory chef at HERM, for your personal engagement, your interest in my work, your assistance in many practical issues, for making me feel "welcome" at the research laboratory. **Lars Möllgård** for great cooperation – both clinically and in our research projects; **Mohsen Karimi**, for your contribution to my last project. **Martin Jädersten**, for in many ways playing a central role in my research project, for your assistance, great cooperation and good advice. Finally, **Christian, Simona, Magnus, Edda, Teresa, Marios, Gunilla, Asmaa, Anette**, and all other people working at HERM for showing interest in my work and many interesting discussions.

**The Karolinska University Hospital** and the **Department of Clinical Pathology**, in particular **Mikael Björnstedt**, head of the Department, and **Birgitta Sundelin von Feilitzen**, head of the Department of Clinical Pathology, Solna, for supporting my research studies and for providing the frame to combine these with clinical work.

All my colleagues at the **Department of Pathology & cytology** and **the whole team at the Division of Hematopathology, Molecular Pathology and Immunohistochemistry**, Karolinska Hospital, Solna – it has been great working with you all! I would like to thank in particular: **Semra, Sabina, Terese, Hanna, Erika** and **Ann** for processing hundreds of bone marrow biopsies; **Mehran, Johanna** and **Ken** for great discussions and assistance with molecular analyses. **Elisabet Björklund** for your cooperation and contribution to the dendritic cell project. My colleague **Anna Kwiecinska** for your hard work during my absence from clinical diagnostics; I highly esteem your loyalty and professional attitude. **Åke Öst**, for your great cooperation and support at our laboratory for many years.

My colleagues at the **Department of Pathology, Huddinge**, in particular **Birgitta Sander** and **Birger Christensson** for sharing interest in my research work and also for our great cooperation.

My colleagues from the **Department of Pathology and Experimental Cancer Research, Semmelweis University, Budapest: András Matolcsy** (head of the department), **Judit, Agotá** and **Botond**. Thank you for all your support!

My clinical colleagues at the **Department of Hematology**, Solna and at **Astrid Lindgren Children's Hospital** for great cooperation. It has been a pleasure for me working with you over the years.

**Rose-Marie Amini**, for being my friend and colleague for many years.

**Christer Sundström**, for offering me my first employment and hereby giving me the chance to continue my training in clinical pathology in Sweden. I am thankful for these first years in Uppsala which I have always kept in precious mind.

My parents, **Karla and Horst Lochhaas**, for your love, care, support and encouragement in many different ways over the years and until today.

Finally, my husband, **Tobias**, for your love, friendship and support.  
*"Ist ein Traum, kann nicht wirklich sein, dass wir zwei beieinander sein".*  
Hugo von Hoffmannsthal, Libretto zu Der Rosenkavalier

Und einige wenige Worte an meine lieben Kinder, **Niklas** und **Sofia**:  
Ich hab' Euch so lieb - welch' ein Glück, dass es Euch gibt!

## 11. APPENDIX

<b>Table 6. TP53 mutations and p53 IHC in MDS</b>				
<b>Reference</b>	<b>Diagnosis group</b>	<b>TP53 mutation</b>	<b>p53 IHC</b>	<b>Significance</b>
<b>Jonveaux et al, Oncogene 6, 1991</b>	MDS	5/151 (3%); 3/5 patients had monosomy 17	NA	TP53 mut associated with monosomy 17
<b>Tsushita et al, Br J Haematol 81, 1992</b>	RA/RARS (18x), RAEB (8x), RAEB-T (5x)	0% (by Sanger technique)	NA	No TP53 mutations detected (n=35)
<b>Ludwig et al, Leukemia 6, 1992</b>	MDS (n=61)	3/61 (5%), all RAEB-subtypes	NA	TP53 mutation suggested role in leukemogenesis
<b>Neubauer et al, Ann Hematol 67, 1993</b>	RA (3x), RARS (7x), RAEB (2x), RAEB-T (5)	0% (by Sanger technique)	NA	No TP53 mutations detected (n=17)
<b>Orazi et al, Mod Pathol 6, 1993</b>	MDS, AML, CML	9/10 IHC++ had complex karyotypes with chrom 5/7 abnormality	7/11 (63%) in t-MDS, 3/4 in t-AML	P53 IHC negative in CML and controls
<b>Sugimoto et al, Blood 81, 1993</b>	MDS (44x), AML (6x)	3/44 (7%) (all RAEB); 2/3 had chrom 5/7 abnormality	NA	TP53 mut in RAEB subtypes, associated with complex karyotype
<b>Kitagawa et al, Am J Pathol 145, 1994</b>	MDS (51x), AML (42x), AA (20x)	NA	7/51 MDS (14%) IHC+, 2/42 AML (5%)	IHC negative in AA and controls; all 7 MDS with p53+ at diagnosis evolved to AML
<b>Lepelley, Leuk 8, 1994</b>	MDS, AML, ALL, CLL	16/19 IHC+ cases showed missense mutations exon 4-8	2/19 AML, 2/21 ALL, 11/48 MDS, 4/40 CLL	IHC and TP53 mutation concordant in 123 of 128 (96%) cases
<b>Preudhomme et al, Leuk 8, 1994</b>	MDS and AML (n=83)	10/83 (12%)	NA	
<b>Wattel et al, Blood 84, 1994</b>	AML, MDS, CLL	16/107 (15%) AML, 20/182 (11%) MDS (RAEB 19x, CMML 1x), 9/81 (11%) CLL	NA	TP53 mutation associated with shorter OS and poor therapy response
<b>Adamson et al., Br J Haematol 89, 1995</b>	RA, RARS, CMML, RAEB, secondary AML	4/26 (15%) (RAEBx2, MDS-AML 2x)	NA	TP53 mutations considered as terminal genetic event

Reference	Diagnosis Group	TP53 mutation	p53 IHC	Significance
<b>Kaneko et al, Blood 85, 1995</b>	MDS (n=57)	7/57 (12%) (RAEB 6x, RA 1x); 5/7 patients had del(5q) abnormality	NA	TP53 mutations detected at an early disease stage, associated with AML risk
<b>Lai et al, Leukemia 9, 1995</b>	MDS, AML	del(17p) in 4.3% of MDS/AML patients	NA	del(17p) highly associated with TP53 mutations
<b>Mori et al, Leuk Res 19, 1995</b>	RA (5x), RAEB (3x), CMML (4x), RAEB-T (2x), AML (12x)	4/24 (16.7%), no mutation detected in RA subtype	NA	TP53 mutations detected at diagnosis and correlated with increased AML risk
<b>Kikukawa et al, Br J Haematol 92, 1996</b>	Case report: MDS type RA with rapid progression	TP53 mutation detected at codon 249	NA	TP53 mut in low-risk MDS patient; case report including literature review
<b>Misawa et al, Leuk Lymph 23, 1996</b>				Review article on TP53 mutations in MDS
<b>Mitani et al, Leukemia 1997</b>	MDS, MDS-AML (total 44x)	4/44 (9%) (RAEB 1x, MDS-AML 3x)	NA	TP53 mutations associated with advanced disease
<b>Elghetany et al, Ann Hematol 77, 1998</b>	RA (28x), AA (10x), normal controls (37x)	NA	19/28 (67%) RA patients p53+	p53 overexpression in RA but not in AA or normal controls
<b>Kikukawa et al, Br J Haematol 100, 1998</b>	RAEB-2 with monosomy 17	Point mutation at splice donor site of intron 5	NA	Rapid disease progression and resistance to chemotherapy
<b>Misawa et al, Leuk Res 22, 1998</b>	AML de novo (n=31), AML with dysplasia (n=17), secondary MDS-AML (n=20), t-AML (n=5)	12/73 (16%) (5/12 were MDS-AML)	NA	TP53 mutation present already at diagnosis in patients with secondary AML (MDS)
<b>Padua et al, Leukemia 12, 1998</b>	RARS (16x), RA (17x), RAEB (10x), CMML (32x)	4/50 (8%) (RARS 2x, RA, 1x, RAEB 1x)	NA	TP53 mutation not associated with increased AML risk
<b>Soenen et al, Leukemia 12, 1998</b>	Case report: secondary/therapy-related MDS	t(15,17), FISH del (17p)	p53 (DO7) strong protein expression	TP53 mutation associated with del(17p) in t-MDS
<b>Tang et al, Anticancer Res 18, 1998</b>	RA 10x, RARS 3x, CMML 6x, RAEB 15x, RAEB-T 9x, MDS-AML 4x	5/47 (11%); RAEB 4x, MDS-AML 1x) 4/5 detected at diagnosis	NA	TP53 mutation early genetic event and associated with poor survival



Reference	Diagnosis Group	TP53 mutation	p53 IHC	Significance
<b>Horiike et al. , Leukemia 13, 1999</b>	Therapy-related MDS or AML (21x); 12/21 with -5/5q- and/or -7/7q-	6/21 (29%)	NA	TP53 mutations only in patients with chromosome 5/7 abnormalities
<b>Kanavaros et al, Clin Exp Pathol 47, 1999</b>	MDS (30x), AML (22x), MPN (16x)	NA	6/30 (20%) MDS p53+; 6/22 (27%) AML p53+	p53 overexpression in myeloid lineage in MDS/AML but not in MPN or normal BM
<b>Kikukawa et al, Am J Pathol 155, 1999</b>	RA, RARS, RAEB, RAEB-t, CMML (total 52x)	3/8 (38%) with positive IHC were mutated	8/52 (15%) IHC+ at initial diagnosis	IHC associated with OS and AML risk: 5/8 (63%) IHC+ patients evolved to AML compared with 9/44 (2%) IHC-negative
<b>Magalhaes et al, Haematologica 84, 1999</b>	RA (19x)	NA	2/19 p53+	p53 expression associated with progression
<b>Kurotaki et al, Act Hematol 102, 2000</b>	RA (10x), RAEB (27x), MDS-AML (12x), de novo AML (13x)	NA	IHC for bcl-2 and p53	Higher frequency of p53 overexpression in MDS-AML as compared to de novo AML
<b>Elghetany et al. Leuk Res 24, 2000</b>	RA (28x), AA (10x)	NA	Comparison of three p53 MoAbs: p53 DO7, Pab 1801, Pab 240	All three p53 MoAbs negative in AA; antibody selection has impact on results
<b>Christiansen et al, JCO 19, 2001</b>	t-MDS (52x), t-AML (25x)	21/77 (27%); 6/21 del(17p)	NA	Frequent TP53 mut in t-MDS/AML, high association with del(5q) and complex karyotype
<b>Kita-Sasai et al, Br J Haematol 115, 2001</b>	RA(54x), RARS (4), RAEB (31x), RAEB-T (19), CMML (10x)	16/118 (13%) (RA 5x, RAEB 8x, RAEB-T 3x)	NA	complex karyotype in 11 of 16 patients with TP53 mutation
<b>Ramos et al, Haematologica 87, 2002</b>	MDS (n=61), AML (n=17), controls (n=25)	NA	strong p53 (DO7) expression seen in MDS but not normal controls	p53 IHC correlated with lower Hb and WBC, higher BM blast count and OS
<b>Imamura et al, Leukemia 16, 2002</b>	RA (n=8), RAEB (n=11), RAEB-T (2x), CMML (2x)	6/21 (28%), RAEB (5x), RA (1x)	NA	5/6 mut+ evolved to AML; 5/6 patients had chrom 5 and/or 7 abnormality

Reference	Diagnosis Group	TP53 mutation	p53 IHC	Significance
<b>Fidler et al, Haematologica 89, 2004</b>	RA (4x), 5q-(20x), RARS (1x), RAEB (11x), RAEB-T (2x), CMML (1x), MDS-AML (1)	3/40 (7.5%) (all RAEB)	NA	No mutation found in MDS with isolated del(5q)
<b>Side et al, Genes Chrom Cancer 39, 2004</b>	t-MDS/AML with chromosome 5/7 abnormality (n=26)	5/23 (21%)	NA	TP53 mutations associated with chromosome 5/7 abnormalities
<b>Zolota et al, Pathology Res Practice 203, 2007</b>	AML (n=42)	NA	p53 (DO7) detected in 81% of cases	No significant correlation between p53 IHC and outcome
<b>Iwasaki et al, Pathology International 58, 2008</b>	RA (19x), RARS (1x), RAEB (13x), RAEB-T (3x), CMML (1x), MDS-AML (11x)	7/48 (14%) (RA 1x, RAEB 3x, MDS-AML 3x); DNA from FFPE BM sample	p53 (DO7)	Patients with AA were p53 IHC negative; TP53 mutation associated with strong p53 staining
<b>Jasek et al, Leukemia 24, 2010</b>	Cohort of 379 patients with MDS/AML		NA	TP53 detected in 75% MDS/AML with complex karyotypes involving chrom 5/7
<b>Saito et al, Leuk Res 35, 2011</b>	Childhood MDS: t-MDS (1x), de novo MDS (n=6), AML with dysplasia (n=2), JMML (18)	1/9 patients with MDS; no TP53 mut in JMML patients	Strong p53 expression <2% in non-mutated and >50% in mut+	TP53 mutation associated with resistance to chemotherapy (one patient)
<b>Kulasekararaj et al, Br J Haematol 2012</b>	MDS (IPSS low-/high risk MDS) and secondary AML/t-AML (n=318)	30/318 (9.4%), predominantly missense mutations	p53 (DO7); 73% mut+ had strong p53 staining	TP53 mutations exclusively in MDS with isolated del(5q) or complex karyotype including -5/del(5q)
<b>Sebaa, et al., Genes Chrom Cancer 51, 2012</b>	MDS (26x) and AML (17x) with del(5q)	3/18 (17%) low-risk MDS, 8/15 (53%) high-risk	NA	TP53 mutations associated with shorter OS
<b>Shih et al, Haematologica 2013</b>	t-MDS/AML (n=38)	8/38 (21%); 83% of mut+ had del(5q) or monosomy 5	NA	TP53 mutations associated with shorter OS
NA, not applicable; chrom, chromosome; OS, overall survival; AML, acute myeloid leukemia; t-AML, therapy-related AML; AA, aplastic anemia; RA, refractory anemia; RARS, refractory anemia with ring sideroblasts; RAEB, refractory anemia with excess of blasts; CMML, chronic myelomonocytic leukemia; JMML, juvenile myelomonocytic leukemia; MPN, myeloproliferative neoplasm; ALL, acute lymphoblastic leukemia; CLL, chronic lymphocytic leukemia				

## 12. REFERENCES

1. List AF, Vardiman J, Issa JP, et al.: Myelodysplastic syndromes. *Hematology Am Soc Hematol Educ Program*:297-317, 2004
2. Rollison DE, Howlader N, Smith MT, et al.: Epidemiology of myelodysplastic syndromes and chronic myeloproliferative disorders in the United States, 2001-2004, using data from the NAACCR and SEER programs. *Blood* 112:45-52, 2008
3. Cogle CR, Craig BM, Rollison DE, et al.: Incidence of the myelodysplastic syndromes using a novel claims-based algorithm: high number of uncaptured cases by cancer registries. *Blood* 117:7121-7125, 2011
4. Neukirchen J, Schoonen WM, Strupp C, et al.: Incidence and prevalence of myelodysplastic syndromes: data from the Dusseldorf MDS-registry. *Leuk Res* 35:1591-1596, 2011
5. Radlund A, Thiede T, Hansen S, et al.: Incidence of myelodysplastic syndromes in a Swedish population. *Eur J Haematol* 54:153-156, 1995
6. Goldberg SL, Chen E, Corral M, et al.: Incidence and clinical complications of myelodysplastic syndromes among United States Medicare beneficiaries. *J Clin Oncol* 28:2847-2852, 2010
7. Gologan R, Georgescu D, Tatic A, et al.: Epidemiological data from the registry of patients with myelodysplastic syndrome in a single hospital center of Romania. *Leuk Res* 33:1556-1561, 2009
8. Nisse C, Lorthois C, Dorp V, et al.: Exposure to occupational and environmental factors in myelodysplastic syndromes. Preliminary results of a case-control study. *Leukemia* 9:693-699, 1995
9. Vardiman JW: Hematopathological concepts and controversies in the diagnosis and classification of myelodysplastic syndromes. *Hematology Am Soc Hematol Educ Program*:199-204, 2006
10. Naqvi K, Jabbour E, Bueso-Ramos C, et al.: Implications of discrepancy in morphologic diagnosis of myelodysplastic syndrome between referral and tertiary care centers. *Blood* 118:4690-4693, 2011
11. Cheson BD, Bennett JM, Kantarjian H, et al.: Report of an international working group to standardize response criteria for myelodysplastic syndromes. *Blood* 96:3671-3674, 2000
12. Swerdlow S.H., Campo E., Harris N.L., et al.: WHO Classification of Tumours of Haematopoietic and Lymphoid Tissues, in , IARC, Lyon, 2008
13. Valent P, Horny HP: Minimal diagnostic criteria for myelodysplastic syndromes and separation from ICUS and IDUS: update and open questions. *Eur J Clin Invest* 39:548-553, 2009
14. Czader M, Orazi A: World Health Organization classification of myelodysplastic syndromes. *Curr Pharm Des* 18:3149-3162, 2012
15. Valent P, Horny HP, Bennett JM, et al.: Definitions and standards in the diagnosis and treatment of the myelodysplastic syndromes: Consensus

statements and report from a working conference. *Leuk Res* 31:727-736, 2007

16. Wimazal F, Fonatsch C, Thalhammer R, et al.: Idiopathic cytopenia of undetermined significance (ICUS) versus low risk MDS: the diagnostic interface. *Leuk Res* 31:1461-1468, 2007
17. Valent P: Low erythropoietin production as non-oncogenic co-factor contributing to disease-manifestation in low-risk MDS: a hypothesis supported by unique case reports. *Leuk Res* 32:1333-1337, 2008
18. Maassen A, Strupp C, Giagounidis A, et al.: Validation and proposals for a refinement of the WHO 2008 classification of myelodysplastic syndromes without excess of blasts. *Leuk Res* 37:64-70, 2013
19. Horny HP, Sotlar K, Valent P: Diagnostic value of histology and immunohistochemistry in myelodysplastic syndromes. *Leuk Res* 31:1609-1616, 2007
20. Bennett JM, Orazi A: Diagnostic criteria to distinguish hypocellular acute myeloid leukemia from hypocellular myelodysplastic syndromes and aplastic anemia: recommendations for a standardized approach. *Haematologica* 94:264-268, 2009
21. Valent P, Orazi A, Busche G, et al.: Standards and impact of hematopathology in myelodysplastic syndromes (MDS). *Oncotarget* 1:483-496, 2010
22. Thiele J, Kvasnicka HM, Facchetti F, et al.: European consensus on grading bone marrow fibrosis and assessment of cellularity. *Haematologica* 90:1128-1132, 2005
23. Buesche G, Teoman H, Wilczak W, et al.: Marrow fibrosis predicts early fatal marrow failure in patients with myelodysplastic syndromes. *Leukemia* 22:313-322, 2008
24. Della Porta MG, Malcovati L, Boveri E, et al.: Clinical relevance of bone marrow fibrosis and CD34-positive cell clusters in primary myelodysplastic syndromes. *J Clin Oncol* 27:754-762, 2009
25. Verhoef GE, De Wolf-Peeters C, Ferrant A, et al.: Myelodysplastic syndromes with bone marrow fibrosis: a myelodysplastic disorder with proliferative features. *Ann Hematol* 63:235-241, 1991
26. Lambertenghi-Deliliers G, Annaloro C, Oriani A, et al.: Myelodysplastic syndrome associated with bone marrow fibrosis. *Leuk Lymphoma* 8:51-55, 1992
27. Orazi A: Histopathology in the diagnosis and classification of acute myeloid leukemia, myelodysplastic syndromes, and myelodysplastic/myeloproliferative diseases. *Pathobiology* 74:97-114, 2007
28. Oriani A, Annaloro C, Soligo D, et al.: Bone marrow histology and CD34 immunostaining in the prognostic evaluation of primary myelodysplastic syndromes. *Br J Haematol* 92:360-364, 1996
29. Soligo DA, Oriani A, Annaloro C, et al.: CD34 immunohistochemistry of bone marrow biopsies: prognostic significance in primary myelodysplastic syndromes. *Am J Hematol* 46:9-17, 1994

30. Bain BJ, Thompson EM: Expression of CD117 by proerythroblasts. *Am J Hematol* 85:123, 2010
31. Tang G, Wang SA, Menon M, et al.: High-level CD34 expression on megakaryocytes independently predicts an adverse outcome in patients with myelodysplastic syndromes. *Leuk Res* 35:766-770, 2011
32. Cazzola M, Malcovati L: Prognostic classification and risk assessment in myelodysplastic syndromes. *Hematol Oncol Clin North Am* 24:459-468, 2010
33. Bacher U, Kern W, Alpermann T, et al.: Prognoses of MDS subtypes RARS, RCMD and RCMD-RS are comparable but cytogenetics separates a subgroup with inferior clinical course. *Leuk Res* 36:826-831, 2012
34. Germing U, Gattermann N, Strupp C, et al.: Validation of the WHO proposals for a new classification of primary myelodysplastic syndromes: a retrospective analysis of 1600 patients. *Leuk Res* 24:983-992, 2000
35. Giagounidis AA, Germing U, Strupp C, et al.: Prognosis of patients with del(5q) MDS and complex karyotype and the possible role of lenalidomide in this patient subgroup. *Ann Hematol* 84:569-571, 2005
36. List AF, Baker AF, Green S, et al.: Lenalidomide: targeted anemia therapy for myelodysplastic syndromes. *Cancer Control* 13 Suppl:4-11, 2006
37. Haase D, Germing U, Schanz J, et al.: New insights into the prognostic impact of the karyotype in MDS and correlation with subtypes: evidence from a core dataset of 2124 patients. *Blood* 110:4385-4395, 2007
38. Sole F, Espinet B, Sanz GF, et al.: Incidence, characterization and prognostic significance of chromosomal abnormalities in 640 patients with primary myelodysplastic syndromes. *Grupo Cooperativo Espanol de Citogenetica Hematologica. Br J Haematol* 108:346-356, 2000
39. Pozdnyakova O, Miron PM, Tang G, et al.: Cytogenetic abnormalities in a series of 1,029 patients with primary myelodysplastic syndromes: a report from the US with a focus on some undefined single chromosomal abnormalities. *Cancer* 113:3331-3340, 2008
40. Schanz J, Steidl C, Fonatsch C, et al.: Coalesced multicentric analysis of 2,351 patients with myelodysplastic syndromes indicates an underestimation of poor-risk cytogenetics of myelodysplastic syndromes in the international prognostic scoring system. *J Clin Oncol* 29:1963-1970, 2011
41. Haase D, Fonatsch C, Freund M, et al.: Cytogenetic findings in 179 patients with myelodysplastic syndromes. *Ann Hematol* 70:171-187, 1995
42. Soenen V, Preudhomme C, Roumier C, et al.: 17p Deletion in acute myeloid leukemia and myelodysplastic syndrome. Analysis of breakpoints and deleted segments by fluorescence in situ. *Blood* 91:1008-1015, 1998
43. Sole F, Luno E, Sanzo C, et al.: Identification of novel cytogenetic markers with prognostic significance in a series of 968 patients with primary myelodysplastic syndromes. *Haematologica* 90:1168-1178, 2005
44. Cordoba I, Gonzalez-Porras JR, Nomdedeu B, et al.: Better prognosis for patients with del(7q) than for patients with monosomy 7 in myelodysplastic syndrome. *Cancer* 118:127-133, 2012

45. Greenberg PL, Tuechler H, Schanz J, et al.: Revised international prognostic scoring system for myelodysplastic syndromes. *Blood* 120:2454-2465, 2012
46. Greenberg P, Cox C, LeBeau MM, et al.: International scoring system for evaluating prognosis in myelodysplastic syndromes. *Blood* 89:2079-2088, 1997
47. Malcovati L, Germing U, Kuendgen A, et al.: Time-dependent prognostic scoring system for predicting survival and leukemic evolution in myelodysplastic syndromes. *J Clin Oncol* 25:3503-3510, 2007
48. Germing U, Lauseker M, Hildebrandt B, et al.: Survival, prognostic factors and rates of leukemic transformation in 381 untreated patients with MDS and del(5q): a multicenter study. *Leukemia* 26:1286-1292, 2012
49. Bowen DT, Fenaux P, Hellstrom-Lindberg E, et al.: Time-dependent prognostic scoring system for myelodysplastic syndromes has significant limitations that may influence its reproducibility and practical application. *J Clin Oncol* 26:1180-1182, 2008
50. Malcovati L, Della Porta MG, Strupp C, et al.: Impact of the degree of anemia on the outcome of patients with myelodysplastic syndrome and its integration into the WHO classification-based Prognostic Scoring System (WPSS). *Haematologica* 96:1433-1440, 2011
51. van de Loosdrecht AA, Alhan C, Bene MC, et al.: Standardization of flow cytometry in myelodysplastic syndromes: report from the first European LeukemiaNet working conference on flow cytometry in myelodysplastic syndromes. *Haematologica* 94:1124-1134, 2009
52. Ogata K, Della Porta MG, Malcovati L, et al.: Diagnostic utility of flow cytometry in low-grade myelodysplastic syndromes: a prospective validation study. *Haematologica* 94:1066-1074, 2009
53. Kern W, Haferlach C, Schnittger S, et al.: Clinical utility of multiparameter flow cytometry in the diagnosis of 1013 patients with suspected myelodysplastic syndrome: correlation to cytomorphology, cytogenetics, and clinical data. *Cancer* 116:4549-4563, 2010
54. Stetler-Stevenson M, Arthur DC, Jabbour N, et al.: Diagnostic utility of flow cytometric immunophenotyping in myelodysplastic syndrome. *Blood* 98:979-987, 2001
55. Kussick SJ, Fromm JR, Rossini A, et al.: Four-color flow cytometry shows strong concordance with bone marrow morphology and cytogenetics in the evaluation for myelodysplasia. *Am J Clin Pathol* 124:170-181, 2005
56. Malcovati L, Della Porta MG, Lunghi M, et al.: Flow cytometry evaluation of erythroid and myeloid dysplasia in patients with myelodysplastic syndrome. *Leukemia* 19:776-783, 2005
57. Della Porta MG, Malcovati L, Invernizzi R, et al.: Flow cytometry evaluation of erythroid dysplasia in patients with myelodysplastic syndrome. *Leukemia* 20:549-555, 2006
58. Matarraz S, Lopez A, Barrena S, et al.: The immunophenotype of different immature, myeloid and B-cell lineage-committed CD34+ hematopoietic cells allows discrimination between normal/reactive and myelodysplastic syndrome precursors. *Leukemia* 22:1175-1183, 2008

59. Lorand-Metze I, Ribeiro E, Lima CS, et al.: Detection of hematopoietic maturation abnormalities by flow cytometry in myelodysplastic syndromes and its utility for the differential diagnosis with non-clonal disorders. *Leuk Res* 31:147-155, 2007
60. van de Loosdrecht AA, Westers TM, Westra AH, et al.: Identification of distinct prognostic subgroups in low- and intermediate-1-risk myelodysplastic syndromes by flow cytometry. *Blood* 111:1067-1077, 2008
61. Wells DA, Benesch M, Loken MR, et al.: Myeloid and monocytic dyspoiesis as determined by flow cytometric scoring in myelodysplastic syndrome correlates with the IPSS and with outcome after hematopoietic stem cell transplantation. *Blood* 102:394-403, 2003
62. Westers TM, Ireland R, Kern W, et al.: Standardization of flow cytometry in myelodysplastic syndromes: a report from an international consortium and the European LeukemiaNet Working Group. *Leukemia* 26:1730-1741, 2012
63. Della Porta MG, Picone C, Pascutto C, et al.: Multicenter validation of a reproducible flow cytometric score for the diagnosis of low-grade myelodysplastic syndromes: results of a European LeukemiaNET study. *Haematologica* 97:1209-1217, 2012
64. Lin YW, Slape C, Zhang Z, et al.: NUP98-HOXD13 transgenic mice develop a highly penetrant, severe myelodysplastic syndrome that progresses to acute leukemia. *Blood* 106:287-295, 2005
65. Chung YJ, Choi CW, Slape C, et al.: Transplantation of a myelodysplastic syndrome by a long-term repopulating hematopoietic cell. *Proc Natl Acad Sci U S A* 105:14088-14093, 2008
66. Kerbauy DM, Lesnikov V, Torok-Storb B, et al.: Engraftment of distinct clonal MDS-derived hematopoietic precursors in NOD/SCID-beta2-microglobulin-deficient mice after intramedullary transplantation of hematopoietic and stromal cells. *Blood* 104:2202-2203, 2004
67. Nilsson L, Astrand-Grundstrom I, Anderson K, et al.: Involvement and functional impairment of the CD34(+)CD38(-)Thy-1(+) hematopoietic stem cell pool in myelodysplastic syndromes with trisomy 8. *Blood* 100:259-267, 2002
68. Nilsson L, Eden P, Olsson E, et al.: The molecular signature of MDS stem cells supports a stem-cell origin of 5q myelodysplastic syndromes. *Blood* 110:3005-3014, 2007
69. Tehrani R, Woll PS, Anderson K, et al.: Persistent malignant stem cells in del(5q) myelodysplasia in remission. *N Engl J Med* 363:1025-1037, 2010
70. Will B, Zhou L, Vogler TO, et al.: Stem and progenitor cells in myelodysplastic syndromes show aberrant stage-specific expansion and harbor genetic and epigenetic alterations. *Blood* 120:2076-2086, 2012
71. Jaju RJ, Jones M, Boulwood J, et al.: Combined immunophenotyping and FISH identifies the involvement of B-cells in 5q- syndrome. *Genes Chromosomes Cancer* 29:276-280, 2000

72. Sato T, Onai N, Yoshihara H, et al.: Interferon regulatory factor-2 protects quiescent hematopoietic stem cells from type I interferon-dependent exhaustion. *Nat Med* 15:696-700, 2009
73. Laurenti E, Varnum-Finney B, Wilson A, et al.: Hematopoietic stem cell function and survival depend on c-Myc and N-Myc activity. *Cell Stem Cell* 3:611-624, 2008
74. Abramovich C, Pineault N, Ohta H, et al.: Hox genes: from leukemia to hematopoietic stem cell expansion. *Ann N Y Acad Sci* 1044:109-116, 2005
75. Akala OO, Clarke MF: Hematopoietic stem cell self-renewal. *Curr Opin Genet Dev* 16:496-501, 2006
76. Misaghian N, Ligresti G, Steelman LS, et al.: Targeting the leukemic stem cell: the Holy Grail of leukemia therapy. *Leukemia* 23:25-42, 2009
77. Pang WW, Pluvinae JV, Price EA, et al.: Hematopoietic stem cell and progenitor cell mechanisms in myelodysplastic syndromes. *Proc Natl Acad Sci U S A* 110:3011-3016, 2013
78. TeKippe M, Harrison DE, Chen J: Expansion of hematopoietic stem cell phenotype and activity in Trp53-null mice. *Exp Hematol* 31:521-527, 2003
79. Armesilla-Diaz A, Elvira G, Silva A: p53 regulates the proliferation, differentiation and spontaneous transformation of mesenchymal stem cells. *Exp Cell Res* 315:3598-3610, 2009
80. Liu Y, Elf SE, Miyata Y, et al.: p53 regulates hematopoietic stem cell quiescence. *Cell Stem Cell* 4:37-48, 2009
81. Rambhatla L, Bohn SA, Stadler PB, et al.: Cellular Senescence: Ex Vivo p53-Dependent Asymmetric Cell Kinetics. *J Biomed Biotechnol* 1:28-37, 2001
82. Dumble M, Moore L, Chambers SM, et al.: The impact of altered p53 dosage on hematopoietic stem cell dynamics during aging. *Blood* 109:1736-1742, 2007
83. Cicalese A, Bonizzi G, Pasi CE, et al.: The tumor suppressor p53 regulates polarity of self-renewing divisions in mammary stem cells. *Cell* 138:1083-1095, 2009
84. Hong H, Takahashi K, Ichisaka T, et al.: Suppression of induced pluripotent stem cell generation by the p53-p21 pathway. *Nature* 460:1132-1135, 2009
85. Kawamura T, Suzuki J, Wang YV, et al.: Linking the p53 tumour suppressor pathway to somatic cell reprogramming. *Nature* 460:1140-1144, 2009
86. Marion RM, Strati K, Li H, et al.: A p53-mediated DNA damage response limits reprogramming to ensure iPS cell genomic integrity. *Nature* 460:1149-1153, 2009
87. Miyazato A, Ueno S, Ohmine K, et al.: Identification of myelodysplastic syndrome-specific genes by DNA microarray analysis with purified hematopoietic stem cell fraction. *Blood* 98:422-427, 2001



88. Hofmann WK, de VS, Komor M, et al.: Characterization of gene expression of CD34+ cells from normal and myelodysplastic bone marrow. *Blood* 100:3553-3560, 2002
89. Chen G, Zeng W, Miyazato A, et al.: Distinctive gene expression profiles of CD34 cells from patients with myelodysplastic syndrome characterized by specific chromosomal abnormalities. *Blood* 104:4210-4218, 2004
90. Ueda M, Ota J, Yamashita Y, et al.: DNA microarray analysis of stage progression mechanism in myelodysplastic syndrome. *Br J Haematol* 123:288-296, 2003
91. Pellagatti A, Esoof N, Watkins F, et al.: Gene expression profiling in the myelodysplastic syndromes using cDNA microarray technology. *Br J Haematol* 125:576-583, 2004
92. Pellagatti A, Marafioti T, Paterson JC, et al.: Induction of p53 and up-regulation of the p53 pathway in the human 5q- syndrome. *Blood* 115:2721-2723, 2010
93. Bejar R, Stevenson KE, Caughey BA, et al.: Validation of a prognostic model and the impact of mutations in patients with lower-risk myelodysplastic syndromes. *J Clin Oncol* 30:3376-3382, 2012
94. Bejar R, Stevenson K, Abdel-Wahab O, et al.: Clinical effect of point mutations in myelodysplastic syndromes. *N Engl J Med* 364:2496-2506, 2011
95. Steensma DP, Gibbons RJ, Mesa RA, et al.: Somatic point mutations in RUNX1/CBFA2/AML1 are common in high-risk myelodysplastic syndrome, but not in myelofibrosis with myeloid metaplasia. *Eur J Haematol* 74:47-53, 2005
96. Akagi T, Ogawa S, Dugas M, et al.: Frequent genomic abnormalities in acute myeloid leukemia/myelodysplastic syndrome with normal karyotype. *Haematologica* 94:213-223, 2009
97. Tang JL, Hou HA, Chen CY, et al.: AML1/RUNX1 mutations in 470 adult patients with de novo acute myeloid leukemia: prognostic implication and interaction with other gene alterations. *Blood* 114:5352-5361, 2009
98. Cilloni D, Gottardi E, Messa F, et al.: Significant correlation between the degree of WT1 expression and the International Prognostic Scoring System Score in patients with myelodysplastic syndromes. *J Clin Oncol* 21:1988-1995, 2003
99. Harada H, Harada Y, Niimi H, et al.: High incidence of somatic mutations in the AML1/RUNX1 gene in myelodysplastic syndrome and low blast percentage myeloid leukemia with myelodysplasia. *Blood* 103:2316-2324, 2004
100. Kosmider O, Gelsi-Boyer V, Cheek M, et al.: TET2 mutation is an independent favorable prognostic factor in myelodysplastic syndromes (MDSs). *Blood* 114:3285-3291, 2009
101. Delhommeau F, Dupont S, Della V, V, et al.: Mutation in TET2 in myeloid cancers. *N Engl J Med* 360:2289-2301, 2009
102. Walter MJ, Ding L, Shen D, et al.: Recurrent DNMT3A mutations in patients with myelodysplastic syndromes. *Leukemia* 25:1153-1158, 2011

103. Boultonwood J, Perry J, Pellagatti A, et al.: Frequent mutation of the polycomb-associated gene ASXL1 in the myelodysplastic syndromes and in acute myeloid leukemia. *Leukemia* 24:1062-1065, 2010
104. Ernst T, Chase A, Zoi K, et al.: Transcription factor mutations in myelodysplastic/myeloproliferative neoplasms. *Haematologica* 95:1473-1480, 2010
105. Tefferi A, Lim KH, Abdel-Wahab O, et al.: Detection of mutant TET2 in myeloid malignancies other than myeloproliferative neoplasms: CMML, MDS, MDS/MPN and AML. *Leukemia* 23:1343-1345, 2009
106. Smith AE, Mohamedali AM, Kulasekararaj A, et al.: Next-generation sequencing of the TET2 gene in 355 MDS and CMML patients reveals low-abundance mutant clones with early origins, but indicates no definite prognostic value. *Blood* 116:3923-3932, 2010
107. Kosmider O, Gelsi-Boyer V, Slama L, et al.: Mutations of IDH1 and IDH2 genes in early and accelerated phases of myelodysplastic syndromes and MDS/myeloproliferative neoplasms. *Leukemia* 24:1094-1096, 2010
108. Pardananani A, Patnaik MM, Lasho TL, et al.: Recurrent IDH mutations in high-risk myelodysplastic syndrome or acute myeloid leukemia with isolated del(5q). *Leukemia* 24:1370-1372, 2010
109. Thol F, Weissinger EM, Krauter J, et al.: IDH1 mutations in patients with myelodysplastic syndromes are associated with an unfavorable prognosis. *Haematologica* 95:1668-1674, 2010
110. Patnaik MM, Hanson CA, Hodnefield JM, et al.: Differential prognostic effect of IDH1 versus IDH2 mutations in myelodysplastic syndromes: a Mayo Clinic study of 277 patients. *Leukemia* 26:101-105, 2012
111. Yoshida K, Sanada M, Shiraishi Y, et al.: Frequent pathway mutations of splicing machinery in myelodysplasia. *Nature* 478:64-69, 2011
112. Thol F, Kade S, Schlarmann C, et al.: Frequency and prognostic impact of mutations in SRSF2, U2AF1, and ZRSR2 in patients with myelodysplastic syndromes. *Blood* 119:3578-3584, 2012
113. Visconte V, Makishima H, Jankowska A, et al.: SF3B1, a splicing factor is frequently mutated in refractory anemia with ring sideroblasts. *Leukemia* 26:542-545, 2012
114. Makishima H, Visconte V, Sakaguchi H, et al.: Mutations in the spliceosome machinery, a novel and ubiquitous pathway in leukemogenesis. *Blood* 119:3203-3210, 2012
115. Damm F, Kosmider O, Gelsi-Boyer V, et al.: Mutations affecting mRNA splicing define distinct clinical phenotypes and correlate with patient outcome in myelodysplastic syndromes. *Blood* 119:3211-3218, 2012
116. Graubert TA, Shen D, Ding L, et al.: Recurrent mutations in the U2AF1 splicing factor in myelodysplastic syndromes. *Nat Genet* 44:53-57, 2012
117. Bacher U, Haferlach T, Kern W, et al.: A comparative study of molecular mutations in 381 patients with myelodysplastic syndrome and in 4130 patients with acute myeloid leukemia. *Haematologica* 92:744-752, 2007

118. Shih LY, Huang CF, Wang PN, et al.: Acquisition of FLT3 or N-ras mutations is frequently associated with progression of myelodysplastic syndrome to acute myeloid leukemia. *Leukemia* 18:466-475, 2004
119. Haferlach C, Bacher U, Haferlach T, et al.: The inv(3)(q21q26)/t(3;3)(q21;q26) is frequently accompanied by alterations of the RUNX1, KRAS and NRAS and NF1 genes and mediates adverse prognosis both in MDS and in AML: a study in 39 cases of MDS or AML. *Leukemia* 25:874-877, 2011
120. Zhang Y, Zhang M, Yang L, et al.: NPM1 mutations in myelodysplastic syndromes and acute myeloid leukemia with normal karyotype. *Leuk Res* 31:109-111, 2007
121. Ammatuna E, Panetta P, Agirre X, et al.: NPM1 gene deletions in myelodysplastic syndromes with 5q- and complex karyotype. *Haematologica* 96:784-785, 2011
122. Walter MJ, Shen D, Ding L, et al.: Clonal architecture of secondary acute myeloid leukemia. *N Engl J Med* 366:1090-1098, 2012
123. Larson RA: Is secondary leukemia an independent poor prognostic factor in acute myeloid leukemia? *Best Pract Res Clin Haematol* 20:29-37, 2007
124. Bello C, Yu D, Komrokji RS, et al.: Outcomes after induction chemotherapy in patients with acute myeloid leukemia arising from myelodysplastic syndrome. *Cancer* 117:1463-1469, 2011
125. Issa JP: Epigenetic changes in the myelodysplastic syndrome. *Hematol Oncol Clin North Am* 24:317-330, 2010
126. Figueroa ME, Skrabanek L, Li Y, et al.: MDS and secondary AML display unique patterns and abundance of aberrant DNA methylation. *Blood* 114:3448-3458, 2009
127. Quesnel B, Guillerm G, Vereecque R, et al.: Methylation of the p15(INK4b) gene in myelodysplastic syndromes is frequent and acquired during disease progression. *Blood* 91:2985-2990, 1998
128. Uchida T, Kinoshita T, Nagai H, et al.: Hypermethylation of the p15INK4B gene in myelodysplastic syndromes. *Blood* 90:1403-1409, 1997
129. Silverman LR, Demakos EP, Peterson BL, et al.: Randomized controlled trial of azacitidine in patients with the myelodysplastic syndrome: a study of the cancer and leukemia group B. *J Clin Oncol* 20:2429-2440, 2002
130. Daskalakis M, Nguyen TT, Nguyen C, et al.: Demethylation of a hypermethylated P15/INK4B gene in patients with myelodysplastic syndrome by 5-Aza-2'-deoxycytidine (decitabine) treatment. *Blood* 100:2957-2964, 2002
131. Wijermans P, Lubbert M, Verhoef G, et al.: Low-dose 5-aza-2'-deoxycytidine, a DNA hypomethylating agent, for the treatment of high-risk myelodysplastic syndrome: a multicenter phase II study in elderly patients. *J Clin Oncol* 18:956-962, 2000
132. Saba HI, Wijermans PW: Decitabine in myelodysplastic syndromes. *Semin Hematol* 42:S23-S31, 2005

133. Jiang Y, Dunbar A, Gondek LP, et al.: Aberrant DNA methylation is a dominant mechanism in MDS progression to AML. *Blood* 113:1315-1325, 2009
134. Shen L, Kantarjian H, Guo Y, et al.: DNA methylation predicts survival and response to therapy in patients with myelodysplastic syndromes. *J Clin Oncol* 28:605-613, 2010
135. Aggerholm A, Holm MS, Guldberg P, et al.: Promoter hypermethylation of p15INK4B, HIC1, CDH1, and ER is frequent in myelodysplastic syndrome and predicts poor prognosis in early-stage patients. *Eur J Haematol* 76:23-32, 2006
136. Alfinito F, Sica M, Luciano L, et al.: Immune dysregulation and dyserythropoiesis in the myelodysplastic syndromes. *Br J Haematol* 148:90-98, 2010
137. Kook H, Zeng W, Guibin C, et al.: Increased cytotoxic T cells with effector phenotype in aplastic anemia and myelodysplasia. *Exp Hematol* 29:1270-1277, 2001
138. Chamuleau ME, Westers TM, van DL, et al.: Immune mediated autologous cytotoxicity against hematopoietic precursor cells in patients with myelodysplastic syndrome. *Haematologica* 94:496-506, 2009
139. Molldrem JJ, Caples M, Mavroudis D, et al.: Antithymocyte globulin for patients with myelodysplastic syndrome. *Br J Haematol* 99:699-705, 1997
140. Molldrem JJ, Jiang YZ, Stetler-Stevenson M, et al.: Haematological response of patients with myelodysplastic syndrome to antithymocyte globulin is associated with a loss of lymphocyte-mediated inhibition of CFU-GM and alterations in T-cell receptor Vbeta profiles. *Br J Haematol* 102:1314-1322, 1998
141. Kochenderfer JN, Kobayashi S, Wieder ED, et al.: Loss of T-lymphocyte clonal dominance in patients with myelodysplastic syndrome responsive to immunosuppression. *Blood* 100:3639-3645, 2002
142. Killick SB, Mufti G, Cavenagh JD, et al.: A pilot study of antithymocyte globulin (ATG) in the treatment of patients with 'low-risk' myelodysplasia. *Br J Haematol* 120:679-684, 2003
143. Broliden PA, Dahl IM, Hast R, et al.: Antithymocyte globulin and cyclosporine A as combination therapy for low-risk non-sideroblastic myelodysplastic syndromes. *Haematologica* 91:667-670, 2006
144. Sloand EM, Wu CO, Greenberg P, et al.: Factors affecting response and survival in patients with myelodysplasia treated with immunosuppressive therapy. *J Clin Oncol* 26:2505-2511, 2008
145. Sloand EM, Wu CO, Greenberg P, et al.: Factors affecting response and survival in patients with myelodysplasia treated with immunosuppressive therapy. *J Clin Oncol* 26:2505-2511, 2008
146. Baumann I, Scheid C, Koref MS, et al.: Autologous lymphocytes inhibit hemopoiesis in long-term culture in patients with myelodysplastic syndrome. *Exp Hematol* 30:1405-1411, 2002

147. Epperson DE, Nakamura R, Sauntharajah Y, et al.: Oligoclonal T cell expansion in myelodysplastic syndrome: evidence for an autoimmune process. *Leuk Res* 25:1075-1083, 2001
148. Pellagatti A, Cazzola M, Giagounidis AA, et al.: Gene expression profiles of CD34+ cells in myelodysplastic syndromes: involvement of interferon-stimulated genes and correlation to FAB subtype and karyotype. *Blood* 108:337-345, 2006
149. Kordasti SY, Ingram W, Hayden J, et al.: CD4+CD25high Foxp3+ regulatory T cells in myelodysplastic syndrome (MDS). *Blood* 110:847-850, 2007
150. Kotsianidis I, Bouchliou I, Nakou E, et al.: Kinetics, function and bone marrow trafficking of CD4+CD25+FOXP3+ regulatory T cells in myelodysplastic syndromes (MDS). *Leukemia* 23:510-518, 2009
151. Jonasova A, Neuwirtova R, Cermak J, et al.: Cyclosporin A therapy in hypoplastic MDS patients and certain refractory anaemias without hypoplastic bone marrow. *Br J Haematol* 100:304-309, 1998
152. Biesma DH, van den Tweel JG, Verdonck LF: Immunosuppressive therapy for hypoplastic myelodysplastic syndrome. *Cancer* 79:1548-1551, 1997
153. Gersuk GM, Lee JW, Beckham CA, et al.: Fas (CD95) receptor and Fas-ligand expression in bone marrow cells from patients with myelodysplastic syndrome. *Blood* 88:1122-1123, 1996
154. Marcondes AM, Mhyre AJ, Stirewalt DL, et al.: Dysregulation of IL-32 in myelodysplastic syndrome and chronic myelomonocytic leukemia modulates apoptosis and impairs NK function. *Proc Natl Acad Sci U S A* 105:2865-2870, 2008
155. Micheva I, Thanopoulou E, Michalopoulou S, et al.: Impaired generation of bone marrow CD34-derived dendritic cells with low peripheral blood subsets in patients with myelodysplastic syndrome. *Br J Haematol* 126:806-814, 2004
156. Ma L, Delforge M, van D, V, et al.: Circulating myeloid and lymphoid precursor dendritic cells are clonally involved in myelodysplastic syndromes. *Leukemia* 18:1451-1456, 2004
157. Kufner S, Zitzelsberger H, Kroell T, et al.: Leukaemia-derived dendritic cells can be generated from blood or bone marrow cells from patients with myelodysplasia: a methodological approach under serum-free culture conditions. *Scand J Immunol* 62:75-85, 2005
158. Saft L, Bjorklund E, Berg E, et al.: Bone marrow dendritic cells are reduced in patients with high-risk myelodysplastic syndromes. *Leuk Res* 37:266-273, 2013
159. Keith T, Araki Y, Ohyagi M, et al.: Regulation of angiogenesis in the bone marrow of myelodysplastic syndromes transforming to overt leukaemia. *Br J Haematol* 137:206-215, 2007
160. Benito AI, Bryant E, Loken MR, et al.: NOD/SCID mice transplanted with marrow from patients with myelodysplastic syndrome (MDS) show long-term propagation of normal but not clonal human precursors. *Leuk Res* 27:425-436, 2003

161. Calvi LM, Adams GB, Weibrecht KW, et al.: Osteoblastic cells regulate the haematopoietic stem cell niche. *Nature* 425:841-846, 2003
162. Zhang J, Niu C, Ye L, et al.: Identification of the haematopoietic stem cell niche and control of the niche size. *Nature* 425:836-841, 2003
163. Mendez-Ferrer S, Michurina TV, Ferraro F, et al.: Mesenchymal and haematopoietic stem cells form a unique bone marrow niche. *Nature* 466:829-834, 2010
164. Kiel MJ, Yilmaz OH, Iwashita T, et al.: SLAM family receptors distinguish hematopoietic stem and progenitor cells and reveal endothelial niches for stem cells. *Cell* 121:1109-1121, 2005
165. Butler JM, Nolan DJ, Vertes EL, et al.: Endothelial cells are essential for the self-renewal and repopulation of Notch-dependent hematopoietic stem cells. *Cell Stem Cell* 6:251-264, 2010
166. Sugimura R, Li L: Shifting in balance between osteogenesis and adipogenesis substantially influences hematopoiesis. *J Mol Cell Biol* 2:61-62, 2010
167. Raaijmakers MH, Mukherjee S, Guo S, et al.: Bone progenitor dysfunction induces myelodysplasia and secondary leukaemia. *Nature* 464:852-857, 2010
168. Das M, Chatterjee S, Basak P, et al.: The bone marrow stem stromal imbalance--a key feature of disease progression in case of myelodysplastic mouse model. *J Stem Cells* 5:49-64, 2010
169. Tauro S, Hepburn MD, Peddie CM, et al.: Functional disturbance of marrow stromal microenvironment in the myelodysplastic syndromes. *Leukemia* 16:785-790, 2002
170. Raaijmakers MH: Myelodysplastic syndromes: revisiting the role of the bone marrow microenvironment in disease pathogenesis. *Int J Hematol* 95:17-25, 2012
171. Van den Berghe H, Vermaelen K, Mecucci C, et al.: The 5q-anomaly. *Cancer Genet Cytogenet* 17:189-255, 1985
172. Bernasconi P, Klersy C, Boni M, et al.: Incidence and prognostic significance of karyotype abnormalities in de novo primary myelodysplastic syndromes: a study on 331 patients from a single institution. *Leukemia* 19:1424-1431, 2005
173. Kantarjian H, O'Brien S, Ravandi F, et al.: The heterogeneous prognosis of patients with myelodysplastic syndrome and chromosome 5 abnormalities: how does it relate to the original lenalidomide experience in MDS? *Cancer* 115:5202-5209, 2009
174. Zhao N, Stoffel A, Wang PW, et al.: Molecular delineation of the smallest commonly deleted region of chromosome 5 in malignant myeloid diseases to 1-1.5 Mb and preparation of a PAC-based physical map. *Proc Natl Acad Sci U S A* 94:6948-6953, 1997
175. Jaju RJ, Boulton J, Oliver FJ, et al.: Molecular cytogenetic delineation of the critical deleted region in the 5q- syndrome. *Genes Chromosomes Cancer* 22:251-256, 1998

176. Le Beau MM, Espinosa R, III, Neuman WL, et al.: Cytogenetic and molecular delineation of the smallest commonly deleted region of chromosome 5 in malignant myeloid diseases. *Proc Natl Acad Sci U S A* 90:5484-5488, 1993
177. Boultonwood J, Fidler C, Lewis S, et al.: Molecular mapping of uncharacteristically small 5q deletions in two patients with the 5q-syndrome: delineation of the critical region on 5q and identification of a 5q-breakpoint. *Genomics* 19:425-432, 1994
178. Boultonwood J, Fidler C, Strickson AJ, et al.: Narrowing and genomic annotation of the commonly deleted region of the 5q-syndrome. *Blood* 99:4638-4641, 2002
179. Pellagatti A, Jadersten M, Forsblom AM, et al.: Lenalidomide inhibits the malignant clone and up-regulates the SPARC gene mapping to the commonly deleted region in 5q-syndrome patients. *Proc Natl Acad Sci U S A* 104:11406-11411, 2007
180. Boultonwood J, Pellagatti A, Cattani H, et al.: Gene expression profiling of CD34+ cells in patients with the 5q-syndrome. *Br J Haematol* 139:578-589, 2007
181. Ebert BL, Pretz J, Bosco J, et al.: Identification of RPS14 as a 5q-syndrome gene by RNA interference screen. *Nature* 451:335-339, 2008
182. Pellagatti A, Hellstrom-Lindberg E, Giagounidis A, et al.: Haploinsufficiency of RPS14 in 5q-syndrome is associated with deregulation of ribosomal- and translation-related genes. *Br J Haematol* 142:57-64, 2008
183. Barlow JL, Drynan LF, Hewett DR, et al.: A p53-dependent mechanism underlies macrocytic anemia in a mouse model of human 5q-syndrome. *Nat Med* 16:59-66, 2010
184. Starczynowski DT, Kuchenbauer F, Argiropoulos B, et al.: Identification of miR-145 and miR-146a as mediators of the 5q-syndrome phenotype. *Nat Med* 16:49-58, 2010
185. Hellstrom-Lindberg E: Management of anemia associated with myelodysplastic syndrome. *Semin Hematol* 42:S10-S13, 2005
186. Malcovati L, Porta MG, Pascutto C, et al.: Prognostic factors and life expectancy in myelodysplastic syndromes classified according to WHO criteria: a basis for clinical decision making. *J Clin Oncol* 23:7594-7603, 2005
187. Leitch HA: Improving clinical outcome in patients with myelodysplastic syndrome and iron overload using iron chelation therapy. *Leuk Res* 31 Suppl 3:S7-S9, 2007
188. Messa E, Cilloni D, Messa F, et al.: Deferasirox treatment improved the hemoglobin level and decreased transfusion requirements in four patients with the myelodysplastic syndrome and primary myelofibrosis. *Acta Haematol* 120:70-74, 2008
189. Gattermann N, Finelli C, Porta MD, et al.: Deferasirox in iron-overloaded patients with transfusion-dependent myelodysplastic syndromes: Results from the large 1-year EPIC study. *Leuk Res* 34:1143-1150, 2010

190. Gattermann N: Pathophysiological and clinical aspects of iron chelation therapy in MDS. *Curr Pharm Des* 18:3222-3234, 2012
191. Hartmann J, Braulke F, Sinzig U, et al.: Iron overload impairs proliferation of erythroid progenitors cells (BFU-E) from patients with myelodysplastic syndromes. *Leuk Res* 37:327-332, 2013
192. Bennett JM: Consensus statement on iron overload in myelodysplastic syndromes. *Am J Hematol* 83:858-861, 2008
193. Gattermann N: Overview of guidelines on iron chelation therapy in patients with myelodysplastic syndromes and transfusional iron overload. *Int J Hematol* 88:24-29, 2008
194. Alessandrino EP, Amadori S, Barosi G, et al.: Evidence- and consensus-based practice guidelines for the therapy of primary myelodysplastic syndromes. A statement from the Italian Society of Hematology. *Haematologica* 87:1286-1306, 2002
195. Giraldo P, Nomdedeu B, Loscertales J, et al.: Darbepoetin alpha for the treatment of anemia in patients with myelodysplastic syndromes. *Cancer* 107:2807-2816, 2006
196. Mannone L, Gardin C, Quarre MC, et al.: High-dose darbepoetin alpha in the treatment of anaemia of lower risk myelodysplastic syndrome results of a phase II study. *Br J Haematol* 133:513-519, 2006
197. Casadevall N, Durieux P, Dubois S, et al.: Health, economic, and quality-of-life effects of erythropoietin and granulocyte colony-stimulating factor for the treatment of myelodysplastic syndromes: a randomized, controlled trial. *Blood* 104:321-327, 2004
198. Balleari E, Clavio M, Arboscello E, et al.: Weekly standard doses of rh-EPO are highly effective for the treatment of anemic patients with low-intermediate 1 risk myelodysplastic syndromes. *Leuk Res* 35:1472-1476, 2011
199. Jadersten M, Malcovati L, Dybedal I, et al.: Erythropoietin and granulocyte-colony stimulating factor treatment associated with improved survival in myelodysplastic syndrome. *J Clin Oncol* 26:3607-3613, 2008
200. Park S, Grabar S, Kelaidi C, et al.: Predictive factors of response and survival in myelodysplastic syndrome treated with erythropoietin and G-CSF: the GFM experience. *Blood* 111:574-582, 2008
201. Greenberg PL, Sun Z, Miller KB, et al.: Treatment of myelodysplastic syndrome patients with erythropoietin with or without granulocyte colony-stimulating factor: results of a prospective randomized phase 3 trial by the Eastern Cooperative Oncology Group (E1996). *Blood* 114:2393-2400, 2009
202. Hellstrom-Lindberg E, Gulbrandsen N, Lindberg G, et al.: A validated decision model for treating the anaemia of myelodysplastic syndromes with erythropoietin + granulocyte colony-stimulating factor: significant effects on quality of life. *Br J Haematol* 120:1037-1046, 2003
203. Jadersten M, Montgomery SM, Dybedal I, et al.: Long-term outcome of treatment of anemia in MDS with erythropoietin and G-CSF. *Blood* 106:803-811, 2005



204. Molldrem JJ, Leifer E, Bahceci E, et al.: Antithymocyte globulin for treatment of the bone marrow failure associated with myelodysplastic syndromes. *Ann Intern Med* 137:156-163, 2002
205. Lim ZY, Killick S, Germing U, et al.: Low IPSS score and bone marrow hypocellularity in MDS patients predict hematological responses to antithymocyte globulin. *Leukemia* 21:1436-1441, 2007
206. Stadler M, Germing U, Kliche KO, et al.: A prospective, randomised, phase II study of horse antithymocyte globulin vs rabbit antithymocyte globulin as immune-modulating therapy in patients with low-risk myelodysplastic syndromes. *Leukemia* 18:460-465, 2004
207. Yazji S, Giles FJ, Tsimberidou AM, et al.: Antithymocyte globulin (ATG)-based therapy in patients with myelodysplastic syndromes. *Leukemia* 17:2101-2106, 2003
208. Aivado M, Rong A, Stadler M, et al.: Favourable response to antithymocyte or antilymphocyte globulin in low-risk myelodysplastic syndrome patients with a 'non-clonal' pattern of X-chromosome inactivation in bone marrow cells. *Eur J Haematol* 68:210-216, 2002
209. Asano Y, Maeda M, Uchida N, et al.: Immunosuppressive therapy for patients with refractory anemia. *Ann Hematol* 80:634-638, 2001
210. Passweg JR, Giagounidis AA, Simcock M, et al.: Immunosuppressive therapy for patients with myelodysplastic syndrome: a prospective randomized multicenter phase III trial comparing antithymocyte globulin plus cyclosporine with best supportive care--SAKK 33/99. *J Clin Oncol* 29:303-309, 2011
211. Sauntharajah Y, Nakamura R, Nam JM, et al.: HLA-DR15 (DR2) is overrepresented in myelodysplastic syndrome and aplastic anemia and predicts a response to immunosuppression in myelodysplastic syndrome. *Blood* 100:1570-1574, 2002
212. Sauntharajah Y, Nakamura R, Wesley R, et al.: A simple method to predict response to immunosuppressive therapy in patients with myelodysplastic syndrome. *Blood* 102:3025-3027, 2003
213. Barrett AJ, Sloand EM: Immunosuppressive therapy for myelodysplastic syndromes: refining the indications. *Curr Hematol Malig Rep* 3:23-28, 2008
214. Fenaux P, Mufti GJ, Hellstrom-Lindberg E, et al.: Efficacy of azacitidine compared with that of conventional care regimens in the treatment of higher-risk myelodysplastic syndromes: a randomised, open-label, phase III study. *Lancet Oncol* 10:223-232, 2009
215. Burnett AK, Milligan D, Prentice AG, et al.: A comparison of low-dose cytarabine and hydroxyurea with or without all-trans retinoic acid for acute myeloid leukemia and high-risk myelodysplastic syndrome in patients not considered fit for intensive treatment. *Cancer* 109:1114-1124, 2007
216. Sekeres MA, List AF, Cuthbertson D, et al.: Phase I combination trial of lenalidomide and azacitidine in patients with higher-risk myelodysplastic syndromes. *J Clin Oncol* 28:2253-2258, 2010

217. Sekeres MA, Tiu RV, Komrokji R, et al.: Phase 2 study of the lenalidomide and azacitidine combination in patients with higher-risk myelodysplastic syndromes. *Blood* 120:4945-4951, 2012
218. Wei S, Chen X, McGraw K, et al.: Lenalidomide promotes p53 degradation by inhibiting MDM2 auto-ubiquitination in myelodysplastic syndrome with chromosome 5q deletion. *Oncogene*, 2012
219. Wei S, Chen X, Rocha K, et al.: A critical role for phosphatase haplodeficiency in the selective suppression of deletion 5q MDS by lenalidomide. *Proc Natl Acad Sci U S A* 106:12974-12979, 2009
220. Venner CP, Woltosz JW, Nevill TJ, et al.: Correlation of clinical response and response duration with miR-145 induction by lenalidomide in CD34+ cells from patients with del(5q) myelodysplastic syndrome. *Haematologica* 98:409-413, 2013
221. Platzbecker U: Allogeneic hematopoietic cell transplantation in patients with myelodysplastic syndromes. *Semin Hematol* 49:342-349, 2012
222. Hofmann WK, Koeffler HP: Myelodysplastic syndrome. *Annu Rev Med* 56:1-16, 2005
223. Cutler CS, Lee SJ, Greenberg P, et al.: A decision analysis of allogeneic bone marrow transplantation for the myelodysplastic syndromes: delayed transplantation for low-risk myelodysplasia is associated with improved outcome. *Blood* 104:579-585, 2004
224. Deeg HJ, Shulman HM, Anderson JE, et al.: Allogeneic and syngeneic marrow transplantation for myelodysplastic syndrome in patients 55 to 66 years of age. *Blood* 95:1188-1194, 2000
225. List AF: New approaches to the treatment of myelodysplasia. *Oncologist* 7 Suppl 1:39-49, 2002
226. Martino R, Iacobelli S, Brand R, et al.: Retrospective comparison of reduced-intensity conditioning and conventional high-dose conditioning for allogeneic hematopoietic stem cell transplantation using HLA-identical sibling donors in myelodysplastic syndromes. *Blood* 108:836-846, 2006
227. Lim Z, Brand R, Martino R, et al.: Allogeneic hematopoietic stem-cell transplantation for patients 50 years or older with myelodysplastic syndromes or secondary acute myeloid leukemia. *J Clin Oncol* 28:405-411, 2010
228. McClune BL, Weisdorf DJ, Pedersen TL, et al.: Effect of age on outcome of reduced-intensity hematopoietic cell transplantation for older patients with acute myeloid leukemia in first complete remission or with myelodysplastic syndrome. *J Clin Oncol* 28:1878-1887, 2010
229. List A, Kurtin S, Roe DJ, et al.: Efficacy of lenalidomide in myelodysplastic syndromes. *N Engl J Med* 352:549-557, 2005
230. List A, Dewald G, Bennett J, et al.: Lenalidomide in the myelodysplastic syndrome with chromosome 5q deletion. *N Engl J Med* 355:1456-1465, 2006
231. Fenaux P, Giagounidis A, Selleslag D, et al.: A randomized phase 3 study of lenalidomide versus placebo in RBC transfusion-dependent patients

with Low-/Intermediate-1-risk myelodysplastic syndromes with del5q. *Blood* 118:3765-3776, 2011

232. Ades L, Boehrer S, Prebet T, et al.: Efficacy and safety of lenalidomide in intermediate-2 or high-risk myelodysplastic syndromes with 5q deletion: results of a phase 2 study. *Blood* 113:3947-3952, 2009
233. Raza A, Reeves JA, Feldman EJ, et al.: Phase 2 study of lenalidomide in transfusion-dependent, low-risk, and intermediate-1 risk myelodysplastic syndromes with karyotypes other than deletion 5q. *Blood* 111:86-93, 2008
234. Kotla V, Goel S, Nischal S, et al.: Mechanism of action of lenalidomide in hematological malignancies. *J Hematol Oncol* 2:36, 2009
235. Melchert M, List A: The thalidomide saga. *Int J Biochem Cell Biol* 39:1489-1499, 2007
236. Moutouh-de Parseval LA, Verhelle D, Glezer E, et al.: Pomalidomide and lenalidomide regulate erythropoiesis and fetal hemoglobin production in human CD34+ cells. *J Clin Invest* 118:248-258, 2008
237. List AF: New therapeutics for myelodysplastic syndromes. *Leuk Res* 36:1470-1474, 2012
238. Komrokji RS, List AF: Lenalidomide for treatment of myelodysplastic syndromes. *Curr Pharm Des* 18:3198-3203, 2012
239. Giagounidis AA: Lenalidomide for del(5q) and non-del(5q) myelodysplastic syndromes. *Semin Hematol* 49:312-322, 2012
240. Westers TM, Alhan C, Chamuleau ME, et al.: Aberrant immunophenotype of blasts in myelodysplastic syndromes is a clinically relevant biomarker in predicting response to growth factor treatment. *Blood* 115:1779-1784, 2010
241. Itzykson R, Kosmider O, Cluzeau T, et al.: Impact of TET2 mutations on response rate to azacitidine in myelodysplastic syndromes and low blast count acute myeloid leukemias. *Leukemia* 25:1147-1152, 2011
242. Lane DP, Crawford LV: T antigen is bound to a host protein in SV40-transformed cells. *Nature* 278:261-263, 1979
243. Linzer DI, Levine AJ: Characterization of a 54K dalton cellular SV40 tumor antigen present in SV40-transformed cells and uninfected embryonal carcinoma cells. *Cell* 17:43-52, 1979
244. DeLeo AB, Jay G, Appella E, et al.: Detection of a transformation-related antigen in chemically induced sarcomas and other transformed cells of the mouse. *Proc Natl Acad Sci U S A* 76:2420-2424, 1979
245. Werness BA, Levine AJ, Howley PM: Association of human papillomavirus types 16 and 18 E6 proteins with p53. *Science* 248:76-79, 1990
246. Sarnow P, Ho YS, Williams J, et al.: Adenovirus E1b-58kd tumor antigen and SV40 large tumor antigen are physically associated with the same 54 kd cellular protein in transformed cells. *Cell* 28:387-394, 1982

247. Scheffner M, Werness BA, Huibregtse JM, et al.: The E6 oncoprotein encoded by human papillomavirus types 16 and 18 promotes the degradation of p53. *Cell* 63:1129-1136, 1990
248. Eliyahu D, Raz A, Gruss P, et al.: Participation of p53 cellular tumour antigen in transformation of normal embryonic cells. *Nature* 312:646-649, 1984
249. Eliyahu D, Michalovitz D, Oren M: Overproduction of p53 antigen makes established cells highly tumorigenic. *Nature* 316:158-160, 1985
250. Parada LF, Land H, Weinberg RA, et al.: Cooperation between gene encoding p53 tumour antigen and ras in cellular transformation. *Nature* 312:649-651, 1984
251. Mowat M, Cheng A, Kimura N, et al.: Rearrangements of the cellular p53 gene in erythroleukaemic cells transformed by Friend virus. *Nature* 314:633-636, 1985
252. Wolf D, Rotter V: Major deletions in the gene encoding the p53 tumor antigen cause lack of p53 expression in HL-60 cells. *Proc Natl Acad Sci U S A* 82:790-794, 1985
253. Baker SJ, Fearon ER, Nigro JM, et al.: Chromosome 17 deletions and p53 gene mutations in colorectal carcinomas. *Science* 244:217-221, 1989
254. Malkin D, Li FP, Strong LC, et al.: Germ line p53 mutations in a familial syndrome of breast cancer, sarcomas, and other neoplasms. *Science* 250:1233-1238, 1990
255. Donehower LA, Harvey M, Slagle BL, et al.: Mice deficient for p53 are developmentally normal but susceptible to spontaneous tumours. *Nature* 356:215-221, 1992
256. Lozano G: Mouse models of p53 functions. *Cold Spring Harb Perspect Biol* 2:a001115, 2010
257. Oren M: p53: the ultimate tumor suppressor gene? *FASEB J* 6:3169-3176, 1992
258. Bates S, Vousden KH: Mechanisms of p53-mediated apoptosis. *Cell Mol Life Sci* 55:28-37, 1999
259. Levine AJ, Hu W, Feng Z: The P53 pathway: what questions remain to be explored? *Cell Death Differ* 13:1027-1036, 2006
260. Wade M, Wang YV, Wahl GM: The p53 orchestra: Mdm2 and Mdmx set the tone. *Trends Cell Biol* 20:299-309, 2010
261. Shaw P, Bovey R, Tardy S, et al.: Induction of apoptosis by wild-type p53 in a human colon tumor-derived cell line. *Proc Natl Acad Sci U S A* 89:4495-4499, 1992
262. Maltzman W, Czyzyk L: UV irradiation stimulates levels of p53 cellular tumor antigen in nontransformed mouse cells. *Mol Cell Biol* 4:1689-1694, 1984
263. Kastan MB, Onyekwere O, Sidransky D, et al.: Participation of p53 protein in the cellular response to DNA damage. *Cancer Res* 51:6304-6311, 1991
264. Toledo F, Wahl GM: Regulating the p53 pathway: in vitro hypotheses, in vivo veritas. *Nat Rev Cancer* 6:909-923, 2006

265. Zuckerman V, Wolynec K, Sionov RV, et al.: Tumour suppression by p53: the importance of apoptosis and cellular senescence. *J Pathol* 219:3-15, 2009
266. Janus F, Albrechtsen N, Dornreiter I, et al.: The dual role model for p53 in maintaining genomic integrity. *Cell Mol Life Sci* 55:12-27, 1999
267. Momand J, Zambetti GP, Olson DC, et al.: The mdm-2 oncogene product forms a complex with the p53 protein and inhibits p53-mediated transactivation. *Cell* 69:1237-1245, 1992
268. Lahav G, Rosenfeld N, Sigal A, et al.: Dynamics of the p53-Mdm2 feedback loop in individual cells. *Nat Genet* 36:147-150, 2004
269. Lin J, Chen J, Elenbaas B, et al.: Several hydrophobic amino acids in the p53 amino-terminal domain are required for transcriptional activation, binding to mdm-2 and the adenovirus 5 E1B 55-kD protein. *Genes Dev* 8:1235-1246, 1994
270. Kubbutat MH, Jones SN, Vousden KH: Regulation of p53 stability by Mdm2. *Nature* 387:299-303, 1997
271. Zhang Y, Lu H: Signaling to p53: ribosomal proteins find their way. *Cancer Cell* 16:369-377, 2009
272. Fumagalli S, Di CA, Neb-Gulati A, et al.: Absence of nucleolar disruption after impairment of 40S ribosome biogenesis reveals an rpL11-translation-dependent mechanism of p53 induction. *Nat Cell Biol* 11:501-508, 2009
273. Chen D, Zhang Z, Li M, et al.: Ribosomal protein S7 as a novel modulator of p53-MDM2 interaction: binding to MDM2, stabilization of p53 protein, and activation of p53 function. *Oncogene* 26:5029-5037, 2007
274. Lohrum MA, Ludwig RL, Kubbutat MH, et al.: Regulation of HDM2 activity by the ribosomal protein L11. *Cancer Cell* 3:577-587, 2003
275. Riley T, Sontag E, Chen P, et al.: Transcriptional control of human p53-regulated genes. *Nat Rev Mol Cell Biol* 9:402-412, 2008
276. Sionov RV, Haupt Y: The cellular response to p53: the decision between life and death. *Oncogene* 18:6145-6157, 1999
277. Krizhanovsky V, Lowe SW: Stem cells: The promises and perils of p53. *Nature* 460:1085-1086, 2009
278. Murray-Zmijewski F, Slee EA, Lu X: A complex barcode underlies the heterogeneous response of p53 to stress. *Nat Rev Mol Cell Biol* 9:702-712, 2008
279. Menendez D, Inga A, Resnick MA: The expanding universe of p53 targets. *Nat Rev Cancer* 9:724-737, 2009
280. Bertheau P, Espie M, Turpin E, et al.: TP53 status and response to chemotherapy in breast cancer. *Pathobiology* 75:132-139, 2008
281. Olivier M, Hollstein M, Hainaut P: TP53 mutations in human cancers: origins, consequences, and clinical use. *Cold Spring Harb Perspect Biol* 2:a001008, 2010

282. Robles AI, Harris CC: Clinical outcomes and correlates of TP53 mutations and cancer. *Cold Spring Harb Perspect Biol* 2:a001016, 2010
283. Peller S, Rotter V: TP53 in hematological cancer: low incidence of mutations with significant clinical relevance. *Hum Mutat* 21:277-284, 2003
284. Cheung KJ, Horsman DE, Gascoyne RD: The significance of TP53 in lymphoid malignancies: mutation prevalence, regulation, prognostic impact and potential as a therapeutic target. *Br J Haematol* 146:257-269, 2009
285. Dittmer D, Pati S, Zambetti G, et al.: Gain of function mutations in p53. *Nat Genet* 4:42-46, 1993
286. Levine AJ, Vosburgh E: P53 mutations in lymphomas: position matters. *Blood* 112:2997-2998, 2008
287. Monti P, Campomenosi P, Ciribilli Y, et al.: Tumour p53 mutations exhibit promoter selective dominance over wild type p53. *Oncogene* 21:1641-1648, 2002
288. Jordan JJ, Inga A, Conway K, et al.: Altered-function p53 missense mutations identified in breast cancers can have subtle effects on transactivation. *Mol Cancer Res* 8:701-716, 2010
289. Brown CJ, Lain S, Verma CS, et al.: Awakening guardian angels: drugging the p53 pathway. *Nat Rev Cancer* 9:862-873, 2009
290. Legros Y, Lacabanne V, d'Agay MF, et al.: Production of human p53 specific monoclonal antibodies and their use in immunohistochemical studies of tumor cells. *Bull Cancer* 80:102-110, 1993
291. Bartek J, Bartkova J, Lukas J, et al.: Immunohistochemical analysis of the p53 oncoprotein on paraffin sections using a series of novel monoclonal antibodies. *J Pathol* 169:27-34, 1993
292. Vojtesek B, Bartek J, Midgley CA, et al.: An immunochemical analysis of the human nuclear phosphoprotein p53. New monoclonal antibodies and epitope mapping using recombinant p53. *J Immunol Methods* 151:237-244, 1992
293. Stephen CW, Helminen P, Lane DP: Characterisation of epitopes on human p53 using phage-displayed peptide libraries: insights into antibody-peptide interactions. *J Mol Biol* 248:58-78, 1995
294. Leppard K, Crawford L: Monoclonal antibodies displaying a novel species specificity for the primate transformation-related protein, p53. *EMBO J* 2:1457-1464, 1983
295. Gannon JV, Greaves R, Iggo R, et al.: Activating mutations in p53 produce a common conformational effect. A monoclonal antibody specific for the mutant form. *EMBO J* 9:1595-1602, 1990
296. Wade-Evans A, Jenkins JR: Precise epitope mapping of the murine transformation-associated protein, p53. *EMBO J* 4:699-706, 1985
297. Legros Y, Meyer A, Ory K, et al.: Mutations in p53 produce a common conformational effect that can be detected with a panel of monoclonal antibodies directed toward the central part of the p53 protein. *Oncogene* 9:3689-3694, 1994

298. Darcy KM, Brady WE, McBroom JW, et al.: Associations between p53 overexpression and multiple measures of clinical outcome in high-risk, early stage or suboptimally-resected, advanced stage epithelial ovarian cancers A Gynecologic Oncology Group study. *Gynecol Oncol* 111:487-495, 2008
299. Laframboise S, Chapman W, McLaughlin J, et al.: p53 mutations in epithelial ovarian cancers: possible role in predicting chemoresistance. *Cancer J* 6:302-308, 2000
300. Wen WH, Reles A, Runnebaum IB, et al.: p53 mutations and expression in ovarian cancers: correlation with overall survival. *Int J Gynecol Pathol* 18:29-41, 1999
301. Hartmann LC, Podratz KC, Keeney GL, et al.: Prognostic significance of p53 immunostaining in epithelial ovarian cancer. *J Clin Oncol* 12:64-69, 1994
302. Havrilesky L, Darcy k, Hamdan H, et al.: Prognostic significance of p53 mutation and p53 overexpression in advanced epithelial ovarian cancer: a Gynecologic Oncology Group Study. *J Clin Oncol* 21:3814-3825, 2003
303. Allred DC, Harvey JM, Berardo M, et al.: Prognostic and predictive factors in breast cancer by immunohistochemical analysis. *Mod Pathol* 11:155-168, 1998
304. Franken J, Lerut E, Van PH, et al.: p53 Immunohistochemistry expression in wilms tumor: a prognostic tool in the detection of tumor aggressiveness. *J Urol* 189:664-670, 2013
305. Zlobec I, Steele R, Michel RP, et al.: Scoring of p53, VEGF, Bcl-2 and APAF-1 immunohistochemistry and interobserver reliability in colorectal cancer. *Mod Pathol* 19:1236-1242, 2006
306. Yemelyanova A, Vang R, Kshirsagar M, et al.: Immunohistochemical staining patterns of p53 can serve as a surrogate marker for TP53 mutations in ovarian carcinoma: an immunohistochemical and nucleotide sequencing analysis. *Mod Pathol* 24:1248-1253, 2011
307. Khoury JD, Medeiros LJ, Rassidakis GZ, et al.: Expression of Mcl-1 in mantle cell lymphoma is associated with high-grade morphology, a high proliferative state, and p53 overexpression. *J Pathol* 199:90-97, 2003
308. Hernandez L, Fest T, Cazorla M, et al.: p53 gene mutations and protein overexpression are associated with aggressive variants of mantle cell lymphomas. *Blood* 87:3351-3359, 1996
309. Beckman G, Birgander R, Sjalander A, et al.: Is p53 polymorphism maintained by natural selection? *Hum Hered* 44:266-270, 1994
310. Thomas M, Kalita A, Labrecque S, et al.: Two polymorphic variants of wild-type p53 differ biochemically and biologically. *Mol Cell Biol* 19:1092-1100, 1999
311. Kononen J, Bubendorf L, Kallioniemi A, et al.: Tissue microarrays for high-throughput molecular profiling of tumor specimens. *Nat Med* 4:844-847, 1998
312. Rimm DL: What brown cannot do for you. *Nat Biotechnol* 24:914-916, 2006

313. Cregger M, Berger AJ, Rimm DL: Immunohistochemistry and quantitative analysis of protein expression. *Arch Pathol Lab Med* 130:1026-1030, 2006
314. McCabe A, Dolled-Filhart M, Camp RL, et al.: Automated quantitative analysis (AQUA) of in situ protein expression, antibody concentration, and prognosis. *J Natl Cancer Inst* 97:1808-1815, 2005
315. Laurinavicius A, Laurinaviciene A, Ostapenko V, et al.: Immunohistochemistry profiles of breast ductal carcinoma: factor analysis of digital image analysis data. *Diagn Pathol* 7:27, 2012
316. Hilbe W, Gachter A, Duba HC, et al.: Comparison of automated cellular imaging system and manual microscopy for immunohistochemically stained cryostat sections of lung cancer specimens applying p53, ki-67 and p120. *Oncol Rep* 10:15-20, 2003
317. Diaz LK, Sahin A, Sneige N: Interobserver agreement for estrogen receptor immunohistochemical analysis in breast cancer: a comparison of manual and computer-assisted scoring methods. *Ann Diagn Pathol* 8:23-27, 2004
318. Chung GG, Zerkowski MP, Ghosh S, et al.: Quantitative analysis of estrogen receptor heterogeneity in breast cancer. *Lab Invest* 87:662-669, 2007
319. Blaszyk H, Hartmann A, Cunningham JM, et al.: A prospective trial of midwest breast cancer patients: a p53 gene mutation is the most important predictor of adverse outcome. *Int J Cancer* 89:32-38, 2000
320. Kovach JS, Hartmann A, Blaszyk H, et al.: Mutation detection by highly sensitive methods indicates that p53 gene mutations in breast cancer can have important prognostic value. *Proc Natl Acad Sci U S A* 93:1093-1096, 1996
321. Thor AD, Yandell DW: Prognostic significance of p53 overexpression in node-negative breast carcinoma: preliminary studies support cautious optimism. *J Natl Cancer Inst* 85:176-177, 1993
322. Bartley AN, Ross DW: Validation of p53 immunohistochemistry as a prognostic factor in breast cancer in clinical practice. *Arch Pathol Lab Med* 126:456-458, 2002
323. Sarkis AS, Dalbagni G, Cordon-Cardo C, et al.: Nuclear overexpression of p53 protein in transitional cell bladder carcinoma: a marker for disease progression. *J Natl Cancer Inst* 85:53-59, 1993
324. Esrig D, Elmajian D, Groshen S, et al.: Accumulation of nuclear p53 and tumor progression in bladder cancer. *N Engl J Med* 331:1259-1264, 1994
325. Kudahetti S, Fisher G, Ambroisine L, et al.: p53 immunochemistry is an independent prognostic marker for outcome in conservatively treated prostate cancer. *BJU Int* 104:20-24, 2009
326. Pollack IF, Finkelstein SD, Woods J, et al.: Expression of p53 and prognosis in children with malignant gliomas. *N Engl J Med* 346:420-427, 2002
327. Geisler HE, Geisler JP, Miller GA, et al.: p21 and p53 in ovarian carcinoma: their combined staining is more valuable than either alone. *Cancer* 92:781-786, 2001



328. Ropponen KM, Kellokoski JK, Lipponen PK, et al.: p22/WAF1 expression in human colorectal carcinoma: association with p53, transcription factor AP-2 and prognosis. *Br J Cancer* 81:133-140, 1999
329. Takano S, Kato Y, Yamamoto T, et al.: Immunohistochemical detection of IDH1 mutation, p53, and internexin as prognostic factors of glial tumors. *J Neurooncol* 108:361-373, 2012
330. Reed W, Hannisdal E, Boehler PJ, et al.: The prognostic value of p53 and c-erb B-2 immunostaining is overrated for patients with lymph node negative breast carcinoma: a multivariate analysis of prognostic factors in 613 patients with a follow-up of 14-30 years. *Cancer* 88:804-813, 2000
331. Pietilainen T, Lipponen P, Aaltomaa S, et al.: Expression of p53 protein has no independent prognostic value in breast cancer. *J Pathol* 177:225-232, 1995
332. Lipponen PK: Over-expression of p53 nuclear oncoprotein in transitional-cell bladder cancer and its prognostic value. *Int J Cancer* 53:365-370, 1993
333. Underwood MA, Reeves J, Smith G, et al.: Overexpression of p53 protein and its significance for recurrent progressive bladder tumours. *Br J Urol* 77:659-666, 1996
334. Gannon JV, Greaves R, Iggo R, et al.: Activating mutations in p53 produce a common conformational effect. A monoclonal antibody specific for the mutant form. *EMBO J* 9:1595-1602, 1990
335. Lepelley P, Preudhomme C, Vanrumbeke M, et al.: Detection of p53 mutations in hematological malignancies: comparison between immunocytochemistry and DNA analysis. *Leukemia* 8:1342-1349, 1994
336. Cuddihy AR, Bristow RG: The p53 protein family and radiation sensitivity: Yes or no? *Cancer Metastasis Rev* 23:237-257, 2004
337. Tashiro H, Isacson C, Levine R, et al.: p53 gene mutations are common in uterine serous carcinoma and occur early in their pathogenesis. *Am J Pathol* 150:177-185, 1997
338. McShane LM, Aamodt R, Cordon-Cardo C, et al.: Reproducibility of p53 immunohistochemistry in bladder tumors. National Cancer Institute, Bladder Tumor Marker Network. *Clin Cancer Res* 6:1854-1864, 2000
339. Banks L, Matlashewski G, Crawford L: Isolation of human-p53-specific monoclonal antibodies and their use in the studies of human p53 expression. *Eur J Biochem* 159:529-534, 1986
340. Esrig D, Spruck CH, III, Nichols PW, et al.: p53 nuclear protein accumulation correlates with mutations in the p53 gene, tumor grade, and stage in bladder cancer. *Am J Pathol* 143:1389-1397, 1993
341. Cordon-Cardo C, Dalbagni G, Saez GT, et al.: p53 mutations in human bladder cancer: genotypic versus phenotypic patterns. *Int J Cancer* 56:347-353, 1994
342. Kamata H, Mitani S, Fujiwara M, et al.: Mutation of the p53 tumour suppressor gene and overexpression of its protein in 62 Japanese non-Hodgkin's lymphomas. *Clin Exp Med* 7:39-46, 2007

343. Stein JP, Ginsberg DA, Grossfeld GD, et al.: Effect of p21WAF1/CIP1 expression on tumor progression in bladder cancer. *J Natl Cancer Inst* 90:1072-1079, 1998
344. Lammie GA, Beckett A, Courtney R, et al.: An immunohistochemical study of p53 and proliferating cell nuclear antigen expression in progressive multifocal leukoencephalopathy. *Acta Neuropathol* 88:465-471, 1994
345. Wang YC, Lin RK, Tan YH, et al.: Wild-type p53 overexpression and its correlation with MDM2 and p14ARF alterations: an alternative pathway to non-small-cell lung cancer. *J Clin Oncol* 23:154-164, 2005
346. Lowe SW, Sherr CJ: Tumor suppression by Ink4a-Arf: progress and puzzles. *Curr Opin Genet Dev* 13:77-83, 2003
347. Vonlanthen S, Heighway J, Tschan MP, et al.: Expression of p16INK4a/p16alpha and p19ARF/p16beta is frequently altered in non-small cell lung cancer and correlates with p53 overexpression. *Oncogene* 17:2779-2785, 1998
348. Xue Q, Sano T, Kashiwabara K, et al.: Aberrant expression of pRb, p16, p14ARF, MDM2, p21 and p53 in stage I adenocarcinomas of the lung. *Pathol Int* 52:103-109, 2002
349. Moll UM, Petrenko O: The MDM2-p53 interaction. *Mol Cancer Res* 1:1001-1008, 2003
350. Koga T, Hashimoto S, Sugio K, et al.: Heterogeneous distribution of P53 immunoreactivity in human lung adenocarcinoma correlates with MDM2 protein expression, rather than with P53 gene mutation. *Int J Cancer* 95:232-239, 2001
351. Eymin B, Gazzeri S, Brambilla C, et al.: Mdm2 overexpression and p14(ARF) inactivation are two mutually exclusive events in primary human lung tumors. *Oncogene* 21:2750-2761, 2002
352. Alsner J, Jensen V, Kyndi M, et al.: A comparison between p53 accumulation determined by immunohistochemistry and TP53 mutations as prognostic variables in tumours from breast cancer patients. *Acta Oncol* 47:600-607, 2008
353. Holstege H, Joosse SA, van Oostrom CT, et al.: High incidence of protein-truncating TP53 mutations in BRCA1-related breast cancer. *Cancer Res* 69:3625-3633, 2009
354. Hashimoto T, Tokuchi Y, Hayashi M, et al.: p53 null mutations undetected by immunohistochemical staining predict a poor outcome with early-stage non-small cell lung carcinomas. *Cancer Res* 59:5572-5577, 1999
355. Visscher DW, Sarkar FH, Shimoyama RK, et al.: Correlation between p53 immunostaining patterns and gene sequence mutations in breast carcinoma. *Diagn Mol Pathol* 5:187-193, 1996
356. Jacquemier J, Moles JP, Penault-Llorca F, et al.: p53 immunohistochemical analysis in breast cancer with four monoclonal antibodies: comparison of staining and PCR-SSCP results. *Br J Cancer* 69:846-852, 1994
357. Hall PA, Lane DP: p53 in tumour pathology: can we trust immunohistochemistry?--Revisited! *J Pathol* 172:1-4, 1994

358. Gretarsdottir S, Tryggvadottir L, Jonasson JG, et al.: TP53 mutation analyses on breast carcinomas: a study of paraffin-embedded archival material. *Br J Cancer* 74:555-561, 1996
359. Marks JR, Davidoff AM, Kerns BJ, et al.: Overexpression and mutation of p53 in epithelial ovarian cancer. *Cancer Res* 51:2979-2984, 1991
360. Shahin MS, Hughes JH, Sood AK, et al.: The prognostic significance of p53 tumor suppressor gene alterations in ovarian carcinoma. *Cancer* 89:2006-2017, 2000
361. Kerns BJ, Jordan PA, Moore MB, et al.: p53 overexpression in formalin-fixed, paraffin-embedded tissue detected by immunohistochemistry. *J Histochem Cytochem* 40:1047-1051, 1992
362. Kmet LM, Cook LS, Magliocco AM: A review of p53 expression and mutation in human benign, low malignant potential, and invasive epithelial ovarian tumors. *Cancer* 97:389-404, 2003
363. Khleif SN, Doroshow JH, Hait WN: AACR-FDA-NCI Cancer Biomarkers Collaborative consensus report: advancing the use of biomarkers in cancer drug development. *Clin Cancer Res* 16:3299-3318, 2010
364. Sawyers CL: The cancer biomarker problem. *Nature* 452:548-552, 2008
365. Wiman KG: Strategies for therapeutic targeting of the p53 pathway in cancer. *Cell Death Differ* 13:921-926, 2006
366. Martins CP, Brown-Swigart L, Evan GI: Modeling the therapeutic efficacy of p53 restoration in tumors. *Cell* 127:1323-1334, 2006
367. Ventura A, Kirsch DG, McLaughlin ME, et al.: Restoration of p53 function leads to tumour regression in vivo. *Nature* 445:661-665, 2007
368. Xue W, Zender L, Miething C, et al.: Senescence and tumour clearance is triggered by p53 restoration in murine liver carcinomas. *Nature* 445:656-660, 2007
369. Boeckler FM, Joerger AC, Jaggi G, et al.: Targeted rescue of a destabilized mutant of p53 by an in silico screened drug. *Proc Natl Acad Sci U S A* 105:10360-10365, 2008
370. Bykov VJ, Issaeva N, Shilov A, et al.: Restoration of the tumor suppressor function to mutant p53 by a low-molecular-weight compound. *Nat Med* 8:282-288, 2002
371. Bykov VJ, Zache N, Stridh H, et al.: PRIMA-1(MET) synergizes with cisplatin to induce tumor cell apoptosis. *Oncogene* 24:3484-3491, 2005
372. Bykov VJ, Issaeva N, Selivanova G, et al.: Mutant p53-dependent growth suppression distinguishes PRIMA-1 from known anticancer drugs: a statistical analysis of information in the National Cancer Institute database. *Carcinogenesis* 23:2011-2018, 2002
373. Lambert JM, Gorzov P, Veprintsev DB, et al.: PRIMA-1 reactivates mutant p53 by covalent binding to the core domain. *Cancer Cell* 15:376-388, 2009
374. Lambert JM, Moshfegh A, Hainaut P, et al.: Mutant p53 reactivation by PRIMA-1MET induces multiple signaling pathways converging on apoptosis. *Oncogene* 29:1329-1338, 2010

375. Shen J, Vakifahmetoglu H, Stridh H, et al.: PRIMA-1MET induces mitochondrial apoptosis through activation of caspase-2. *Oncogene* 27:6571-6580, 2008
376. Nahi H, Merup M, Lehmann S, et al.: PRIMA-1 induces apoptosis in acute myeloid leukaemia cells with p53 gene deletion. *Br J Haematol* 132:230-236, 2006
377. Nahi H, Lehmann S, Mollgard L, et al.: Effects of PRIMA-1 on chronic lymphocytic leukaemia cells with and without hemizygous p53 deletion. *Br J Haematol* 127:285-291, 2004
378. Lehmann S, Bykov VJ, Ali D, et al.: Targeting p53 in vivo: a first-in-human study with p53-targeting compound APR-246 in refractory hematologic malignancies and prostate cancer. *J Clin Oncol* 30:3633-3639, 2012
379. Vassilev LT, Vu BT, Graves B, et al.: In vivo activation of the p53 pathway by small-molecule antagonists of MDM2. *Science* 303:844-848, 2004
380. Shangary S, Qin D, McEachern D, et al.: Temporal activation of p53 by a specific MDM2 inhibitor is selectively toxic to tumors and leads to complete tumor growth inhibition. *Proc Natl Acad Sci U S A* 105:3933-3938, 2008
381. Issaeva N, Bozko P, Enge M, et al.: Small molecule RITA binds to p53, blocks p53-HDM-2 interaction and activates p53 function in tumors. *Nat Med* 10:1321-1328, 2004
382. Enge M, Bao W, Hedstrom E, et al.: MDM2-dependent downregulation of p21 and hnRNP K provides a switch between apoptosis and growth arrest induced by pharmacologically activated p53. *Cancer Cell* 15:171-183, 2009
383. Meletis K, Wirta V, Hede SM, et al.: p53 suppresses the self-renewal of adult neural stem cells. *Development* 133:363-369, 2006
384. Dutt S, Narla A, Lin K, et al.: Haploinsufficiency for ribosomal protein genes causes selective activation of p53 in human erythroid progenitor cells. *Blood* 117:2567-2576, 2011
385. Xu H, Menendez S, Schlegelberger B, et al.: Loss of p53 accelerates the complications of myelodysplastic syndrome in a NUP98-HOXD13-driven mouse model. *Blood* 120:3089-3097, 2012
386. Zhao Z, Zuber J, Diaz-Flores E, et al.: p53 loss promotes acute myeloid leukemia by enabling aberrant self-renewal. *Genes Dev* 24:1389-1402, 2010
387. Passegue E, Weisman IL: Leukemic stem cells: where do they come from? *Stem Cell Rev* 1:181-188, 2005
388. Guan Y, Hogge DE: Proliferative status of primitive hematopoietic progenitors from patients with acute myelogenous leukemia (AML). *Leukemia* 14:2135-2141, 2000
389. Jordan CT, Guzman ML: Mechanisms controlling pathogenesis and survival of leukemic stem cells. *Oncogene* 23:7178-7187, 2004

390. Kaneko H, Misawa S, Horiike S, et al.: TP53 mutations emerge at early phase of myelodysplastic syndrome and are associated with complex chromosomal abnormalities. *Blood* 85:2189-2193, 1995
391. Kitagawa M, Yoshida S, Kuwata T, et al.: p53 expression in myeloid cells of myelodysplastic syndromes. Association with evolution of overt leukemia. *Am J Pathol* 145:338-344, 1994
392. Wattel E, Preudhomme C, Hecquet B, et al.: p53 mutations are associated with resistance to chemotherapy and short survival in hematologic malignancies. *Blood* 84:3148-3157, 1994
393. Padua RA, Guinn BA, Al-Sabah AI, et al.: RAS, FMS and p53 mutations and poor clinical outcome in myelodysplasias: a 10-year follow-up. *Leukemia* 12:887-892, 1998
394. Kita-Sasai Y, Horiike S, Misawa S, et al.: International prognostic scoring system and TP53 mutations are independent prognostic indicators for patients with myelodysplastic syndrome. *Br J Haematol* 115:309-312, 2001
395. Horiike S, Kita-Sasai Y, Nakao M, et al.: Configuration of the TP53 gene as an independent prognostic parameter of myelodysplastic syndrome. *Leuk Lymphoma* 44:915-922, 2003
396. Fenaux P, Collyn dM, Jonveaux P, et al.: Rearrangement and expression of the p53 gene in myelodysplastic syndrome and acute myeloid leukemia. *Nouv Rev Fr Hematol* 32:341-344, 1990
397. Jonveaux P, Fenaux P, Quiquandon I, et al.: Mutations in the p53 gene in myelodysplastic syndromes. *Oncogene* 6:2243-2247, 1991
398. Lai JL, Preudhomme C, Zandecki M, et al.: Myelodysplastic syndromes and acute myeloid leukemia with 17p deletion. An entity characterized by specific dysgranulopoiesis and a high incidence of P53 mutations. *Leukemia* 9:370-381, 1995
399. Christiansen DH, Andersen MK, Pedersen-Bjergaard J: Mutations with loss of heterozygosity of p53 are common in therapy-related myelodysplasia and acute myeloid leukemia after exposure to alkylating agents and significantly associated with deletion or loss of 5q, a complex karyotype, and a poor prognosis. *J Clin Oncol* 19:1405-1413, 2001
400. Fidler C, Watkins F, Bowen DT, et al.: NRAS, FLT3 and TP53 mutations in patients with myelodysplastic syndrome and a del(5q). *Haematologica* 89:865-866, 2004
401. Andersen MK, Christiansen DH, Pedersen-Bjergaard J: Amplification or duplication of chromosome band 21q22 with multiple copies of the AML1 gene and mutation of the TP53 gene in therapy-related MDS and AML. *Leukemia* 19:197-200, 2005
402. Haferlach C, Dicker F, Herholz H, et al.: Mutations of the TP53 gene in acute myeloid leukemia are strongly associated with a complex aberrant karyotype. *Leukemia* 22:1539-1541, 2008
403. Jasek M, Gondek LP, Bejanyan N, et al.: TP53 mutations in myeloid malignancies are either homozygous or hemizygous due to copy number-neutral loss of heterozygosity or deletion of 17p. *Leukemia* 24:216-219, 2010

404. Iwasaki T, Murakami M, Sugisaki C, et al.: Characterization of myelodysplastic syndrome and aplastic anemia by immunostaining of p53 and hemoglobin F and karyotype analysis: differential diagnosis between refractory anemia and aplastic anemia. *Pathol Int* 58:353-360, 2008
405. Horiike S, Misawa S, Kaneko H, et al.: Distinct genetic involvement of the TP53 gene in therapy-related leukemia and myelodysplasia with chromosomal losses of Nos 5 and/or 7 and its possible relationship to replication error phenotype. *Leukemia* 13:1235-1242, 1999
406. Kulasekararaj AG, Smith AE, Mian SA, et al.: TP53 mutations in myelodysplastic syndrome are strongly correlated with aberrations of chromosome 5, and correlate with adverse prognosis. *Br J Haematol*, 2013
407. Kikukawa M, Aoki N, Sakamoto Y, et al.: Study of p53 in elderly patients with myelodysplastic syndromes by immunohistochemistry and DNA analysis. *Am J Pathol* 155:717-721, 1999
408. Machado-Neto JA, Traina F, De Melo CP, et al.: Lack of association between MDM2 SNP309 and TP53 Arg72Pro polymorphisms with clinical outcomes in myelodysplastic syndrome. *Neoplasma* 59:530-535, 2012
409. Eclache V, Da RA, Le RG, et al.: Unusual clonal evolution involving 5q in a case of myelodysplastic syndrome with deletion 5q 31 treated with lenalidomide. *Haematologica* 93:315-316, 2008
410. Sebaa A, Ades L, Baran-Marzack F, et al.: Incidence of 17p deletions and TP53 mutation in myelodysplastic syndrome and acute myeloid leukemia with 5q deletion. *Genes Chromosomes Cancer* 51:1086-1092, 2012