

UM Libraries Depository

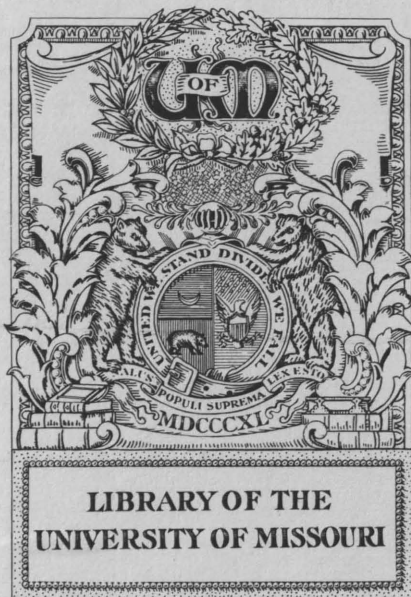

104024407015













30

THE  $\alpha$ -RAYS AND THE  $\alpha$ -PARTICLE  
A STUDY OF IONIZATION AND ALLIED PHENOMENA  
PRODUCED BY  $\alpha$ -RAYS

by

Clark Arthur Briggs, B.S.



SUBMITTED IN PARTIAL FULFILMENT OF THE  
REQUIREMENTS FOR THE DEGREE OF  
MASTER OF ARTS

in the

GRADUATE DEPARTMENT  
(COLLEGE OF ARTS AND SCIENCE)

of the

UNIVERSITY OF MISSOURI

1910





378.7M71  
XB76

23972

**\*\* C O N T E N T S \*\***

SUBJECT	PAGE
RADIO-ACTIVE SUBSTANCES (defined) .....	1.
IONIZATION OF GASES .....	1 -
RADIATIONS FROM RADIO-ACTIVE BODIES .....	3- & 7-
PATH OF CHARGED PARTICLES MOVING IN ELECTRIC AND MAGNETIC FIELDS .....	4- 5-
SOURCE OF RAYS .....	8 -
TABLE OF THE RADIUM GROUP OF THE RADIO- ACTIVE BODIES .....	10 -
$\alpha$ -RAYS, HISTORICAL DEVELOPMENT OF DIS- COVERIES .....	11 -
$\alpha$ -PARTICLE, ACCEPTED DATA ON .....	15
$\alpha$ -PARTICLE, DISCRPTION OF IONIZING ACTION AND EXPERIMENTS RELATIVE TO.....	16 -
EXPERIMENTAL PURPOSE OF WRITER .....	20 -
EXPERIMENTAL APPARATUS OF WRITER .....	22 -
EXPERIMENTAL DATA .....	24 -
EXPERIMENTAL RESULTS ( discussion).....	34 -
EXPERIMENTAL RESULTS OF OTHER INVESTIGATORS BEARING ON THE SUBJECT .....	41 -
SUGGESTED MODIFICATIONS OF EXPERIMENTS THAT WOULD CLEAR UP SOME DOUBTFUL POINTS .....	48 -
SUMMARY.....	50









## R A D I O - A C T I V E    S U B S T A N C E S

As a result of experiments by M. Henri Becquerel in 1896 we now know a certain class of chemical elements as Radio-active. A radio-active body gives off radiations that have the following effects:-

1. They will affect a photographic plate.
2. They will excite phosphorescence in some substances.
3. The rays will ionize a gas thru which they pass.

The study of the last and most important property has contributed most of our knowledge of radio-activity. Before proceeding further it may be best to outline this phenomenon.

### I O N I Z A T I O N    O F    G A S E S

The atoms of a gas are supposed to be composed of a certain amount of mass. Associated with this atomic mass are equal amounts of positive and negative electricity. The positive electricity seems to be very closely associated with the mass of the atom while the negative charge in part, seems capable of being separated from the mass.. At least the mass with which it is often associated after being separated from the atom is of the order of the  $1/1700$  part of a hydrogen atom and may be entirely electromagnetic in character. The negative charges that are capable of being separated in this manner are definite in magnitude and do not seem divisible in varying amounts.



When an atom has become separated from one or more negative charges we call the  $\nearrow$  charged atom a positive ion; the separated negative charge we call a negative ion. When a part of the ~~atoms~~<sup>molecules</sup> of a gas have become separated from a negative charge, we say that the gas is ionized.

If an electric field is placed across the ionized gas, a positive ion would experience a force driving it to the negative electrode, where it secures a negative charge or electron and becomes a normal atom. The negative ion would be driven to the positive electrode where its charge would be given to the electrode. (See Figure 1). The procession of ions in this manner would constitute an electric current passing across the gas. Such a current is sometimes called the leakage current due to ionization. Ionization is usually detected by the loss of the charge on a conductor due to these currents set up, the rapidity with which a given body loses its charge being a measure of the ionization.



**Note:**

The writer has considered that when a gas is ionized part of the atoms become separated from one or more of their negative charges. The process of ionization seemed to be of such a character as to cause doubt as to whether the general properties as to valency etc. were unaltered. Therefore the term "atom" was used.

Dr Schlundt prefers to consider ionization as present when part of the "molecules" of a gas have become separated from electrons.





## R A D I O - A C T I V E    R A D I A T I O N S

Radio-active substances (as before mentioned) possess the power of ionizing a gas in their vicinity. This is due to the radiations given off which, in passing through the gas, separate atoms or molecules into ions. This is thought to occur much in the same manner as a chip might be knocked off a clay pigeon with a bullet.

The radiations given off fall into three classes:-

1. Alpha-rays, or  $\alpha$ -rays. These rays consist of streams of positively charged particles, known as  $\alpha$ -particles, starting off with a speed of about 1/10 the velocity of light.

2.  $\beta$ -rays. These rays consist of streams of negatively charged particles shot off with a velocity approaching that of light. (Velocity of light is  $3 \times 10^{10}$  cms. per second, or about 186,000 miles per second).

3.  $\gamma$ -rays. The precise character of these rays is in dispute but they are much like the X-ray. They move with high velocity, supposed to be the velocity of light.

In order to bring out some points regarding the character of the radiations and the methods that are applied to test and determine their nature, the following relations will be outlined :-



P A T H   O F   A   C H A R G E D   P A R T I C L E  
M O V I N G   I N  
A   M A G N E T I C   F I E L D

---

An electric current consists of a procession of electric charges. The current  $\underline{i} = \frac{dQ}{dT}$ , where  $Q$  is the charge and  $T$  the time. The force  $F$  on a unit length of conductor carrying a current of strength  $\underline{i}$  in a magnetic field of strength  $H$  is  $F = i H$ , the field being perpendicular to the current. The force  $F$  is in direction perpendicular alike to  $\underline{i}$  and  $H$ .

Let  $ds$  be the length of an elementary conductor, and  $e$  a charge moving with a velocity  $\underline{v}$ ; then -

$$i ds - \text{is equivalent to} - e v$$

that is, the current  $\underline{i}$  in  $ds$  could be replaced in effect by a charge  $e$  moving with a velocity  $\underline{v}$ . This charge might be mounted on a particle of matter and shot in the given direction.

We had

$$F = i H ds = e v H$$

If the charge were on a mass  $m$  the acceleration (upon it) due to this force would be  $\frac{F}{m}$  or  $F = m a$  where  $a$  is the acceleration.

The acceleration of such a particle carrying an electric charge is always perpendicular to its direction of motion. The radius of curvature of its path may be found thus:



For circular motion we have

$$a = \frac{v^2}{r} \qquad F = \frac{mv^2}{r}$$

$$e v H = F = m \frac{v^2}{r}$$

$$\frac{e}{m} = \frac{v}{rH}$$

$$r = \frac{v}{H} \div \frac{e}{m} = \frac{v m}{H e}$$

where  $r$  is the radius of curvature.

Reference will be made to this formula later.

### ACTION OF A CHARGED PARTICLE IN AN ELECTRIC FIELD

If a charged particle moves across an electric field it will experience a force along the field, the direction depending upon the sign of the charge. If a charge  $e$  accompanied by a mass  $m$  moves across an electric field of strength  $F$  it will experience an acceleration of an amount  $\frac{F e}{m}$  which will be independent of the velocity and direction of motion. The direction of the force will depend upon the sign of the charge. The paths of such particles in a uniform electric field will be parabolas providing the particle does not collide with something.



If at the time a particle is observed it has a velocity at right angles to the field, the radius of curvature of its path is

$$r = \frac{v^2 m}{F e} .$$

If the path is then observed in an interval where the deflection is small,  $r$  is fairly constant and the above expression holds.

By means of the magnetic and electrostatic fields, some of the problems of the "radiations" may be attacked. When a magnetic field is placed across the path the radiations behave as indicated in Figure 2. If the magnetic field is toward the plane of the paper, the  $\beta$ -rays are deflected toward the right and the  $\alpha$ -rays are deflected toward the left, the  $\gamma$ -rays passing on uninfluenced. The same general phenomena occurs when an electrostatic field is placed across the path in the plane of the paper, the direction of the field being from right to left. The laws of the deflection are given in the preceding paragraph.





GENERAL    DETAILS  
ON        THE  
RADIO - ACTIVE    RADIATION

From various experiments, some of them being of this preceding character, the following conclusions have been reached:-

The  $\alpha$ -particle consists of a positively charged body of atomic or molecular magnitude. The charge is of the order of that of the hydrogen ion in electrolysis, the precise value of which will be given later. The  $\alpha$ -particles possess great ionizing power, each  $\alpha$ -particle producing about 100,000 of ions. In air at atmospheric pressure the length of the ionizing path is about 6 cms. The  $\alpha$ -particles possess but weak penetrating power, a sheet of ordinary writing paper would serve to stop practically all the  $\alpha$ -rays striking it. The velocity of the  $\alpha$ -particle at its start is  $2.5 \times 10^9$  cms./sec., or about 1/10 the velocity of light. Velocity of light is  $3 \times 10^{10}$  cms./sec., or 186,000 miles per second.

The  $\beta$ -rays are found to be streams of negatively charged particles called  $\beta$ -particles. The  $\beta$ -particle starts with a velocity approaching the velocity of light. They seem to be like a cathode stream (if they are not identical). The charge is the same as that of a hydrogen ion in electrolysis, the mass is of the order of 1/1700 of that of the hydrogen atom and may be entirely electro-



magnetic in character. Their ionizing power is not nearly as great as that of the  $\alpha$ -particles, but the penetrating power is much greater. After passing through 6 cms. of aluminum they still possess ionizing power. The  $\beta$ -rays are easily deflected by magnetic and electrostatic fields.

The  $\gamma$ -rays are not deflected by magnetic or electric fields but their penetrating power is very great. Fifty cms. of lead will not cut them off.

### S O U R C E   O F   T H E   R A Y S

In studying the source of these rays it is necessary to consider a hypothesis regarding the structure of matter. Essentially neutral matter in the ultimate form is supposed to consist of negative electrons associated with a positive charge and a mass. The number and arrangement<sup>z</sup> of the negative charges with respect to the mass determine the chemical element. In radio-active bodies the arrangement is unstable and at certain times, determined by chance, a point is reached where the forces become unbalanced. A sudden re-arrangement takes place. If a positive or a negative particle is ejected with a high velocity, we have the  $\alpha$  or  $\beta$  rays. The re-arrangement results in a system having greater or less possibilities of stability which, in the course of time suffer other changes until a final stable or inactive and permanent element is formed. It is not to be thought that the molecule or atom is a static



arrangement, but the component charges are probably in active motion and could be roughly illustrated by the solar system. The splitting-up may involve more than the loss of one negative particle; it may involve the loss of a mass with atomic or molecular magnitude.

It is found that the number of molecules of a substance that will disintegrate in a given time depends upon the number of molecules present, and in no way upon their relative age or previous history. The process can not be hastened or retarded by any physical experience that the substance suffers, at least as far as present magnitudes are concerned. The decay, as it is called, is also independent of chemical form and combination. This results in a law for the substance -

$$\frac{dN}{dt} = -k n$$

Solving

$$m = M e^{-kt}$$

where

$m$  = mass at any time

$M$  = mass at the start

$t$  = time

$k$  = a constant for the substance

$e$  = base of natural logarithms

What is known as the life of a substance is the time it takes to decay to half value.

The following table from Makower and Duff gives a list of the substances of the Radium group. Each substance experiences a radio-active change and "decays". The result is a radiation of some kind and the production of the substance next on the list.



It is subject to revision, as for the long-period substances more time will be needed to determine the values accurately:

SYBSTANCE	CHARACTER OF RADIATION	TIME TO DECAY TO HALF VALUE
Uranium	$\alpha$	$5 \times 10^9$
Uranium X	$\beta + \gamma$	22 days
Ionium	<del><math>\alpha</math></del>	
Radium	$\alpha$	1800 years
Radium Emanation (a gas)	$\alpha$	3.75 days
Radium A	$\alpha$	3 minutes
Radium B	$\beta$ slow	26 minutes
Radium C	$\alpha \beta + \gamma$	19 minutes
Radium D	no rays	40 years
Radium E <sub>1</sub>	no rays	6.0 days
Radium E <sub>2</sub>	$\beta + \gamma$ -rays	4.8 days
Radium F (polonium)	$\alpha$ -rays	143. days
Lead		





**\*\* THE  $\alpha$ -RAYS AND THE  $\alpha$ -PARTICLE \*\***

In order that the nature of the  $\alpha$ -particle be understood and to enable a fair idea to be grasped about the relative intensity of the various phenomena occurring, the following outline will be given, following in a general way the historical development of the subject.

At first the character of the  $\alpha$ -rays was little understood. They were found very active in producing ionization and easily screened.

Rutherford, (Phil. Mag. Jan. 1899) showed that the total ionization produced by the  $\alpha$ -rays was the same for any simple gas. This is only approximately true. About 1900 Sir William Crookes and R.J. Strutt suggested that the  $\alpha$ -rays might consist of positively charged particles, but were unable to observe deflection in electrostatic or magnetic fields. In 1902-03 Rutherford showed that the  $\alpha$ -rays were deflected in a magnetic field. The deflection was small but the direction and character clearly indicated that they carried a positive charge. In 1903 M. Henri Becquerel confirmed Rutherford's results by a photographic method. In addition, as the length of the path increased the radius of curvature of the deflected ray increased. Referring to the equation of a charged particle moving across a magnetic field (see pages 5 -6) we have  $e/m = v/Hr$  and  $r = vm/He$ , where  $r$  is radius of curvature,  $v$  the velocity  $H$  strength of magnetic field,  $M$  the mass and  $e$  the electric charge. Becquerel suggested that the increase of



r is due to a particle losing the charge or increasing its mass gradually as it passed along its path. However, it was shown later by Bragg and Kleeman (Phil. Mag. Dec. 1904, Sept. 1905) that this was due to  $\alpha$ -rays from radium, having four distinct velocities, each kind having the most effective photographic action at a different distance from the source.

J.J. Thompson (Nature, Dec. 15, 1904) Rutherford, (Nature, March 2, 1905) succeeded in demonstrating the positive charge carried by the  $\alpha$ -rays by the direct method of intercepting the  $\alpha$ -particles and charging up a body. This proved to be an experiment of great difficulty.

In 1903 it was noted by Crookes\*, and Elster\* and Geitel\*, that the  $\alpha$ -rays produced phosphorescence in a zinc sulphide screen, and Crookes in his spintharoscope makes use of this phenomenon. Whenever an  $\alpha$ -particle strikes such a screen it causes a very small flash of light to occur and these flashes can be viewed under a microscope. At first it was thought that but a small percentage of the  $\alpha$ -particles striking the screen produced this phosphorescence but it is now generally thought that every  $\alpha$ -particle will produce a flash if its velocity is not below the critical value.

Bragg and Kleeman (Phil. Mag. Dec. 1904 and Sept. 1905) showed that the  $\alpha$ -rays given off by radium were of several ranges or initial velocities. The particular

\* Rutherford's "Radioactivity".



substances and products giving the various  $\alpha$ -rays have been identified.

The remarkable fact was developed that as the  $\alpha$ -particle passed along its path its ionizing power increased to a maximum value after which it fell rapidly to zero. The curve, with distance and velocity as coordinates is known as a Bragg curve. In Figure 5 is such a curve taken from an article by T.S. Taylor. The detailed method of taking the curve will be discussed in another section. The active body was about two milligrams of radium bromide.

The results found by Bragg and Kleeman showed that the law of absorption of  $\alpha$ -rays in passing through matter, as given by Rutherford, could not be true. Rutherford stated that the absorption of the  $\alpha$ -rays was an exponential law, and uses the results of Bragg to support this; but this is approximately true only in narrow limits and is accidental and not fundamental.

In 1905 Rutherford (Radio-activity) pointed out the fact that the ionizing action, photographic action and phosphorescent action all stop at about the same point and that the photographic activity and ionizing action have a maximum value at about the same velocity for the  $\alpha$ -particle.

William Duane (Comptes Rendus, May 1908) made further investigations along this line and from experimental observations concluded that, at this critical velocity the



$\alpha$ -particles lost their charge and any power of producing secondary radiations, practically disappearing as far as could be determined.

At first, (1905 McKenzie and in 1906 Rutherford and Hahn) it was thought that the charge carried by the  $\alpha$ -particle was that of the hydrogen ion in electrolysis, and from the value of  $e/m$  the mass was twice that of a hydrogen atom. About this time spectroscopic observations upon the conduct of some of the radio-active substances indicated that the  $\alpha$ -particle might be in some way connected with helium.\* Rutherford, (Manchester Lit. and Phil. Soc. Mem., 1908) experimentally demonstrated that the  $\alpha$ -particle produced helium. The atomic weight is 4. It then follows that if the charge carried was that of a hydrogen ion in electrolysis the  $\alpha$ -particle was half of a helium atom. Recently, however, it has been determined that the  $\alpha$ -particle consists of a helium atom and therefore carries twice the charge of the hydrogen ion in electrolysis.

In February 1910 Mme. Curie managed to isolate a relatively large amount of polonium. It is hoped that she will be able to tell whether polonium is the parent of lead or not. She has already succeeded in confirming in an unmistakable way the later results of Rutherford by showing that the final product of the  $\alpha$ -particle is helium.

\* Regner, Ber. Akad. der Wissen., Berlin, 1909.





**\*\* PROBLEM OF THE DISSERTATION \*\***

**The Behavior Of The  $\alpha$ -particle In Passing Through  
Solids and Gases.**

In order to dispose of the generally accepted facts and data in as brief a manner as possible they will be given in the following form:

- (1) The  $\alpha$ -particle carries a positive charge.
- (2)  $\alpha$ -particles caused by any particular radio-active change are ejected with a fixed initial velocity.
- (3)  $\alpha$ -particles from different substances vary only in their initial velocity.
- (4) The values of  $e$  and  $m$  remain constant throughout the observable path. (Rutherford).
- (5) The velocity decreases as the particle proceeds. (Rutherford Phil. Mag. 12, P. 134, 1906).
- (6) In passing through metal the velocity is decreased (Rutherford, See (6)).
- (7) a. When the velocity falls below a certain fixed value the particle loses its power of ionization. For an average case Rutherford (Radio-activity) gives the critical value as about 60 per cent of its initial velocity.
  - b. The photographic and phosphorescent action stops at about this critical velocity.
  - c. The power to produce secondary radiations ceases at about this point. (H. Duane, Amer. Jour. Sc. 26, P. 464, 1908).



d. The  $\alpha$ -particle seems to lose its charge below this critical velocity. (Duane, see (c)).

That is, the  $\alpha$ -particle **apparently** becomes non-existent when its velocity has been reduced to about 60% of its original velocity. At this point the particle still should retain from 36% to 40% of its original kinetic energy.

(8) The  $\alpha$ -particle is a charged Helium atom.

(9) The charge carried by an  $\alpha$ -particle is twice that of a hydrogen ion in electrolysis.

(10) The initial velocity is  $2.5 \times 10^9$  cm./sec. (Rutherford, Radio-activity). This varies slightly with the source.

(11) The kinetic energy of an  $\alpha$ -particle is  $5.9 \times 10^{-6}$  ergs. (Rutherford Radio-activity).

(12) The potential difference through which the  $\alpha$ -particle would have to be carried to develop its initial velocity is 5.2 million volts.

(13) Number of ions formed by  $\alpha$ -particle is roughly 100,000.

(14) Value of  $e/m$  is  $6 \times 10^3$  emu (Rutherford Radio-activity).

(15)  $e = 4.69 \times 10^{-10}$  E.S.U. (Phil. Mag. Feb. 1909).

The experimental evidence as to the behavior of the  $\alpha$ -particle under different circumstances seems to vary with the method of investigation used. Upon different assumptions and view-points conflicting conclusions are reached.



In the following the different experiments and data will be discussed and the results correlated as much as possible.

The experiments which first called attention to the peculiar nature of the behavior of the  $\alpha$ -particle were performed by Bragg and Kleeman (Phil. Mag. Dec. 1904 and Sept. 1905). These experiments determined the ionization power of an  $\alpha$ -particle as the distance from the active source increased. The ideas underlying their experimental arrangement can be understood from the following:

Suppose there is an active layer giving  $\alpha$ -rays as represented at xx - - - x in Figure 3, Plate II. The region above the substance becomes ionized. In order to simplify the problem the active layer must be thin enough so that the  $\alpha$ -particles coming from the bottom will not suffer any appreciable retardation in passing through the material above it. When this is the case the particles all leave the plate with the same velocity and penetrating power. As indicated in Figure 3 the ionization at any region A is due to the particles that reach it from all directions. If now a bundle of fine tubes be placed over the active substance as shown at C, Figure 4, Plate II, the particles that make an appreciable angle with the vertical will be stopped before reaching the ionizing space above. By placing two electrodes GG (Separated a small distance) at various heights, the ionization current set up between them can be measured. The lower electrode must be gauze to allow the particles to enter and ionize the space between GG.



The experiments performed by Bragg and Kleeman were essentially an application of the method described above. The active substance used consisted of between one and two milligrams of pure radium bromide. This was dissolved in water and evaporated. The resulting layer consisted of tiny crystals of radium bromide thin enough to cause but little retardation of the  $\alpha$ -particles coming from the bottom.

As a result of their experiments it was found that as the  $\alpha$ -particle proceeded along its path the ionizing power increased, reached a maximum, and then fell rapidly to zero. Such curves are given in Figures 5 and 6. Plates III and IV. The presence of a point of maximum ionization at a distance from the radio-active body was very remarkable and unexpected. It is the cause of the peculiar shape of the ionization curve that is the subject of the present investigation.

Two explanations have suggested themselves, and are outlined in the following:

Suggestion One: This explanation is consistent with the path of the  $\alpha$ -particle being a straight line. The increase in ionization might be due to some detail of the mechanisms of the  $\alpha$ -particle and gas. As the velocity of the  $\alpha$ -particle approached a certain value it might prove more effective as an ionizer of gas atoms having a certain structure. If this be the case, the velocity of maximum ionization might be expected to vary





with the kind of gas used, and if ionization curves be taken with different gases the shapes of the curves would vary and the maxima occur at different points.

T.S. Taylor, Phil. Mag. Oct. 1909, P. 615, gives curves for hydrogen and air. The air is reduced in pressure until the limiting range is the same for the air as for hydrogen at atmospheric pressure.

These curves are reproduced in Figure 5, Plate III. The maxima are seen to occur at slightly different points and are not the same in height or value. The curves differ in detail but not in character. We might expect to find gases where the maxima occurred nearer the active body. A mixture of two gases, having marked and widely separated maxima should give an ionization curve having two maxima.

Suggestion Two: Another explanation of the phenomena as represented by the form of the curves could be that the  $\alpha$ -particle produced the same number of ions for each centimeter of its path until its power of ionizing suddenly ceased. The increase of ionization at greater distances from the active layer could be due to the particle being deflected and resulting in a more oblique path across the space traversed, as indicated, Figure 7, Plate IV. If the deflecting power was not proportional to the retardation at any velocity, but varied with the gas ionized, then, as in Suggestion One



the maxima would occur at different points for different gases. However, in contrast to supposition one, a mixture of two or more gases would give but one maximum.

\*\*\* The experimental work of the writer is designed to determine which supposition was in accord with facts.

**EXPERIMENTAL ARRANGEMENTS SUGGESTED AND USED IN**

**GETTING DATA APPEAR IN THE FOLLOWING**

Referring to Figure 8, Plate V. Let xxxxx represent an active layer sending off  $\alpha$ -particles. C represents a perforated lead plate that confines the particles getting through, to a small angle. The ionization space, GG is to be considered as fixed at a certain distance from xxxx, and is close enough to come well within the range of the  $\alpha$ -particles. Now if the path of the  $\alpha$ -particle is a straight line, the average number of  $\alpha$ -particles that pass through C and reach the space GG in a given time is independent of the height of the plate C. This plate C will be called the collimating plate. However, if the increase of ionization with distance is due to scattering or deflection of the  $\alpha$ -particles, then the ionization curve would depend upon whether C was kept next to the active layer or next to GG. The smallest ionization would be expected to occur when C was next to GG. This fact would be true whether the active substance was in a thin layer or not.



This preceding paragraph therefore outlines an experimental method that can be used to investigate the action of the  $\alpha$ -particle and was the general plan used. Several other methods suggested themselves and the apparatus partly constructed but no opportunity was had to use it.

In order to carry out the experiment it was necessary to provide a radio-active substance giving  $\alpha$ -rays. A great deal of the available time was consumed in investigating materials and methods of measurement. It was found impossible to use a thick layer of uranium oxide as under the best condition, the introduction of the lead plate C cut off so much activity that it could be detected only with difficulty.

Polonium was selected for further experiment, being a substance that gives off rays of a uniform character. An objection to this substance was that the  $\alpha$ -particles given off did not have as great a range as those from most active bodies. About half a pound of pitch-blende was treated and polonium was finally obtained, partly in solution and partly in a mixture of sulphur and a sulphide. An attempt was made to collect some of the polonium upon a button of bismuth that was rotated in the liquid containing polonium, but this method was not satisfactory. But little activity was obtained and the surface of the button became coated with a white deposit. An arrangement was made to electrolyze the solution and <sup>to</sup> get the polonium on the button in this manner but time did not permit.



The active substance was obtained by placing some of active sulphur (as I will call the active sulphide and sulphur mixture) on a glass plate and burning. There resulted a black, flaky or papery layer that was active enough to use in rough determinations.

The ionizing chamber consisted of a tin vessel 8 cms in diameter and 6.5 cms. high. The bottom opening, thru which the  $\alpha$ -particles passed, was covered with a brass screen slightly finer than the ordinary window screen. The top electrode consisted of a sheet iron or "tin" disc fastened to a wire which passed thru the top of the case. A diagram of the chamber is given in Figure 9, Plate VI.

The ions formed outside of the chamber could be carried into the space between the electrodes by a process of diffusion and by air currents. This would cause errors in the experimental observations. To get rid of this trouble a brass tube was soldered on the ionization chamber thru which air could be passed. The air before entering was passed thru glass wool to remove dust and ions that might be present. In leaving thru the bottom of the ionization chamber the air would tend to sweep back ions that would otherwise wander into the ionization space and vitiate the results. The fall of potential due to the ionization current was measured with a Dolezalek type of quadrant electrometer. The connections are shown in Figure 9. Plate VI





The position of the needle of the quadrant electrometer was read by means of a telescope and scale. With all the quadrants grounded the needle was in its zero position, the reading on the scale at this point being 10 cm. To determine the relative activity time was taken in passing from one certain reading to another. Then the relative activity was represented by the change in scale reading divided by the time. In order to allow conditions to become uniform the needle was allowed to get in motion before the time was taken. Time was taken on a stop watch, starting when the scale reading was 15 and stopping when the readings were 20, 25, 30, 35 or 40 cms., according to the strength of the active body. The "rate" which is a measure of the activity, is the before mentioned change in reading, divided by the time. The data appears in the following.



**\*\* Experimental Data \*\***

V A R I A T I O N   O F   A C T I V I T Y   W I T H  
D I S T A N C E

Activity consisted of sample of the active sulphur which had been placed in a copper tray and burned. Depth of ionization chamber .2 - .3 cms.

The Quadrant Electrometer was at ten for a zero reading. Time was observed in passing from 15 to some higher reading as is given under interval. This enabled the movement of the needle to become steadied before any observations were made.

\* Data for Curve #1. Plate VII

Zero reading: 10.0 cms. Time taken from 15 - 30 cms. or over a space of 15 cms. on the scale. Rate =  $\frac{15}{\text{Time}}$ . Collimating screen not used. "Distance" = distance between active substance and bottom of ionization chamber.

Distance	Time sec.	Rate	Distance	Time sec.	Rate
0.9 cm.	3.4	4.41	2.5 cm.	4.4	3.41
"	3.6	4.17	"	4.2	3.57
	3.4	4.41		4.0	3.75
	3.6	4.17		4.3	3.48
	3.6	4.17	2.5 cm.	(mean)	3.55
	3.2	4.68			
0.9 cm.	(mean)	4.33			
4.5 cm.	22.8	0.658	1.5 cm.	3.3	4.54
	20.3	0.739		3.2	4.68
	22.8	0.457		3.3	4.54
	26.0	0.576		3.0	5.00
	26.4	0.568		3.3	4.54
	28.4	0.528	1.5 cm.	(mean)	4.60
4.5 cm.	(mean)	0.587			

\* All data hereinafter given appears in the order in which it was taken.



At 7.0 cms. distance there was some activity but the action was so irregular that the readings could not be taken. The activity for the largest values was so great that it was difficult to time.

Data for Curve #2. Plate VII

Active material in copper tray. Lead Collimating Plate next to active sample. Zero reading 10.0 cms. Interval timed 15 to 20.

Distance	Time sec.	Rate	Distance	Time sec.	Rate
1.5 cm.	90.0	.0555	3.5 cm.	47.5	.1052
	78.3	.0641		47.0	.1063
	83.8	.0596		53.6	.0933
	84.5	.0592		51.6	.0968
1.5 cm.	(mean)	.0596	3.5 cm.	(mean)	.1004
3.0 cm.	47.5	.1052	4.0 cm.	69.0	.0724
	45.0	.1098		53.8	
	51.0	.0968		62.0	.0806
	46.8	.1067		67.0	.0745
3.0 cm.	(mean)	.1046	4.0 cm.	58.0	.0861
				(mean)	.0784
1.1 cm.	99.6	.0502	3.0 cm.	83.8	.0596
	108.6	.046		109.0	.0459
	95.0	.0526		108.2	.0462
	101.7	.0496	3.0 cm.	(mean)	.0505
1.1, cm.	(mean)	.0495			
Empty,	230.0	.02175			
for leak	130	.0312			
age.	(mean)	.026			

(Screen next ionization chamber. Action unsteady)



Data for Curve #3. Plate VIII

Active body consisted of residue left from burning some of the active sulphur on a glass plate. The black residue was treated with nitric acid and dried; this was thought to get the activity in a uniform layer. Zero reading 10.0 cms. Interval 15 - 30 cms. Colimating Plate not used.

Distance	Time sec.	Rate	Distance	Time sec.	Rate
1.4 cm.	3.8	3.95	.02 - .03	3.6	4.17
	3.6	4.17	oms.	3.5	4.28
	3.5	4.28		3.4	4.41
	3.6	4.17		3.6	4.17
	3.5	4.28		3.5	4.28
1.4 cm.	(Mean)	4.37	.02-.03 cm.	Mean	4.26
1.4 cm.	3.7	4.05	2.2 cm	4.6	3.26
Air blown	3.3	4.55		4.8	3.12
through	3.6	4.17		4.7	3.19
chamber.	3.4	4.41		4.7	3.19
	3.2	4.68		4.6	3.26
1.4 cm.	(mean)	4.37	2.2 cm.	(mean)	3.20
0.8 cm.	3.6	4.17	3.2 cm.	10.6	1.414
	3.4	4.41		14.0	1.071
	3.6	4.17		16.1	.932
	3.2	4.68		10.6	1.414
	3.5	4.28		13.2	1.137
0.8 cm.	(mean)	4.34	3.2 cm	(mean)	1.194
3.2 cm.	17.0	-	4.0 cm	68.0	.2205
Air cur-	12.0	1.25	Air cur-	80.0	.1874
rent on.	13.5	1.11	rent on.	77.8	.1925
	12.4	1.21		80.6	.1860
	13.8	1.087		94.2	.1592
	13.2	1.137	4.0 cm	(mean)	.1891
3.2 cm.	(mean)	1.159		(Very irregular)	
Empty	230	.0217			
	265	.0187			
		.0202			





Data for Curve #4. Plate VIII

Sample same as preceding. Distance from collimating screen to active surface 0.2 cms. Zero reading 10.0 cms. Interval timed 15.2 cms.

Distance	Time sec.	Rate	Distance	Time sec.	Rate
2.0 cm.	49.0	.102	2.0 cm	51.0	
	43.2	.1157		43.2	.1156
	36.0	.1389	Air cur-	41.2	.1212
	49.0	.102	rent flow-	39.4	.1270
	39.3	.1272	ing.	37.0	.1350
2.0 cm.	(mean)	.1172		37.6	.1330
Action rather irregular			2.0 cm	(mean)	.1318
			Action regular		
1.0 cm	61.4	.0815	3.0 cm	47.0	.1063
	67.8	.0737		40.0	.1250
Air current	70.8	.0705	Air current	39.8	.1256
flowing.	50.5	-	flowing.	37.7	.1327
	79.8	.0627		33.8	.1480
	67.5	.0740	3.0 cm.	(mean)	.1275
1.0 cm	(mean)	.0725			
4.0 cm.	75.3	air			
	48.0	no air			
	56.2	no air			
	42.7	no air			
	74.8	air			

Last observation results extremely irregular. Air seems to decrease activity where in preceding cases it increased it.

Data for Curve #5a. Plate IX

Added active sulphur to sample and burned off the sulphur. Did not treat the residue as before. Sample of glass. Collimator as before. Zero reading 10.0 cms. Interval timed 15 - 20 cms.



Distance	Time sec.	Rate	Distance	Time sec.	Rate
4.0 cm.	33.0	.1514	3.0 cm.	25.0	.200
	33.7	.1484		25.0	.200
	32.2	.1552		23.2	.216
	40.0	.1250		25.0	.200
	36.0	.1388		25.0	.200
4.0 cm.	(mean)	.1437	3.0 cm.	(mean)	.203
3.5 cm.	26.0	.1923	2.5 cm.	26.8	.1860
	31.2	.1603		26.0	.1922
	27.2	.1838		27.5	.1820
	30.2	.1655		24.6	.2030
	31.3	.1597		22.8	.2190
3.5 cm.	(mean)	.1723	2.5 cm.	(mean)	.1965
2.0 cm.	27.1	.1845	1.5 cm.	35.5	.1408
	29.1	.1715		33.2	.1505
	28.8	.1735		27.3	.1833
	29.4	.1700		32.6	.1533
	29.5	.1600		42.0	.1190
2.0 cm.	(mean)	.1738	1.5 cm.	(mean)	.1456
1.0 cm.	39.2	.1275	1.0 cm.	41.0	.1220
	33.5	.1496		(mean)	.1252
	42.8	.1168			
	45.2	.1105			
	41.0	.1220			

## Data on Curve #5b. Plate IX.

Arrangement same as for 5a except collimator is placed just beneath the ionization chamber.

Distance	Time sec	Rate	Distance	Time sec.	Rate
2.5 cm	64.4	.0777	3.3	75.4	.0663
	52.2	.0959		70.6	.0708
	67.4	.0742		93.7	.0533
	81.2	.0616		90.8	.0551
	70.8	.0696		92.2	.0542
2.5 cm	(mean)	.0758	3.3 cm	(mean)	.0599



Data on Curve #6. Plate IX

Sample strengthened by the addition of more of the active substance. Distance between the electrodes increased 0.6 cm. Zero reading 10 cm. Interval timed 15-20 cms.

Distance	Time sec	Rate	Distance	Time sec	Rate
3.0 cm	70.2	.0712	3.9 cm. (Too weak to determine activity).		
	70.8	.0705			
	71.4	.0700			
	57.6	.0868			
	66.0	.0757			
3.0 cm	(mean)	.0748			
1.6 cm	39.0	.1283	2.1 cm	46.2	.1082
	41.0	.1220		43.0	.1163
	39.8	.1257		43.6	.1147
	39.2	.1276		44.2	.1130
	38.4	.1303		45.0	.1111
1.6 cm	(mean)	.1268	2.1 cm	(mean)	.1127
2.5 cm	56.4	.0897	1.0 cm	32.4	.1543
	52.3	.0956		32.1	.1557
	43.0	.1161		33.4	.1497
	51.8	.0965		32.3	.1548
	53.0	.0944		34.0	.1470
2.5 cm	(mean)	.0982	1.0 cm	(mean)	.1523

Data on Curve #7a. Plate X

Distance between electrodes 0.6 cms. Collimator next to active layer. Zero reading 10 cms. Interval timed 15 - 20 cms.

Distance	Time sec.	Rate	Distance	Time sec.	Rate
1.1 cm	29.4	.1700	1.5 cm	24.0	.2083
	34.0	.1470		28.0	.1785
	33.7	.1484		29.3	.1706
	36.4	.1374		26.4	.1894
	30.8	.1623		25.8	.1938
1.1 cm.	(mean)	.1530	1.5 cm.	(mean)	.1881



Distance	Time sec.	Rate	Distance	Time sec.	Rate
2.0 cm	24.0	.2083	2.5 cm	21.0	.2380
	20.8	.2430		21.8	.2292
	24.6	.2032		21.5	.2325
	21.8	.2293		22.9	.2185
	20.2	.2475		22.2	.2250
2.0 cm	(mean)	.2262	2.5 cm	(mean)	.2286
3.0 cm	40.2	.1243	3.5 cm	42.4	.1033
	37.1	.1348		55.7	.0897
	43.3	.1154		42.7	.1170
	42.5	.1175		53.0	.0943
	34.8	.1436		45.2	.1106
3.0 cm	(mean)	.1271	3.5 cm	(mean)	.103
4.0 cm.	60.7	.0810	Empty, active bo- dy removed.	178	.0381
	101.0	.0495		230	.0217
	104.0	.0481		150	.0333
	61.6	.0812		227	.0220
	75.2	.0665		180	.0270
4.0 cm (Unsteady)	(mean)	.0655	(mean)	.0286	

At this point the collimating plate was grounded. This set up an electric field between the mouth of the ionization chamber and plate. Ions in the space beneath the chamber were then deposited on the gauze covering the ionization chamber and on the plate. (See Figure 9). This prevented them from entering the ionization chamber.

Data on Curve #7b. Plate X

Collimator placed over active layer and grounded. Ionization space in chamber 0.6 cms. Zero reading 10.0 cm. Interval timed 15 - 20 cms.





Distance	Time sec.	Rate	Distance	Time sec.	Rate
4.0 cm	197	.0254	2.5 cm	75.8	.0660
	205	.0244		82.0	.0610
	194	.0258		76.0	.0668
	170	.0294		76.0	.0668
	178	.0281		79.2	.0631
4.0 cm	(mean)	.0266	2.5 cm.	(mean)	.0647
3.5 cm.	123	.0417	2.0 cm	63.0	.0794
	148	.0338		73.7	.0678
	143	.0394		73.0	.0685
	135	.0370		71.0	.0704
	135	.0370		73.6	.0680
3.5 cm.	(Mean)	.0369	2.0 cm	(mean)	.0708
3.0 cm	93	.0538	1.5 cm	62.0	.0806
	96	.0521		59.0	.0847
	91	.0549		64.8	.0771
	83	.0602		59.2	.0845
	94	.0532		60.0	.0833
3.0 cm	(mean)	.0548	1.5 cm	(mean)	.0820

Ground removed from collimator to check values:

1.5 cm	31.8	.1572
	32.0	.1562
1.5 cm	(mean)	.1567

The grounding of the collimator produced an unexpected result. The last two values taken show that the result is not due to any failure of the apparatus.

#### Data for Curve #8. Plate X

The arrangement is the same as for curve #7b except that the electric fields are reversed. Zero reading 10.0 cms. Int Interval timed 15 - 20 cms.

Distance	Time sec.	Rate	Distance	Time sec.	Rate
1.5 cm	54.2	.0922	3.0 cm	72.5	.0689
	56.7	.0882		79.8	.0626
	58.8)	.0849		88.7	.0564
	69.0	-----		79.8	.0626
	80.2	-----		80.4	.0622
	60.0	.0833		3.0 cm	(mean)
66.0	.0757				
1.5 cm	(mean)	.0849			



Distance	Time sec.	Rate	Distance	Time sec.	Rate
1.1, cm.	60.6	.0824	3.5 cm	115	.0434
	56.8	.0880		123	.0407
	50.7	.0877		111	.0450
	58.4	.0855		119	.0420
	53.0	.0943		123	.0407
1.1 cm	(mean)	.0894	3.5 cm	(mean)	.0424
2.0 cm	62.8	.0796	4.0	119	-----
	58.7	.0852		174	.0387
	65.4	.0765		168	.0298
	62.6	.0799		188	.0266
	58.8	.0850	4.0 cm	(mean)	.0281
2.0 cm	(mean)	.0808			
2.5 cm.	67.1	.0745	Empty	270	.0185
	68.8	.0726		265	.0189
	75.0	.0666		265	.0189
	69.3	.0721		(mean)	.0188
	78.0	.0640			
2.5 cm	(mean)	.0699			

Data to determine the effect of varying the position of the collimating screen, keeping the distance between the active substance and ionization chamber constant.

Active sample prepared and placed in small copper tray. "Col-Distance" - the distance from top of lead collimator to ionization chamber. Distance between the active layer and mouth of chamber 2.4 cms. Zero reading 10.0 cms. Interval timed 15 - 20 cms. Collimator plate grounded. Distance between electrodes 1.6 cms.



Distance	Time	Rate
1.2 cms.	67.8	.0737
	74.0	.0675
	64.8	.0782
	51.0	.0980
	58.8	.0844
1.2 cm.	(Mean)	.0804

Distance	Time	Rate
0.2 cms.	65.4	.0764
	66.0	.0754
	72.8	.0634
	54.0	.0926
	62.0	.0805
0.2 cm.	(mean)	.0789

0.2 cms.	45.2	.1107
	50.0	.1000
	44.3	.1129
	46.8	.1068
0.2 cms.	(mean)	.1076

Collimator not grounded  
but connected to ioniza-  
tion chamber.



DISCUSSION OF RESULTS

The first observations, Curve 1, were taken without the collimating plate but the sample occupied only a small area and the curve was such as might be expected. The mouth of the ionization chamber was small enough to act roughly as a collimator. From an examination of the curve it would seem that the active substance was in a sensibly thin layer; otherwise the decided maximum would not have occurred.

In Curve 2, the collimating plate was used next to the active substance. A great part of the activity was cut down due to the material interposed. The maximum is shifted and occurs at a greater distance. This was in agreement with the supposition that the apparent increase in activity as the particle travels along its path is due to deflection and scattering. After the collimating plate was introduced the particles getting thru would have parallel directions and the particles that were particularly effective in producing the maxima in Curve 1 would be cut off. The result should be that the maximum should occur further from the active body.

The point marked  $\square$  on curve sheet was taken with the collimator moved next to the ionization chamber. The value is less than when the collimator was next to the radiating body. This should not be the case if the path of the  $\alpha$ -particle was a straight line but should occur if scattering was present.





Curve 3 was taken in a similar manner to Curve 1, the collimating plate being removed. With this curve the effect of diffusion was investigated. The results proved unreliable later but are valuable in showing limitations. When Rutherford in 1899 succeeded in proving that the  $\alpha$ -particle carried a positive charge he avoided the effect due to diffusion of ions and the emanation, by passing a gentle draft of air thru the apparatus in a direction that would sweep them back. The method was found effective. The observations were made upon a gold leaf electroscope so that the air current must have been very small. The same idea was used here. Air was passed into the ionization chamber thru the tube provided (see Figure 9). The air passing out the bottom would prevent ions formed in the space beneath from entering the chamber.

The first two sets of observations were made alike, except that for the second set the air current was passed thru the chamber. The results, figured on a slide rule, came out exactly alike (an accidental detail) and it would seem that the diffusion played but a small part. This is the same conclusion that Bragg came to in the first of his experiments. (Phil. Mag. Dec. 1904). However, in later experiments he found that this diffusion was present and had to be eliminated.



The other points on the curve were then taken without the air current. In spite of the fact that the active sample was not the same as used in Curve 1, the curves are very much alike. This was taken as an indication that diffusion was not influencing the results, for if diffusion occurred to any extent the irregularities (due to change in air current) would cause greater differences between curves 1 and 3.

A comparison was also made, with and without air, when the ionization chamber was at 3.2 cms., resulting in a change in average rate from 1.194 to 1.159 when the air was used. The change is 3% and the experimental error is probably greater.

In results shown by Curve 4 the collimating plate being used, the general shape of the curve was like Curve 2 as far as it went. However, at a distance of 4 cms. the air current seemed to reduce materially the activity registered. The readings at this point were so irregular that they were discontinued. The needle would oscillate over wide readings and the general average movement could only be estimated with difficulty. The effect of the air current was tried with the distance 2 cm. and the ionization was increased from .1172 to .1318.

Curve 5a represents the results taken with the collimator placed over the active layer. More material had been added to the layer to increase the activity. The result shows a sharp maximum at a distance of about 3 cms.



The collimator was then placed next to the ionization chamber and the ionization curve taken as before. This is shown in Curve 5b. The distance between the electrodes in the ionization chamber was increased and the data taken as in 5b; the result being shown in curve 6. The reason that the curves 5a and 5b have a common point is that at this position there was no space to vary the collimator between them. This was the starting point for the curve for either the collimating plate next the ionization chamber or next to the active layer. The results at this point were interpreted as follows: The curves taken at different times under the same general conditions agreed closely. If diffusion played a large part, variations should be expected as changes in the air currents would produce variations in the effective diffusion. Also the changes produced in using the current of air were comparatively small. The conclusion was reached that diffusion was a small factor in producing error though this conclusion proved later to be unjustified.

The curve obtained with the collimating plate next to the active substance gave a maximum value at 3 cms. and from this the conclusion was drawn that the active substance was in a sensibly thin layer. The curve obtained when the collimating plate was next to the ionization chamber gave steadily decreasing ionization as the distance increased. The result is what was expected if the increase of ionization was due to scattering.



In order to check the conclusion that the diffusion was negligible it was decided to dispose of the ions formed outside of the ionization chamber in another way. This was done by grounding the collimating plate to the cage in which the apparatus was installed. The ionization chamber was connected to one terminal of the battery and the cage to the other so that the ions formed outside the chamber were caught and deposited upon the plate or lower electrode.

In order to form a check on Curve 5a the values obtained for Curve 7a were taken. The electrodes were further apart than for 5a and it was desirable to see whether they were too far apart to get results. The effect of increasing the distance between the electrodes was to increase the sensibility by reducing the capacity of the charged circuit. At the same time the ionization space was increased, increasing the effective ionization. The results gave the maximum as in Curve 5a but the curve was more rounded due to greater distance between electrodes. Also, as the distances were measured from the bottom electrode the maximum apparently occurred nearer the active surface.

Curve 7b, Plate X . The data for this curve is the same as for Curve 7a except that the collimating plate is grounded. A remarkable difference occurred. The curve no longer had a maximum and the ionization decreased steadily until the limit of ionization was reached. The potential difference necessary to establish an  $\alpha$ -particle in its initial velocity would be something like 5,200,000 volts;





the potential difference in the field beneath the instrument was about 115 volts, so if the ionization recorded was produced directly by the  $\alpha$ -particle there would be no observable change in ionization if the field beneath the ionization chamber was reversed.

The data for Curve 8 was taken in this way. There is no change in the character of the curve. This would indicate that the ionization was not due to any slow moving secondary effect set up but probably due directly to the  $\alpha$ -particle. The last two curves, 7b and 8, show that the conclusions reached in considering the preceding curves, are not as final as first thought. It would seem that the air blast was not sufficient to prevent or even greatly modify the diffusion of ions into the ionization chamber.

If it is now assumed that the curves preceding 7b and 8 owe their form to the effect of diffusion and that 7b and 8 give the ionization curves after effectively disposing diffusion then new conclusions will have to be reached. First, the radio-active material was not distributed in a thin layer; second, new data will have to be secured to arrive at an explanation.

The data and values of activity found to cover this last need are found at the end of the curve data, the information taken not being presentable as a curve. The distance between the active layer and the mouth of the ionization chamber was 2.4 cms. A greater distance made the ionization too weak to measure. The thickness of the lead collimating plate was about 1 cm. and the distance that it could be varied was 1.3 cms.



The results gave an ionization of relative value of .0804 when the collimator was next to the active body, and .0789 when the collimator was next to the ionization chamber. This variation is about the amount to be expected from experimental error. When the ground was removed from the collimating plate in the second case the leakage rate increased to .1076, showing that it was very necessary to have the electric field beneath the electrodes.

This last evidence is strongly in favor of the supposition that the ionization is produced by  $\alpha$ -particles moving in approximately straight lines.

The results of the experiments performed by the writer are limited in interpreting only the most general behavior. While it would appear that the results point to the fact that the  $\alpha$ -particle travels in sensibly straight lines, yet there is a small possibility of secondary effects. Before the possibilities of this method of investigation would be exhausted it would be necessary to perform the experiments with substances of strong activity and greater range, and employ more refined apparatus. With an active body possibly 10,000 times as strong as the one used, and an arrangement for examining the effect under reduced pressure, small details and variations in the general average path of the  $\alpha$ -particle could be followed and measured.



EXPERIMENTAL RESULTS REGARDING THE  
ALPHA PARTICLE  
OBTAINED BY VARIOUS INVESTIGATORS

In 1906 Rutherford carried out a series of experiments to determine with some degree of precision the paths of the  $\alpha$ -rays in electric and magnetic fields. The particular question that was being investigated was the variation of path curvature as the velocity decreased. A narrow stream or beam of  $\alpha$ -rays was used and the path was followed by means of the photographic action of the rays. The experiments are given in Philosophical Magazine, Vol. 11, 1906, and Vol. II, P. 134, 1906. p. 176

The photographs clearly indicated that a scattering occurred. When the rays passed through a vacuum the impressions were sharp and well defined, but in passing through air the scattering was plainly evident. This scattering seemed to increase rapidly as the velocity of the  $\alpha$ -particles decreased. The  $\alpha$ -rays, after passing through aluminum foil showed a marked increase in scattering. The scattering was relatively greater than the retardation produced.

Becquerel, Philosophical Magazine, Vol 11, p. 722, gives a photograph of some  $\alpha$ -ray traces obtained upon an inclined photographic plate. Though a great amount of detail is lost in the cut, yet the scattering is clearly indicated. The rays that passed through aluminum showed more scattering than retardation; this is an important



point and agrees with what has been derived from Rutherford. However, it is to be noted that the scattering indicated is not of any great magnitude as if it were the photographic impression would fade out.

Important experiments were made by H. Geiger and E. Marsden (Proc. Royal Soc. May 19, 1909). The effect of reflection was investigated in a very direct way. A glass tube AB (see Figure 14, Plate XI,) contained radium emanation giving off  $\alpha$ -particles. These particles passed out a thin mica window at B and struck a screen interposed at RR. P was a plate to cut off direct  $\alpha$ -rays from reaching a scintillating screen SR. The scintillations produced by  $\alpha$ -particles striking a given region in SR were counted by observing thru a microscope M. With a strong active sample in AB it was found that scintillations were produced on SR. In order that an  $\alpha$ -particle strike and produce a scintillation on SR it would have to be deflected  $90^\circ$  from its initial direction so that the reflections that were observed had to be of some angular magnitude. Different substances were tried as a reflecting surface at RR and the results are given in the following.





Metal	Atomic Weight	Number of Scin. per min.	Atomic weight scin./min.
Lead	207	63	30
Gold	197	67	34
Platinum	195	63	33
Tin	119	34	28
Silver	108	27	25
Copper	64	14.5	23
Iron	56	10.2	18.5
Aluminum	27	3.4	12.5
Air alone	--	1. (about)	

That this so-called reflection is really a scattering was indicated from the following result. With one layer of gold foil at RR a certain number of particles were reflected per minute; when the number of foils was increased the reflected particles increased. With 30 layers a maximum was reached and the number of scintillations produced was about 6 times the number produced by one foil and air. This result is greatly in favor of the probability that the reflection is really a scattering that occurs with the material.

The second figure, Figure 15, is the diagram of the method used to test the reflecting power of R at various angles of incidence. The reflection was independent of the angle, except at grazing incidence when the number of particles reflected increased many times. This is important, as it shows the necessity of taking pre-



cautions in experiments where some forms of screening are used. For instance, where it is desired to get a narrow beam of  $\alpha$ -rays from a definite solid angle, a straight tube confining the rays is liable to give erroneous results. Referring to Figure 16 the scheme (a) is a method that would cause errors due to reflection that (b) would eliminate.

The relative number of particles that were reflected in any case was small, to quote from the article "Three different determinations showed that of the incident  $\alpha$ -particles about one in eight thousand was reflected."

EFFECT PRODUCED ON ALPHA RAYS IN  
PASSING THRU METAL  
FOILS

Some general results of causing the  $\alpha$ -rays to pass thru metal foils have been mentioned in the historical sketch. Some of the effects will now be taken up in detail. The ionization produced by  $\alpha$ -rays coming from a thin metal foil, as indicated at "f", the result is to cut out a portion of the curve and the ionization is represented by curve 2. If another similar metal foil is introduced the resulting curve is given in curve 3, each layer of the foil cutting down the range of the  $\alpha$ -rays an equal amount. The result is about the same as though the  $\alpha$ -rays had passed thru a certain extra thickness of



of air instead of the foil. In other words, the metal has the effect of a certain thickness of air and this air thickness is called the air equivalent of the metal foil.

That is, observations made the ionization curve after introducing the metal foils give the curve about the same form and about the same maximum. But these results are not obtained with sufficient accuracy to say the form and maximum are exactly the same. The effect of the  $\alpha$ -rays passing thru two or more foils of different materials was not altered by changing the order in which they were arranged. From this fact Rutherford concluded that the retardation was independent of the velocity of the entering particle. However, another phenomena is present. If the foil is moved from the distance corresponding to  $t$  to  $t'$  the ionization would change from 3 to 4. That is, the air equivalent changes with the position of the metal foil. The result was interpreted by Bragg as indicating that the retardation was not independent of the velocity of the entering particle. T.S Taylor, (Amer. Jour. of Science, Vol. 26, p. 169, and Phil. Mag. Vol. 18, p. 604, 1909) carried out experiments in which the range of the  $\alpha$ -particle was supposed to be measured as the metal foil was moved from the active substance. He found that the air equivalent of a metal foil decreased as the foil was moved away from the active layer.

The change in range was not observed directly but



from measurements made on the ionization curve under different circumstances. The results were obtained, making the following assumptions:

- (a) The  $\alpha$ -particles travel in straight lines.
- (b) The form of the terminal portion of the ionization curve was not altered upon introducing the metal foil.
- (c) The maximum was not changed in value when the foil was introduced.

In regard to (a) some scattering was detected by him but disregarded as it was assumed to be small. (b) and (c) are not accurately determined facts, as data of sufficient refinement have not been secured to accept as true.

The results of Taylor can consistently be explained by scattering in spite of the fact that he thinks he has proven the case against it. Taylor finds that the ionizing power at a distance from the active body is reduced more when a metal foil is placed next to the active source than when placed nearer to the point at which ionization is observed.

The fact has been previously pointed out that the scattering produced by  $\alpha$ -rays passing thru metal foils was relatively greater than the retardation. That is, a metal foil increased the scattering to a greater extent than it reduces the velocity. In this we have a very probable explanation of the results obtained from Taylors experiments.







Referring to Figures 18 and 19, Plate XIII, we have a diagram of what the conditions might be. A narrow beam of  $\alpha$ -rays comes from a small opening and passes upward to the ionization electrodes, GG, between which the ionization current passes. With the foil  $f$  as in Figure 19 more particles would reach the electrodes than with  $f$  as in Figure 18. In moving  $f$  toward GG the air equivalent would apparently decrease. The above method will in every case anticipate the character of results found by Taylor in his various combinations of metal and gas layers.

From the preceding work we can now state the conclusions as follows:

(1) As far as it can be followed the path of the  $\alpha$ -particle is approximately a straight line.

(2)a Scattering of the  $\alpha$ -particles occurs and a small per cent of them are capable of being deflected thru large angles.

(2)b The scattering increases as the velocity decreases.

(2)c The scattering effect of a substance increases with its atomic weight and increases more rapidly than the retarding effect.

Question: How far does the scattering affect the various phenomena observed?

The reply is: Experiments carried up to date are not final and will need be modified before we can get further information.



The results of Taylor's experiments could be checked by a modification of apparatus used. By employing a scintillating method the question of how far scattering was responsible for an apparent change in the air equivalent could be studied.

Referring to Figure 20, Plate XIV, a narrow pencil of  $\alpha$ -rays coming from A would produce scintillations upon screen S. The number reaching the screen during any time could be observed by means of the microscope M. The screen S must be well within the range of all the  $\alpha$ -particles. If "f" represents a metal foil, the effect upon scattering at various distances can be observed by means of the scintillations produced at S in a given time. One precaution, however, is necessary. The geometrical path of the rays as formed by the collimator at A must be narrow or the metal foil f will scatter as many  $\alpha$ -particles on to S from other initial paths as it scatters away from S particles that would originally reach it.

If new features did not appear this method would dispose of an important question relative to the cause of the results obtained by Taylor. Another possibility is present which could account for some of the phenomena shown by the  $\alpha$ -particle. Heretofore we have only considered a gradual or continuous scattering as taking place. There is a slight possibility that the  $\alpha$ -particle travels for some distance in a straight line and when



deflection occurs it is large and instantaneous.

To investigate this an arrangement used by H. Geiger (Proc. Roy. Soc. May 18, 1909) could be modified and employed. A diagram of the apparatus is given in Figure 21, Plate XV.

The parts were mounted in glass chambers M and N which could be exhausted separately. The radio-active substance was placed at R and measurements were made upon the ionization produced in NL by the  $\alpha$ -particles passing through the window L. The opening L was small and covered with a thin sheet of mica. This mica was sufficiently thin to cause but little retardation in the  $\alpha$ -particles passing through, but being over a small opening it was strong enough to enable a large difference in pressure to be maintained between N and M.

The ionization current measured was that which passed between electrodes B and C. The function of electrode A was to act as a guard ring. The ionization curve was taken in the following way: The pressure in chamber N was lowered until the ionization measured between B and C corresponded to a thin layer of gas at atmospheric pressure. The effect of varying the distance LR was obtained by varying the pressure in the part M. The curve in Figure 6, Plate IV, was obtained in this manner.

This method did not avoid any effect of scattering as shown by the path of the particle marked S,SS. The general scattering could be eliminated by use of an op-



ening of the type shown in (b) Figure 16 at the point L. It seems to the writer that such a modified experiment would be valuable.

The other form of scattering has been suggested where the deflection of the particles was abrupt. The path of such a particle that travels with little deflection up to a certain point and then becomes deflected through large angles is shown at S'S'S'.

A further modification of Geiger's apparatus would enable this last point to be tested. If the electrodes AB and C were arranged so that the distance BC could be varied, then any scattering of the kind under consideration would cause the ionization current to increase as the electrodes were moved farther apart.

**\*\* S U M M A R Y \*\***

The experimental results obtained in investigating the action of the  $\alpha$ -particle under various circumstances tend to lead to conflicting conclusions.

The experiments of Rutherford, Becquerel and others show that the  $\alpha$ -rays suffer small scattering. The results of Geiger show that a small percent of the  $\alpha$ -particles undergo marked deflection. The photographic results of Rutherford and Becquerel, and the experiments of the writer, do not suggest that the shape of the ionization curve is due to scattering. On the other hand the





results of a large number of experiments can be anticipated if scattering be assumed to be a large factor.

Further investigation is necessary before further progress can be attained.

By modifying some of the experimental arrangements that have been used in the past, information leading to final conclusions can be reached.



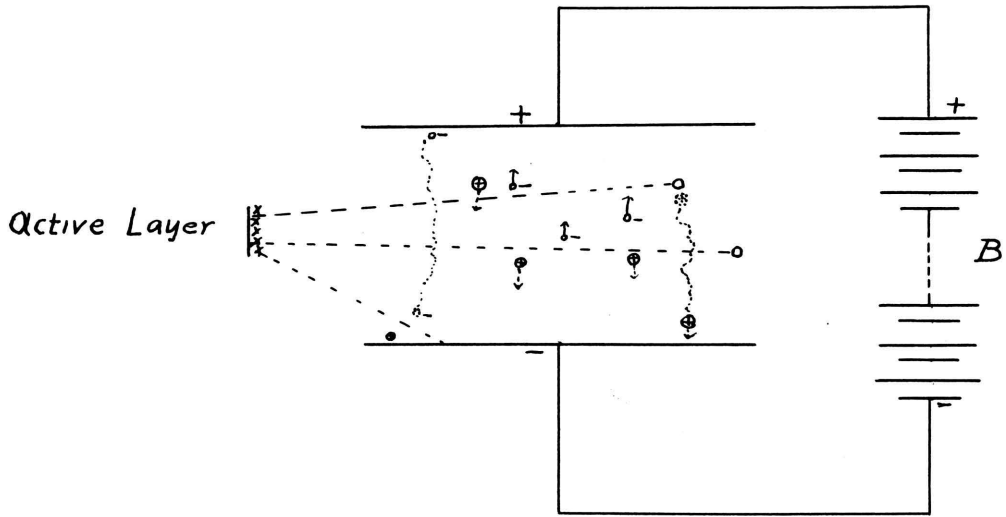

Fig. 1.

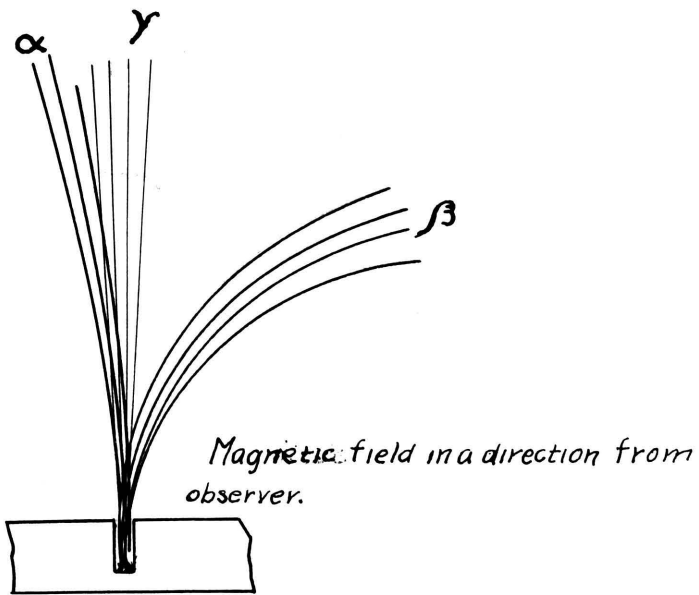

Fig 2.



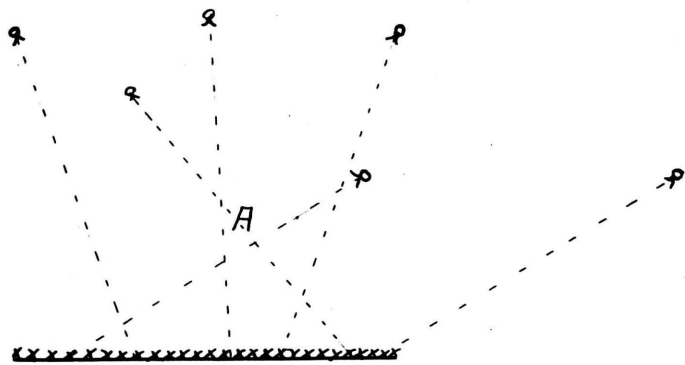

Fig. 3.

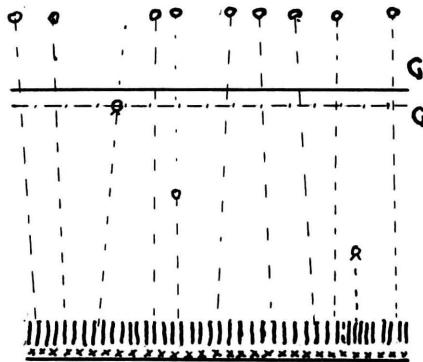
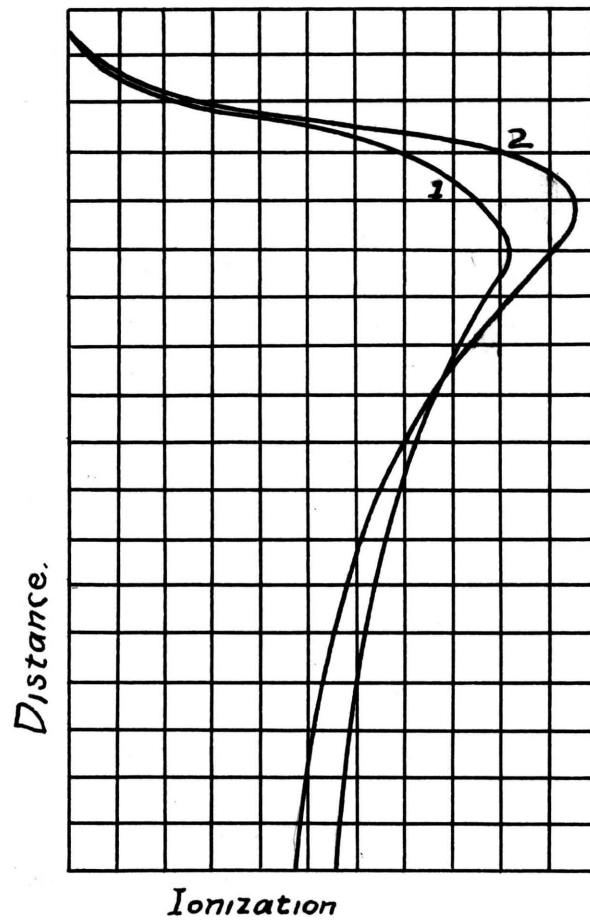

Fig. 4.





Curve 1. for air at 17cm. of mercury

Curve 2 for hydrogen at normal pressure.

From Phil. Mag. Oct. 1909.

Fig. 5.





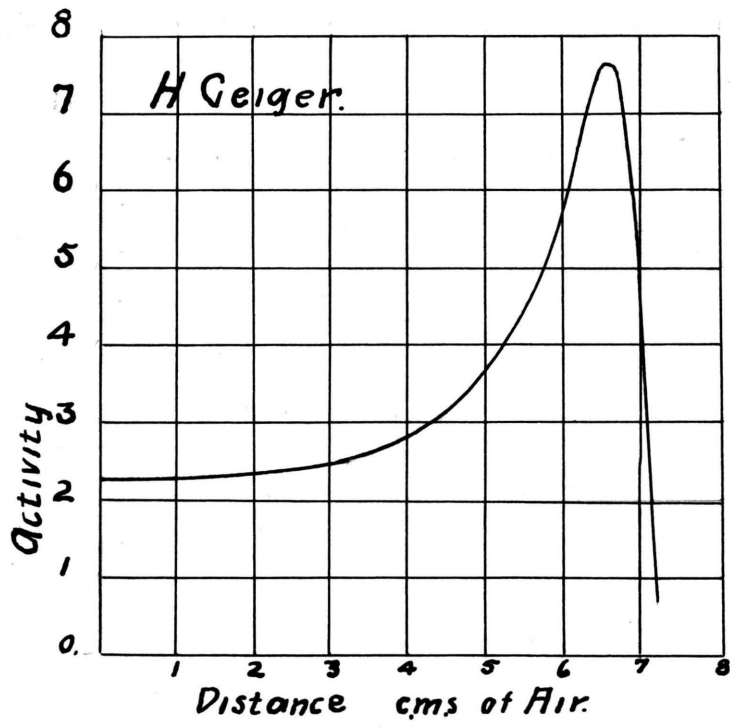

Fig. 6.

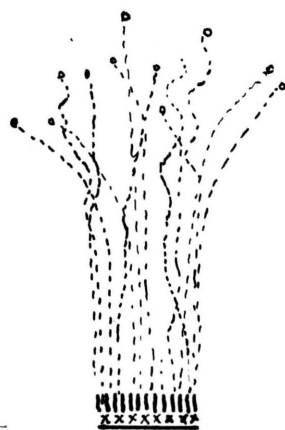

Fig. 7.



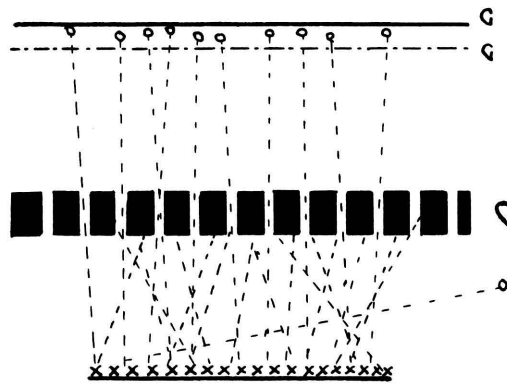

Fig. 8.



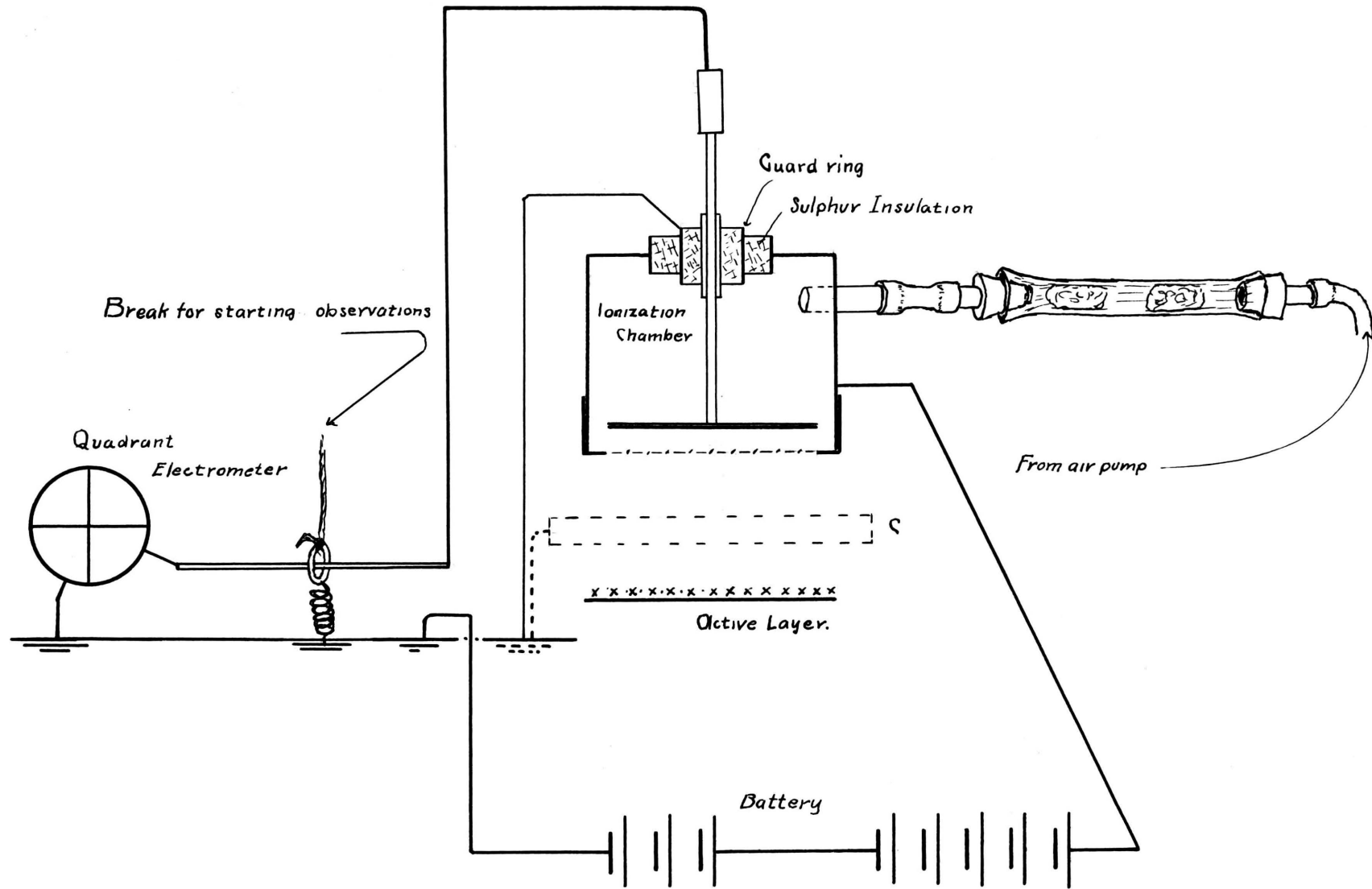
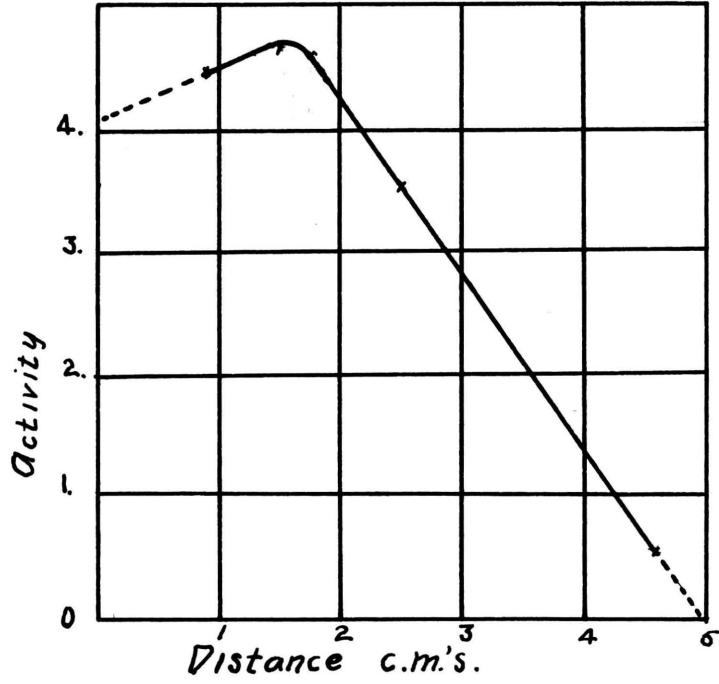

Fig. 9.

L.A.B.



Curve No. 1.



Curve No. 2.

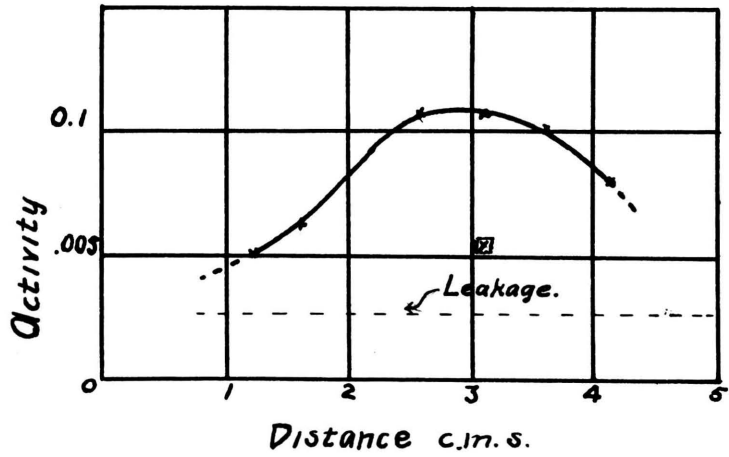





Curve No. 3.

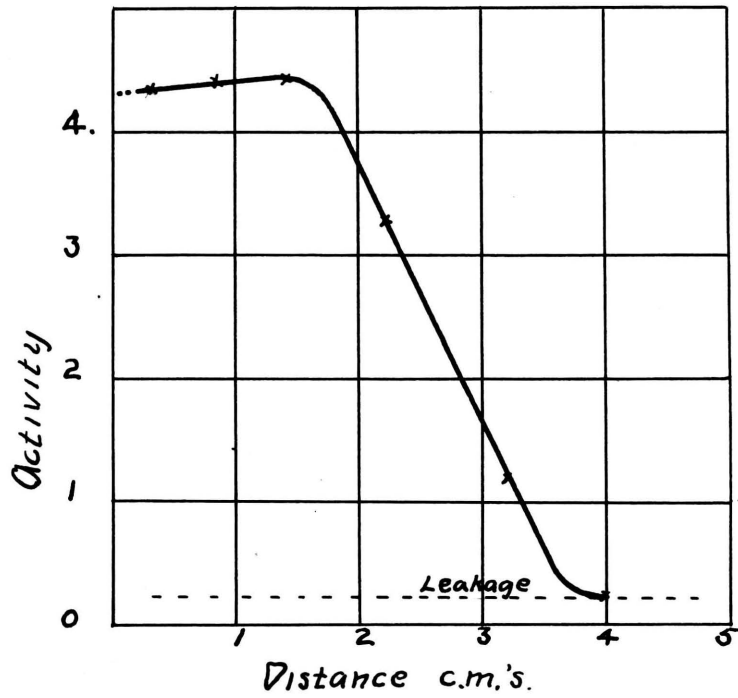

Curve No. 4.

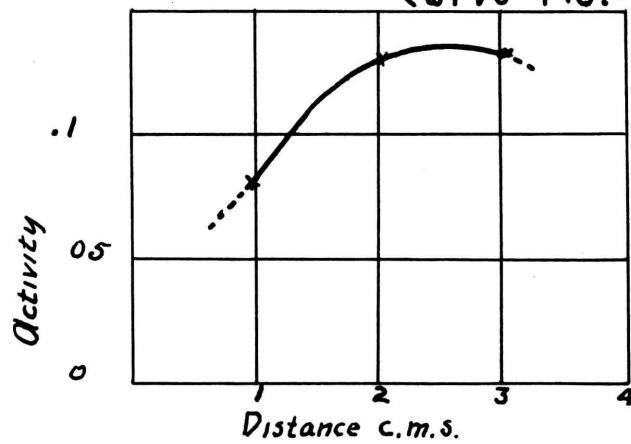



Curve No. 5.

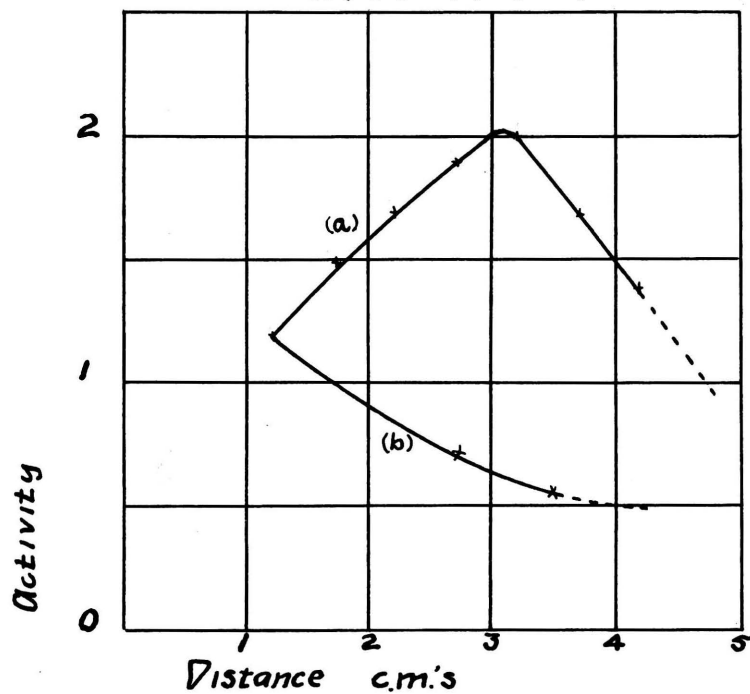

Curve No. 6.

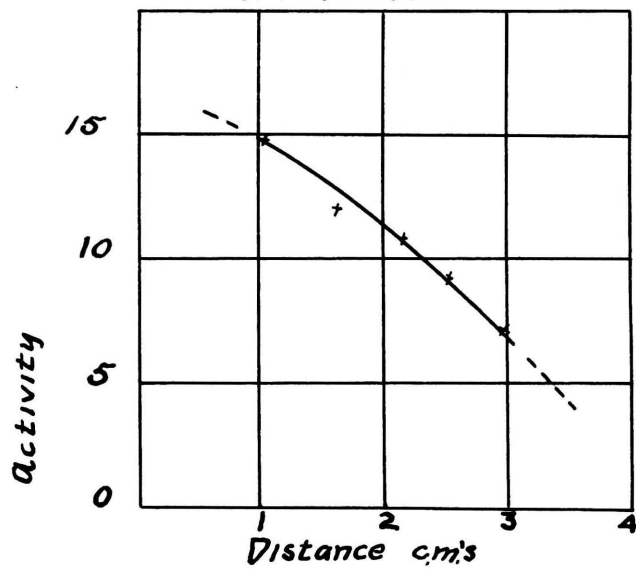



Curve No. 7.

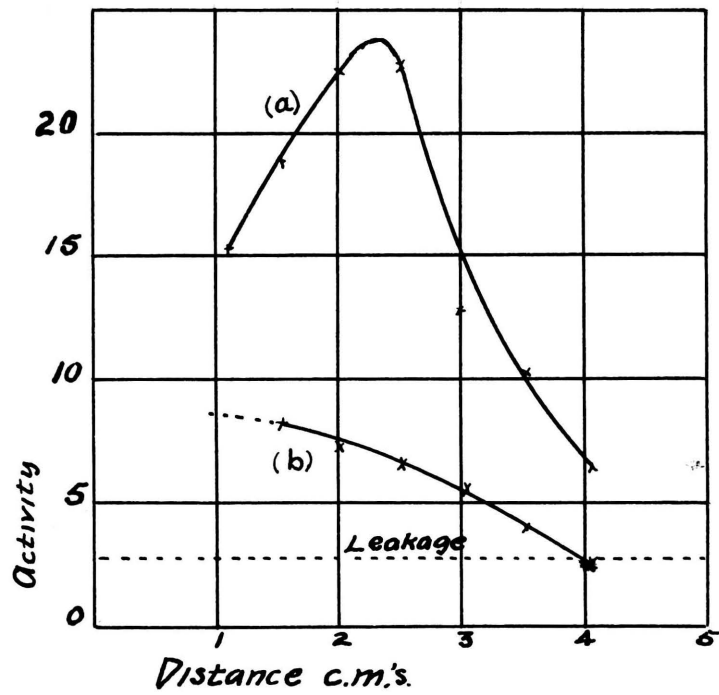

Curve No. 8.

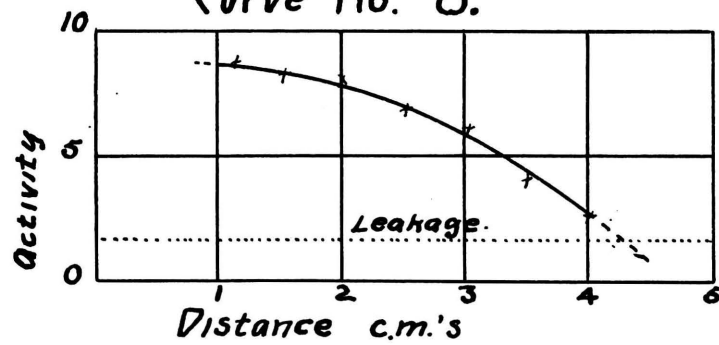



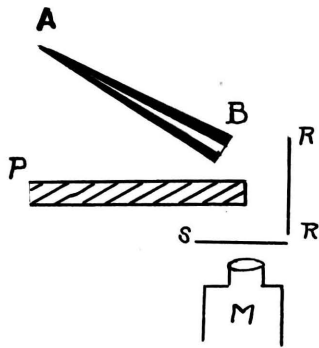

Fig. 14

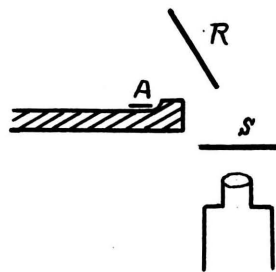

Fig. 15.





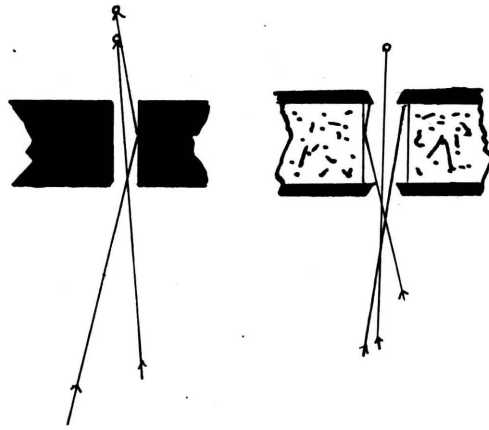

Fig. 16

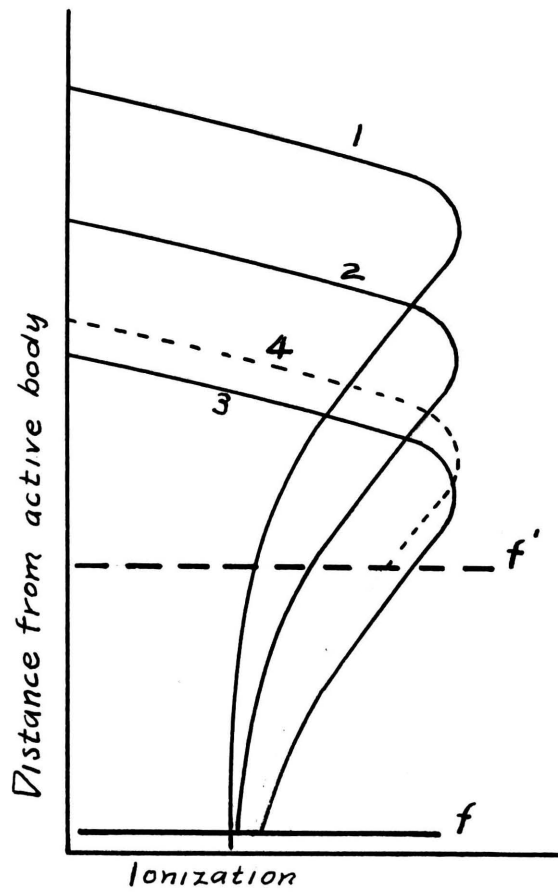

Fig. 17.



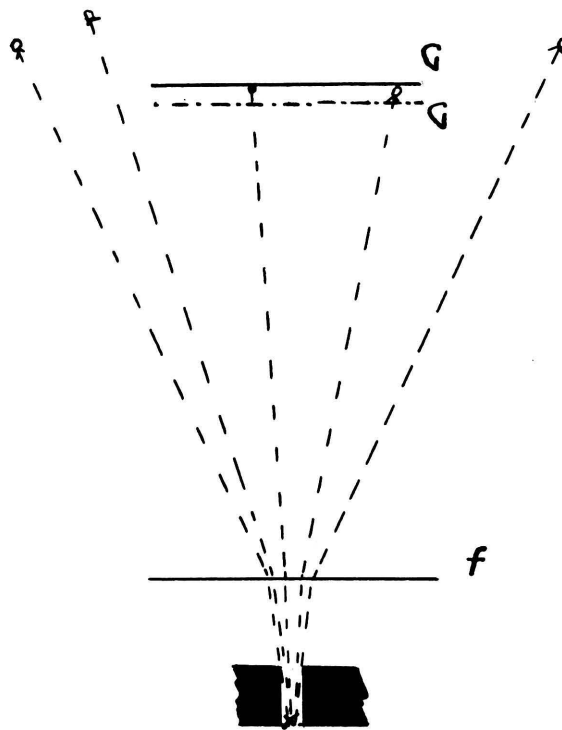

Fig. 18.

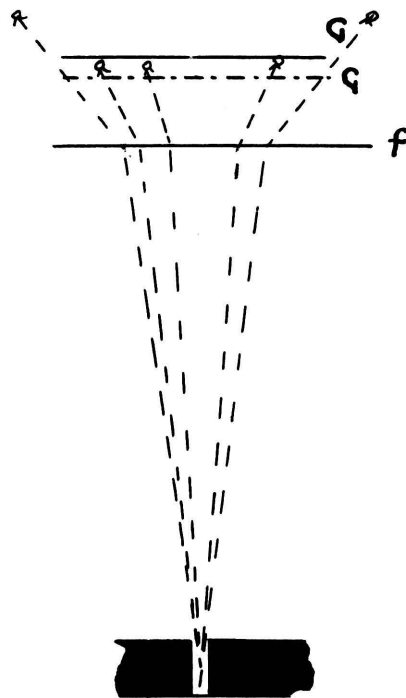

Fig. 19.



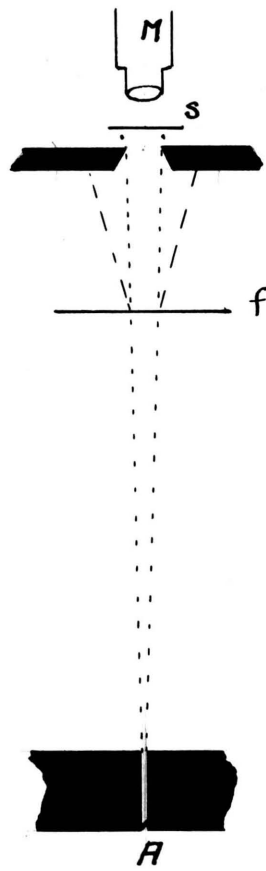

Fig. 20.



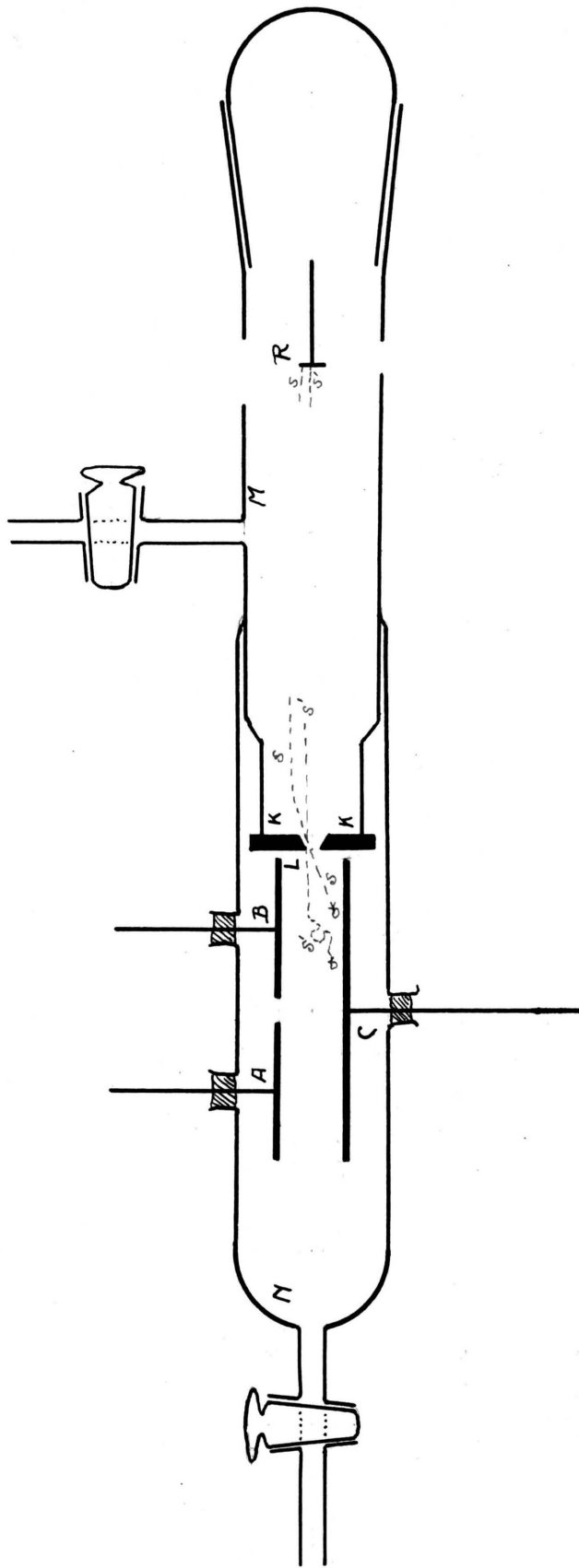

Fig 21.















010-10176099 8

378.7m71  
XB76



