

University of Missouri Extension

G1310, Reviewed October 1993

Low Temperature, In-Bin Drying: Shelled Corn in Southwest, Central and Northern Missouri

Robert M. George, Donald Brooker, Anil Duggal and Neil F. Meador
Department of Agricultural Engineering

This guide tells how to manage low-temperature, in-bin drying of shelled corn. Low-temperature drying is **natural air** drying (using only a fan) or natural air drying plus supplemental heat to raise the air temperature an additional 2 to 4 degrees Fahrenheit. Natural air drying uses the heat in the outside air plus the heat released from the fan motor, which raises the air temperature about 2 degrees Fahrenheit. The supplemental heat may be provided by gas heaters, electric heaters, solar collectors, etc.

Low-temperature drying has two major advantages: energy efficiency and high quality dried grain.

You can manage low-temperature drying as layer drying, controlled filling, or a combination of the two. This guide addresses all three options.

This guide helps manage grain drying by recommending the depth of wet grain to be added to the bin for various combinations of bin diameter and fan sizes. The depth of grain recommended gives the same air flow per bushel of wet grain for all the bin-fan combinations. Therefore, all combinations have the same probability of drying without mold growth.

Weather records in southwest, central and northern Missouri have been analyzed, and the recommended depths should allow successful drying nine years out of 10. Given the established depth of fill, this guide helps estimate the time required to dry the wet grain and suggests how the drying should be managed. Variation in weather and fan characteristics can change the time required to dry the grain.

If you have difficulty determining how to manage your low-temperature drying from this guide, contact your area agricultural engineering specialist at your local MU Extension center for help.

Layer drying

With low-temperature layer drying, the bin is filled in two or more fillings or layers and each fill layer is dried before the next layer is added. The depth of each fill depends on the moisture content of the corn, the depth of dried corn already in the bin and the amount of air delivered by the fans. Adding layers at depths greater than those recommended increases the chance of mold.

Because the time to dry a layer of wet grain can take four to 14 days, layer drying works best where several bins are equipped for low-temperature drying. Harvesting can proceed more rapidly because the grain is drying in several bins at the same time.

Fill depth recommendations

Figures 1, 2 and 3 give recommended depth of fill for different depths of dried corn already in the bin and for different moisture contents of corn in the fill layer. The depth of fill from Figures 1, 2 or 3 multiplied by the fill adjustment factor in Table 1 gives the depth of fill for the particular fan (or fans) and bin diameter used. If you are selecting a fan (or fans) for your bin, the combinations of fan(s) and bin diameters where the fan factor is **bolded** in Table 1 are the most economical.

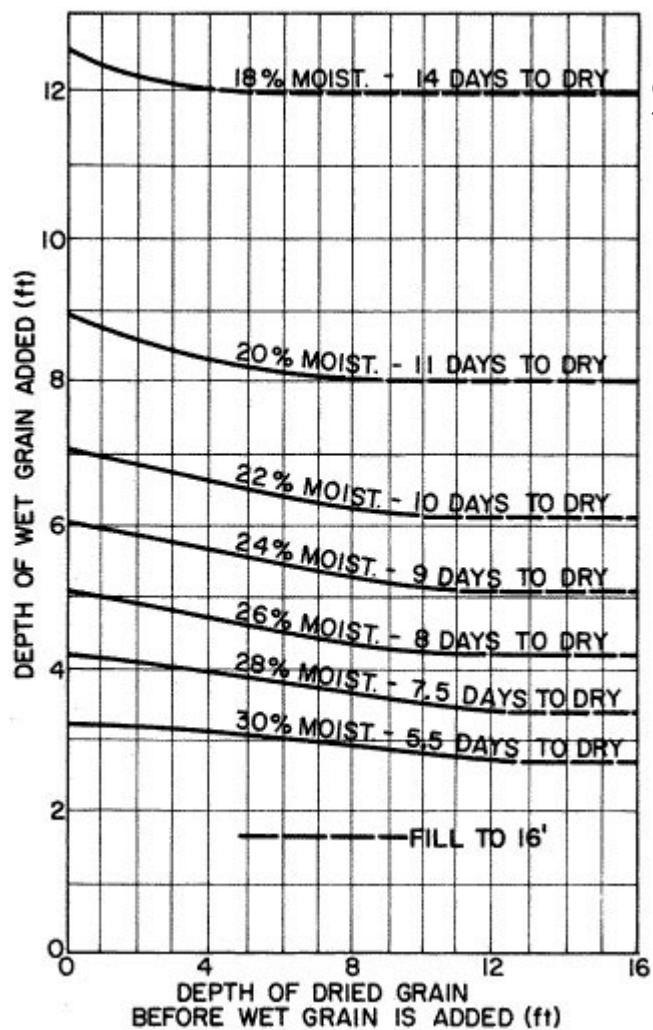

Figure 1

Depth of fill and drying time for *natural-air drying*. The only heat comes from the fan and fan motor, which increase the air temperature about 2 degrees Fahrenheit.

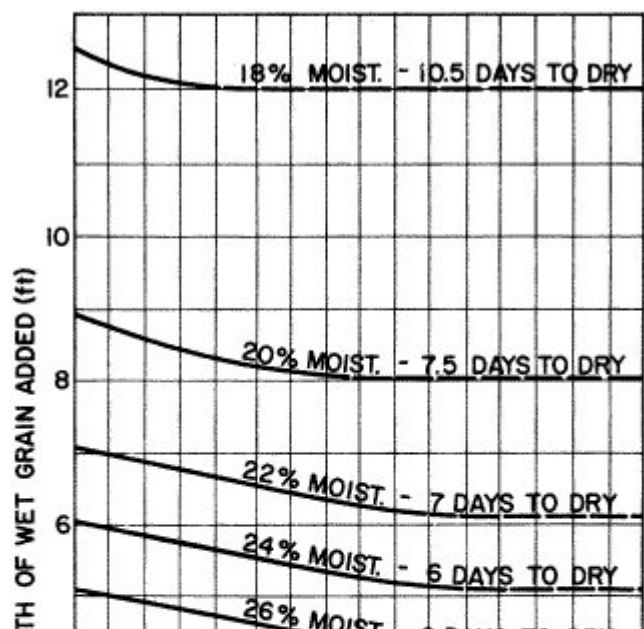

Figure 2

Depth of fill and drying time for air heated 2 degrees Fahrenheit by supplemental heater, above natural-air drying.

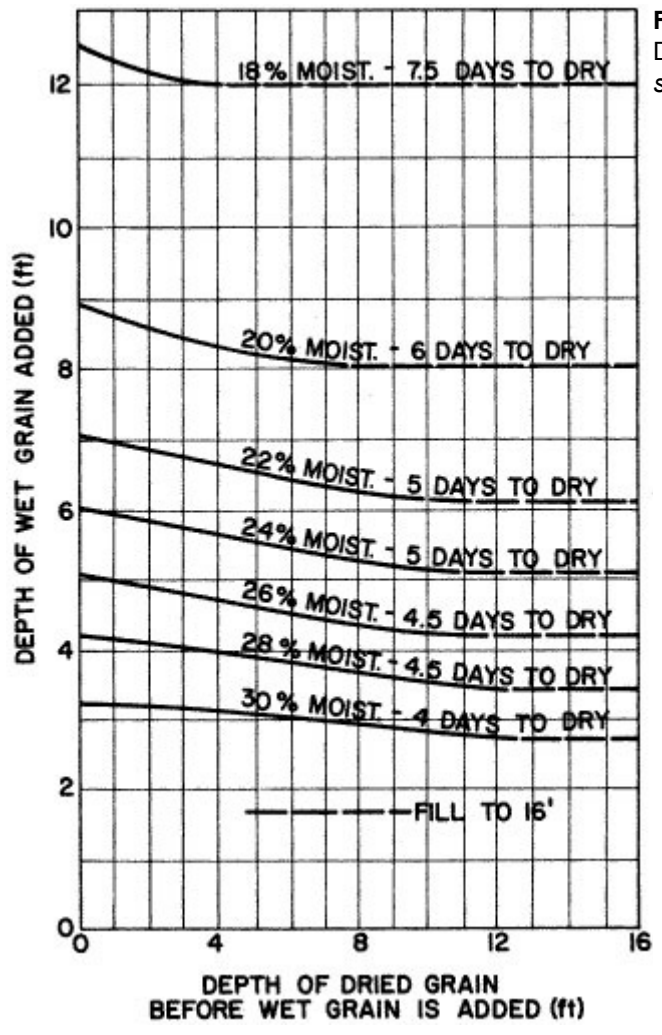
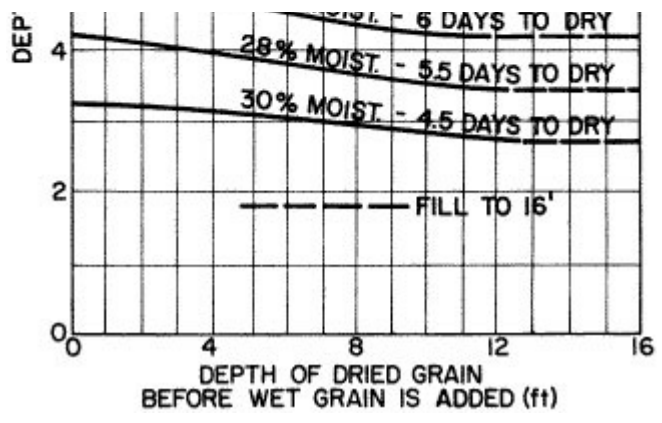

Figure 3
Depth of fill and drying time for air heated 4 degrees Fahrenheit by supplemental heater, above natural-air drying.

Table 1
Depth adjustment factor* for fan(s)**

Bin diameter	Fans								
	One 3 Hp	One 5 Hp	Two 5 Hp	One 7-1/2 Hp	Two 7-1/2 Hp	Three 7-1/2 Hp	One 10 Hp	Two 10 Hp	Three 10 Hp
18 feet	1.00***	1.25							
21 feet	0.80	1.15	1.35	1.25					

24 feet	0.65	1.00	1.30	1.15					
27 feet		0.85	1.20	1.00	1.35		1.20		
30 feet				0.85	1.30	1.40	1.05	1.40	
33 feet					0.95	1.35	1.50		
36 feet					1.05	1.25	0.80	1.25	1.40

***Multiply depth from Figures 1, 2 and 3 by these factors.**

****This table was prepared on performance data of typical vaneaxial fans. At the grain depths used in drying as described in this guide, vaneaxial fans are recommended.**

*****The adjustment factor is bolded for the fan-bin combination recommended when the unit is purchased.**

After the depth of fill has been determined, the estimated time to dry the layer is shown in Figures 1, 2 or 3. This is an estimate. The next layer can be added when a visual inspection or a moisture test determines that the top surface of the last layer added has dried to 15 percent moisture or less.

Steps for management of layer drying system

- Find the approximate depth of the **initial** fill from Figures 1, 2 or 3. The depth is based on the moisture content of the corn put in the bin (fill moisture or M_f) and zero depth of dried corn. Also, find the approximate days required to dry the corn that is given on the moisture content line.
- Adjust the depth found in Step 1 by multiplying it by the factor in Table 1 for the fan-bin diameter combination.
- Fill the bin to the depth determined in Step 2, and run the fan 24 hours a day until the top of the fill has dried to 15 percent moisture. Use the days-to-dry figure found in Step 1 as a guide.
- The approximate depth of the next fill is based on the depth of the dried corn in the bin and the moisture content of the incoming corn (M_f). The depth of the dried grain is less than the fill depth because it shrinks during the drying. The depth of fill after drying is determined by multiplying the depth of wet grain fill by the fraction-of-volume figure in Table 2.

This procedure can be simplified by working with wet corn depths only. The chance of mold will not be increased. Next, find the depth of next fill and the approximate drying time on the moisture content line in Figures 1, 2 or 3.

Table 2

Volume shrink of shelled corn dried to 15 percent moisture

Original moisture	Volume at 15 percent as fraction of original volume
30 percent	0.74
28 percent	0.76
26 percent	0.79
24 percent	0.82
22 percent	0.86
20 percent	0.90
18 percent	0.94
16 percent	0.98

15 percent	1.00
------------	------

- Adjust the depth of the corn added to match the size of the fan(s) selected according to the appropriate factor in Table 1.
- Make the next fill and run the fan 24 hours a day until the top layer is dried to 15 percent moisture. Use the approximate time from Step 4 as a guide.
- If further fills are needed, repeat Steps 4, 5 and 6.
- When the top surface of the last fill has dried to 15 percent moisture, run the fan during daytime hours only until the corn is dried to 14 percent moisture.

Low-temperature layer drying does present harvesting limitations at moisture contents above 24 percent. Several fills are required and you must wait for the last fill to dry before adding another layer. If the cost of field losses are combined with the cost of drying, the least costly drying calls for the initial fill to average about 24 percent moisture. The moisture content of the corn in the field is decreasing while the initial fill dries, and it is often low enough so that the bin can be completely filled with the second filling. Harvesting usually is completed in about three weeks.

The following three examples illustrate how to use this guide to manage an in-bin, low-temperature layer drying system for shelled corn.

Example 1

Given

27-foot bin diameter

One 7.5-horsepower fan

Natural air drying

Initial fill moisture is 24 percent

Management

- From Figure 1 (with $M_f = 24$ percent and zero dried grain depth), fill depth is 6 feet of wet corn and the approximate drying time is nine days (Figure 4).
- From Table 1 (with a 27-foot diameter bin and a 7.5-horsepower fan), the fan factor is 1.00. Adjusted depth of fill is 6 feet \times 1.00 = 6.0 feet.
- Fill the bin to a depth of 6.0 feet wet corn and run the fan 24 hours a day until the top surface of corn is 15 percent moisture. This takes approximately nine days.
- Dried depth is 4.9 feet (from Table 2, 6.0 feet \times 0.82 = 4.9 feet). Corn now harvested tests 20 percent. From Figure 1 (with $M_f = 20$ percent, and 4.9 feet dried grain depth), fill depth is 8.3 feet, and approximate drying time is 11 days.
- Adjusted depth of fill is 8.3 feet \times 1.00 = 8.3 feet.
- Add 8.3 feet of corn and run fan 24 hours a day until top surface of corn is 15 percent. Takes approximately 11 days.
- Second fill shrinks to 7.5 feet (8.3 feet \times 0.90 = 7.5 feet). Dried depth of corn is now 4.9 + 7.5 = 12.4 feet. Corn now harvested tests 18 percent. From Figure 1 (with $M_f = 18$ percent, and 12.4 feet dried grain depth), the bin can be filled to more than 16 feet, the maximum depth for this bin. Fill bin to 16 feet and run fan 24 hours per day until the top surface of corn is 15 percent moisture.
- Run fan during daytime hours until the corn is dried to 14 percent moisture or the moisture required for safe storage.

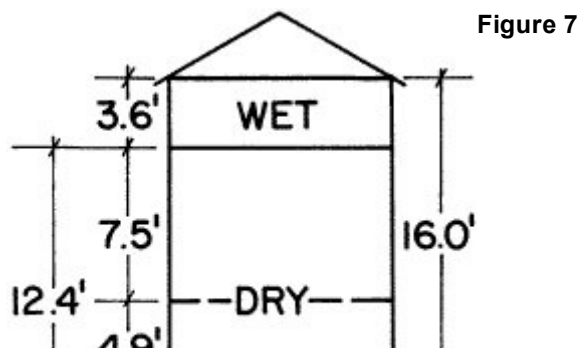
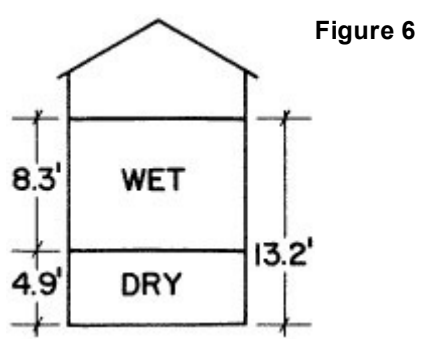
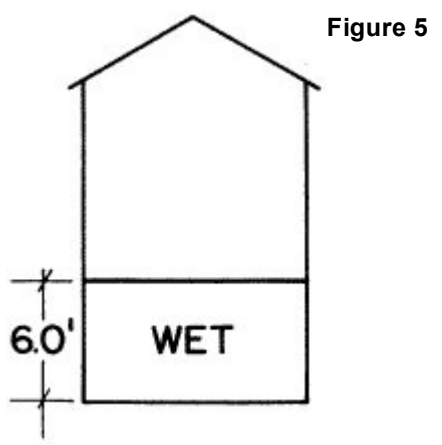
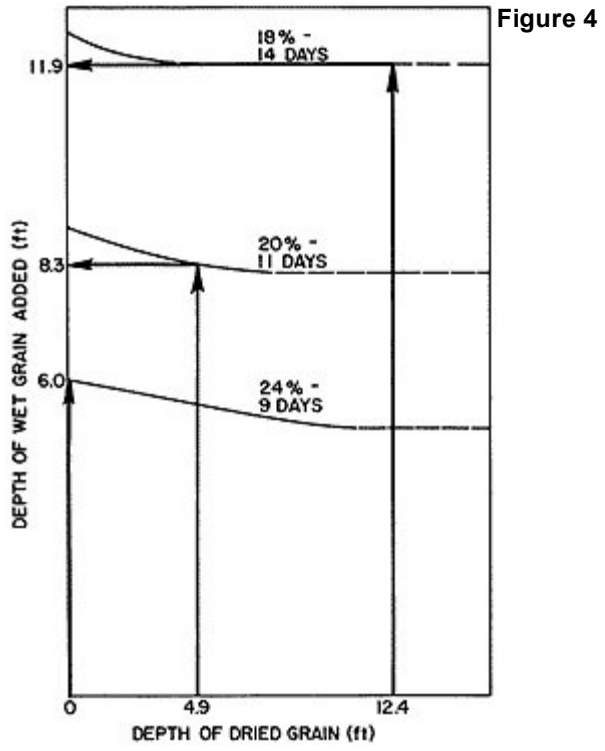

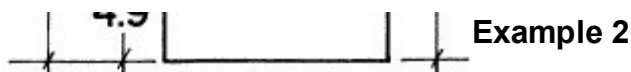

Example 2

Given

30-foot bin diameter

$M_f = 28$ percent moisture

Two 7.5-horsepower fans

Air temperature is increased 2 degrees Fahrenheit above **natural air** by solar collector.

Management

- From Figure 2 (with $M_f = 28$ percent and zero dried grain depth), fill depth is 4.2 feet and approximate drying time is 5-1/2 days (Figure 8).
- From Table 1 (with a 30-foot bin diameter and two 7.5-horsepower fans), the fan factor is 1.3. Adjusted depth of fill is 4.2 feet \times 1.30 = 5.5 feet.
- Fill bin to depth of 5.5 feet and run fan 24 hours a day until top surface of corn is 15 percent moisture. This takes approximately 5-1/2 days.
- Dried depth is 4.2 feet (from Table 2, 5.5 feet \times 0.76 = 4.2 feet). Corn now harvested tests 26 percent. From Figure 2 (with $M_f = 26$ percent and 4.2 feet dried grain depth), fill depth is 4.7 feet and approximate drying time is six days (Figure 8).
- Adjusted depth of fill is 4.7 feet \times 1.30 = 6.1 feet.
- Add 6.1 feet of corn and run fan for 24 hours until the top surface of corn is at 15 percent moisture. This takes approximately six days.
- Second fill shrinks to 4.8 feet (6.1 \times 0.79). The depth of dried corn is 4.2 + 4.8 = 9 feet. Corn now harvested tests 20 percent. From Figure 2 (with $M_f = 20$ percent and 9 feet dried grain depth), next fill depth is 8.0 feet and approximate drying time is 7-1/2 days.
- Adjusted depth of fill is 8.0 feet \times 1.30 = 10.4 feet. The bin can be filled to the maximum depth for this bin, 16 feet.
- Fill bin to about 16 feet and run the fan 24 hours a day until the top surface of corn is 15 percent moisture.
- Run the fan during daylight hours to dry corn to 14 percent moisture or the moisture required for safe storage. You may have to disconnect the solar collector to prevent over-drying.

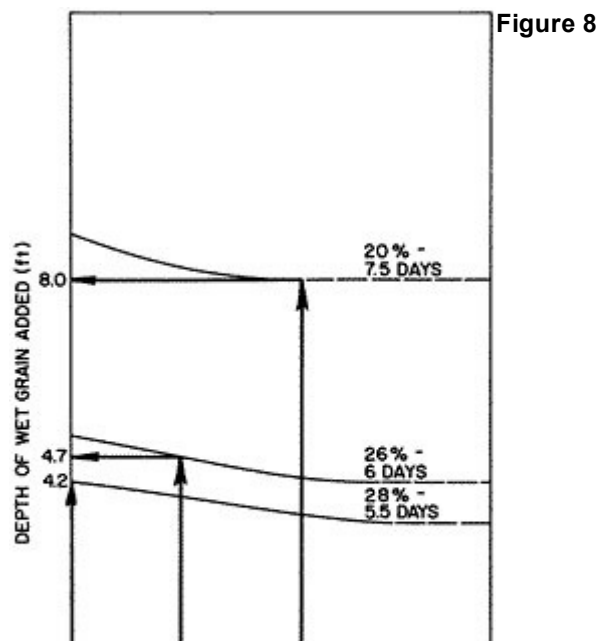

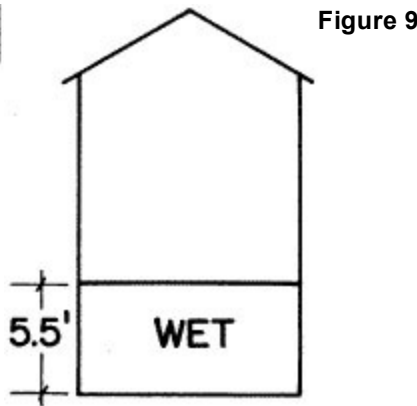
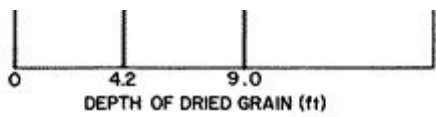
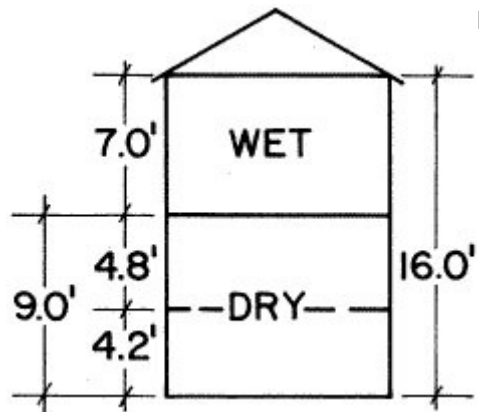

Figure 10



Figure 11



Example 3

Given

21-foot bin diameter

$M_f = 26$ percent

One 3 horsepower fan

Air temperature is increased 4 degrees Fahrenheit above **natural air** using a gas burner.

Management

- From Figure 3 (with $M_f = 26$ percent and zero dried grain depth), fill depth is 5.1 feet and approximate drying time is 4-1/2 days (Figure 6).
- From Table 1 (with a 21-foot bin diameter and 3-horsepower fan), the fan factor is 0.80. Adjusted depth of fill is 5.1 feet x 0.80 = 4.1 feet.

- Fill the bin to depth of 4.1 feet and run fan 24 hours a day until top surface of corn is 15 percent moisture. This takes approximately 4-1/2 days.
- The dried depth is estimated at 3.2 feet (from Table 2, 4.1 feet x 0.79 = 3.2 feet). Corn now harvested tests 24 percent. From Figure 3 (with $M_f = 24$ percent and 3.2 feet dried grain depth), fill depth is 5.7 feet and approximate drying time is five days (Figure 6).
- Adjusted depth of fill is 5.7 feet x 0.80 = 4.6 feet.
- Add 4.6 feet of corn and run fan 24 hours a day until top surface of corn is 15 percent moisture. This takes approximately five days.
- Second fill shrinks to 3.8 feet (4.6 x 0.82). Depth of dried corn is 3.2 + 3.8 = 7.0 feet Corn now harvested tests 22 percent. From Figure 3 (with $M_f = 22$ percent and 7.0 = feet dried grain depth), approximate fill depth is 6.3 feet and approximate drying time is five days (Figure 6).
- Adjusted depth of fill is 6.3 feet x 0.80 = 5.0 feet.
- Add 5 feet of corn and run fan 24 hours a day until top surface of corn is 15 percent moisture. This takes approximately five days.
- Third fill shrinks to 4.3 feet (5 x 0.86). Depth of dried corn is 3.2 + 3.8 + 4.3 = 11.3 feet. Corn now harvested tests 20 percent. From Figure 3 (with $M_f = 20$ percent and 11.3 feet dried grain depth), fill depth is 8.0 feet and approximate drying time is six days.
- Adjusted depth of fill is 8.0 feet x 0.80 = 6.4 feet. This gives a depth of greater than 16 feet, the maximum depth for this bin.
- Fill bin to 16 feet and run for 24 hours a day until top surface of corn is 15 percent or the moisture required for safe storage.
- Run fan during daylight hours only until corn is dried to 14 percent moisture. You may have to turn off gas burner to keep from over-drying.

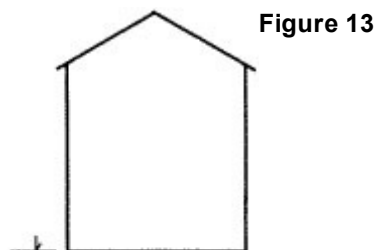
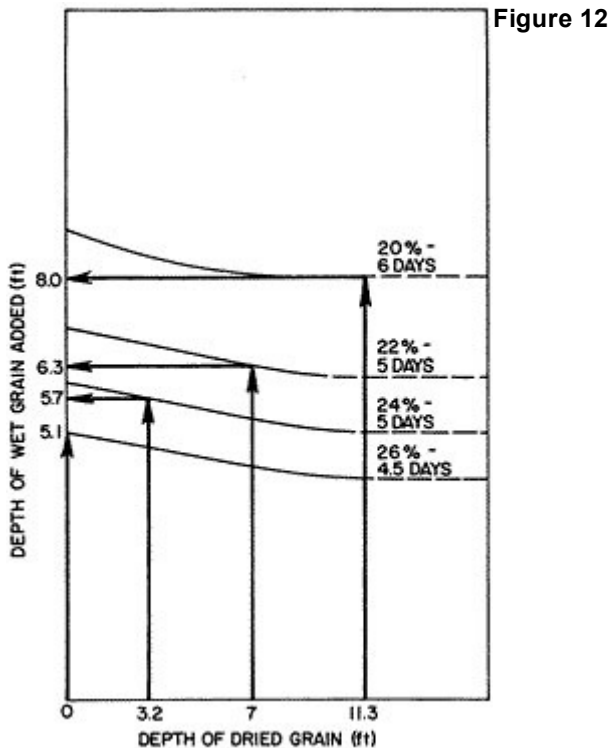

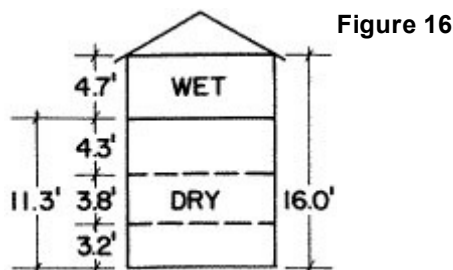
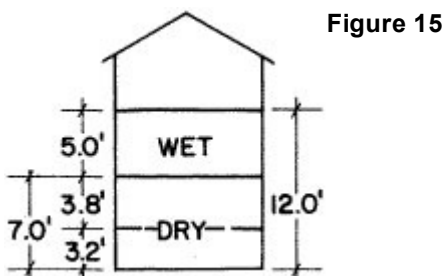
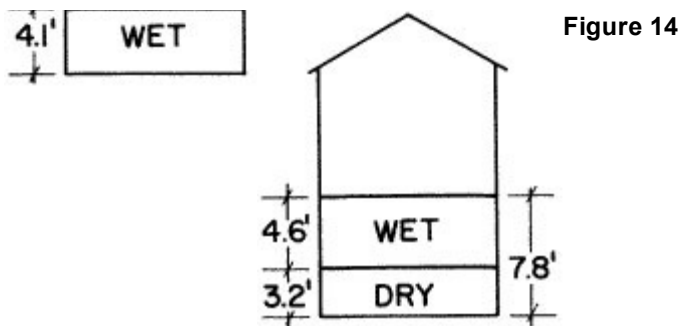

Controlled filling

Fills can be made before the top surface of a previous fill dries to 15 percent moisture if you carefully control the depth of wet corn above the dried corn. The total depth of wet corn permitted depends on the moisture content of the undried corn in the bin.

Steps for filling while undried corn from a previous fill is in the bin are:

- Measure the depth of the wet corn in the bin. Find the depth of the wet corn by probing. A concrete reinforcing rod makes a suitable probe. As long as the rod is being pushed through wet corn, there is considerable resistance. When the rod reaches dry corn, you can push it easily and it seems to break through.
- Add wet corn until undried corn has a total depth **not greater** than the values given in Table 3.

Table 3
Guide for controlled filling

Corn moisture	Maximum total depth* of wet corn
18 percent	12 feet
20 percent	8 feet
22 percent	6 feet
24 percent	5 feet

26 percent	4 feet
28 percent	3-1/2 feet
30 percent	2-1/2 feet

***Adjust these depths by multiplying by the appropriate depth adjustment factor for the fan(s) (Table 1).**

Note

Never add wet corn with a moisture content higher than that previously placed in the bin unless the surface corn of the previous fill has dried to 15 percent moisture. The next example illustrates how you manage controlled filling.

Example 4

Given

Same conditions as in Example 1

27-foot bin diameter

One 7.5-horsepower fan

Natural air drying

Initial fill moisture is 24 percent

Management

- From Figure 1 (with $M_f = 24$ percent and zero dried grain depth), the initial fill is 6 feet and the approximate drying time is nine days.
- Adjusted fill depth is 6 feet because the depth adjustment factor is 1.0. The corn will dry about 6 feet divided by 9 days or $2/3$ feet per day or 2 feet every 3 days.

The filling schedule to maintain 5 feet of undried grain is listed in Table 4.

Table 4

Filling schedule

Day	Feet
1	6 (initial fill depth)
4	1 (brings wet depth to 5 feet)
7	2
10	2
13	2
16	2
19	2
22	Fill to 16 feet to make up for shrinkage

The actual filling schedule should be faster than shown here because the corn moisture in the field is going down while you fill the bin. Add corn at any time to bring the depth of wet corn up to 5 feet when probing

shows that the drying front is less than 5 feet from the surface.

Combination layer drying and controlled filling

You can combine layer drying and controlled filling if such a procedure fits your harvesting schedule better. For example, after you place two or three layers in the bin with layer drying, it may be desirable to finish filling the bin before the surface of the top layer is dry. You can add corn if you follow the procedure for controlled filling. In fact, you can switch from one procedure to the other at any time during harvest if you follow the recommendations of this guide for whatever procedure you use.

Management of stored grain

Keep in mind that properly dried grain can go out of condition in storage. It is a valuable possession; protect it.

- Store at a moisture content of 14 percent or less.
- Level the top surface of the grain.
- Aerate in the fall to cool the grain to 40 degrees Fahrenheit. Do not freeze.
- Check and record grain temperature every 21 days. Aerate as soon as any increase in temperature is evident.
- Warm grain to 65 degrees Fahrenheit in the spring by running aeration fan.
- Try to maintain less than 20 degrees Fahrenheit difference between average outdoor temperature and grain temperature.
- Check for insects in the fall, spring and summer. If treatment is necessary, use proper procedures.

G1310, reviewed October 1993

Related MU Extension publications

- G1305, Estimating Airflow for In-Bin Grain Drying Systems
<http://extension.missouri.edu/publications/DisplayPub.aspx?P=G1305>
- G1969, Safe Storage and Handling of Grain
<http://extension.missouri.edu/publications/DisplayPub.aspx?P=G1969>

Order publications online at <http://extension.missouri.edu/explore/shop/> or call toll-free 800-292-0969.



■ Issued in furtherance of the Cooperative Extension Work Acts of May 8 and June 30, 1914, in cooperation with the United States Department of Agriculture. Director, Cooperative Extension, University of Missouri, Columbia, MO 65211
■ an equal opportunity/ADA institution ■ 573-882-7216 ■ extension.missouri.edu