

# On-Light: Optical Social Network

Rogério P. Dionísio

Instituto Politécnico de Castelo Branco, Avenida do Empresário S/N,  
6000-767 Castelo Branco, Portugal

## ABSTRACT

Social networks are a recent phenomenon of communication, with a high prevalence of young users. This concept serves as a motto for a multidisciplinary project, which aims to create a simple communication network, using light as the transmission medium. Mixed team, composed by students from secondary and higher education schools, are partners on the development of an optical transceiver. A LED lamp array and a small photodiode are the optical transmitter and receiver, respectively. Using several transceivers aligned with each other, this configuration creates a ring communication network, enabling the exchange of messages between users. Through this project, some concepts addressed in physics classes from secondary schools (e.g. photoelectric phenomena and the properties of light) are experimentally verified and used to communicate, in a classroom or a laboratory.

**Keywords:** Free space communication, Visible light, LED, Microprocessor, Communication protocol, Social networking

## 1. INTRODUCTION

Today's high school students may lack interest in math and science due to insufficient connections between why they learn in classes and real-life applications. However, the same students are attracted by new electronic devices, such as portable game players, smartphones and computer games, which rely on engineering principles that integrates math, physics, sciences and technology. One popular application for such electronic devices relies on social networking, such as Facebook, with a high prevalence of young users. The challenge is to attract students' interests to engineering applications and make them aware of the engineering potential in their future life. In order to provide a smooth transition from high school to engineering for those who do choose engineering, outreach programs engaging high school and graduated engineering students are one of the proposed methods<sup>1</sup> to overcome those difficulties.

Bearing these in mind, the project "On-Light - Optical Social Network", was born of a partnership between three secondary schools: Amato Lusitano High School in Castelo Branco, Quinta das Palmeiras High School in Covilhã, and the High School cluster in Fundão, and the Polytechnic Institute of Castelo Branco, that coordinates the project (all the schools are from Portugal). The concept of social networking serves as a motto for this project, which aims to create a simple communication network, using light as the transmission medium. Mixed team, composed by students from secondary and higher education, are responsible for the development, production and testing of an optical transceiver. When several transceiver modules are aligned with each other in a ring topology, as depicted in Fig. 1a, this configuration will create a communication network, enabling the exchange of messages between users. This way, some concepts addressed in physics classes from secondary schools (photoelectric phenomena and properties of light) are experimentally verified, and combined with other subjects from undergraduate courses related with Telecommunications, such as communication protocols, digital modulation techniques, and electronics.

The project is funded under a national program, financed by "Ciência Viva",<sup>2</sup> a state agency focused on the dissemination of science activities among young people. This program aims to promote closer ties between high school and graduate education, with a view to share resources and encourage young students to pursue studies in science and technology areas.

---

Further author information: (Send correspondence to R.P.D.)  
R.P.D.: E-mail: rdionisio@ipcb.pt, Telephone: +351 272 339 300

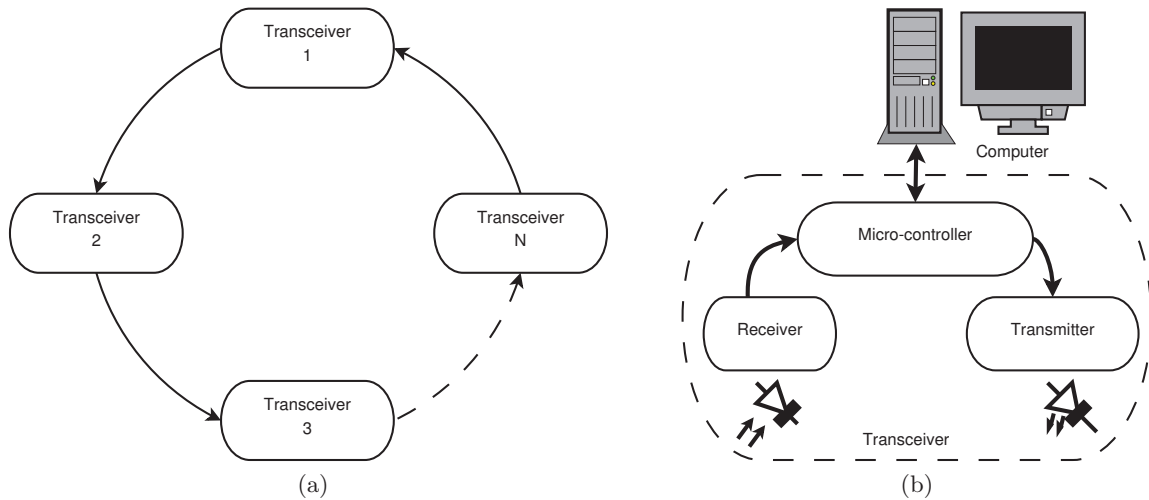

Figure 1: VLC network diagram: (a) Ring configuration; (b) Transceiver diagram.

## 1.1 Related Work

The dissemination of Visible Light Communication (VLC) technology and its principles among young students is scarce. A recent work uses lasers as optical transmitter<sup>3</sup> for undergraduate courses, which may raise concern on eye safety when manipulating such devices. Even if Physics curriculum from secondary school courses include the photoelectric effect and the properties of light, little time is available for teachers and educators to bring these subjects into practical experiments. However, using visible light has the transmission support for wireless communication is not a recent subject,<sup>4</sup> and has drawn great interest as a new communication medium due to the following recent developments. Firstly, solid-state light sources, like Light Emitting Diodes (LED) are rapidly replacing conventional ones in signaling, illumination and display infrastructures. It thus becomes possible to carry communication data on such light sources.<sup>5</sup> Secondly, the visible band is free from frequency regulation and RF interference so that it is well suited to RF crowded or RF restricted environments. Thirdly, the unique feature of visibility can enhance the physical-layer security and offer intuitive usage. Given the growing expectation of ubiquitous connectivity in all settings and environments, the need for unlicensed, high bandwidth, easy to use wireless communications technology has never been greater. Since the appearance of the LED, several researcher have successfully create free-space optical transmission links with high bit rates and long reach.<sup>6</sup> Recently, IEEE has created the working group 802.15.7 to produce a standard for WPANs (Wireless Personal Area Networks) using VLC.<sup>7</sup>

The rest of this paper is structured as follows. Section 2 defines the methodology of the project. Hardware and software development are described in details in Section 3 and 4, respectively. Outreach activities are presented in Section 5, and preliminary results and assessment in Section 6. Finally, Section 7 concludes the paper.

## 2. METHODOLOGY

Each task in this project is described in the following sub sections. Fig. 2 highlights the task interdependencies.

### 2.1 Task 1 - Team creation and assignment

The project coordinator was responsible for the process of selecting students to participate in this project. Students from three educational level are involved: students from secondary schools, post secondary and undergraduate courses (the last two groups are from the Polytechnic Institute of Castelo Branco). The selection process was different between each educational level. In secondary schools, the selection usually follows a request for volunteers during sciences classes, where the project was previously presented and described by an educator.

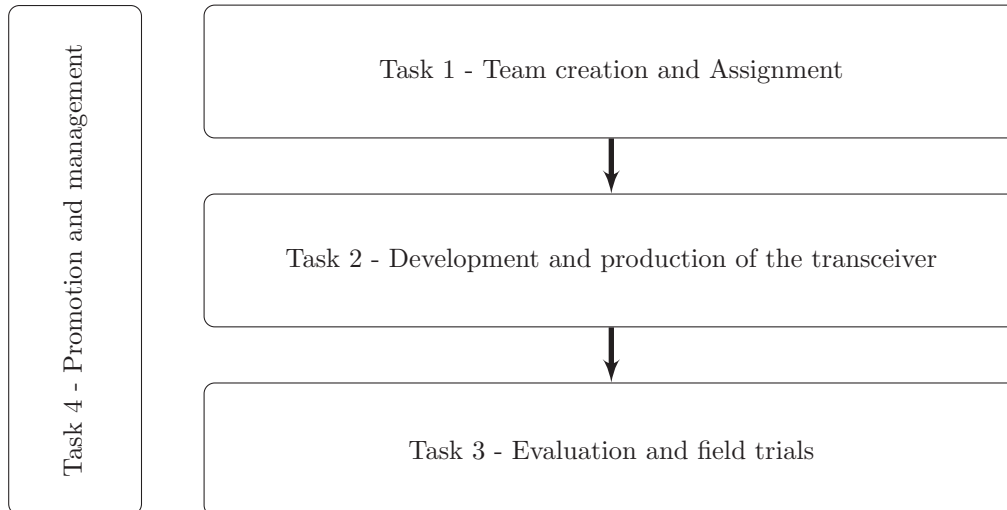

Figure 2: Tasks interdependencies along the project.

One exception occurs in Quinta das Palmeiras secondary school, where the selection targeted a group of students, led by a science teacher, that had already formed a club for extra curricular activities on electronics and software programming. After the student selection, the project coordinator creates student teams from the three educational levels previously described. Each team is responsible for the development, production and testing of one optical transceiver.

## 2.2 Task 2 - Development and production of the transceiver

Task 2 implements the required hardware and software, to obtain an optical transceiver with communication capabilities. More details are given in Sections 3 and 4. Each team is responsible for the selection of the necessary electronic component, the bill of material (BOM) and the programming of the Arduino micro-controller.<sup>8</sup> The first prototypes are tested individually, and in a latter stage incorporated into the ring network for performance evaluation. In each team, the tasks are distributed in the following temporal order:

1. Undergraduate students prepare the design of the circuit and implement it in a prototype breadboard, together with the programming of the micro controller.
2. Students from post-secondary technological programs (CETs) receive all the circuit diagrams, and prepare a printed circuit board (PCB) for each hardware module (transmitter and receiver). The PCB production is done using a LPKF prototyping PCB machine.<sup>9</sup> Finally, they follow with PCB verification and component soldering.

## 2.3 Task 3 - Evaluation and field trials

Task 3 is where the trial of the optical network occurs, to assess the limitations and future improvements of the optical transceivers. Interaction between Task 2 and Task 3 will allow tuning of the transceivers architecture and software. This is where secondary school student will have their most significant participation, collaborating in the field trials and giving their feedback on the results.

## 2.4 Task 4 - Promotion and management

Task 4 will disseminate the results of this project hence, will flow from all previous tasks. These activities include:

- Presentation of the project: The project coordinator, together with a selected group of undergraduate student, present the project to the school community (students and teachers).

- Lectures in secondary schools, given by the project coordinator or undergraduate students, on the optoelectronics effect and its applications in engineering: From energy production to optical communications.
- Participation in national and international science fairs.
- Dissemination of activities in conferences and journals articles.

### 3. HARDWARE

This section presents a overall description of the electronic circuits of the transceiver presented in Fig. 1b.

#### 3.1 Transmitter

The transmitter may be subdivided into 4 subsystems, as depicted in Fig. 3. First, the Arduino micro-controller processes the information received from the PC, and send a corresponding signal to a digital port. This signal is used to control the state of a electronic switch (MC14066). The Arduino also generated an analog voltage to feed a voltage-to-frequency converter (LM311). Depending on the logical state of the control signal, the output of the electronic switch will generate an ASK signal. Finally, the ASK signal is used as at the excitation signal at the base of a power transistor (TIP41C), set in a common emitter configuration. This last subsystem is meant to keep the lamp always on, and imprint an optical signal variation proportional to the ASK signal.

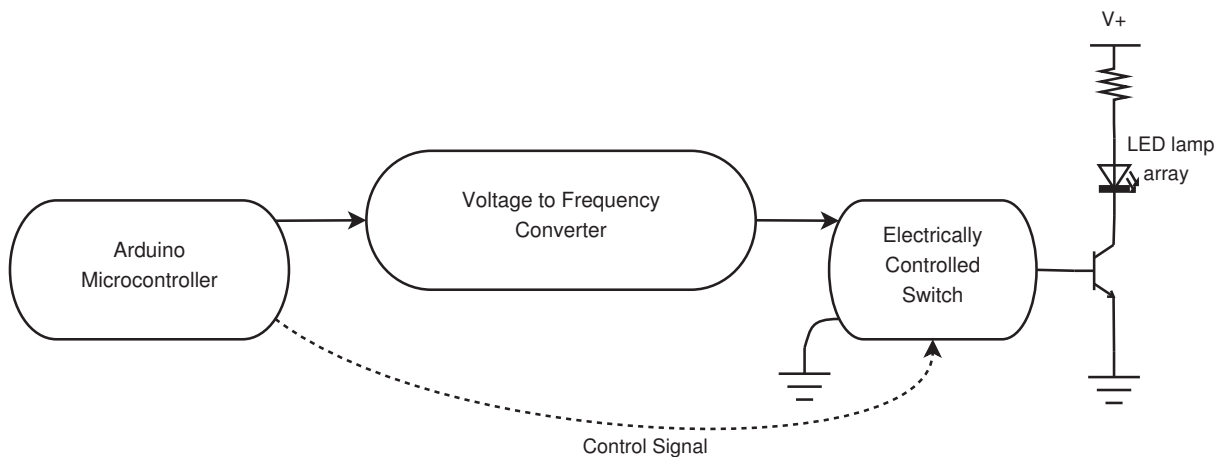

Figure 3: Transmitter diagram.

#### 3.2 Receiver

The diagram of the receiver circuit is depicted in Fig. 4. The photodiode is first connected to a transimpedance amplifier, to convert the current produced from the photoelectric effect into a voltage. Then, a bandpass filter removes the spectral component outside the frequency band of interest. The central frequency of the filter is the same frequency used in the voltage-to-frequency subsystem, on the transmitter. This operation introduces losses, so the resulting signal is once again amplified. The next step is to demodulate the ASK signal, remove the carrier and recover the original information. Thus, we implement a simple envelope detection using a diode and a capacitor. A threshold subsystem is needed to recover the mean value of the signal, and used as one of the inputs of a comparator. The threshold subsystem is implemented with a low-pass filter with cutoff frequency equal to 10 Hz. The final stage is a comparator, that delivers a binary signal according to the input signals levels (envelope and mean value signals). The resulting signal is then adjusted to 0-5 V levels and sent to one of the digital input of the Arduino micro-controller.

One of the key parameters in optical system is the speed with which the optical sensor responds to light variations. Therefore, we tested the frequency response of a set of optical sensors. We choose three solar panels with surface areas of 2400, 3000 and 30000 mm<sup>2</sup>, that we call solar panel 1, 2 and 3, respectively. We also tested

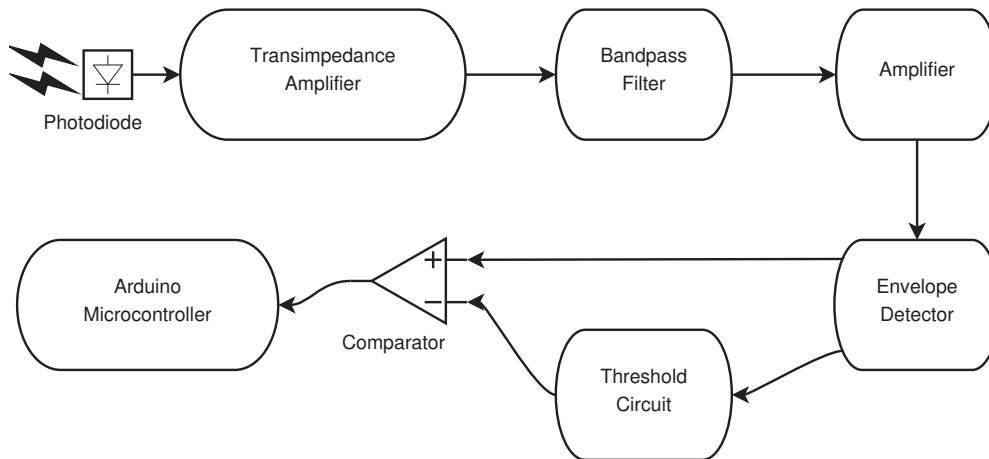

Figure 4: Receiver diagram.

a photo diode with an integrated transimpedance amplifier (OPT101) and a sensitive area of  $9 \text{ mm}^2$ . For the experiment, we use a LED lamp connected to an electrical signal source with variable frequency as the optical transmitter. The distance between the transmitter and the optical sensor was 30 cm. The results of spectral measurements presented in Fig. 5 show that the photo diode presents an increased bandwidth when compared to other components, mainly because it has much smaller dimensions than a solar panel, and a faster response to variations in amplitude modulated light from the LED lamp. Therefore, this photodiode will be the optical receiver of the transceiver.

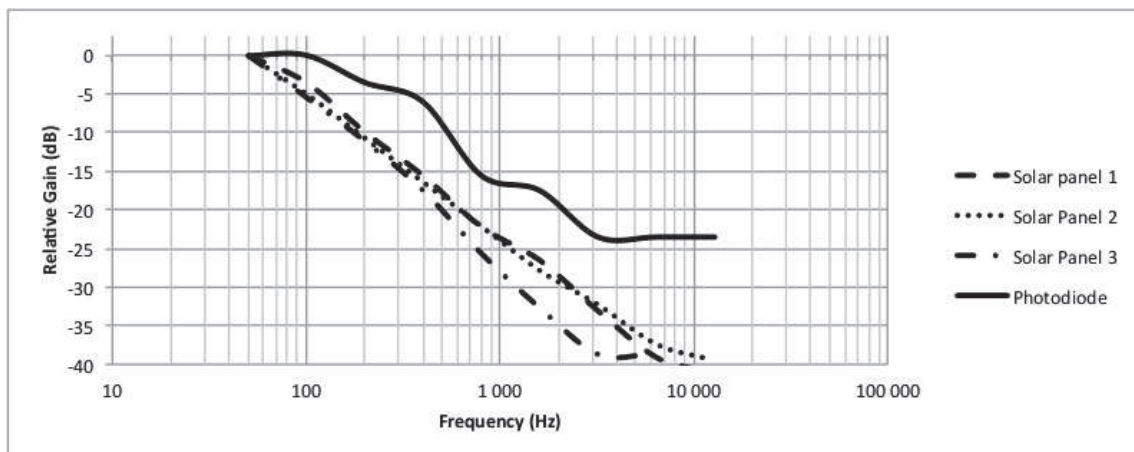

Figure 5: Frequency Response of several optical receiver tested, including solar panels and small footprint photodiodes.

#### 4. SOFTWARE

The Arduino platform offers a simple interface and a multitude of functions to interact with the micro-controller, all based on the universal C language. Nowadays, this is a commonly used language, taught in secondary school. To keep the project as simple as possible, we use Hyperterminal from Windows (or a similar tool from other operating systems) as the graphical user interface on the computer.

Regarding the communication protocol, the student are working on a proposal based on the Token Ring protocol, often used for ring network topologies. It is a protocol for Local Access Networks (LANs) defined in

IEEE 802.5,<sup>10</sup> where all stations are connected in ring and each station can only receive direct transmissions from the nearest neighbor. Such networks carries a short bit sequence, designated as a token. Possession of the token grants the right to transmit. If a transceiver receives the token and has data to send, it captures the token, changes a bit, adds the information to convey and sends this information to the next transceiver on the ring. While the token circulates on the network, other stations wishing to transmit must wait. Therefore, collisions doesn't occur in this type of networks. The token circulates on the ring until it reaches the intended destination station, which copies the information for further processing. The token continues to circulate in the network and is removed as it arrives at the destination station. The sending station can check for the token to see if it was received and consequently copied by the destination target.

## 5. OUTREACH

This section describes outreach activities with the visible light transceivers and the path toward exploring the associated communication network curriculum more broadly.

### 5.1 Hands-on sessions in secondary schools

One of the most rewarding activities is the interaction between students of different levels of education, made possible through the creation of collaborative teams. Fig. 6a shows the project coordinator, together with students from the Polytechnic Institute of Castelo Branco, that are involved with the project and have developed the first prototype of the optical transceivers, using electronic breadboards. Fig. 6b to 6d shows some of the hands-on sessions that took place in secondary schools. Here, the role of the project coordinator is minimized, to give room to a direct interaction between students from secondary schools and higher education. The hands-on sessions were designed to focus on the photoelectric effect and the properties of light subjects.

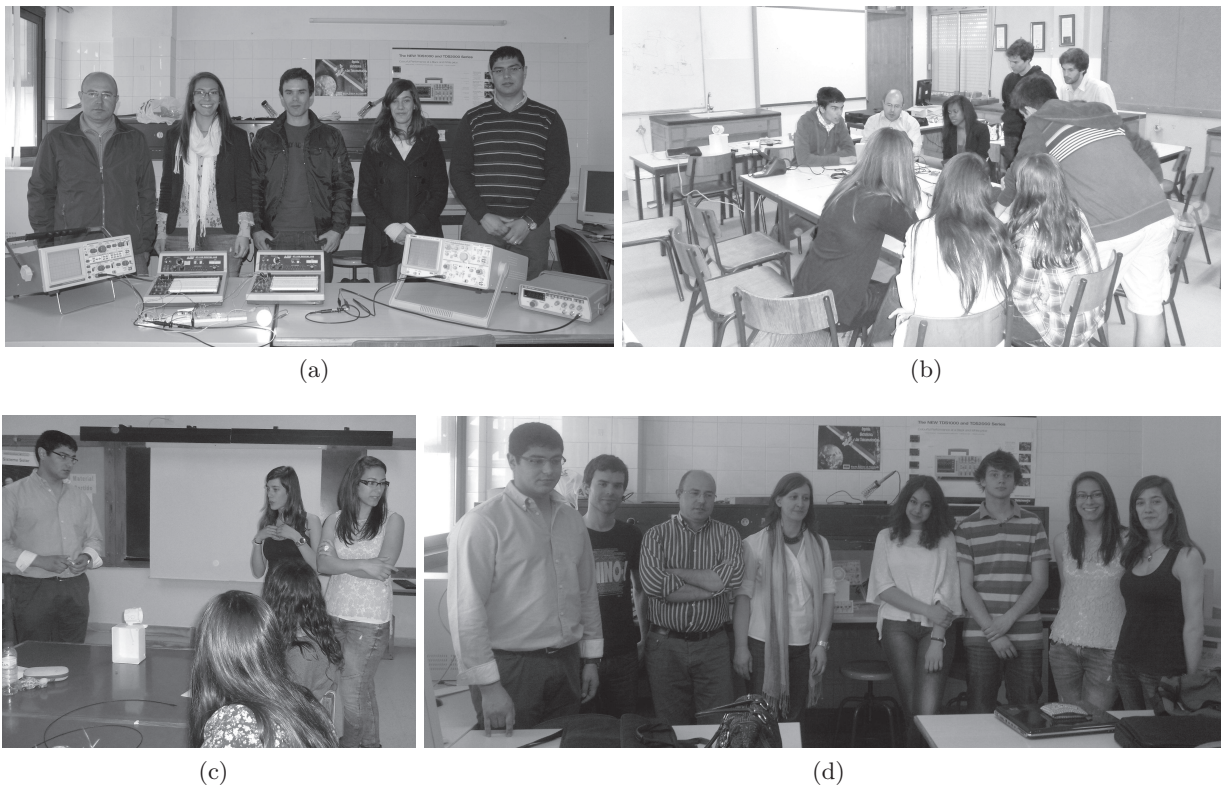

Figure 6: Pictures taken during hands-on sessions in: (b) Quinta das Palmeiras secondary school, (c) High School cluster from Fundão and (d) Amato Lusitano secondary school. The team from the Polytechnic Institute of Castelo Branco is presented in (a).



## 5.2 Young scientists and researchers science fair

Each year, the Museum of Electricity in Lisbon, gathers hundred of young researchers to participate in a national science fair, organized by a youth foundation.<sup>11</sup> The project “On-Light: Optical Social Network” was represented by a team composed by three students, one from the Polytechnic Institute of Castelo Branco (higher education) and two students from Amato Lusitano secondary school, and accompanied by two educators. The stand was composed by a poster, describing the theoretical aspect related to the photoelectric effect and the properties of light, and a table with two optical transceivers, as depicted in Fig. 7b. The participants could exchange messages bi-directionally, using portable computers connected to each optical transceiver, as depicted in Fig. 7a.

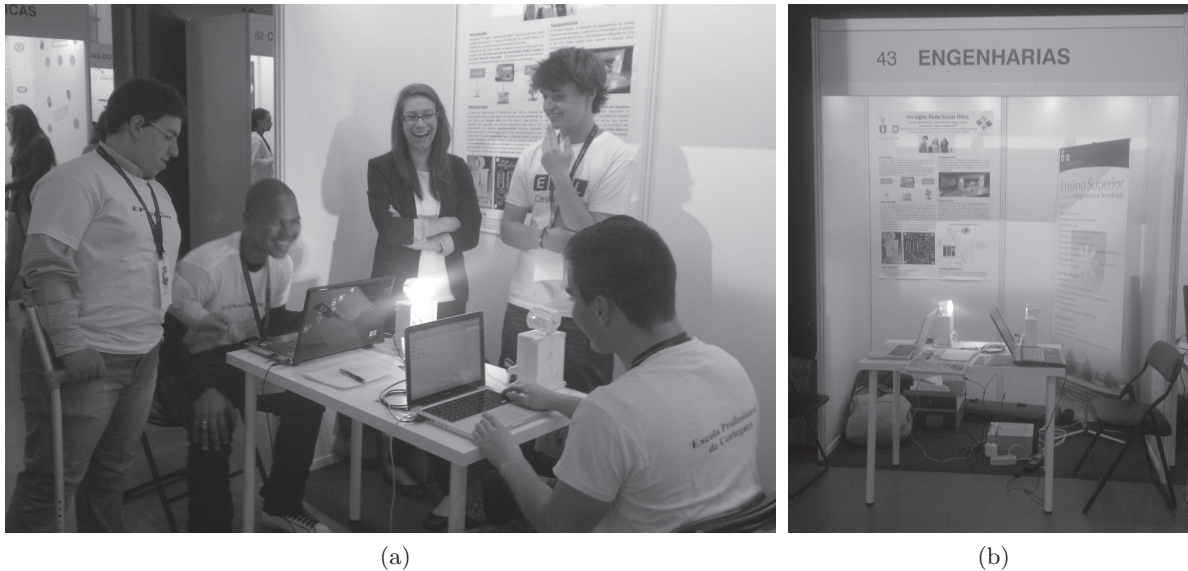
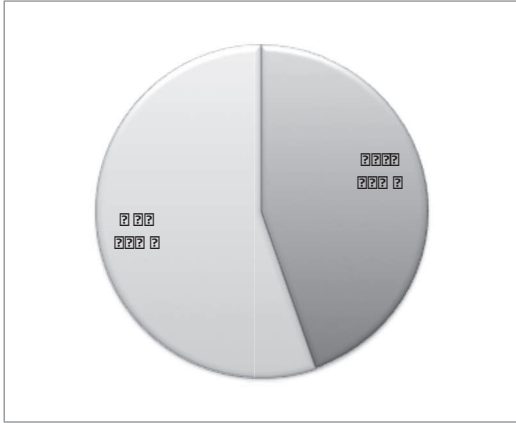

Figure 7: Picture of the stand during the Lisbon science fair contest in May 2013. Each stand has dimensions 1.0 m x 2.0 m x 2.5 m. The organization provides one table, two chairs and a power cord with each stand.

## 6. RESULTS AND ANALYSIS

Although the participation in science fairs and hands-on sessions is *a priori* a good indicator of the relative success of the project, the only way to ascertain whether this is true is by means of an opinion pool about the project with the general population. Therefore, a survey has been administered during the participation on the Lisbon science fair, in May 2013 (described in Section 5). After each participant has exchanged messages with the optical network (e.g. Fig. 7a), we followed with a survey to collect their opinion. Fig. 8 shows the questions along with the responses gathered during the event. The total intake was 38 answers. Since the participants on the science fair were mainly students from secondary school, the sample mode is 18 years old (Q6). However, the science fair is opened for the general public, and received attendees from all ages. As a result of the participant responses, the following conclusions were drawn:

- The level of satisfaction of the participants after experimenting the project is positive. More than 94 % agreed that the project was interesting (Q4), even if only 16 % had previous contact with similar projects (Q2). Only 2 % of the 38 participants were not satisfied or interested by the project (Q4).
- When asked if the project could evolve for a practical use, 84 % agreed with that affirmation (Q3). From the participants, 45 % had already knowledge that light can be used to communicate (Q1), and 68 % strongly agreed that the properties of visible light should be used in Telecommunications (Q5).
- Most of the participant asked, after experimenting the project, if LED lamps already used in many houses, could be used to deliver broadband communications in a near future. Although a standard for VLC is already active,<sup>7</sup> the technology beyond this approach is still in its infancy due to the enormous success of Wi-Fi technology.



**Q1** Have you ever thought that visible light could be used for telecommunications?

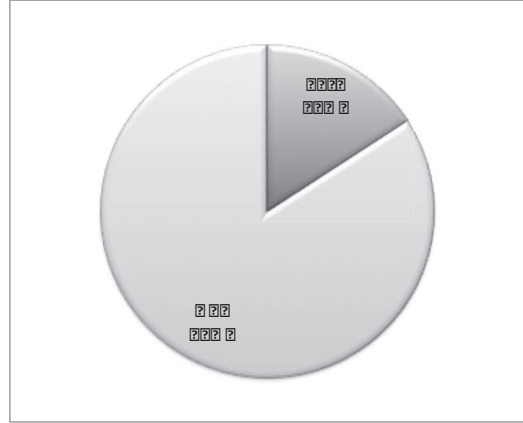

**Q2** Did you ever had contact with similar projects?

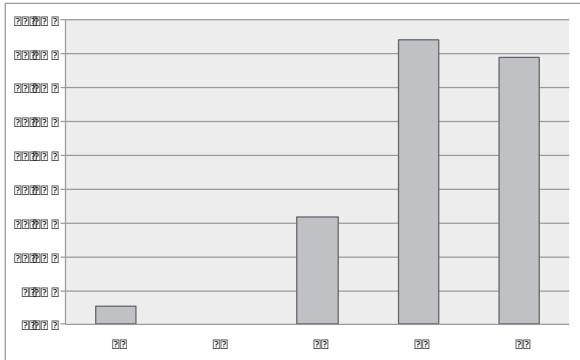

**Q3** Do you think that this project may evolve for a practical use?

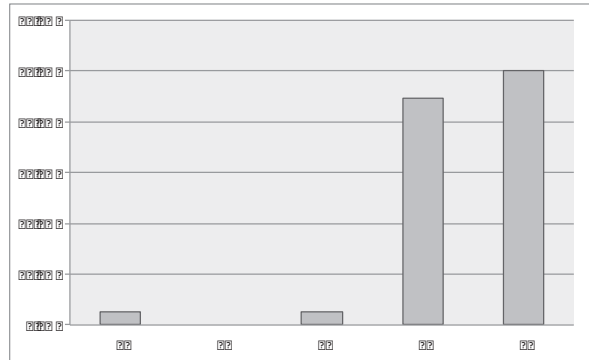

**Q4** Do you find this kind of project interesting?

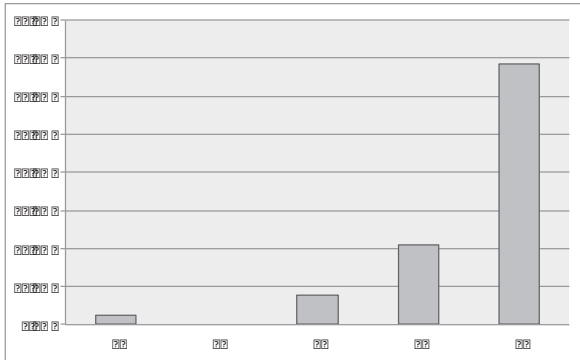

**Q5** Do you think that the properties of light should be exploited for telecommunications?

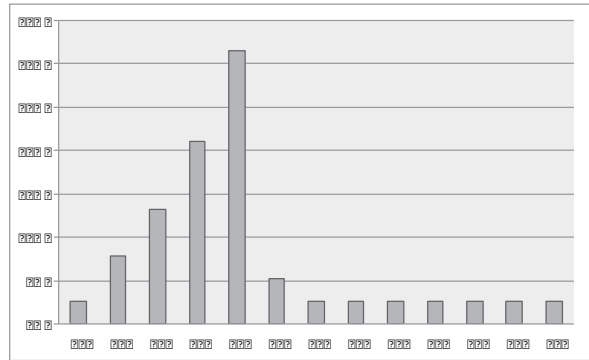

**Q6** What is your age?

Figure 8: Survey responses gathered during the Lisbon Science Fair in May 2013. Questions **Q1** and **Q2** may be answered with “yes” or “no”. Questions **Q3** to **Q5** can be answered with a Likert scale from 1 to 5, for which 1 = strongly disagree, 2 = disagree, 3 = unsure, 4 = agree and 5 = strongly agree.



## 7. FUTURE WORK AND CONCLUSIONS

The development of the transceivers is still in its early stages, and an optical ring network is not yet a reality. However, the project has already reached a few milestones, and probably the most significant ones: The continuous cooperation between students from secondary schools and the Polytechnic Institute in Castelo Branco district has become a reality. The hands-on sessions and the joint participation in science fair are the result of that. The question is how to maintain this cooperation in the future, when the project is concluded? The opinion pool about the project, during the science fair in Lisbon, is a good indicator that we should continue with this approach. In October 2013, a international science Fair, called “Ciência em Ação”, will be held in Bilbao, Spain. The project team has already filled the application form, and hope to participate in this event, that will certainly motivate even more our student teams to continue their cooperation, and hopefully find a motivation to enroll on engineering courses.

## ACKNOWLEDGMENTS

The author gratefully acknowledges the Portuguese program Ciência Viva (Project PEC41/2013) and the Polytechnic Institute of Castelo Branco for funding this research.

## REFERENCES

- [1] Habash, R. and Suurtamm, C., “Engaging High School and Engineering Students: A Multifaceted Outreach Program Based on a Mechatronics Platform,” *Education, IEEE Transactions on* **53**(1), 136–143 (2010).
- [2] “Ciencia Viva - Agencia Nacional para a Cultura Cientifica e Tecnologica,” (May 2013). <http://www.cienciaviva.pt/>.
- [3] Selfridge, R. H., Schultz, S., and Hawkins, A., “Free-Space Optical Link as a Model Undergraduate Design Project,” *IEEE Trans. Education* **50**(3), 208–215 (2007).
- [4] Schreyer, R. and Sonek, G., “An optical transmitter/receiver system for wireless voice communication,” *IEEE Trans. Education* **35**(2), 138–143 (1992).
- [5] Komine, T. and Nakagawa, M., “Fundamental analysis for visible-light communication system using LED lights,” *IEEE Trans. Cons. Electronics* **50**(1), 100–107 (2004).
- [6] Afgani, M., Haas, H., Elgala, H., and Knipp, D., “Visible light communication using OFDM,” in [*Testbeds and Research Infrastructures for the Development of Networks and Communities, 2006. TRIDENTCOM 2006. 2nd International Conference on*], 6 pp.–134 (2006).
- [7] “IEEE Standard for Local and Metropolitan Area Networks–Part 15.7: Short-Range Wireless Optical Communication Using Visible Light,” *IEEE Std 802.15.7-2011* , 1–309 (2011).
- [8] “Arduino: An open-source electronics prototyping platform,” (May 2013). <http://www.arduino.cc>.
- [9] LPKF, “LPKF PCB prototyping,” (May 2013). <http://www.lpkf.com/products/rapid-pcb-prototyping/>.
- [10] “IEEE 802.5 Token Ring Standard,” (May 2013). <http://www.ieee802.org/5/www8025org/>.
- [11] “Youth Foundation,” (May 2013). <http://www.fjuventude.pt/jcientistas2013/>.