

THE INQUIRY LEARNING MODEL
AS AN APPROACH TO MATHEMATICS INSTRUCTION

by

Michael C. Brune

A thesis

submitted in partial fulfillment

of the requirements for the degree of

Masters of Science in Mathematics Education

Boise State University

December 2010

©2010
Michael C. Brune
All Rights Reserved

BOISE STATE UNIVERSITY GRADUATE COLLEGE

DEFENSE COMMITTEE AND FINAL READING APPROVALS

of the thesis submitted by

Michael Christopher Brune

Thesis Title: The Inquiry Learning Model as an Approach to Mathematics Instruction

Date of Final Oral Examination: 01 October 2010

The following individuals read and discussed the thesis submitted by student Michael Christopher Brune, and they also evaluated his presentation and response to questions during the final oral examination. They found that the student passed the final oral examination, and that the thesis was satisfactory for a master's degree and ready for any final modifications that they explicitly required.

Margaret T. Kinzel, Ph.D. Chair, Supervisory Committee

Mary J. Smith, Ph.D. Member, Supervisory Committee

Laurie O. Cavey, Ph.D. Member, Supervisory Committee

The final reading approval of the thesis was granted by Margaret T. Kinzel, Ph.D., Chair of the Supervisory Committee. The thesis was approved for the Graduate College by John R. Pelton, Ph.D., Dean of the Graduate College.

ACKNOWLEDGEMENTS

I would like to thank Dr. Margaret Kinzel for the endless amount of time that she spent reading and re-reading. I would also like to thank all of my committee members, Dr. Mary Smith, and Dr. Laurie Cavey, for all of their advice in terms of the written document, my lesson designs, and throughout my investigation. The inquiry lessons would not have gone nearly as well without their input and advice. I also must thank my wife for having the patience to read through the entire document and give me feedback. Her willingness to put up with me throughout this process was also greatly appreciated. I owe them all a great deal of gratitude; I would not have been successful without their guidance and support

ABSTRACT

Since current approaches to mathematical instruction fall short of the goals of NCTM (National Council of Teachers of Mathematics) research was conducted in a small rural school district in the northwest United States evaluating inquiry based instruction. To complete the study two high school geometry classes were taught area formulation using a traditional lecture based approach to instruction. A third geometry class was taught area formulation utilizing inquiry-based instructional methods. Students in both groups took both a pre-test and post-test, filled out a questionnaire, and participated in a project designed to test their applications of mathematical understanding. Results indicated that inquiry-based instructional methods had a significant effect on students' ability to solve decontextualized mathematical problems, students' retention of the mathematics, and improved students' attitudes about the mathematics in which they were engaged.

TABLE OF CONTENTS

ACKNOWLEDGEMENTS.....iv

ABSTRACT.....v

LIST OF TABLESviii

LIST OF FIGURESix

CHAPTER 1: INTRODUCTION1

CHAPTER 2: LITERATURE REVIEW5

 Current Educational Practice5

 Constructivist Learning Approaches8

 Inquiry Learning9

 Implementing Inquiry11

 Inquiry Lessons and Instruction11

 The Importance of Community13

 The Role of Challenge and Proof14

 Conclusion15

CHAPTER 3: METHODOLOGY16

 Participants16

 Lesson Design17

 Lesson Progression19

 Procedure19

CHAPTER 4: RESULTS	25
Pre-Test	25
Post-Test	26
Questionnaire	32
Project	37
Retention Quiz	38
CHAPTER 5: DISCUSSION	40
Observations	40
Conclusion	44
Limitations	45
WORKS CITED	47
APPENDIX A	49
Inquiry-Based Lessons	
APPENDIX B	84
Tests and Quizzes	
APPENDIX C	91
Questionnaire	
APPENDIX D	94
Project Schematics	
APPENDIX E	98
Item Analyses	

LIST OF TABLES

Table 1: Lesson Progression	19
Table 2: Pre-Test Results	25
Table 3: Post-Test Results	27
Table 4: Questionnaire Results	33
Table 5: Retention Quiz Results	38
Table E1: Pre-Test Item Analysis	99
Table E2: Post-Test Item Analysis	100
Table E3: Retention Quiz Item Analysis	101

LIST OF FIGURES

Figure 1: Distribution of Scores for Post-Test.....	28
Figure 2: Post-Test Items $p=0.01$	28
Figure 3: Post-Test Items $p=0.05$	29
Figure 4: Post-Test Items $p=0.01$	31
Figure 5: Items on which Control Group Outperformed Experimental Group	32

CHAPTER 1: INTRODUCTION

Students often question the validity of the mathematics that they are exposed to in the classroom and its relationship to their everyday life. Doubt that the mathematics learned in school is applicable outside of school leads to a logical disconnect between what is learned in school and what may be needed for a real-life problem. Research into approaches used by students when confronted with mathematical situations outside of the classroom indicates that students do not transfer the mathematics used to complete classroom tasks into applicable knowledge. Instead students frame their attempts to solve a problem around either the environment or the context of the problem. Since classroom problems are often decontextualized, giving no real-world context for the students to consider, and the classroom environment is not replicated by students' real-world experiences, students fail to see the relationship between their educational experiences and real-world mathematical applications. As a result students do not transfer mathematical knowledge learned in school (Boaler, 1998).

The inability to transfer mathematical learning into situations outside of the classroom seriously calls into question the goals of our educational practice. If educators want their students to be mathematically literate and able to use classroom skills in the world around them, then students must learn how to apply the mathematical skills learned in the classroom. Current instructional practice, however, is focused on students' ability to complete classroom assignments and thereby progress to the next level of mathematics instruction. Such an approach would be acceptable if students planned to continue

learning in classrooms throughout their lives. However, since students will be progressing into the real-world they will need to develop mathematical skills that they can utilize throughout their lives.

Investigations into students' inability to transfer mathematical knowledge reveal underlying instructional issues. Boaler (1998) has suggested that students in traditional mathematics classrooms are unable to use the mathematics learned because they don't fully understand the mathematics, but simply have learned to repeat specific processes that underlie certain mathematical actions. Skemp (1976) seems to support this with his research into the role of instrumental (procedural) understanding in the classroom and strongly advocates relational approaches. These relational approaches focus on building conceptual understanding that can be applied in many different environments. Skemp credits the ability to apply learned mathematics to a more dynamic understanding of mathematical relationships.

Boaler (2000) also suggests that the context of the classroom environment bears some of the blame with regard to students' lack of ability to solve problems framed in a real-world environment. Her research states that students learn classroom cues and then base their mathematical actions on how they interpret these cues. Classrooms in this respect serve as a very specific social environment in which certain behaviors and practices have been learned and are strictly followed. Along with the cue-based behavior, students' exposure to lecture and drill-oriented instruction has developed their perspective of how mathematics is supposed to be understood and used. Since the same cues present in a lecture-based classroom are not present in real-life mathematical

situations, students fail to perceive the relationship between school-learned mathematics and areas where mathematics is useful in their real-life experiences (Boaler, 1998, 2000).

Skemp (1976) goes as far as to suggest that two completely different forms of mathematics are being taught, leading to different types of understanding among students: instrumental and relational. Skemp emphasizes that the type of understanding a student achieves affects that student's ability to use their mathematical knowledge in different contexts. Obviously, it is desirable that mathematics instruction promote students' ability to apply mathematics in a variety of ways and in different contexts. Educators in the United States are currently falling short of that goal and, for the most part, continue to teach for instrumental understanding. This problem must be addressed and non-traditional approaches need to be considered as possible catalysts to relational understanding.

Open-ended, process-based, mathematical tasks have been shown to promote more student enjoyment, retention, understanding, and transferability of mathematics knowledge (Boaler, 1998). Such approaches, however, have not been applied on a large scale. Current textbook selection seems to reflect a more traditional approach to mathematics instruction. Although reformed curriculums have been shown to increase problem-solving ability and conceptual understanding, only about 15% of the current textbook market is made up of such texts, indicating that they are not widely used (Schoenfeld, 2007). When problem-solving ability and mathematical aptitude are critical for student success in the 21st century environment, it is indefensible for educators to continue promoting practice that does not attend to these abilities.

There is unease from teachers when implementing a new methodology into a classroom that the students will not adequately adapt to their new role. Throughout their classroom experiences, students develop a sense of acceptable and expected behaviors. Changing the instructional style will require a shift in their role as a student. This raises concern as to whether students are equipped to adapt to a new classroom climate and become the successful problem solvers that society wishes them to be. If they do adapt, one wonders how long it will take students to properly assume their new role.

Students will also be expected to continue to perform on standardized tests even though less traditional approaches are being used. Educators fear that less procedural approaches will inhibit students' ability to solve decontextualized problems, thereby handicapping them when they take standardized tests. In an era where high-stakes testing can mean receiving a diploma as a student, and receiving funding as an institution, these concerns are worth consideration.

I conducted an investigation of the inquiry-learning model to address some of the concerns raised when new instructional approaches are taken. It is important to understand which educational methods are most effective in light of what we expect students to know, and be able to accomplish in and out of the classroom. In light of these educational priorities, my research goal was to determine what affects an inquiry-based instructional approach would have on:

- Students' problem-solving abilities.
- Students' ability to solve traditional decontextualized classroom problems.
- Students' retention of mathematical knowledge.
- Students' attitude towards the mathematics in which they are engaged.

CHAPTER 2: LITERATURE REVIEW

Current Educational Practice

In a recent study, Jerry Stonewater (2005) examined 29 teachers' perceptions of best educational practices in middle-school mathematics before and after they were taught using inquiry-based methods throughout a mathematics course designed for middle-school mathematics teachers. Data were collected using an open-ended essay in which teachers were asked to address specific elements of what they viewed as the best practices for teaching mathematics. This essay was administered before and after the instructional period. The initial responses revealed that 20 of the 29 teachers involved viewed mathematics education as a process of imparting knowledge to students. What these teachers perceived as good educational practice consisted mostly of teachers modeling a specific way to solve a problem, followed by students solving similar problems using the method presented by the teacher. Best teaching practice was then defined as reducing problems to a set of steps that the students could follow.

The most common approach to teaching mathematics fits this perception and involves a review of previously completed homework, followed by a teacher-directed demonstration the students watch carefully, and concluding with a homework assignment from the textbook. This model emphasizes mathematics through reproduction of procedure and memorization (Stonewater, 2005; Goos, 2004) and promotes the view that knowing mathematics means being able to reproduce the correct answer as judged by the instructor (Lampert, 1990).

The National Council of Teachers of Mathematics (NCTM) does not support such an approach to mathematics education. In their recent online publication (NCTM, 2009) of guiding principles in mathematics instruction, the NCTM asserts that students need to learn mathematics by solving problems that support conceptual understanding. Ideally a marriage between knowledge, procedure, and conceptual understanding would be the result of mathematics lessons. In fact, they go as far as to say that reasoning, communication, problem solving, conceptual understanding, and procedural ability must be developed simultaneously for a student to be successful at mathematics (NCTM, 2009).

Skemp (1976) bolsters this argument with his discussion of relational versus instrumental understanding. Instrumental understanding can be considered strictly procedural understanding, rules without reason. Relational understanding, on the other hand, is an interrelated conceptual understanding of the mathematics that students learn, both the how (procedure) and the why for a specific mathematical exercise. It is reasonable to believe that relational understanding is much more applicable and transferable for students. Traditional educational practices, however, more closely resemble practices meant to encourage only instrumental understanding.

McKinney and Frazier (2008) verified this with their survey of high poverty middle schools designed to gain insight into common educational practices. The study highlighted that a high percentage of teachers primarily rely on direct instruction even though their research suggested that such skill and drill approaches don't adequately prepare students to use mathematics. They also noted that although hands on tasks are

beneficial in building conceptual understanding, only 25% of the classrooms surveyed used such tasks frequently.

Further evidence that current practice does not meet the ideal goals presented by the NCTM and Skemp can be found in evaluations of the texts used to teach mathematics. A recent study of textbooks used in Australia revealed that most texts presented problems of a low overall procedural complexity. These texts also contained a low overall number of concept connecting questions, completely overlooking the need for relational understanding. This lack of challenge, and also the high percentage (25%-71%) of repetitive questions coincide with teachers' push for a back-to-basics approach (Vincent & Stacey, 2008). The same push for a back-to-basics approach was present in the United States throughout the relatively recent "math wars" and resulted in students who lack fundamental mathematical skills, limiting their ability to compete internationally (Cavanagh, 2006).

NCTM pushes for conceptual approaches to instruction to support these fundamental mathematical skills. The NCTM standards for mathematics have become widely used as a basis for many state curriculums. However, curriculums designed to meet these standards take on many different forms. Schoenfeld (2007) comments that due to the nature of the standards, textbooks can simply contain strict procedure followed by repetitive practice and still meet individual strands of the standards. Such texts cover the listed standards, but fail to emphasize problem-solving ability and relational understanding. Sadly these texts are widely used in states such as California, which represent large student populations, because they meet state textbook adoption guidelines (Schoenfeld, 2007).

The lack of focus on relational understanding evident in current educational approaches and textbook selection in the United States is not ideal if the goal is to prepare students to use the mathematics that they learn in school throughout their lives. New approaches to instruction must be considered to support students in developing a relational understanding of mathematics.

Constructivist Learning Approaches

The constructivist approach to learning takes the position that learners build a construct within their mind to understand their sensory experiences. This construct serves as a catalyst for students to internalize the relationships that exist in the world around them. Constructivist learning theories suggest that students develop their own knowledge through experience and interaction. In a lecture-oriented learning environment, students will build their own understanding of the material presented during the instruction based on their experiences. This can create disparity between what the educator is attempting to teach and what the student actually learns. Simply stated, constructivist learning theory suggests that knowledge must be developed; it cannot simply be passed on by the instructor (Saunders, 1992). Constructivist approaches to learning are more in line with the goals of the NCTM in the sense that they focus on building students' conceptual understanding, linking new knowledge to previous experience.

Constructivist approaches have come under fire from some researchers. Kirschner, Sweller, and Clark (2006) concluded that constructivist guided approaches lack proper guidance and as a result overuse students' working memory while ignoring

their long-term memory. They argue that skills and knowledge necessary for future application cannot be learned without first being added to students' long-term memories.

Hmelo-Silver, Duncan, and Chinn (2007) argue that Kirschner, Sweller, and Clark are incorrect in their evaluation of some of these constructivist techniques. They concluded that inquiry-based instruction and problem-based learning, both considered constructivist guided approaches, can arguably be considered to be guided forms of instruction. They also note that between these two methods there is enough similarity that they are often considered the same approach but were developed through different educational avenues.

Inquiry Learning

The inquiry learning style establishes itself as different from other constructivist guided approaches in the sense that it is not a minimally guided learning environment and that direct instruction can be used in the context of inquiry learning. Proper inquiry learning requires that teachers carefully scaffold their students as they challenge them with new mathematical material (Hmelo-Silver et al., 2007). Once students are challenged, they are expected to engage in creating conjectures, analyzing conjectures, communicating, working collaboratively, and engaging in mathematical argument (Stonewater, 2005). This sets inquiry learning squarely within the context supported by the NCTM and other reform documents (Lampert, 1990).

Research regarding inquiry-learning programs suggests that students can achieve relational understanding through this approach. Through the use of inquiry-based instructional methods, students have shown improvements in their ability to apply

mathematical knowledge to multiple environments and to solve complex problems. Students taught using inquiry-based methods have also been shown to transfer their knowledge better to new tasks, and still maintain the ability to perform well on standardized tests. In fact, students in a middle school that adopted an inquiry-based learning model performed better on their standardized tests when compared with those in the traditional curriculum (Hmelo-Silver et al., 2007). Ismail (2008) noted that when using the Connected Mathematics Program, which is arguably an inquiry directed text, her students showed great gains in their problem-solving abilities with no loss in their procedural abilities. These examples show that inquiry methods offer great opportunities for enhancing students' problem-solving and mathematical-reasoning abilities without sacrificing their procedural knowledge.

Longitudinal studies have also shown that gains made in inquiry-based classrooms are more likely to last long periods of time, reduce achievement gaps, and help disadvantaged students find success (Hmelo-Silver et al., 2007). Long term gains may be related to the fact that students involved in inquiry classrooms report that they find these classes more enjoyable than other studies in school because of the discussion and reasoning involved in place of memorization (Goos, 2004). This ability to find solutions to problems rather than memorize them is often cited as a better way to understand mathematics and is linked to better retention, because if your memory fails you, your logic will not. Students with self-reported bad memorization skills tend to enjoy inquiry instruction over traditional methods (Stonewater, 2005).

Though apprehension exists among educators when considering adoption of a new approach to instruction, the results of Stonewater's 2005 study involving 29 middle

school mathematics educators needs to be considered. Concluding essays written by the participants revealed that the teachers' beliefs about educational practice were shifting. Of the 20 instructors who initially favored direct instruction, 14 began to show signs that their perception was changing. After becoming involved in lessons that were taught using the inquiry approach, teachers began to see that different levels of understanding could be attained through inquiry-based instruction (Stonewater, 2005). Such research suggests that though educators lack exposure to the inquiry-learning method, they may see the value in such methods if they could see them implemented.

Implementing Inquiry

Inquiry Lessons and Instruction

Proper inquiry instruction requires facilitation by the instructor and well-designed inquiry tasks. Such tasks can be identified as problematic situations that engage the students in mathematical problems in context (Hodge, 2008). Before tasks are put into action, they should be evaluated to ensure that they meet a standard of objective-oriented instruction. Tasks should promote understanding of important mathematical ideas or ways to solve problems. Tasks should be accessible to all students and support mathematical thinking. Finally, tasks should relate to other mathematical topics being learned so that mathematics is not separated into strands, but understood as a web of connected knowledge that can be applied (Marcus & Fey, 2003).

As inquiry lessons are designed, teachers should consider what students already know about a topic, what knowledge they want students to gain, a process for getting there, and an understanding of where this knowledge can be applied (Barell, 2007).

Lampert (1990) states that “The most important criterion in picking a problem was that it be the sort of problem that would have the capacity to engage all of the students in the class in making and testing mathematical hypotheses” (p. 39). Such problems allow students access to both inductive and deductive reasoning as they make conjectures and prove or disprove them together. Properly designed inquiry lessons will provide students with the opportunity to investigate, debate, and challenge what they know (Hmelo-Silver et al., 2007).

In such a classroom of constant conjecture, a great burden of understanding is placed on the teacher as they serve as the facilitator of the learning process. It is easy to imagine that students will come up with many mathematical theories that may or may not be correct. The teacher must be able to redirect the students when necessary. Teachers, therefore, must closely monitor students’ processes, adjust quickly to individual student needs, and be ready to face the challenges within the classroom of inquiry (Goos, 2004).

It is also important to note that although direct instruction can be used in a classroom of inquiry, it is suggested that investigative learning precede direct instruction. Pesek and Kirshner (2000), in their research of investigative approaches to learning and subsequent student understanding indicate that when direct instruction precedes investigation, students learn less and overlook important conceptual connections. When investigative opportunities come before direct instruction, students show a much better ability to conceptualize the mathematics they are taught. In this respect, explorations should precede direct instruction to allow students to construct their own understanding and make important connections between what they know from experience and what they are taught by the instructor.

The Importance of Community

Central to the concept of inquiry learning is the notion of a mathematical community. Students are expected to participate in discussion, promote and defend mathematical ideas, solve unfamiliar problems, and challenge the ideas of their peers (Goos, 2004; Hodge, 2008). Often students are asked to share their way of doing a particular task or their reasoning throughout the process. As a result, students begin to feel as though their processes are as important, if not more so, than the teacher's thinking about a problem. Student sharing is directed not only at the teacher, but also at fellow students, and fellow students have the right to challenge the reasoning of their peers (Hodge, 2008). Such interaction between peers acts as a scaffold to bring students to higher levels of understanding. Students who may not have been able to reach a new plane of understanding on their own do succeed at gaining new and complex mathematical understanding when working with others (Goos, 2004). When students do find success in such group-work sessions, they feel a strong sense of accomplishment, which may motivate them to continue future investigations (Stonewater, 2005). It is reasonable to assume that the same feeling of accomplishment would not be present if the teacher had provided the answer or if the solution had been arrived at through strict procedure.

The role of the teacher as facilitator and guide of the mathematical classroom community is crucial to the successful implementation of an inquiry approach. The teacher, as the master of the material, must make the mathematics accessible to the groups of students who are working through the problems by providing proper guidance without giving away the solution to the problem at hand (Stonewater, 2005; Goos, 2004).

Depending on students' understanding, the amount of guidance provided by the teacher fluctuates to meet the needs of the student groups. When groups make mistakes in their reasoning, these mistakes can be brought before the entire class and can lead to a discussion facilitated by the instructor to bring to light any misconceptions that may have been presented. By structuring investigations in such a manner, students will feel ownership of the mathematics that they are learning (Goos, 2004). By allowing students to interact with one another, they learn more than they could have if the answer or process had simply been given to them (Stonewater, 2005).

The Role of Challenge and Proof

To fully realize the benefits of inquiry learning, students must be encouraged to continually challenge solutions, even those that they find themselves. Questions must be weighed against logic and reason. No student should be satisfied without being able to prove that his or her solution is the correct one (Levasseur & Cuoco, 2003). Initially, these challenges to the information being presented will likely come from the instructor, but through instructor modeling of proper inquiry behavior students will take on the roles necessary to be active learners in their environment. Case studies show that students who have participated in an inquiry environment for some time begin to desire the complete assurance that comes through proof, even if earlier in their studies they were more interested in simply completing a task (Goos, 2004). Such benefits of inquiry learning are encouraging in the face of NCTM guidelines that push for instruction involving reasoning and proof (NCTM, 2009).

Conclusion

Since new direction is needed in mathematics curriculum and instruction, investigations into the inquiry method seem natural. Data suggest that most students learn best when given problems to solve and that such problem-based learning improves retention and ownership of the mathematics (Goos, 2004; Stonewater, 2005; Hmelo-Silver et al., 2007). Through investigations into this approach of teaching it seems feasible that one could create a more optimal learning environment for most students.

Few articles are dedicated to the detriments of inquiry instruction; however, Lampert did indicate that not all students participate in inquiry environments. In particular, some students may not wish to participate in classroom discussions (1990). Though there are concerns regarding inquiry-based instructional methods they are not severe enough that we should ignore the possible benefits of such an approach. In light of the current state of mathematics education, and the consideration that in current practice not all students are engaged learners, the inquiry-learning approach should be investigated. The possible benefits to students and mathematics education in the United States warrant a movement towards constructivist-based instruction and inquiry-based learning opportunities.

CHAPTER 3: METHODOLOGY

To complete this quasi-experimental study of the effects of inquiry-based learning on problem-solving ability, I conducted research at a high school serving grades 10-12 in a low-income rural school district. The high school had an enrollment of 628 students.

Participants

Experimental and control groups were chosen based on pre-established classes. These classes were determined by student enrollment and administrator and teacher placement. The experimental group consisted of 27 students, of which 14 were female and 13 were male. I instructed this class during fifth period, which fell directly before lunch. Two classes represented the control group; I instructed the control group during sixth and seventh periods. The control group consisted of 37 students, of which 20 were female and 17 were male. Student ages ranged from 15-18 years in all three class periods. The experimental group was made up of 2 seniors, 15 juniors, and 10 sophomores. The control group on the other hand was made up of 3 seniors, 20 juniors, and 14 sophomores. The overwhelming majority of students were white, with only two Hispanic students and one African American student involved in the study.

Each class was a regular session geometry class that met for 49 minutes daily and was made up of students from a variety of educational experiences. Every student must have completed some form of Algebra 1. Some completed this through a two-year course, while others completed the more conventional one-year course. Students' prior

mathematical path had no bearing on where they were placed, so each class was a mixed-ability group.

Lesson Design

One of the goals of this study was to teach the same material two different ways: using traditional, lecture-based instruction with the control group, and inquiry-based instructional methods with the experimental group. These lessons were to be taught over the same timeframe. For this reason, I followed the progression through area formulation dictated by the McDougal Littell Geometry 2007 textbook adopted by the district.

The control group lessons were taught using the traditional approach described by Stonewater (2005) and Goos (2004). This involved reviewing the homework assignment from the previous day, followed by a presentation of new material, and concluded with a homework assignment of 20-30 problems. New material was presented using lecture-based instruction that included examples of problems that they would see in their homework, and the formulas required to solve these problems. Parts necessary for substitution into area formulas were highlighted, and examples included shapes that were orientated in different ways. These lessons also included dissections of specific area formulations to inform students of the origins of the formulas taught during the lesson.

Experimental group lessons were inquiry-based and had specific objectives for each day to keep the experimental group on pace with the control group. Students in the experimental group solved the same type of area problems but were taught in a very different manner than the control group. Lessons were specifically designed to meet the criteria of inquiry-based learning environments and are included in Appendix A. A

definition of what inquiry learning entails can be found through the National Research Council's National Science Education Standards (1996) and is as follows:

Inquiry is a multifaceted activity that involves making observations; posing questions; examining books and other sources of information to see what is already known; planning investigations; reviewing what is already known in light of experimental evidence; using tools to gather, analyze, and interpret data; proposing answers, explanations, and predictions; and communicating the results. Inquiry requires identification of assumptions, use of critical and logical thinking, and consideration of alternative explanations. (p. 23)

The inquiry methods for instruction used focused student investigations and encouraged community-based learning through discussion and on-going hands-on tasks. These tasks supported students as they worked to discover specific mathematical relationships and understanding.

The inquiry lessons were taught through facilitated group work with the expectation that students would work with their group members to develop methods for finding the areas of given figures. As the instructor, I closely monitored the process of individual groups, and required all participants to give justification for their methods. I carefully designed the lessons to allow students to move from more simple environments for formulation into more complex problems that required usage of a developed method for finding area. As the class progressed into considering more complex shapes, students were expected to draw on previous explorations to find the areas of these shapes. The lessons were designed to engage students in developing their own strategies for area formulation, fitting with basic constructivist learning principles.

At the end of each lesson, students were provided a problem set to take home and complete using their newly developed method. These problem sets were short (consisting of three to five problems) and only served to solidify developed understandings.

Lesson Progression

Area topics taught in this unit were taught in the order presented in Table 1.

Table 1: Lesson Progression

Experimental Group	Control Group
1. Area of parallelograms	1. Area and perimeter of rectangles, squares, and circles
2. Area of triangles	2. Area of triangles and parallelograms
3. Area of trapezoids	3. Area of trapezoids, rhombuses, and kites
4. Area of rhombuses and kites	4. Review of formulas covered so far
5. Perimeter and area of similar figures	5. Perimeter and area of similar figures
6. Circumference and arc-length	6. Circumference and arc-length
7. Areas of circles and sectors	7. Areas of circles and sectors
8. Area of regular polygons	8. Area of regular polygons

Procedure

At the beginning of the study, all members of the control group and the experimental group took a pre-test. The purpose of the pre-test was to measure students' prior knowledge about shapes and area-based problems. Prior knowledge should have included: an ability to use the Pythagorean theorem to find missing side lengths in right triangles, the ability to use right triangle trigonometry to find unknown measures for sides in right triangles, a basic understanding of perimeter, and a basic understanding of simple area formulas. Known formulas should have included square, rectangle, triangle, and circle area formulas. The pre-test also contained a small number of problems involving

area formulas that the students had been minimally exposed to, including trapezoids and parallelograms. Data from the control group was compared with the experimental group using a t-test. Differences were noted and included in the final comparison of the two classes.

Once the pre-test was completed, the differing lessons began. I instructed both the experimental class as well as those classes that represented the control group. I was careful to maintain a different approach between the two groups, using well-developed lessons to ensure fidelity to each instructional approach.

The inquiry-based lessons were taught over a two and a half week period. Students were encouraged to discuss the mathematics and develop methods through this discourse. Students' desks were arranged in groups of two or three to encourage group discussion. I served as a facilitator of the discussion and guided the direction of the discourse in a way that helped students recognize the meaningful relationships underlying their mathematical tasks. This included small segments of direct instruction as well as extended periods monitoring students' progress as individual groups developed approaches. I closely monitored individual groups' progress, aiding them in recognizing any noticeable misconceptions through question posing. Though direct instruction was sometimes used, it was never the primary method of instruction, and every class period began with student investigations and discussions of the mathematics.

Students were expected to defend their mathematical ideas to their groups as well as to the entire class, to support their abilities to explain mathematical ideas. Students were not required to take formal notes. Instead, the hands-on materials and handouts that students received during lessons became their resource for future use. Daily lessons

concluded with short take-home assignments to assess the students' developing understanding of the mathematics.

The control group was taught using the McDougal Littell Geometry 2007 edition adopted by the selected school district. Their lessons followed those from the selected text and were supplemented with worksheets that I generally have used in my geometry classes to highlight specific concepts of area formulation. Students were instructed how to find the area of a variety of geometric figures and were expected to use those formulas on a variety of problems, including problems that do not give all necessary information. All instruction was lecture-based and examples were provided to guide the students in using the area formulas. Students were also shown the reasoning behind the area formulations. For example, when students were learning how to find the area of a triangle, I illustrated for control-group students that a triangle is actually half of a parallelogram.

Students were expected to participate in the lecture by answering questions and by taking formal notes, which were assessed for completeness at the end of the unit. To encourage participation and focus on the instructor throughout the class period, students' desks were placed in rows facing forward. Once instruction was completed, students were given an assignment out of the book consisting of 10-20 problems and a small amount of class time to begin work so that they could ask questions if necessary. Work not completed during this time should have been taken home by the student for completion. Students should have felt comfortable with this progression through the material, as this instructional approach had already been established throughout the school year.

Throughout the course of the study I maintained a journal in which I documented student behaviors within the control and experimental classrooms, as well as my own reflections on what went well during the instructional periods. I recorded examples of student conversations and strategies as they attempted to use the mathematics they were learning. Through careful observation I hoped to discover if the method of instruction impacted the students' willingness to attack difficult problems on their own. I was also trying to determine if the students in the experimental group adapted and took responsibility for their learning. When differences developed in their approaches to the mathematics and problem-solving approaches, then I attempted to generalize these differences and included them in my observational data. I also tried to find whether the experimental-group students performed better when confronted with a real-life situation involving area, observing whether they had a better established ability to convey meaning and understanding through mathematical discourse than their control-group peers. All of this information was important in determining the overall success of each educational approach.

At the end of the two and a half week period, both groups of students were given a post-test. The post-test contained standard decontextualized mathematical problems similar to those found on standardized tests and in textbooks. These problems fell into two categories: problems that had all necessary parts given in the figure, and problems that needed some parts calculated in the figure before area could be determined. The post-test also contained a section of problems that required students to apply their problem-solving abilities. These problems were given in less traditional contexts and required more than a simple area formula to solve. Such problems required more analysis

on the part of the students and a better understanding of the area relationships that exist among shapes. Students' post-test scores were compared based on their instructional approach. A t-test was used to determine differences between group scores on the post-test. Determining the effectiveness of each approach was partially based on these findings.

At the end of the study, all students were asked to complete surveys designed to gain insight into their perspective of the mathematics learned. This included program-oriented questions developed to measure students' attitudes towards the instructional approach as well as questions regarding their feelings towards the usefulness of the mathematics they had just learned. The survey was designed to gain insight into how students felt about the mathematics they learned with respect to their future learning and to real-world situations. A copy of the survey can be found in Appendix C.

After the post-test and the survey, experimental and control-group students completed a culminating area project. This project involved finding the area of the floor of a classroom from a dome-shaped high school. For students to effectively complete the project, they needed to be able to use their problem-solving abilities as well as their understanding of area to break a complex region into manageable parts. I monitored their progress as the different groups completed this project. The goal of this culminating exercise was to determine if the experimental group was better prepared to complete a real-life situational problem involving area. I monitored all groups for their approaches to the problem and monitored discourse among students. Any generalizable differences between the control and experimental students were included in the final evaluation of the inquiry-based instruction.

At the very end of the year, all geometry students were given a retention quiz over the area unit. This quiz included area problems similar to those on the post-test. Scores on the retention quiz were collected and analyzed to see if there was any difference in retention between the two groups. An example of the retention quiz can be found in the Appendix B.

At the end of the research, responses and test data were collected and analyzed for trends. Student data were used to answer the research questions posed and to give insight into how students learn mathematics. The data also gave insight into which instructional method was most effective in preparing students to use mathematics in their life and to pass standards-based mathematics exams.

CHAPTER 4: RESULTS

Pre-Test

The study began with the completion of a pre-test by all students in both the control and the experimental groups. Students who did not return consent forms were excluded from the final analysis. The scores of the control group and experimental group were compared to obtain a baseline measure of students' knowledge. The mean score was found for each group, including the standard deviation. This was followed by a t-test to evaluate for differences in the scores not attributable to chance. Results can be found in Table 2.

Table 2: Pre-Test Results

	N	mean	standard deviation	p-value
Control	33	6.70	3.70	0.151
Experimental	19	8.26	3.78	

Clearly the mean score for the experimental group was higher on the pre-test, though not at a level that could be considered statistically significant with $p=0.151$. To gain further insight into the differences in students' scores on the pre-test, a complete item analysis was done for each student who completed the pre-test. Results of the item analysis can be found in Appendix E and the pre-test can be found in Appendix B.

A review of the item analysis of the pre-test revealed that the only item that appeared to have a statistically significant difference in score between the control group and the experimental group was item 3f. This item involved finding the circumference of a circle and appeared to reveal that the experimental group had a better memory of the formula for circumference. Item 3d also revealed a rather large difference in mean scores. This item involved finding the perimeter of a triangle with an altitude given. Further testing on individual items revealed that if the only items included in the t-test were those involving area, items 4a-4g, then the p-value increased to $p=0.196$. If problem 4a, the area of a rectangle, was removed from this set, then the p-value for comparing means increased to $p=0.454$. This revealed that the students' overall understanding of area did not differ in a statistically meaningful way.

Post-Test

After the treatment period the post-test was given. The analysis of the post-test mean scores for the two groups can be found in Table 3. One significant factor for the post-test was student absences on the date of the test. Many students from the experimental and control groups were absent for school related events, and were unable to make up the test until 3-5 days after the actual test date. These scores were left out of the final analysis of the post-test since their results would require a higher level of retention. Retention was examined later in the semester. It seemed more relevant to include only comparable data, which would be limited to tests taken within a reasonable timeframe of one another.

The post-test results revealed a p-value = 0.0061, which is statistically significant at the $p=0.01$ level. This implies that the difference in the mean scores for the two groups did not happen by chance and can be attributed to the treatment that was given. Since the experimental group achieved a much higher score, we can conclude that the inquiry based instruction was beneficial to the students' performance on the post-test.

Table 3: Post-Test Results

	n	mean	standard deviation	p-value
Control	31	16.968	8.631	0.0061**
Experimental	17	24.352	8.306	

**Statistically significant at the $p=0.01$ level

A close look at the results in Table 3 reveals a large standard deviation for the scores of both groups. Two histograms illustrating the scores achieved by each group can be viewed in Figure 1. Though both histograms can be considered bimodal, a simple observation of the distribution of scores indicates that most of the experimental-group students achieved either between the ranges of 15-20, or 25-30, with the largest number of students achieving scores from 25-30. The same range, 25-30, was only achieved by two of the control-group students as most of them fell in the range of 15-25 or 5-9. Also, two students from the experimental group scored in the highest possible range on the test (35-40), a range none of the control-group students achieved. Only one student from the experimental group performed below a 15 on the post test compared with 14 students from the control group. This analysis supports the claim that the experimental group

obtained a better understanding of the mathematical relationships, and overall achieved higher scores on the post-test.

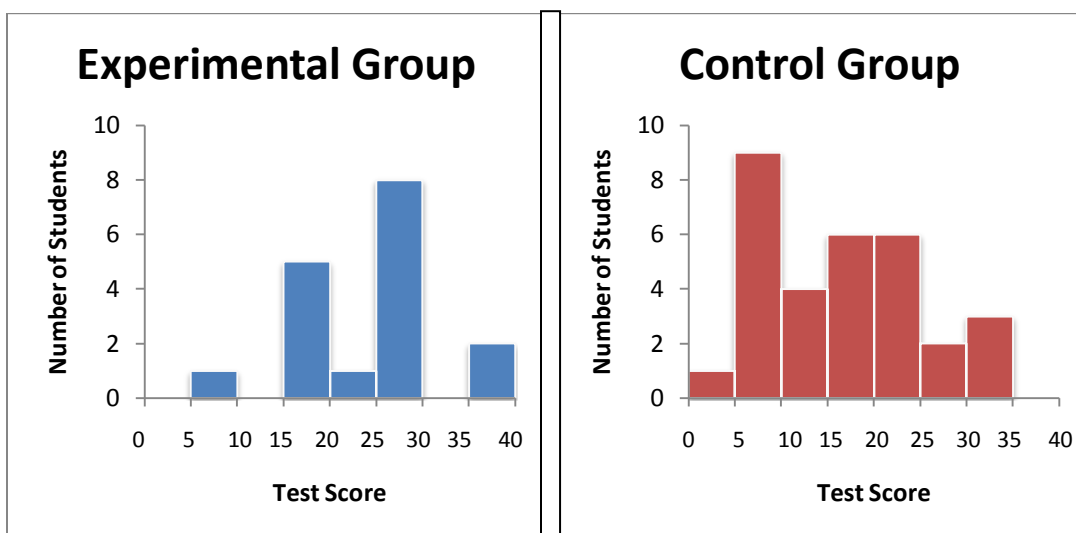

Figure 1: Distribution of Scores for Post-Test

Again, to further analyze the differences in the scores between the groups, a complete item analysis for the post-test was conducted. The results of this item analysis can be found in Appendix E; the post-test can be found in the Appendix B.

The item analysis reveals that the experimental group performed statistically significantly better at the $p=0.01$ level on item 1c and item 1f. These problems can be viewed in Figure 2.

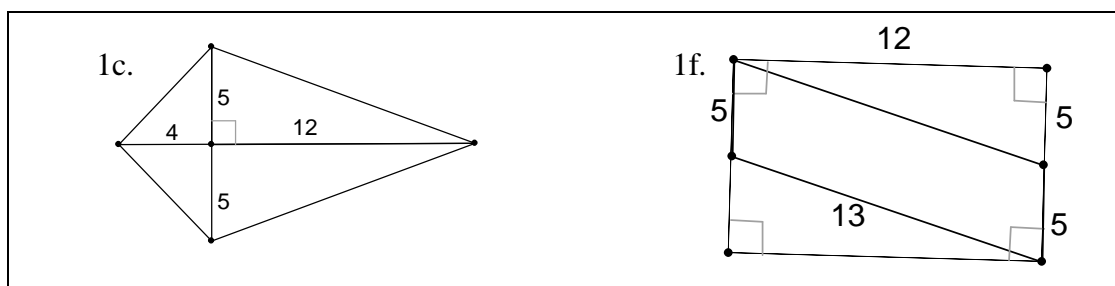

Figure 2: Post-Test Items $p=0.01$

Item 1c involves finding the area of a kite. Most students in the experimental group attacked this problem by dividing the kite into triangles and finding the area of all involved triangles. Though some of the students in the control group used this method, most relied heavily on the formula for the area of a kite ($\frac{1}{2}d_1d_2$).

Item 1f involves identifying the parallelogram and finding the parts necessary for area. All important elements are given, but students must demonstrate a strong understanding of area by reasoning how the area of the parallelogram can be found. Control-group students more so than experimental-group students had a strong tendency to multiply 10×12 or 5×13 . Since the experimental students did significantly better on this problem, it leads to the conclusion that inquiry based instruction leads to better visual understanding of area and an ability to break down shapes.

The experimental group did statistically significantly better at the $p=0.05$ level on items 1a, 1e, 1g, and 2a. These problems can be viewed in Figure 3.

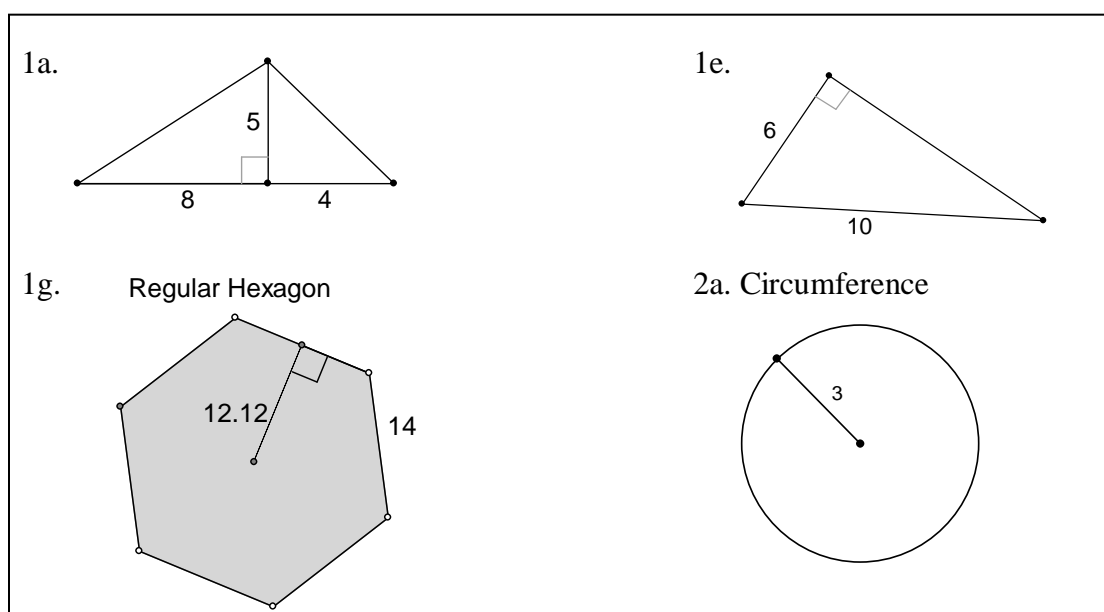

Figure 3: Post-Test Items $p=0.05$

Though item 1a is a straightforward triangle area problem, item 1e requires a small amount of analysis followed by the use of the Pythagorean Theorem. This then becomes a multi-step problem. Many students, more in the control group than in the experimental group, used the triangle formula improperly by multiplying $\frac{1}{2} \cdot 10 \cdot 6$. Students in the experimental group outperformed their peers, suggesting that even though they were never given the formula directly, they had a better understanding of the parts necessary for finding the area of a triangle.

Item 1g proved fairly straightforward for the experimental students, as most of them broke the hexagon into six triangles and found the area using this strategy. Control group students were handicapped by their dependence on the formula $Area = \frac{1}{2} aP$. Finally, the difference in score on item 2a is not surprising given that the experimental students outperformed the control group students in a statistically meaningful way on the circumference problem on the pre-test.

The experimental group outperformed the control group at a nearly statistically significant level ($p=0.1$) on items 1b, 1i, 1j, and 3c. These problems can be viewed in Figure 4.

Though problem 1b should be fairly straightforward for students utilizing the formula for the area of a trapezoid, many-control group students under-performed on this problem. Experimental-group students had a tendency to break the trapezoid into a rectangle and a triangle to find the area. This requires a better understanding of area and the nature of space. Item 1i can be considered a strong indicator of problem-solving ability and visual recognition. Few students were able to grasp that it was necessary to break the given triangle into two triangles to find the area. The fact that the

experimental-group students performed better on this problem further promotes the idea that the experimental-group students had developed better problem solving abilities and a more dynamic understanding of the concept of area.

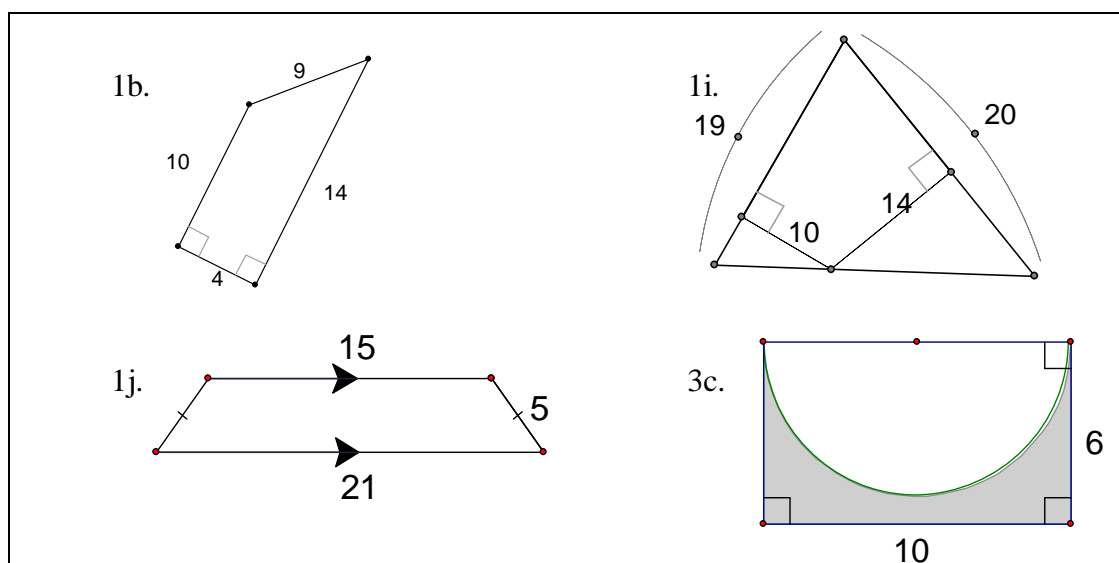

Figure 4: Post-Test Items $p = 0.1$

Item 1j is another example that would require analysis of the given shape in order to find the height of the trapezoid. Again experimental-group students demonstrated better problem-solving ability by analyzing what was given, and deciding not only what was needed, but how to find what was needed in order to calculate the area of a difficult problem. Finally, item 3c further supports this claim by again indicating that the experimental-group students were more capable of solving multi-step problems, which required analysis and understanding of the concept of area.

It is also worth noting that the only two problems on which the experimental group underperformed the control group were item 1h and item 7. These items can be viewed in Figure 5.

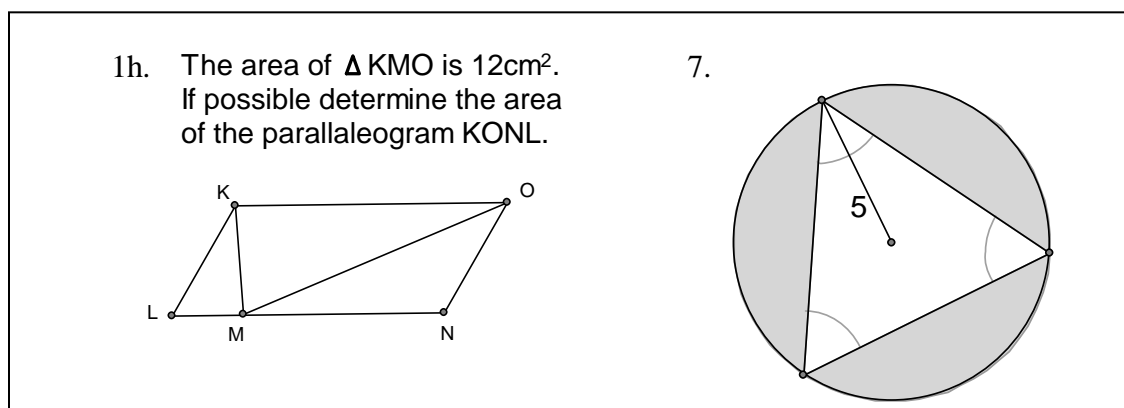

Figure 5: Items on which Control Group Outperformed Experimental Group

Notably item 1h is a problem that draws reference to the relationship between a parallelogram and a triangle and the understanding that the area of the triangle is half of the parallelogram with the same base and height. The fact that the experimental group did worse on this problem may indicate that they did not grasp the relationship through the tasks that were given to them. Item 7 is a multi-step problem involving a regular triangle cut out of the area of a circle. Item 7 was given as a bonus problem for all students and as a result not all students attempted this problem. Performance on the problem may be an indication that the control group was slightly better attuned to the area of a regular triangle, or it may indicate that the experimental group felt less desire to complete an extra-credit portion of the test.

Questionnaire

At the end of the area unit, a questionnaire was distributed to all students involved in the study. The questionnaire consisted of eight Likert scale questions that allowed ranking from 1-5, with one being the lowest and five being the highest. The second half

of the questionnaire included six open-ended questions. Responses to these questions were synthesized to identify common themes. This questionnaire is included in Appendix C and the results of questions 1 – 8 of the questionnaire are tabulated in Table 4.

Table 4: Questionnaire Results

Questions	Control Group n = 31		Experimental Group n = 22		p-value
	mean	standard deviation	mean	standard deviation	
1. How well did you like this chapter compared to other chapters we have covered?	1.968	0.983	3.773	0.922	0.000**
2. How well do you feel you understand how to find area of shapes?	2.742	0.930	3.182	1.053	0.114
3. How confident do you feel that if you had to find area to complete a project you would be able to do it?	2.645	1.050	3.364	1.049	0.018*
4. How much do you feel you learned this chapter?	2.807	0.910	3.409	1.008	0.027*
5. How prepared did you feel before this chapter started to apply what you knew about area to real world applications?	1.968	0.752	2.333	0.913	0.121
6. How prepared do you think you are now to apply what you know about area to real world applications?	2.645	0.950	3.500	0.802	0.001**
7. How did your performance in this chapter (homework and tests) compare with your performance on previous chapters?	2.194	1.167	3.000	1.113	0.015*
8. Did you feel that the approach we took to learning area was beneficial to your understanding?	2.807	1.195	3.682	1.129	0.010**

* Statistically significant at the $p=0.05$ level

**Statistically significant at the $p=0.01$ level

Results of the questionnaire indicate that students in the experimental group felt that they learned more than their control group counterparts and felt more prepared to use what they learned outside of the classroom. The experimental group indicated that they had a slightly higher confidence level for applying area before the study began, but felt even stronger after the study. In fact, the experimental students' indication that they were more prepared to apply what they learned during the unit on area outside of the classroom can be attributed to the difference in approaches at the $p=0.01$ level, giving a strong indication that the students felt more prepared to apply their knowledge when instructed using inquiry-based methods.

The experimental students also indicated that they enjoyed the area unit more than other units that they had covered throughout the year and felt that the approach was beneficial to their understanding. The control students, on the other hand, indicated that they liked the area unit less and were mixed on how beneficial they felt the approach was. As would be expected, the t-test reveals that this can be attributed to the differences in approaches at the $p = 0.01$ level. This should not be surprising considering these are questions directed at how the students felt about the approach itself.

Responses to open-ended questions on the survey further illuminate the responses from the Likert scale questions. Question 9 asked the students, "Why did you feel that the way this chapter was taught was helpful or not helpful?" Multiple control-group students indicated that remembering the formulas was difficult for them. Some of these students did not mind the approach and felt that the presentation was good; they simply could not recall the formulas when they needed to. Other control students indicated that they prefer to learn through different approaches and that the lecture style did not match

with their own learning style. Multiple students also cited the pace of the class as being too rapid, with inadequate time for examples to grasp the concepts. There was a comparable amount of positive and negative responses among the control-group students in response to this question with eleven positive responses, fourteen negative responses, and four responses that could not be classified as either positive or negative.

Experimental-group students overall seemed positive about the approach, citing that they learn better in groups and that they enjoyed seeing different ways to solve the problems. One student commented that he “was able to see different ways to solve problems, helped find the way that (he) learned.” Others commented that the method was fun and that the slower pace helped.

Not all experimental group comments were positive however. Some felt that they should be working individually because everyone has their own pace. Others cited that their group was continually lost so they didn’t feel that they learned very much.

Question 10 asked the students, “What was the most interesting thing you learned during this chapter?” An overwhelming number of control-group students made some reference to the formulas used. Some students did this by stating that a specific formula was the most interesting thing that they learned, such as “The trapezoid formula and the fact that there were two bases,” while other students cited the formulas in general, such as “the formulas for all the shapes to find area.”

The experimental group responses were more varied, with students referencing things that they learned from the style of instruction, such as, “How easy it is to actually learn,” and “Working in groups helps me learn more.” Other students cited that they learned how to find area without formulas, and that “You can break stuff down instead of

just following one approach.” Still others referenced individual connections that they made throughout the unit, such as the connection between circle area and parallelograms or how they can break complicated figures down to find the area.

Question 11 asked the students, “If you were an educator, how would you change the way that lessons are taught?” and question 12 followed up with “Why?” Control-group students varied on their responses to this question, but many students did identify that they would vary their instructional methods, give more time, and give more hands-on work. Much of the justification behind this was that students learn in different ways and need more time to master concepts before moving on.

Experimental-group responses also varied, but many students did seem to like having more hands-on activities and would continue using similar methods. Others suggested small changes to the inquiry-based approach, such as changing groups every day to allow students to gain access to more ideas or giving the formulas first before the explorations. A few of the experimental students did feel that better explanations would have helped them; they did not always feel that what they accomplished in their group was adequate for complete understanding.

Questions 13 and 14 asked students to define area and perimeter, respectively. Both groups seemed to have an adequate grasp of the two concepts. This was evident as most students referred to area as the space inside of an object or figure and the perimeter as the distance or length outside of an object or figure. A few students in both groups were subject to improper language, such as defining area as the distance inside of an object or defining perimeter as the space outside an object. Multiple students in the control group used a definition referring to specific formulas, such as the base times the

height of an object, which may convey a misunderstanding of area formulation. A few experimental students referenced the number of squares inside of an object as area.

Overall, both groups indicated a basic understanding of the two concepts.

Project

At the very end of the area unit and questionnaire, all students were placed in groups and spent two days working on a culminating area project. Every group was given a scale drawing of the floor space of a room within a dome-shaped high school and asked to find the area. Examples of these problems can be found in Appendix D.

The goal of the project was to discern if the experimental students were better prepared for real-world applications of their learning. Small differences in methods did come to light, including a willingness of the experimental group to jump in and attempt to solve the problem, often asking questions like, “does this make sense?” seeking to validate their own ideas. The control group was much more likely to ask the question, “How do I do this?” or “Is this right?” These questions indicated that the experimental-group students had begun to accept that there was a process involved when solving problems and that there are multiple ways of solving a problem, while control-group students remained convinced that there was one right method for solving the problem. Aside from this distinction, however, student-to-student discussions and strategies between the control and experimental groups did not noticeably vary once all students became engaged. The experimental group did not display a better aptitude for solving the difficult problem than did the control group, and many members of both groups made assumptions without weighing their validity. In fact, only one group found the area of

the sector portion of the room in an appropriate fashion. These students were members of the control group.

This leads to the conclusion that two weeks of inquiry-based instruction did increase the students' acceptance of multiple methods for solving problems and their willingness to jump in and attempt working their own ideas. It did not increase their efficiency, or the likelihood that they would correctly navigate the difficulties and misconceptions of a real-world problem involving area.

Retention Quiz

At the end of the semester, four weeks after the culmination of the area project, students were given a retention quiz over the area unit. It is worth noting that between the area unit and the end of the semester two units were covered, one on surface area and one examining volume.

The results of the retention exam can be found in Table 5. It is important to recognize that the experimental group did significantly better at the $p=0.05$ level on the retention exam. This indicates that the inquiry-based treatment of the experimental group did increase retention among the students involved.

Table 5: Retention Quiz Results

	n	mean	standard deviation	p-value
Control	30	3.70	2.087	0.010*
Experimental	18	5.278	1.776	

* Statistically significant at the $p=0.05$ level

Analysis of the retention exam is continued with a complete item analysis, found in Appendix E with the complete retention quiz in Appendix B. Results indicate that the experimental group performed statistically significantly better at the $p=0.01$ level on item 7, which required students to find the area of a sector with a 90° central angle. The experimental students performed better at the $p=0.05$ level on item 1 and item 8. Item 1 required students to use the Pythagorean Theorem to find the length of the missing side of a triangle and use that length to calculate area. Item 8 consisted of two parallelograms that were mirror images of one another. Students could use a variety of approaches to find the combined area of the parallelograms

The experimental students outperformed the control-group students on every item except item 2, which required students to find the area of a triangle with all necessary parts given. The small difference in scores between the control and experimental group on this item can be attributed to most students having the formula for area of a triangle memorized and possessing basic ability to apply the formula when all necessary parts are clearly given.

CHAPTER 5: DISCUSSION

Observations

While the research was being conducted, I kept a daily journal to track how the lesson went and if the students experienced any great revelations as a result of the instruction. Throughout the two-week period, many interesting factors came to light.

It is important within a classroom that students remain on task in order to learn. Though the experimental group of students met every day in groups, this did not seem to detract from time on task. One might expect students to be off task when placed in groups and given more freedom within a classroom, but this was not the case. The continual movement from task to task and encouragement to discuss the mathematics at hand kept students interested, and groups continued to work through the problems. The freedom of exploration seemed to spur groups on in their discussions and explorations. This is not to imply that groups did not get off task or that I did not take an active role in reminding students what they should be discussing. However, on-task time for the experimental students surpassed that of the control-group students.

Students did seem motivated by having a problem to solve and discuss. This meant something different in the context of the group work than it did in the traditional homework problems presented to the control groups. Students were engaged and curious as to where they were going during the inquiry lessons in a way that control-group students were not. Control students did appear to listen to the lectures and answer questions, but a far smaller number of students were able to be involved and too many

students left the class without becoming involved in the lecture. This leads to concern regarding what they actually understood.

Not all experimental students were involved however. Throughout the unit there was one particular student that refused to take part in the discussion and would become obstinate when approached. The student did not attempt to complete group assignments and disengaged herself from other group members. Working with the student was frustrating and unrewarding. Throughout the unit, I was unable to reach this student and as a result the student's learning was minimal.

Other students engaged in similar behavior at times, waiting for one member of the group to lead the rest to the discovery. Complete group involvement was hard to come by in this regard. Many groups learned to rely on one strong member for their progress through assigned tasks.

Although control group lessons did present why specific formulas are used, this information was not deemed important by many students, and their subsequent student-to-student discussions often revolved around what the formula was and what should be plugged in where. For the experimental group, questions more often revolved around how and why a certain method worked. Since students were not given explicit formulas, they were not inclined to ask about them; instead the individual students attempted to understand a method. This method seeking required more thought, more conversation, and a higher level of understanding. Students were not always ready to answer such questions regarding their methods, and even for the experimental group it often became explanations about multiplying this by that without justification. Constant monitoring did catch many of these instances and I questioned these students until they could defend

their method. In one such instance, the student became openly irritated by the constant questioning, but when she eventually conveyed her understanding in a meaningful way, she seemed to be proud of the argument that she had constructed. Since students were often required to present their findings and defend the methods of their group, students slowly adapted to asking the questions to discover why a specific approach did or didn't work.

The idea of proof is central to the goal of inquiry-based learning. Although students did get closer to proof by discussion, they never fully engaged in one another's ideas. This could be the result of instructional shortcomings, or a reflection of the short amount of time students were given to adapt to the inquiry-learning style. Even when two students had different yet valid ideas, the students' arguments failed to be proof oriented as students reacted to frustration in their attempts to defend their ideas. Group dynamics played a large role as some students were not interested in others' ideas, especially if they felt they had the correct answer already. This kept students from engaging in discussion about the validity of a response simply due to the fact that their process was not the same.

Two lessons especially illuminated what effective inquiry instruction looks like. The first was the lesson on area and perimeter of similar figures. When given the group worksheet, students did not begin by discussing, but by trying to fill in answers. Small, quickly discerned items did not seem to spur the students to communicate. Also, in this lesson, students' mistakes and improper assumptions led to an inability to draw the conclusion that the ratio of the areas is the ratio of the scale factor squared in similar figures. Students did not come up with this in their groups and I played a large part in

clearing up their lack of understanding. As a result, the experimental-group students never seemed to fully grasp the connection. Scaffolding and the ability of the student to draw and defend their own valid conclusions is central to inquiry-based lessons. If the lesson fails to allow students to do this, then it is unlikely that they would be able to progress mathematically.

The second illuminating lesson involved finding the area of regular polygons. Students have always seemed to struggle with this complex area formula. However, the experimental-group students jumped in. By the end of the two-day lesson, every group was able to find the area of a regular polygon given a side length and defend the method they used for finding that area. The connections students had drawn differed from those traditionally drawn during lessons on regular polygons, and as a result the experimental students displayed a much better understanding of how to find areas of those figures than the control-group students did, even though the control-group students had a simple and concise formula for that area. This lesson illustrated the importance of the connections the students had drawn. Since the students made their own conclusions, and had their own arguments, their method was remembered. This is further backed by the results of the retention quiz.

Students also had a tendency to remember what they had come up with on their own. Due to the approach we took to learning area of a circle involving a formula derived from parallelograms built from sectors of the circle, one student always calculated area of a circle using the product of half the circumference and radius. Even though this student had been exposed to the more concise πr^2 , they remembered the formula that they had derived through experience.

It is important to admit that misconceptions among the experimental group were common throughout the lessons. Though I attempted to discuss with each group their misconceptions and clarify them, often there was not enough time to clear up all of the misconceptions. As a result, I was concerned throughout the implementation that the students may not have been adequately grasping the material. The results of the study indicate that even though there were many misconceptions along the way, students developed a better understanding of area than their peers who were taught in the traditional fashion. This leads to the conclusion that the control-group students suffered from at least as many misconceptions as the experimental-group students. The difference then lay in the fact that the experimental-group students were constantly discussing their understanding, thus bringing these misconceptions to light. Mathematics instructors may be more likely to engage in correcting these misconceptions because they see them as being developed by the students. This research reflects that even when students are taught explicitly, their understanding is not without its misconceptions. Educators may often overlook these misconceptions because they know that the students have been instructed in how the mathematics should be done. Students will still develop their own understanding based on their interpretations of the information presented; an understanding that is imperfect and subject to the students' misconceptions is often developed.

Conclusion

The likelihood that misconceptions come to light, paired with the idea that students will clarify their own understanding through interaction with the material,

creates a learning environment that is superior, and better enjoyed by the students, than the traditional classroom. Students involved in the inquiry-based lessons exhibited better retention, a better ability to problem solve, and better performance on decontextualized mathematical problems than their peers who were taught in the traditional fashion. They did not, however, display a better ability at proof or greater aptitude in a real-life area problem situation.

These results validate many of the claims of the inquiry-based instructional style. To maintain quality education for our students and to help them build a relational understanding of the mathematics teachers should incorporate inquiry-based instructional methods into their classrooms. Fear of change and concern about high stakes testing should not inhibit change within classrooms as these fears are shown to be baseless by the results of this research. Implementation of inquiry-based instructional methods should be encouraged by administrators and embraced by educators in an effort to continually improve public education in the United States.

Limitations

After the conclusion of the study, it became apparent that more research would lead to a better understanding of the impacts of inquiry-based instruction. Changes to elements of this study would bring about better understanding of the impacts of inquiry-based instruction. It is impossible to predict the full impact of such changes without further research.

One limitation was the timeframe over which the study was implemented. It would be worthwhile to extend this study throughout the course of an entire year,

introducing students to inquiry-based learning at the very beginning and continuing in this format. Such an experiment may lead to greater acceptance of the approach by the students and thus involve a greater number of them in the thinking process. Along the way, students may learn better what mathematical discourse looks like and be better prepared to communicate mathematically. Such an extension of the study would give greater insight into the benefits of inquiry-based instruction in terms of retention, problem-solving ability, development of mathematical discourse, and transferability of learned mathematics.

The retention element of this study was also limited by timeframe. There was only a four-week period between the end of the inquiry-based lessons and the end of the semester. This did not allow for long term testing of retention. A longitudinal test for retention would lead to greater insight into whether the gains due to the inquiry-based methods are lasting and could include extended studies of students' real-world application of the mathematics.

As the sole instructor of the inquiry-based lessons and the designer of the lessons used in this study, the results cannot be disconnected from my classroom or my implementation. Further research should include implementations guided and created by others to determine the true benefits of inquiry learning and elements of successful inquiry lessons.

WORKS CITED

- Barell, J. (2007). *Problem based learning and inquiry approach*. New Delhi: Sage Publications India Pvt. Ltd.
- Boaler, J. (1998). Open and closed mathematics: student experiences and understanding. *Journal for Research in Mathematics Education*, 29 (1), 41-62.
- Boaler, J. (2000). Exploring Situated Insights Into Research and Learning. *Journal for Research in Mathematics Education*, 31 (1), 113-119.
- Cavanagh, S. (2006). Big cities credit conceptual math for higher scores. *Education Week*, 25 (18), 1-15.
- Goos, M. (2004). Learning mathematics in a classroom community of inquiry. *Journal for Research in Mathematics Education*, 35 (4), 258-291.
- Hmelo-Silver, C. E., Duncan, R. G., & Chinn, C. A. (2007). Scaffolding and achievement in problem-based and inquiry learning: a response to Kirschner, Sweller, and Clark(2006). *Educational Psychologist*, 42 (2), 99-107.
- Hodge, L. (2008). Student roles and mathematical competence in two contrasting elementary classes. *Mathematics Education Research Journal*, 20 (1), 32-50.
- Ismail, J. (2008). The effects of a reform curriculum on students' problem solving abilities. (Unpublished master's thesis). Boise State University, Boise, ID.
- Kirschner, P. A., Sweller, J., & Clark, R. E. (2006). Why minimal guidance during instruction does not work: an analysis of the failure of constructivist, discovery, problem based, experiential, and inquiry based teaching. *Educational Psychologist*, 41 (2), 75-86.
- Lampert, M. (1990). When the problem is not the question and the solution is not the answer: mathematical knowing and teaching. *American Educational Research Journal*, 27 (1), 29-63.

- Levasseur, K., & Cuoco, A. (2003). Mathematical habits of mind. In H. L. Schoen, *Teaching mathematics through problem solving* (pp. 27-37). Reston: The National Council of Teachers of Mathematics Inc.
- Marcus, R., & Fey, J. T. (2003). Selecting quality tasks for problem-based teaching. In H. L. Schoen, *Teaching mathematics through problem solving* (pp. 55-67). Reston: The National Council of Teachers of Mathematics, Inc.
- McKinney, S., & Frazier, W. (2008). Embracing the principles and standards for school mathematics: an inquiry into the pedagogical and instructional practices of mathematics teachers in high-poverty middle schools. *Clearing House*, 201-209.
- National Research Council. (1996). *National science education standards*. Washington DC: National Academy Press.
- NCTM. (2009, June). *Guiding principles for mathematics curriculum and assessment*. Retrieved 10 14, 2009, from National Council for Teachers of Mathematics: <http://www.nctm.org/standards/content.aspx?id=23273>
- Pesek, D. D., & Kirshner, D. (2000). Interference of instrumental instruction in subsequent relational learning. *Journal for Research in Mathematics Education*, 31 (5), 524-540.
- Saunders, W. L. (1992). The constructivist perspective: implications and teaching strategies for science. *School Science and Mathematics*, 92 (3), 136-141.
- Schoenfeld, A. H. (2007). Problem solving in the United States, 1970-2008: research and theory, practice and politics. *ZDM Mathematics Education* (39), 537-551.
- Skemp, R. R. (1976). Relational understanding and instrumental understanding. *Mathematics Teaching*, 77, 20-26.
- Stonewater, J. K. (2005). Inquiry teaching and learning: the best math class study. *School Science and Mathematics*, 105 (1), 36-48.
- Vincent, J., & Stacey, K. (2008). Do mathematics textbooks cultivate shallow teaching? Applying the TIMSS video study criteria to Australian eight-grade mathematics textbooks. *Mathematics Education Research Journal*, 20 (1), 81-106.

APPENDIX A

Inquiry-Based Lessons

Lesson 1 Parallelograms

Objectives:

1. SWBAT find the area of rectangles, squares, and parallelograms using grid paper drawings.
2. SWBAT develop a method for finding the area of parallelograms.
3. SWBAT use developed formula to find area of parallelograms.

Procedures:

1. Present students with building problem which requires finding the area of parallelograms.
2. Distribute grid paper containing rectangles, squares, and parallelograms. Ask students to find the area of all the figures on the paper in their groups.
3. Once students have found the area of all the figures, ask them to formalize how they are finding the area of figures of different types and compare their answers and method with one other group.
4. Groups should then flip over the distributed grid paper drawings, and find parallelograms with lengths provided on the reverse side. Students should begin finding the area of these figures.
5. Give students the opportunity to discuss their methods for finding the area of the parallelograms in front of the class. If time permits allow students to discuss their methods, and demonstrate how they work.
6. Distribute a short problem set for students to take home and practice finding area of parallelograms, rectangles, and squares.

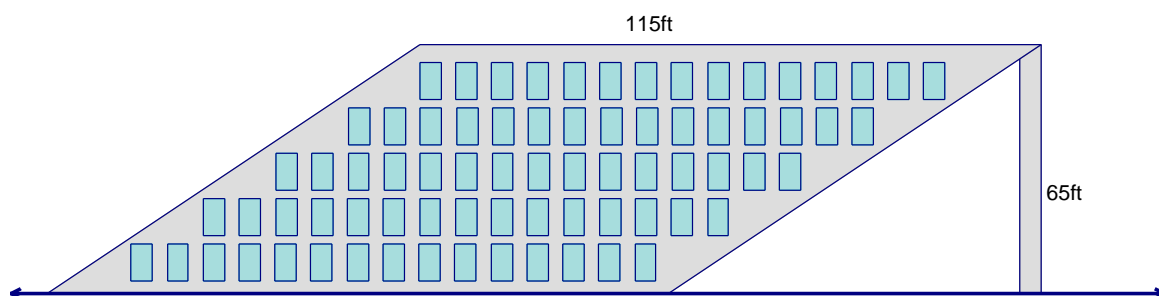

The Slant company has hired a local architect to design a building that is slanted to one side. Above you can see a sketch of his plan. The builder needs to know the area of one side of the building to begin putting together a list of necessary materials. What is the area of this slanted face of the building?

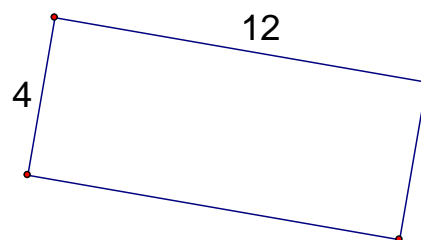
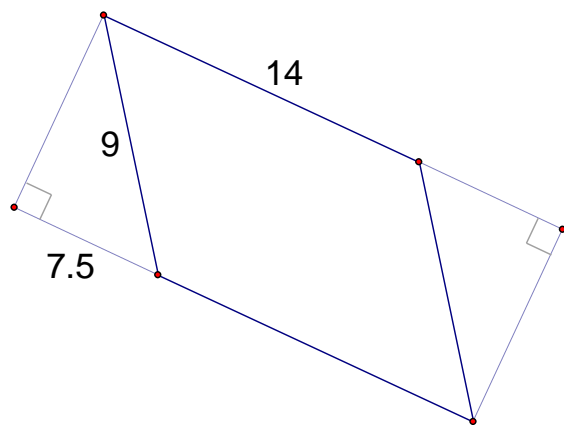
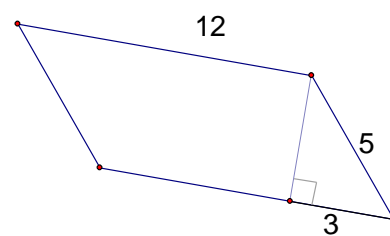
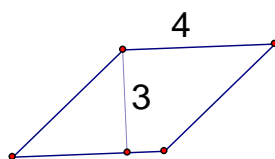
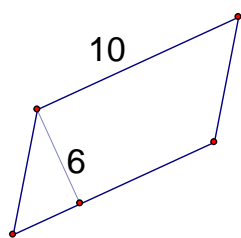
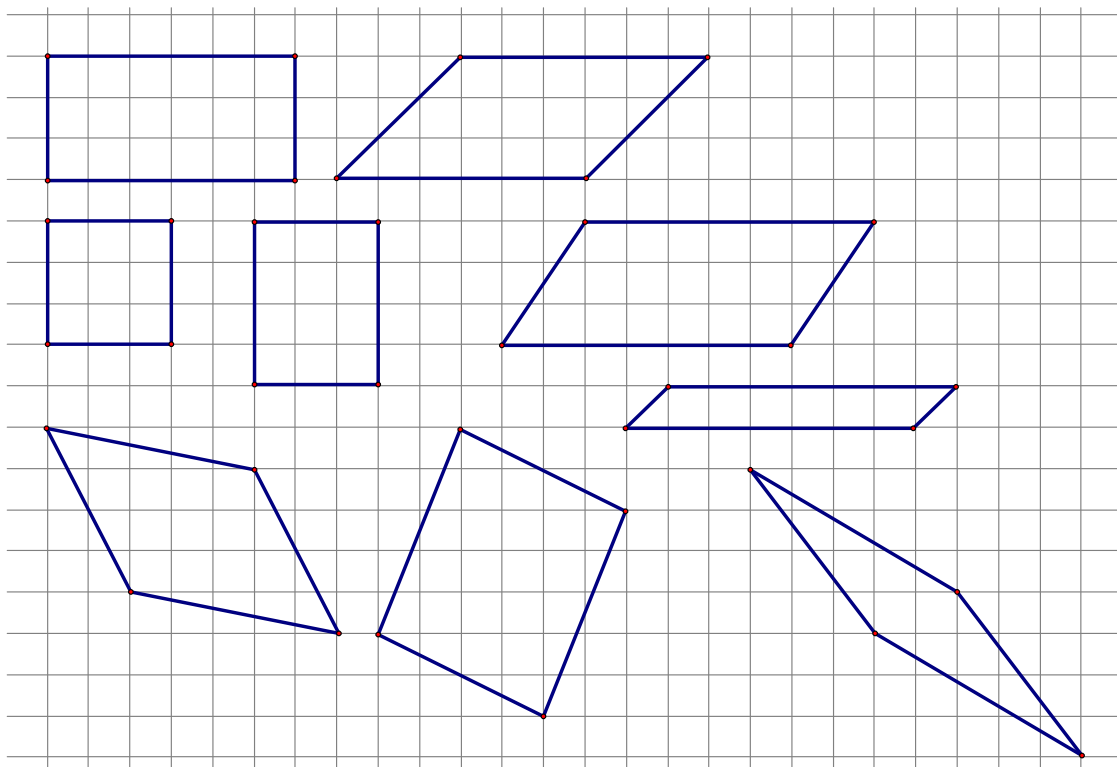

Area of Parallelograms Homework

Name _____

Find the area of each parallelogram.

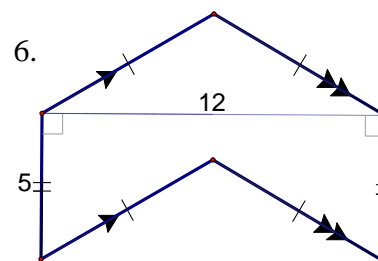
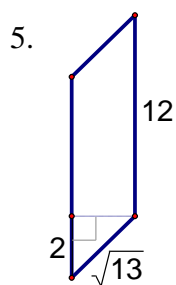
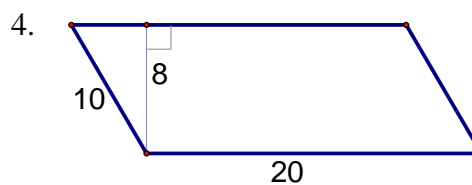
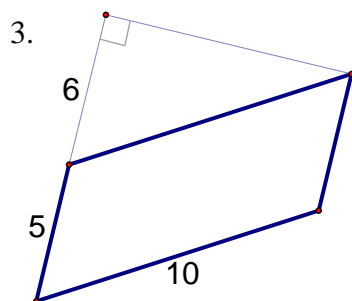
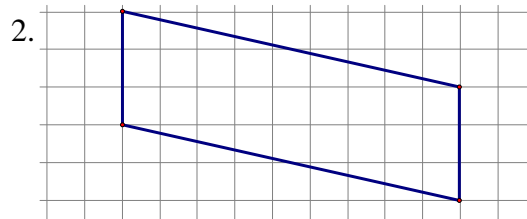
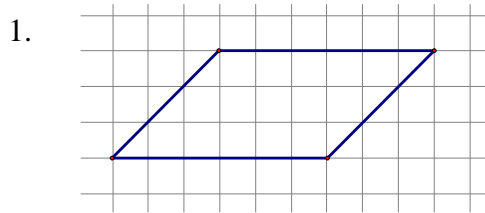

Lesson 2 Triangles

Objectives:

1. SWBAT find the area of triangles with and without right angles using grid paper, and matching triangle cut outs.
2. SWBAT Develop a method for finding area of a triangle.
3. SWBAT use their developed method to find the area of triangles not on grid paper, including triangles with missing base or height that can be calculated using Pythagorean Theorem, or right triangle trigonometry.
4. SWBAT break complex shapes into recognizable forms to find their area.

Procedures:

1. Distribute grid paper with constructed triangles to every student, also distribute cut out copies of the same triangles to each group. Ask the students to find the area of each triangle in the set.
2. Once students complete gridded triangles, ask them to flip the paper over and continue by finding the area of triangles with base and height given, but no grid to guide them. Some of these triangles will require the use of Pythagorean theorem and right triangle trigonometry.
3. Have groups discuss their method for finding area, and define in their groups why the formula $\frac{1}{2}b \cdot h$ works for finding the area of a triangle. Each group will be responsible for writing down, and turning in a short justification for why this formula works before leaving the classroom.
4. If time permits have students rotate groups, and verify their justification for why the formula $\frac{1}{2}b \cdot h$ works with members of a different group.
5. Distribute take home assignment as students leave the classroom.

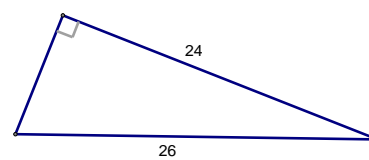
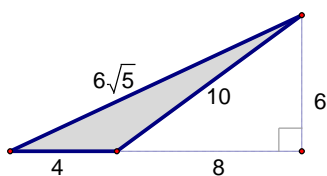
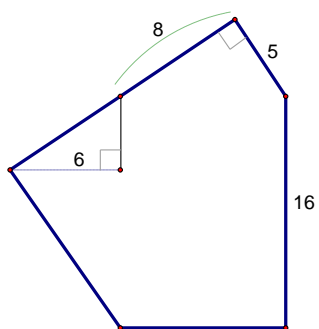
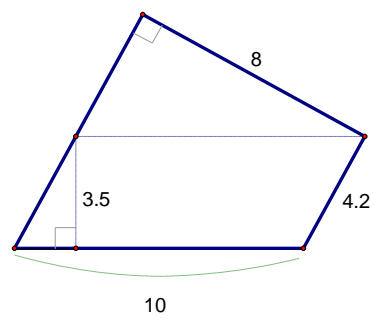
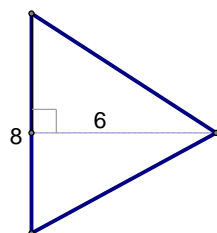
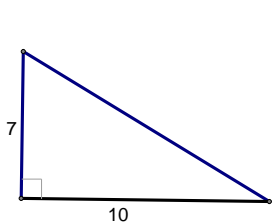
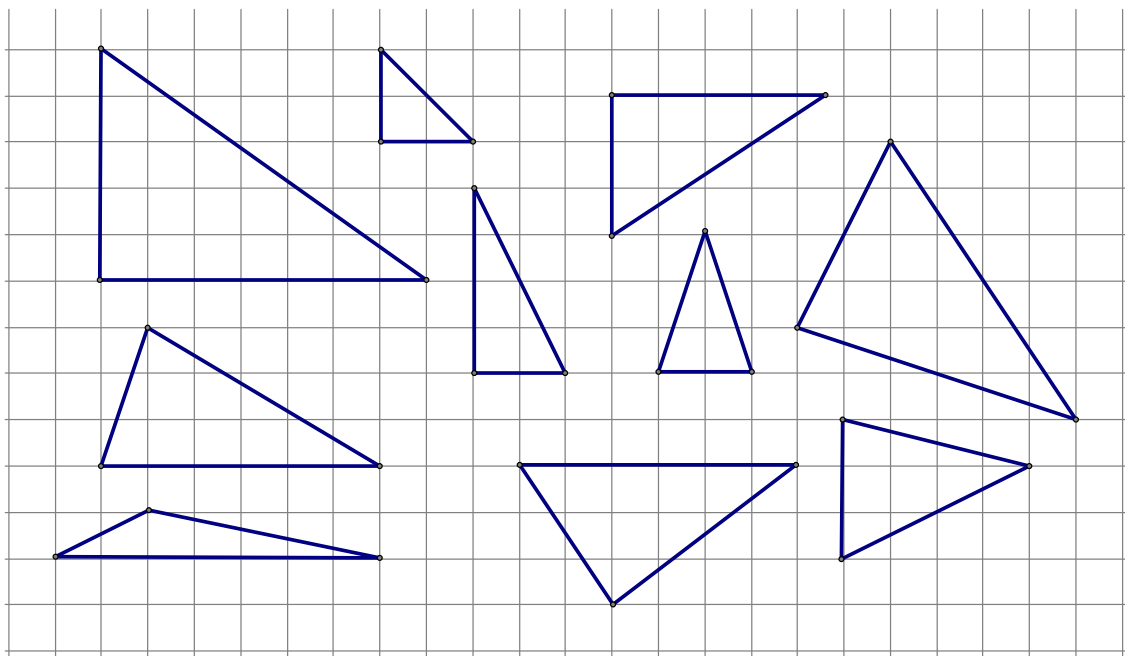

Area of a Triangle Homework

Name _____

Find the area of each figure

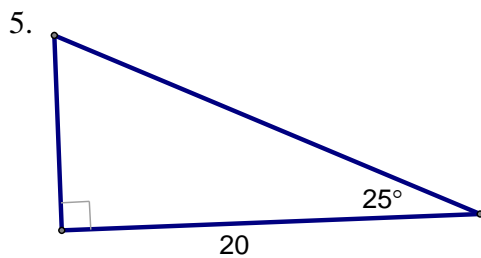
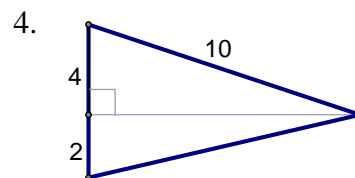
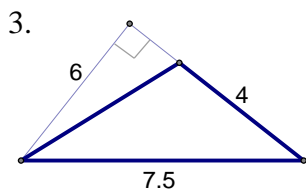
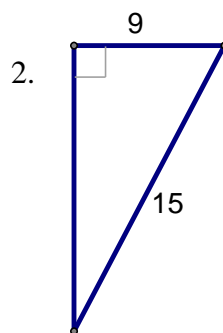
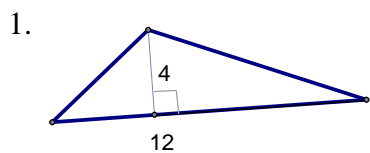

Lesson 3 Trapezoids

Objectives:

1. SWBAT find the area of trapezoids using grid paper.
2. SWBAT develop a method for finding the area of any trapezoid.
3. SWBAT find the area of any trapezoid using given parts.
4. SWBAT explain their method for finding the area of trapezoids to their peers.

Procedures:

Day 1:

1. Present students with the floor plan of a room that has a bay window and ask how many 3ft x 3ft tiles it would take to tile the floor.
2. Hand out, one to each student, grid paper constructions of trapezoids, and instruct them to find the area of these figures in their groups. To help complete this task, also distribute packets of the same trapezoids cut out so that students can put them together in different ways.
3. Once students have discovered the area of each gridded trapezoid, instruct them to turn over the grid paper, and find the area of the non-gridded trapezoids on the reverse side using what they discovered while working with the grid paper.

Day 2:

4. Give each group two identical large trapezoid with measurements written on them. These trapezoids need to be large enough to allow students to see them from across the room if necessary. Many of the handed out trapezoids should require the use of Pythagorean Theorem to find the height.. Instruct the students to find the area of their groups trapezoid, and to be prepared to explain how they found that area.
5. If students complete this task, they should continue working on the gridded, and non-gridded trapezoids from the previous day.
6. Have students present the area they found for the large trapezoid, and justify their method for finding the area of the trapezoid.
7. Distribute short problem set involving finding area of trapezoids to be completed by the next class period.

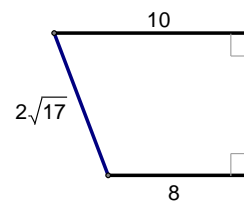
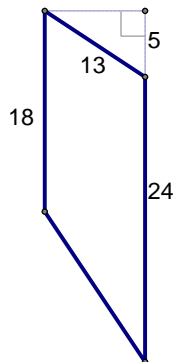
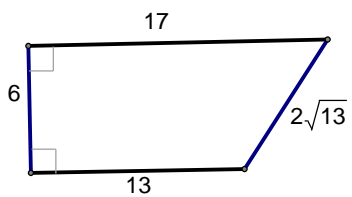
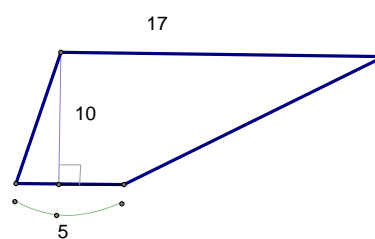
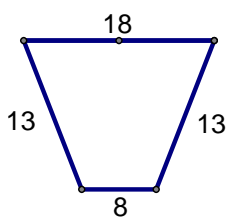
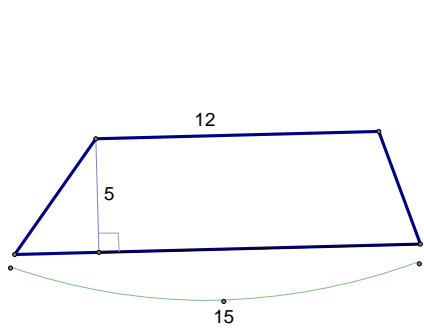
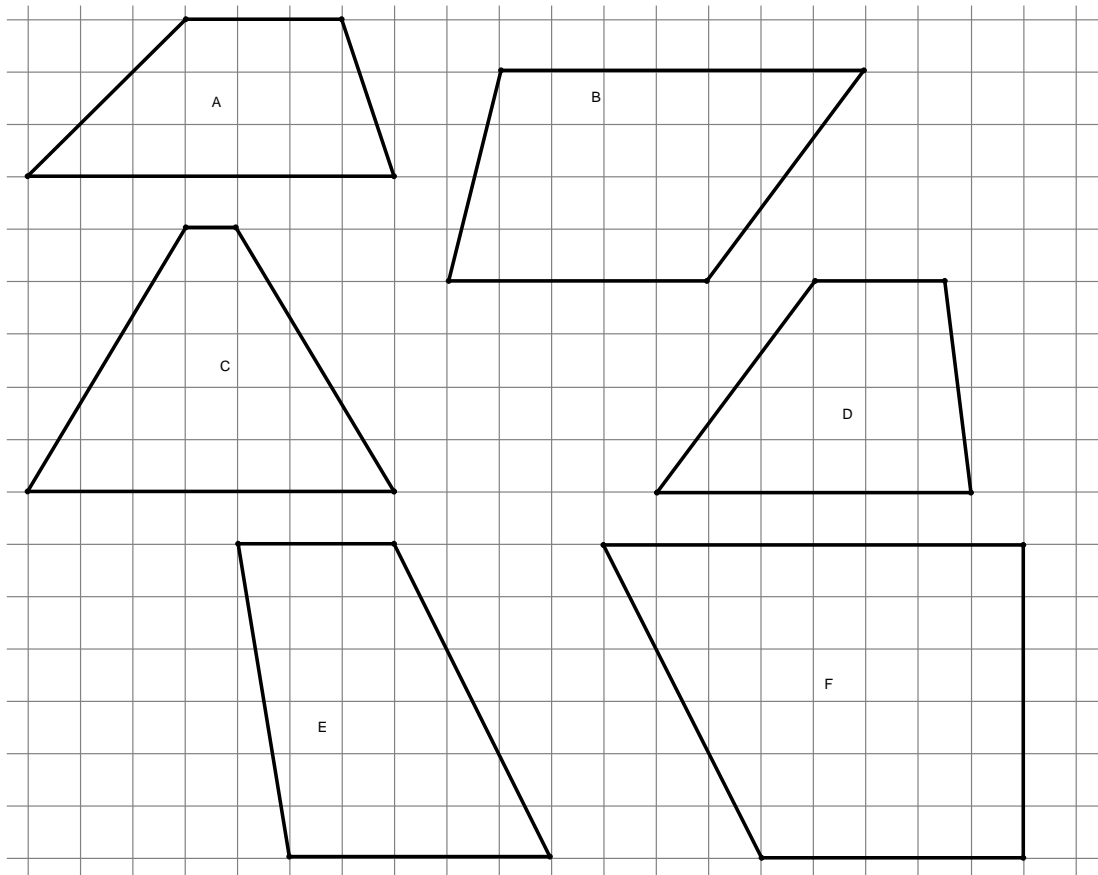

Area of a Trapezoid Homework

Name _____

Find the area of each figure

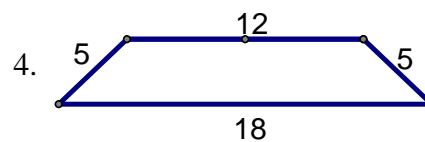
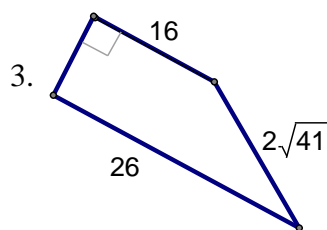
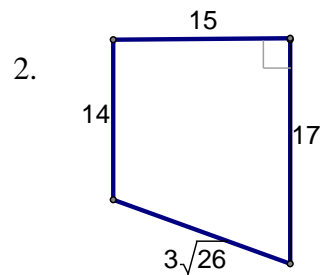
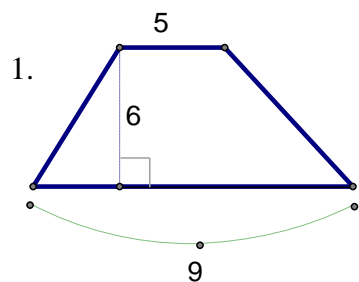

5. Find the area of the shaded region if the area of the trapezoid is $75u^2$:

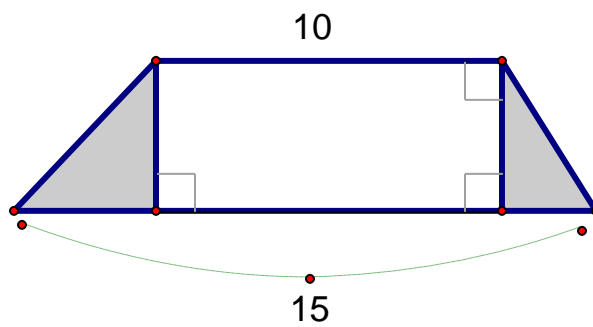

Lesson 4 Kites and Rhombuses

Objectives:

1. SWBAT find the area of kites and rhombuses on grid paper.
2. SWBAT break kites and rhombuses into triangles which will allow them to find area of figures off of grid paper.
3. SWBAT use their developed method to find the area of any kite or rhombus.
4. SWBAT defend their method for finding the area of kites and rhombuses.

Procedures:

1. Hand out figures not on grid paper, and ask students to find the area of all the figures using known formulas.
2. Once students complete the above task, they should move on to gridded kites and rhombuses. Instruct students to not only find the area using the methods that they used for the non-gridded figures, but to verify their solution by counting the square units in each figure.
3. Randomly select one representative from each group and ask them to explain to the class how their method for finding area. Entire class should be engaged in debating whether presented methods are valid or flawed.
4. Hand out to groups a second set of problems which require the use of the Pythagorean Theorem and have them find the area of these figures.
5. Distribute homework assignment as the students leave.

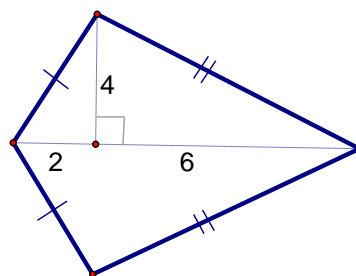
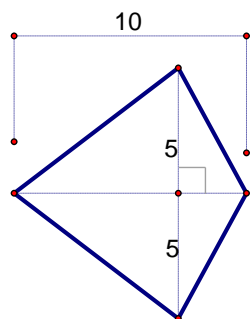
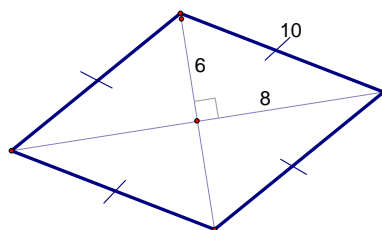
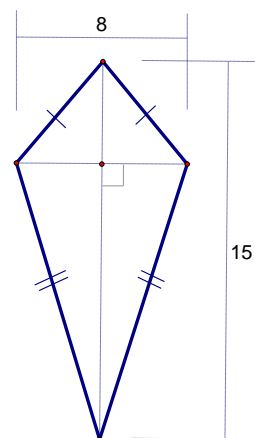
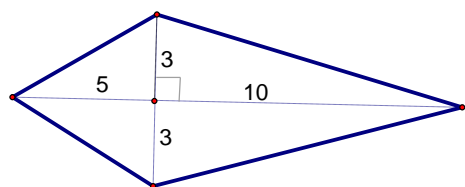
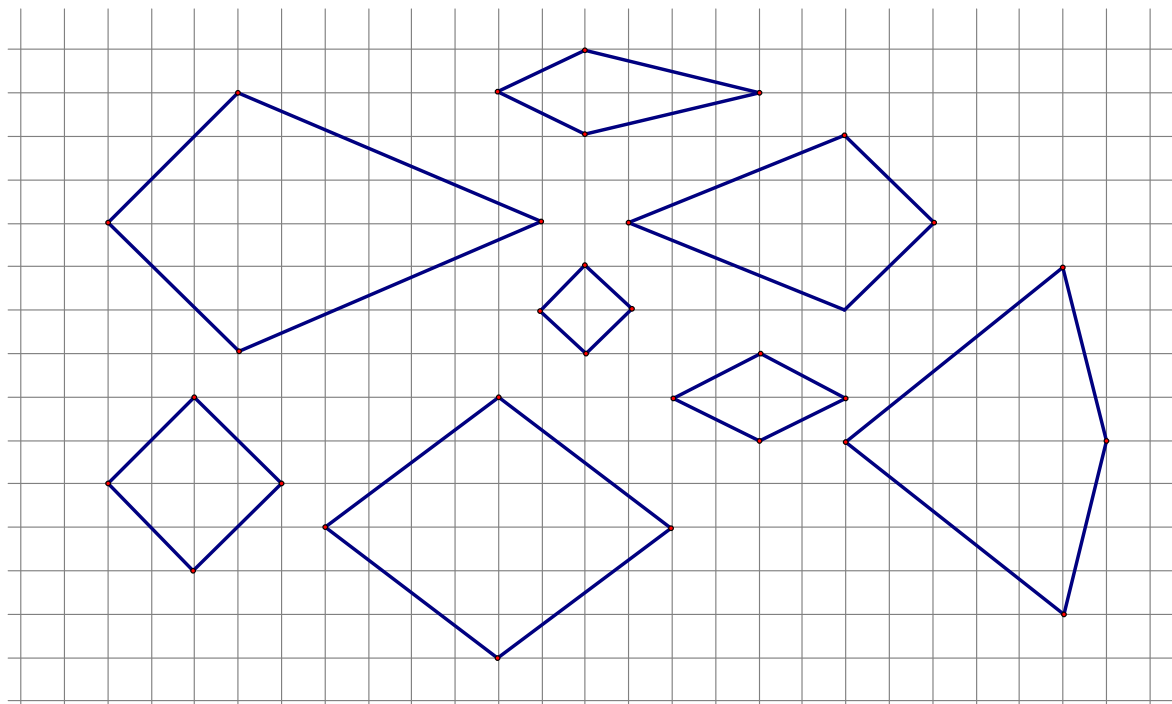

Set 2

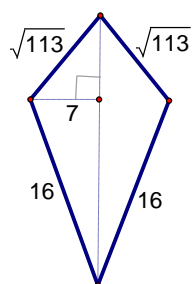
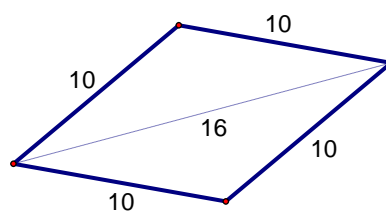
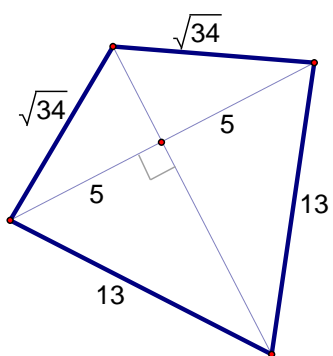

Kite and Rhombus Homework

Name _____

Find the area of each figure.

1.

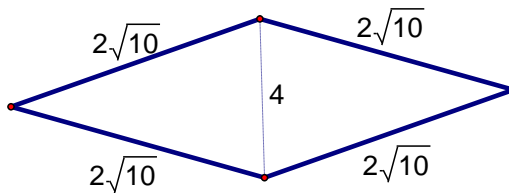

2.

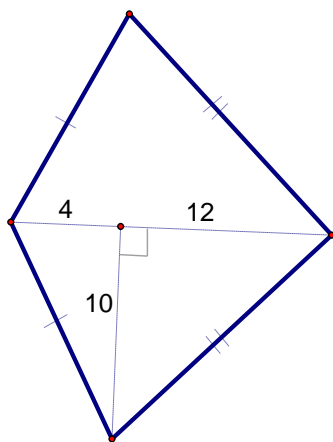

3.

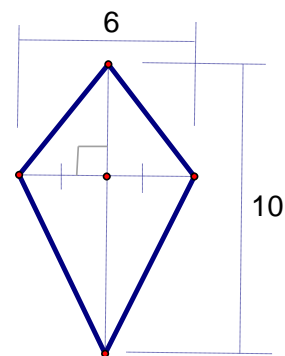

Lesson 5 Area and Perimeter of Similar Figures

Objectives:

1. SWBAT identify the ratio of side lengths of figures, as well as the ratio of perimeters. Students will understand that these ratios are the same.
2. SWBAT identify the ratios of areas of figures, and identify the relationship between ratios of areas and ratios of sides.
3. SWBAT use the relationships that exist between similar figures to solve problems.

Procedures:

1. Hand out group worksheet (one per group) and have students fill in the blanks and answer all questions.
2. Give a short review lesson on solving and setting up proportions involving similar figures.
3. Distribute one set of problems to each student; allow groups to work through these problems using what they have discovered about similar figures.
4. Have each group record the answer that they got to each of the 4 problems on the board.(ongoing)
5. If time permits ask groups to defend their responses to the problems. If differences exist among groups, utilize the difference as a catalyst to discussion.
6. Distribute short problem sets for students to complete for the following day involving similar figures.

Group Work

Verify every set of figures is similar, identify the scale factor (A to B), find the perimeter of each figure, the area of each figure, the ratio of the perimeters (A to B), and the ratio of the areas (A to B).

(Be sure to reduce all ratios to simplest form)

As you find all ratios, see if you can identify any patterns.

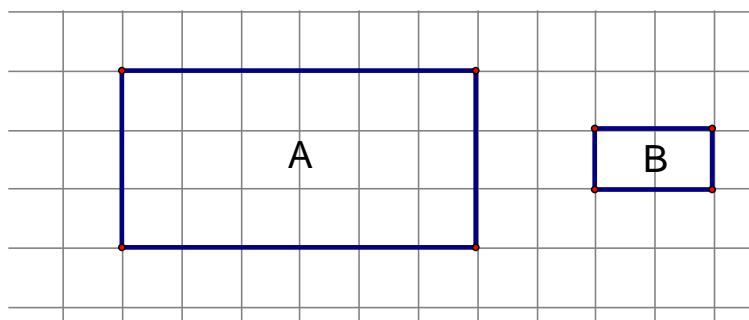

Scale Factor _____

Perimeter of A _____

Perimeter of B _____

Area of A _____

Area of B _____

Ratio of perimeters _____

Ratio of Areas _____

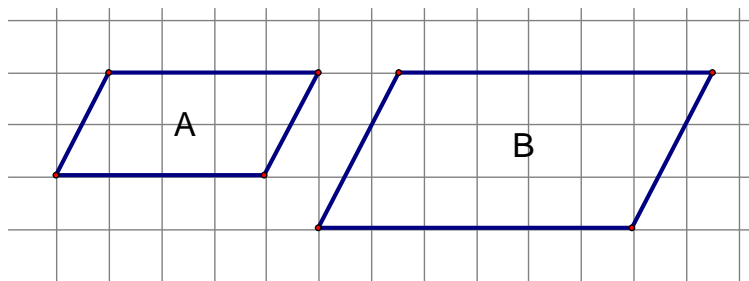

Scale Factor _____

Perimeter of A _____

Perimeter of B _____

Area of A _____

Area of B _____

Ratio of perimeters _____

Ratio of Areas _____

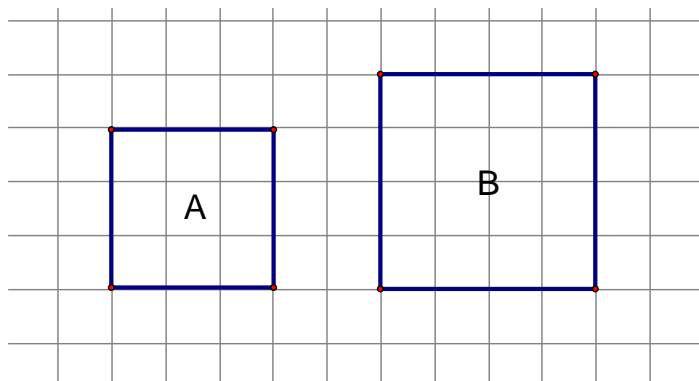

Scale Factor _____

Perimeter of A _____

Perimeter of B _____

Area of A _____

Area of B _____

Ratio of perimeters _____

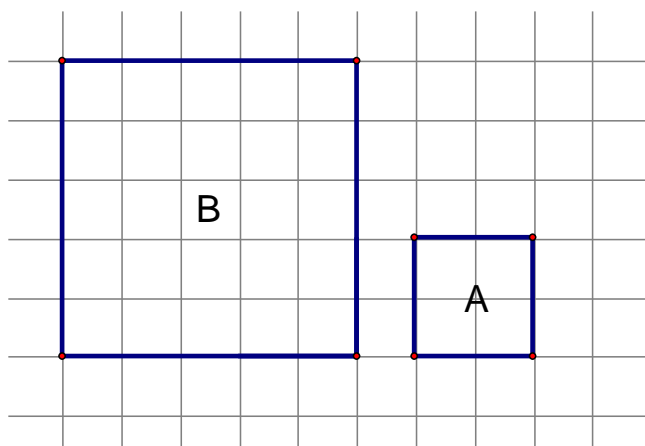

Ratio of Areas _____

Scale Factor _____

Perimeter of A _____

Perimeter of B _____

Area of A _____

Area of B _____

Ratio of perimeters _____

Ratio of Areas _____

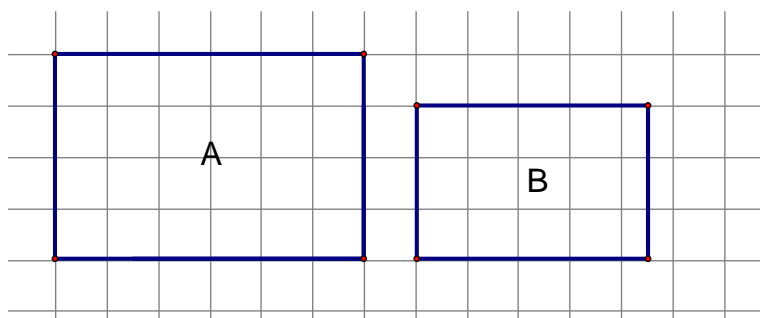

Scale Factor _____

Perimeter of A _____

Perimeter of B _____

Area of A _____

Area of B _____

Ratio of perimeters _____

Ratio of Areas _____

Formalize any patterns that you noticed

a. Between the scale factor and the ratio of perimeters.

b. Between the scale factor and the ratio of the areas.

c. In your groups, discuss why these relationships exist. Formalize why on a separate sheet of paper to be turned in. (one per group)

Find the listed information for each set of figures. For each given pair figure A is similar to figure B.

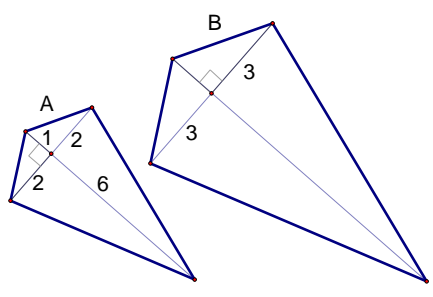

Scale Factor $\frac{A}{B} =$
 Ratio of Areas $\frac{A}{B} =$

Find the area of Figure A, and then find the area of Figure B (remember, they are similar)

- Scale Factor A:B =
- Ratio of Perimeters A:B =
- Ratio of Areas A:B =
- Perimeter of A =
- Area of A =
- Perimeter of B =
- Area of B =

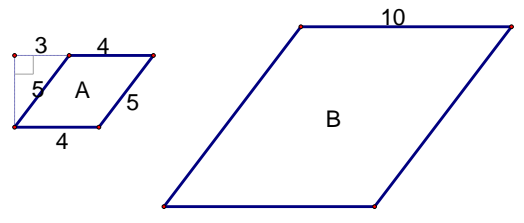

Find the listed information for each set of figures. For each given pair figure A is similar to figure B.

- Perimeter A = 36 u
- Area A = 96 u²
- Perimeter B =
- Area B =

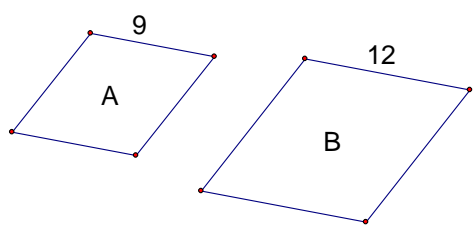

- Area A = 5
- Perimeter A = 8.5
- Area B = 45
- Perimeter B =
- Length of side x =

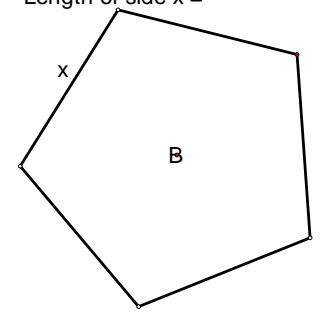
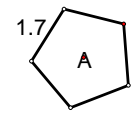

Ratio of Areas $\frac{A}{B} =$
 Ratio of Perimeters $\frac{A}{B} =$

Similar Figures Homework

Name _____

1. You are given two similar rectangles. The scale factor of rectangle A to rectangle B is 5:2.
 - a. If the perimeter of rectangle A is 30 in. What is the perimeter of rectangle B?
 - b. If the area of rectangle A is 100 in^2 what is the area of rectangle B?

2. The figures below are similar.

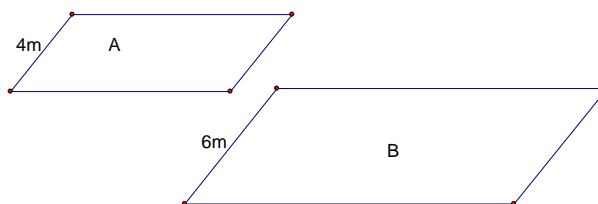

- a. The perimeter of figure A is 12m, what is the perimeter of figure B?
 - b. The area of figure A is 30m^2 , what is the area of figure B?
3. The figures below are similar. The area of figure A is 54 u^2 , while the area of figure B is 6 u^2 .

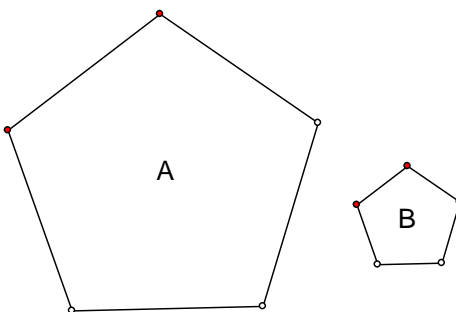

- a. What is the ratio of one side of figure A, to the same side of figure B?
- b. If the perimeter of figure A is 28, what is the perimeter of figure B?

4. Write a brief explanation for why the area of a triangle can be found using the formula $\frac{1}{2}b \cdot h$. Draw pictures if appropriate.

5. Find the area of the trapezoid below.

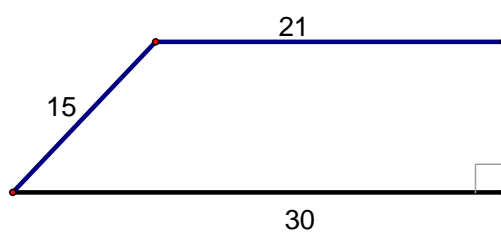

Lesson 6 Circumference and Arc Length

Objectives:

1. SWBAT understand why circumference can be found using the formula πd or $2\pi r$.
2. SWBAT find the circumference of a circle given radius or diameter.
3. SWBAT develop a method for finding arc-length.
4. SWBAT find arc lengths, and perimeters of figures involving arcs.

Procedures:

1. Provide each group of students with a circular object, and a small paper with measurement lines equally spaced and marked. Instruct the students to use the ruler to identify the circumference, and decide how that measurement compares with the length of the diameter.
2. Select a member from each group and ask them to summarize their findings to the rest of the class.
3. Decide as a class the most efficient way to find the area of a circle. (Students should be encouraged to justify why their methods are most efficient.)
4. Distribute problems involving arc lengths to every student, these problems should increase in difficulty as the students progress through them. Instruct the students to discuss how the length of the arc relates to the circumference of the circle. Students should use their understanding of this relationship to formalize how they could find the arc length, and to complete the provided problems.
5. Have one student from each group rotate to a new group and compare their methods and solutions to the arc length problems. These groups should then work together to complete any unfinished problems on the handouts.
6. Students will be given assignments to take home.

Find the circumference of each object:

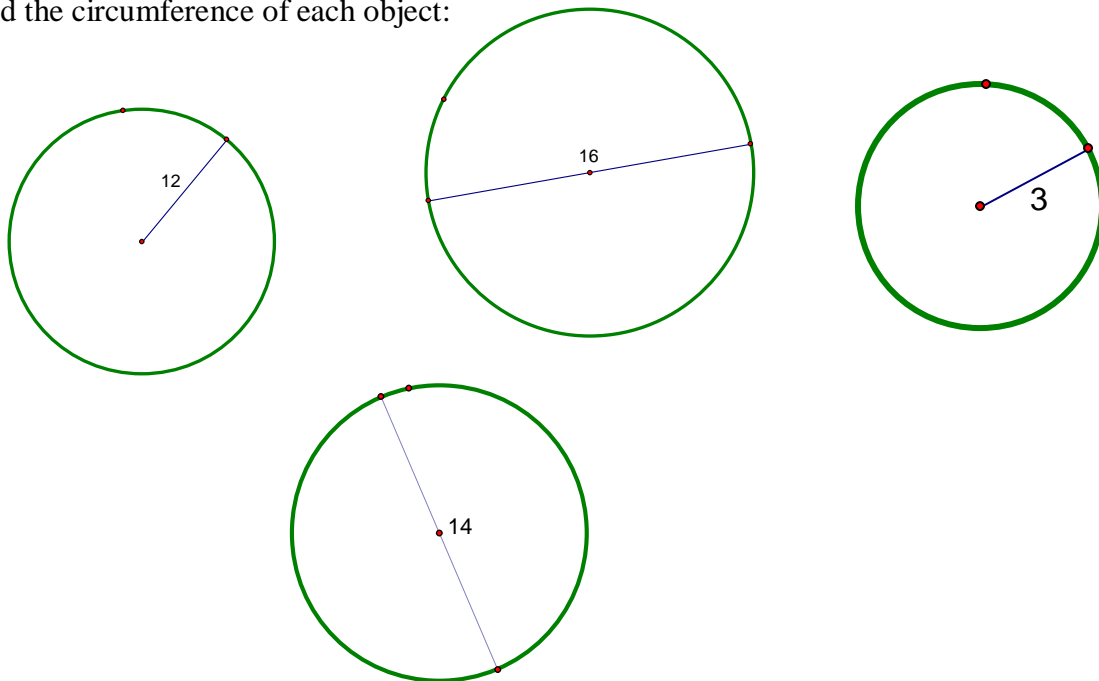

Arc-Length: (Length of an arc of a circle) Find the length of the requested arc for each object. Consider how much of the circumference you have.

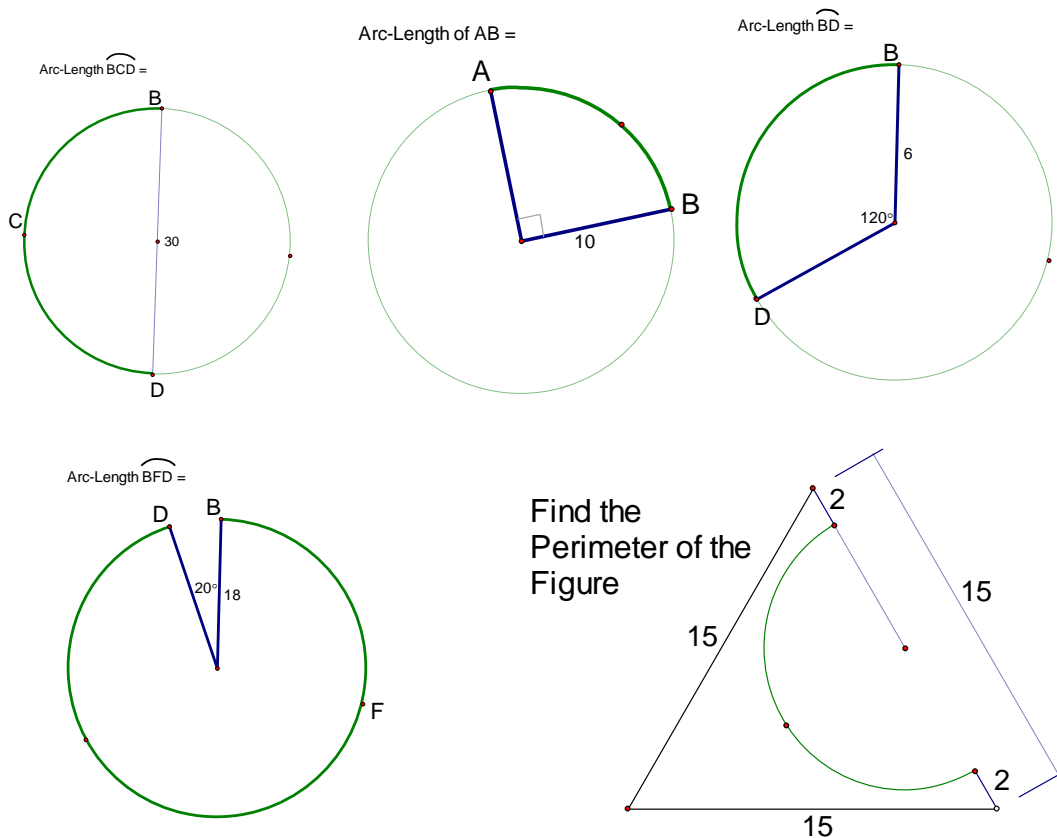

Find the Perimeter of the Figure

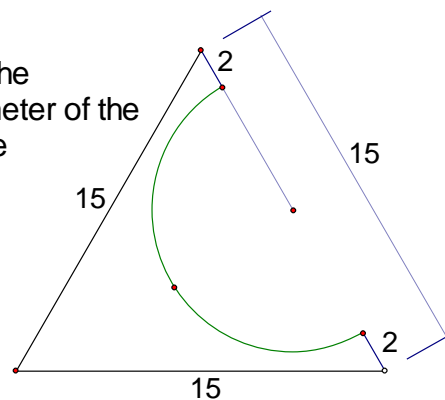

Circumference and Arc-length Homework

Name _____

Find the circumference of each figure.

1.

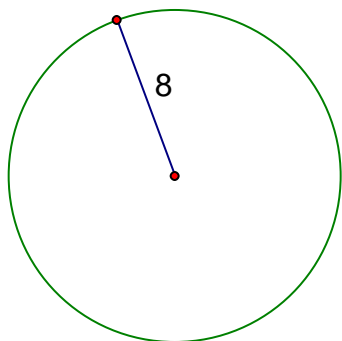

2.

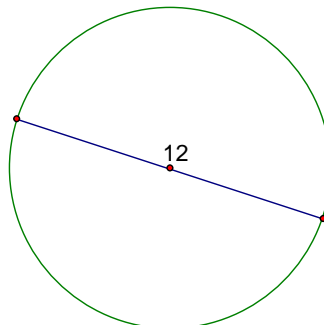

Find the requested Arc-Length for each figure.

Length of \widehat{AB} =

3.

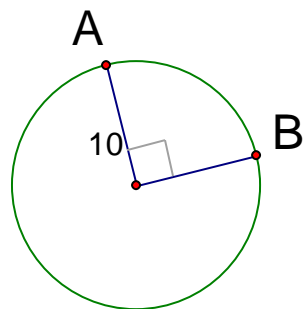

4.

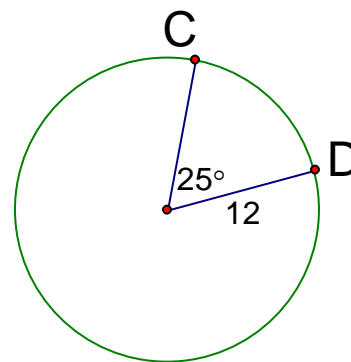

Find the perimeter of each figure.

5. Rectangle, with semicircles attached

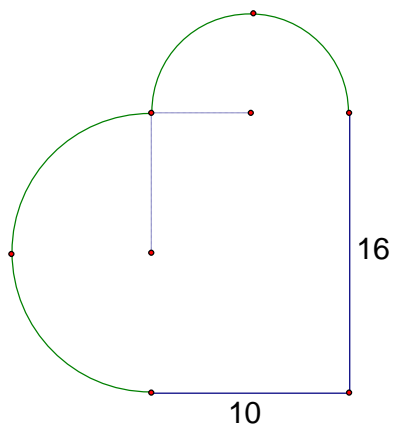

Length of \widehat{CD} =

6.

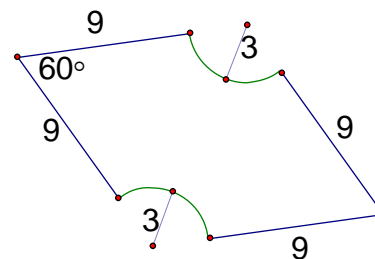

Rhombus w/ Cut Ends

Lesson 7 Area of Circles

Objectives:

1. SWBAT develop and use a formula for the area of a circle.
2. SWBAT develop and use a formula for area of sectors.
3. SWBAT find the area of shapes involving circles and sectors.

Procedures:

1. Using tiles from a fraction circle, place circle on overhead projector. Using the largest fractional pieces break the circle apart, and re-arrange the pieces into a parallelogram like shape. Continue to do this with each smaller set of fractional circle pieces. Students will be asked to identify what shape we are getting near to creating.
2. Once students have identified that we have a parallelogram, have them discuss how to find the area of a parallelogram.
3. Distribute handout that contains a circle broken into pieces, and then rearranged as a parallelogram. Ask students to identify what the base and the height of the parallelogram would be based on where those parts come from in the circle in their groups. (As necessary remind groups of circumference formula $= 2\pi r$.)
4. Once groups have discovered where each part comes from in the circle, direct them to begin discussing what the formula for circle area should be. Allow a short time for full class discussion.
5. Next direct students to the handout containing sectors of circles and ask them to find the area. Students should have a method quickly as this exercise is similar to that in lesson 6. If time is limited this can be accomplished as a class.
6. Have groups work through problems involving area of sectors and circles.
7. Distribute homework assignment as students leave.

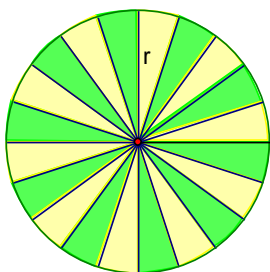

Area of a circle formula:

Be sure to label parts of figures for clarity, and to justify why the formula works.

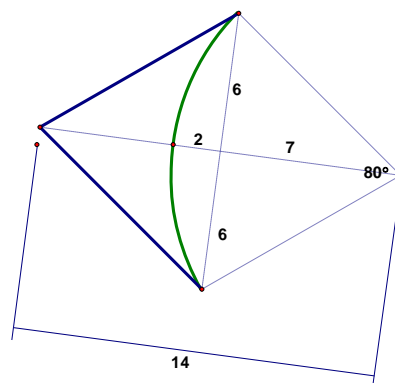
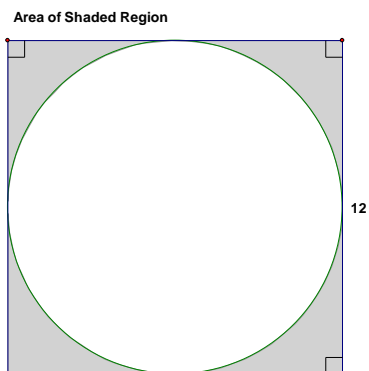
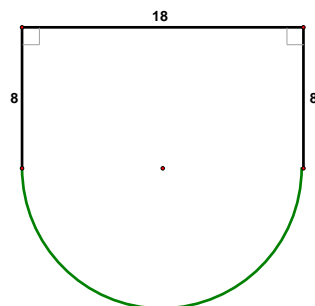
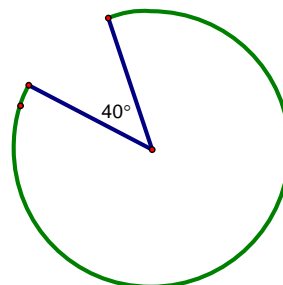
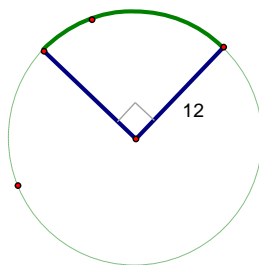
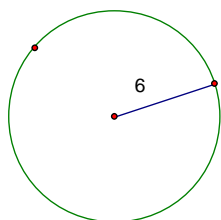
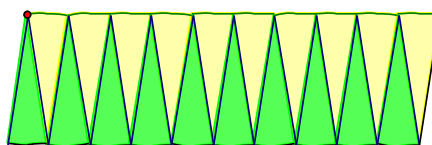

Area of Circles and Sectors Homework

Name _____

1. Find the area of the circle.

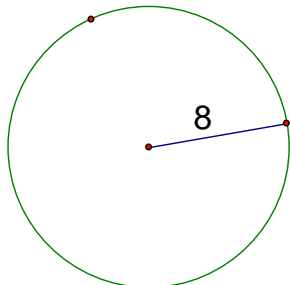

2. Find the area of the shaded sector.

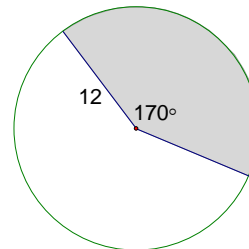

3. Find the area the shaded region of each figure.

a.

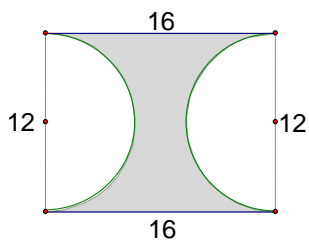

b.

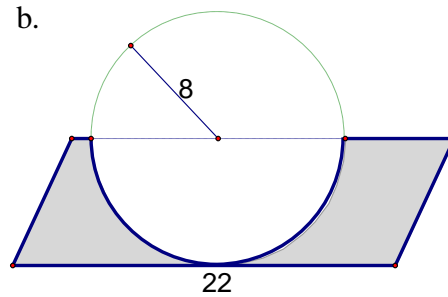

c.

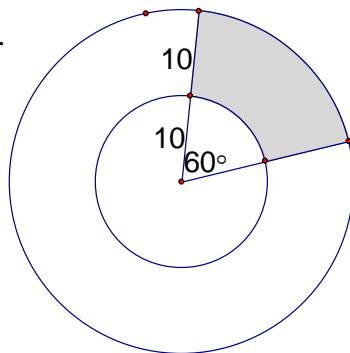

Lesson 8 Area of Regular Polygons

Objectives:

1. Students will be able to find the area of a regular polygon with the apothem and side length given by breaking the polygon into known shapes.
2. SWBAT find central angles of regular polygons, and understand that the apothem divides them exactly in half.
3. SWBAT find the area of any regular polygon given the length of a side, or apothem.

Procedures:

Day 1:

1. Hand out 3 different regular polygons with side length and apothem given, to each group. Each polygon should be at least half of a sheet of printer paper in size. Instruct students to find the area of each polygon. Every member will be responsible for one shape.
2. Have students record the area that they found on the board.
3. Lead students into a discussion about responses, have different members defend their resulting shape.
4. Handout worksheet with regular polygons with marked angles. Have students complete the worksheet finding the measure of the central angles, and in some cases, the measure of the angle after the apothem divides it.
5. Have groups justify their methods for finding the angle measures to one another by moving one member from each group and encouraging discussion.
6. Homework will be assigned and sent home which has the students find the areas of different regular polygons, and the central angles, and halves of central angles in regular polygons.

Day 2:

1. Hand out one large polygon to each group, each polygon should be at least half of a piece of printer paper in size. Allow students to work together to find the area of their polygon, refreshing what they had discussed the previous day.
2. Randomly select one member from each group and have them present the resulting area.
3. Give a short lesson reminding students how to use their trig functions to find missing elements of right triangles.
4. Hand out the gazebo problem to every student and allow groups to work through the problem.
5. Randomly select one group to collectively defend their solution to the class.
6. Allow other groups to present differing methods, and engage students in discussion of results for the remainder of the class period.

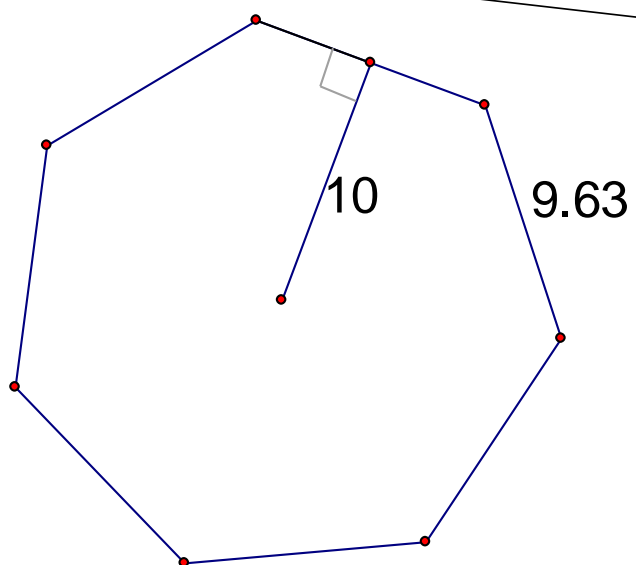
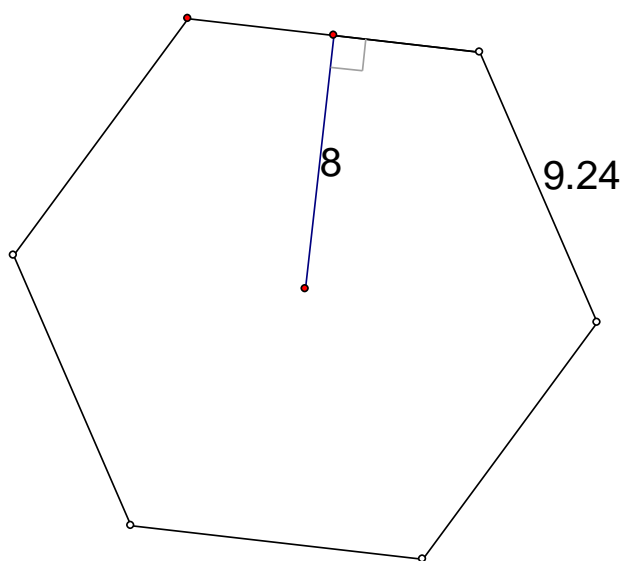
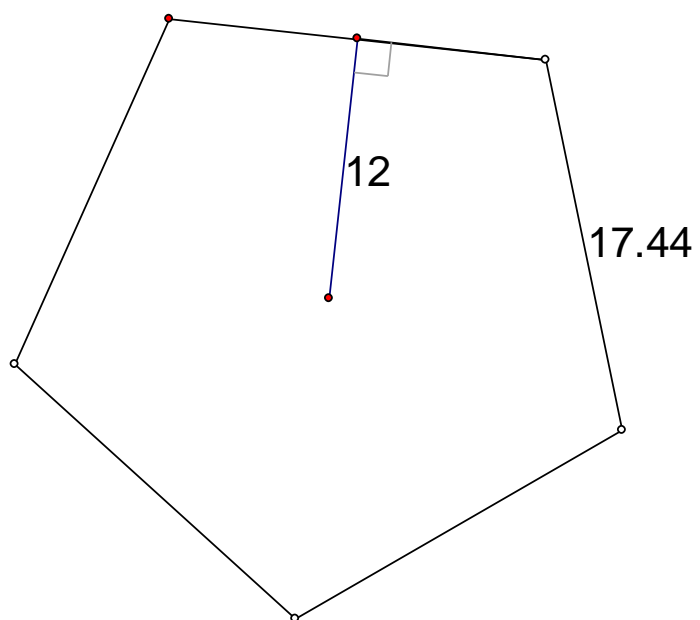

Find the measure of angle x in each figure.

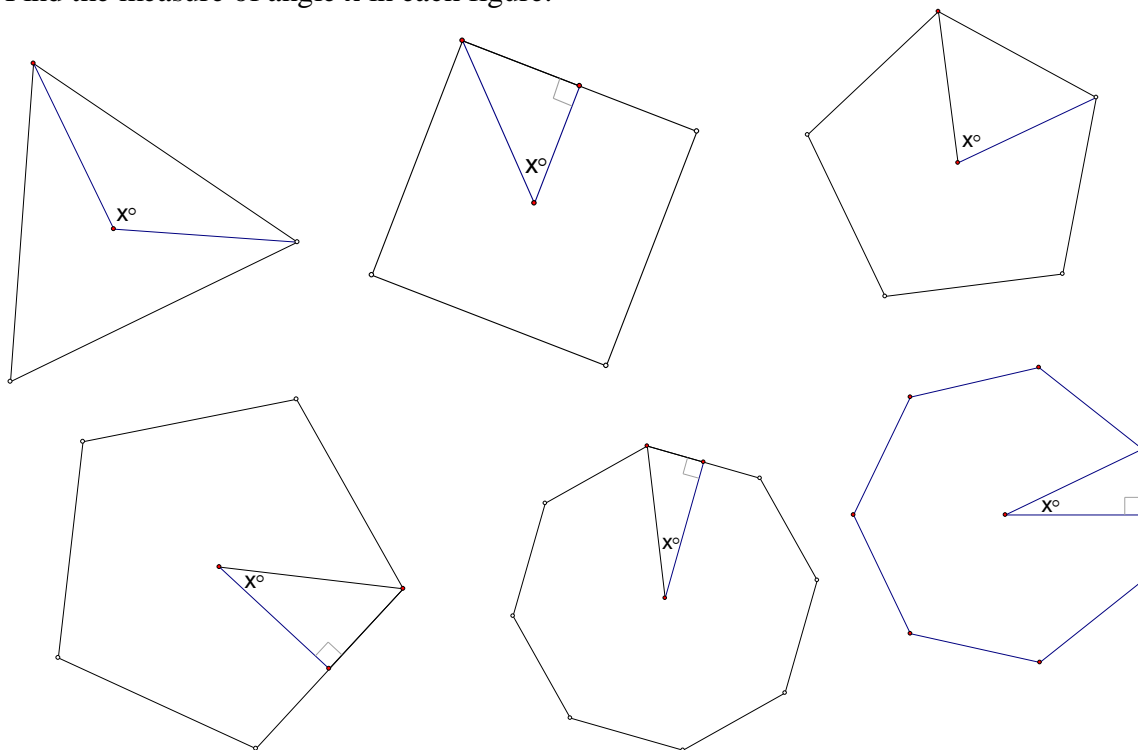

Find the area of each figure.

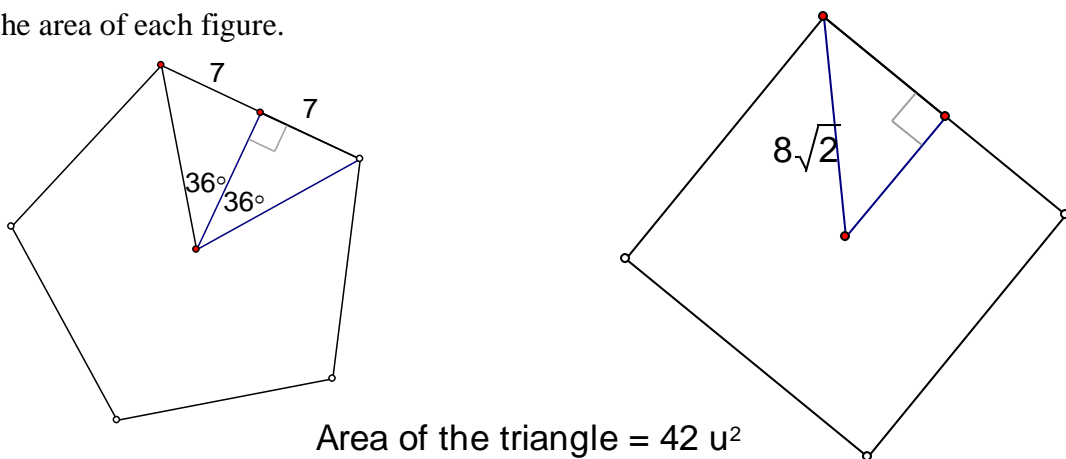

Area of the triangle = $42 u^2$
Find the area of the octagon

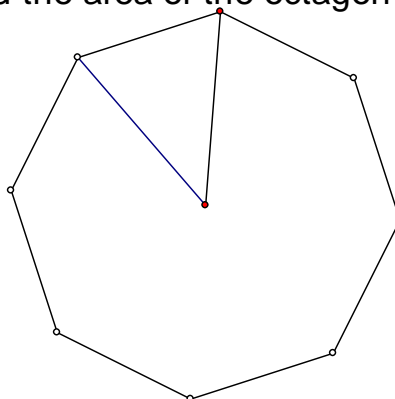

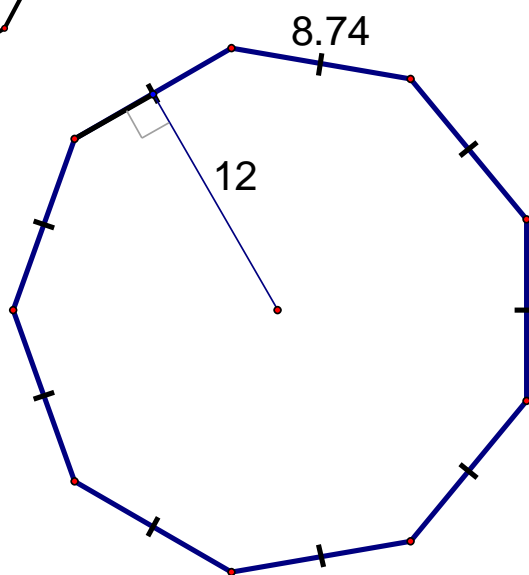
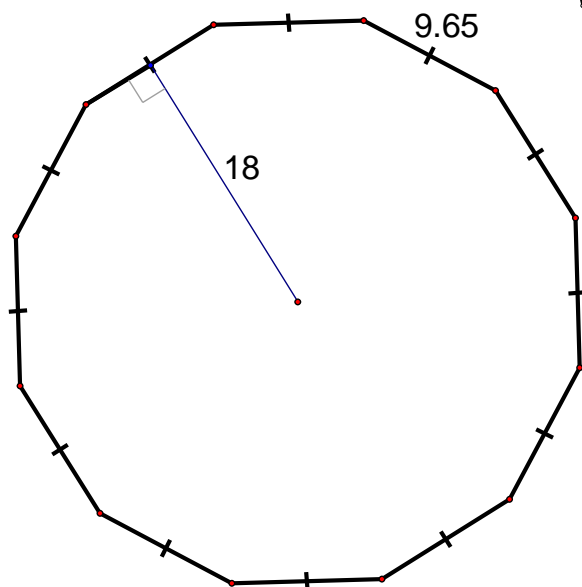
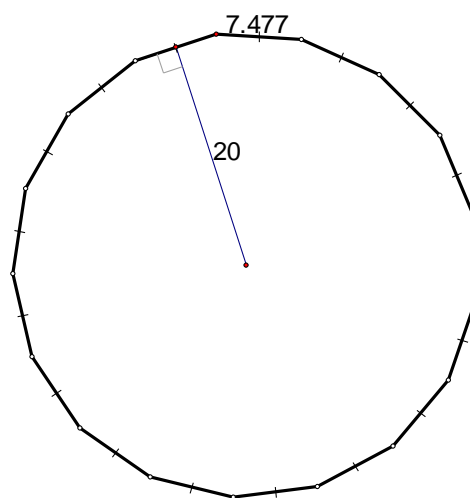
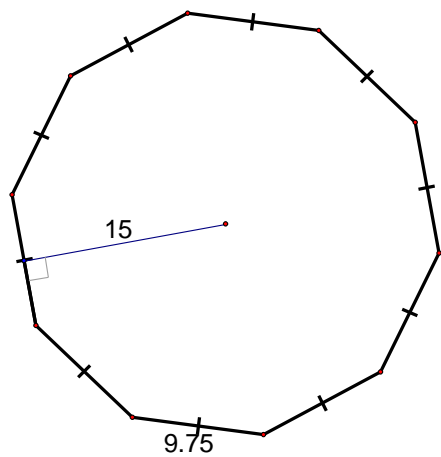

You would like to have a gazebo built in your backyard. A builder gives you the two options below for the same price. You want the gazebo that gives you the the largest floorspace for dances. Which gazebo design should you pick. How much more area do you get by using this design?

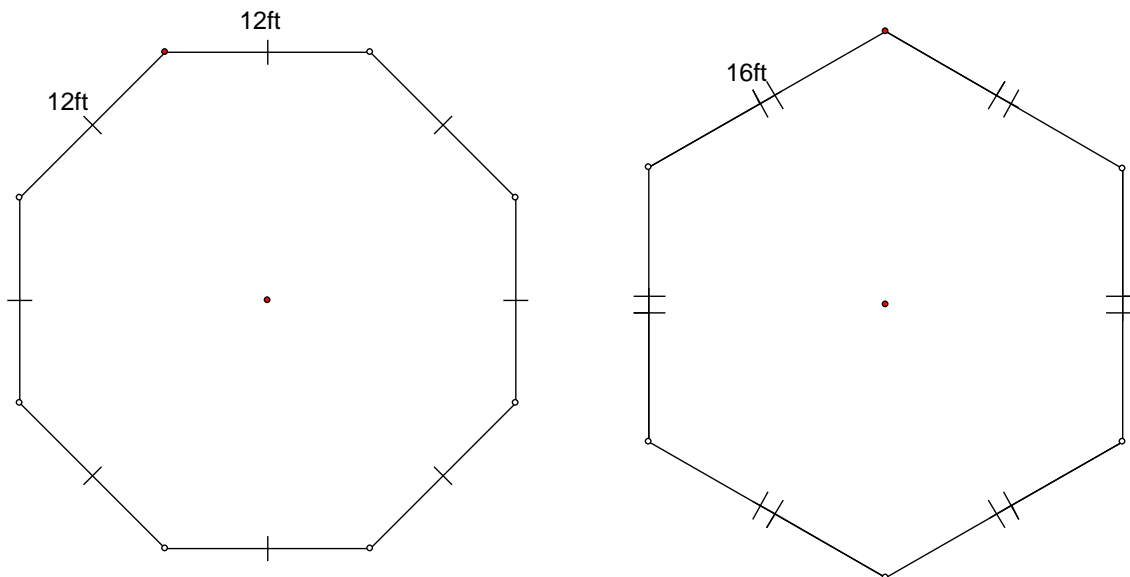

Regular Polygon Homework

Name _____

1. Find the area of each regular polygon using the given information.

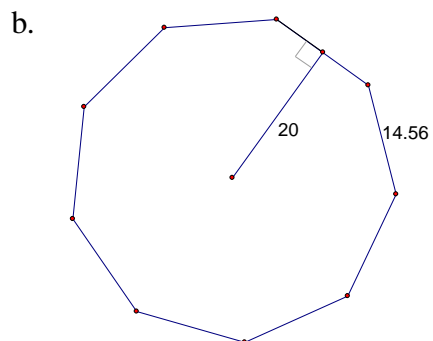
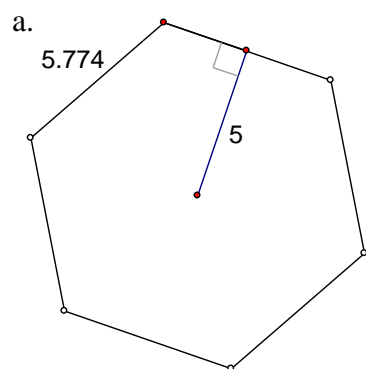
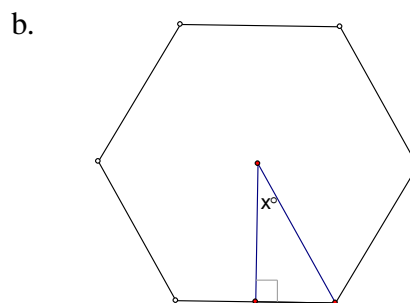
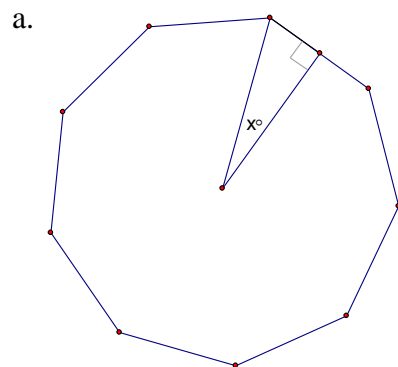
2. Find the measure of angle x in each figure.

Review of Area Lesson Plan

Objective:

1. SWBAT use the area formulas that they developed throughout the chapter to solve problems involving area.

Procedure:

1. Hand out a packet of realistic problems to each group, each problem should be sized to fill one piece of printer paper with landscape orientation. Allow students to work through the problems in any order. Groups will be expected to spend the period moving from problem to problem until the packet is complete.
2. Select groups to present their findings to the given problems based on methods that are witnessed throughout the class period. Allow time for student discussion.

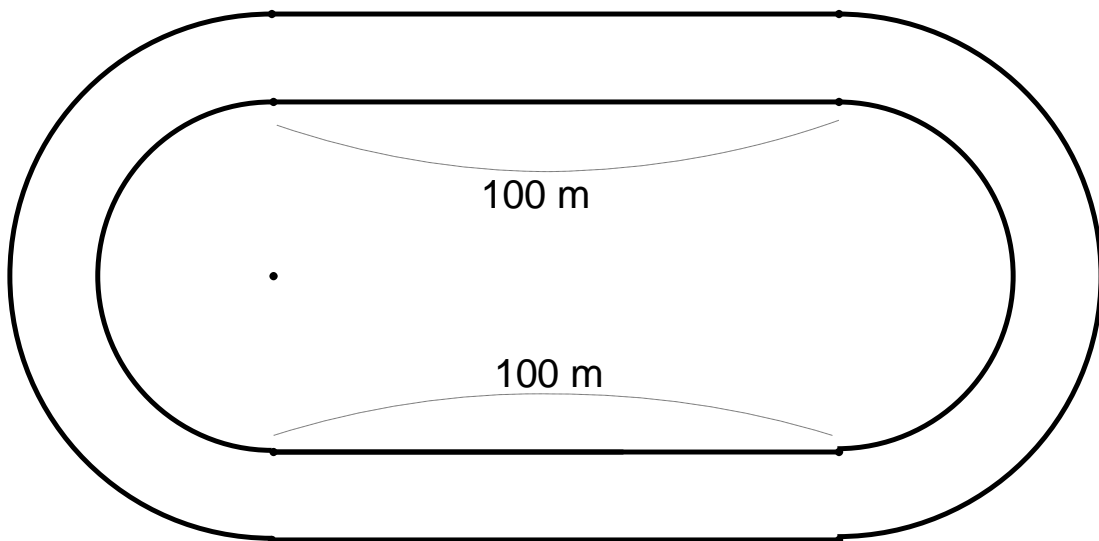

The distance around a track is 400 m.
What is the area of the infield? (Space inside of the track)

To the right is a floorplan for a room with a bay window. The homeowner would like to install 3ft x 3ft tiles in the floor of the room. The owner would first like to find the area of the room and then determine how many 3ft by 3ft tiles she needs to buy.

You are a friend of the owner, and she asks for your assistance. First find the area, then make a recommendation for how many tiles she should buy to floor the room.

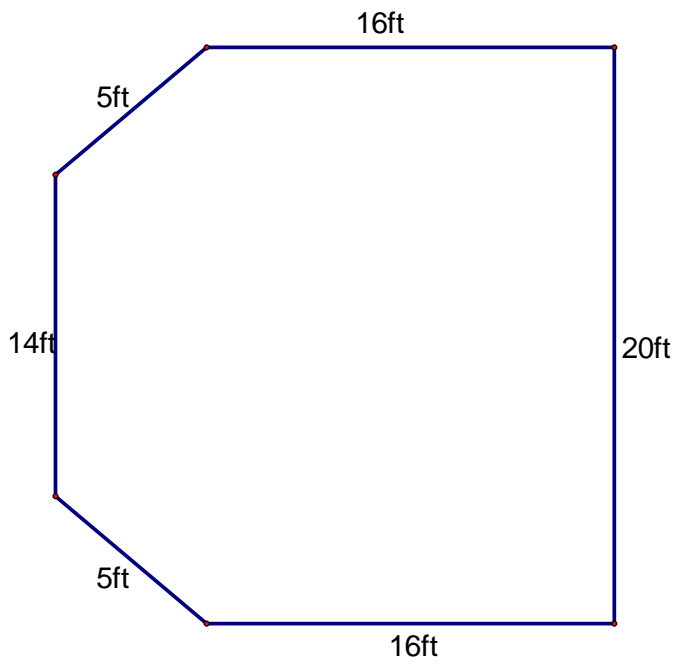

Below is a scale model of a garage we plan to build. The scale factor between the model and the garage is 1:7.

I want to know two things about the actual garage.

1. What will the perimeter of the garage be?
2. If the area of the scale model is 7.898 ft² what is the area of the actual garage?

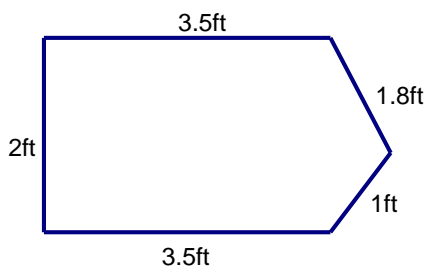

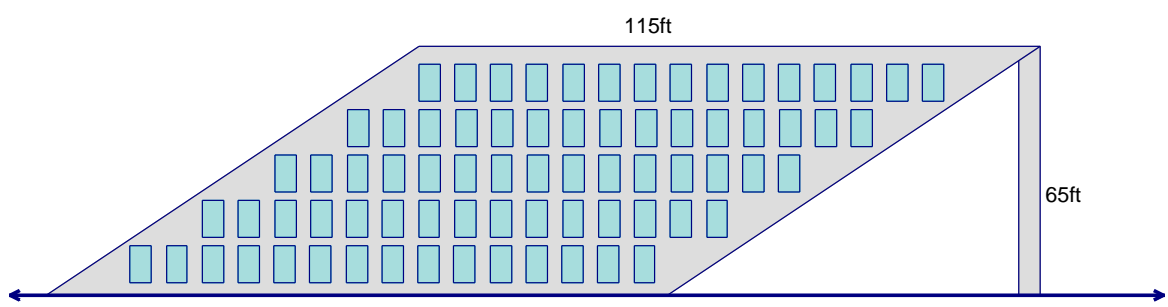

The Slant company has hired a local architect to design a building that is slanted to one side. Above you can see a sketch of his plan. The builder needs to know the area of one side of the building to begin putting together a list of necessary materials. What is the area of this slanted face of the building?

A large skyscraper is oriented on a single city block as shown below. The length of each block is 1200 ft

We need to know two things

- 1. The area of the buildings footprint
- 2. The area of the leftover space around the building which will eventually be covered by grass.

If 1 square yard of sod costs \$12, how much will it cost to lay sod around the entire building?

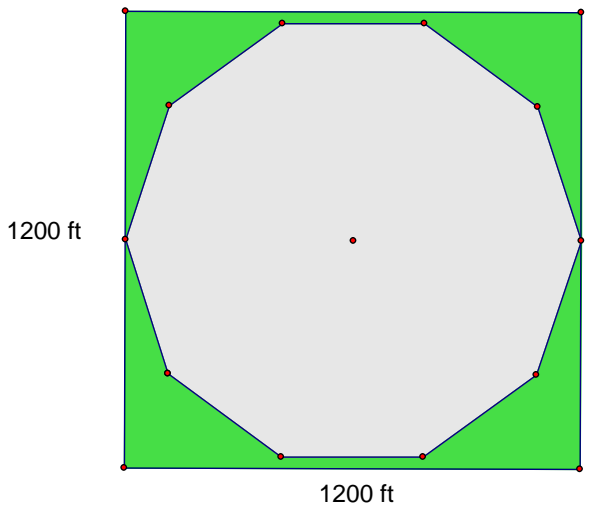

APPENDIX B
Tests and Quizzes

Geometry Area Project Pre-Test

Name _____

1. Find the length of the missing side of each right triangle.

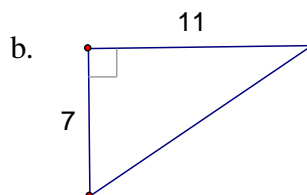
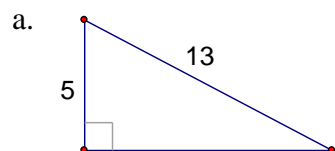
2. Find the length of side x in each triangle. Use your trig functions

$$\left(\text{sine} = \frac{\text{opp}}{\text{hyp}}, \text{ cosine} = \frac{\text{adj}}{\text{hyp}}, \text{ tangent} = \frac{\text{opp}}{\text{adj}} \right)$$

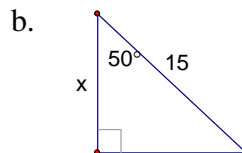
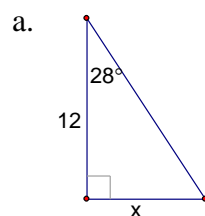

3. Find the perimeter of each figure.

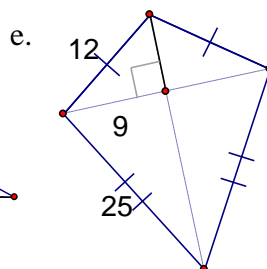
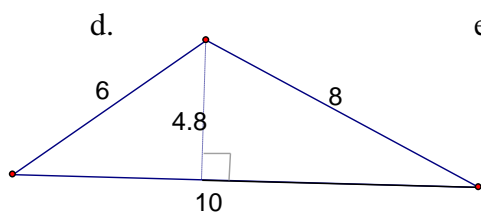
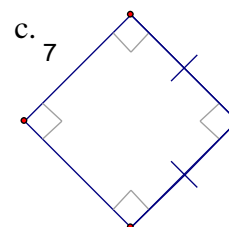
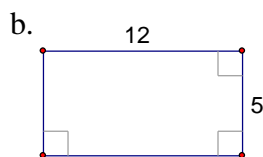
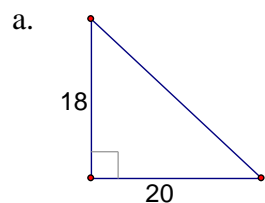

f. Circumference

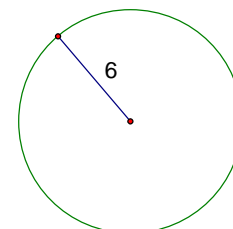

4. Find the area of each figure.

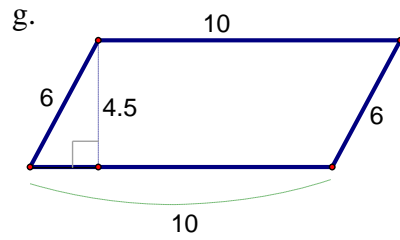
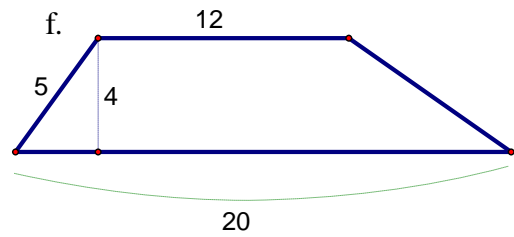
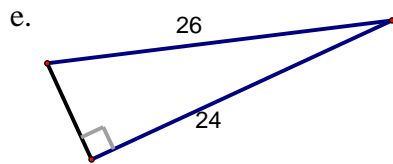
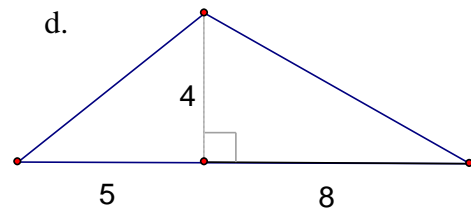
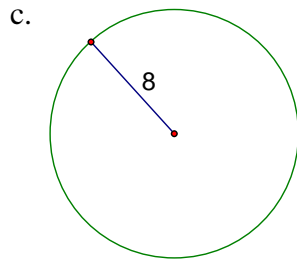
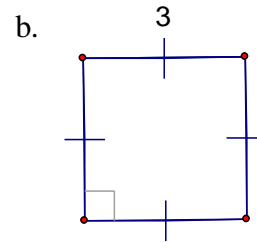
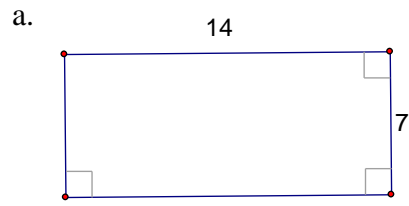

Geometry Test Chapter 11

Name _____

1. Find the area of each figure.

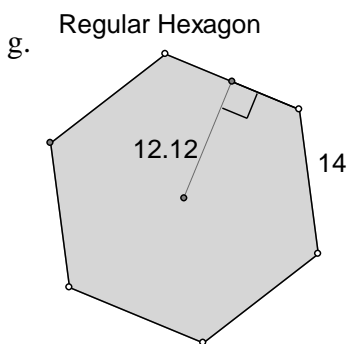
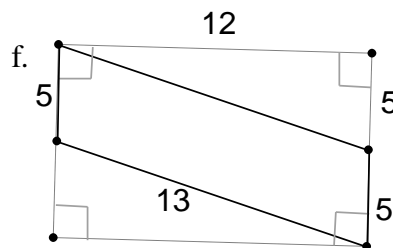
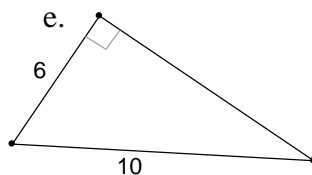
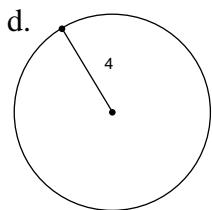
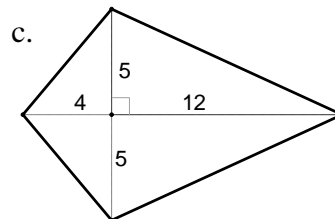
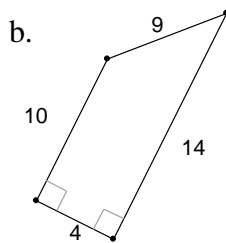
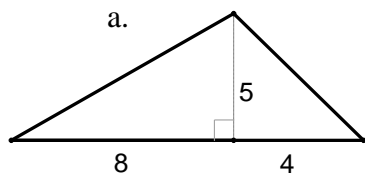

h. The area of $\triangle KMO$ is 12cm^2 .
If possible determine the area of the parallelogram KONL.

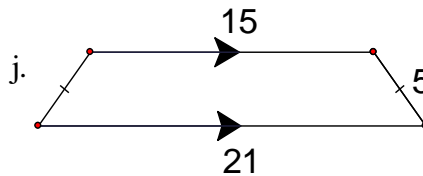
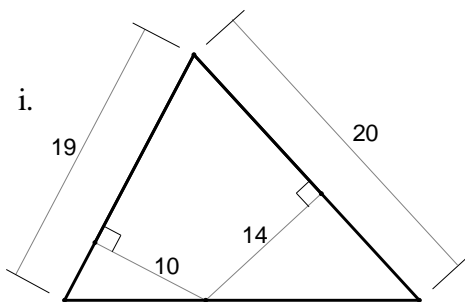
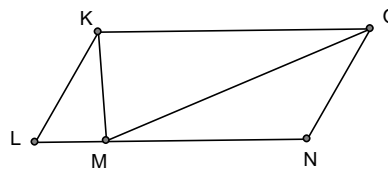

2. Find the circumference, arc-length or perimeter for each figure

a. Circumference

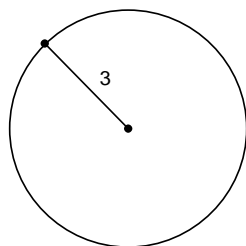

b. arc-length of AB

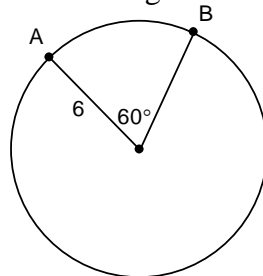

c. Perimeter

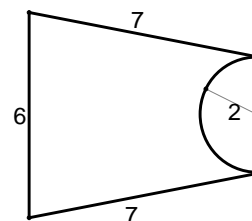

3. Find the area of the shaded region of each figure

a.

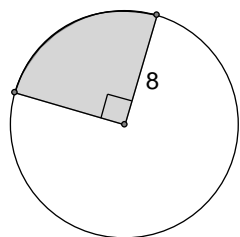

b.

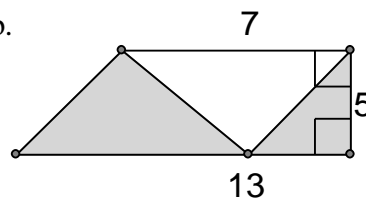

c.

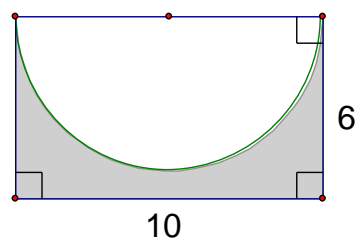

d.

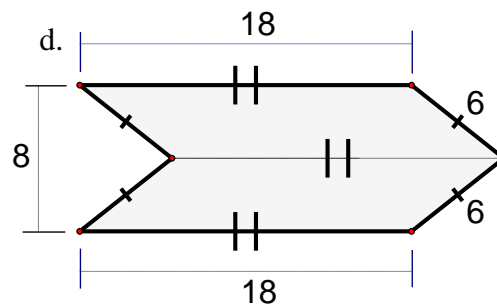

4. Find the area of the regular polygon, remember your trig functions. (Show all work)

$$\text{sine} = \frac{\text{opposite}}{\text{hypotenuse}}$$

$$\text{cosine} = \frac{\text{adjacent}}{\text{hypotenuse}}$$

$$\text{tangent} = \frac{\text{opposite}}{\text{adjacent}}$$

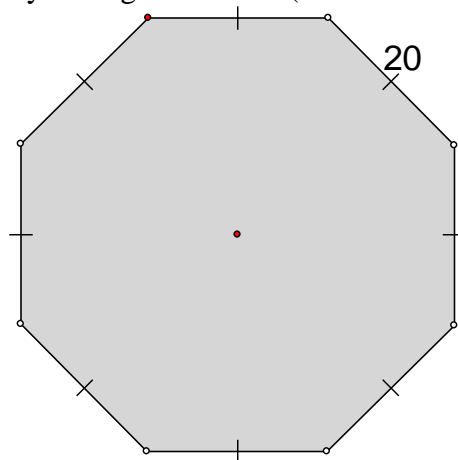

5. If two similar figures have a ratio of perimeters of $6/7$ what is the ratio of their areas?

6. Which is larger, the circumference of the large circle, or the sum of the circumferences of the smaller circles that share their diameters with the larger circle?

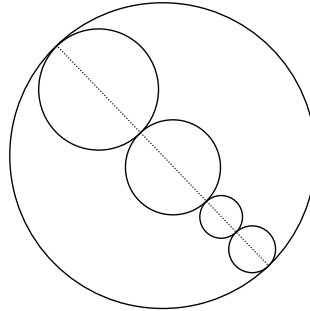

7. BONUS: Find the area of the shaded region

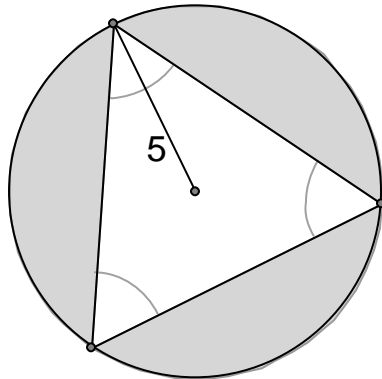

Area Retention Quiz

Name _____

Find the area of each figure.

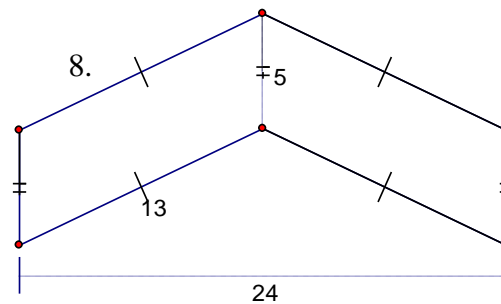
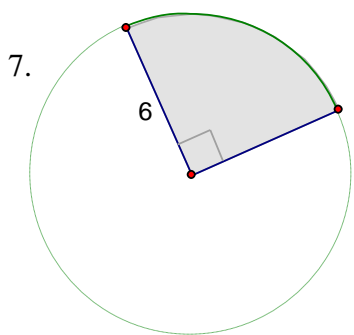
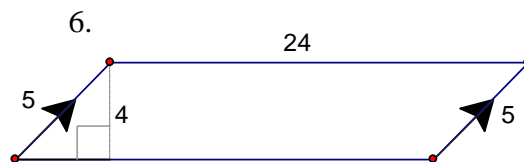
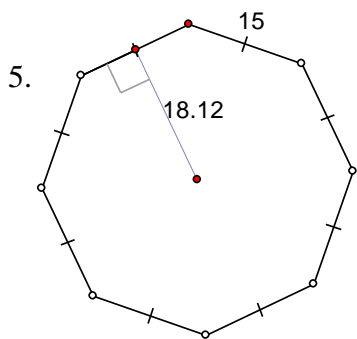
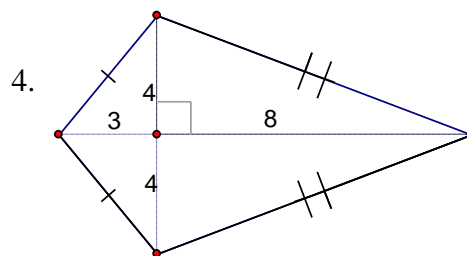
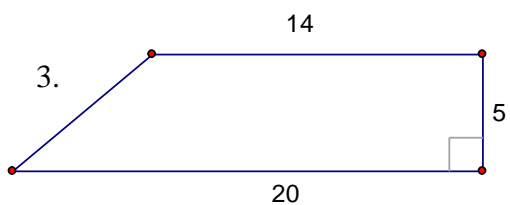
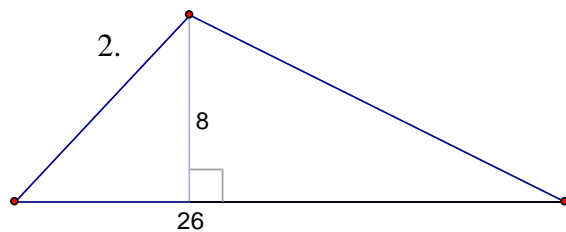
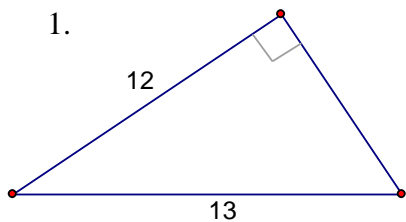

APPENDIX C

Questionnaire

Questionnaire

(do not write your name)

1. Please rate on a scale of 1-5, 1 being the worst and 5 being the best, how well you liked this chapter compared to other chapters we have covered.

1 2 3 4 5

2. How well do you feel you understand how to find area of shapes? (1 being not very well, 5 being extremely well)

1 2 3 4 5

3. How confident do you feel that if you had to find area to complete a project you would be able to do it? (1 = not very confident, 5 = extremely confident)

1 2 3 4 5

4. How much do you feel you learned this chapter? (1 = not very much, 5 = I didn't know I could learn so much)

1 2 3 4 5

5. How prepared did you feel before this chapter started to apply what you knew about area to real world applications? (1 = I couldn't have done it, 5 = could have solved any real world area problem)

1 2 3 4 5

6. How prepared do you think you are now to apply what you know about area to real world applications? (1 = couldn't do it, 5 = could solve any real world area problem)

1 2 3 4 5

7. How did your performance in this chapter (homework and tests) compare with your performance on previous chapters? (1 = I did way worse on this chapter, 5 = I did much better on this chapter)

1 2 3 4 5

8. Did you feel that the approach we took to learning area was beneficial to your understanding? (1 = no, not at all, 5 = yes, there is no better way)

1 2 3 4 5

9. Why did you feel that the way this chapter was taught was helpful or not helpful?

10. What was the most interesting thing you learned during this chapter?

11. If you were an educator, how would you change the way that lessons are taught?

12. Why?

13. Define area in your own words.

14. Define perimeter in your own words.

APPENDIX D
Project Schematic

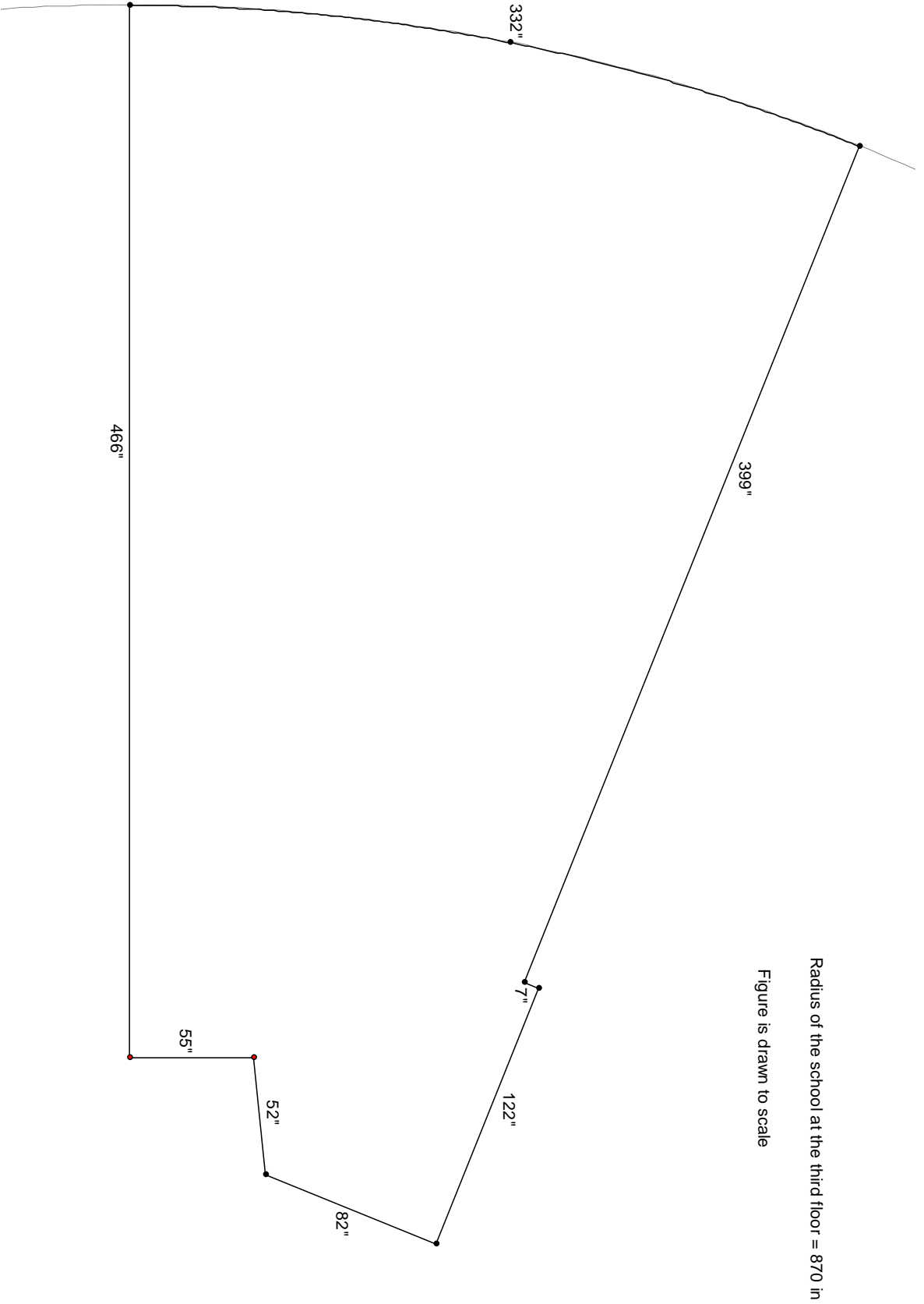

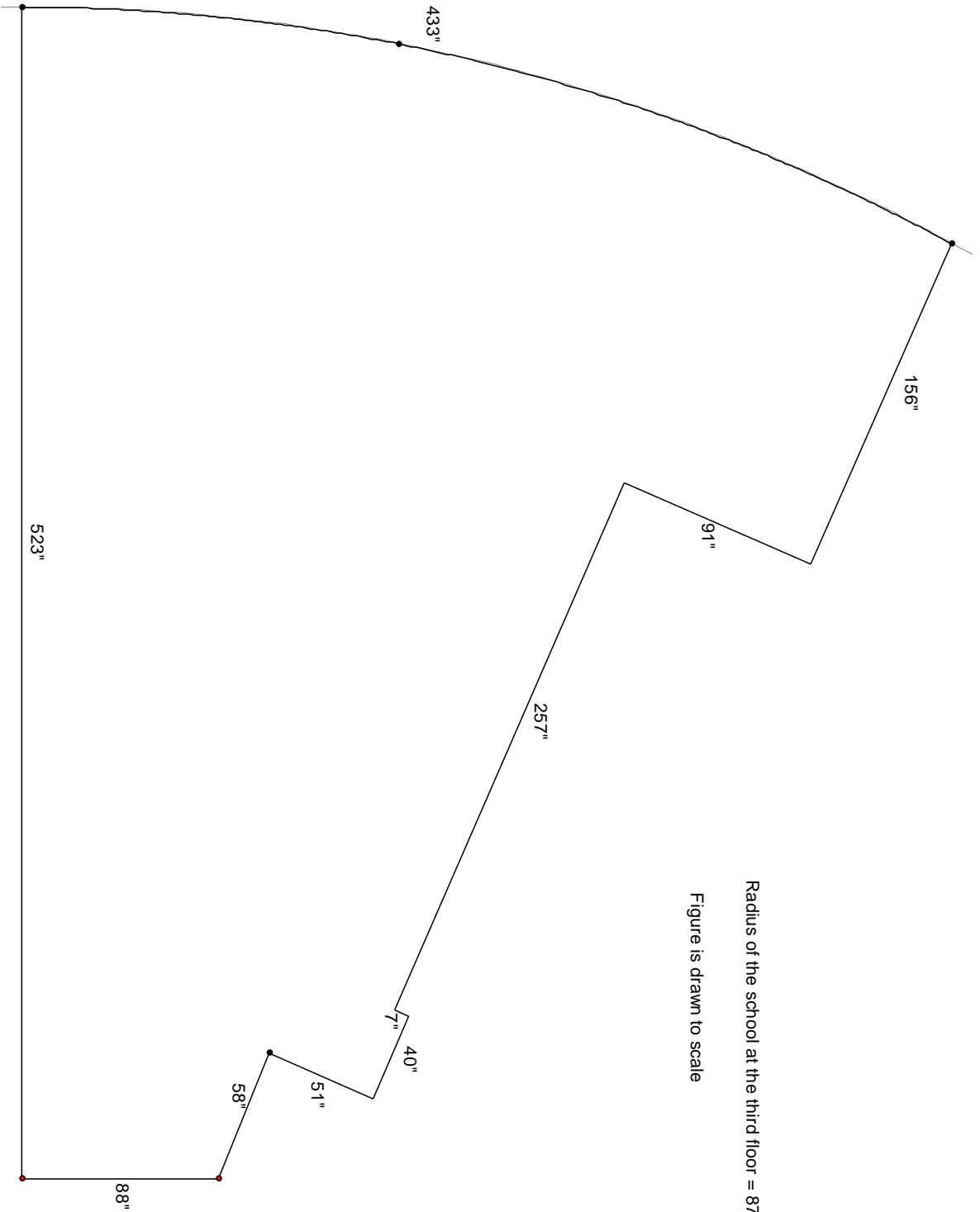

Radius of the school at the third floor = 870 in
Figure is drawn to scale

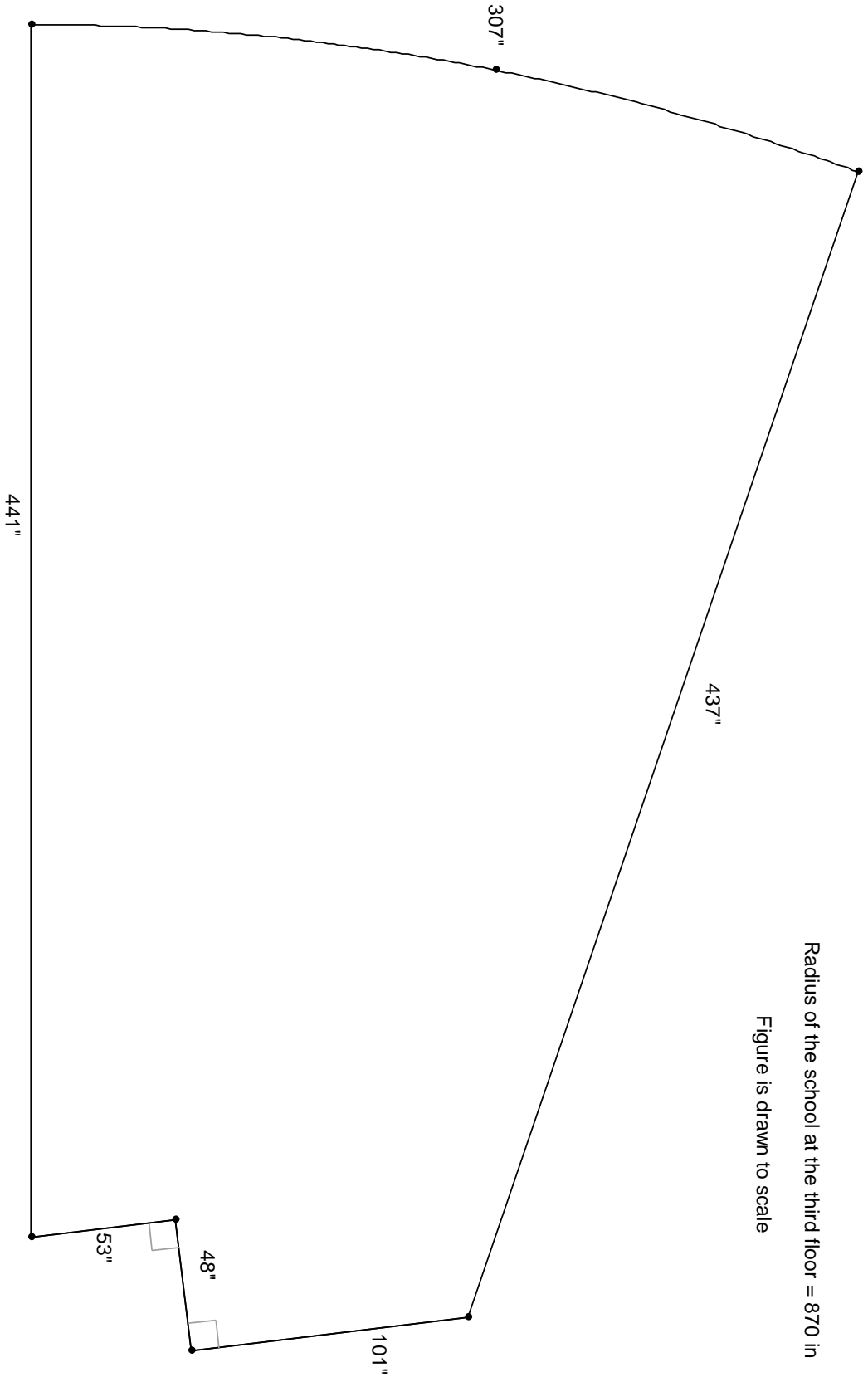

APPENDIX E

Item Analysis

Table E1: Pre-Test Item Analysis

Item	Control Group n = 33		Experimental Group n =19		p-value
	mean	standard deviation	mean	standard deviation	
1a.	0.848	0.364	0.947	0.229	0.292
1b	0.818	0.391	0.737	0.452	0.499
2a.	0.152	0.364	0.211	0.419	0.597
2b.	0.212	0.415	0.263	0.452	0.681
3a.	0.242	0.435	0.368	0.496	0.344
3b.	0.727	0.452	0.895	0.315	0.161
3c.	0.758	0.435	0.895	0.315	0.235
3d.	0.545	0.506	0.789	0.419	0.081
3e.	0.545	0.506	0.684	0.478	0.336
3f.	0.030	0.174	0.211	0.419	0.034*
4a.	0.515	0.508	0.737	0.452	0.121
4b.	0.485	0.508	0.526	0.513	0.779
4c.	0.061	0.242	0.158	0.375	0.260
4d.	0.303	0.467	0.474	0.513	0.226
4e.	0.182	0.392	0.158	0.375	0.830
4f.	0.030	0.174	0.053	0.229	0.694
4g.	0.242	0.435	0.158	0.375	0.482

* Statistically significant at the p=0.05 level

Table E2: Post-Test Item Analysis

Item	Control Group n = 31		Experimental Group n= 17		p-value
	mean	standard deviation	mean	standard deviation	
1a	0.645	0.486	0.941	0.243	0.02*
1b	0.452	0.506	0.706	0.470	0.095
1c	0.484	0.508	0.882	0.332	0.006**
1d	0.742	0.445	0.824	0.393	0.530
1e	0.323	0.475	0.647	0.493	0.030*
1f	0.097	0.301	0.412	0.507	0.009**
1g	0.387	0.495	0.706	0.470	0.035*
1h	0.161	0.374	0.118	0.332	0.670
1i	0.129	0.341	0.353	0.493	0.070
1j	0.065	0.250	0.235	0.437	0.090
2a	0.323	0.475	0.706	0.470	0.010*
2b	0.226	0.425	0.353	0.493	0.354
2c	0.290	0.461	0.471	0.514	0.220
3a	0.452	0.506	0.588	0.507	0.376
3b	0.387	0.495	0.412	0.507	0.871
3c	0.226	0.425	0.471	0.514	0.083
3d	0.355	0.486	0.471	0.514	0.444
4	0.226	0.425	0.294	0.470	0.610
5	0.387	0.495	0.412	0.507	0.870
6	0.226	0.425	0.235	0.437	0.942
7	0.097	0.301	0.059	0.243	0.657

* Statistically significant at the p=0.05 level

**Statistically significant at the p=0.01 level

Table E3: Retention Quiz Item Analysis

Item	Control Group n = 30		Experimental Group n = 18		p-value
	mean	standard deviation	mean	standard deviation	
1	0.400	0.498	0.722	0.461	0.031*
2	0.900	0.305	0.833	0.383	0.509
3	0.633	0.491	0.667	0.485	0.820
4	0.567	0.504	0.722	0.461	0.291
5	0.267	0.449	0.500	0.514	0.106
6	0.433	0.504	0.611	0.502	0.242
7	0.367	0.490	0.833	0.383	0.001**
8	0.133	0.346	0.389	0.502	0.042*

* Statistically significant at the $p=0.05$ level

**Statistically significant at the $p=0.01$ level