

Wearable Textile Antenna for Glucose Level Monitoring

Asha Ghodake, and Balaji Hogade

Abstract—Wearable antennas are becoming increasingly popular as a result of their wide range of applications, including communication, health parameter monitoring, and so on. If the wearable antenna is built of textile material, it is highly comfortable to wear and has numerous benefits, such as light weight, compact size, and low cost. A 1.3 GHz microstrip antenna made from jeans substrate is presented in this work. For antenna conducting patch and ground plane copper material is used. The electromagnetic properties of the jean's substrate are dielectric constant $\epsilon_r = 1.7$ and loss tangent $\tan \delta = 0.01$. In this work the main purpose or application of this antenna is to observe three levels of glucose, i.e., hypoglycemia, hyperglycemia, and normal glucose. The antenna is placed over the arm in the first scenario, while the finger is placed over the antenna patch in the second case. When the glucose concentration in the blood varies, the blood properties change, and the antenna frequency shifts as a result. [That] This frequency shift is used to find out the three glucose levels. The advantage of jeans substrate is that you can wear this antenna very easily over your arm. The antenna is designed using HFSS software and tested using an arm phantom and a finger phantom designed in HFSS.

Keywords—Wearable; textile; microstrip; hypoglycemia; frequency shift; phantom

I. INTRODUCTION

IN recent years, the scope of wearable technology has become greater, and there has been a growing need for wearable gadgets in a variety of industries. Wearable antennas for all current applications are often light in weight, cheap in cost, and nearly maintenance-free [1]. Now a day's one of the most prominent antenna research subjects is wearable textile-based antennas for communications between devices and the human body [2].

Fabric antenna design necessitates an understanding of the electromagnetic properties of the textile material, such as ϵ_r and $\tan \delta$ [3]. One category of textile material is conductive, and the other is nonconductive. Examples of non-conductive materials are silk, felt, jeans, cotton, and fleece, which are normally used as substrates, and conductive materials like Zelt, Electron, copper, polyester, and taffeta fabrics. Conducting materials are normally used for conducting patches [4]. Because fabrics have a small dielectric constant, antennas utilizing fabrics as a substrate can provide better performance than traditional antennas [5].

Wearable textile antennas have a variety of uses for military and commercial purposes, but one of the most essential is the observation of various health-related signals when the antenna is worn on the human body [6]. As a result, [one of] its most

important application is the monitoring of health parameters. In wearable antenna design, microstrip and patch designs are very popular. So, anyone can easily wear or include these antennas in clothing.

There are different methods of fabrication of textile antennas; in general, in the fabrication process, non-conducting textile material is used as the substrate, and copper material is used for the conducting patch. Copper material is directly glued onto textile material using non-conducting glue [7].

Nowadays, glucose level monitoring is very essential for diabetic patients, and it is common in many people. Diabetic patients have face different health problems due to an increase in glucose levels, so it is necessary to monitor glucose levels regularly and, after that, according to glucose levels, patients can change their diet, meditation, and exercise to maintain glucose levels. When a patient can keep proper track of blood glucose, it will be a great help to keep glucose level under control. It is possible only when this tracking is easy, without any pain, without taking blood every time. [8].

Due to different health issues, people can use different medicines. Because of that, a change in glucose level is also observed. Busy life, workload, and stress are responsible for the ups and downs in glucose levels. There are different types of glucose levels. The first is hypoglycemia, means low sugar levels, which are less than 70 mg/dl [9]. The second type is hyperglycemia, which occurs when blood sugar levels exceed 200 mg/dl, and the third type is normoglycemia, or normal glucose, which occurs when blood sugar levels are between 70 and 200 mg/dL [10] [11].

Different methods are available for glucose level monitoring, called invasive methods and noninvasive methods. In the invasive method, devices [enter] are entered into the body, but in the noninvasive method, devices do not enter the body, and the procedure is painless and easy [12]. The most preferred method is to take blood samples from patients and then analyze those samples. Finally, reports are generated [13]. Under the home monitoring concept, different devices and types are used for glucose level monitoring. Two types are available: noncontinuous glucose monitoring and continuous glucose monitoring. [14].

The aim of this paper is noninvasive glucose monitoring. Considering these points, a microstrip antenna is designed to act as a sensor. It senses an increase or decrease in glucose levels. When there is a change in glucose level, then there is a variation in blood properties. This variation is responsible for the shift in output frequency of the antenna. This frequency shift is used to measure glucose level [15].

Authors are with Terna Engineering College, University of Mumbai, India (e-mails: asha.p.ghodake@gmail.com, bghogade@gmail.com).



II. ANTENNA DESIGN

The antenna is designed at 1.3 GHz using a jeans substrate having a dielectric constant $\epsilon_r = 1.7$ and a loss tangent of 0.025 [16] [17]. An antenna is simulated using HFSS software. A dielectric layer on the ground surface supports a rectangular patch element [18]. The front side and back side of the antenna are given in Fig 1. The antenna operates at 1.3 GHz with a patch length of 45.25 mm and a width of 53.75 mm. Partial ground plane concept is used in this design.

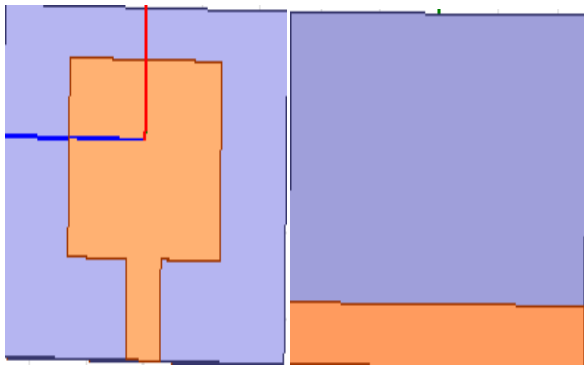

Fig. 1. (a) Front side (b) back side of proposed antenna

For feeding, the microstrip feed line method is used. The patch and ground are made of copper material.

A. Simulation Results

It is clear to see that the return loss for the antenna is to be -48.06 dB at a frequency of 1.3 GHz, as shown in Fig 2. A good value of reflection coefficient is obtained, and it is required for antenna design. Because the reflection coefficient is the ratio of incident to reflected power [19].

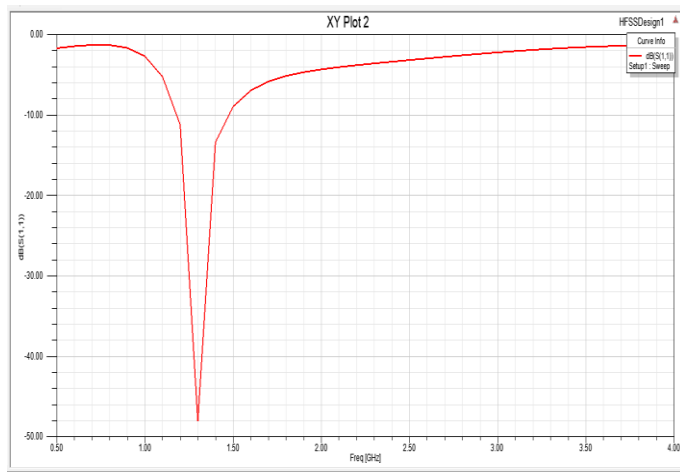

Fig. 2. Return loss of antenna

The obtained voltage standing wave ratio is 1.01, as shown in Fig 3. Normally, the value of VSWR falls between 1 and 2.

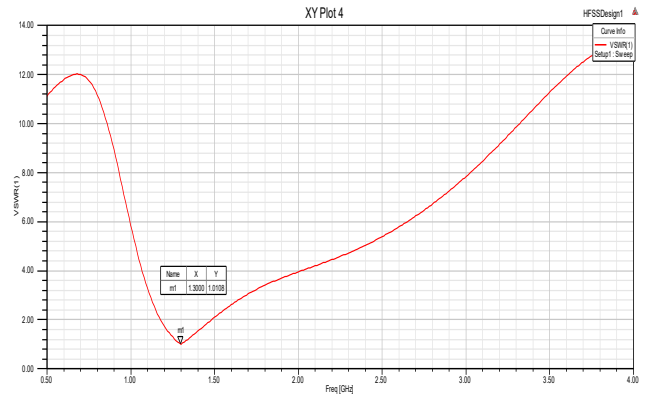

Fig. 3. Voltage standing wave ratio

The obtained radiation pattern of the antenna is shown in Fig 4. Radiation patterns are very important to find out the quality of radiated power. There are two different plots of the radiation pattern; one is 2D and the other is 3D.

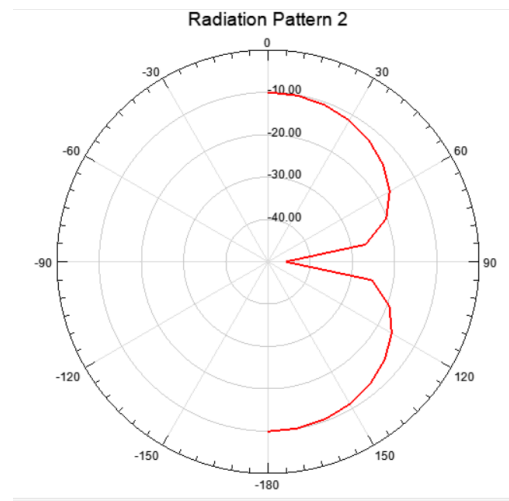

Fig. 4. Radiation pattern of antenna

An antenna's gain is another important component. It is related to how an antenna effectively converts input into RF output. The obtained gain of the designed antenna is 2.27 dB, as shown by the 3D polar plot given in Fig 5.

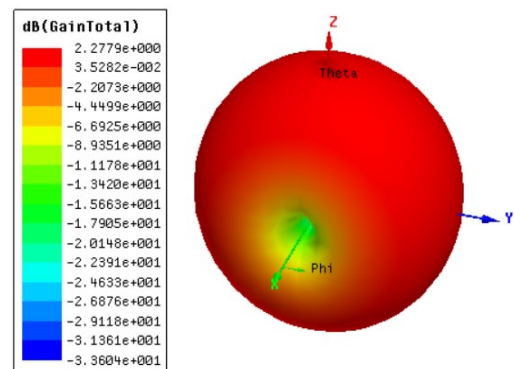

Fig. 5. Gain of antenna

The E field distribution at the patch and at the feeding point is shown in Fig. 6. The electric field at the feeding point is $1.0120 \text{ e} + 002$, at the patch center electric field is $2.5307 \text{ e} + 001$, and at the patch age, it is $7.5903 \text{ e} + 001$.

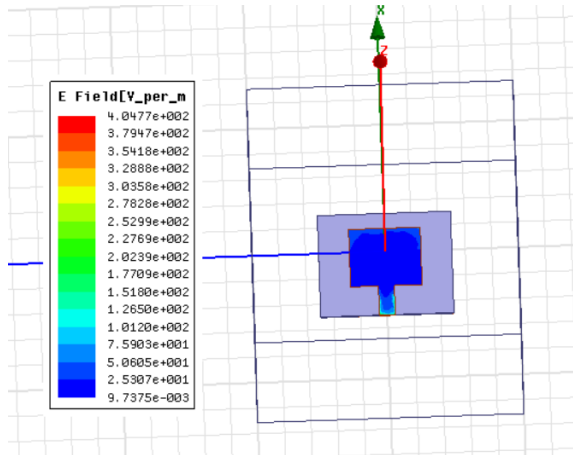

Fig. 6. Electric field distribution of antenna

B. Specific absorption rate (SAR)

In wearable antennas, the main significant parameter is the specific absorption rate (SAR). Because human beings can wear these antennas on their bodies, so what is the effect of electromagnetic radiation on the human body? This can be found out using SAR results. SAR is nothing but how much RF power is absorbed by the human body when an antenna is placed near to it [20]. The SAR value also depends on the distance between the antenna and the human body [21]. The obtained value of SAR for the designed antenna is 0.487 w/kg , as shown in Fig 7.

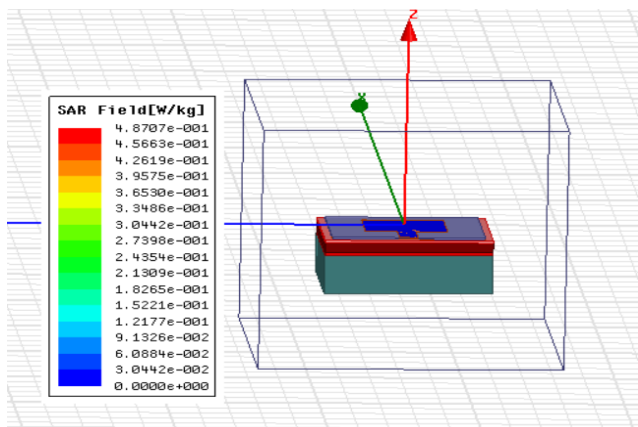

Fig. 7. SAR result

SAR is calculated using 1 gram or 10 grams of body tissue [22] [23]. There is no effect of RF radiation when the value of SAR is less than 1.6 w/kg [24]. In this work, SAR is measured over 1 gram of body tissue.

C. Arm and finger phantom design

In the testing procedure, two steps are considered. In the first step, the antenna is placed over the arm phantom and observations are to be taken. In the second case, a finger is placed over the antenna patch and observations are to be taken.

The Arm Phantom was created using HFSS software. It consists of the four layers of skin, fat, blood, and muscle given in Table I [25]. The output frequency and reflection coefficient are observed when the antenna is mounted on the arm phantom, which is shown in Fig 8.

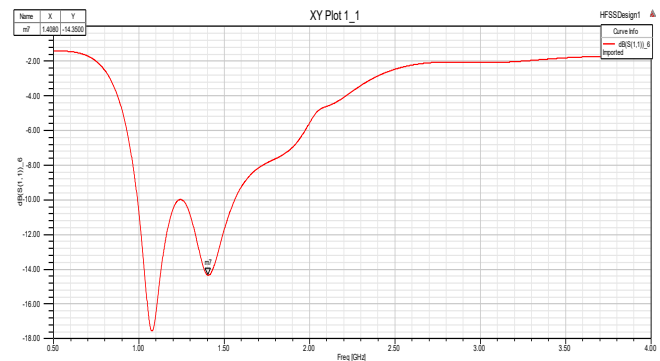

Fig. 8. Output using arm phantom

Permittivity and σ of each layer are given in Table I at 1.3 GHz, along with the height of each layer. Figure 9 Shows an arm phantom designed in HFSS software and an antenna is placed over the phantom.

TABLE I
ARM PHANTOM LAYERS

Layers	ϵ_r	$\sigma \text{ s/m}$	h mm
Skin	39.9	1.00	2.48
Fat	5.41	0.0618	9.07
Blood	60.3	1.73	2.5
Muscle	54.3	1.10	32

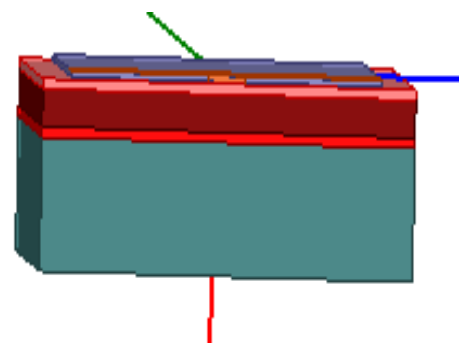

Fig. 9. Arm Phantom

Similarly, finger phantom is also designed using HFSS software. This phantom also made up of four layers of skin, fat, blood, and bone. Phantom layer specifications are given in Table II. The height of each layer is also mentioned [26].

TABLE II
FINGER PHANTOM LAYERS

Layers	ϵ_r	$\sigma \text{ s/m}$	h mm
Skin	39.9	1.00	1
Fat	5.41	0.0618	0.5
Blood	60.3	1.73	5
Muscle	12.1	0.196	4

III. RESULTS

The antenna is placed over the arm phantom in the first case. At 1.3 GHz, the blood properties are, $\epsilon_r = 60.3$ and $\sigma = 1.73$ s/m. These values are for normal glucose levels. When glucose levels increase, there is a decrease in the value of ϵ_r and increase in output frequency of antenna [27]. So, by keeping σ value constant and the variation in ϵ_r , output frequency shift is observed. If the glucose level rises, the value of ϵ_r falls, resulting in hyperglycemia. Similarly, if the glucose level decreases the value of ϵ_r rises, resulting in hypoglycemia is achieved.

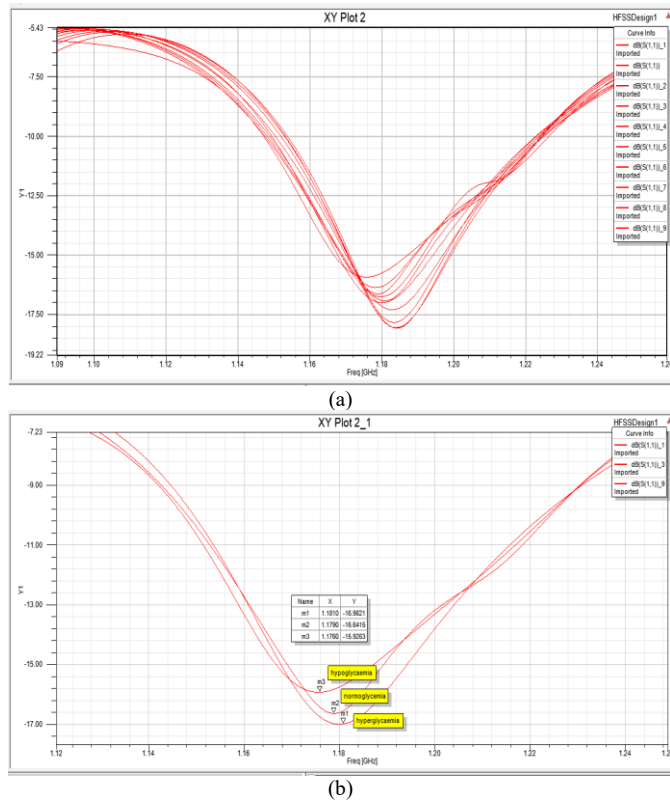

Fig. 10. (a) Frequency shift (b) frequency shift at three different glucose levels using arm phantom at different values of ϵ_r

Fig. 10 (a) shows that when the value of permittivity of blood changes according to Table III, which affects the resonant frequency of the antenna. Table III shows the frequency variation from 1.1760 GHz to 1.1850 GHz. Along with frequency, there is variation in return loss also. These two parameters are very important for finding out the glucose level.

TABLE III
FREQUENCY SHIFT

ϵ_r	σ s/m	f GHz	S ₁₁
64.3	1.73	1.1760	-15.92
62.3	1.73	1.1780	-16.37
60.3	1.73	1.1790	-16.64
58.3	1.73	1.1800	-16.75
56.3	1.73	1.1810	-16.92
54.3	1.73	1.1810	-16.98
52.3	1.73	1.1840	-17.24
50.3	1.73	1.1850	-18.05

For normal glucose levels, ϵ_r is 60.3 at 1.3 GHz [28]. When glucose levels increase, ϵ_r decreases. Table III shows when $\epsilon_r = 54.3, 52.3,$ and 50.3 , which represent decreased values of ϵ_r i-e high glucose levels, and for these values high output frequency is obtained. This condition is considered hyperglycemia. When $\epsilon_r = 62.3$ and 64.3 , which represent increased values of ϵ_r i-e low glucose levels, and low output frequency. This is considered hypoglycemia. So, according to ϵ_r values, Table III is divided into hypoglycemia, normoglycemia, and hyperglycemia levels, which are summarized in Table IV and shown in Fig 10 (b).

TABLE IV
OUTPUT ACCORDING TO BLOOD SUGAR LEVELS

Blood Sugar Levels	f GHz	S ₁₁
hyperglycaemia	1.1810	-16.98
Normal range	1.1790	-16.64
hypoglycaemia	1.1760	-15.92

Similarly, output frequency shift is also measured in the second case, when a finger is placed over the antenna. Fig 11 (a) illustrate the frequency change and change in return loss. The height of the blood layer is greater in the finger phantom than in the arm phantom. So, the frequency shift is maximum in the case of the finger, which is shown in Table V.

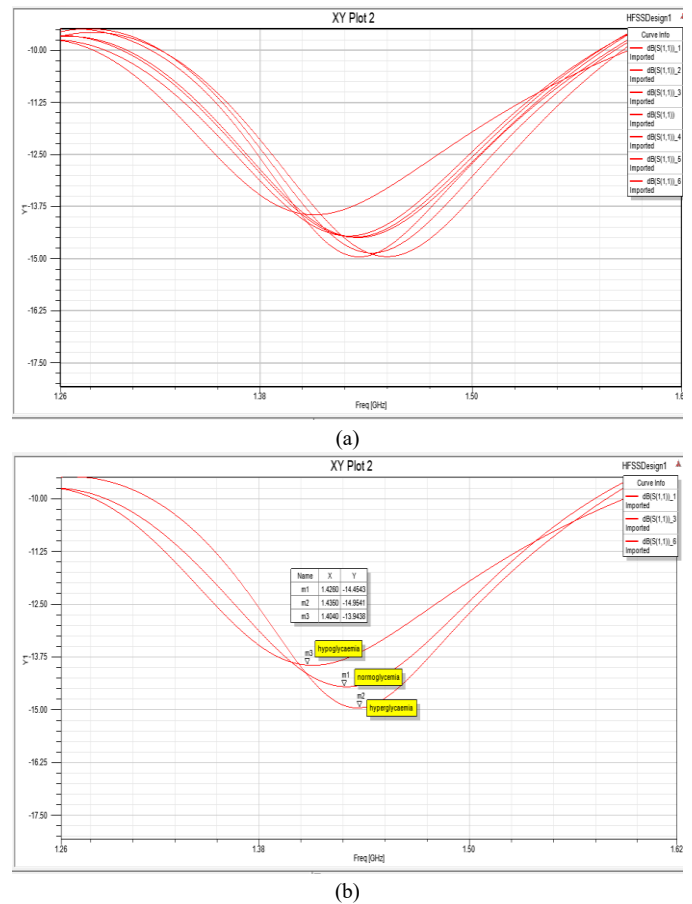

Fig.11. (a) Frequency shift (b) frequency shift at three different glucose levels using finger phantom at different values of ϵ_r

Table V shows the variation in frequency according to the ϵ_r values. When the glucose level falls, ϵ_r rises and the frequency falls; when ϵ_r is 64.3, the output frequency is 1.4040 GHz, indicating hypoglycemia. Similarly, when glucose levels increase and ϵ_r decreases, there is an increment in output frequency. When ϵ_r is 54.3, then the output frequency is 1.4350 GHz. This is the condition of hyperglycemia.

TABLE V
FREQUENCY SHIFT

ϵ_r	σ s/m	f GHz	S_{11}
64.3	1.73	1.4040	-13.94
62.3	1.73	1.4250	-14.40
60.3	1.73	1.4260	-14.45
58.3	1.73	1.4330	-14.49
56.3	1.73	1.4340	-14.48
54.3	1.73	1.4350	-14.95
52.3	1.73	1.4440	-14.85
50.3	1.73	1.4510	-14.94

TABLE VI
OUTPUT ACCORDING TO BLOOD SUGAR LEVELS

Blood Sugar Levels	f GHz	S_{11}
hyperglycaemia	1.4350	-14.95
Normal range	1.4260	-14.45
hypoglycaemia	1.4040	-13.94

Using finger, we can also measure three glucose levels, which are mentioned in Table VI. Fig 11(b) shows the response of three glucose levels.

CONCLUSION

As a function of blood dielectric characteristics, a link between blood glucose level fluctuation and matching resonating frequency shift is seen. If the blood glucose level increases, then there is an increment in output frequency. Results are observed in both cases; one is the antenna placed over the arm and the second is the finger placed over the antenna patch. A maximum frequency shift is obtained when a finger is placed over the antenna patch. A specially designed antenna should be used as a sensor to sense variations in glucose levels and find out hyperglycemia and hypoglycemia levels.

REFERENCES

[1] Schilingovski, Pavel; Vulfin, Vladimir; Sayfan-Altman, Shai; Shavit, Reuven "Wearable antennas design for wireless communication." *IEEE 2017 IEEE International Conference on Microwaves, Antennas, Communications and Electronic Systems (COMCAS)* - Tel-Aviv, Israel, 2017, pp. 1–3. <https://doi.org/10.1109/COMCAS.2017.8244796>

[2] Rais, N. H. M.; Soh, P. J.; Malek, F.; Ahmad, S.; Hashim, N.B.M.; Hall, P.S "A review of wearable antenna." *IEEE Propagation Conference (LAPC)* - Loughborough, UK, 2009, pp. 225–228. <https://doi.org/10.1109/LAPC.2009.5352373>

[3] Pei, Rui; Wang, Jingchen; Leach, Mark; Wang, Zhao; Lee, Sanghyuk; Lim, Eng Gee "Wearable antenna design for bioinformatics." *IEEE Conference on Computational Intelligence in Bioinformatics and Computational Biology (CIBCB)* - Chiang Mai, Thailand, 2016, pp. 1–4. <https://doi.org/10.1109/CIBCB.2016.7758129>

[4] Potey, Pranita Manish; Tuckley, Kushal. "Design of wearable textile antenna with various substrate and investigation on fabric selection." *IEEE 2018 3rd International Conference on Microwave and Photonics (ICMAP)*– Dhanbad, 2018, pp. 1–2. <https://doi.org/10.1109/ICMAP.2018.8354539>

[5] Sreelekshmi, S.; Sankar, S.Perumal "Performance Comparison of Wearable Antennas for Body Centric Wireless Communication." *International Conference on Emerging Trends and Innovations in Engineering And Technological Research (ICETIETR)*, 2018, pp. 1–4. <https://doi.org/10.1109/ICETIETR.2018.8529013>

C. Hertleer, H. Rogier, L. Vallozzi, and L.Van Langenhove, "A textile antenna for off-body communication integrated into protective clothing for firefighters," *IEEE Transactions on Antennas and Propagation*, vol. 57(4), pp. 919–925, 2009. <https://doi.org/10.1109/TAP.2009.2014574>

[6] Klemm, M., & Troester, G. "Textile UWB Antennas for Wireless Body Area Networks." *IEEE Transactions on Antennas and Propagation*, vol. 54(11), pp. 3192–3197, Nov 2006. <https://doi.org/10.1109/TAP.2006.883978>

[7] Zheng, Hui; He, Jing; Li, Peng; Guo, Mengjiao; Jin, Hui; Shen, Jie; Xie, Zhijun; Chi, Chihung. "Glucose Screening Measurements and Noninvasive Glucose Monitor Methods." *Procedia Computer Science*, vol. 139, pp. 613–621, 2018. <https://doi.org/10.1016/j.procs.2018.10.202>

[8] Davis, Stephen N.; Lastra-Gonzalez, Guido. "Diabetes and Low Blood Sugar (Hypoglycemia)." *The Journal of Clinical Endocrinology & Metabolism*, vol 93(8), pp. 0–0. 2008. <https://doi.org/10.1210/jcem.93.8.9993>

[9] Chatterjee S, Khunti K and Davies M J "Type-2- Diabetes". *The Lancet*, vol. 389, pp. 2239-2251, 2017.

[10] Entisar Younis Al-Iraqi, Rashid Ali Fayadh. "Measurement of Non-Invasive Blood Glucose Level by UWB Transceiver in Diabetic Patient Type-1" *IOP Conf. Series: Materials Science and Engineering PEC*, 2020 <https://doi.org/10.1088/1757-899X/1105/1/012071>

[11] Gusev, Marjan; Poposka, Lidija; Spasevski, Gjoko; Kostoska, Magdalena; Koteska, Bojana; Simjanoska, Monika; Ackovska, Nevena; Stojmiski, Aleksandar; Tasic, Jurij; Trontelj, Janez. "Noninvasive Glucose Measurement Using Machine Learning and Neural Network Methods and Correlation with Heart Rate Variability." *Journal of Sensors*, vol.2020, pp.1–13, 2020. <https://doi.org/10.1155/2020/9628281>

[12] Tang, Liu; Chang, Shwu Jen; Chen, Ching-Jung; Liu, Jen-Tsai "Non-Invasive Blood Glucose Monitoring Technology: A Review." *Sensors*, vol. 20(23), pp. 6925, 2020. <https://doi.org/10.3390/s20236925>

[13] Villena Gonzales, Wilbert; Mobashsher, Ahmed; Abbosh, Amin. "The Progress of Glucose Monitoring—A Review of Invasive to Minimally and Non-Invasive Techniques, Devices and Sensors." *Sensors*, vol. 19(4), pp. 800, 2019. <https://doi.org/10.3390/s19040800>

[14] Satish, Sen, Kushal; Anand, Sneha. "Design of microstrip sensor for noninvasive blood glucose monitoring." *IEEE International Conference on Emerging Trends & Innovation in ICT (ICEI)* - Pune, India, 2017, pp. 5–8. <https://doi.org/10.1109/ETICT.2017.7977001>

[15] Shorav Khan Vinod Kumarsingh, Naresh.B "Textile Antenna Using Jeans Substrate for Wireless Communication Application" *International Journal of Engineering Technology Science and Research IJETSRS*, vol. 2, pp. 2394 –3386, November 2015.

[16] Christina, G.; Rajeswari, A.; Lavanya, M.; Keerthana, J.; Ilamathi, K.; Manoranjitha, V. "Design and development of wearable antennas for tele-medicine applications" *IEEE International Conference on Communication and Signal Processing (ICCSPP)* - Melmaruvathur, Tamilnadu, India, 2016 pp. 2033–2037. <https://doi.org/10.1109/ICCSPP.2016.7754532>

[17] A. P. Ghodake and H. B. Sale, "Gain Enhancement of Microstrip Antenna," *International Conference on Advanced Computation and Telecommunication (ICACAT)*, 2018, pp. 1-6.

[18] Mohammad Faisal, Abdul Gafur, Syed Zahidur Rashid, Md. Omar Faruk Shawon, Kazi Ishtiaq Hasan, Md. Bakiy Billah, "Return Loss and Gain Improvement for 5G Wireless Communication Based on Single Band Microstrip Square Patch Antenna", *1st International Conference on Advances in Science, Engineering and Robotics Technology (ICASERT)*, 2019, pp. 1 - 5. <https://doi.org/10.1109/ICASERT.2019.8934474>

[19] Ramli, Muhammad Nazrin; Soh, Ping Jack; Rahim, Hasliza A.; Jamlos, Mohd Faizal; Gimam, Fatin Nabilah; Hussin, Ezzaty Faridahnor Mohd; Lago, Herwansyah; Van Lil, Emmanuel "SAR for wearable antennas with AMC made using PDMS and textiles." *IEEE XXXII Ind General Assembly and Scientific Symposium of the International Union of Radio Science*, Montreal, QC, Canada, 2017, pp. 1–3. <https://doi.org/10.23919/URSIGASS.2017.8105353>

[20] Usman Ali, Sadiq Ullah, Jalal Khan, Muhammad Shafi, Babar Kamal, Abdul Basir, James A Flint, Rob D. Seage "Design and SAR Analysis of Wearable Antenna on Various Parts of Human Body, Using

- Conventional and Artificial Ground Planes” *Journal of electrical engineering and technology*, vol 12, pp. 317-328, December 2016. <https://doi.org/10.5370/JEET.2017.12.1.317>
- [21] Ashwal, Wadhah Abdo Mohammed Al; Ramli, Khairun Nidzam “Compact UWB wearable antenna with improved bandwidth and low SAR.” IEEE International RF and Microwave Conference (RFM), Penang, Malaysia, 2013, pp. 90–94. <https://doi.org/10.1109/RFM.2013.6757225>
- [22] Afyf, Amal; Elouergui, Achraf; Afyf, Maroua; Sennouni, M. Adel; Bellarbi, Larbi “Flexible Wearable Antenna for Body Centric Wireless Communication in S-Band.” IEEE International Conference on Electrical and Information Technologies (ICEIT), Rabat, Morocco, 2020, pp. 1–4. <https://doi.org/10.1109/ICEIT48248.2020.9113217>
- [23] Samal, Purna B.; Soh, Ping Jack; Zakaria, Zahriladha “Compact Microstrip-Based Textile Antenna for 802.15.6 WBAN-UWB with Full Ground Plane.” *International Journal of Antennas and Propagation*, vol. 2019, pp. 1–12, 2019. <https://doi.org/10.1155/2019/8283236>
- [24] Freer, Benjamin; Venkataraman, Jayanti. “Feasibility study for non-invasive blood glucose monitoring.” *IEEE International Symposium Antennas and Propagation and CNC-USNC/URSI Radio Science Meeting*, 2010, pp. 1–4. <https://doi.org/10.1109/APS.2010.5561003>
- [25] Sethi, W.T.; Ashraf, M.A.; Alshebeili, S.A.; Issa, K. “Thumb positioning analysis of new elliptical-shaped microwave sensors for non-invasive glucose monitoring.” *Electronics Letters*, vol. 54(9), pp. 553–554, 2018. <https://doi.org/10.1049/el.2018.0128>
- [26] Álvaro Rocha, Hojjat Adeli, Luís Paulo Reis, Sandra Costanzo “New Knowledge in Information Systems and Technologies” *Springer Nature Switzerland*, vol3, pp. 287–291, 2019. <https://doi.org/10.1007/978-3-030-16181-1>
- [27] <https://itis.swiss/virtual-population/tissue-properties/database/>