

Optical Wireless Communications Operated at Long-Wave Infrared Radiation

Janusz Mikolajczyk, Dariusz Szabra, Artur Prokopiuk, Krzysztof Achtenberg,
Jacek Wojtas, and Zbigniew Bielecki

Abstract – This paper presents some construction analysis and test results of a Free Space Optics system operating at the wavelength of 9.35 μm . In the system, a quantum cascade laser and a photoreceiver with mercury cadmium telluride photodetectors were used. The main parameters of these elements were discussed taking into account a data link operation. It also provides to determine a data range for various weather conditions related to scattering and scintillation. The results of numerical analyses defined the properties of currently available FSO technologies working in the near infrared or in the short infrared range of spectrum versus the performances of the developed system. The operation of this system was verified in three different test environments. The obtained results may also contain important issues related to the practical application of any FSO system.

Keywords—optical wireless communications, free space optics, quantum cascade lasers, optoelectronics, telecommunications

I. INTRODUCTION

FREE Space Optics (FSO) provides an optical communication link between two points in so-called Line-On-Sight (LOS) configuration. To send data, modulated optical radiation is used. The first demonstration of this technology was presented by A.G. Bell in 1880. He developed a photophone to carry voice signals at the distance of about 200 meters using modulated solar radiation [1]. Although the first commercial FSO link was used to service air traffic in 1970, the dynamic development of FSO systems did not occur until the late 1970s'. The progress in laser source technology made it possible to construct unique wireless communication tools characterized by:

- high data rate,
- high security of financial, legal, military and other confidential data transfer,
- free of charge operation (without any licenses of the Federal Communications Commission) or the lack of frequency allocation,
- compact construction and low-energy consumption,
- portable design, ease and fast installation.

FSO technology does not displace radio technology (RF - Radio Frequency). However, in some cases it can be treated as an alternative method of data transfer. It has also some practical limitations. For example, there is need to provide LOS conditions for data transfer. If this is not assured, information loss may occur. Moreover, bad weather conditions also influence on the temporary errors in FSO operation.

Nowadays, FSO technology is mainly dedicated for special applications, e.g. wireless military communications to provide high speed and secure data transfer [2]. In space research centers, there were some ideas to apply an optical communication to ensure continuous contact with space expeditions, such as missions on Mars and lunar probes. For a long time, FSO technology could not find any support of reliable communication networks because of the market domination by existing radio and microwave infrastructures. FSO systems were also considered as non-attractive communication devices due to their limited availability. This availability is determined by operation conditions such weather conditions and LOS requirement. For example, strong dispersion and attenuation of light can be observed in the case of fog, rain, snow, and atmospheric turbulences [3]. However, increasing demand for high data rate and decreasing radio spectra resources cause to increase the interest in development of FSO technology. In these scenarios, the FSO device can be an alternative to RF links for data and voice transmission using license-free spectra. Therefore, it can be used for short-range communication, especially as "last mile" link. In this configuration, FSO link connects the end-user with the existing network node. Atmospheric interferences are the most important challenge for this technology. However, the FSO device in hybrid combination with RF one can create a future solution. It makes possible to accommodate performances of radio links (limited bandwidth) and optical one (weather sensitivity) providing data link availability of 99.999% [4]. In practice, this hybrid configuration is constructed updating existed RF systems with additional FSO devices. Such hybrid link can be used in:

- LAN-LAN connection in housing estates or camps equipped with Fast-Ethernet or Gigabit-Ethernet,
- LAN-LAN connection in the wide area network,
- ad-hoc access to high bandwidth fiber networks,
- on-demand network installation (for special tasks),
- quick recovery of the link (Disaster Recovery-Emergency),
- communication between land and spacecraft or between spacecrafts, including elements of the satellite constellation.

The article presents test results of the developed optical head used in the hybrid FSO/RF link. It is unique design resulting from its operating wavelength range. This range is determined by applied quantum cascade lasers (QCL) and mercury cadmium telluride (MCT) heterojunction detectors operating

This work was prepared in the frame of the grant UGB/22-786/2020/WAT.

Authors are with Military University of Technology, Warsaw, Poland,
(e-mail: janusz.mikolajczyk@wat.edu.pl).



in longwave infrared radiation (LWIR). It provides link sensitivity reduction to adverse atmospheric conditions, probability of link detection or data interception comparing commercially used FSO devices operated in the near infrared (NIR) or short infrared (SWIR) radiation range [5].

II. LWIR DATA LINK CONSTRUCTION

The main task of any FSO system is to send data from its transmitter to its receiver using atmospheric channel at an acceptable rate of data and errors. In practice, the FSO transmitter consists of a radiation source (laser or light-emitting diode), driver (to supply the radiation source), modulator (to implement the selected type of modulation), and a transmit optics. In practice, the modulator converts data into an electrical signal driving the radiation source. Transmit optics shapes the beam to reduce e.g. its divergence. Radiation beam is transmitted through the atmosphere and registered by the receiver. The receiver consists of a receive optics, photoreceiver, and data decoding unit. The receiver optics focuses radiation on the photodetector surface. The registered photons are converted into an electrical signal. A block diagram of a typical FSO link is presented in Fig. 1.

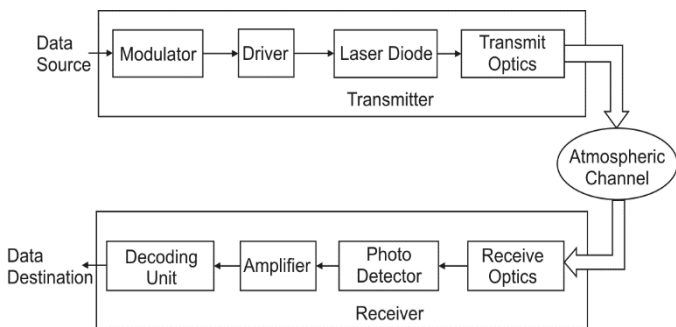

Fig. 1. Scheme of the FSO data link.

As the radiation source, quantum cascade laser generated light at the wavelength of 9.35 μm were used in the developed FSO link (Fig. 2a). These lasers were developed at the Institute of Electron Technology (ITE) in Warsaw in the science group of prof. M. Bugajski [6]. Figure 2b presents light-current-voltage characteristics of the applied QCL.

Research on the time-energy characteristics of laser pulses enabled to define the optimal operation point of QCL (ITE). There was compromise between pulse peak power and its pulse time duration. The best results were obtained for the pulse frequency of 4 MHz and its time duration of 16 ns. These data were initially implemented in the modulation method of optical radiation.

The modulation PPM-5 (Pulse-Position Modulation) was used. A special transmission protocol has been developed to provide not only data transfer but also to perform error correction, bit error rate (BER) analysis, and monitoring the FSO link operation state. Due to the geometrical parameters of the laser beam, an off-axis parabolic mirror with the diameter of 2 inches (Edmund Optics) in the transmitter was used.

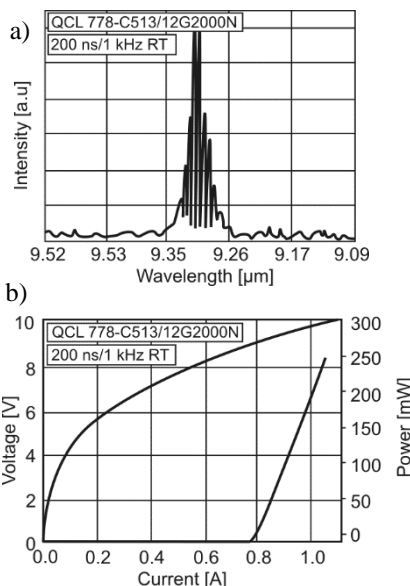

Fig. 2. Light-current-voltage (a) and spectral emission characteristics (b) of the applied QCL (ITE).

In the FSO receiver, detection module PVI-4 series (VIGO System S.A.) was used for recording the optical pulses. The module consists of a polarized MCT photovoltaic detector and a two-stage low-noise TIA preamp. The module parameters are listed in Table I and its spectral detectivity is shown in Fig. 3.

TABLE I
PARAMETERS OF DETECTION MODULE

Parameter	Value
Transimpedance	17.5 kV/A
Low cut-off frequency	1 kHz
High cut-off frequency	198 MHz
Output noise density	305 nV/ $\sqrt{\text{Hz}}$
Detectivity	$6.7 \cdot 10^9 [\text{cm}\sqrt{\text{Hz}/\text{W}}]$

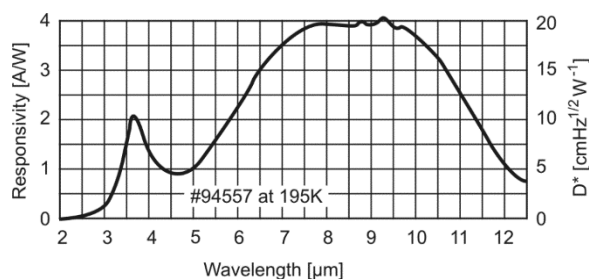

Fig. 3. Spectral detectivity and responsivity of the applied detection module [7].

The transmitted radiation is focused on the detector surface using an off-axis 4-inch parabolic mirror (Edmund Optics). Transmitter and receiver components are mounted in a common housing head (Fig. 4).

The special construction provides independent control of the position of transmitting and receiving optical axes. It this way, the possibility to work not only in the Point-To-Point connection configuration, but also in the Ring one is applied.

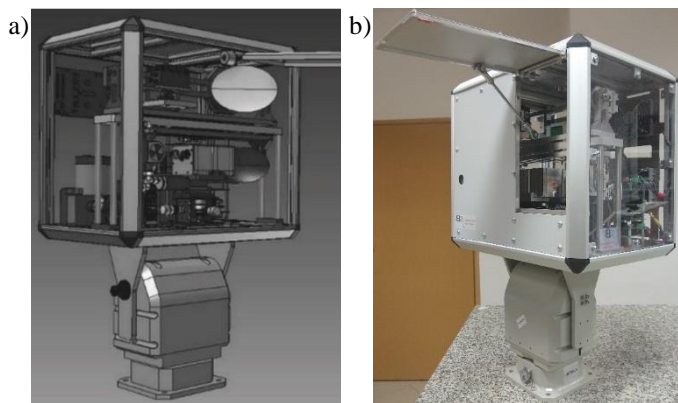

Fig. 2. 3D model and view of the developed head of FSO data link.

The parameters of the FSO data link are listed in Table II. The laboratory tests shown that the described configuration of FSO components ensures data transmission with the data rate of 10 Mb/s.

TABLE II
FSO DATA LINK PARAMETERS

Parameter	Value
Peak pulse power	500 mW
Beam divergence	1 mrad
Detectivity	$10^9 \text{cm}^2/\text{Hz/W}$
Detector active area	$0.5 \times 0.5 \text{ mm}$
Diameter of receiver optica	4"
Bandwidth	200 MHz
Data rate	10 Mb/s
Link range [BER= 10^{-6}]	2 km

III. FSO DATA LINK RANGE

Based on the FSO system parameters, the analyzes of the LWIR link range were performed. The obtained characteristics were related to results estimated for NIR and SWIR optical wireless link. The impact of radiation scattering and scintillation in analytical calculation was considered. In the simplest approximation, the effects of scattering are determined by visibility described by e.g. the Kruse model [8]. Influences of absorption, scattering and scintillation on the FSO link range has been described in [9]. Figure 5 presents influence of visibility on extinction coefficient for three wavelength ranges determined by analytical model. If wavelength increases, the effect of scattering is being decreased.

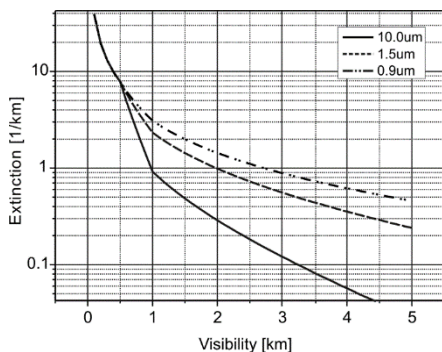

Fig. 5. Extinction characteristics versus visibility for three wavelengths.

Scintillation is another important factor decreasing range of the data link. Currently, there are many analytical models to estimate their level [10]. It results directly from the complexity of this phenomenon. Scintillation level depends on many factors, e.g. temperature distribution, air pressure, wind speed, height above ground, and even the type of this ground. The scintillation can be defined by the value of the structural coefficient C_n^2 . This coefficient varies in the range from $10^{-13} \text{m}^{-2/3}$ to $10^{-17} \text{m}^{-2/3}$. The value range defines strong and negligible scintillations, respectively. The estimated BER changes for two levels of scintillation $C_n^2=10^{-13} \text{m}^{-2/3}$ and $C_n^2=10^{-15} \text{m}^{-2/3}$ were determined. These calculations were performed for good weather conditions (Vis better than 5 km) and three wavelengths.

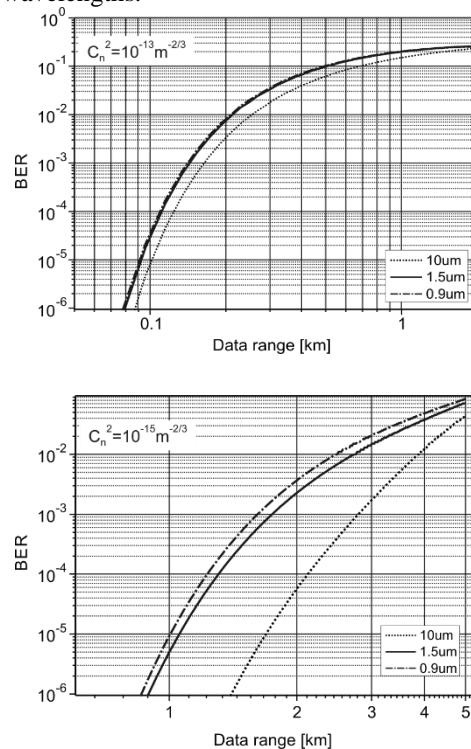

Fig. 6. BER vs. data range for different radiation wavelengths and scintillation of $C_n^2=10^{-13} \text{m}^{-2/3}$ and $C_n^2=10^{-15} \text{m}^{-2/3}$.

For low scintillation levels, the choice of laser wavelength is very important. Thus, the use of LWIR FSO system will significantly improve data link range. As the scintillation level increases, BER differences for FSO devices operated in NIR, SWIR and LWIR spectrum decrease. For the generally accepted requirements for optical wireless data transmission systems (BER= 10^{-4}), the range of the developed link in good weather conditions (low scintillation, good visibility, no rainfall) is about 2 km. However, for strong scintillation ($C_n^2=10^{-13} \text{m}^{-2/3}$) there is no difference between the ranges of the analyzed FSO devices. In this scenario, the link range is very short, ca. 100 m.

IV. EXPERIMENTAL RESULTS

Tests of the FSO link were performed for various conditions of laser pulses propagation during the summer, 2019. These conditions were defined by selection of measurement places. The BER value was determined by a special algorithm using a pseudo-random generator developed by KenBIT company. The first measurements were carried out in the campus of

the Military University of Technology (MUT). The visibility was of over 5 km and the link distance of 800 m. The FSO system heads were located about 1.5 m from the surface of the asphalt road. Research was performed in the morning to minimize the impact of turbulence. The received signals were recorded and BER was measured over time of 3-5 minutes. Figure 7 shows a view of the measurement conditions (clear air) and an example of recorded pulses (yellow line). The red line presents fluctuation of the pulse's amplitude. In that scenario, the link provided data rate of 10 Mb/s without any interruptions. Additionally, the data transmission did not require any error correction.

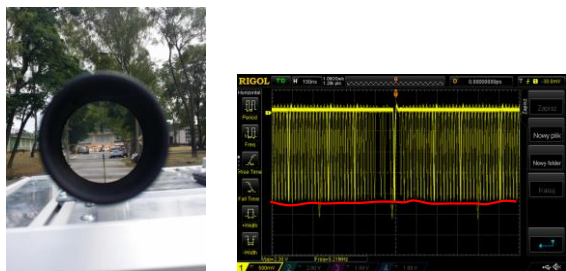

Fig. 7. View of the operation conditions of the FSO link located at the campus of the MUT and the shape of recorded pulses.

The same tests were performed during procedure for the link range determination. The procedure was performed along a local road at the distance of about 1.8 km. In this case, the conditions for radiation propagation have changed, significantly (Fig. 8). There were observed very strong scintillations resulting directly from high heating of the road surface and the wind. This impact is illustrated by strong fluctuations in the registered pulses.



Rys. 8. View of the operation conditions of the FSO link placed at the local road and the shape of registered pulses.

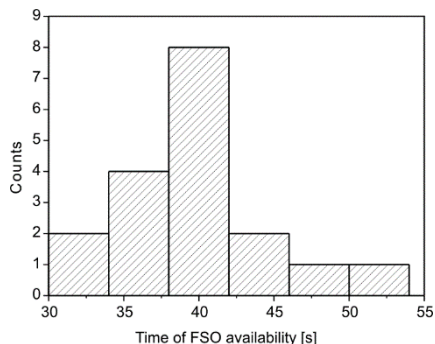

Fig. 9. Histogram of the FSO link availability placed along local road.

During that tests, the temporary changes of BER value were also measured. Figure 9 presents a histogram obtained results. The histogram estimates time of continuous operation of the link, for which the BER is better than its threshold value of 10^{-6} . Based on these tests, estimated value of the link availability was about 20%.

The last tests were performed with the FSO devices located on two banks of the water reservoir (Zegrzynski Lagoon). That scenario was accepted to ensure stable operating conditions of the link (no scintillation). The distance between the transmitter and receiver was about 1.6 km. The laser beam propagated at the distance of 1.5 m from the water surface. Figure 10 shows the view of the test conditions and the recorded oscillogram.

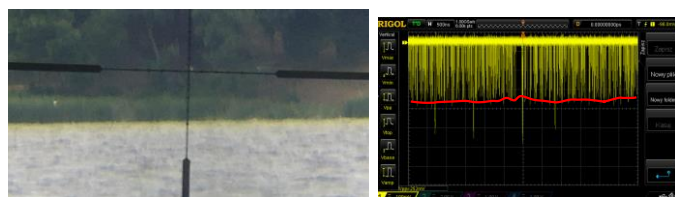

Fig. 10. View of the operation conditions of the FSO link located near the Zegrzynski Lagoon and the shape of recorded pulses.

The shapes of the recorded pulses are more stable than signals obtained along the local road. Long-term observation indicated that these signals are attenuated, i.e. both amplitude and fluctuations are reduced. There is noticed greater effect of scattering, which was the result of the appearance of a strong wind and the formation of a breeze above the water surface. Figure 11 presents the histogram determining the link availability.

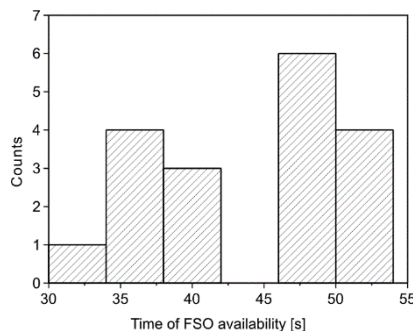

Fig. 11. Histogram with the availability of the FSO link placed near the Zegrzynski Lagoon.

Although lower signal noise was obtained, but the link availability was slightly higher comparing results from the local road. In this case, the availability was about 30% and had a slightly different character. During the research on the local road, high dynamic attenuation of the signal (signal fluctuations) was noticed. However, above the water surface with a breeze, signal oscillations were much less common. This confirms that there is a strong scattering of laser radiation from the water molecules forming the breeze above the lagoon surface.

CONCLUSIONS

Laser communication in open space is a perspective direction for the wireless network development. The presented analyzes showed that FSO links can be an effective complement to the capabilities of currently used RF radio networks. However, a special attention should be paid to their operation conditions. The strong influence of atmospheric conditions could limit their scope of applications or forces the use of special elevating platforms to minimize the effect of scintillations. The presented results are unique due to the selected wavelength for the FSO device design and the harsh test conditions. Currently, it is difficult to find in the literature information on achieving similar transmission ranges using quantum cascade lasers, especially in such varied and very difficult conditions considering an optical signal transmission.

REFERENCES

- [1] O. Wilfert, H. Henniger, and Z. Kolka, "Optical communication in free space," in *Proc. 16th Polish-Slovak-Czech Opt. Conf. Wave Quantum Asp. Contemp. Opt.* 7141, 714102 (2008).
- [2] J. Mikołajczyk, D. Szabra, Z. Bielecki, R. Matyszekiel, and B. Grochowina, "Optical-radio hybrid technology in military wireless communication systems", in *Proc. SPIE* 11055, XII Conference on Reconnaissance and Electronic Warfare Systems, 1105506, doi: 10.1117/12.2524431, 2019
- [3] S. Rajbhandari, Z. Ghassemlooy, J. Perez, H. Le Minh, M. Ijaz, E. Leitgeb, G. Kandus, and V. Kvicera, "On the study of the FSO link performance under controlled turbulence and fog atmospheric conditions," in *Proc. 11th Int. Conf. Telecommun. ConTEL*, 2011.
- [4] T.H. Ho, S. Trisno, A. Desai, J. Llorca, S.D. Milner, and Ch.C. Davis, "Performance and analysis of reconfigurable hybrid FSO/RF wireless networks", in *Proc. SPIE* 5712, Free-Space Laser Communication Technologies XVII, doi: 10.1117/12.592820, April 2005.
- [5] T. Plank, E. Leitgeb, P. Pezzei, and Z. Ghassemlooy, "Wavelength-selection for high data rate Free Space Optics (FSO) in next generation wireless communications," in *Proc. 17th Eur. Conf. Networks Opt. Commun.*, 1–5, DOI: 10.1109/NOC.2012.6249909, IEEE, 2012.
- [6] P. Gutowski, P. Karbownik, A. Trajnerowicz, K. Pierściński, D. Pierścińska, I. Sankowska, J. Kubacka-Traczyk, M. Sakowicz, M. Bugajski, "Room-temperature AlInAs/InGaAs/InP quantum cascade lasers", *Photonics Letters of Poland* 6 (4), doi: 10.4302/plp.2014.4.10, pp.142-144, 2014.
- [7] P. Kalinowski, J. Mikołajczyk, A. Piotrowski, and J. Piotrowski, "Recent advances in manufacturing of miniaturized uncooled IR detection modules," *Semicond. Sci. Technol.* 34(3), 33002, DOI: 10.1088/1361-6641/aaf458, 2019.
- [8] S. Mughal, S. Shah, S. Afridi, M.I. Bhatti, and Y. Sandhu, "Analysis/Simulation of Unavailability of FSO Link Due to FOG in Karachi & Lahore," *Int. J. Eng. Innovation Res.* 1, pp. 567–573, 2012.
- [9] J. Mikołajczyk, Z. Bielecki, M. Bugajski, J. Piotrowski, J. Wojtas, W. Gawron, D. Szabra, and A. Prokopiuk, "Analysis of free-space optics development," *Metrol. Meas. Syst.*, vol. 24 (4), pp. 653-674, doi: 10.1515/mms-2017-0060, 2017.
- [10] A. Ahmed, S. Gupta, Y. Luthra, K. Gupta, and S. Kaur, "Analysing the Effect of Scintillation on Free Space Optics Using Different Scintillation Models," in *Proc. 6th Int. Conf. Signal Process. Integr. Networks*, pp. 799–804, 2019.