

Electronic Thesis and Dissertation Repository

12-13-2013 12:00 AM

Production of Lignin-Based Phenolic Resins Using De-Polymerized Kraft Lignin and Process Optimization

Homaira Siddiqui
The University of Western Ontario

Supervisor
Charles Xu
The University of Western Ontario Joint Supervisor

Ajay Ray
The University of Western Ontario

Graduate Program in Chemical and Biochemical Engineering
A thesis submitted in partial fulfillment of the requirements for the degree in Master of
Engineering Science
© Homaira Siddiqui 2013

Follow this and additional works at: <https://ir.lib.uwo.ca/etd>

 Part of the [Biomaterials Commons](#), and the [Polymer Science Commons](#)

Recommended Citation

Siddiqui, Homaira, "Production of Lignin-Based Phenolic Resins Using De-Polymerized Kraft Lignin and Process Optimization" (2013). *Electronic Thesis and Dissertation Repository*. 1808.
<https://ir.lib.uwo.ca/etd/1808>

This Dissertation/Thesis is brought to you for free and open access by Scholarship@Western. It has been accepted for inclusion in Electronic Thesis and Dissertation Repository by an authorized administrator of Scholarship@Western. For more information, please contact wlsadmin@uwo.ca.

PRODUCTION OF LIGNIN-BASED PHENOLIC RESINS USING DE-
POLYMERIZED KRAFT LIGNIN AND PROCESS OPTIMIZATION

(Thesis format: Integrated Article)

By

Homaira Siddiqui

Graduate Program in Chemical and Biochemical Engineering

A thesis submitted in partial fulfillment
of the requirements for the degree of
Master of Engineering Science

The School of Graduate and Postdoctoral Studies
The University of Western Ontario
London, Ontario, Canada

© Homaira Siddiqui 2013

Abstract

Commercialization of Lignin-based phenol formaldehyde resins (LPF) has been limited due to the increase in curing temperatures and decrease in adhesive strength of LPF compared to conventional phenolic resins. Lignin depolymerization can increase the reactivity of lignin; however, the effect of lignin molecular weight on curing performance of LPF resins has yet to be investigated. This research work examined the optimization of synthesis parameters including percent substitution of phenol with lignin, formaldehyde-to-phenol ratio (F/P), and Mw of lignin to reduce the curing temperature and increase the adhesive strength of LPF. DSC analysis indicated that lignin with Mw ~1200g/mol resulted in lowest curing temperature for 75%-LPF while requiring F/P of less than 3. Highest adhesive strength of ~9MPa was attained for 50%-LPF synthesized with F/P of 3 and lignin with high Mw. Incorporation of lignin likely facilitated higher molecular contact and enhanced entanglement; however, it could also increase steric hindrance effects.

Keywords: Adhesives, phenol-formaldehyde, Lignin, LPF, optimization, natural polymers, bio-resins

Co-Authorship Statement

Chapters 5 and 6 are article manuscripts that will be submitted to peer reviewed journals. The contribution of each author is stated below.

Chapter 5: Synthesis of Lignin-based PF (LPF) Resoles at Large Phenol Substitution Ratios using De-polymerized Lignin from Hydrolytic Depolymerization of Kraft Lignin: Adhesive Strength

Authors: Homaira Siddiqui, Chunbao (Charles) Xu, Ajay Ray, Zhongshun (Sean) Yuan, Shanghuan Feng, Shuna Cheng, Amin Rizkalla

Status: To be submitted to Journal of Applied Polymer Science

Experimental work and data analysis were performed by Homaira Siddiqui. Chunbao (Charles) Xu, Ajay Ray, Zhongshun Yuan, Shanghuan Feng, Shuna Cheng and Amin Rizkalla, who also provided consultation regarding experimental work and interpretation of results. The manuscript was written and revised by Homaira Siddiqui, and reviewed by Chunbao (Charles) Xu, Ajay Ray, and Zhongshun Yuan.

Chapter 6: Synthesis of Lignin-based PF (LPF) Resoles at Large Phenol Substitution Ratios using De-polymerized Lignin from Hydrolytic Depolymerization of Kraft Lignin: Synthesis Parameter Optimization for Curing Temperature

*Authors: Homaira Siddiqui, Ajay Ray, Chunbao (Charles) Xu, Zhongshun (Sean) Yuan
Nubla Mahmood*

Status: To be submitted to Journal of Applied Polymer Science

Experimental work and data analysis were performed by Homaira Siddiqui. Ajay Ray, Chunbao (Charles) Xu, Zhongshun Yuan and Nubla Mahmood, who also provided consultation regarding experimental work and interpretation of results. The manuscript was written and revised by Homaira Siddiqui, and reviewed by Ajay Ray, Chunbao (Charles) Xu, and Nubla Mahmood.

Acknowledgement

I would like to express my deepest gratitude to my supervisors, Dr. (Chunbao) Charles Xu and Dr. Ajay Ray, for their exceptional support and guidance throughout my study period. Dr. Xu has motivated me to continue to strive for excellence particularly during the most challenging times and has been incredibly patient with me as I attempted to meet the pressing deadlines. Dr. Ray has ever so generously provided me with his kind understanding and uplifting support. Most of all, I wholeheartedly appreciated his inspiring outlook on life and his genuine interest in his students. I would also like to express my appreciation to Dr. Zhongshun (Sean) Yuan for offering his expert advise on my data analysis and for his patience with me during my experimental work.

My colleagues, the faculty, and staff from Institute for Chemicals and Fuels from Alternative Resources (ICFAR) as well from Western University have been a tremendous source of support for me. Special thanks to Shuna Cheng, Nubla Mahmood, Shanghuan Feng, Ferdinando Crapulli for guiding me and offering thoughtful commentary and suggestions. I would also like to thank and acknowledge Michael MacKenzie and Shanhua Huang for assisting me in my experimental work during the earlier stages.

I would like to acknowledge Carrie Hay and Steve Barlett from for granting me access to the Biotron Experimental Climate Change Research Center for use of the environmental chambers, Dr. Rizkalla for graciously allowing me to use the Universal Testing Machine in his lab, Ian Vinkenvleugel and Clayton Cook from the University Machine Services for accommodating my urgent requests without delay, Hossein Kazemian for allowing me to use the Viscometer in Dr. Rohani's lab, and Jaydevsinh Gohil for granting me access to the Hot Press in Dr. Karamanev's even during the most inconvenient times.

My parents, Omyjaan and Babajaan, have provided me with their unconditional love and heartwarming support at all times. This work is dedicated to them, and to Hamida, Mahmoda, Bilal, Hilal, Hamad, Omar, Sulaiman, and Marwa. My friends have offered their smiles, words of encouragements, and prayers. Their contribution has touched my heart and motivated me during the most difficult times.

Table of Contents

Abstract	ii
Co-Authorship Statement.....	iii
Acknowledgement.....	iv
List of Tables.....	vii
List of Figures	viii
Chapter 1: Introduction	1
1.1. Background.....	1
1.2. Substitution for Phenol with Lignin	3
1.3. LPF Resin Synthesis Parameters	5
1.4. Objectives	6
1.5. Thesis Structure.....	7
1.6. References	8
Chapter 2: Literature Review	1
2.1. History and Background of Adhesives	1
2.1.1. Natural Adhesives	1
2.1.2. Synthetic Adhesives.....	3
2.2. Phenol-Formaldehyde (PF) Resins:	5
2.2.1. PF Resole Synthesis and Curing.....	6
2.3. PF Synthesis and Curing Parameters	9
2.4. Bio-based Phenolic Resins	11
2.5. Lignin-based phenol formaldehyde (LPF) resins	15
2.6. Lignin Modification Techniques	15
2.6.1. Methylation and Phenolation	16
2.6.2. Lignin Thermolysis Techniques	17
2.7. Concluding Remarks.....	19
2.8. References	20
Chapter 3: Synthesis of Lignin-based PF (LPF) Resoles at Large Phenol Substitution Ratios using De-polymerized Lignin from Hydrolytic Depolymerization of Kraft Lignin: Physical Properties.....	26
3.1. Introduction	26
3.3. Experimental	29
3.3.1. Design of Experiments.....	29
3.3.2. Materials	31
3.3.4. Synthesis of LPF resoles	32
3.3.5. DL and LPF Product Characterizations	33
3.4. Results and Discussion	34
3.4.1. Effect of Reaction Severity on DL yield and Mw	34
3.4.2. Effect of Reaction Severity on Elemental Compositions of DL Products.....	36
3.4.3. Viscosity Measurements for LPF Resoles.....	37
3.4.4. NVC and pH measurements of LPF Resoles	40
3.5. Conclusions	42
3.6. References	43

Chapter 4: Synthesis of Lignin-based PF (LPF) Resoles at Large Phenol Substitution Ratios using De-polymerized Lignin from Hydrolytic Depolymerization of Kraft Lignin: Thermal Curing Behaviours	46
4.1. Introduction	46
4.2. Experimental Section	48
4.3. Results and Discussion	48
4.3.1. Effect of Formaldehyde-to-Phenol Ratio on LPF Curing Temperatures	49
4.3.2. Effect of Percent Substitution on LPF Curing Temperatures	52
4.3.3. Effect of Lignin depolymerization on LPF Curing Temperatures.....	53
4.4. Conclusions	57
4.5. References	57
Chapter 5: Synthesis of Lignin-based PF (LPF) Resoles at Large Phenol Substitution Ratios using De-polymerized Lignin from Hydrolytic Depolymerization of Kraft Lignin: Adhesive Strength	60
5.1. Introduction	60
5.2. Experimental Section	62
5.2.1. Materials and Equipment	62
5.2.2. Procedure	62
5.3. Results and Discussion	64
5.3.1. Obtaining maximum shear stress values from stress-strain curves.....	64
5.3.2. Effect of LPF synthesis parameters on maximum shear stress	65
5.3.2. Wood Failure	70
5.5. Conclusions	71
5.7. References	72
Chapter 6: Synthesis of Lignin-based PF (LPF) Resoles at Large Phenol Substitution Ratios using De-polymerized Lignin from Hydrolytic Depolymerization of Kraft Lignin: Synthesis Parameter Optimization for Curing Temperature	74
6.1. Introduction	74
6.2. Experimental Procedure	75
6.2.1. Box-Behnken Design (BBD).....	75
6.3. Results and Discussion:	77
6.3.1. Model Building and Regression Adequacy	77
6.3.2. Interaction Effects	80
6.3.3. Surface and Contour Plots	81
6.3.3.1. Effect of F/P and Lignin Mw at Constant Percent Substitutions (25%, 50%, 75%) on Curing Temperatures	81
6.3.3.2. Effect of Percent Substitutions and Lignin Mw at Constant F/P ratios (1.2, 2.1, 3) on Curing Temperatures	84
6.3.3.3. Effect of Percent Substitutions and F/P at Lignin Mw (800g/mol and 1700g/mol) on Curing Temperatures	84
6.4. Conclusions	87
6.5. References	87
Chapter 7: Conclusions and Recommendations on Future Work	89
Curriculum Vitae	92

List of Tables

Table 1- 1: Typical physical properties of PF resins for plywood adhesives (Pizzi, 2003)	1
Table 3- 1: Three parameters and three levels of the Box-Behnken experimental design	30
Table 3- 2: Experimental runs using a Box-Behnken Design (BBD) of experiments	30
Table 3- 3: Set reaction temperatures and residence times corresponding to target lignin molecular weight levels	32
Table 3- 4: GPC-UV derived relative molecular weight (Mw) and percent yield of the three depolymerized lignin levels	35
Table 3- 5: Elemental compositions of Kraft Lignin (KL) and DL products obtained from hydrolysis at reaction temperatures of 250°C and 350°C, both for 45 min.	36
Table 3- 6: Room temperature viscosities of all LPF resoles synthesized in this study	38
Table 3- 7: Viscosities of LPF resoles with increasing phenol substitution (left to right)	38
Table 3- 8: Viscosities of LPF resoles with increasing F/P molar ratio (left to right)	38
Table 3- 9: Viscosities of LPF resoles with increasing Mw of the DL used (left to right)	39
Table 3- 10: NonVolatile Content (NVC) of LPF resoles with varying phenol percent substitutions (left to right)	40
Table 3- 11: NonVolatile Content (NVC) of LPF resoles with increasing F/P molar ratios (left to right)	41
Table 3- 12: NonVolatile Content (NVC) of LPF resoles with increasing Mw of DL (left to right)	41
Table 4- 1: Curing Temperatures of LPF resoles at increasing F/P molar ratios (left to right)	49
Table 4- 2: Curing Temperatures of LPF resoles at increasing percent substitutions (left to right)	53
Table 4- 3: Curing temperatures of LPF resoles with increasing DL Mw (left to right)	54
Table 5- 1: Maximum Shear Stress of LPF resoles at increasing Mw of DL (left to right)	65
Table 5- 2: Maximum Shear Stress of LPF resoles at increasing phenol percent substitutions (left to right)	66
Table 5- 3: Table 5-3: Maximum Shear Stress of LPF resoles at increasing F/P molar ratios (left to right)	66
Table 6- 1: Coded Values of the Variables for the Box-Behnken Design	75
Table 6- 2: Box-Behnken Design Matrix for the effect of phenol-to-lignin substitution, (x_1) Lignin Mw (x_2).F/P molar ratio (x_3) on the Curing Temperature (°C) of LPF resoles including experimental results	76
Table 6- 3: Statistical Significance of the Coefficient of the Regression	78
Table 6- 4: Analysis of Variance (ANOVA) for the Regression	78

List of Figures

Figure 1-1-Structure of a fragmented lignin molecule (Binder <i>et al.</i> , 2009).	3
Figure 2- 1: Reaction pathways for addition reactions of PF resoles (Tonge, 2007)	7
Figure 2- 2: Formation of dimethylene ether linkages (a) and methylene linkages (b) during PF resole condensation reactions (Tonge, 2007)	9
Figure 2- 3: Structure of tannin compounds. Two phenolic groups joined by a heterocyclic ring (Raquel <i>et al.</i> , 2010).....	12
Figure 2- 4: Chemical Structure of CNSL (Pizzi, 2006).....	14
Figure 3- 1: pH of phenolic resoles with varying F/P ratios for pure PF resoles and LPFs at 25% and 50% phenol substitutions	42
Figure 4- 1: Effect of F/P molar ratio on curing temperature using Lignin of Mw level (- 1).....	51
Figure 4- 2: Effect of F/P molar ratio on curing temperature using Lignin of Mw level (+1).....	51
Figure 4- 3: Effect of lignin molecular weight on curing temperature of LPF Resins at 25% Substitution.....	55
Figure 4- 4: Effect of lignin molecular weight on curing temperature of LPF resins at 75% substitution.....	56
Figure 5- 1: Form and dimensions of test specimen.....	63
Figure 5- 2: Stress-Strain curve for Pure Phenolic Resole (F/P of 2.1)	64
Figure 5- 3: Stress-Strain curve for LPF-75,(0),3.....	65
Figure 5- 4: Effect of Lignin Molecular Weight (M_w) on Maximum Shear Stress of LPF resoles	67
Figure 5- 5: Effect of % Phenol Substitution Ratio on the Maximum Shear Stress of LPF resoles	68
Figure 5- 6: Effect of F/P Molar Ratio on the Maximum Shear Stress of LPF resoles	70
Figure 5- 7: Test specimens after failure for pure PF resole synthesized with F/P of 2.1 (wood failure).....	71
Figure 5- 8: Test specimens after failure for LPF-75,(0),1.2 (no wood failure)	71
Figure 6- 1: Box-plot of Curing Temperatures (deg. C)	77
Figure 6- 2: Normal Probability Plot for Curing Temperature Response.....	79
Figure 6- 3: Residuals versus Fitted values of the Regression.....	79
Figure 6- 4: Predicted versus Actual (Curing Temperature).....	80
Figure 6- 5: Interaction Effects on Curing Temperature of LPF resoles	80
Figure 6- 6: Surface plots for effect of Lignin Mw and F/P on Curing Temperature of LPF Resoles at substitution of phenol with lignin at (a) 0.25; (b) 0.50; & (c) .075..	81
Figure 6- 7: Contour Plot for Lignin Mw (x_2) & F/P (x_3) on curing temperatures of LPF resoles at 25% substitution of phenol with lignin.....	82
Figure 6- 9: Contour Plot for Lignin Mw (x_2) & F/P (x_3) on curing temperatures of LPF resoles at 75% substitution of phenol with lignin.....	83
Figure 6- 8: Contour Plot for Lignin Mw (x_2) & F/P (x_3) on curing temperatures of LPF resoles at 50% substitution of phenol with lignin.....	83
Figure 6- 10: Contour Plot for substitution of phenol with lignin (x_1) Lignin Mw (x_2) on curing temperatures of LPF resoles	84

Figure 6- 11: Contour Plot for substitution of phenol with lignin (x_1) & F/P (x_3) on curing temperatures of LPF resoles.....85

Figure 6- 12: Contour Plot for substitution of phenol with lignin (x_1) & F/P (x_3) on curing temperatures of LPF resoles at Lignin Mw of 800 g/mol86

Figure 6- 13: Contour Plot for substitution of phenol with lignin (x_1) & F/P (x_3) on curing temperatures of LPF resoles at Lignin Mw of 1700g/mol.....86

Chapter 1: Introduction

1.1. Background

Phenol-formaldehyde (PF) resins are synthetic polymeric materials known for superior mechanical strength, heat and moisture resistance, and excellent ablative properties. Also known as phenolic resins, PF resins were first introduced to the market in the early twentieth century by Bakelite GmbH plant in Germany and General Bakelite Co. in the United States (Kopt, 2002). Since then, PF resins have been extensively used in numerous applications including industrial coatings, insulation, lamination, wood bonding, and most notably as plywood adhesives (Kopf, 2002). Favorably versatile in nature, these resins offer unique advantages to emerging technologies in electronics, aerospace, railway, and building and construction industries (Raquez *et al.*, 2010). In North America, 75% of PF resin demand is accounted for by the building and construction industries (Hall *et al.*, 2012). Phenolic resins are designed, synthesized, and prepared to meet the specified requirements of the application of interest. For instance, phenolic resins as plywood adhesives are characterized with high methylol content, nonvolatile content of around 40-45%, and viscosity range of 150-600 cP (Pizzi, 2003). In comparison, phenolic resins as additives have typical nonvolatile content of 5-15% while glue-mixes require higher viscosity values in the range of 1500-2500 cP (Pizzi, 2003). Typical physical properties of PF resins for plywood adhesives are summarized in Table 1.1. Globally, PF resin industry is valued at \$10 billion with a market value of \$4.5 billion to \$6 billion per year (SRI Consulting, 2010).

Table 1- 1: Typical physical properties of PF resins for plywood adhesives (Pizzi, 2003)

Property	Value
Specific Gravity	1.2 - 1.3
Colour	Dark yellow, orange red, or brown
Nonvolatile Content	40-45%
Viscosity	150 cP to 600 cP

PF resins are synthesized through the reaction of phenol with formaldehyde resulting in highly cross-linked structures. According to Wilson (2010), energy consumption associated with PF manufacturing process is considerably less in comparison to the energy associated with the PF material resources retrieval. For one kilogram of liquid resin, around 0.443MJ of energy is required for the production PF liquid resin compared to the 40.35MJ of energy required for resources retrieval (Hall *et al.*, 2012). Around 95% of the feedstock phenol is derived from petroleum-based benzene and propylene via the Cumene process. At an annual production of 10.7Mt/year globally, the primary use for phenols is in the manufacture of phenolic resins (LigniMatch, 2011). In the United States alone, up to 40% of the phenol produced is consumed by the PF manufacturing industry (SRI Consulting, 2010). Phenolic resins as wood adhesives, in particular, account for around 36% of the global phenolic consumption (SRI Consulting, 2010). Given the rapid depletion of the world's fossil fuel reserves and the accumulating negative effect of greenhouse gases build-up in the atmosphere, there has been widespread interest in finding a more sustainable alternative source for phenols in the production of PF resins. The latest Intergovernmental Panel on Climate Change (IPCC) UN report, for instance, has shown overwhelming consensus among leading scientists around the world on the pressing need to address the challenges of energy consumption demands through more sustainable means.

The past few decades of research has shown promising potential in the use of biomass as an alternative resource to fossil fuels because of its wide availability and abundant supply. In particular, lignocellulosic biomass presents viable greener, lower cost alternative raw materials to phenols in the production of PF resins (Connor & Piskorz, 1994). Lignocellulosic biomass is composed of hemicellulose, cellulose, and lignin. Depending on the biomass species, lignin comprises around 15-30% of lignocellulosic biomass dry weight and has higher energy content of 9000-11000 Btu/lb compared to that of cellulose, which is estimated to be around 7300-7500 Btu/lb (Nimani, 2011; Effendi *et al.*, 2008). Lignin is also generated as a byproduct of chemical processing in pulp and paper industry at an estimated annual production rate of 50Mt (Lora & Glasser, 2002). The primary use for lignin particularly from pulp and paper industry is in combustion

processing for heat generation (Wang *et al.*, 2013). Today, roughly only 1-2% of lignin is isolated; the remainder is used in the form of black liquor in boilers for heat recovery (Lora & Glasser, 2002). However, there is remarkable opportunity in isolating the lignin from black liquor specifically for use in various value added bio-chemicals and products such as bio-phenols for synthesis of lignin-based PF (LPF) resins.

1.2. Substitution for Phenol with Lignin

In recent years, there have been numerous attempts to take advantage of the structural similarities between biomass constituents and phenol, and to substitute the latter with the former, in hopes of attaining a greener feedstock for the production of PF resoles. Particular interest has been focused on usage of lignin obtained from side streaming of pulp processing, where the most commonly products considered are alkaline, kraft, and liginosulfonate lignins. Other considerations include sawdust, tannin, and bark from forestry residue. Reviews of the life cycle assessment (LCA) of PF resins indicate that the use of lignin in the production of phenolic resins could significantly improve its environmental profile in the global warming category (Hall *et al.*, 2012). However, a few important challenges arise when attempting to maximize the substitution rate of phenol with lignin.

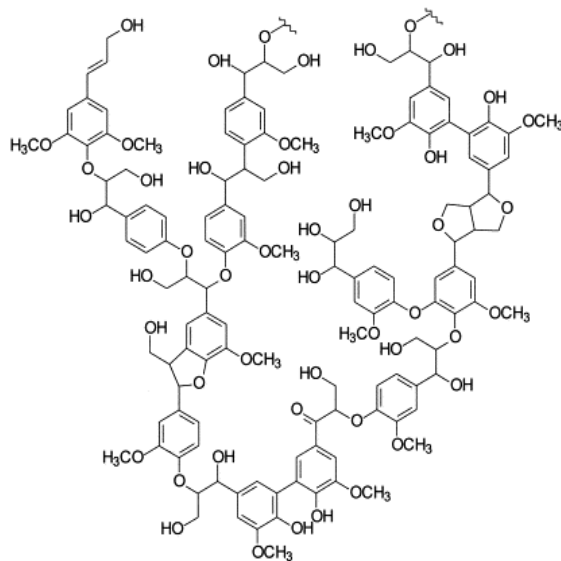

Figure 1-1-Structure of a fragmented lignin molecule (Binder *et al.*, 2009).

Most research studies have reported successful substitution of phenol with lignin at up to 50% without compromising the resin quality. In the United States, phenolic resins with up to 35% phenol replacement have been favorably used in applications of fiberboard bonding and plywood adhesives (Cheng, 2011). Generally incorporation of lignin into PF synthesis increases the curing temperature and pressing time of the resin (Hu *et al.*, 2011). One of the most common challenges with direct substitution of phenol with lignin includes the reduced reactivity of lignin as compared to phenol due to the considerably more complex structure of lignin (see Figure 1-1). Petroleum-based phenols have three main reactive positions within a single molecule including two ortho positions and one para position. Lignin is however a polyphenolic macromolecule with fewer positions that readily available for the addition reaction with formaldehyde and hence more steric hindrance when compared to phenols (Effendi *et al.*, 2008). Substitution of 50% or greater may be achieved by subjecting the lignin to structural modifications or by including pretreatment steps to the Lignin-based phenol-formaldehyde (LPF) resin synthesis process.

Recent studies have proposed modification of lignin molecule in order to increase its reactivity via methylation, phenolation, and thermolysis techniques. In methylation and phenolation, the lignin molecule is pretreated with formaldehyde or phenol respectively, before addition into resin synthesis. Thermolysis of lignin includes application of heat to lignin in presence or absence of catalysts, solvents, and/or additives. Previous reviews have considered improving the reactivity of lignin by using thermo-chemical depolymerization techniques including pyrolysis, liquefaction, oxidation, hydrogenolysis, and hydrolysis (Nimani, 2011). Pyrolysis involves thermal treatment in the absence of oxygen whereas oxidation converts lignin to aldehydes through the application of heat in the presence of oxygen. In contrast, hydrogenolysis uses hydrogen to cleave the bonds within the structure of lignin under heat while favoring higher yields of liquid. Hydrolysis of lignin is conducted at sub-or supercritical conditions without the use of organic solvents and often in the use of an alkaline solvent such as sodium hydroxide. Studies by Mahmood *et al.* (2013) indicate that subjecting Kraft Lignin (KL) to hydrolysis reactions results in significantly decreased molecular

weights and increase of hydroxyl non-aliphatic phenolic groups, which would be favourable for the production of LPF resoles, as will be studied and confirmed in the present work.

1.3. LPF Resin Synthesis Parameters

Resin performance has been correlated with the chemical structure and molecular distributions of phenolic resins (Wang, 2007). The study of “chemistry, structure, characteristic reactions, and kinetic behaviour” of PF resins is necessary for acquiring resins for specific applications (Pizzi, 2003). It is important to optimize the synthesis parameters of PF resins to satisfy the requirement of an application.

PF resins are synthesized by adding formaldehyde to phenols in the presence of an acid or a basic catalyst. There are two main types of phenolic resins, namely resole and novolac resins. When the molar ratio of input formaldehyde-to-phenol is > 1.0 , normally in the range of 1 - 3, under basic conditions, resoles are produced. In contrast, novolacs are synthesized under acidic conditions and input formaldehyde-to-phenol molar ratio of less than 1. Resoles and novolacs differ in their curing mechanisms, where resoles tend to self-cure under heat and pressure while novolacs require a hardening agent in curing. Since resoles are widely used for engineered wood products, such as plywood, oriented strand board (OSB), particle boards, and medium-density fiberboard (MDF), this research work focuses primarily on the application of de-polymerized lignin for the synthesis and characterization of resoles.

One of the main contributors to the characteristic properties of resoles is the formaldehyde to phenol molar ratio (F/P ratio). With higher F/P ratios, the methylation of phenol molecules increases resulting in a three-dimensional structure with higher viscosity and molecular weight. Higher F/P ratios also reduce the gel time and the activation energy of the crosslinking reactions, leading to a faster cure (Tonge, 2007). However, the content of free formaldehyde would increase with increasing F/P ratios.

Another important consideration is the pH of the reaction medium, which influences the formation of ether and methylene bridges during condensation reactions as well as the gel time, molecular weight, and adhesive strength of the resin. Recent study by Abdel Wahab & Nassar (2011) suggests that increasing the pH of the reaction medium results in higher adhesive strength properties but only when the concentration of the catalyst, sodium hydroxide, is equal to or less than 10 wt% of phenolic feedstock.

A third important parameter in the synthesis of LPF resoles is the molecular weight of the lignin materials. Through de-polymerization in order to reduce the lignin molecular weight, it has been demonstrated in our group that the reactivity of the lignin molecule toward formaldehyde increases and leads to favorable thermal and mechanical properties of the resultant

LPF resoles (Cheng *et al.*, 2013). Mahmood *et al.* (2013) has indicated an increase in the content of hydroxyl phenolic units in the de-polymerized lignin (DL) products from hydrolytic de-polymerization of Kraft Lignin (KL). This suggests promise of application of the Kraft lignin-derived DL products in the synthesis of LPF resoles with high phenol substitution ratios. The synthesis parameters need to be investigated and optimized to obtain Kraft lignin-based resoles with high phenol replacement ratios without comprising their curing and adhesive properties.

1.4. Objectives

The aim of this research work was to investigate the optimization of synthesis parameters for the production of Kraft lignin-based phenol formaldehyde resoles (LPF) for plywood adhesives at high phenol percent substitutions while maintaining the high performance of the resoles as plywood adhesives. Desirable resin performance includes higher adhesive strength for plywood and lower thermal curing temperatures during curing of the resins for minimal energy input purposes.

Obtained from FPInnovations Lignin Pilot Plant in Thunder Bay, Kraft Lignin was initially subjected to hydrolytic de-polymerization at varying reaction severities to attain

DL products at various relative molecular weight ranges for use as a replacement for phenols in the production of PF resoles.

Three phenolic resin synthesis parameters including relative molecular weight of the depolymerized Kraft lignin (Mw of DL), formaldehyde-to-phenol ratio (F/P), and phenol percent substitution were varied in an experimental design using Box Behnken Design (BBD). Physical, thermal (curing), and mechanical properties of the synthesized LPF resoles were studied and presented in the following chapters.

1.5. Thesis Structure

To meet the above objectives, this thesis is structured as follows:

Chapter 2 provides literature review on synthetic, natural, and bio-based adhesives with a particular focus on lignin-based phenol formaldehyde (LPF) resoles and lignin modification techniques.

Chapter 3 presents yields and characterizations of the DL products from lignin hydrolytic depolymerization process at varying severities, as well as physical characteristics of the synthesized LPF resoles including viscosity, pH values, and non-volatile content.

Chapter 4 investigates the thermal curing behaviours of the synthesized LPF resoles using Differential Scanning Calorimetry (DSC). Effects of F/P ratios, phenol percent substitutions, and relative Mw of the DL used on the curing peak temperatures are discussed.

Chapter 5 investigates the mechanical properties (adhesive strengths) of the Kraft lignin-derived LPF resoles as adhesive for plywood.

Chapter 6 presents and discusses parameter optimization results for LPF resoles synthesis with respect to thermal curing temperature

Chapter 7 provides the major conclusions from all the chapters, and recommendations for future work in the topic.

1.6. References

- Amen-Chen, C., Pakdel, H., & Roy, C. (2001). Production of monomeric phenols by thermochemical conversion of biomass: A review. *Bioresource Technology*, 79(3), 277-99.
- Binder, J. B., Gray, M. J., White, J. F., Zhang, Z. C., & Holladay, J. E. (2009). Reactions of lignin model compounds in ionic liquids. *Biomass and Bioenergy*, 33(9), 1122-1130.
- Cheng S, Yuan Z, Leitch M, Anderson M, Xu C (2013). Highly efficient depolymerization of organosolv lignin using a catalytic hydrothermal process and production of phenolic resins/adhesives with the depolymerized lignin as a substitute for phenol at a high substitution ratio. *Industrial Crops and Products*, 44, 315-322.
- Connor MA, Piskorz J. Workshop report: Chemical from Biomass. In: Bridgewater, A.V. (Ed.), *Advances in Thermo-Biomass Conversion*. Blackie, New York. 1994, 1502–1504.
- Effendi, A., Gerhauser, H., & Bridgewater, A. V. (2008). Production of renewable phenolic resins by thermochemical conversion of biomass: A review. *Renewable and Sustainable Energy Reviews*, 12(8), 2092-2116.
- Hu, L., Pan, H., Zhou, Y., & Zhang, M. (2011). Methods to improve lignins reactivity as a phenol substitute and as replacement for other phenolic compounds: A brief review. *BioResources*, 6(3), 3515-3525.
- Kopf, P.W. (2002). Phenolic resins. *Encyclopedia of Polymer Science and Technology*, 7, 233-268. Retrieved from <http://onlinelibrary.wiley.com/doi/10.1002/0471440264.pst236/abstract>
- Lora, J.H., Glasser, W.G. (2002). Recent industrial applications of lignins: A sustainable alternative to non-renewable materials, *J. Polym. Environ.* **10**, 39–48.
- LigniMATCH. (2011). Future use of lignin in value added products – a roadmap for possible Nordic/Baltic Innovation. Retrieved May 2013 from <http://www.scanbalt.org/files/graphics/ScanBalt/Activities/ScanBalt%20Bridge%20Award/Roadmap%20100823.pdf>

- Mahmood, N., Yuan, Z., Schmidt, J., & Charles Xu, C. (2013). Production of polyols via direct hydrolysis of kraft lignin: Effect of process parameters. *Bioresource Technology*, 139, 13-20.
- Nimani, L. (2011). Lignin depolymerization and conversion. 2011 Wisconsin Bioenergy Summit. Retrieved from <http://www.slideshare.net/lnimani/lignin-depolymerization-and-conversion-15269049>
- Pizzi, A. (2003). Phenolic resin adhesives. *Handbook of Adhesive Technology*, 541-571.
- Raquez, J. M., Deléglise, M., Lacrampe, M. F., & Krawczak, P. (2010). Thermosetting (bio) materials derived from renewable resources: A critical review. *Progress in Polymer Science*, 35(4), 487-509.
- SRI consulting. (2010). World Petrochemical (WP) report on PF Resins. Retrieved May 2013 from http://www.sriconsulting.com/WP/Public/Reports/pf_resins/
- Tonge, L. (2007). *Thermochemical properties of methylol phenol monomers and phenol formaldehyde resoles*. Thesis. Hawthorn, Australia: Faculty of Engineering and Industrial Sciences, Swinburne University of Technology.
- Wang, H., Tucker, M., & Ji, Y. (2013). Recent development in chemical depolymerization of lignin: A review. *Journal of Applied Chemistry*, 2013.
- Wang, J. (2007). *Cure kinetics of wood phenol-formaldehyde systems*. Thesis. Washington: Department of Civil and Environmental Engineering, Washington State University.
- Wilson, J. B. (2010). Life-cycle inventory of formaldehyde-based resins used in wood composites in terms of resources, emissions, energy and carbon. *Wood and Fiber Science*, 42, 125-143.

Chapter 2: Literature Review

2.1. History and Background of Adhesives

Adhesives include any materials that are used to adhere adherents or laminates including metal, plastics, and wood together by use of cohesive forces under specified conditions of humidity, temperature, and pressure (Eckelman, 1999; Zhao *et al.*, 2011). Adhesives can be classified into two categories, namely synthetic and natural adhesives. Natural adhesives were primarily used before World War II and largely derived from extensive cassava plantations. Following the loss of these plantations around WWII, the use and development of synthetic substitutes to natural adhesives increased, and today synthetic adhesives such as urea formaldehyde and phenol formaldehyde resins are widely used; the feedstocks of which are mostly derived from petroleum-based products such as natural gas and crude oil. However, due to depleting fossil fuel reserves and increasing environmental concerns, researchers and adhesive companies alike are increasingly interested in developing adhesives from natural resources or incorporating natural polymeric materials such as lignocellulosic biomass into synthetic adhesives.

2.1.1. Natural Adhesives

Natural adhesives are typically derived from animals, vegetables, and proteins. A few important limitations have been reported with natural adhesives including increased viscosity, colour variation, short application periods, and relatively lower bonding strength as well as moisture resistance, although the use of natural adhesives certainly has a great potential primarily due to their environmentally friendly origins (Pizzi, 2006).

Animal-based glues

Animal glues are formulated from bones of horses, cattle, and even fish. Good quality animal glues remain in gel-form when soaked in water. The fish-based glues can be found in convenient liquid form for ease of application. It is important to note that animal glues develop their full strength only upon drying. This makes their usage inconvenient and relatively expensive. Although animal glues have high strength properties, they lack proper resistance to moisture and damp conditions. Due to these limitations, animal glues

have been largely replaced by synthetic polyvinyl acetate (PVA) emulsions particularly in the application of furniture construction (Eckelman, 1999).

Starch-based vegetable glues

Originating from plants such as cassava rice, corn, and potatoes, starch used for glues have naturally larger molecules and include important functional groups useful for adhesion purposes (Zhao *et al.*, 2011). Additionally, starch based glues are relatively inexpensive and have reportedly long pot life and high dry strength. However, like animal-based glues, starch-based glues are associated with poor moisture resistance properties and poor storage stability. Today, synthetic urea formaldehyde (UF) resins have displaced starch-based adhesives in the construction of interior hardwood plywood and furniture (Eckelman, 1999).

Protein-based glues

Given that soybeans are easy to obtain, most protein-based glues are formulated using whole soybeans, the protein isolated from soybeans, or as a blend of blood and soybean proteins (Zhao *et al.*, 2011; Eckelman, 1999). As adhesives, soybeans exhibit moderate to low dry strength, moderate resistance to intermediate temperatures, and low moisture resistance properties. Given their limitations, synthetic phenol formaldehyde resins have displaced these resins primarily in the application of softwood plywood.

Casein Glue

Derived from the precipitate of skim and butter milk, casein glues are characterized by their relatively high dry strength, moderate resistance to moisture and intermediate temperature, and short pot life (Eckelman, 1999). These glues are sold as dry powders to be mixed with water for usage. To produce one pound of dry casein, around eight gallons of skim milk are needed. The casein curds are dissolved in alkaline solutions with the addition of chemicals such as formaldehyde or copper chloride. Given their relatively higher moisture resistance properties when compared to animal or soybean glues, casein glues were used primarily in interior laminated timbers applications prior to the large-scale application of synthetic adhesives. However, these glues require excessively large

amounts of milk for production, therefore not desirable due to competition with food supply (Eckelman, 1999).

2.1.2. Synthetic Adhesives

Synthetic adhesives are typically synthesized to meet specific needs of applications. Synthetic adhesives have proven to be advantageous to natural adhesives in several aspects including flexibility of end-use for extensive applications, ease of use, rapid development, and relatively higher strength and moisture resistance properties (Zhao *et al.*, 2011). Synthetic adhesives are derived from synthetic polymers that can be further classified into two groups including thermosetting and thermoplastic polymers. More widely used, thermosetting polymers undergo irreversible condensation polymerization changes under specified conditions of temperature, pressure, and/or addition of curing agents. In contrast, thermoplastic polymers are pre-polymerized, set by loss of a dispersing solvent, and softening by the application of heat (Eckelman, 1999). Common types of synthetic adhesives include urea-formaldehyde (UF), phenol formaldehyde (PF), melamine formaldehyde, resorcinol-formaldehyde, and polyvinyl acetate emulsions.

Urea-Formaldehyde:

Urea-formaldehyde (UF) resins are the most widely used synthetic thermosetting resins especially in the manufacture of particleboard and interior grade plywood. Although first synthesized by B. Tollens in 1844, UF resins were not fully developed for wood adhesives until 1929 by IG Company in Germany. The use of UF resins now account for around 90% in wood-based adhesives (Zhao *et al.*, 2011). UF resins are found in liquid or powder form and are cured at temperatures ranging from room temperature up to around 200°C (Eckelman, 1999). Key concerns with UF resins are low-to-moderate moisture resistance, brittle adhesive layer, and excess free formaldehyde release. According to EPA (2012), pressed wood with UF adhesives emit formaldehyde at considerably higher rates than those pressed with PF resins. Ongoing attempts have been made by researchers to reduce the formaldehyde release from UF resins including reducing the formaldehyde

to phenol ratio in the synthesis and modifying UF resins by using additives and inorganic nanoparticles (Zhao *et al.*, 2011).

Melamine-formaldehyde (MF):

Melamine-formaldehyde (MF) resins were developed to improve the poor moisture resistance properties associated with urea-formaldehyde. Though at a relatively higher manufacturing cost, MF resins are significantly more resistant to a wider range of conditions when compared to UF resins. However, phenolic resins are substantially more resistant to extreme conditions than both UF and MF resins (Eckelman, 1999). For most applications, MF resins require curing temperatures of at least 115°C to 150°C (Eckelman, 1999). MF resins are required for some applications where water-resistant and light-colored adhesives are desirable such as for marine plywood.

Polyvinyl acetate (PVA) emulsions:

Classified as thermoplastic resin adhesives, polyvinyl acetate (PVA) emulsions have key desirable characteristics such as low cost and non-toxicity. PVAs are widely used in applications of furniture assembly as well as bonding plastic laminates. However, polyvinyl acetates are associated with poor resistance to moisture, heat, creep and mechanical stress in comparison to UF resins. Under high temperatures and humidity, the bond strength of PVAs drops significantly, limiting their usage in wide variety of applications (Zhao *et al.*, 2011). Previous attempts at improving the resiliency performance of PVAs under extreme conditions include modifications in the form of blending and/or polymerization, where monomers such as ethylene, styrene, and acrylic acid esters or crosslinking agents are added to change the molecular structure of the polymer and improve the associated water resistance properties (Zhang *et al.*, 2006; Liu & Xu, 2000; Ayoub, 1997).

Isocyanate Adhesives:

Reported first uses of isocyanate adhesives were around the 1940s; however, initial health-related concerns as well as technical difficulties prevented their large-scale application at the time. After technical improvements along with the demand for

formaldehyde free particleboards, isocyanate adhesives regained popularity in Germany and later in the United States since the manufacture of isocyanate particleboards in 1975 (Eckelman, 1999). Isocyanate adhesives bond by forming urethane bridges with hydroxyl groups of the wood cellulose resulting in excellent wood adhesion, high versatility, and superior moisture and chemical resistance properties. However, the use of isocyanates is still very limited due to the associated high costs.

Resorcinol and Phenol-Resorcinol Formaldehyde:

Resorcinol and phenol-resorcinol formaldehyde are more expensive than PF resins, but used in specialized applications. Characterized by excellent dry and wet strength as well as superior moisture and damp conditions resistance properties, these resins are commonly used as assembly glues in laminated timbers, solid wood joints and even in the manufacture of wood aircraft (Eckelman, 1999).

2.2. Phenol-Formaldehyde (PF) Resins:

Discovered by Dr. Leo Bakeland in 1909, phenol-formaldehyde (PF) or phenolic resins were the first synthetic resins to be developed (Eckelman, 1999). PF resins are the second most common resins (following UF resins) in wood applications, and are highly demanded in the manufacture of softwood plywood for exterior building and construction purposes (Eckelman, 1999; Zhao *et al.*, 2011). The PF resin is valued at \$10 billion globally, and has an annual market value of \$4.5 billion to \$6 billion (SRI Consulting, 2010). PF resins are known for their superior high bond strength and moisture resistance properties particularly under severe conditions of weather, temperature, and humidity. Phenolic resins are typically dark reddish in colour and can be synthesized at a variety of temperature ranges ranging from room temperature to temperatures over 135°C. Curing temperatures range from 125°C to 150°C; however, hot-pressing temperatures can reach up to 200°C for use in structural composites (Eckelman, 1999).

In the United States, PF resins are typically alkaline-catalyzed and are known as resoles. Application of resoles as wood adhesives became common around the 1930s especially in the manufacture of particleboard and plywood (Tonge, 2007). Resoles are advantageous

over acid-catalyzed PF resins known as novolacs for several reasons. Resoles are preferred for wood adhesives because of their ability to form three dimensional networks that have favorably high tensile strength, high modulus, dimensional stability, and resistance to moisture (Tonge, 2007). Unlike novolacs, resoles do not require the addition of a curing agent during the crosslinking stage and there is less concern for wood damage using base-catalyzed resins. However, the free formaldehyde content from resoles is relatively higher when compared to novolacs given that resoles are synthesized with higher formaldehyde-to-phenol molar ratio (>1.0).

About 95% of the feedstock phenol is produced using petroleum-based benzene and propylene with the Cumene process at annual production of 10.7Mt/year globally. The primary use for phenols is for the manufacture of phenolic resins (LigniMatch, 2011). In the United States, up to 40% of the phenol produced is consumed by the PF manufacturing industry (SRI Consulting, 2010). Phenolic resins as wood adhesives, in particular, account for around 36% of the total global phenolic consumption (SRI Consulting, 2010). Since the raw materials for PF resins are derived from petroleum-based products, considerable research has been focused to replace the phenol in the manufacture of PF resins with a more renewable and sustainable resources. Recent phenol replacement options include modified pyrolytic oil, bio-crude from hydrothermal liquefaction of biomass, lignin, biomass tar, bark, and tannin (Zhao *et al.*, 2011; Cheng *et al.*, 2011; Wang *et al.*, 2009).

2.2.1. PF Resole Synthesis and Curing

Phenol formaldehyde (PF) resins are available in a wide variety of forms and exhibit broad range of characteristics depending on the applications of interest. It is necessary to study the chemistry of synthesis and curing of PF resins in order to be able to appreciate the unique properties of the final resultant resin used for a specific application. Also known as phenolic resins, PF resins are synthesized through the reaction of formaldehyde with phenol. One of main contributors to the synthesis of phenolic resins is the molar ratio of formaldehyde-to-phenol (F/P). Resoles are formed when formaldehyde is in excess > 1.0 , at an F/P ratio of up to 3:1 or 4:1, under alkaline conditions while novolacs

resins are obtained under acidic conditions at F:P ratios less than 1.0. Since resoles are more extensively used for wood production applications, this section will focus primarily on the synthesis and curing of PF resoles. Typically, resoles are a mixture of oligomers of several units, residual free phenols and formaldehyde, as well as methylolated phenolic groups (Tonge, 2007). Production and application of PF resoles involve three reaction sequences including formaldehyde addition to phenol, condensation reactions to form the resin, and finally curing of the polymeric resin upon application.

The first step of addition reaction starts to occur at low temperatures, e.g., 60 °C or less, whereby formaldehyde is added to a phenolate ion in the presence of an alkaline catalyst such as sodium hydroxide at pH of around 8 to 13. Formaldehyde attacks the ortho or para position of a phenol molecule and adds a methylol group to the phenol molecule resulting in the formation of an intermediate methylolated phenolic group such as an ortho- or para- monosubstituted methylol phenol. Ortho- or para-substituted mono-methylol phenols (MMP) are the simplest groups that can react with other phenolic groups in condensation reactions and cured into resins. Other forms of intermediate methylol phenolic groups include di-methylol (DMP) and tri-methylol (TMP) phenols, which are more likely to form when formaldehyde is in excess (Tonge, 2007). It is desirable to methylolate phenol molecules as much as possible in order to obtain a highly-crosslinked three-dimensional final product for structural purposes.

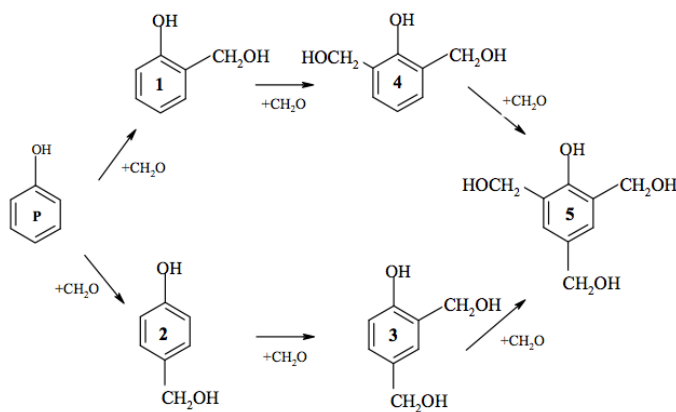

Figure 2- 1: Reaction pathways for addition reactions of PF resoles (Tonge, 2007)

The position of the methylol group on the phenolic molecule as well as the ratio of methylol groups have a significant influence on the rate of polymerization and subsequently the properties of the final PF product (Tonge, 2007). Various reaction pathways are possible for the addition reactions of PF resoles as illustrated in Figure 2-1. The factors that influence the composition of methylol phenols during addition reactions include F/P ratio, catalyst concentration, temperature and pH value of the reaction medium. Methylolated phenolic groups tend to be more reactive with formaldehyde than with unsubstituted phenols. As a result, the formation of 2,4-dimethylol phenols followed by 2,4,6-trimethylolphenols is favourable, where these intermediates are predominant when formaldehyde is in large excess and during relatively shorter reaction times. Still, not all reactive sites of phenolic molecules can be methylolated due to steric hindrance effects as the oligomer increases in size (Tonge, 2007).

When the reaction temperature reaches above 60°C, methylol phenols start to react with other methylol phenols or unsubstituted phenols in condensation reactions resulting in the formation of pre-polymeric resin intermediates of varying reactivity and thermal properties. During these condensation reactions, side products such as unreacted phenols, water, and formaldehyde can also be released (Tonge, 2007). PF polymerization is initiated with the formation of methylene or dimethylene ether bridges, where a methylol group on one phenol reacts with another phenol at the ortho or para position or two methylolphenol units react with one another. More common in acidic or neutral conditions, dimethylene ether bridges are formed between two methylol groups with the release of one water molecule (Figure 2.2a). In contrast, methylene bridges form between two methylol groups with the release of one water molecule as well as one formaldehyde molecule (Figure 2.2b). During the condensation reactions, the molecular weight of the resole polymer starts to increase substantially, resulting in increase of solid contents as well as increase in the polymer viscosity from around 100 cP to around 5000 cP depending on the application of interest.

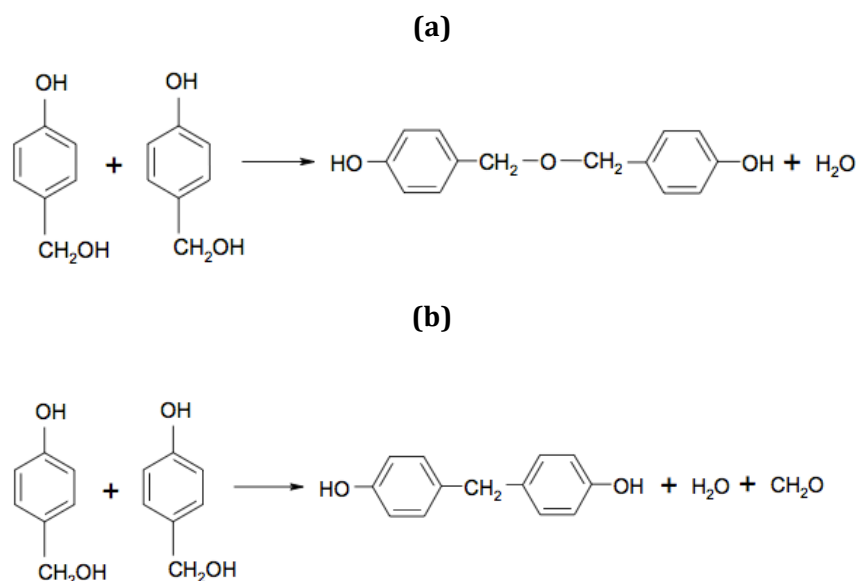

Figure 2- 2: Formation of dimethylene ether linkages (a) and methylene linkages (b) during PF resole condensation reactions (Tonge, 2007)

During the curing process, one or more of the intermediate reactive methylol groups are transformed from low molecular weight materials into a highly branched and cross-linked network of phenolic resin usually through the application of heat and sometimes a curing agent. The curing stage is characterized by more complex molecular rearrangements and reactions resulting from further condensation reactions at higher temperatures of above 125°C. Resoles tend to cure without the addition of a curing agent while novolacs require a curing agent for cross-linking of the network resin polymer. Beyond 170°C, ether linkages may undergo further reactions to form newer arrangements such as methylene linkages that form with loss of formaldehyde. Above 200°C, the resole undergoes thermal and oxidative decomposition of its structure as well as other complex reactions that may include further polymerization of the products.

2.3. PF Synthesis and Curing Parameters

Resin performance has been correlated with the chemical structure and molecular distributions of phenolic resins (Wang, 2007). The study of chemistry, structure, characteristic reactions, and kinetic behaviour of PF resins is necessary for acquiring resins for specific applications (Pizzi, 2003). Addition, condensation, and curing

reactions of PF resins are all influenced by reaction conditions (Tonge, 2007). It is important to optimize the synthesis parameters of PF resins to satisfy the requirement of an application. Since this research work is focused on wood application purposes, this section includes discussion of synthesis parameters of PF resoles given their widespread wood applications.

One of main contributors to the synthesis of PF resoles is the molar ratio of formaldehyde-to-phenol (F/P). Previous reviews indicate that increases in F/P ratios are associated with increases in the molecular weight of the resole (So & Ruddin, 1990; Decatur, 1989; Holopainen *et al.*, 1997). Higher F/P ratios result in greater concentration of methylol groups in methylol phenols and greater methylol substitution in the phenolic molecules, thereby resulting in increases of methylene and ether bridges for a more rigid three-dimensional PF resin structure. Increasing the F/P ratios also increases the viscosity of the resin and decreases the gel time while also increasing the curing rate of the resole. However, higher F/P molar ratios are associated with health risk implications as a result of higher free formaldehyde content.

Temperature of the curing process is another important contributor to the final properties of PF resoles primarily due to the complexity of the cross-linking reactions. Curing temperatures below 170°C result in formation of methylene bridges but also ether bridges. Given their instability, ether bridges may undergo further reactions to reach more stable states and arrangements at higher than 170°C. **Additionally, incorporation of renewable resource such as lignin at a large phenol substitution ratio tends to increase the curing temperature of the phenolic resin primarily due to the increased complexity of the lignin structure when compared to a phenol molecule** (Wang *et al.*, 2009). For energy expenditure purposes, lower curing temperatures are preferred.

A third important parameter is the pH of the reaction medium, where ether bridges dominate at acidic or neutral pH ranges while methylene bridges dominate at higher, more alkaline pH values (Tonge, 2007). Using an alkaline catalyst such as sodium hydroxide at increasing concentrations tends to reduce the gel time, increase the

molecular weight of the resin, and the solid content. Studies from Abdel Wahab and Nassar (2011) indicated that the adhesive strength of PF resoles increases with increasing sodium hydroxide content until about 10wt% of catalyst concentration. Increasing the catalyst concentration beyond 10wt% results in reduction in the adhesive strength.

2.4. Bio-based Phenolic Resins

Bio-based wood adhesives include a narrower range of resins using non-petroleum-based materials. Common examples include tannins, lignins, liquefied wood, unsaturated oil, starch, cellulose, proteins, blood, and collagen.

Biomass-based resins have many advantages over synthetic resins such as the use of renewable resources for feedstocks, reduced toxicity, and generally lower energy usage. Synthetic resins are coming under increasing scrutiny due to recent tightening of environmental exposure regulations (Jones, 2007). Because of their low toxicity, incorporation of renewable raw materials into the manufacturing of adhesives provides opportunities for improved employee health and safety regulations and safer end-use products for consumers and household residents (Hall *et al.*, 2012). Similar to biofuels, bio-resins lack proven commercial scale production; however, there is a potential for a much larger market for bio-resins mainly due to minimal requirements for industry infrastructure adjustment for bio-resins compared to biofuels (Hall *et al.*, 2012).

Examples of recent industrial applications of bio-resins include use of soybeans and other renewable raw sources for the development of bio-based sealants and adhesives by Rohm and Haas Company and Cara Plastics, and the use of oilseed rape enzymes for the production of saturated polyester resins (Jones, 2007).

At present, bio-resins have a few technological shortcomings when compared to petroleum-based resins including reduced reactivity and thermal stability, inferior bond strength, and colour and curing issues (Hall *et al.*, 2012). Recently, the renewable aspect of bio-resins has inspired a revived interest among researchers to focus studies on overcoming the technological hurdles associated with bio-resins for satisfactory performance improvements. Of particular interest is the use of lignin and tannin in the

manufacture of phenol formaldehyde resins as a replacement to phenol given the structural similarities of the former with the latter.

Tannin

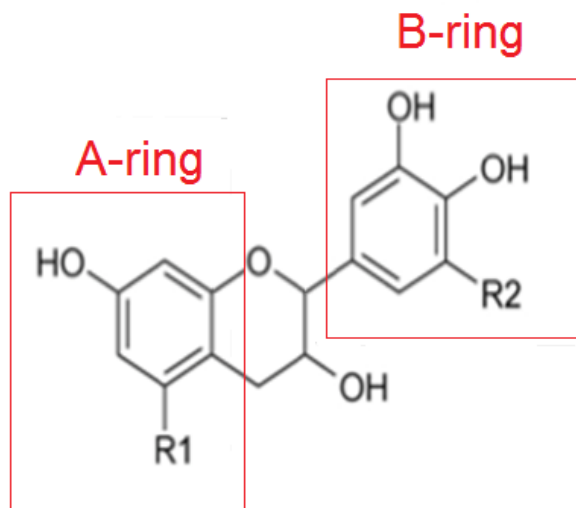

Figure 2- 3: Structure of tannin compounds. Two phenolic groups joined by a heterocyclic ring (Raquel *et al.*, 2010).

Tannin compounds are natural polyphenolic materials that are extracted from wood, bark, leaves, and galls of plants. The structure of tannins is composed of flavan-3-ol repeating units, where a heterocyclic ring connects two phenolic rings known as A-ring and B-ring (Raquez *et al.*, 2010). The A-ring phloroglucinolic or resorcinolic nuclei shown in Figure 2.3 influences reactivity of tannins with formaldehyde and ultimately the cross-linking capacity of tannins. Interest in using tannin-based adhesives was initiated around 1950's by Dalton, followed by Plomley in the late 1950's and mid 1960's (Santana *et al.*, 1995). Tannins have traditionally been used for the conversion of animal hides into leather, a process known as tanning. Other uses include use as anti-corrosive binders, rust inhibitors, and wood adhesives. At an industrial-scale, tannin-based adhesives were used in the manufacture of plywood and particleboard in 1970's (Lee *et al.*, 2011). Two different classes of tannins include hydrolysable and condensed tannins. Composed of simple phenols such as pyrogallol and ellagic acid and of esters of a sugar, hydrolysable tannins lack macromolecular structure and are relatively expensive due to limited worldwide production (Jones, 2007). In contrast, condensed tannins have rigid carbon-to-

carbon bonds and are produced at an annual rate of 200,000 tons, constituting greater than 90% of the worldwide commercial tannin production (Lee *et al.*, 2011; Jones, 2007).

However, several limitations have been associated with more extensive commercial use of tannin adhesives including relatively weak adhesive bonds, high transportation costs, high viscosities, short pot life, and high free formaldehyde content due to incorporation of large levels of hardeners for curing purposes (Raquez *et al.*, 2010; Jones, 2007). To improve some of these qualities, most tannin-based adhesives are fortified with synthetic adhesive such as PF or UF resins (Lee *et al.*, 2011). Despite attempts of tannin modifications, tannins continue to face rotation restrictions around their backbone bonds due to their large molecular sizes. As a result, tannin-based resins tend to experience premature gelation during the curing process especially at high temperatures leading to formation of brittle materials with shorter shelf life (Raquez *et al.*, 2010).

Cashew Nut Shell Liquid

Cashew Nut Shell Liquid (CNSL) is the reddish brown viscous protective layer surrounding cashew nuts that grow on cashew trees known as *Anacardium occidentale* (Raquez *et al.*, 2010). Used as a deterrent to animals, CNSL has a bitter taste due to the acidity of its phenolic groups (Jones, 2007). It is primarily composed of cardanol, anacardic acid, cardol, and methyl cardol, as shown in Figure 2.4. Cardanol is a C15 aliphatic chain composed of saturated and unsaturated compounds and can be extracted from CNSL to be used in the production of bio-resins (Yadav & Srivastava, 2012). Given its phenolic nuclei as well as the unsaturated fatty acid chains, CNSL has a potential for the production of resins that are associated with high resistance to water (Pizzi, 2006). Cardanol is regarded as a versatile raw material with higher flexibility than conventional phenolic resins and has wide range of applications as brake linings, varnishes, paints, coatings, and polymer productions (Raquez *et al.*, 2010). However, cardanol-based resins used as adhesives are associated with relatively weaker tensile strength due to steric hindrance effects and reduced intermolecular interactions (Raquez *et al.*, 2010). Like tannin-based resins, it is therefore necessary to incorporate synthetic resins such as urea

or phenol formaldehyde resins into CNSL-based adhesives in order to meet the minimum mechanical strength requirements depending on the application (Lee *et al.*, 2011).

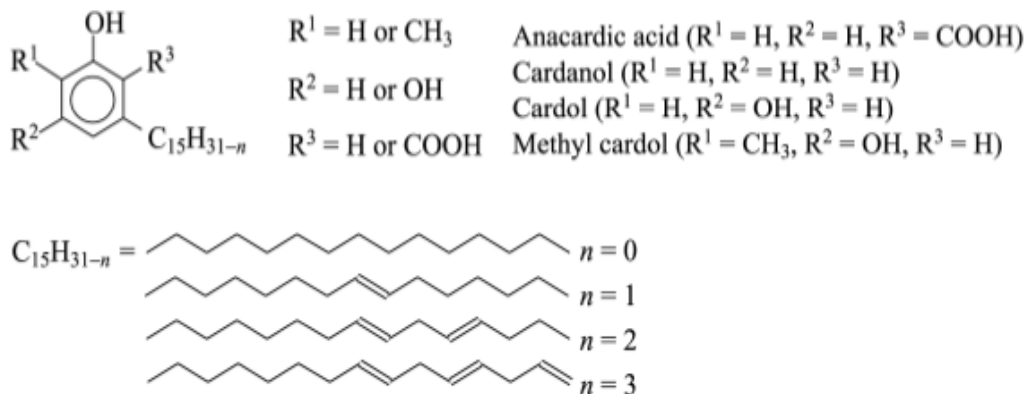

Figure 2- 4: Chemical Structure of CNSL (Pizzi, 2006).

Lignin

Lignin is the second most abundant natural polymer available and has an estimated 300 billion tons capacity with an annual biosynthetic rate of 20 billion tons (Hu *et al.*, 2011). It is one of the three components of lignocellulosic biomass and is known to provide woody stems with rigidity and impact resistance (Raquez *et al.*, 2010). Lignin is a copolymer of three different phenyl-propane monomer units including p-hydroxy-phenyl-propanol, guaiacyl-propanol, and syringyl-propanol predominantly bonded by aryl ether linkages. Major functional groups that influence the reactivity of lignin include aliphatic hydroxyl, phenolic, methoxyl, carboxyl, carbonyl, benzyl alcohol, and noncyclic benzyl ether groups (Effendi *et al.*, 2008; Nimani, 2011). Given its complexity, the exact structure of lignin is still unknown. The structure of lignin is also dependent on the source and the isolation technique. Originating from pulp processing or directly from lignocellulosic biomass, lignin can be extracted using various mechanical and chemical isolation techniques. Most common examples of lignin include Kraft lignin, organosolv lignin, liginosulfonates, and hydrolysis lignin.

Lignin extracted from pulping processing (mainly Kraft lignin and liginosulfonates) has been traditionally regarded as low-value and primarily used in recovery boilers in pulp/paper mills for heat generation and recovery of pulping chemicals. Around 80% of

the available lignin from chemical pulping is derived from the widely executed Kraft pulping process (Kirk-Othmer, 1999-2008; Raquel *et al.*, 2010). Kraft lignin (KL) is isolated through dissolution, where cellulose and hemi-cellulose form insoluble residues within the solution while the dissolved lignin is extracted and recovered from the solution (Nimani, 2011). The isolated lignin can then be subjected to further processing for the purpose of conversion and depolymerization. Today, roughly only 1-2% of lignin is isolated for specific applications; the remainder is used in the form of black liquor in recovery boilers (Lora and Glasser, 2002; Raquel *et al.*, 2010). Given the estimated annual production of lignin at 50 Mt, there is remarkable potential benefit in isolating lignin for use in various value added bio-chemicals and products.

2.5. Lignin-based phenol formaldehyde (LPF) resins

Over the last decade, there has been increasing interest to use lignin an attractive alternative to phenols due to the structural similarities between lignin and phenols, low cost of lignin, as well as wide availability of lignin (Hu *et al.*, 2011). The use of Kraft lignin (KL) is of particular interest since the capacity of recovery boilers is the bottle neck for a majority of the pulp mills in North America. From recent thermogravimetric studies by Amen-Chen *et al.* (2001), lignin is the most heat resistant component in wood, implying a great potential of using lignin in the production of heat-resistant phenolic resins. Additionally, lignin based adhesives tend to have good moisture resistance properties and are not readily attacked by microorganisms (Rowell, 2012). However, direct use of lignin in the production of phenol-formaldehyde (PF) resins requires considerably longer press times and higher press temperatures given the reduced reactive sites of lignin in comparison to conventional phenols (Hu *et al.*, 2011). Most research findings indicate a successful substitution up to 50% of phenol with original lignin in PF resin production without compromising the bonding properties of resins. As such, direct use of unmodified lignin is not seen as a commercially attractive option for the production bio-based phenolic resins (Hu *et al.*, 2011).

2.6. Lignin Modification Techniques

Recent studies have suggested the application of various chemical modifications such as phenolation, methylation, liquefaction, pyrolysis, oxidation, and hydrolysis in hopes of

increasing the potential reactive sites of lignin toward formaldehyde (Hu *et al.*, 2011). With thermolysis techniques, the three-dimensional structure of lignin can be thermochemically broken down into phenolic units of smaller molecular weight ranges. These phenolic oligomers may then be used as a replacement of petroleum-derived phenols and incorporated into the synthesis process of PF resins. In phenolation and methylation, the structure of lignin is enhanced with the introduction reactive functional groups (Hu *et al.*, 2011). Recently, some plywood mills in North American have attempted to use methylolated lignin in the production of phenolic resins, where lignin is pre-reacted with formaldehyde (Pizzi, 2006). The major limitation with this modification is that its successful phenol replacement ratio is below 30-40 % by weight (Pizzi, 2006; Hu *et al.*, 2011).

2.6.1. Methylolation and Phenolation

In methylolation, hydroxymethyl groups of lignin reacts with formaldehyde under basic conditions resulting in the formation of methylolated lignin. The methylolated lignin is then incorporated in the manufacture of PF resins in varying methylolated lignin-to-phenol substitution percentages. In comparison to the use of un-modified lignin, Lin *et al.* (2010) reported considerably improved mechanical and thermal properties of lignin-based phenolic resins with the use of methylolated lignin only when the phenol substitution ratio is more than 50% (Lin *et al.*, 2010; Zhao *et al.*, 2011). However, the reported adhesive strength for a PF resin produced with 50/50 (w/w) methylolated lignin and phenol blend was found to be very low, at around 0.5 MPa (Zhao *et al.*, 2000; Hu *et al.*, 2011). Additionally, the use of methylolated lignin in PF production is associated with higher free formaldehyde content as well as increased probability of the occurrence of undesirable side reactions such as Cannizzarro reaction, where formaldehyde reacts with itself (Hu *et al.*, 2011). LPF resins with up to 40% phenol substitution with methylolated-lignin have shown comparable properties to conventional PF resins (Hu *et al.*, 2011).

In phenolation, lignin molecules are thermally pre-treated with phenols in the presence of organic solvents such as ethanol or methanol under acid conditions. This treatment is known to increase the content of phenolic hydroxyl group and reduce the size of the

lignin molecules (Hu *et al.*, 2011). The resultant modified lignin molecules of reduced molecular weight can then be incorporated in the manufacture of PF resins under either acidic or basic conditions. Studies have indicated that particleboards produced using up to 30% of phenol substitution by phenolated lignin have comparable properties as those using conventional PF resins (Cetin & Ozmen, 2002).

2.6.2. Lignin Thermolysis Techniques

Studies indicate that for every nine-carbon unit of Kraft Lignin (KL), there are only 0.3 reactive aromatic sites available for formaldehyde addition (Hu *et al.*, 2011; Pizzi *et al.* 1989; Marton *et al.* 1996). Additionally, methyl groups block more than half of the potentially reactive non-aliphatic hydroxyl groups in KL resulting in steric hindrance. To counteract this effect, several lignin de-polymerization techniques could be used to increase the reactivity of lignin. In thermolysis of lignin, thermal energy or heat is applied to lignin in the presence or absence of catalysts, solvents, and/or additives (Amen-Chen *et al.*, 2001; Effendi *et al.*, 2008). Improving the reactivity of lignin using thermo-chemical depolymerization techniques such as pyrolysis, liquefaction, oxidation, hydrogenolysis, and hydrolysis has also been extensively reviewed (Nimani, 2011). Although most of the de-polymerization techniques involve the application of heat, there are remarkable differences in the preferred temperature range, the use of solvents, and/or in the use of catalysts. Pyrolysis of lignin, for instance, involves thermal treatment in the absence of oxygen. In contrast, hydrogenolysis uses hydrogen to cleave the bonds within the structure of lignin and favors higher yields of liquid while hydrolysis uses water as the primary solvent for lignin conversion often with the use of an alkaline catalyst (Mahmood *et al.*, 2013). Depending on the thermolysis technique as well as the severity of the reaction, lignin de-polymerization products may vary in the yields and composition of liquid (de-polymerized lignin, DL), gaseous, and solids components.

Pyrolysis:

Of all the thermolysis techniques, pyrolysis is the most studied for the conversion of biomass into liquid, gaseous, and solid products. Pyrolysis of lignin in particular is influenced by various factors including the heating rate, reaction temperature, additives,

and the type of feedstock. Weaker bonds are broken at lower temperatures in the range of 120°C to 300°C while stronger bonds breakage including aromatic ring cracking occurs at higher temperatures of greater than 500°C. Secondary reactions become increasingly important at temperatures higher than 400°C. Major products include lower molecular weight liquid products such as monophenols, monolignols; non-condensable gaseous products such as carbon dioxide, carbon monoxide and gaseous hydrocarbons; and solid char.

Hydrogenolysis:

When performed in the presence of hydrogen under heat with temperatures ranging from 300°C to 600°C, the lignin depolymerization technique is known as hydrogenolysis or hydrogenation. In this reaction process, hydrogen can be supplied in its gaseous form or via hydrogen donating solvents such as tetralin or formic acid (Nimani, 2011).

Hydrogenolysis of lignin is a very promising technique for the production of bio-phenols as it can lead to higher yields of monophenols with higher net conversions and less char formation, provided the use of suitable solvents and catalysts. Highest conversions rates could be achieved when the lignin feedstock is subjected to a pretreatment process such as microwave or ultrasound irradiation prior to hydrogenolysis. Of increasing interest among researchers (Shabtai *et al.*, 2001; Vigneault *et al.*, 2007) is the incorporation of lignin hydrogenolysis in a multistage lignin conversion process known as Base-Catalyzed Depolymerization – Hydrogenolysis Treatment (BCD-HT) for the production of reformulated gasoline (Nimani, 2011).

Oxidation:

Due to the presence of hydroxyl groups within the structure of lignin, oxidation or even oxidative cracking can be used to modify the structure of lignin for value-added biochemicals depending on the application of interest. With varying reaction severities and oxidants such as nitrobenzene and metal oxides or catalytic oxidation agents such as oxygen, products may range from aldehydes to carboxylic acids (Nimani, 2011). For instance, using potassium dichromate as an oxidizing agent resulted in formation of catechol groups with reduced methoxyl content and increased phenolic hydroxyl content. Other common oxidation reagents used in lignin oxidation studies include hydrogen

peroxide, nitrobenzene, and copper (II) oxide. Depending on the oxidation agent, temperature, and time, lignin-modified molecules with significant variations of aromatic aldehydes and hydroxycinnamic acids may be produced (Hu *et al.*, 2011). Important considerations for lignin oxidation include the cost, selectivity as well as recovery rate of the catalysts. Reducing agents may also be required to cap the lignin oxidation reactions.

Hydrolysis:

In hydrolysis, sub-or-supercritical water is used to rupture the ether bonds that link phenyl-propane units within the lignin molecule usually in the presence of an acid or an alkaline catalyst resulting in lower molecular weight phenolic compounds (Yuan *et al.* 2010; Hu *et al.* 2011). Studies have shown that hydrolysis of lignin increases the content of phenolic hydroxyl content particularly under increased reaction severities, thereby increasing the reactivity of lignin toward formaldehyde (El Mansour *et al.*, 2006). Mahmood *et al.* (2013) from our group reported that ¹H NMR results of Kraft lignin hydrolytic processing indicated that increases in severity treatment of hydrolytic processing resulted in increases of phenolic hydroxyl groups in the products as compared to the phenolic-OH groups in original Kraft lignin. Hydrolysis is advantageous because of its milder process conditions compared to pyrolysis; however, lignin yields can be much lower at extreme severities due to re-polymerization of intermediates to form into char particularly under acidic conditions (Hu *et al.* 2011; Yuan *et al.*, 2010). To address this issue, alkaline catalysts can be used to cap the reaction, prevent further char formation, and promote higher conversion rates. Catalysts can also be used to selectively cleave bonds resulting in higher selectivity for use in end products. Previous studies have shown that base catalysts such as potassium hydroxide and sodium hydroxide can be effective in attaining high lignin yield during hydrolysis reactions (Miller *et al.*, 1999; Yuan *et al.*, 2010; Nimani, 2011; Yoshikawa, 2013).

2.7. Concluding Remarks

Production of lignin-based phenol formaldehyde (LPF) resins has gained increasing interest given the depleting fossil-fuel reserves and increasing environmental concerns over the feedstock of phenol formaldehyde resins. Given the complex structure of lignin, replacement of phenol with lignin at a large percentage in PF resole synthesis presents a

few technological challenges including reduced mechanical strength properties and increased curing temperature and curing time when high phenol-to-lignin substitution rates are employed. Recent efforts have focused on increasing the reactivity of lignin by pretreatment with phenol or formaldehyde via the phenolation or methylation process, respectively, or by de-polymerizing the lignin molecule into smaller bio-phenolic oligomers through the application of heat (thermolysis). De-polymerization techniques present an opportunity to synthesize bio-phenolic resins with minimal inclusion of petroleum-derived phenols as the feedstock materials. Hydrolytic lignin de-polymerization technique is of particular interest as it eliminates the need for use of organic solvents in the reaction and requires moderate reaction temperatures while also increasing the phenolic hydroxyl content of the DL products (Mahmood *et al.*, 2013). However, so far there has been limited practical success on producing lignin-based phenol formaldehyde (LPF) resins at high lignin-to-phenol percent substitutions (Jones, 2007).

The main objective of this research work is synthesize lignin-based phenol formaldehyde resins (LPF) using depolymerized Kraft lignin at high percent substitutions. Three key synthesis parameters, including the formaldehyde-to-phenol ratio, the weight average molecular weight of depolymerized lignin, and the percent substitution of phenol with lignin, were optimized in order to achieve lower possible curing temperatures and higher possible adhesive strength for plywood adhesive application.

2.8. References

- Abdelwahab, N. A., & Nassar, M. A. (2011). Preparation, optimisation and characterisation of lignin phenol formaldehyde resin as wood adhesive. *Pigment & Resin Technology*, 40(3), 169-174.
- Amen-Chen, C., Pakdel, H., & Roy, C. (2001). Production of monomeric phenols by thermochemical conversion of biomass: A review. *Bioresource Technology*, 79(3), 277-99.
- Ayoub M H. 1997. Emulsion copolymerization latexes for interior and exterior coatings. *Pigm Resin Technol*, 261: 6–11

- Binder, J. B., Gray, M. J., White, J. F., Zhang, Z. C., & Holladay, J. E. (2009). Reactions of lignin model compounds in ionic liquids. *Biomass and Bioenergy*, 33(9), 1122-1130.
- Cetin, N. S., & Özmen, N. (2002). Use of organosolv lignin in phenol--formaldehyde resins for particleboard production: I. Organosolv lignin modified resins. *International Journal of Adhesion and Adhesives*, 22(6), 477-480.
- Cheng, S., Dacruz, I., Yuan, Z., Wang, M., Anderson, M., Leitch, M., Xu, C. (2011). Use of biocrude derived from woody biomass to substitute phenol at a high- substitution level for the production of biobased phenolic resol resins. *J. Applied Polymer Science*, 121,2743-2751.
- Cheng, S., Dacruz, I., Wang, M., Leitch, M., & Xu, C. (2010). Highly efficient liquefaction of woody biomass in hot-compressed alcohol- water co-solvents. *Energy & Fuels*, 24(9), 4659-4667.
- Chow, S. (1983). Adhesive developments in forest products. *Wood Science and Technology*, 17 (1), 1-11.
- Decatur, G. (1989). The correlation between preparation and properties in phenolic resins. *Wood Adhesives: Chemistry and Technology*, 2, 121.
- Eckelman, C. A. (1999). *Brief survey of wood adhesives*. Purdue University Cooperative Extension Service.
- Effendi, A., Gerhauser, H., & Bridgwater, A. V. (2008). Production of renewable phenolic resins by thermochemical conversion of biomass: A review. *Renewable and Sustainable Energy Reviews*, 12(8), 2092-2116.
- El Mansouri, N. -E., Farriol, X., & Salvadó, J. (2006). Structural modification and characterization of lignosulfonate by a reaction in an alkaline medium for its incorporation into phenolic resins. *Journal of Applied Polymer Science*, 102(4), 3286-3292.
- EPA. (2012). Formaldehyde. [Web page]. Retrieved October 20, 2013 from <http://www.epa.gov/iaq/formaldehyde.html>
- Gardner, D. J. (2006). Adhesion mechanisms of durable wood adhesive bonds. *Characterization of the Cellulosic Cell Wall*, 254-265.
- Gosselink, R. J. A. (2011). *Lignin as a renewable aromatic resource for the chemical industry*. Wageningen University.
- Hall, J., Matos, S., Martin, M., & Bachor, V. (2012). Overcoming technological, commercial,organizational and social uncertainties of innovation: The case of forest

biomass as a replacement of petroleum-based feed stocks. In *Technology management for emerging technologies (PICMET), 2012 proceedings of PICMET'12*: (pp. 249-258).

- Holopainen, T., Alvila, L., Rainio, J., & Pakkanen, T. T. (1997). Phenol-formaldehyde resol resins studied by ¹³C-NMR spectroscopy, gel permeation chromatography, and differential scanning calorimetry. *Journal of Applied Polymer Science*, 66(6), 1183-1193.
- Hu, L., Pan, H., Zhou, Y., & Zhang, M. (2011). Methods to improve lignins reactivity as a phenol substitute and as replacement for other phenolic compounds: A brief review. *BioResources*, 6(3), 3515-3525.
- Huber, G. W., Iborra, S., & Corma, A. (2006). Synthesis of transportation fuels from biomass: Chemistry, catalysts, and engineering. *Chem Rev*, 106(9), 4044-98.
- Jones, D. (2007). *Review of existing bioresins and their applications*. BRE Ltd. Keimel, F. A. (2003). Historical development of adhesives and adhesive bonding. *Handbook of Adhesive Technology*, 1-12.
- Kirk-Othmer Encyclopedia of Chemical Technology [electronic resource], Web ed., John Wiley & Sons, New York, 1999-2008, Vol. 21.
- Kopf, P.W. (2002). Phenolic resins. *Encyclopedia of Polymer Science and Technology*, 7, 233-268. Retrieved from <http://onlinelibrary.wiley.com/doi/10.1002/0471440264.pst236/abstract>
- Laborie, M. -P. G. (2002). *Investigation of the wood/phenol-formaldehyde adhesive interphase morphology*. Thesis. Blacksburg, VA: Virginia Polytechnic Institute and State University.
- Lee, J., Jeon, J., & Kim, S. (2011). Green adhesives using tannin and cashew nut shell liquid for environmentfriendly furniture materials. *Journal of the Korea Furniture Society*, 22(3), 219-229.
- LigniMATCH. (2011). Future use of lignin in value added products – a roadmap for possible Nordic/Baltic Innovation. Retrieved May 2013 from <http://www.scanbalt.org/files/graphics/ScanBalt/Activities/ScanBalt%20Bridge%20Award/Roadmap%20100823.pdf>
- Lin, Z. X., Ouyang, X. P., Yang, D. J., Deng, Y. H., & Qiu, X. Q. (2010). Effect of hydroxymethylation of lignin on the properties of lignin-phenol-formaldehyde resins. *World Sci-Tech R&D*, 32(3), 348-351.
- Lora, J.H., Glasser, W.G. (2002). Recent industrial applications of lignins: A sustainable alternative to non-renewable materials, *J. Polym. Environ.* **10**, 39–48.

- Mahmood, N., Yuan, Z., Schmidt, J., & Charles Xu, C. (2013). Production of polyols via direct hydrolysis of kraft lignin: Effect of process parameters. *Bioresource Technology*, 139, 13-20.
- Marton, J., Marton, T., Falkehag, S. I., & Adler, E. (1966). Alkali-catalyzed reactions of formaldehyde with lignins. *Lignin Structure and Reactions. Advances in Chemistry Series*, 59, 125-144.
- Miller, J. E., Evans, L., Littlewolf, A., & Trudell, D. E. (1999). Batch microreactor studies of lignin and lignin model compound depolymerization by bases in alcohol solvents. *Fuel*, 78 (11), 1363-1366.
- Nimani, L. (2011). Lignin depolymerization and conversion. 2011 Wisconsin Bioenergy Summit. Retrieved from <http://www.slideshare.net/lnimani/lignin-depolymerization-and-conversion-15269049>
- Liu, T. J., & Xu, X. Y. (2000). Preparation of PVAc emulsion through copolymerization. *Guangdong Chem Ind*, 6: 71-73
- Pilato, L. (2010). *Phenolic resins: A century of progress*. Berlin Heidelberg: Springer-Verlag.
- Pizzi, A. (2003). Phenolic resin adhesives. *Handbook of Adhesive Technology*, 541-571.
- Pizzi, A. (2006). Recent developments in eco-efficient bio-based adhesives for wood bonding: Opportunities and issues. *Journal of Adhesion Science and Technology*, 20(8), 829-846.
- Pizzi, A., Cameron, F. -A., & van der Klashorst, G. H. (1989). Soda bagasse lignin adhesive for particleboard. *Adhesives From Renewable Resources*, 82-95.
- Raquez, J. M., Deléglise, M., Lacrampe, M. F., & Krawczak, P. (2010). Thermosetting (bio) materials derived from renewable resources: A critical review. *Progress in Polymer Science*, 35(4), 487-509.
- Rowell, R. M. (2012). *Handbook of wood chemistry and wood composites*. Boca Raton, FL: CRC press.
- Santana, M. A., Baumann, M. G., & Conner, A. H. (1995). Resol resins prepared with tannin liquified in phenol. *Holzforchung-International Journal of the Biology, Chemistry, Physics and Technology of Wood*, 49(2), 146-152.
- Sellers, T. (2001). Wood adhesive innovations and applications in north america. *For Prod J*, 51 (6), 12-22.

- Shabtai, J. S., Zmierzak, W. W., & Chornet, E. (2001). *Process for conversion of lignin to reformulated, partially oxygenated gasoline*. Google Patents.
- So, S., & Rudin, A. (1990). Analysis of the formation and curing reactions of resol phenolics. *Journal of Applied Polymer Science*, 41(1-2), 205-232.
- SRI consulting. (2010). World Petrochemical (WP) report on PF Resins. Retrieved May 2013 from http://www.sriconsulting.com/WP/Public/Reports/pf_resins/
- Tonge, L. (2007). *Thermochemical properties of methylol phenol monomers and phenol formaldehyde resoles*. Thesis. Hawthorn, Australia: Faculty of Engineering and Industrial Sciences, Swinburne University of Technology.
- Van Langenberg, K., Grigsby, W., & Ryan, G. (2010). Green adhesives: Options for the Australian industry-summary of recent research into green adhesives from renewable materials and identification of those that are closest to commercial uptake. *Forest & Wood Products for Australia, PNB158-0910*.
- Vigneault, A., Johnson, D. K., & Chornet, E. (2007). Base-Catalyzed depolymerization of lignin: Separation of monomers. *The Canadian Journal of Chemical Engineering*, 85(6), 906-916.
- Wang, H., Tucker, M., & Ji, Y. (2013). Recent development in chemical depolymerization of lignin: A review. *Journal of Applied Chemistry*, 2013.
- Wang, J. (2007). *Cure kinetics of wood phenol-formaldehyde systems*. Thesis. Washington: Department of Civil and Environmental Engineering, Washington State University.
- Wang, M., Leitch, M., Xu, C (2009). Synthesis of phenol-formaldehyde resol resins using organosolv pine lignins. *European Polymer Journal*, 45, 3380–3388.
- Wilson, J. B. (2010). Life-cycle inventory of formaldehyde-based resins used in wood composites in terms of resources, emissions, energy and carbon. *Wood and Fiber Science*, 42, 125-143.
- Yadav, R., & Srivastava, D. (2012). Statistical design and response surface technique for the optimization of cardanol based phenolic polymer. *Archives of Applied Science Research*, 4 (5), 2261-2273.
- Yoshikawa, T., Yagi, T., Shinohara, S., Fukunaga, T., Nakasaka, Y., Tago, T., & Masuda, T. (2013). Production of phenols from lignin via depolymerization and catalytic cracking. *Fuel Processing Technology*, 108, 69-75.
- Yuan, Z., Cheng, S., Leitch, M., & Xu, C. C. (2010). Hydrolytic degradation of alkaline lignin in hot-compressed water and ethanol. *Bioresource Technology*, 101(23),

9308-13. doi:10.1016/ j.biortech.2010.06.140

- Zabaleta, A. T. (2012). *Lignin extraction, purification, and depolymerization study*. Monogram. Retrieved from http://www.ehu.es/argitalpenak/images/stories/tesis/Ciencias/ANA_TOLEDANO.pdf
- Zhao, B. Y., Hu, K. A., & Wu, R. J. (2000). Primary study on the phenolic modification of sodium lignosulphoate. *Polymer Materials Science and Engineering, 1*, 158-161.
- Zhao, L. F., Liu, Y., Xu, Z. -D., Zhang, Y. -Z., Zhao, F., & Zhang, S. -B. (2011). State of research and trends in development of wood adhesives. *Forestry Studies in China, 13*(4), 321-326.
- Zhang, J. T., Yang, X. Q., & Huang, L. X. 2004. Progress of studies on modified soy protein adhesives. *Adhes China, 25*(4): 32-34

Chapter 3: Synthesis of Lignin-based PF (LPF) Resoles at Large Phenol Substitution Ratios using De-polymerized Lignin from Hydrolytic Depolymerization of Kraft Lignin: Physical Properties

3.1. Introduction

Due to depleting fossil fuel reserves, researchers are increasingly interested in use of bio-resins as adhesives for various engineered wood products (plywood, OSB, particleboard, etc.). Of particular importance has been using renewable feedstock as raw materials for the production of phenol formaldehyde (PF) resins, which have widely been used as plywood adhesives due to their superior moisture resistance as well as excellent mechanical strength properties. Synthesis of PF resins involves reaction of formaldehyde with phenol, and the feedstock phenol is currently derived from non-renewable fossil resources such as oil and natural gas. In addition to non-renewable origins, petroleum derived phenol is also associated with high costs and toxicity. As such, there is an incentive to replace the petroleum-based phenol with a renewable alternative for the production of PF resins. Lignin is the second most abundant natural polymer consisting of natural aromatic/phenolic building blocks, so it has been of particular interest among researchers for use of lignin as replacement to phenol for the production lignin-based PF resins (LPF).

Lignin is one of the three components of lignocellulosic biomass, comprising around 10-30% of its dry mass and 40% of its energy content. Lignin is a complex macromolecule with three different phenyl-propane monomer units including p-hydroxy- phenyl-propanol, guaiacyl-propanol, and syringyl-propanol and two main types of linkages: ether linkages such as α -O-4 and β - O-4 and condensed linkages such as 5-5 and b-1 linkages (Charkar & Ragauskas, 2004). Though the exact structure of lignin in its native form is still unknown, major functional groups that influence the reactivity of lignin include aliphatic hydroxyl, phenolic, methoxyl, carboxyl, carbonyl, benzyl alcohol, and noncyclic benzyl ether groups (Effendi *et al.*, 2008; Nimani, 2011). The percentage of linkages,

phenyl-propane monomers, and various functional groups depend on the origin of the lignin as well as the extraction and isolation technique used. For instance, hardwood lignin contain about 72% ether linkages while softwood lignin contain about 56% ether linkages (Pu *et al.*, 2008). Lignins (Kraft lignin and lignosulfonates) are produced as a byproduct in the form of “black liquor” at a large amount from pulping processing, where the annual production rate is estimated at 50 Mt. At present, only around 1-2% of the Kraft lignin (KL) from pulping processing is separated from black liquor; most of the remainder is used in recovery boiler for heat and pulping chemicals recovery. However, KL provides a promising pathway for making use of low-value side-stream of pulping processes for production of high value biomaterials (e.g., lignin-based PF resins).

However, preliminary studies on lignin-based phenol formaldehyde resins (LPF) with high phenol substitution ratios indicate higher curing temperatures (Hu *et al.*, 2011; Wang *et al.*, 2009); thereby, limiting successful substitution of phenol with lignin in the manufacture of phenolic resins at only 50% without compromising the mechanical and thermal properties of the resins. Direct use of lignin in the synthesis of phenolic resins is associated with several challenges including steric hindrance as well as availability of fewer reactive sites, resulting in reduced reactivity of lignin as compared to petroleum-derived phenol. To improve the reactivity of lignin with formaldehyde, researchers have offered suggestions for applying chemical modifications to lignin prior to its usage in PF synthesis (Hu *et al.*, 2011). Examples of chemical modification techniques include pretreatment of lignin with phenol or formaldehyde in phenolation or methylation (Lin *et al.*, 2010; Zhao *et al.*, 2011) and application of heat in thermolysis reactions such as pyrolysis, hydrogenolysis, oxidation, and hydrolysis for lignin de-polymerization (Mahmood *et al.*, 2013).

De-polymerization techniques offer opportunities for higher substitutions of phenol with lignin. Of the depolymerization techniques, hydrolysis of lignin is advantageous for a few reasons: it offers a milder process than pyrolysis and does not necessitate the use of expensive organic solvents and hydrogen gas. In hydrolysis, the aryl ether linkages are ruptured in sub or supercritical conditions, and often in the presence of a catalyst

(Mahmood *et al.*, 2013). For phenolic resins, the presence of non-aliphatic hydroxyl phenols is important to allow for increased reactivity of depolymerized lignin products with formaldehyde. According to El Masouri *et al.* (2006), the content of hydroxyl phenolic compounds in the products increases with increased reaction severities. This observation was also supported by the ¹H NMR results conducted by Mahmood *et al.* (2003) on hydrolysis of kraft lignin at various reaction severity conditions. However, one of the major concerns with using hydrolysis is the increase in the re-polymerization reactions of the intermediates where the yield of the char is unfavorably increased at too high severity conditions, in particularly in acid hydrolysis at conditions of high temperature and pressure severities (Mahmood *et al.*, 2013). Many previous studies on hydrolytic depolymerization of lignin with the use of alkaline catalysts such as potassium hydroxide and sodium hydroxide have shown promising results in terms of the lignin conversion, yield of de-polymerized lignin (DL), and molecular weight of the DL products (Miller *et al.*, 1999; Yuan *et al.*, 2010; Nimani, 2011; Yoshikawa, *et al.*, 2013).

The DL products from the hydrolytic depolymerization of Kraft lignin can be a promising phenol substitute for the synthesis of lignin-based PF (LPF) resins at a large phenol substitution ratio. This is because the DL products have lower Mw (with reduced steric hindrance effect) and higher content of hydroxyl phenols (hence more reactive sites) as compared to original Kraft lignin (El Masouri *et al.*, 2006; Mahmood *et al.*, 2013).

PF resoles are manufactured by the reaction of phenol with formaldehyde typically at atmospheric pressure and temperatures of around 80°C-100°C in the presence of an alkali catalyst such as sodium hydroxide for a period of two to four hours (Pilato, 2010). The alkali catalyst increases the water solubility of the resin to allow for high degree of condensation reactions (Dunky, 2003). Findings from Abdelwahab & Nassar (2011) indicate that increasing the concentration of sodium hydroxide is favorable in increasing the adhesive strength of LPF resins only until around 10wt% based on phenolic mass. Beyond 10wt%, the adhesive strength of phenolic resins is compromised. The reaction temperature of PF synthesis is important as it influences the methylation reactions and the degree of condensation reactions (Pilato, 2010). Abdelwahab & Nassar (2011) also

studied the effect of temperature (60°C, 80°C, and 100°C) on the solid content, the gel time, and the adhesive strength of LPF and determined that the most optimal reaction temperature during the manufacture of LPF resins is 80°C, where the adhesive strength of the resultant LPF resin was found to be the highest. Molar ratio of formaldehyde-to-phenol (F/P) is one of the most important contributors that influence the properties of PF resoles. For plywood applications, F/P ratios of 1:1 and higher up to 3:1 are used in the feedstock to synthesize resoles. Higher F/P ratios increase the reaction rates resulting in final polymeric structures that are highly crosslinked and have high viscosities and molecular weights (Park *et al.*, 2002; Tonge, 2007).

While lignin hydrolysis demonstrated to be effective for decreasing the Mw of Kraft lignin and increasing the content of hydroxyl phenols (El Masouri *et al.*, 2006; Mahmood *et al.*, 2013), there has been limited research work on applications of the DLs in the synthesis of LPF. Thus, one objective of this chapter is to de-polymerize KL into three different molecular weight ranges using different hydrolysis reaction severities (by varying temperatures and residence time). The other objective of this work is to synthesize LPF resins using the DL products of various Mw obtained from hydrolytic depolymerization of KL, and characterize its physical properties (non volatile content and viscosities) of the resultant LPF resins. For adhesives for engineered wood manufacture applications, the most important physical properties are characterized by nonvolatile content of around 40-45% as well as viscosity in the range of 150-600 cP at 25°C (Pizzi, 2003).

3.3. Experimental

3.3.1. Design of Experiments

For future optimization of the LPF synthesis process (results to be presented in Chapter 5), aiming to attain LPF resins with lower possible curing temperatures for energy saving purposes and higher possible bond strength, Box-Behnken Design (BBD) of experiments was employed (see Section 6.2.1 for more information about BBD). In the BBD of the experiments, the following three key synthesis parameters were chosen based on literature studies and the authors' experience:

F/P molar ratios ($X_1 = 1.2, 2.1$ and 3);
 Phenol substitution percentages ($X_2 = 25, 50$ and 75 wt%); and
 Mw levels of the DL products ($X_3 = 800, 1200$ and 1700 g/mol).

The above three parameters were varied across three levels (-1, 0, and +1) and a total of 15 experimental runs using a Box-Behnken Design (BBD) of experiments, as listed in Tables 3-1 and 3-2 respectively.

Table 3- 1: Three parameters and three levels of the Box-Behnken experimental design

Parameter	Variable	Level (-1)	Level (0)	Level (+1)
Formaldehyde-to-phenol molar ratio (F/P)	X_1	1.2	2.1	3
Phenol substitution ratio (%)	X_2	25	50	75
Weight average molecular weight of DL, Mw (g/mol)	X_3	800 ¹	1,200 ²	1,700 ³

¹ Hydrolytic de-polymerization at 350°C & 45 min; ² Hydrolytic de-polymerization at 300°C & 60 min; ³ Hydrolytic de-polymerization at 250°C & 45 min. All these Mw results are relative molecular weight in-lab analyzed by GPC-UV calibrated with polystyrene standards.

Table 3- 2: Experimental runs using a Box-Behnken Design (BBD) of experiments

Sample ID*	Experiment Number	Variable Levels		
		X_1	X_2	X_3
LPF-25,(0),1.2	1	-1	0	-1
LPF-25,(0),3	2	-1	0	+1
LPF-75,(0),1.2	3	+1	0	-1
LPF-75,(0),3	4	+1	0	+1
LPF-50,(-1),1.2	5	0	-1	-1
LPF-50,(-1),3	6	0	-1	+1
LPF-50,(+1),1.2	7	0	+1	-1
LPF-50,(+1),3	8	0	+1	+1
LPF-25,(-1),2.1	9	-1	-1	0
LPF-75,(-1),2.1	10	+1	-1	0
LPF-25,(+1),2.1	11	-1	+1	0
LPF-75,(+1),2.1	12	+1	+1	0
LPF-50,(0),2.1 (1)	13	0	0	0
LPF-50,(0),2.1 (2)	14	0	0	0
LPF-50,(0),2.1 (3)	15	0	0	0

3.3.2. Materials

Softwood Kraft lignin (KL) was obtained from FPInnovations Lignin Pilot Plant in Thunder Bay, Ontario, in a light brown powder form. Given that it was originated from pulping processing, it has a faint odour and has a high sulfur content of 5.2 wt% based on dry ash free basis. Using a muffle furnace, the ash content of original KL powder was determined to be 0.57 wt% on a dry basis. Preliminary GPC-UV analysis on the original KL obtained showed that the relative average weight molecular weight (M_w) was around 10,000 g/mol with a polydispersity index (PDI) of 2.0. For KL hydrolysis experiments, all chemicals were obtained from Sigma-Aldrich and including acetone 99.5% purity, sulfuric acid 99% purity, and HPLC grade tetrahydrofuran or THF for GPC analysis. The chemicals used for LPF resin synthesis include solid phenol crystals at 99% from J.T Baker, formaldehyde as 37% formalin from Anachemia, 50% sodium hydroxide solution from Ricca Chemical Company, and ethanol from Fisher Scientific.

3.3.3. Procedure for Hydrolytic Depolymerization of Lignin

The hydrolytic depolymerization of KL operations was carried out in a 500 mL Parr Model 4848 autoclave reactor. It was equipped with a pressure gauge, stirrer, thermocouple, gas line, and sampling line. The reactor was charged with 48g lignin and 60g distilled water and 132g NaOH solution (10 wt%). The reaction substrate was 20wt% concentration. The air inside the reactor was removed by repetitive vacuum-purge, and the reactor was pressurized with nitrogen to initial pressure of 290 psi. To ensure proper mixing of the reactor contents, the mixture was pre-mixed for 30 minutes by 390 rpm stirring. The reactor was then heated at approx. 10°C/min to desired temperatures for specific residence times under stirring at 390 rpm, according to Table 3-3. After the set residence time for reaction, the reactor was quenched to room temperature with water cooling. The gas was released into a gas bag and vented into a fume hood, and the reaction products were collected in a 1000 mL flask using distilled water, which was then acidified to pH~2.0 using 1 M of sulfuric acid to precipitate the DL products, followed by filtration using distilled water. The water insoluble filter cake containing DL and solid residues as well as ash was then filtered again using acetone washing to dissolve DL. The DL was then separated by rotary evaporation of acetone solvents, followed by finally

drying in a vacuum oven at 50°C overnight to obtain the weight of water/solvent-free DL products. After overnight drying, the mass of DL products collected was measured to obtain the DL yield as weight percent of original dry KL. The solid residues (SR) from the second filtration stage were dried in an oven at 105°C for 24 hours.

It should be noted that, the set reaction temperatures and residence times were carefully chosen based on preliminary tests in order to obtain DL products at three levels (-1, 0, and +1) weight average molecular weights, Mw. The reaction conditions for each lignin molecular weight level (-1, 0, and +1) as listed on Table 3-3, where the (-1) level indicates DL products with the lowest weight average molecular weight Mw, (0) level indicates DL products with moderate weight average molecular weight Mw, and (+1) indicates DL products with highest weight average molecular weight Mw. The measured relative Mw for each level is given in the Results and Discussion section of this chapter.

Table 3- 3: Set reaction temperatures and residence times corresponding to target lignin molecular weight levels

Lignin Molecular Weight (Mw) Level	Set-Reaction Temperature (°C)	Residence Time (min)
Mw level (-1)	350	45
Mw level (0)	300	60
Mw level (+1)	250	45

3.3.4. Synthesis of LPF resoles

Various LPF resoles were synthesized with DL of different Mw values, phenol percent substitutions, and F/P molar ratios, according to the Box-Behnken Design (BBD) of experiment Design table (Table 3-2). The resinification was carried out in a 250 mL three-neck flask equipped with a thermometer, a pressure-equalizing addition funnel, and a condenser and then placed over a water-bath on top of a hot plate. The mixture of phenol, DL, sodium hydroxide, ethanol and water were added at pre-determined amounts into the three-neck flask. The required amounts of phenol and lignin were determined by the phenol percent substitution ratio for the experimental run from the BBD. Sodium hydroxide solution and water were added at concentrations of 10wt% and 40wt% based

on phenolic compounds, respectively, referring to the literature study (Abdelwahab & Nassar (2011)). Ethanol was added to improve the solubility of DL at a mass equal to that all phenolic compounds including pure phenol and DL. To avoid the formation of coagulants during the reaction especially at high percent phenol substitutions, sodium hydroxide solution was mixed with phenol and added drop wise. The mixture was allowed to mix for a period of two hours under magnetic stirring at 60°C to ensure a homogenous lignin-phenol solution.

The reaction temperature was then increased to 80°C and formalin (37% formaldehyde by weight) was added drop-wise into the three-neck flask using a cylindrical separatory funnel given that the reaction is exothermic. The amount of formaldehyde added was determined by the required F/P molar ratio of the experimental run, where P denotes all phenolic compounds including phenol and DL (assuming Mw of phenolic compounds to be 94.11 g/mol to calculate F/P ratios). The reaction was held at 80°C for two hours, and then stopped by cooling to room temperature. The resultant LPF resin was then recovered into labeled 250 mL plastic bottles and stored in the freezer at -2°C for further characterization purposes. The synthesized LPF resins were labeled as “LPF-25,(+1),2.1”, denoting LPF-% phenol substitution, (the DL Mw level), F/P ratio. For example, LPF-25,(+1),2.1 indicates that the LPF has phenol substitution ratio of 25% with DL of the highest Mw level and was synthesized using F/P ratio of 2.1. In a typical resinification experiment, e.g., to produce 150 mL of LPF-50,(0),2.1, 18g of DL at Mw level of (0) were allowed to mix with 18g of phenol, 36 mL of ethanol and 14.4g of distilled water followed by an addition of 65.2g of formalin for F/P molar ratio of 2.1:1.

3.3.5. DL and LPF Product Characterizations

The relative weight average molecular weight, Mw, of the DL products was measured for each specified reaction severity (see Table 3-3) using a Waters Breeze Gel Permeation Chromatography (GPC) instrument with a binary bump, UV detector at 270 nm, and Water Styragel HR1 column at 40°C, where tetrahydrofuran (THF) was used as the eluent at a flow rate of 1 mL/min. The calibration curves for determination of lignin molecular weight distributions in GPC analysis were created using standards of polystyrene. To prepare depolymerized lignin (DL) samples for GPC, around 10 mg of lignin samples

were dissolved in a vial of 10 mL of THF by placing the vial in a sonic shaker for about 10 minutes and then filtered using 0.045 μm filters. Next, 20 μL of dissolved samples were injected into the GPC column using a syringe needle at a flow-rate of 1 mL/min and allowed to run for a period of 20 minutes. The analysis was repeated twice for each DL sample.

The elemental composition of carbon, hydrogen, nitrogen, and sulfur in the DL samples were analyzed with a CHNS Flash Elemental Analyzer 1112 series and using helium as a carrier gas. Averages of three runs were taken and recorded. Viscosity measurements of the synthesized LPF resoles were taken using Brookfield Digital Viscometer Model DV-E at 50 rpm and room temperature in accordance to recommendations by ISO-2555 for plywood adhesives. An average of three measurements were taken and recorded for each LPF resole.

The pH measurements of final LPF resole products were taken using a digital pH probe at room temperature. An average of three measurements was taken and recorded for each LPF resole. The nonvolatile contents of LPF resoles were determined in accordance to ASTM D4426-01 (2006). Around 1 g of each LPF sample was weighed on a glass dish, and heated in an oven at 125°C for 105 minutes. Next, the LPF sample was placed in a desiccator for a period of 5-15 minutes and then weighed again to determine the weight percentage of the residues in relation to the original liquid LPF sample, i.e. the non-volatile content.

3.4. Results and Discussion

3.4.1. Effect of Reaction Severity on DL yield and Mw

Given the limited or no research work on the impact of lignin Mw on the properties of LPF resins, the Mw of DL products is of particular interest in this research project, where it is used as one of the process parameters for the production of LPF resoles at high phenol substitutions. The relative Mw of the three DL products were obtained and listed in Table 3-4, along with the DLyields from the hydrolysis experiments at various severities.

Table 3- 4: GPC-UV derived relative molecular weight (Mw) and percent yield of the three depolymerized lignin levels

Mw of DL	Reaction Temp. (°C)	Residence time (min)	Mw (g/mol)	DL Yield (wt%)
Level (-1)	250	45	1,700	83.3 ± 3.7
Level (0)	300	60	1,200	71.1 ± 1.7
Level (+1)	350	45	800	31.3 ± 2.4

From Table 3-4, it can be seen that different hydrolysis reaction severities successfully produced DL products of various relative Mw. As the reaction temperature increased from 250°C to 300°C and 350°C for 45 or 60 min, the measured relative Mw for the DL products decreased from 1,700 g/mol to 1,200 g/mol and 800 g/mol, respectively. The relative weight average molecular weights (Mw) of DL products decreased with increasing reaction temperatures. This observation is consistent with findings from Yuan *et al.* (2010) and Mahmood *et al.* (2013). Given that the depolymerization reactions are endothermic, higher temperatures were thermodynamically favorable in promoting greater cleavage of aryl-ether linkages within the polymer chains of the lignin molecule. As a result, the molecular weight of the DL products reduced considerably with higher reaction temperatures.

Additionally, the percent yield of the DL products also decreased with increasing reaction severity from 83.3 wt% for DL Mw level (-1) to 71.1 wt% for DL Mw level (0) and 31.3 wt% for DL Mw level (-1). The original Kraft lignin (KL) from FPIinnovations experienced less depolymerization at 250°C and 45 minutes of hydrolysis reaction (Mw of 1,700 g/mol for the DL) as expected, but it resulted in a higher DL yield of 83.33 wt%. As the reaction temperature increased beyond 250°C, lower yields of DL products were obtained, as can be seen in Table 3-4. At 350°C, the yield of DL products dramatically dropped to 31.3 wt%. The drastic decrease in the yield of DL products was found to be accompanied with the drastic increase in the yield of SR for KL hydrolysis at 350°C likely occurred due to rise in dehydration reactions at higher temperatures as well as increases in re-polymerization reactions, where higher carbon-carbon crosslinking

activity resulted in char formation and less DL products (Yuan *et al.*, 2010; Hu *et al.*, 2011; Mahmood *et al.*, 2013). KL hydrolyzed at 250°C produced the highest yield of DL as well as the lowest yield (1-1.4wt%) of SR products, compared with around 38wt% SR yield at 350°C.

DL with lower Mw can be particularly advantageous in applications for the synthesis of lignin based phenol formaldehyde (LPF) resins, where lignin with lower Mw would result in reduced steric hindrance and provide more phenolic hydroxyl contents (Mahmood *et al.* (2013), which increases the reactive sites towards formaldehyde, thus facilitating the resinification reactions and enabling production of LPF resins at higher phenol substitutions. However, the trade-off for obtaining lower molecular weights DL at a higher reaction severity (or a higher temperature) is the substantially lowered DL yields.

3.4.2. Effect of Reaction Severity on Elemental Compositions of DL Products

To determine the elemental compositions of the DL products, elemental analysis was performed using the CHNS Flash Elemental Analyzer 1112 series. The measured carbon, hydrogen, nitrogen, sulfur, and oxygen compositions of the original Kraft lignin (KL), and DLs obtained from hydrolysis reaction at 250°C and 350°C are comparatively listed in Table 3-5.

Table 3- 5: Elemental compositions of Kraft Lignin (KL) and DLproducts obtained from hydrolysis at reaction temperatures of 250°C and 350°C, both for 45 min.

Reaction Conditions		Elemental composition (wt%, dry and ash-free basis)				
Temperature (°C)	Residence	C	H	N	S	O ^a
	Time (min)					
KL ^b	N/A	63.8	5.4	0.02	5.2	25.6
250	45	63.6±0.18	5.3±0.02	0.07±0.03	1.8±0.11	29.2±0.17
350	45	75.5±0.16	5.9±0.02	0.11±0.01	0.21±0.04	18.2±0.18

^a by difference

^b KL results were taken from Mahmood *et al.* (2013)

Clearly, that sulfur compounds in both DL products are remarkably lower than that in the KL, suggesting that depolymerizing KL using hydrolysis can effectively reduce S content in lignin. As can be seen from Table 3-5, the carbon, oxygen, and hydrogen compositions are almost the same for the KL sample and the DL sample obtained from hydrolysis reaction at 250°C for 45 minutes. This may have attributed to the limited dehydration reactions at such mild reaction conditions, 250°C and 45 minutes. It should be noted that the relative weight average molecular weight M_w at that condition was around 1,700 g/mol, indicating significant de-polymerization of the KL at this condition due to efficient hydrolysis reaction to cleave the ether bonds of the KL macromolecules. Table 3-5 also indicates that at higher hydrolysis reaction temperature of 350°C, the carbon content of DL increased from around 64 wt% (for KL) to 75.5 wt%, accompanied by a marked decrease in oxygen content, dropping from 26 wt% (KL) to 18 wt% (DL at 350°C). This result implies that at a high reaction severity (temperature), the KL is not only subject to deeper depolymerization (leading to a much lower M_w), but a great extent of dehydration reaction that decreases the oxygen content but increases the carbon content of the DL products. This enhanced dehydration reactions at higher temperatures can be evidenced by reduced DL yields and increased SR yields as shown in previous Table 3-4, which is also in a good agreement with the findings from many previous reports (Yuan *et al.*, 2010; Hu *et al.*, 2011; Mahmood *et al.*, 2013).

3.4.3. Viscosity Measurements for LPF Resoles

Table 3-6 shows the viscosities of all LPF resoles determined with Brookfield Viscometer Model DV-E using spindle 1 at 50 rpm and room temperature. Averages of three measurements were recorded.

Table 3- 6: Room temperature viscosities of all LPF resoles synthesized in this study

Sample ID	Viscosity (cP)
LPF-25,(-1),2.1	26 ± 1.2
LPF-50,(-1),1.2	229 ± 8.5
LPF-50,(-1),3	165 ± 7.2
LPF-75,(-1),2.1	191 ± 3.5
LPF-25,(+1),2.1	124 ± 0.4
LPF-50,(+1),1.2	288 ± 0.8
LPF-50,(+1),3	137 ± 1.2
LPF-75,(+1),2.1	348 ± 0.6
LPF-25,(0),1.2	124 ± 0.1
LPF-25,(0),3	16 ± 0.1
LPF-50,(0),2.1	40 ± 0.1
LPF-75,(0),1.2	>5,000
LPF-75,(0),3	>5,000

For better comparison and discussion on the general dependencies of the LPF viscosities on synthesis parameters including phenol percent substitution, F/P molar ratio, and molecular weight of DL used, the above Table 3-6 is divided into three sub-Tables as Tables 3-7, 3-8 and 3-9.

Table 3- 7: Viscosities of LPF resoles with increasing phenol substitution (left to right)

25% Substitution	Viscosity (cP)	75% Substitution	Viscosity (cP)
LPF-25,(-1),2.1	26 ± 1.2	LPF-75,(-1),2.1	191 ± 3.5
LPF-25,(+1),2.1	124 ± 0.4	LPF-75,(+1),2.1	348 ± 0.6

Table 3- 8: Viscosities of LPF resoles with increasing F/P molar ratio (left to right)

F/P of 1.2	Viscosity (cP)	F/P of 3	Viscosity (cP)
LPF-50,(-1),1.2	229 ± 8.5	LPF-50,(-1),3	165 ± 7.2
LPF-50,(+1),1.2	288 ± 0.8	LPF-50,(+1),3	137 ± 1.2
LPF-25,(0),1.2	124 ± 0.1	LPF-25,(0),3	16 ± 0.1
LPF-75,(0),1.2	>5,000	LPF-75,(0),3	>5,000

Table 3- 9: Viscosities of LPF resoles with increasing Mw of the DL used (left to right)

DL Mw (-1): 800g/mol	Viscosity (cP)	DL Mw (+1): 1,700 g/mol	Viscosity (cP)
LPF-25,(-1),2.1	26 ± 1.2	LPF-25,(+1),2.1	124 ± 0.4
LPF-50,(-1),1.2	229 ± 8.5	LPF-50,(+1),1.2	288 ± 0.8
LPF-50,(-1),3	165 ± 7.2	LPF-50,(+1),3	137 ± 1.2
LPF-75,(-1),2.1	191 ± 3.5	LPF-75,(+1),2.1	348 ± 0.6

As well agreed, viscosity measurements of phenolic resins tell important information about the advancement of resol resin synthesis and the degree of condensation reactions (So & Rudin, 1990; Monni *et al.*, 2007). Low resin viscosities or low degree of condensation reactions may result in over-penetration of adhesive into the wood resulting in starved glue-lines while too high viscosities may result in low adhesive penetration as well as poor mechanical interlocking of the adhesive into the wood (Dunky, 2003).

As can be seen from Table 3-7, increasing the phenol percent substitution from 25% to 75% at DL Mw level (-1) and F/P of 2.1 resulted in increase of LPF viscosities from 26 cP to 191 cP. Similarly, increasing the phenol percent substitution from 25% to 75% at DL Mw level (+1) and F/P of 2.1 resulted in increase of LPF viscosities from 124 cP to 348 cP. The increase in viscosity of LPF with higher percent substitutions can be attributed to incorporation of greater lignin content in the LPF resole synthesis. A larger addition amount of lignin or bio-phenolic oils (at a high Mw) likely increases the molecular weight of the resin resulting in higher end viscosities for LPF resoles (Monni *et al.*, 2007) at 75% phenol-to-lignin substitutions. Research findings from Cheng (2011) confirm similar trend of increasing viscosities of bio-based phenolic resins with increasing phenol substitutions.

Table 3-8 shows the viscosities of LPF for increasing F/P molar ratios. Increasing the F/P molar ratio from left to right for various LPF resoles resulted in reduced LPF viscosities. This seems to be counterintuitive because increasing the F/P ratio increases the degree of methylation as well as the branching of the LPF polymer, which should result in increases of viscosities of the LPF resoles. However, this effect might be due to the larger

water contents that were added into LPF resoles with higher F/P ratios in the form of formalin, an aqueous solution of only 37% formaldehyde. This is actually confirmed by the measurements of pH and non-volatile content for the corresponding resoles. As shown in Figure 3-1 and Table 3-11, the corresponding pH value and non-volatile content both decrease if increasing F/P molar ratios likely due to the increased amount of water content in the resulted LPF resoles.

Table 3-9 shows the viscosities of LPF resoles with varying Mw of the DL used. As Mw of DL increased from level (-1) to level (+1), the viscosities of LPF resoles also increased. This trend was consistent for the LPF resoles with 25%, 50%, and 75% phenol substitutions and LPF resoles synthesized at F/P ratios of 1.2 and 3. Using higher Mw of DL in the synthesis of lignin-based phenol formaldehyde resins will likely result in LPF resin with higher molecular weights and increased viscosities (Cheng *et al.*, 2011). Given the complex structure of lignin, higher Mw of depolymerized lignin could result in lengthening of polymeric chains or additional branching within the structure of LPF resoles, which would then significantly increase the viscosities of the LPF resins (Monni *et al.*, 2007).

3.4.4. NVC and pH measurements of LPF Resoles

Tables 3-10, 3-11 and 3-12 shows non-volatile content (NVC) of the synthesized LPF resoles at varying phenol percentage substitutions, varying F/P ratios, and varying Mw the DL used, respectively.

Table 3- 10: NonVolatile Content (NVC) of LPF resoles with varying phenol percent substitutions (left to right)

25%Substitution	NVC (wt%)	75%Substitution	NVC (wt%)
LPF-25,(-1),2.1	36	LPF-75,(-1),2.1	26
LPF-25,(+1),2.1	34	LPF-75,(+1),2.1	30

Table 3- 11: NonVolatile Content (NVC) of LPF resoles with increasing F/P molar ratios (left to right)

F/P of 1.2	NVC (wt%)	F/P of 3	NVC (wt%)
LPF-50,(-1),1.2	44	LPF-50,(-1),3	33
LPF-50,(+1),1.2	35	LPF-50,(+1),3	28
LPF-25,(0),1.2	35	LPF-25,(0),3	30
LPF-75,(0),1.2	41	LPF-75,(0)3	39

Table 3- 12: NonVolatile Content (NVC) of LPF resoles with increasing Mw of DL (left to right)

DL Mw (-1)	NVC (wt%)	DL Mw (+1)	NVC (wt%)
LPF-25,(-1),2.1	NVC = 36	LPF-25,(+1),2.1	NVC = 34
LPF-50,(-1),1.2	NVC = 44	LPF-50,(+1),1.2	NVC = 35
LPF-50,(-1),3	NVC = 33	LPF-50,(+1),3	NVC = 28
LPF-75,(-1),2.1	NVC =26	LPF-75,(+1),2.1	NVC =30

As shown in the above Tables 3-10, 3-11, and 3-12, the NVC of LPF resoles synthesized (26 – 44 wt%) are normally lower than the recommended NVC range for PF resins as plywood adhesives (i.e., 40-45 wt%) (Pizzi, 2003). To increase the NVC, less water or ethanol content can be used as the solvents during the synthesis of LPF resoles or the reaction period can be further increased to 3-4 hours. However, care must be taken not to cause drastic increases in the viscosities of LPF as a result of potential polymer gelation.

Figure 3-1 clearly indicates that pH of LPF resoles decreases with increases in F/P molar ratios for pure PF resins as well as LPF resoles at 25% and 50% phenol substitutions. As discussed earlier, higher water content with increasing F/P ratios likely occurred due to increased formalin input. This also explains the increased non-volatile content (NVC) of LPF resoles with increasing F/P ratios (Table 3-11).

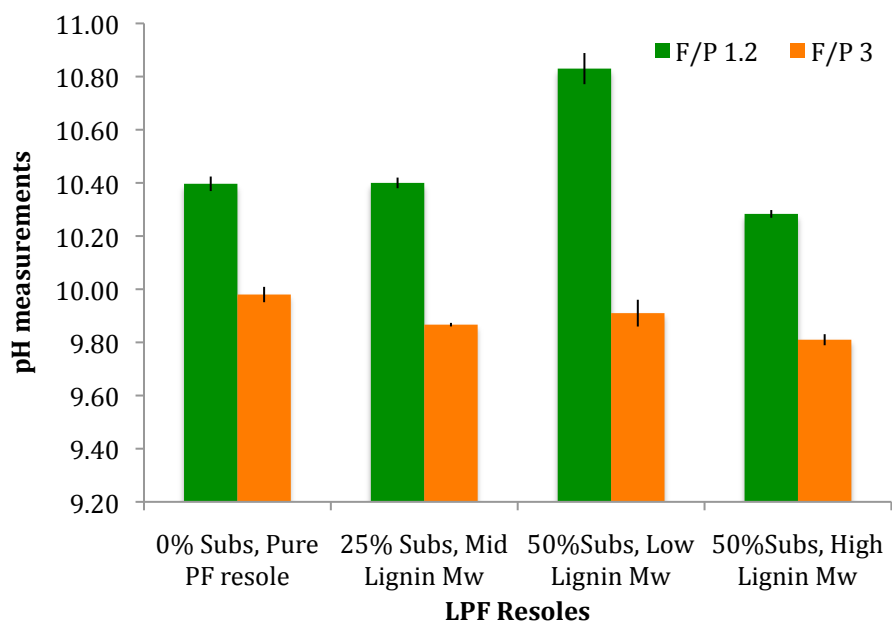

Figure 3- 1: pH of phenolic resoles with varying F/P ratios for pure PF resoles and LPFs at 25% and 50% phenol substitutions

3.5. Conclusions

(1) Kraft lignin was depolymerized into DL products with three distinct relative weight average molecular weights using hydrolysis reaction at varying reaction severities. DL products with a lower Mw were obtained at higher reaction temperatures at the expense of significantly lower yields. At moderate temperature of 300°C, the yield of DL was relatively moderate around 71wt% and the relative Mw was in a moderate range too (1,200 g/mol).

(2) DLs with a lower Mw can be favorable feedstocks for the synthesis LPF resoles due to their reduced steric hindrance and increased reactive sites towards formaldehyde due to the increase in content of phenolic hydroxyl per lignin unit.

(3) CHNS Elemental analysis of the DL products showed that sulfur compounds were reduced by depolymerizing KL using hydrolysis, which implies safer environmental conditions associated with DL products obtained from hydrolysis reactions.

- (4) The obtained DL products at three distinct Mw were successfully incorporated into the manufacture of lignin-based phenol formaldehyde (LPF) at high lignin-to-phenol percent substitution (25-75%).
- (5) Viscosity measurements of LPF resoles were taken for indication of the progress of reaction and as well as the degree of polymerization. Higher viscosities were attained for LPF resoles with higher phenol substitutions and DLs with a higher Mw.
- (6) Lower viscosities, low pH, and lower non-volatile contents (NVC) were observed with increasing F/P ratio due to increased water content as a result of higher formalin content with higher F/P ratios.
- (7) To improve the slightly low NVC of the resoles synthesized, the content of water and solvents used in the synthesis of LPF resoles can be used reduced or the synthesis reaction time can be lengthened. However, it is important to ensure that the resin polymer does not experience gelation during synthesis reactions in order to avoid sudden drastic rise in the viscosities of LPF resoles.

3.6. References

- Abdelwahab, N. A., & Nassar, M. A. (2011). Preparation, optimisation and characterisation of lignin phenol formaldehyde resin as wood adhesive. *Pigment & Resin Technology*, 40(3), 169-174.
- Chakar, F. S., & Ragauskas, A. J. (2004). Review of current and future softwood kraft lignin process chemistry. *Industrial Crops and Products*, 20(2), 131-141.
- Cheng, S., Dacruz, I., Yuan, Z., Wang, M., Anderson, M., Leitch, M., Xu, C. (2011). Use of biocrude derived from woody biomass to substitute phenol at a high-substitution level for the production of biobased phenolic resol resins. *J. Applied Polymer Science* 121: 2743-2751.
- Dunky, M. (2003). Adhesives in the wood industry. *Handbook of Adhesive Technology*, 2.
- Eckelman, C. A. (1999). *Brief survey of wood adhesives*. Purdue University Cooperative Extension Service.

- Effendi, A., Gerhauser, H., & Bridgwater, A. V. (2008). Production of renewable phenolic resins by thermochemical conversion of biomass: A review. *Renewable and Sustainable Energy Reviews*, 12(8), 2092-2116.
- El Mansouri, N. -E., Farriol, X., & Salvadó, J. (2006). Structural modification and characterization of lignosulfonate by a reaction in an alkaline medium for its incorporation into phenolic resins. *Journal of Applied Polymer Science*, 102(4), 3286-3292.
- Hu, L., Pan, H., Zhou, Y., & Zhang, M. (2011). Methods to improve lignins reactivity as a phenol substitute and as replacement for other phenolic compounds: A brief review. *BioResources*, 6(3), 3515-3525.
- Lin, Z. X., Ouyang, X. P., Yang, D. J., Deng, Y. H., & Qiu, X. Q. (2010). Effect of hydroxymethylation of lignin on the properties of lignin-phenol-formaldehyde resins. *World Sci-Tech R&D*, 32(3), 348-351.
- Mahmood, N., Yuan, Z., Schmidt, J., & Charles Xu, C. (2013). Production of polyols via direct hydrolysis of kraft lignin: Effect of process parameters. *Bioresour Technol*, 139, 13-20.
- Miller, J. E., Evans, L., Littlewolf, A., & Trudell, D. E. (1999). Batch microreactor studies of lignin and lignin model compound depolymerization by bases in alcohol solvents. *Fuel*, 78 (11), 1363-1366.
- Nimani, L. (2011). Lignin depolymerization and conversion. *2011 Wisconsin Bioenergy Summit*. Retrieved from <http://www.slideshare.net/lnimani/lignin-depolymerization-and-conversion-15269049>
- Monni, J., Alvila, L., & Pakkanen, T. T. (2007). Structural and physical changes in phenol- formaldehyde resol resin, as a function of the degree of condensation of the resol solution. *Industrial & Engineering Chemistry Research*, 46(21), 6916-6924.
- Park, B. D., Riedl, B., Kim, Y. S., & So, W. T. (2002). Effect of synthesis parameters on thermal behavior of phenol--formaldehyde resol resin. *Journal of Applied Polymer Science*, 83(7), 1415-1424.
- Pilato, L. (2010). *Phenolic resins: A century of progress*. Berlin: Springer.
- Pizzi, A. (2003). Phenolic resin adhesives. *Handbook of Adhesive Technology*, 541-571.
- Pizzi, A. (1994). *Advanced wood adhesives technology*. New York: M. Dekker.
- Pu, Y., Zhang, D., Singh, P. M., & Ragauskas, A. J. (2008). The new forestry biofuels sector. *Biofuels, Bioproducts and Biorefining*, 2(1), 58-73.

- Riedlinger, D. A. (2008). *Characterization of PF resolisocyanate hybrid adhesives*. Thesis. Virginia: Virginia Polytechnic Institute and State University.
- So, S., & Rudin, A. (1990). Analysis of the formation and curing reactions of resol phenolics. *Journal of Applied Polymer Science*, *41*(1-2), 205-232.
- Tonge, L. (2007). *Thermochemical properties of methylol phenol monomers and phenol formaldehyde resoles*. Thesis. Hawthorn, Australia: Faculty of Engineering and Industrial Sciences, Swinburne University of Technology.
- Wang, M., Leitch, M., Xu, C (2009). Synthesis of phenol-formaldehyde resol resins using organosolv pine lignins. *European Polymer Journal*, *45*, 3380–3388.
- Yuan, Z., Cheng, S., Leitch, M., & Xu, C. C. (2010). Hydrolytic degradation of alkaline lignin in hot-compressed water and ethanol. *Bioresource Technology*, *101*(23), 9308-13.
- Yoshikawa, T., Yagi, T., Shinohara, S., Fukunaga, T., Nakasaka, Y., Tago, T., & Masuda, T. (2013). Production of phenols from lignin via depolymerization and catalytic cracking. *Fuel Processing Technology*, *108*, 69-75.
- Zhao, L. F., Liu, Y., Xu, Z. -D., Zhang, Y. -Z., Zhao, F., & Zhang, S. -B. (2011). State of research and trends in development of wood adhesives. *Forestry Studies in China*, *13*(4), 321-326

Chapter 4: Synthesis of Lignin-based PF (LPF) Resoles at Large Phenol Substitution Ratios using De-polymerized Lignin from Hydrolytic Depolymerization of Kraft Lignin: Thermal Curing Behaviours

4.1. Introduction

Phenol formaldehyde (PF) resins consist of oligomeric and polymeric chains as well as monomeric methylol-phenols, free formaldehyde and unreacted phenols (Dunky, 2003). Also known as phenolic resins, PF resins are widely used in exterior wood building and construction applications given their superior moisture resistance and excellent bond strength properties (Pizzi, 2003; Zhao *et al.*, 2011). Characteristics of phenolic resins depend upon their composition as well as their reactivity i.e. the degree of methylation and condensation reactions (Lee *et al.*, 2003). It is therefore imperative to study the cure process of these adhesives for effective optimization of resin properties depending on the specific requirements of the application of interest (Pizzi, 2003).

PF resins are synthesized by the addition of formaldehyde onto a phenolate ion to form methylol-phenols in methylation, followed by formation of methylene or dimethylene ether bridges in condensation reactions between phenol and methylol-phenol units or between two methylol-phenol units (Pizzi, 1994; Park *et al.*, 2002; Tonge, 2007). Depending on the formaldehyde-to-phenol (F/P) molar ratio as well as the pH of the reaction medium, the resultant resin is either a resole or a novolac resin (Kopf, 2002). Resoles are synthesized under alkaline conditions in excess of formaldehyde and are cured by the addition of heat. In contrast, novolacs are synthesized with F/P ratios of less than one under acidic conditions and require a hardening agent in addition to heat during their curing processes (Kopf, 2002). In most wood applications, resol resins are preferred given their availability in soluble low cost liquid forms, their good wettability properties, and their ability to form infusible, highly crosslinked three-dimensional networks that have favorably high tensile strength, dimensional stability, and resistance to moisture (Tonge, 2007).

Several important parameters influence the rate of polymerization as well as the subsequent properties of PF resoles (Tonge, 2007). Of the most important parameters is the ratio of formaldehyde-to-phenol (F/P), which affects the degree of methylation reactions. It is desirable to methylate phenol molecules as much as possible in order to facilitate the cross-linking reactions during the curing process. However, as the synthesis of PF resoles progresses, oligomers continue to increase in size and steric hindrance effects hinder further methylation reactions (Tonge, 2007). Higher F/P ratios reduce the activation energy of condensation reactions but also result in increase of resin viscosity and molecular weight and decrease of resin gel time given the increase in condensation reactions (Cheng, 2011).

Curing temperature of PF resoles is an important contributor to the properties of the final product given the complexity of cross-linking reactions. During the curing process, complex molecular rearrangements occur as a result of further condensation reactions of active methylol intermediates to form an infusible, highly-crosslinked network.

According to the Canadian Plywood Association, phenolic resins are typically cured at 150°C (CertiWood Technical Centre, 2004). Compared to other thermosetting resins, phenolic resins require longer press times while lignin-based phenol formaldehyde (LPF) resins requires even longer press times as well as higher temperatures as compared to phenolic resins (Mo *et al.*, 2006; Stark *et al.*, 2010). The complex structure of lignin hinders its reactivity toward formaldehyde during addition reactions thereby delaying curing processing. From an economic standpoint, it is desirable to reduce the curing temperature of the resoles while also maintaining the high quality of the resins.

This chapter examines the effect of synthesis parameters including F/P molar ratios, phenol substitutions, and average weight molecular weight of lignin on the curing temperatures of LPF resoles.

4.2. Experimental Section

Using a three factor box-behnken design (BBD), a total of 15 liquid lignin-based PF (LPF) resoles (referring to Tables 3-1 and 3-2), were obtained at varying levels of the three synthesis parameters including Mw of the depolymerized lignin (DL) products by hydrolytic depolymerization of Kraft lignin at various reaction severities, as described in details in Chapter 3. For comparison purposes, pure phenol formaldehyde (PF) resole at F/P ratio of 2.1 was also synthesized.

Briefly, the lignin used was Kraft Lignin obtained from FPIinnovations Lignin Pilot Plant in Thunder Bay, which was hydrolytically depolymerized to obtain DL products with three distinct relative Mw: 800 g/mol at level (-1), 1,200 g/mol at level (0), and 1,700 g/mol at level (+1). Phenol substitution percentages were varied from 25% to 50% and 75% and F/P molar ratios were varied from 1.2 to 2.1 and 3 (see Table 3-2). Physical properties of the obtained LPF resoles are discussed in Chapter 3.

To investigate the thermal curing properties of the synthesized LPF resoles, Mettler-Toledo Differential Scanning Calorimetry (DSC) was used to test dried resin samples in sealed aluminum crucibles between temperatures of 40°C and 350°C at a heating rate of 10°C/min under nitrogen gas at 50 mL/min. From the obtained DSC thermograms, the curing peaks of LPF resoles were determined and recorded.

4.3. Results and Discussion

Depending on the synthesis parameters, there were two or three exothermic peaks in the DSC thermograms of LPF resoles, where the first peak occurred in the temperature ranges of 115°C to 135°C while the second and third peak occurred in the temperature 140°C to 230°C (see figures 5-1, 5-2, 5-3, and 5-4). The first exothermic peak can be attributed to addition reactions of free formaldehyde to phenolic rings while the second and third exothermic peaks can be attributed to further condensation reactions of methylolphenols and phenols to form methylene bridges and condensation reactions of two methylol groups to form dimethylene ether bridges (Christiansen and Gollob, 1985; Wang, 2007; Wang *et al.*, 2009; Tonge, 2007; Nor *et al.*, 2013).

For the comparison purposes, in this research work the second exothermic peaks that occur in the temperature range of 140°C to 230°C are chosen as the characteristic curing temperatures for LPF resoles, although the third peaks are also important as they influence the cross-linking reactions of the resole. The curing temperature of pure phenolic resole synthesized at F/P ratio of 2.1 was determined to be 152°C with a single peak and is used for reference purposes in this chapter.

4.3.1. Effect of Formaldehyde-to-Phenol Ratio on LPF Curing Temperatures

Table 4-1 shows the curing temperature of LPF resoles at increasing formaldehyde to phenol (F/P) molar ratio from 1.2:1 to 3:1 (left to right) at various percent substitutions and lignin Mw. The curing temperature of LPF-25,(0),1.2 was found to be lower than the curing temperature of pure phenolic resole synthesized in the lab with an F/P ratio of 2.1. All the other LPF resoles showed curing temperatures higher than that of pure phenolic resole. For 50% substituted LPF resoles (second and third rows of Table 4-1), it can be seen that as the F/P molar ratio increased, the curing temperature decreased. This pattern is observed for LPF resoles synthesized with lignin of any Mw at phenol to lignin percent substitutions of 50%. For 25% substituted-LPF resoles, increasing the F/P ratio from 1.2 to 3 resulted in significant increase of curing temperature. Increases in F/P ratios for 75% substituted resoles also resulted in increase of curing temperature albeit to a less extent.

Table 4- 1: Curing Temperatures of LPF resoles at increasing F/P molar ratios (left to right)

F/P of 1.2	Curing Temp. (°C)			F/P of 3	Curing Temp. (°C)		
	Onset	Peak	Endset		Onset	Peak	Endset
¹ LPF-25,(0),1.2	123.0	139.27	154.5	LPF-25,(0),3	190.6	194.8	235.2
LPF-50,(-1),1.2	187.8	219.5	293.0	LPF-50,(-1),3	190.4	200.1	206.02
LPF-50,(+1),1.2	191.2	227.7	274.6	LPF-50,(+1),3	186.3	190.9	200.6
LPF-75,(0),1.2	170.1	180.1	192.5	LPF-75,(0)3	183.0	186.0	189.2
PF at F/P of 2.1	149.4	152.5	159.0				

¹The LPF resoles are labeled as follows: BPF or LPF-%substitution, DL Mw level, F/P molar ratio

At low phenol-to-lignin percent substitution of 25% and low F/P ratio of 1.2, only one major exothermic peak was observed at 139°C for the temperature range of 40°C to 350°C. This was observed likely as a result of limited to negligible free formaldehyde content in the resole mixture prior to curing for LPF-25,(0),1.2 given the low formaldehyde to phenol input during the synthesis of the resole. As such, there was no delay in the condensation reactions of LPF-25,(0),1.2 resulting in curing at considerably lower curing temperatures. However, with 25% substituted LPF at high F/P of 3, three distinct exothermic peaks were observed; the first peak was attributed to addition reactions of free formaldehyde to phenolic rings whereas the second and the third peaks were attributed to formation of ether and methylene linkages and condensation of ether linkages to methylene bridges respectively (Holopainen *et al.* 1997). As a result of more complex curing reactions for resins with higher F/P, the adhesive strength of LPF-25,(0),3 was higher than that of LPF-25,(0),1.2 as can be seen in Table 5-3 of Chapter 5.

Figures 4-1 and 4-2 show the DSC thermograms for LPF-50,(-1),1.2 & LPF-50,(-1),3 and LPF-50,(+1),1.2 & LPF-50,(+1),3, respectively. As can be seen from Figures 4-1 and 4-2, the curing of LPF resoles synthesized with higher F/P ratios is characterized by a sharp, narrow peak followed by a smaller peak. In contrast, the curing of LPF resoles synthesized with low F/P ratios of 1.2 is characterized by one broad distinctive peak. Similar observation was noted by Holopainen *et al.* (1997) and King *et al.* (2003), who studied the effect of F/P ratios on the curing of resoles. The first exotherm was attributed to ether and methylene linkage formation while the second exotherm and the third were attributed to further crosslinking reactions of the polymeric resin such as condensation of ether linkages to form methylene linkages by eliminating a formaldehyde molecule (Zheng, 2002). Given the presence of a third peak for LPF resoles synthesized with F/P ratios of 3, the complex curing reactions resulted in higher adhesive strength as compared LPF resoles synthesized with low F/P ratios of 1.2 (see Table 5.3 in Chapter 5).

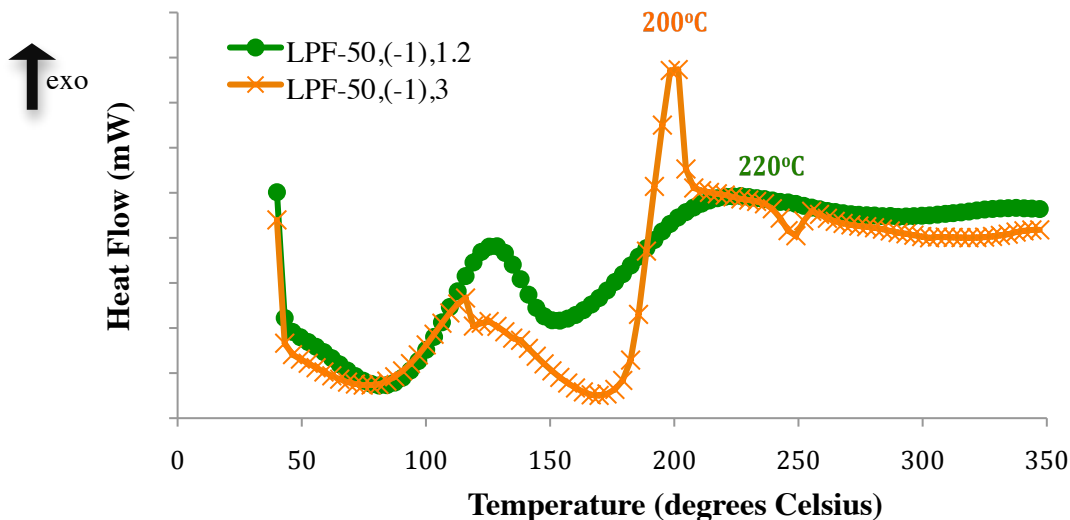

Figure 4- 1: Effect of F/P molar ratio on curing temperature using Lignin of Mw level (-1)

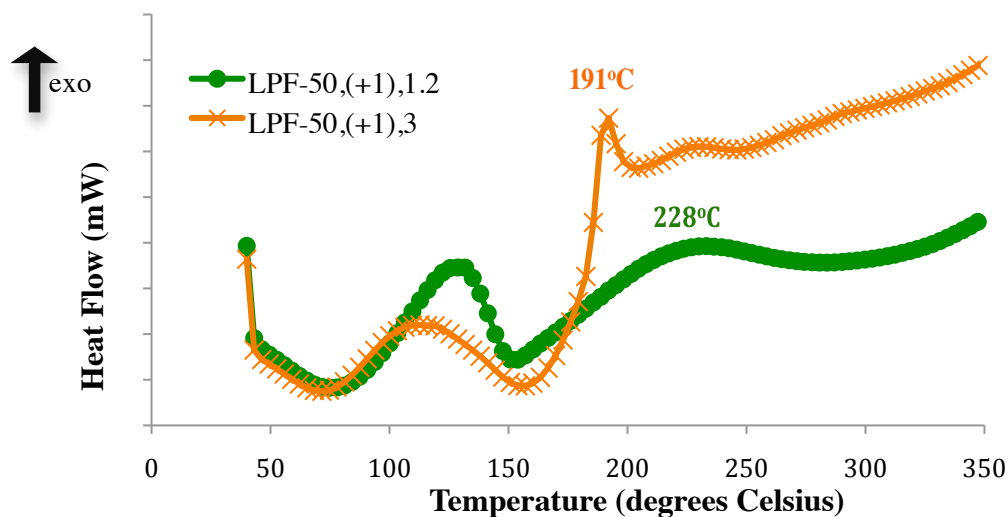

Figure 4- 2: Effect of F/P molar ratio on curing temperature using Lignin of Mw level (+1)

Figures 4-1 and 4-2 also show that the first curing exothermic peak of 50% substituted LPF resoles with higher F/P ratios occurred at much lower temperatures in comparison to the curing exothermic peak of 50% substituted LPF resoles with low F/P ratios. This suggests that the curing was initiated faster for LPF resoles with higher F/P ratios (Tonge, 2007) likely as a result of higher reactivity of resoles with increased methylol substitutions in phenolic rings (Grenier-Loustalot *et al.*, 1996) as well as reduction in gel time for higher methylol contents (Park *et al.*, 2002).

As curing progresses, the molecular weight of the resoles increase and the gel time decreases particularly for resins with high formaldehyde content (Decatur, 1989; So & Rudin, 1990; Park *et al.*, 2002), where higher methylol concentration result in increases of methylene and ether linkages (Holopainen *et al.* 1997). According to Pizzi & Stephanou (1994), gel time of resoles is inversely proportional to the rate of polycondensation reactions and crosslinking of the resoles. For 75%-substituted LPF resoles, the molecular weights of the resoles were likely higher than the molecular weight of 50%-substituted LPF resoles given that higher lignin content is incorporated. The increase in molecular weight of phenolic resins for higher percent substitution of 75% likely resulted in faster curing rates of the resoles. Hence, the curing temperatures of 75% substituted LPF resoles were lower than those of 50% substituted LPF resoles. However, the combined effect of highest F/P ratio and 75% phenol-to-lignin substitution can result in resin molecular weights that are too high, and steric hindrance effects may hinder the rate of cross-linking reactions. This likely explains the slight decrease in curing temperature observed for LPF-75,(0),3 in comparison to LPF-75,(0),1.2.

4.3.2. Effect of Percent Substitution on LPF Curing Temperatures

Table 4-2 shows the curing peaks for LPF resoles at increasing phenol-to-lignin percent substitutions from 25% to 75% (left to right). The resoles presented in this table were synthesized with varying F/P ratios of 1.2, 2.1, and 3. The first and the third rows present the curing peaks for LPF resoles that were synthesized using lignin of weight average molecular weight of ~1,200 g/mol (at level 0) and F/P ratios of 1.2 and 3 respectively. The second row presents the curing peaks for LPF resoles that were synthesized using lignin of low weight average molecular weight, Mw of ~800 g/mol (level -1), whereas the fourth row presents the curing peaks for LPF resoles that were synthesized with lignin of high weight average molecular weight, Mw of ~1,700 g/mol (level +1).

Table 4- 2: Curing Temperatures of LPF resoles at increasing percent substitutions (left to right)

25% Substitution	Curing Temp. (°C)			75% Substitution	Curing Temp. (°C)		
	Onset	Peak	Endset		Onset	Peak	Endset
¹ LPF-25,(0),1.2	123.0	139.27	154.5	LPF-75,(0),1.2	170.1	180.1	192.5
LPF-25,(-1),2.1	167.0	211.2	298.5	LPF-75,(-1),2.1	187.0	195.0	199.8
LPF-25,(0),3	190.6	194.8	235.2	LPF-75,(0),3	183.0	186.0	189.2
LPF-25,(+1),2.1	176.8	216.2	245.9	LPF-75,(+1),2.1	188.3	191.8	195.8
PF at F/P of 2.1	149.4	152.5	159.0				

¹The LPF resoles are labeled as follows: LPF-%substitution, DL Mw level, F/P molar ratio

As can be seen from the table, increasing the phenol-to-lignin percent substitution resulted in reduced curing peak temperatures for lignin of low and high Mw for all resoles except for LPF-25,(0),1.2 (first row in Table 4-2), where the low free formaldehyde content (if any) at low percent substitution of 25% resulted in limited the addition reactions and resulted in faster initiation of condensation and cross-linking reactions.

Given the complex structure of lignin and its higher molecular weight relative to phenol molecules, LPF resoles synthesized with greater phenol-to-lignin percent substitutions likely have higher molecular weights. Although the weight average molecular weights of phenolic resins were not measured, viscosity measurement of LPF resoles indicated increasing viscosities at higher substitution percentages as shown previously in Table 3-7. Polymers with larger and bulkier molecules tend to make more contact and entangle more readily (Rodriquez, 1996). As a result, lignin phenol formaldehyde resins with higher molecular weights have lower gel times (Pizzi & Stephanou, 1994), and require lower activation energy (Park *et al.*, 2002) leading to faster curing and condensation reactions (Khan & Ashraf, 2007). Khan & Ashraf (2007) studied the effect of increasing lignin mass% from 0% to 25% and 50% in LPF adhesives and reported lower curing peaks of 25% and 50% substituted LPF resoles in comparison to pure phenolic resoles.

4.3.3. Effect of Lignin depolymerization on LPF Curing Temperatures

Table 4-3 shows the effect of increasing lignin weight average molecular weight (left to right) on the curing temperatures of LPF resoles. From the table, it can be seen that the

effect of lignin molecular weight on curing of LPF resoles depends upon other parameters such as the percent substitution and the F/P ratio.

At phenol-to-lignin substitution percentage of 25% (first row in Table 4-3), decreasing the relative weight average molecular weight, Mw, of lignin from 800 g/mol (at level +1) to 800 g/mol (at level -1) through hydrolytic reactions resulted in slightly lower curing temperature of LPF resole (see Figure 4-3). For 50% substituted LPF resoles (second and third row in Table 4-3), the effect of decreasing the Mw of lignin on the LPF curing temperature depended upon the F/P ratio. With F/P ratio of 1.2, depolymerization of lignin to lower Mw resulted in significant reduction of curing temperature of 50% substituted-LPF resoles. However, the opposite trend was observed for 50% substituted-LPF resoles synthesized with F/P ratio of 3, where lignin depolymerization to lower Mw resulted in increase of curing temperature of LPF resoles. At phenol-to-lignin substitution percentage of 75% (last row in Table 4-3), decreasing the relative molecular weight, Mw, of lignin from 1,700 g/mol (at level +1) to 800 g/mol (at level -1) resulted in slightly higher curing temperature of LPF resole (see Figure 4-4).

Table 4- 3: Curing temperatures of LPF resoles with increasing DL Mw (left to right)

DL Mw (-1)	Curing Temp (°C)			DL Mw (+1)	Curing Temp (°C)		
	Onset	Peak	Endset		Onset	Peak	Endset
LPF-25,(-1),2.1	167.0	211.2	298.5	LPF-25,(+1),2.1	176.8	216.2	245.9
LPF-50,(-1),1.2	187.8	219.5	293.0	LPF-50,(+1),1.2	191.2	227.7	274.6
LPF-50,(-1),3	190.4	200.1	206.0	LPF-50,(+1),3	186.3	190.9	200.6
LPF-75,(-1),2.1	187.0	195.0	199.8	LPF-75,(+1),2.1	188.3	191.8	195.8
PF at F/P of 2.1	149.4	152.5	159.0				

At low phenol-to-lignin percent substitutions, petroleum-derived phenol molecules dominate the phenolic feedstock for the synthesis of LPF resoles. As such, lignin products with lower weight average molecular weights, Mw, are preferable because of the higher phenolic hydroxyl content in comparison to lignin products with higher molecular weights as discussed in Chapter 3. Incorporation of lignin with higher phenolic hydroxyl content at low percent substitutions to phenolic resole resins accelerates the curing rate of

the resins. As such, the curing temperature of 25% substituted LPF resoles was lower for resoles synthesized with lignin products of lower average molecular weights (see first row of Table 4-3 and Figure 4-3). Similar findings were reported from previous reviews (Khan & Ashraf, 2007; Cheng, 2011).

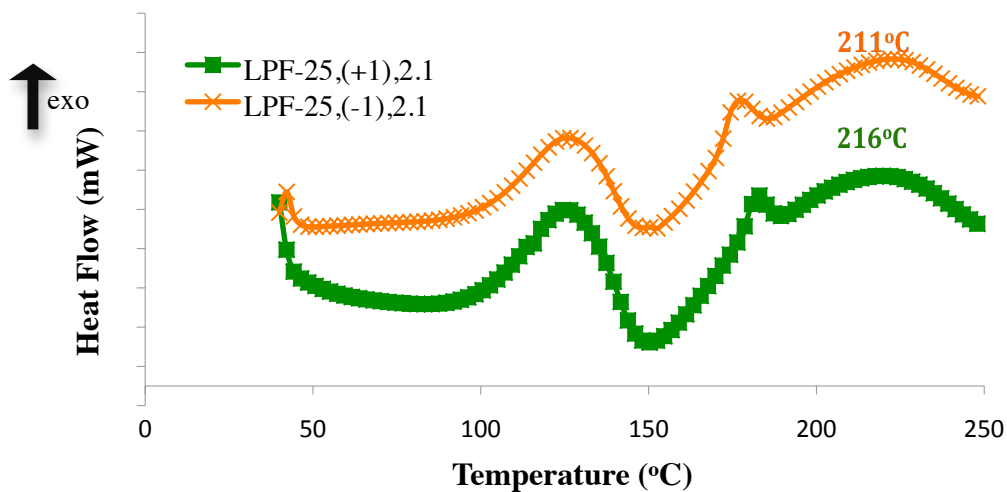

Figure 4- 3: Effect of lignin molecular weight on curing temperature of LPF Resins at 25% Substitution

However, as the lignin-to-phenol substitution percentage in LPF resoles increases to 75%, lignin products dominate the phenolic feedstock for the synthesis of LPF resoles. With higher lignin products content in the feedstock, the molecular weight of LPF resoles likely increases substantially. For phenolic resins with higher molecular weights, condensation reactions are facilitated by the larger and bulkier molecules available within the mixture where these molecules have an increased likelihood of more contact and enhanced entanglement during polymerization and cross-linking reactions (Rodriquez, 1996). At high phenol-to-lignin percentage substitutions, lignin products with higher weight average molecular weights are preferred because of the increase in molecular contact resulting in lower activation energy (Park *et al.*, 2002). Hence, the curing temperature of 75% substituted LPF resoles was lower for resoles synthesized with lignin products of higher average molecular weights (see second row of Table 4-3 and Figure 4-4).

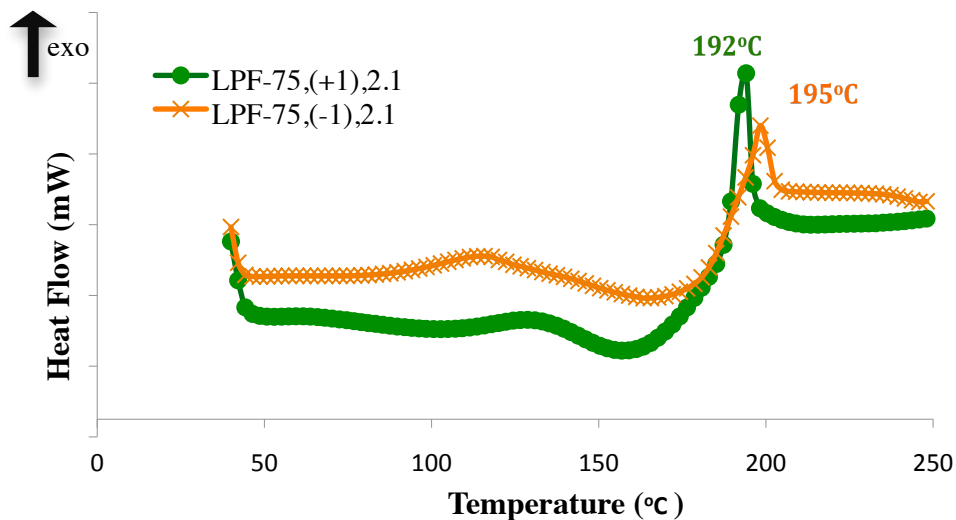

Figure 4- 4: Effect of lignin molecular weight on curing temperature of LPF resins at 75% substitution

Similarly, LPF resoles synthesized with F/P ratio of 3 are more likely to result in a mixture of high molecular weight products given the increase in methylene and ether linkages from higher condensation reactions (Holopainen *et al.* 1997). Therefore, incorporation of lignin products of higher weight average molecular weights likely results in further increase of the molecular weight of these resoles, thereby facilitating the curing reactions of the LPF resoles and resulting in lower curing temperatures. As such, the curing temperature of 50% substituted LPF resole was lower for resoles synthesized with higher lignin Mw (see third row of Table 4-3). In contrast, LPF resoles synthesized with F/P ratio of 1.2 tend to result in more linear polymer chains (Dunky, 2003). For these resoles, incorporation of lignin products with lower average weight molecular weights are preferred for curing reactions particular if the phenolic hydroxyl contents are higher in lignin products with lower Mw compared to those with higher Mw. As such, the curing temperature of 50%-substituted LPF resole at F/P ratio of 1.2 was lower for resoles synthesized with lower lignin Mw (see second row of Table 4-3).

4.4. Conclusions

Incorporating lignin into the synthesis of phenolic resol resins influences the curing temperature of the lignin phenol formaldehyde (LPF) resoles depending on the F/P ratio and the percent of phenol substitution.

(1) Increasing the F/P ratio results in increase of methylol substitutions in phenol and facilitates faster curing reactions for 50% substituted LPF resoles resulting in an infusible, highly crosslinked three-dimensional network of phenolic resin.

(2) At lower phenol percent substitutions, petroleum-derived phenol molecules dominate the phenolic feedstock for the synthesis of LPF resoles. As such, the incorporation of lignin products with lower average weight molecular weights with high phenolic hydroxyl content tends to decrease the curing temperature of LPF resoles.

(3) In contrast, at high phenol percent substitutions, lignin products dominate the phenolic feedstock for the synthesis of LPF resoles and hence incorporation of lignin products with higher average weight molecular weights tends to facilitate greater contact between larger and bulkier molecules, which results in enhanced curing rates and temperatures.

(4) The combined effect of high phenol percentage substitution and high F/P ratio can result in formation of LPF resoles with too high average weight molecular weights and significant steric hindrance effects that could impede the curing rate of the resoles.

4.5. References

CertiWood Technical Centre. (2012). Glueline Characteristics. Retrieved May, 2013 from http://www.canply.org/english/literature_media/tech_glue.htm.

Cheng, S., Dacruz, I., Yuan, Z., Wang, M., Anderson, M., Leitch, M., Xu, C. (2011). Use of biocrude derived from woody biomass to substitute phenol at a high-substitution level for the production of biobased phenolic resol resins. *J. Applied Polymer Science* 121: 2743-2751.

Chow, S. (1977). A curing study of phenol-resorcinol-formaldehyde resins using infrared spectrometer and thermal analysis. *Holzforschung-International Journal of the Biology, Chemistry, Physics and Technology of Wood*, 31(6), 200-205.

- Christiansen, A. W., & Gollob, L. (1985). Differential scanning calorimetry of phenol--formaldehyde resols. *Journal of Applied Polymer Science*, 30(6), 2279-2289.
- Decatur, G. (1989). The correlation between preparation and properties in phenolic resins. *Wood Adhesives: Chemistry and Technology*, 2, 121.
- Dunky, M. (2003). Adhesives in the wood industry. *Handbook of Adhesive Technology*, 2.
- Grenier-Loustalot, M. F., Larroque, S., & Grenier, P. (1996). Phenolic resins: 5. Solid-state physicochemical study of resoles with variable FP ratios. *Polymer*, 37(4), 639-650.
- He, G., & Yan, N. (2005). Effect of wood on the curing behavior of commercial phenolic resin systems. *Journal of Applied Polymer Science*, 95(2), 185-192. doi:10.1002/app.21115
- Holopainen, T., Alvila, L., Rainio, J., & Pakkanen, T. T. (1997). Phenol-formaldehyde resol resins studied by ¹³C-NMR spectroscopy, gel permeation chromatography, and differential scanning calorimetry. *Journal of Applied Polymer Science*, 66(6), 1183-1193.
- Khan, M. A., & Ashraf, S. M. (2007). Studies on thermal characterization of lignin. *Journal of Thermal Analysis and Calorimetry*, 89(3), 993-1000.
- King, P. W., Mitchell, R. H., & Westwood, A. R. (1974). Structural analysis of phenolic resole resins. *Journal of Applied Polymer Science*, 18(4), 1117-1130.
- Kopf, P.W. (2002). Phenolic resins. *Encyclopedia of Polymer Science and Technology*, 7, 233-268. Retrieved from <http://onlinelibrary.wiley.com/doi/10.1002/0471440264.pst236/abstract>
- Knop, A., & Pilato, L. A. (1985). *Phenolic resins: Chemistry, applications, and performance: Future directions*. Springer-Verlag Berlin.
- Lee, Y. -K., Kim, D. -J., Kim, H. -J., Hwang, T. -S., Rafailovich, M., & Sokolov, J. (2003). Activation energy and curing behavior of resol-and novolac-type phenolic resins by differential scanning calorimetry and thermogravimetric analysis. *Journal of Applied Polymer Science*, 89(10), 2589-2596.
- Mo, X., Zhong, Z., Wang, D., & Sun, X. (2006). Soybean glycinin subunits: Characterization of physicochemical and adhesion properties. *Journal of Agricultural and Food Chemistry*, 54 (20), 7589-93. doi:10.1021/jf060780g
- Monni, J., Alvila, L., & Pakkanen, T. T. (2007). Structural and physical changes in phenol- formaldehyde resol resin, as a function of the degree of condensation of the resol solution. *Industrial & Engineering Chemistry Research*, 46(21), 6916-6924. Retrieved from Google Scholar .

- Nor, H. H., Paridah, P., Mohd Yunus, N. Y., Ashaari, Z., Yong, A. C. C., & Selamat, N. A. (2013). Influence of resin molecular weight on curing and thermal degradation of plywood made from phenolic prepreg palm veneers. *The Journal of Adhesion*, (just-accepted). Retrieved from Google Scholar:
<http://www.tandfonline.com/doi/full/>
- Park, B. -D., Riedl, B., Kim, Y. S., & So, W. T. (2002). Effect of synthesis parameters on thermal behavior of phenol--formaldehyde resol resin. *Journal of Applied Polymer Science*, 83(7), 1415-1424.
- Pizzi, A., & Stephanou, A. (1994). A ¹³C NMR study of polyflavonoid tannin adhesive intermediates. II. Colloidal state reactions. *Journal of Applied Polymer Science*, 51(13), 2125-2130.
- Pizzi, A. (2003). Phenolic resin adhesives. *Handbook of Adhesive Technology*, 541-571.
- Rodriguez, F. (1996). *Principles of polymer systems* (Vol. 4). New York: Taylor & Francis.
- Stark, N. M., Cai, Z., & Carll, C. (2010). Wood-Based composite materials: Panel products, glued- laminated timber, structural composite lumber, and wood-nonwood composite materials. *Wood Handbook: Wood As An Engineering Material*, 11-1.
- So, S., & Rudin, A. (1990). Analysis of the formation and curing reactions of resol phenolics. *Journal of Applied Polymer Science*, 41(1-2), 205-232.
- Tonge, L. (2007). *Thermochemical properties of methylol phenol monomers and phenol formaldehyde resoles*. Thesis. Hawthorn, Australia: Faculty of Engineering and Industrial Sciences, Swinburne University of Technology.
- Wang, J. (2007). *Cure kinetics of wood phenol-formaldehyde systems*. Thesis. Washington: Washington State University.
- Wang, M., Leitch, M., Xu, C. (2009). Synthesis of phenol-formaldehyde resol resins using organosolv pine lignins. *European Polymer Journal*, 45, 3380–3388
- Zhao, B. Y., Hu, K. A., & Wu, R. J. (2000). Primary study on the phenolic modification of sodium lignosulphate. *Polymer Materials Science and Engineering*, 1, 158-161.
- Zheng, J. (2002). *Studies of PF resol/isocyanate hybrid adhesives*. Thesis. Blacksburg, Virginia: Virginia Polytechnic Institute and State University.

Chapter 5: Synthesis of Lignin-based PF (LPF) Resoles at Large Phenol Substitution Ratios using De-polymerized Lignin from Hydrolytic Depolymerization of Kraft Lignin: Adhesive Strength

5.1. Introduction

The main purpose for the development of plywood adhesives is to attain good penetration of the adhesive into the wood and achieve high bond strength while maintaining high moisture resistance as well as the thermal and dimensional stability of the adhesive (Pizzi, 1994; Dunky, 2003). During the curing of the adhesive, there are substantial chemical and physical interactions between the wood and resins; however, the relationship between the chemical and mechanical advancement of phenolic adhesives is still unclear (Pizzi, 1994; He *et al.*, 2005). Mechanically, the adhesive strength is the “force necessary to pull apart the substrates that are bonded together” (Frihart, 2005). The resultant bond strength of the adhesive depends on the properties of the adhesive as well as the adhesion mechanism (Rowell, 1984; Obućina *et al.*, 2013). According to the Canadian Construction Materials Centre (2009), the minimum shear stress required for phenol formaldehyde resins as wood adhesives is 2.5 MPa. Poor adhesion can occur as a result of low penetration of adhesive into the wood due to incomplete polymerization of the adhesive and excessively high resin molecular weights and viscosities, or a result of starved glue-lines and over-penetration of adhesive into the wood due to low resin viscosities or exceedingly high press pressures (Dunky, 2003; Frihart, 2005; Kurt & Cil, 2012).

Three of the main parameters that govern the pressing mechanism of adhesives include heat, press pressure, and moisture content of the wood (Kamke & Lee, 2007; Kurt & Cil, 2012). Application of heat promotes cross-linking of the adhesive polymer into a highly dense, three-dimensional network whilst pressure acts as the driving force of the adhesive penetration into the wood and influences the glue-line thickness. Moisture content of wood of the wood affects important processes during the application of adhesive

including the wetting and flow of the adhesive, and the penetration of resin into the wood (Obućina *et al.*, 2013; Dunky, 2003). In wood applications, moisture content of the range of 6% to 14% is acceptable (Dunky, 2003). Too high wood moisture content can result in over-penetration of adhesive into the wood and starved glue-lines while too low wood moisture content can result in low wetting of the adhesive as well as quick dryout of adhesive spread (Dunky, 2003).

From an economic standpoint, it is desirable to minimize the duration and input of press pressure at a given temperature without compromising the bond strength of the wood product. Yet sufficient pressing times are required for the developed interface to withstand internal pressure or stresses occurring due to changes in wood thickness during press opening (Kurt & Cil, 2011). This is especially important for phenol formaldehyde resins given that they require relatively longer press times in comparison to other formaldehyde-based resins (Stark *et al.*, 2010). Typical press conditions of phenolic resins for plywood applications include press pressure of 200 psi and temperature of around 150°C (CertiWood Technical Centre, 2004). An important indicator of adhesive penetration into the wood is the thickness of glue-line. Kurt and Cil (2012) studied the effect of press pressures from 2.5 kg/cm² to 12.5 kg/cm² on wood glue-line thickness using phenol-formaldehyde adhesives. According to their findings, the optimal wood glue-line thickness of 0.127 mm and 0.178 mm was attained with press-pressure of 10 kg/cm². However, it is important to note lignin based phenol formaldehyde (LPF) resins require even longer press times as well as higher curing temperatures (Pizzi, 1994; Dunky, 2003).

This chapter examines the effect of synthesis parameters lignin based phenol formaldehyde (LPF) resins including the percent substitution of phenol-to-lignin, the weight average molecular weight of lignin, and the formaldehyde-to-phenol ratio on the maximum adhesive strength for specific pressing conditions of 180°C, 1.4 MPa, and press-time of 6 minutes.

5.2. Experimental Section

5.2.1. Materials and Equipment

Eastern yellow birch veneer of thickness 1.3 mm was obtained from a sawmill in ThunderBay, Ontario and used for preparing plywood samples with the obtained depolymerized lignin-based phenol formaldehyde (LPF) resoles as adhesives in this study.

Using a three factor box-behnken design (BBD), a total of 15 liquid lignin-based PF (LPF) resoles (referring to Tables 3-1 and 3-2), were obtained at varying levels of the three synthesis parameters including Mw of the depolymerized lignin (DL) products by hydrolytic depolymerization of Kraft lignin at various reaction severities, as described in details in Chapter 3. For comparison purposes, pure phenol formaldehyde (PF) resole at F/P ratio of 2.1 was also synthesized.

Briefly, the lignin used was Kraft Lignin obtained from FPIinnovations Lignin Pilot Plant in ThunderBay, which was hydrolytically depolymerized to obtain DL products with three distinct relative Mw: 800 g/mol at level (-1), 1,200 g/mol at level (0), and 1,700 g/mol at level (+1). Phenol substitution percentages were varied from 25% to 50% and 75% and F/P molar ratios were varied from 1.2 to 2.1 and 3 (see Table 3-2). Physical properties of the obtained LPF resoles are discussed in Chapter 3. Thermal curing properties of the obtained LPF resoles are discussed in Chapter 4.

To adjust the solids content of the liquid resoles, all-purpose flour was used as filler. Carver hot-press was used for hot-pressing of the veneers to make plywood samples. For mechanical tensile strength measurements, INSTRON Universal Testing Machine (UTM) Model No. 2716.010 was used.

5.2.2. Procedure

Given the importance of wood moisture content, the wood veneers obtained from the sawmill were pre-treated in environmental chambers at 20°C and 65% relative humidity for a period of seven days. To prepare the phenolic resins for application, around 15wt% of all-purpose flour was mixed with the liquid resoles. Next, the resins were applied to the inside surface of the two face veneers at a spread rate of 250 g/m² per single glue-line

using a brush. For calculation of the amount of lignin required per glue-line, around 10wt% loss was assumed during transfer of glue mix to the veneer surfaces.

The veneers were pressed at 180°C and press-pressure of 1.4 MPa or around 203 psi for 6 minutes in accordance to two-ply requirement of ASTM D2339. The pressed veneers were then cut into test specimen sizes with a slight modification of ASTM D2339 of reducing the sizes of test specimens in half to accommodate the constraints of the UTM used for mechanical testing (see Figure 5-1). Changes in size of test specimens were taken into consideration when conducting mechanical testing of the specimens. The test specimens were re-conditioned in environmental chambers at 23°C and 50% relative humidity for a period of seven days prior to mechanical testing. A total of 10 specimens per resin sample were tested to obtain an average maximum shear stress at failure point using the INSTRON UTM. The specimens were placed and gripped tightly in the jaws of the grips in the testing machine and load was applied at a crosshead speed of 1 mm/min, thereby subjecting the specimens to increasing shear strain until failure. This was repeated for 15 lignin-based phenol formaldehyde resins and one pure lab synthesized phenol formaldehyde resin. Due to time constraints, only dry tensile strength of the specimens was tested.

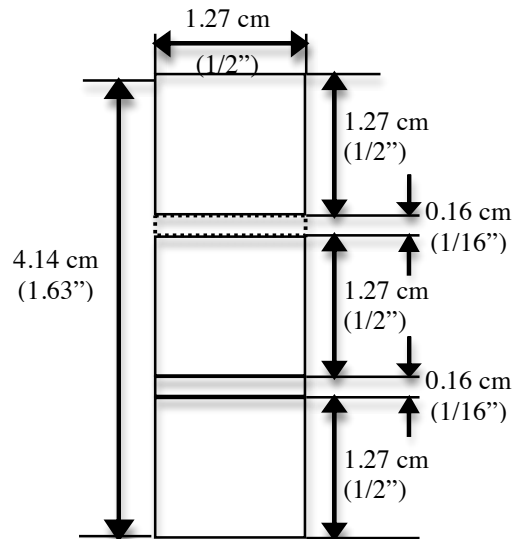

Figure 5- 1: Form and dimensions of test specimen

5.3. Results and Discussion

5.3.1. Obtaining maximum shear stress values from stress-strain curves

A total of 10 specimens were tested for each lignin-based phenol formaldehyde (LPF) resole. The specimens were subjected to shear strain until the point of failure. Typical shear stress-shear strain curves for specimens of pure phenolic resin and LPF-75,(0),3 are shown in Figures 5-2 and 5-3, respectively. As can be seen from the figures, shear stresses of these specimens continued to increase until failure, at which point, shear stresses dropped significantly. The maximum shear stresses for all ten specimens were recorded from the shear stress-strain curves and averages of these values were taken and recorded, as can be seen in Tables 5-1, 5-2, and 5-3.

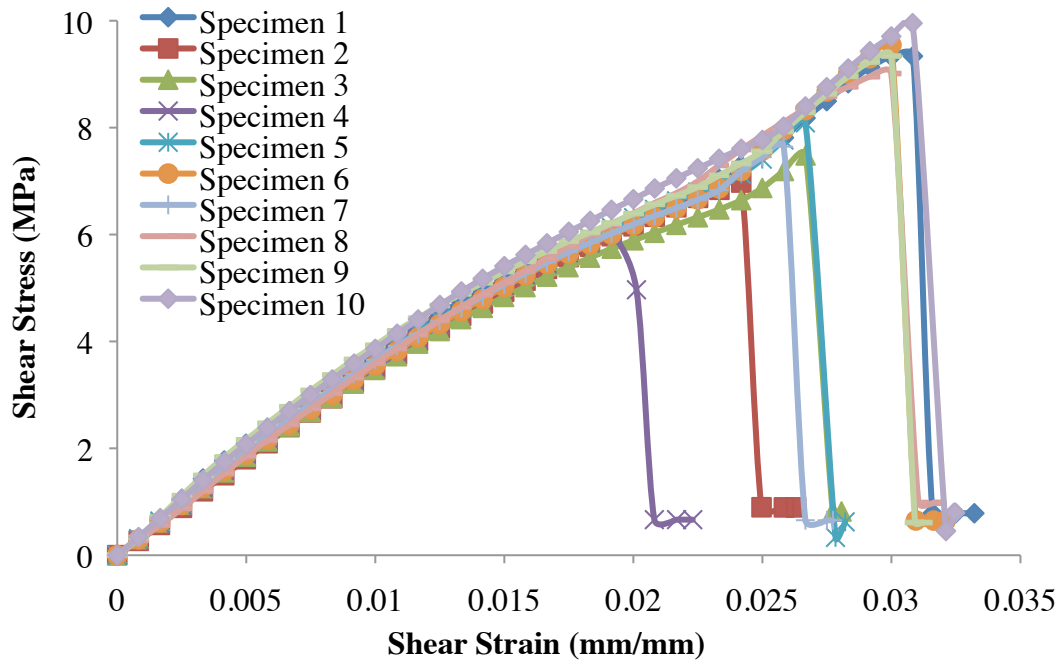

Figure 5- 2: Stress-Strain curve for Pure Phenolic Resole (F/P of 2.1)

From Figure 5-2, it can be seen that the specimens failed at considerably different shear stresses. The specimens that had higher wood failure percentages experienced lower shear stresses in comparison to the specimens that failed at the adhesive bondline. Failure at wood is desirable because it indicates that the adhesive is stronger than the wood; however, it had an influence on the average maximum shear stress values reported in Tables 5-1, 5-2, and 5-3. Specimens from LPF-75,(0),3 did not experienced failure at the

wood due to the exceedingly high viscosity of the resole, which resulted in lower adhesive bond strength as can be seen in Figure 5-3. Section 5.3.3 provides further discussion on the importance of wood failure in test specimens.

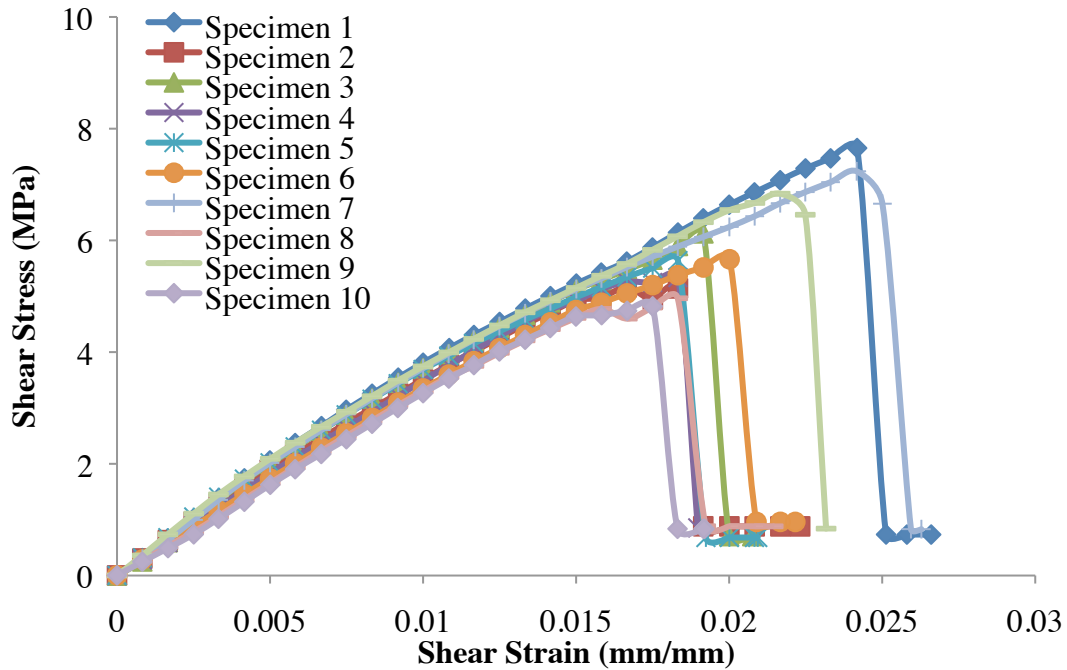

Figure 5- 3: Stress-Strain curve for LPF-75,(0),3

5.3.2. Effect of LPF synthesis parameters on maximum shear stress

For each test specimen, a shear-strain curve was created to determine the maximum shear stress at the point of failure. Since 10 specimens were tested for each resin, an average of the maximum shear strength was recorded along with the associated standard error. The effect of LPF synthesis parameters including lignin average weight molecular weights, the phenol-to-lignin percent substitutions, and the formaldehyde-to-phenol ratio on the maximum shear stress are presented in Tables 5-1, 5-2, 5-3, respectively.

Table 5- 1: Maximum Shear Stress of LPF resoles at increasing Mw of DL (left to right)

DL Mw (-1)	Max. Shear Stress (MPa)	DL Mw (+1)	Max. Shear Stress (MPa)
LPF-25,(-1),2.1	7.77 ± 0.29	LPF-25,(+1),2.1	8.36 ± 0.32
LPF-50,(-1),1.2	8.90 ± 0.33	LPF-50,(+1),1.2	8.17 ± 0.35
LPF-50,(-1),3	8.78 ± 0.32	LPF-50,(+1),3	9.13 ± 0.46
LPF-75,(-1),2.1	8.48 ± 0.30	LPF-75,(+1),2.1	8.83 ± 0.17

*NB: The LPF resoles are labeled as follows: LPF-%substitution, DL Mw level, F/P ratio

Table 5- 2: Maximum Shear Stress of LPF resoles at increasing phenol percent substitutions (left to right)

25% Substitution	Max. Shear Stress (MPa)	75% Substitution	Max. Shear Stress (MPa)
LPF-25,(-1),2.1	7.77 ± 0.29	LPF-75,(-1),2.1	8.48 ± 0.30
LPF-25,(+1),2.1	8.36 ± 0.32	LPF-75,(+1),2.1	8.83 ± 0.17

Table 5- 3: Table 5-3: Maximum Shear Stress of LPF resoles at increasing F/P molar ratios (left to right)

F/P of 1.2	Max. Shear Stress (MPa)	F/P of 3	Max. Shear Stress (MPa)
LPF-50,(-1),1.2	8.90 ± 0.33	LPF-50,(-1),3	8.78 ± 0.32
LPF-50,(+1),1.2	8.17 ± 0.35	LPF-50,(+1),3	9.13 ± 0.46
LPF-25,(0),1.2	7.45 ± 0.29	LPF-25,(0),3	8.28 ± 0.25
LPF-75,(0),1.2	4.14 ± 0.29	LPF-75,(0),3	6.03 ± 0.25

As can be seen from Tables 5-1, 5-2, and 5-3, the measured average maximum shear stresses for all of the specimens are above the minimum shear strength requirement by the Canadian Construction Materials Centre (2009) for phenolic resins as wood adhesives, which is 2.5 MPa. For illustrative purposes, the data from Tables 5-1, 5-2, and 5-3 are plotted into Figures 5-4, 5-5, and 5-6, respectively. For comparison reasons, the maximum shear stress of a pure phenol formaldehyde resin synthesized with an F/P ratio of 2.1 in the lab is shown in each of these figures. Figure 5-4 compares the effect of lignin average weight molecular weights on the maximum shear stress of lignin phenol formaldehyde (LPF) resin. In this figure, low lignin Mw and high lignin Mw refer to lowest weight average relative molecular weight of depolymerized lignin, around 800 g/mol, and highest weight average relative molecular weight of depolymerized lignin, around 1,700 g/mol, respectively. The specified average lignin Mw were obtained from hydrolysis reactions of kraft lignin at varying severities as described in Chapter 3. It can be seen that the maximum shear stresses of LPF resoles synthesized with low lignin Mw are comparable to that of pure phenol-formaldehyde resin (PF) resole. At high lignin Mw, LPF resoles exhibit relatively higher maximum shear stresses. Lignin at higher molar mass contributes to higher molar masses of resoles; as a result of which, lower activation energy is required for condensation and crosslinking reactions (Khan & Ashraf, 2007).

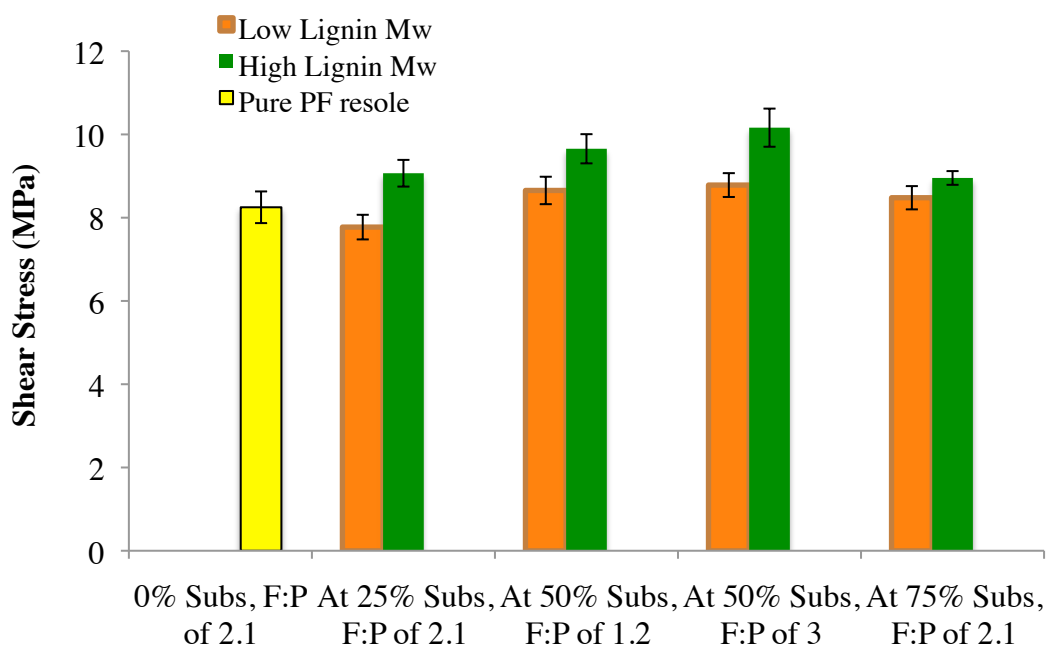

Figure 5- 4: Effect of Lignin Molecular Weight (M_w) on Maximum Shear Stress of LPF resoles

Larger and bulkier molecules make more contact under viscous shear forces as the curing temperature increases to the set press temperature (Rodriquez, 1996), thereby, facilitating a faster curing process. However, higher curing temperatures may be required to overcome the steric hindrance effects associated with the bulkier lignin structure. The highest maximum shear stress for LPF resoles was obtained at phenol-to-lignin percent substitution of 50% and F/P ratio of 3. This is also illustrated in Figures 5-5 and 5-6. With increase in percent substitution of phenol with lignin to 75%, the maximum shear stress is reduced albeit still considerably higher than the minimum shear strength requirement. It is important to note that the data used for 75% substituted LPF at F/P of 2.1 in Figure 5-4 excludes the 75% substituted LPF resole synthesized at mid-lignin given the constraints of the experimental design.

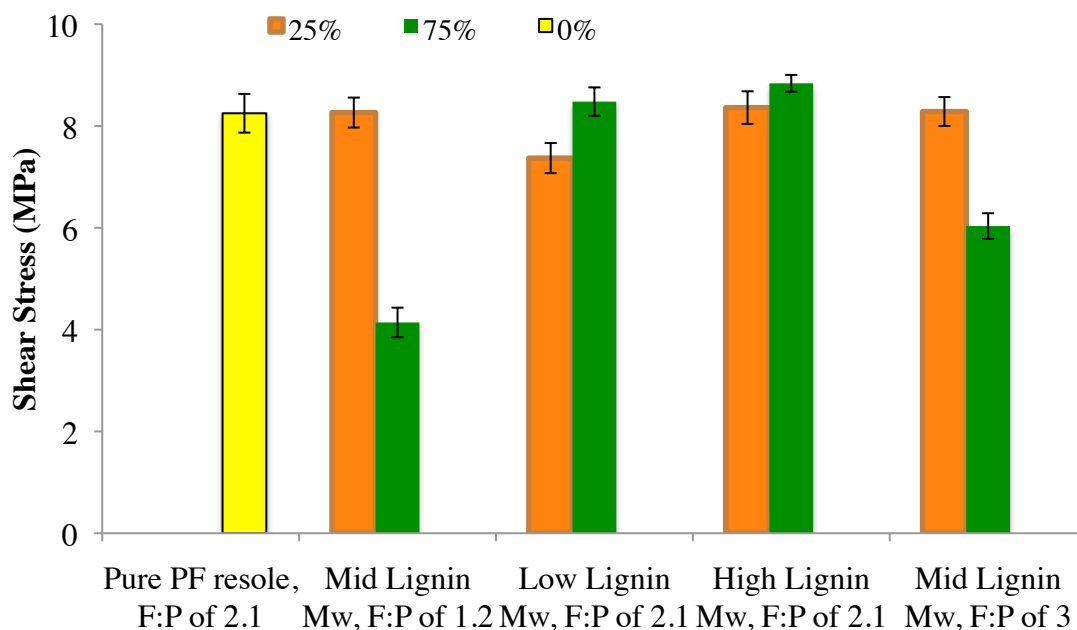

Figure 5- 5: Effect of % Phenol Substitution Ratio on the Maximum Shear Stress of LPF resoles

Figure 5-5 presents the effect of phenol-to-lignin percent substitutions on the maximum shear stresses of LPF resoles. It can be seen that the maximum shear stresses of LPF resoles with 25% phenol-to-lignin percent substitutions are comparable to the maximum shear stress of pure PF resole that was synthesized in the lab at an F/P ratio of 2.1. However, when the percent substitution of lignin-to-phenol is increased to 75%, the resultant maximum shear stress of the LPF resoles depend upon other synthesis parameters such as the weight average lignin molecular weight as well as the F/P molar ratio. For instance, the LPF-75% resoles exhibited substantially higher shear stresses when synthesized with F/P ratio of 2.1 in comparison to the LPF-75% resoles synthesized with medium weight average lignin molecular and F/P ratios of 1.2 or 3. This can be attributed to the viscosities of the LPF resoles.

Viscosity of phenolic resins influences the degree of condensation reactions as well as the penetration of the resins into the wood veneers (Monni *et al.*, 2007; Pilato, 2010; Kurt & Cil, 2012). At low viscosities and low degree of condensation reactions, a large amount

of the resin penetrates into the wood resulting in starved glue-lines. In contrast, too high viscosities do not allow for enough resin penetration into the wood resulting in poor bond strength properties (Dunky, 2003; Frihart, 2005). For phenolic resins in wood application, the acceptable viscosity range is 150-600 cP with the most optimal viscosities reported to be around 200-250 cP (Pizzi, 2003). However, the viscosities for LPF-75% resoles synthesized with mid weight average lignin molecular weight of 1,200 g/mol and F/P ratios of 1.2 and 3 exceeded 5000 cP as a result of resin gelation (see Table 3-7b in Chapter 3). These high viscosities likely impacted the wettability of the adhesives as well as the penetration of the adhesives into the wood veneers negatively, resulting in poor mechanical interlocking and low bond strength properties (Dunky, 2003). Hence, the reported maximum shear stresses for resoles LPF-75,(0),1.2 and LPF-75,(0),3 were considerably lower than those of LPF-75,(-1),2.1 and LPF-75,(+1),2.1, where (1),(0),(+1) represent the low, medium, and high weight average molecular weight of lignin used during the synthesis of LPF resoles respectively. Still, the resoles LPF-75,(0),1.2 and LPF-75,(0),3 met the minimum shear stress requirement of 2.5 MPa likely as a result of using higher curing temperature of 180°C during pressing as compared to the curing temperature of 150°C (CertiWood Technical Centre, 2012) used for conventional phenolic resins.

Figure 5-6 compares the effect of increasing F/P molar ratio on the maximum shear stresses of LPF resoles. As can be seen, the maximum shear stress of the LPF resole increases with increased F/P molar ratio during the reaction synthesis. The highest maximum shear stress was for LPF-50,(+1),3. It can also be seen that all the reported maximum shear stresses for LPF resoles are comparable to that of pure PF resole at F/P of 2.1 except for the maximum shear stress of the two resoles LPF-75,(0),1.2 and LPF-75,(0),3. As explained, this observation can be attributed to excessively high viscosities of the two resoles.

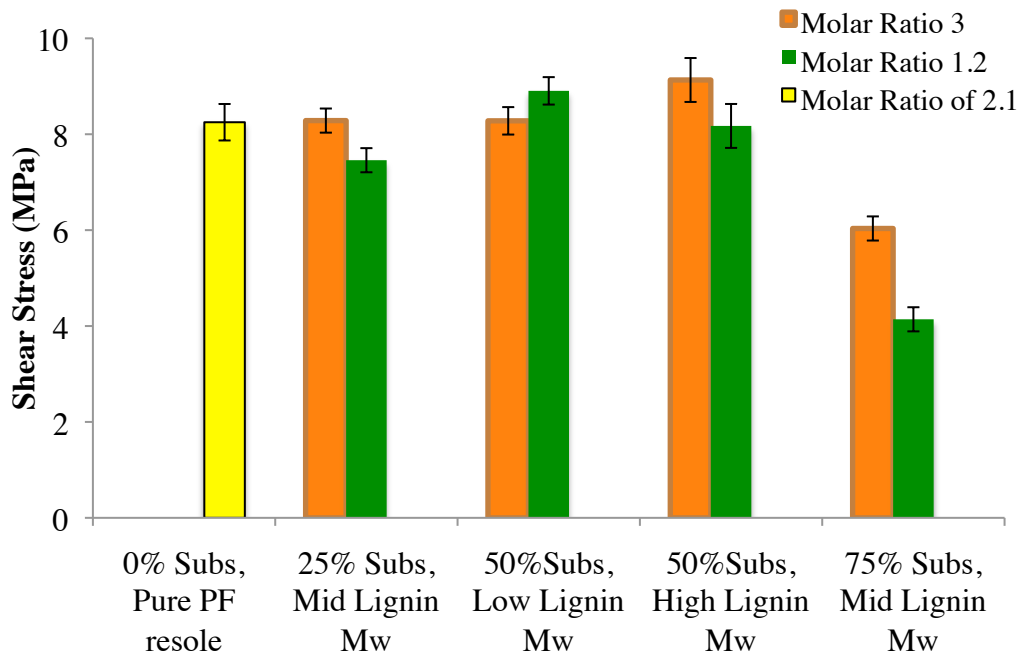

Figure 5- 6: Effect of F/P Molar Ratio on the Maximum Shear Stress of LFP resoles

Resoles synthesized with higher F/P ratios exhibit higher degree of methylation and condensation reactions resulting in highly-crosslinked three-dimensional networks. Additionally, resoles with higher F/P ratios have lower activation energies for synthesis and curing reactions, which increases the reactivity of the resoles and facilitates their curing processes resulting in higher bond strength properties (Dunky, 2003). Similar trend was observed by Chow (1997), who also reported higher bond strength with higher F/P molar ratio of up to 1.4 for plywood adhesives. However, care must be taken not to exceed the acceptable threshold for free formaldehyde content for LFP resoles synthesized with higher F/P molar ratios.

5.3.2. Wood Failure

In addition to the maximum shear stress of resoles, it is important to consider the wood failure percentage of each LFP resole. Higher wood failure percentages indicate increased failure at the wood as opposed to the glue-line. Although it is more of a qualitative property, LFP resoles can exhibit varying wood failure percentages depending on the synthesis parameters and the resultant viscosities of the resoles. In this research work, it

was observed that LPF resoles with exceedingly high viscosities such as LPF-75,(0),1.2 and LPF-75,(0),3 were associated with poor wood failure as compared to those with lower viscosities such as pure phenolic resins (see Figures 5-7 and 5-8). At higher resin viscosities, the adhesive penetration into the wood surface is low, which reduces the mechanical interlocking of the resin and the wood thereby increasing the likelihood of failure at the glue-line as opposed to failure at the wood.



Figure 5- 7: Test specimens after failure for pure PF resole synthesized with F/P of 2.1 (wood failure)

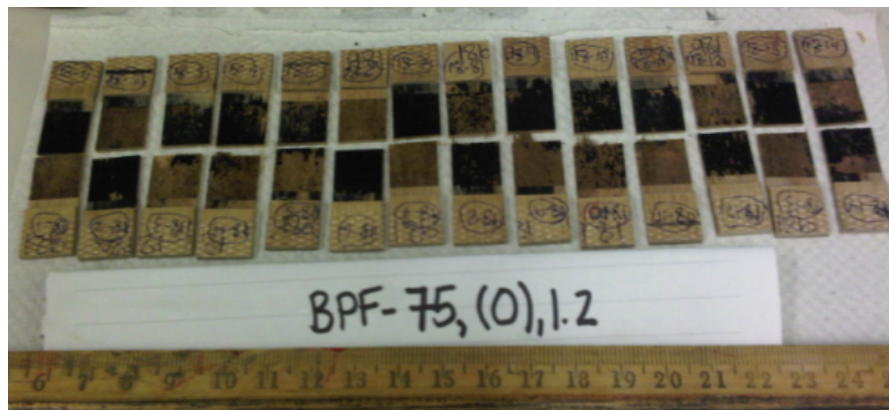

Figure 5- 8: Test specimens after failure for LPF-75,(0),1.2 (no wood failure)

5.5. Conclusions

- (1) All the phenolic resoles synthesized successfully met the minimum bond strength requirement of 2.5 MPa for wood applications.
- (2) When compared to conventional phenolic resins, lignin phenol formaldehyde (LPF) resoles require higher curing temperatures for enhanced shear strength properties. When tested at press temperature of 180°C, the maximum shear stresses of the LPF resoles at

failure increased with increasing F/P ratios and higher weight average lignin molecular weights.

(3) The effect of phenol percent substitution on the maximum shear strength depended upon the viscosities of the LPF resoles. If the viscosities were within the acceptable range for wood adhesives (150-600 cP), higher percent substitutions resulted in higher maximum shear stresses of LPF resoles. However, the penetration of adhesives into the wood was very low for resoles with exceedingly high resin viscosities.

(4) For a given resin, it is important to consider the percentage of wood failure in addition to reporting shear stress values, as higher percentages of wood failure are desirable for phenolic resins as wood adhesives.

5.7. References

- Canadian Construction Materials Centre. (2009). Wood Adhesives. Retrieved May, 2013 from http://www.nrc-cnrc.gc.ca/ccmc/registry/pdf/06%2005%2023.02_e.pdf.
- CertiWood Technical Centre. (2012). Glueline Characteristics. Retrieved May, 2013 from http://www.canply.org/english/literature_media/tech_glue.htm.
- Chow, S. (1977). A curing study of phenol-resorcinol-formaldehyde resins using infrared spectrometer and thermal analysis. *Holzforschung-International Journal of the Biology, Chemistry, Physics and Technology of Wood*, 31(6), 200-205.
- Dunky, M. (2003). Adhesives in the wood industry. *Handbook of Adhesive Technology*, 2.
- Frihart, C. R. (2005). Wood adhesion and adhesives. *Handbook of Wood Chemistry and Wood Composites*, 215.
- He, G., & Yan, N. (2005). Effect of wood on the curing behavior of commercial phenolic resin systems. *Journal of Applied Polymer Science*, 95(2), 185-192.
- Kamke, F. A., & Lee, J. N. (2007). Adhesive penetration in wood: A review. *Wood and Fiber Science*, 39(2), 205-220.
- Khan, M. A., & Ashraf, S. M. (2007). Studies on thermal characterization of lignin. *Journal of Thermal Analysis and Calorimetry*, 89(3), 993-1000.

- Kurt, R., & Cil, M. (2012). Effects of press pressures on glue line thickness and properties of laminated veneer lumber glued with phenol formaldehyde adhesive. *BioResources*, 7(4), 5346-5354.
- Monni, J., Alvila, L., & Pakkanen, T. T. (2007). Structural and physical changes in phenol- formaldehyde resol resin, as a function of the degree of condensation of the resol solution. *Industrial & Engineering Chemistry Research*, 46(21), 6916-6924.
- Obucina, M., Turk, G., Dzaferovic', E., & Resnik, J. (2013). Influence of gluing technology on physical and mechanical properties of laminated veneer lumber. *Drvna Industrija*, 64(1), 33-38.
- Pilato, L. (2010). *Phenolic resins: A century of progress*. Berlin, Germany: Springer.
- Pizzi, A. (1994). *Advanced wood adhesives technology*. CRC Press.
- Pizzi, A. (2003). Phenolic resin adhesives. *Handbook of Adhesive Technology*, 541-571.
- Rodriguez, F. (1996). *Principles of polymer systems*. New York: Taylor & Francis.
- Rowell, R. M. (1984). Penetration and reactivity of cell wall components. *The Chemistry of Solid Wood*, 175-210.
- Stark, N. M., Cai, Z., & Carll, C. (2010). Wood-Based composite materials: Panel products, glued- laminated timber, structural composite lumber, and wood-nonwood composite materials. *Wood Handbook: Wood As An Engineering Material*, 11-1.

Chapter 6: Synthesis of Lignin-based PF (LPF) Resoles at Large Phenol Substitution Ratios using De-polymerized Lignin from Hydrolytic Depolymerization of Kraft Lignin: Synthesis Parameter Optimization for Curing Temperature

6.1. Introduction

Phenol formaldehyde (PF) resins are widely known for their superior strength and moisture resistance properties and have been extensively used in wood adhesion application. Around 95% of the phenol used in the production of PF resins is derived from petroleum products (LigniMatch, 2011). Due to depleting fossil fuel reserves as well as increasing environmental concerns as a result of accumulating greenhouse gases in the atmosphere, scientists and researchers have shown interest in replacing the phenol in PF resins with a renewable feedstock such as tannin, cashew nut shell, and lignin. Lignin-substituted phenol formaldehyde (LPF) resins have been of particular interest given the wide availability of lignin as well as its low cost and low toxicity in comparison to petroleum derived phenol (Hu *et al.*, 2011).

Lignin is composed of three different phenyl-propane monomer units including p-hydroxy-phenyl-propanol, guaiacyl-propanol, and syringyl-propanol predominantly bonded by aryl ether linkages (Nimani, 2011). Because of its complex structure, lignin has reduced reactive sites as compared to conventional phenols (Hu *et al.*, 2011; Pizzi *et al.* 1989; Marton *et al.* 1996). As such, direct use of lignin in the production of PF resins requires longer press times as well as higher curing temperatures (Stark *et al.*, 2010). Recent studies have proposed the inclusion of pretreatment processes such as demethylation or depolymerization of lignin to increase its reactivity by breaking its three-dimensional structure into oligomers of considerably smaller molecular weight ranges. Common depolymerization techniques include pyrolysis, liquefaction, oxidation, hydrogenation, and hydrolysis (Effendi *et al.*, 2008).

This research work examined the effects of weight average molecular weight of lignin, percent substitution of phenol to lignin, and formaldehyde-to-phenol ratio on the curing

temperature of LPF resoles. The aim of this chapter was to develop a model to predict and optimize the curing temperature of LPF resoles using the three synthesis parameters.

6.2. Experimental Procedure

Kraft lignin was obtained from FPIInnovations and depolymerized using hydrolysis reactions at varying severities as described in Chapter 3. Using Gel Permeation Chromatography, the relative weight average molecular weight, M_w of the depolymerized lignin (DL) products were determined to be $\sim 800\text{g/mol}$, $\sim 1200\text{g/mol}$, and $\sim 1700\text{g/mol}$. The DL products were then incorporated in the synthesis of 15 LPF resoles at varying formaldehyde-to-phenol ratios, phenol-to-lignin percent substitutions, and DL M_w across three levels (see Table 6-1). The LPF synthesis procedure is described in Chapter 3. The actual values of factors were coded using the equation: $x_i = (x_i - x_i^0)/\Delta x_i$, where x_i is coded value for the i th independent variable, x_i^0 is the actual value of the i th independent variable at the centre point, and Δx_i is the step change value (Qi *et al.*, 2009). The experiments were designed based on a three-factor Box Behnken Design (BBD) as shown in Table 6-2.

Table 6- 1: Coded Values of the Variables for the Box-Behnken Design

Parameter	Variable	Level (-1)	Level (0)	Level (+1)
Phenol-to-lignin substitution (%)	x_1	25	50	75
Average molecular weight, M_w of (DL) (g/mol)	x_2	800	1200	1700
Formaldehyde-to-phenol (F/P)	x_3	1.2	2.1	3

6.2.1. Box-Behnken Design (BBD)

Box-Behnken Design is a three-level partial factorial design where experiments are statistically designed to have treatment combinations that are at the midpoints of the edges of the experimental space. The total number of experiments follow the equation $N=2k(k-1) + C_0$, where k is the number of parameters, factors, or variables, and C_0 is the number of central points. In this research work, a total of 15 LPF resoles were prepared with three central points and three factors ($N = (2)(3)(3-1) + 3 = 15$).

Table 6- 2: Box-Behnken Design Matrix for the effect of phenol-to-lignin substitution, (x_1) Lignin Mw (x_2), F/P molar ratio (x_3) on the Curing Temperature ($^{\circ}\text{C}$) of LPF resoles including experimental results

Sample ID*	Experiment Number	Variable Levels			Response, T ($^{\circ}\text{C}$)
		X_1	X_2	X_3	
LPF-25,(0),1.2	1	-1	0	-1	139.27
LPF-25,(0),3	2	-1	0	+1	193.95
LPF-75,(0),1.2	3	+1	0	-1	180.14
LPF-75,(0),3	4	+1	0	+1	185.99
LPF-50,(-1),1.2	5	0	-1	-1	219.50
LPF-50,(-1),3	6	0	-1	+1	200.09
LPF-50,(+1),1.2	7	0	+1	-1	227.66
LPF-50,(+1),3	8	0	+1	+1	190.90
LPF-25,(-1),2.1	9	-1	-1	0	211.17
LPF-75,(-1),2.1	10	+1	-1	0	194.96
LPF-25,(+1),2.1	11	-1	+1	0	216.20
LPF-75,(+1),2.1	12	+1	+1	0	191.75
LPF-50,(0),2.1 (1)	13	0	0	0	189.57
LPF-50,(0),2.1 (2)	14	0	0	0	186.91
LPF-50,(0),2.1 (3)	15	0	0	0	181.44

*Note: Samples are labeled as follows: LPF-%substitution of phenol with lignin, Lignin Mw level, F/P ratio.

Following the design of the experiments (Table6-2), the resoles were synthesized and the curing temperatures were determined using Differential Scanning Calorimetry in dynamic mode from 40°C to 350°C at $10^{\circ}\text{C}/\text{min}$ under $50 \text{ mL}/\text{min}$ of nitrogen gas. Using Minitab, the regression coefficients were estimated and a mathematical model for predicting the curing temperature was built and used to predict the response. The model was then tested for adequacy using analysis of variance (ANOVA) and also interpreted using surface and contour plots.

6.3. Results and Discussion:

The response (curing temperature) was determined using DSC. All of the DSC thermograms depicted at least two peaks; the first appeared in the temperature range 115°C and 135°C while the second appeared in the temperature range 140°C-230°C. The one exception was LPF-25,(0),1.2 (see Experimental run '1' in Table 6-2), where only one peak appeared at 139°C. A box-plot of the response (curing temperature) in Figure 6-1 shows that the curing temperature for LPF-25,(0),1.2 was an outlier. Thus, this data point was excluded from the model building.

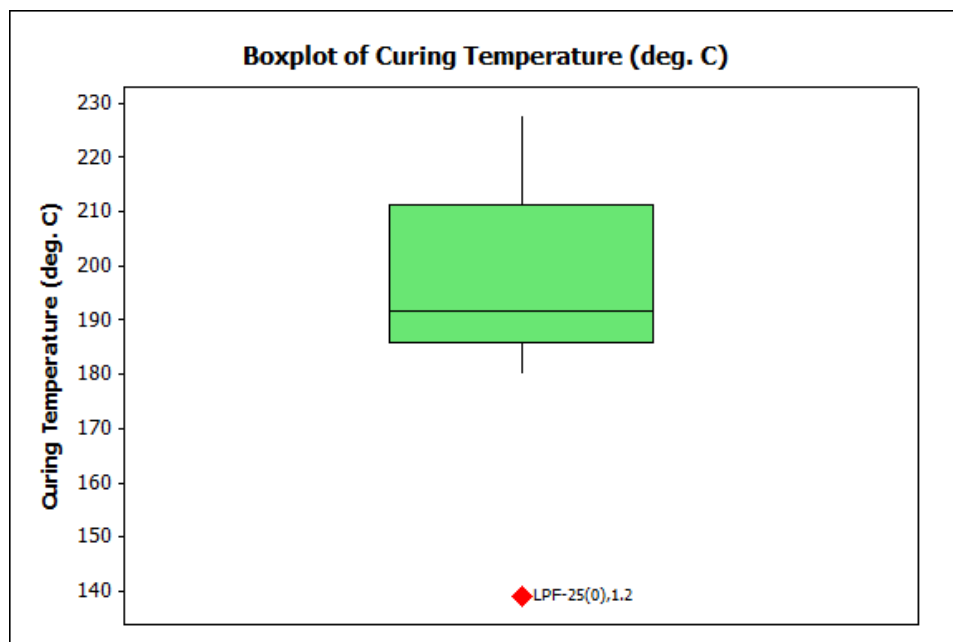

Figure 6- 1: Box-plot of Curing Temperatures (deg. C)

6.3.1. Model Building and Regression Adequacy

Using Minitab, the following regression model of response was built (using coded analysis):

$$T = 185.55 - 9.68x_1 - 14.04x_3 + 17.77 x_2^2 + 6.39 x_3^2 + 16.49 x_1x_3 - 4.34 x_2x_3$$

Where x_1 is the substitution of phenol with lignin, x_2 is the weight average molecular weight of lignin (g/mol); x_3 is the formaldehyde-to-phenol ratio; x_2^2 and x_3^2 are the quadratic terms for second and third variables respectively; and x_1x_3 and x_2x_3 are the interaction terms.

The regression model had the following coefficient of multiple determination (as determined by Minitab):

$$R^2 = 98.05\%; R^2_{\text{pred}} = 94.04\%; R^2_{\text{adj}} = 95.77\%$$

Therefore, ~98% (R^2) of the variability in curing temperature is accounted for by the model above. R^2_{adj} was used to ensure that the model is not over-fitted. ~94% for R^2_{pred} indicates that the model seems to predict responses to new observations very well. The statistical significance of the coefficients, regression, and residual errors was checked using the F-test and the p-value test as shown in Table 6-3 and Table 6-4.

Table 6- 3: Statistical Significance of the Coefficient of the Regression

Model Term	Parameter Estimate	Standard Error	T-value	p-value
Constant	185.55	1.77	105.03	0.00
x_1	-9.68	1.30	-7.43	0.002
x_2	0.10	1.10	0.09	0.933
x_3	-14.04	1.55	-9.04	0.001
x_1^2	0.04	1.78	0.02	0.982
x_2^2	17.77	1.76	10.07	0.001
x_3^2	6.39	1.94	3.29	0.030
x_1x_2	-2.11	1.55	-1.36	0.244
x_1x_3	16.49	2.70	6.12	0.004
x_2x_3	-4.34	1.55	-2.79	0.049

Table 6- 4: Analysis of Variance (ANOVA) for the Regression

Source	df	Sum of Squares	Mean Squares	F-value	p-value
Regression	7	2840.88	405.84	43.07	0
Residual	6	56.54	9.42		
Total	13	2897.42			

As can be seen from Table 6-3, three coefficients were not significant based on a confidence interval of 95% where the corresponding p -values $> \alpha = 0.05$ including x_2 , x_1^2 , and x_1x_2 . Thus, these coefficients were not including in the regression model. From the ANOVA in Table 6-4, it can be seen that the estimator of variance, $\hat{\sigma}^2$ is 9.42 and the p -value is 0 indicating that the regression model is significant. The normal probability plot (Figure 6-2) indicates that assumption that the errors are normally distributed was a

good prediction. The absence of a visible pattern in the residual versus fitted plot (Figure 6-3) indicates model adequacy.

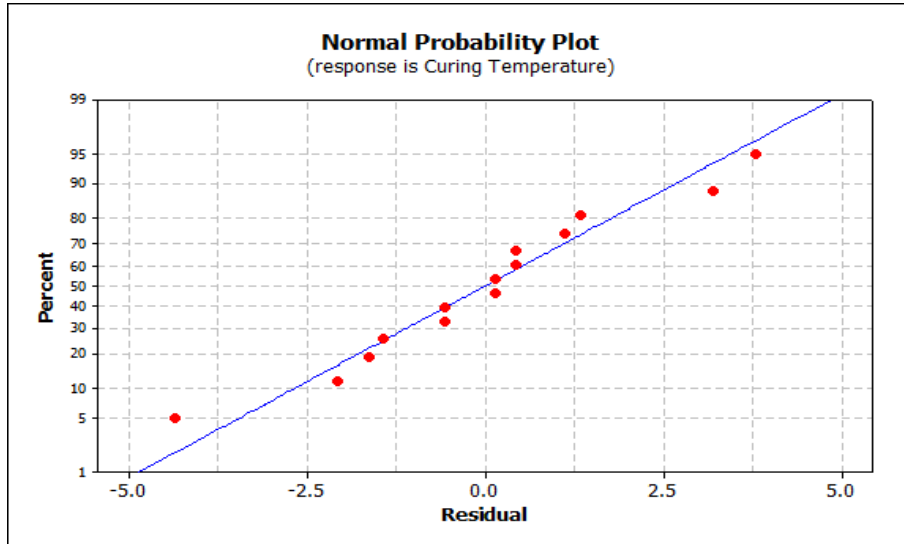

Figure 6- 2: Normal Probability Plot for Curing Temperature Response

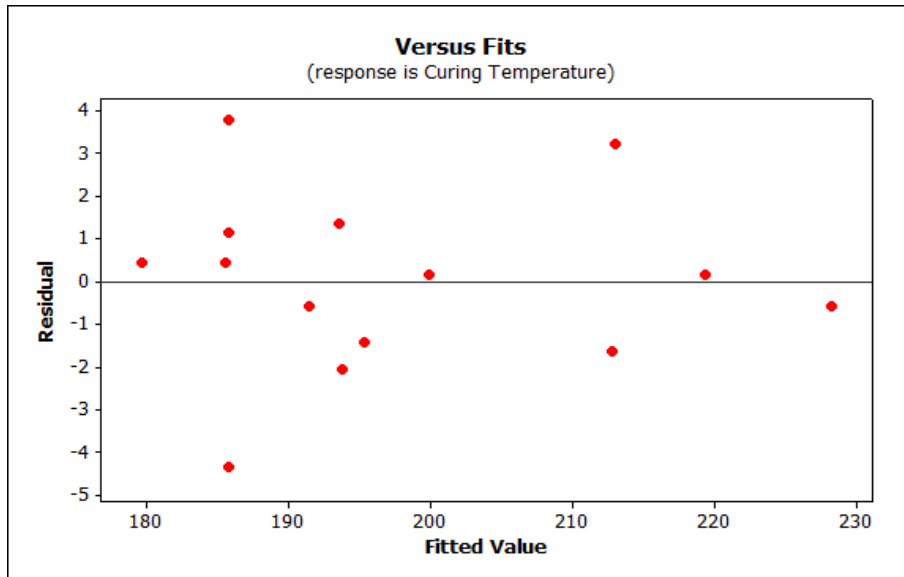

Figure 6- 3: Residuals versus Fitted values of the Regression

Figure 6-4 shows the actual curing temperatures of the LPF resoles plotted against the predicted curing temperatures from the model. As can be seen, there was an agreement between the predicted data and the actual data for the curing temperature.

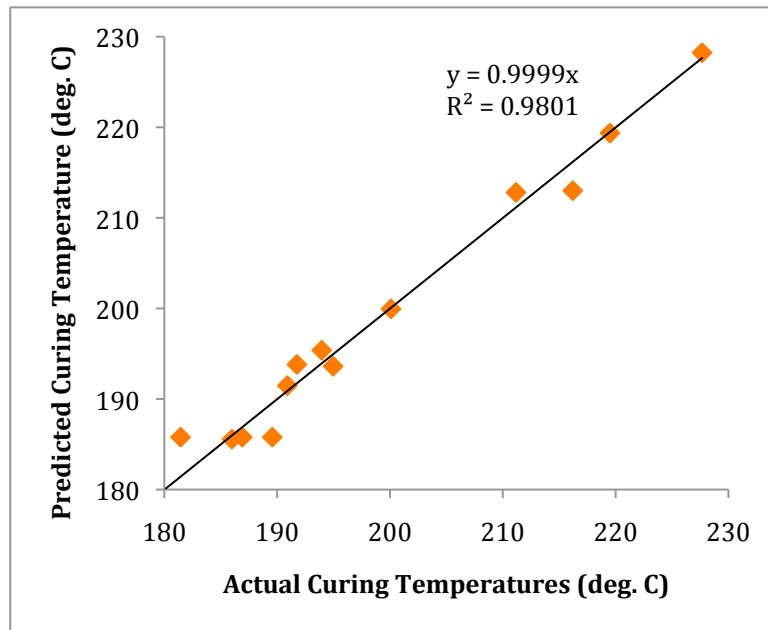

Figure 6- 4: Predicted versus Actual (Curing Temperature)

6.3.2. Interaction Effects

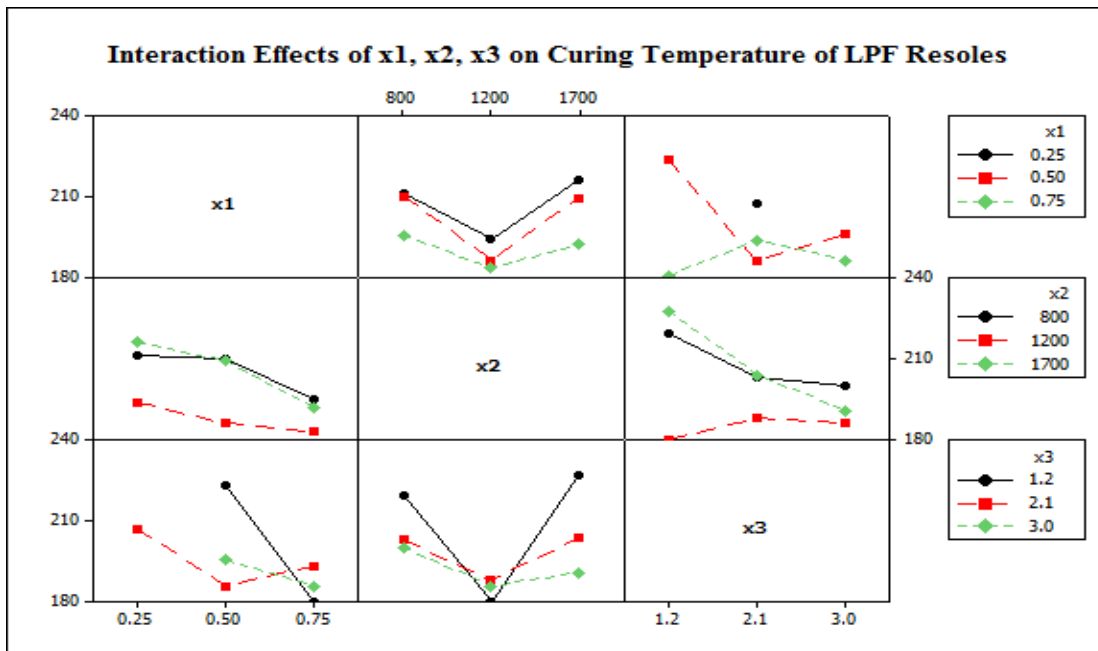

Figure 6- 5: Interaction Effects on Curing Temperature of LPF resoles

Figure 6-5 shows the interaction effects of the regression model, where the plots for means of each level of a factor are given while keeping the second factor constant. Absence of parallel lines indicates that the response of one variable depends upon the levels of other variables. As such, assessment of the effect of any of the variables

(substitution of phenol with lignin, Lignin Mw, and formaldehyde-to-phenol ratio) has to be done with respect to the other variables.

6.3.3. Surface and Contour Plots

6.3.3.1. Effect of F/P and Lignin Mw at Constant Percent Substitutions (25%, 50%, 75%) on Curing Temperatures

Figure 6-6 and Figure 6-8 show the surface plots and contour plots (respectively) of lignin weight average molecular weight (x_2) and F/P molar ratio (x_3) on the curing temperature when held constant at substitution percentage of (a) 25%; (b) 50%; and (c) 75%. As can be seen from Figure 6-6(a) and Figure 6-7, at 25% substitution of phenol with lignin, lowest curing temperature range occurs at an F/P ratio of slightly higher than 2.5 for lignin Mw of ~ 1200 g/mol and at F:P ratio of 3 for lignin Mw in the range of ~ 1000 to ~ 1600 g/mol. Lower F/P ratios result in higher curing temperatures particularly at highest and lowest ranges of lignin Mw.

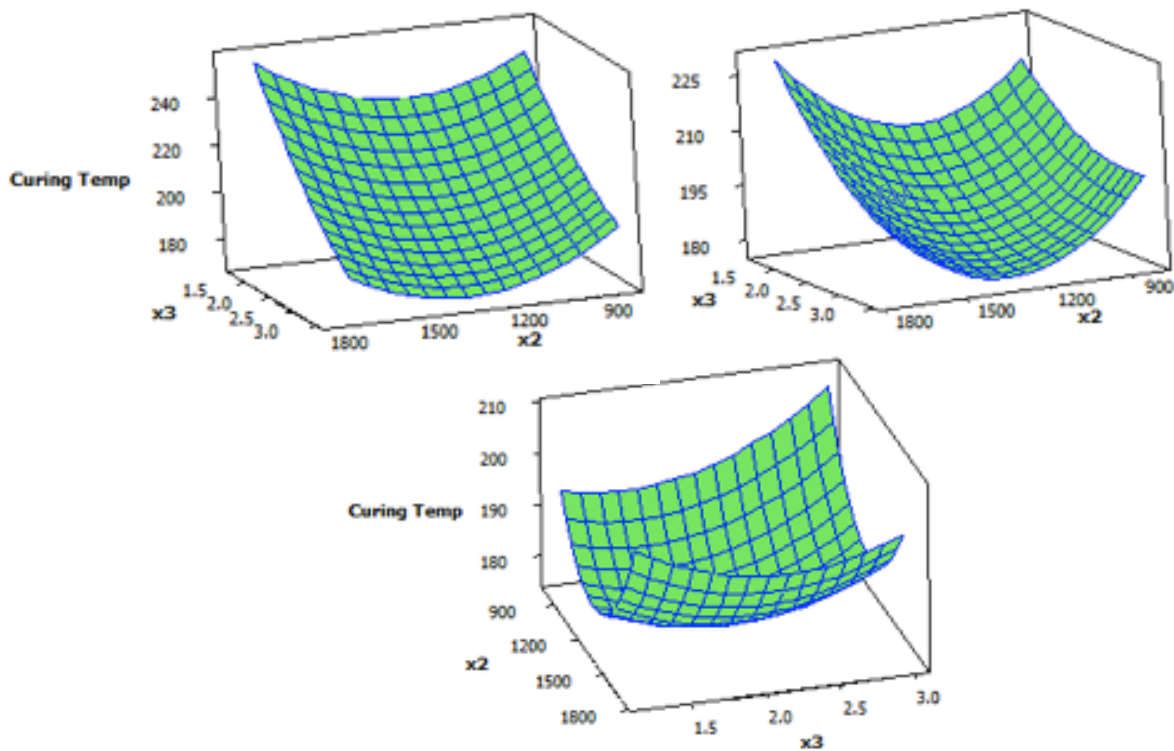

Figure 6- 6: Surface plots for effect of Lignin Mw and F/P on Curing Temperature of LPF Resoles at substitution of phenol with lignin at (a) 0.25; (b) 0.50; & (c) .075

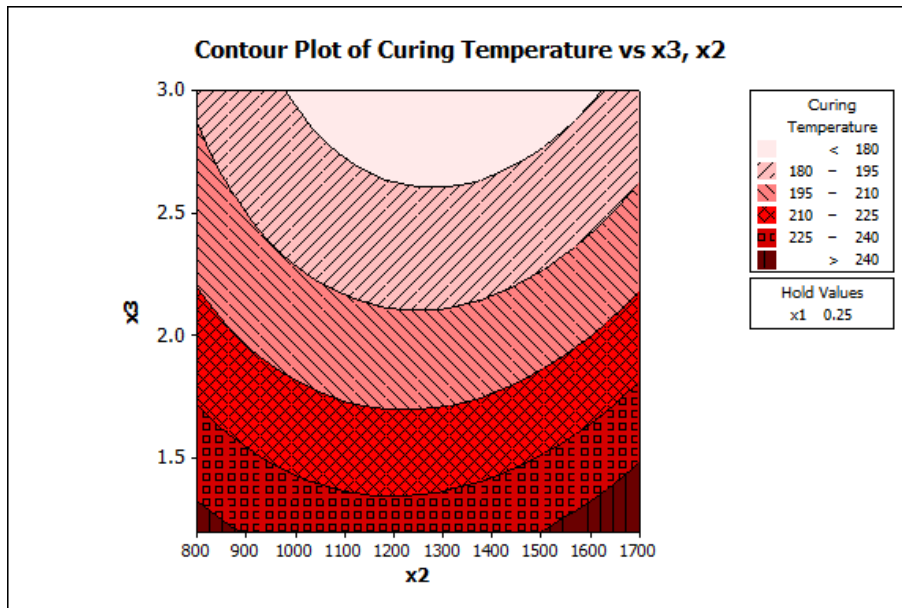

Figure 6- 7: Contour Plot for Lignin Mw (x_2) & F/P (x_3) on curing temperatures of LPF resoles at 25% substitution of phenol with lignin

Similar trend can be seen when the contour plot is held constant at 50% substitution of phenol with lignin (Figure 6-6b and Figure 6-8); however, the lowest curing temperatures occurs at a narrower range of lignin Mw especially at F/P ratio of 3 (~1100-1450g/mol). At 75% substitution of phenol with lignin (Figure 6-6c and Figure 6-9), it can be seen that lowest curing temperatures can occur at lower F/P ratios while temperature range of 180°C to 185°C can occur at F/P ratio of 3 provided that the lignin Mw is ~1250 g/mol. At lignin Mw of less than 900g/mol and greater than ~1550g/mol, the curing temperature increases at varying rates depending on the F/P ratios when held constant at 75% substitution of phenol with lignin.

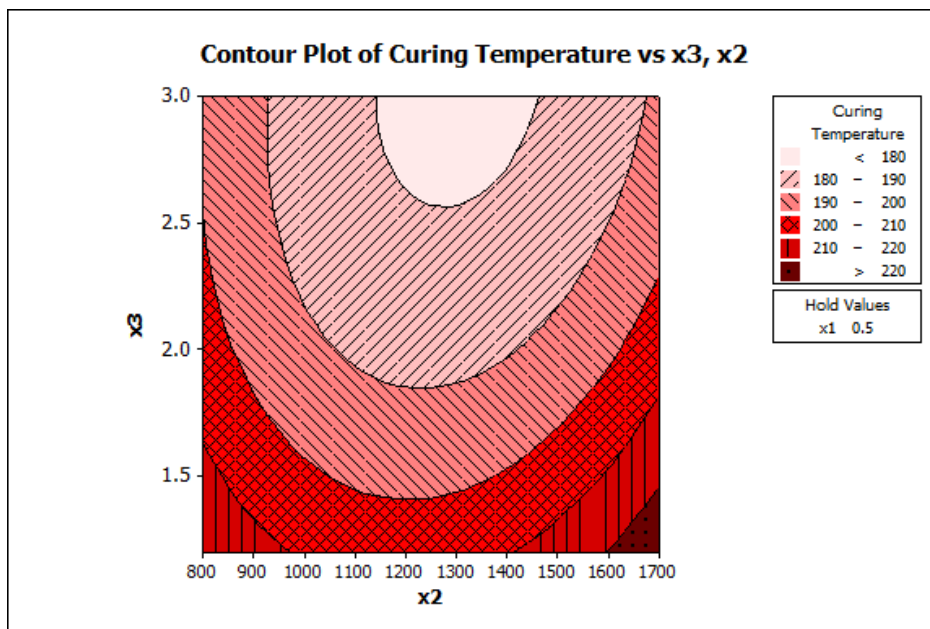

Figure 6- 8: Contour Plot for Lignin Mw (x_2) & F/P (x_3) on curing temperatures of LPF resoles at 50% substitution of phenol with lignin

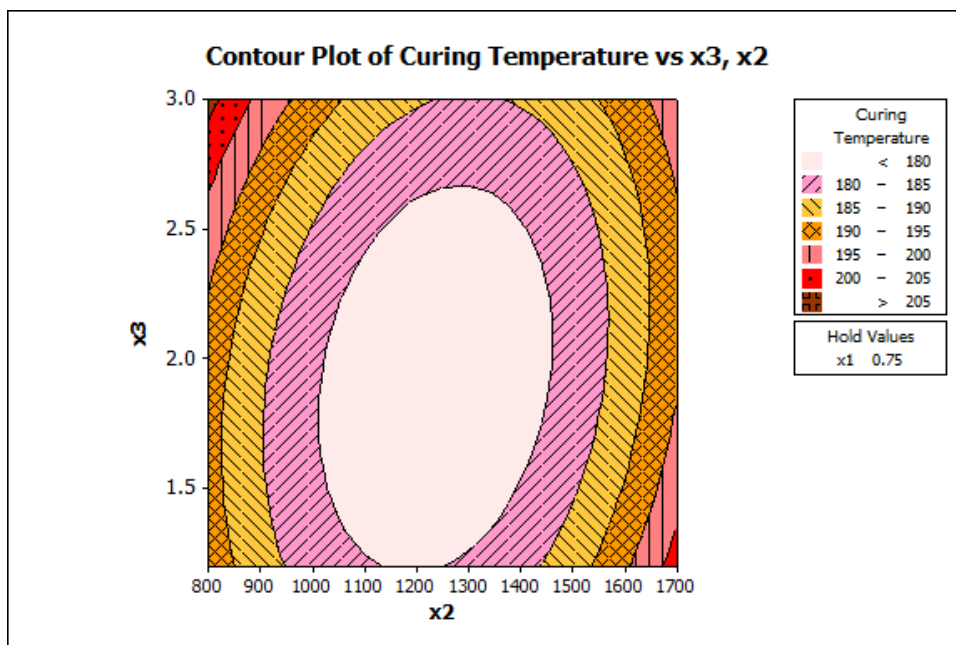

Figure 6- 9: Contour Plot for Lignin Mw (x_2) & F/P (x_3) on curing temperatures of LPF resoles at 75% substitution of phenol with lignin

6.3.3.2. Effect of Percent Substitutions and Lignin Mw at Constant F/P ratios (1.2, 2.1, 3) on Curing Temperatures

Figure 6-10 shows the contour plot for substitutions of phenol with lignin and lignin Mw while holding the F/P ratio constant. As can be seen, the two extremes of lignin Mw do not yield the lowest curing temperatures. At higher percent substitutions, the range of lignin Mw that can yield the lowest curing temperature increase, allowing for more variation in lignin Mw at higher percent substitutions. Lignin of Mw ~1200 g/mol allows for yield of lowest curing temperatures (less than 190°C) from around 35% substitution of phenol with lignin and upto 75% (based on the data range).

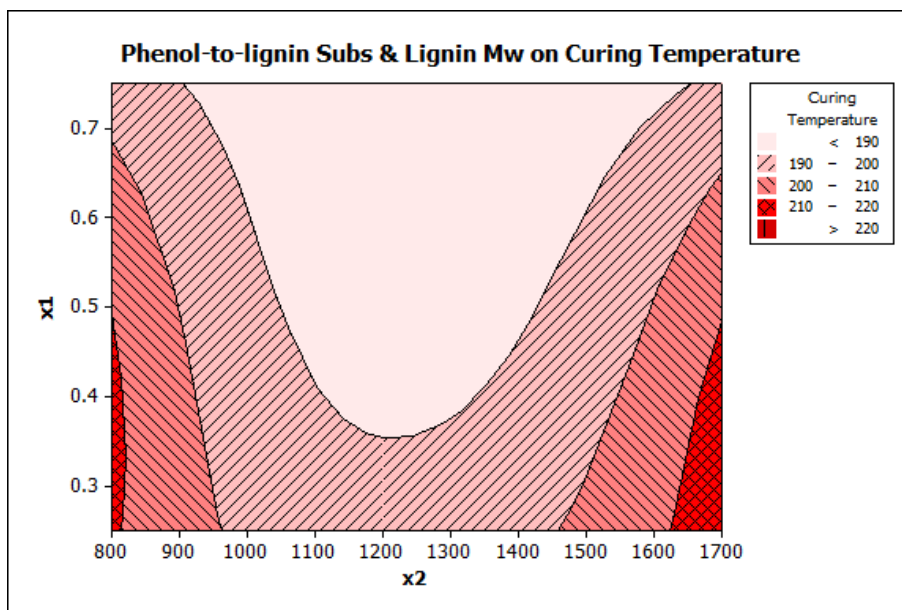

Figure 6- 8: Contour Plot for substitution of phenol with lignin (x_1) Lignin Mw (x_2) on curing temperatures of LPF resoles

6.3.3.3. Effect of Percent Substitutions and F/P at Lignin Mw (800g/mol and 1700g/mol) on Curing Temperatures

Figure 6-11 shows the contour plot for the substitution of phenol with lignin (x_1) and F/P ratio (x_3) on the curing temperature while keeping the lignin Mw constant. As can be seen, lowest curing temperatures of less than 190°C occur at the centre of the two variables as well as at extremes of F/P ratio and high substitution percentage. Therefore, to attain LPF resoles with high percent substitutions, LPF resoles must be synthesized either with low F/P ratios or high F/P ratios. Although low F/P may be desirable for less free formaldehyde content, other factors also need to be taken into consideration like the adhesive strength and the thermal stability of the LPF resoles at both F/P ratios.

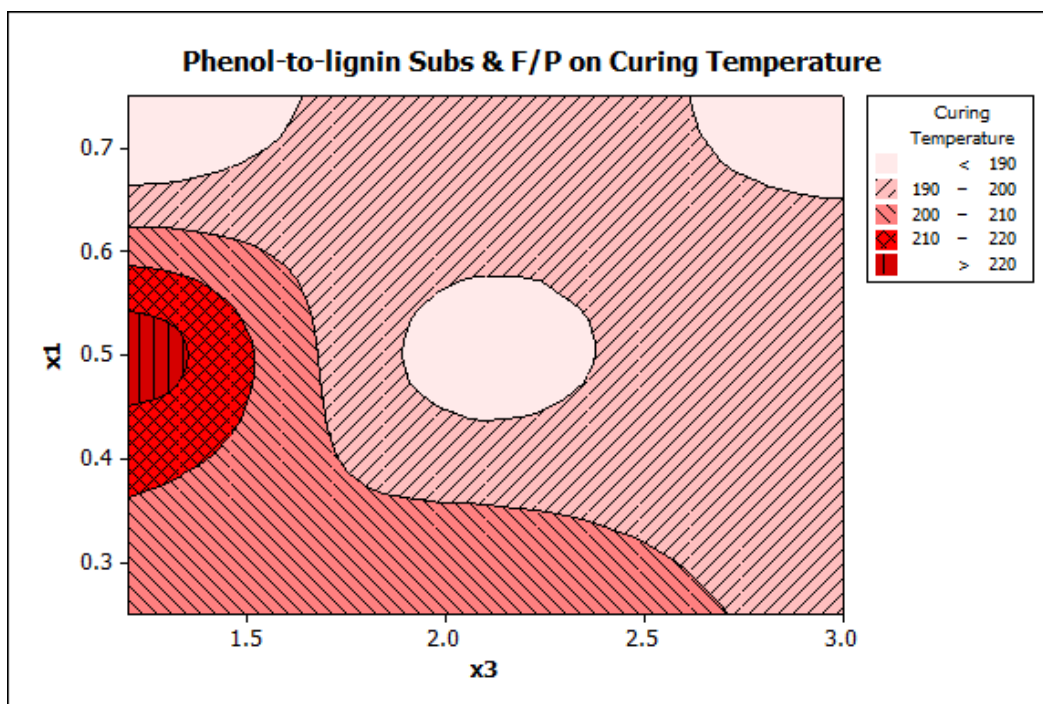

Figure 6- 9: Contour Plot for substitution of phenol with lignin (x_1) & F/P (x_3) on curing temperatures of LPF resoles

At low lignin Mw (~ 800 g/mol), it can be seen that for high percent substitution, increasing the F/P ratio yields in low curing temperatures of less than 200°C until around F/P ratio of 2.5, where the curing temperature range increase slightly (Figure 6-12). At low lignin Mw (~ 800 g/mol) and at lower percent substitutions, higher F/P ratios are preferred. Figure 6-13 shows that the contour plot for substitution of phenol with lignin and F/P ratio when lignin at higher Mw (~ 1700 g/mol) is held constant. It can be seen that curing temperatures lower than 190°C can be attained for LPF resoles synthesized at low percent substitutions and high F/P ratio. However, curing temperatures in the range of 190°C - 200°C can be still be attained for higher percent substitutions and higher lignin Mw as long as the F/P ratio is higher than 1.2. For both high and low lignin Mw, curing temperatures start to increase when substitution percentage and F/P are decreased.

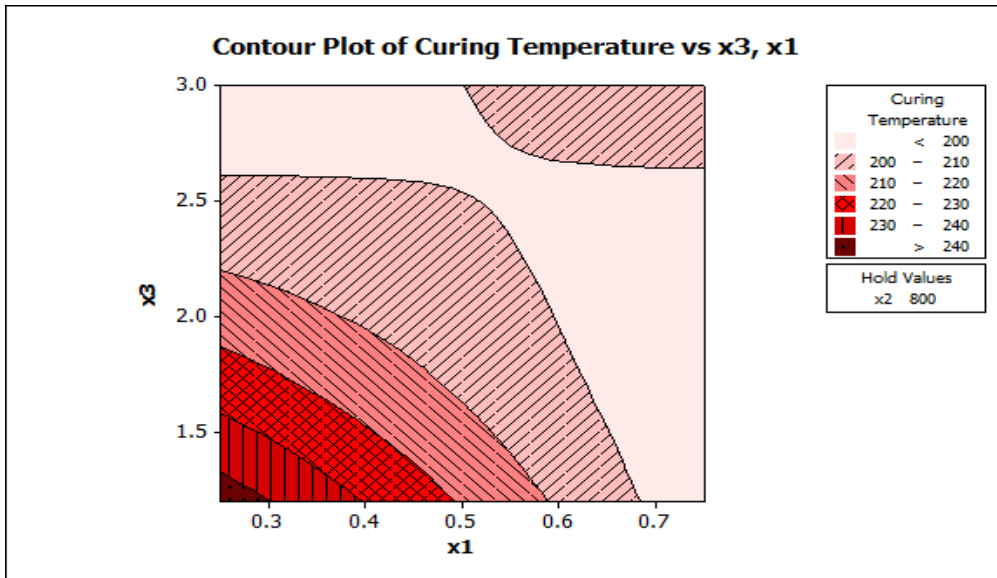

Figure 6- 10: Contour Plot for substitution of phenol with lignin (x_1) & F/P (x_3) on curing temperatures of LPF resoles at Lignin Mw of 800 g/mol

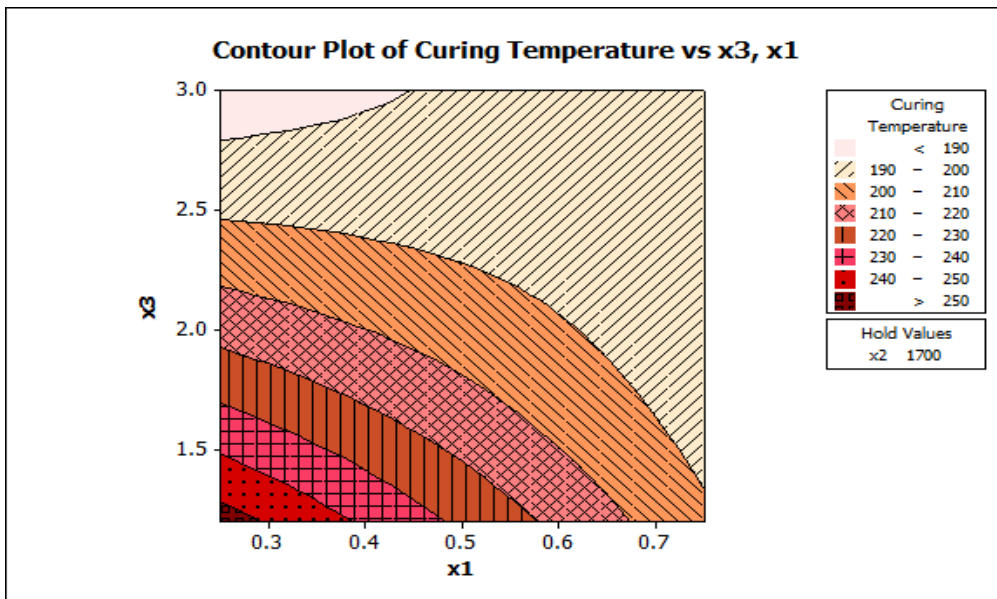

Figure 6- 11: Contour Plot for substitution of phenol with lignin (x_1) & F/P (x_3) on curing temperatures of LPF resoles at Lignin Mw of 1700g/mol

6.4. Conclusions

A regression model was successfully built for the prediction of curing temperature using the synthesis parameters substitution of phenol with lignin, average weight molecular weight of lignin (Mw) and formaldehyde to phenol ratio. It was verified for its fit and adequacy using the coefficients of determination, analysis of variance (ANOVA), significance test of coefficients, normal probability plot, residuals versus fitted data plot, and the predicted versus actual plot. Contour and surface plots indicate that lignin average weight molecular weight should be ~1200 g/mol provides low temperatures of less than 180°C at any substitution percentage. Studies have indicated that the incorporation of lignin can reduce the curing temperature of the resin because it allows for larger molecules to make contact and hence enhances entanglement of final resole network (Rodriquez, 1996). However, at higher lignin Mw, steric hindrance effects may start to hinder the cross-linking reaction rates. For both high lignin Mw and low lignin Mw, curing temperature increases with lower F/P ratios and lower substitution of phenol-to-lignin. At 25% and 50% substitution of phenol with lignin, increasing the F/P ratio allows for synthesis of resins with low curing temperatures. Increasing the substitution of phenol-to-lignin allows for a broader range of lignin weight average molecular weight to attain low curing temperatures.

6.5. References

- Effendi, A., Gerhauser, H., & Bridgwater, A. V. (2008). Production of renewable phenolic resins by thermochemical conversion of biomass: A review. *Renewable and Sustainable Energy Reviews*, 12(8), 2092-2116. Retrieved from Google Scholar.
- Hu, L., Pan, H., Zhou, Y., & Zhang, M. (2011). Methods to improve lignins reactivity as a phenol substitute and as replacement for other phenolic compounds: A brief review. *BioResources*, 6(3), 3515-3525. Retrieved from Google Scholar.
- LigniMATCH. (2011). Future use of lignin in value added products – a roadmap for possible Nordic/Baltic Innovation. Retrieved May 2013 from <http://www.scanbalt.org/files/graphics/ScanBalt/Activities/ScanBalt%20Bridge%20Award/Roadmap%20100823.pdf>

- Marton, J., Marton, T., Falkehag, S. I., & Adler, E. (1966). Alkali-catalyzed reactions of formaldehyde with lignins. *Lignin Structure and Reactions. Advances in Chemistry Series*, 59, 125-144. Retrieved from Google Scholar.
- Nimani, L. (2011). Lignin depolymerization and conversion. 2011 Wisconsin Bioenergy Summit. Retrieved from <http://www.slideshare.net/lnimani/lignin-depolymerization-and-conversion-15269049>
- Pizzi, A., Cameron, F. -A., & van der Klashorst, G. H. (1989). Soda bagasse lignin adhesive for particleboard. *Adhesives From Renewable Resources*, 82-95. Retrieved from Google Scholar.
- Qi, B., Chen, X., Shen, F., Su, Y., & Wan, Y. (2009). Optimization of enzymatic hydrolysis of wheat straw pretreated by alkaline peroxide using response surface methodology. *Industrial & Engineering Chemistry Research*, 48(15), 7346-7353. Retrieved from Google Scholar.
- Rodriguez, F. (1996). *Principles of polymer systems* (Vol. 4). New York: Taylor & Francis. Retrieved from Google Scholar.
- Stark, N. M., Cai, Z., & Carll, C. (2010). Wood-Based composite materials: Panel products, glued- laminated timber, structural composite lumber, and wood-nonwood composite materials. *Wood Handbook: Wood As An Engineering Material*, 11-1. Retrieved from Google Scholar.

Chapter 7: Conclusions and Recommendations on Future Work

7.1 Conclusions

- (1) Kraft lignin was depolymerized into DL products with three distinct relative weight average molecular weights using hydrolysis reaction at varying reaction severities. DL products with a lower Mw were obtained at higher reaction temperatures at the expense of significantly lower yields. At moderate temperature of 300°C, the yield of DL was relatively moderate around 71wt% and the relative Mw was in a moderate range too (1,200 g/mol).
- (2) DLs with a lower Mw can be favorable feedstocks for the synthesis LPF resoles due to their reduced steric hindrance and increased reactive sites towards formaldehyde due to the increase in content of phenolic hydroxyl per lignin unit.
- (3) CHNS Elemental analysis of the DL products showed that sulfur compounds were reduced by depolymerizing KL using hydrolysis, which implies safer environmental conditions associated with DL products obtained from hydrolysis reactions.
- (4) The obtained DL products at three distinct Mw were successfully incorporated into the manufacture of lignin-based phenol formaldehyde (LPF) at high lignin-to-phenol percent substitution (25-75%).
- (5) Viscosity measurements of LPF resoles were taken for indication of the progress of reaction and as well as the degree of polymerization. Higher viscosities were attained for LPF resoles with higher phenol substitutions and DLs with a higher Mw.
- (6) Lower viscosities, low pH, and lower non-volatile contents (NVC) were observed with increasing F/P ratio due to increased water content as a result of higher formalin content with higher F/P ratios.
- (7) To improve the slightly low NVC of the resoles synthesized, the content of water and solvents used in the synthesis of LPF resoles can be used reduced or the synthesis reaction time can be lengthened. However, it is important to ensure that the resin polymer

does not experience gelation during synthesis reactions in order to avoid sudden drastic rise in the viscosities of LPF resoles.

(8) Increasing the F/P ratio results in increase of methylol substitutions in phenol and facilitates faster curing reactions for 50% substituted LPF resoles resulting in an infusible, highly crosslinked three-dimensional network of phenolic resin.

(9) At lower phenol percent substitutions, petroleum-derived phenol molecules dominate the phenolic feedstock for the synthesis of LPF resoles. As such, the incorporation of lignin products with lower average weight molecular weights with high phenolic hydroxyl content tends to decrease the curing temperature of LPF resoles.

(10) In contrast, at high phenol percent substitutions, lignin products dominate the phenolic feedstock for the synthesis of LPF resoles and hence incorporation of lignin products with higher average weight molecular weights tends to facilitate greater contact between larger and bulkier molecules, which results in enhanced curing rates and temperatures.

(11) The combined effect of high phenol percentage substitution and high F/P ratio can result in formation of LPF resoles with too high average weight molecular weights and significant steric hindrance effects that could impede the curing rate of the resoles.

(12) All the phenolic resoles synthesized successfully met the minimum bond strength requirement of 2.5 MPa for wood applications.

(13) When compared to conventional phenolic resins, lignin phenol formaldehyde (LPF) resoles require higher curing temperatures for enhanced shear strength properties. When tested at press temperature of 180°C, the maximum shear stresses of the LPF resoles at failure increased with increasing F/P ratios and higher weight average lignin molecular weights.

(14) The effect of phenol percent substitution on the maximum shear strength depended upon the viscosities of the LPF resoles. If the viscosities were within the acceptable range for wood adhesives (150-600 cP), higher percent substitutions resulted in higher maximum shear stresses of LPF resoles. However, the penetration of adhesives into the wood was very low for resoles with exceedingly high resin viscosities.

(15) For a given resin, it is important to consider the percentage of wood failure in addition to reporting shear stress values, as higher percentages of wood failure are desirable for phenolic resins as wood adhesives.

7.2 Recommendations on Future Work

This research work shows that lignin can be substituted with phenol in the production of phenolic resins at high percent substitutions and result in resins with superior adhesive strength properties. However, the curing temperature of lignin-substituted phenol formaldehyde (LPF) resoles is almost always higher than that of conventional phenolic resins (~150°C). Therefore, it is recommended to study the curing temperature of LPF with varying press-pressures and press times in an attempt to reduce the curing temperature while also maintain the high quality of the resins. It is also recommended to determine the moisture resistance of the synthesized LPF resoles through wet-adhesive bond testing to ensure acceptable standards with respect to conventional phenolic resins.

An exciting extension of this research work could focus on the optimization of degree of methylation and condensation reactions during the synthesis of LPF resoles to obtain low curing temperatures and high adhesive strength properties. This can be done through monitoring of resin viscosities or by measuring the resin molecular weights using Gel Permeation Chromatography at various intervals during the synthesis of LPF resoles.

Curriculum Vitae

Name: Homaira Siddiqui

Post-secondary Education and Degrees: The University of Western Ontario
London, Ontario, Canada
2007-2011 B.E.Sc

The University of Western Ontario
London, Ontario, Canada
2011-2013 M.E.Sc.

Honours and Awards: **Speaker of the Month**
CBE Graduate Seminars, Faculty of Engineering, UWO
October 2013

Best Presentation & Poster Award
Bioenergy IV Conference, Otranto, Italy
June 2013

Dean's Honour List
2008-2011
Faculty of Engineering

Related Work Experience Teaching Assistant
The University of Western Ontario
2012-2013