



Title	A study of the RF characteristics for wireless sensor deployment in building environment
Author(s)	Jafer, Essa; O'Flynn, Brendan; Ó Mathúna, S. Cian; Špinar, Rostislav
Publication date	2009-06
Original citation	Jafer, E., O'Flynn, B., O'Mathuna, C., Spinar, R., 2009. A study of the RF characteristics for wireless sensor deployment in building environment. In: Proceedings of the Third International Conference on Sensor Technologies and Applications SENSORCOMM '09. Athens/Glyfada, Greece 18-23 June 2009. Los Alamitos, California; Washington; Tokyo: IEEE Computer Society
Type of publication	Conference item
Link to publisher's version	http://dx.doi.org/10.1109/SENSORCOMM.2009.41 Access to the full text of the published version may require a subscription.
Rights	©2009 IEEE. Personal use of this material is permitted. However, permission to reprint/republish this material for advertising or promotional purposes or for creating new collective works for resale or redistribution to servers or lists, or to reuse any copyrighted component of this work in other works must be obtained from the IEEE.
Item downloaded from	http://hdl.handle.net/10468/155

Downloaded on 2017-02-12T05:38:39Z



UCC

University College Cork, Ireland
Coláiste na hOllscoile Corcaigh

A study of the RF characteristics for Wireless Sensor Deployment in Building Environment

Essa Jafer, Brendan O'Flynn, and Cian O'Mathuna
Tyndall national Institute, Lee Maltings, Prospect Row,
Cork, Ireland
brendan.oflynn@tyndall.ie

Rosta Spinar
Cork Institute of technology (CIT), Rossa Avenue,
Bishopstown
Cork, Ireland
Rostislav.Spinar@cit.ie

Abstract— In this paper, The radio Frequency (RF) Monitoring and Measurement of the Environmental Research Institute (ERI) located in Cork city will be monitored and analyzed in both the Zigbee (2.44 GHz) and the industrial, scientific and medical (ISM 433MHz). The main objective of this survey is to confirm what the noise and interferences threat signals exist in these bands. It was agreed that the surveys would be carried out in 5 different rooms and areas that are candidates for the Wireless Sensors deployments. Based on the carried on study, A Zigbee standard Wireless Sensor Network (WSN) will be developed employing a number of nodes for sensing number of signals like temperature, light and humidity beside the RSSI and battery voltage monitoring. Such system will be used later on to control and improve indoor building climate at reduced costs, remove the need for cabling and both installation and operational costs are significantly reduced.

Keyword: Building monitoring, RF Characteristics, Wireless Sensor Network, Nodes deployment

I. INTRODUCTION

The primary focus of building automation is the reduction of energy consumption in the building installations through automated mechanisms to lower total energy costs and comply with governmental regulations. Building automation comprises a set of diverse functions that includes energy conservation, environment control, lighting control, safety and security [1-2]. All of this functionality can be overlaid in a common communications network since the characteristics of each of these functions require similar performance requirements. The interest in using wireless sensor networking in building automation applications is based on the need to lower installation cost which comes in the form of cabling, labor, materials, testing, and verification.

For example, the installation cost of a light switch in a building facility can be as high as 10–30 times the cost of the switch; this estimate does not include the possibility of additional work such as conduit installation and infrastructure work. Furthermore, the installation cost of a large number of existing building facilities can be prohibited high due to the existence of pollution agents such as

asbestos; in this case, wireless sensor networks and power line carrier are the only solution viable for retrofitting buildings with business automation machinery. Low cost power line carrier still shows serious reliability issues that limit the use of the technology [3].

While the mobility of wireless sensors is irrefutable, the cost of the wireless technology at the current time may still be too high to penetrate the market more widely. This may soon change. According to a 2004 market assessment of the wireless sensor networks, the cost of the radio frequency (RF) modules of sensors is projected to drop below \$12 per unit in 2005 and drop further to \$4 per unit by 2010 [4-5]. While these costs reflect only one portion of a wireless sensor, the sensor cost is also expected to be reduced with technology advancements. For instance, digital integrated humidity and temperature sensors at high volumes are currently commercially available for less than \$3 per sensor probe. The general trend in sensor technology development toward solid state technology is likely to produce low-cost sensors for the mass markets.

Advancements in the sensor and wireless industries provide a significant opportunity for building owners, operators, and energy service companies to consider controls upgrades to improve the overall energy efficiency, become more demand responsive, and to improve the indoor environmental conditions.

II. THE ARCHITECTURE OF THE ZIGBEE SENSOR MODULE

Zigbee Module is able to perform RF (Chipcon CC2420) communication and Serial (RS-232c) communication through 8 Bit Microcontroller (ATMEL ATMegal28L) as presented by Figure 1. Diverse works can be controlled through the internal and external Timer Interrupts, as well as real time based operations. Additionally, other device operations can be controlled through external interrupt, ADC port, etc. Devices using serial port can be controlled using UART port. The microcontroller has 128K Bytes flash memory, 4K Bytes EEPROM, and 4K Bytes SDRAM, internally. Real-time based functions can be implemented

using the 8 MHz internal clock and 32 KHz external interrupt clock.

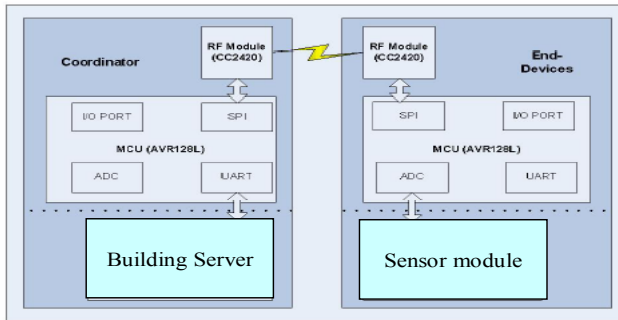

Figure 1. Zigbee Module H/W Architecture

It is connected with RF Chip (CC2420) through SPI interface, at maximum communication rate of 250Kbps. The sensors module can measure three different data these are light, temperature and humidity.

A. Tyndall Prototyping 25mm System Selecting a Template

The aim of 25 mm sensor module, shown in Figure 3 is to provide a novel 3-D programmable modular system that could be used as a toolkit for ambient systems research (such as robotics, autonomous agents and neural networks, telemetry, transducer networks, etc) [6].

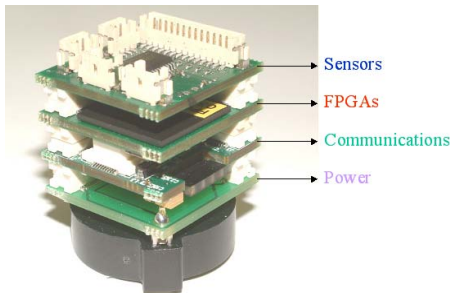

Figure 2. Tyndall 25mm Mote

The target objective for the 25 mm cube module is to be used in the building deployment phases and it mainly includes:

1. The RF Zigbee platform as described before act as the communication layer.
2. A platform for sensing and actuating.
3. A platform for signal processing and conditioning using Xilinx based FPGA device.

III. FIELD TEST EVALUATION IN ERI

This section presents field test evaluation results of the wireless sensor network based on the initial deployment in the ERI. The results show an analysis of the radio frequency performance and interference issues in the ERI as well as results from the sensing evaluation.

A. Test Environment

Prior to deploying the motes, a radio frequency signal strength (RSSI) analysis of the building was performed to enable proper node location planning so as to ensure sufficient radio communication field strength. The Tyndall mote platform itself was used to measure RSSI values.

For example, the immunology laboratory located on the ground floor of the ERI had high RSSI values (between -59dBm and -43dBm) compared to the RSSI quality of the surrounding areas as seen from the representations in Figure.3.

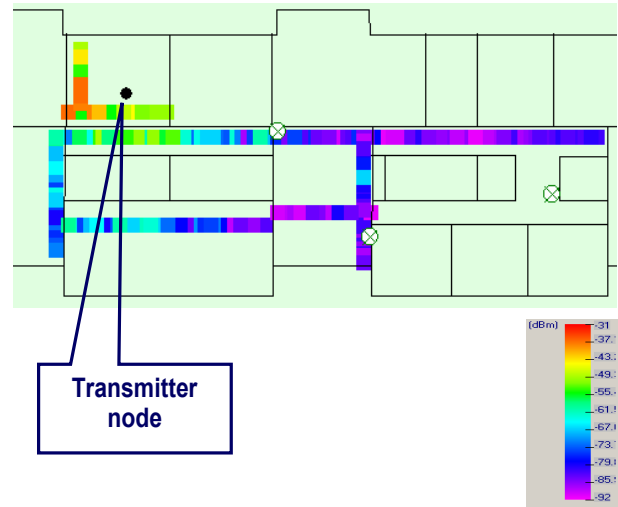

Figure 3. Measured RSSI level for the First Floor

The RF sweep was done for the offices, corridors and rooms in the ERI to determine the locations with high RF to enable proper pre-planning so that the sensors can be deployed in spots with high signal strength.

B. RF Spectral Survey of the ERI Building in Zigbee and ISM band

The radio frequency (RF) Monitoring and Measurement of the ERI was tasked to carry out a RF survey in both the Zigbee (2.44 GHz) and the industrial, scientific and medical (ISM 433MHz). The main objective of this survey is to confirm what the noise and interferences threat signals exist in these bands. As it is planned for the next stages of the project to deploy a determined scale Wireless Sensors network (WSN), it is crucial at this stage to have a clear idea about the RF activity of the Building for the 24 hours period. These surveys were carried out in 5 different rooms and areas that are candidates for the Wireless Sensors deployments and distributed in the three floors of the building.

The method used in this survey was represented by an integrated hardware/Software system as shown in Figure 4. In the Hardware side, a handheld spectrum analyzer (SA) of frequency range 100 kHz to 3.0 GHz was used. Suitable band antennas with SMA connectors were fixed at the top of

the device to receive the RF signals. The SA is connected to a laptop through RS232. A Labview program was developed to control the operation of the SA in two single sweep (for the 24 hours survey) and max hold (for detecting noise signals) modes.

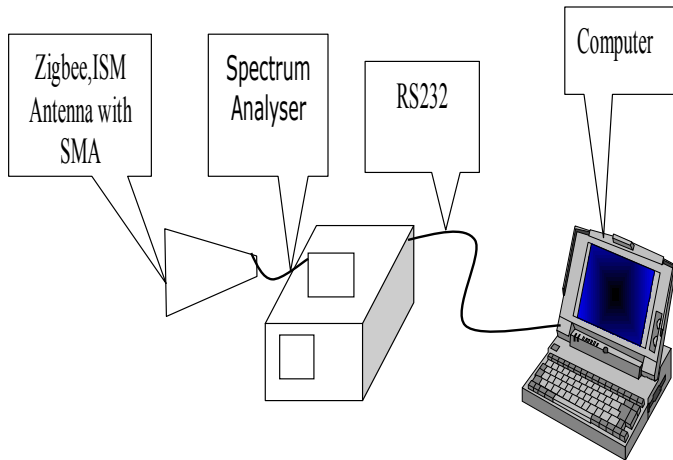

Figure 4. Survey Equipments Configuration

In this Section the results of the of the 24 hours survey for Immunology Lab room in the first floor inside the ERI building will be presented and explained as a useful example. The spectrum of the maximum noise peaks captured in both the Zigbee and ISM bands are shown in the two dimensional Figure 5. The spectral monitoring has expressed in terms of the in-bands received power mapped with the time and frequency as shown in Figure 6.

The lab is displaying a high noise activity in Zigbee band. The max detected peak was at 2.4484 GHz with -83.96 dBm power magnitude. This is can be due to the existed equipments and devices that may generate such Inband noise peaks. In the ISM, number of spaced peaks was captured forming relatively low activity with the highest peak at -78 dBm.

The 24 hours RF survey in Zigbee band displays larger activity at 2.445 GHz and other scattered components with similar power magnitudes at 2.45 GHz. In the ISM band, high RF activity was monitored in the frequency band 430-455 MHz with received RF power from -84 to -72 dBm. In general, the level of the detected noise/interference power is higher in ISM band based with less effect on the transmission band in compared with the Zigbee.

IV. SMALL SCALE WIRELESS NETWORK ARCHITECTURE

The architecture follows 3-tiers layout as shown in Figure 7. The sensor network IEEE802.15.4 based physical layer consists of 8 Motes which are divided into 3 small clusters covering 3 different rooms in the ERI:

- 1) Meeting room (Mote1,2)
- 2) Open office (Mote4,5,6)
- 3) Immunology lab (Mote7,8)

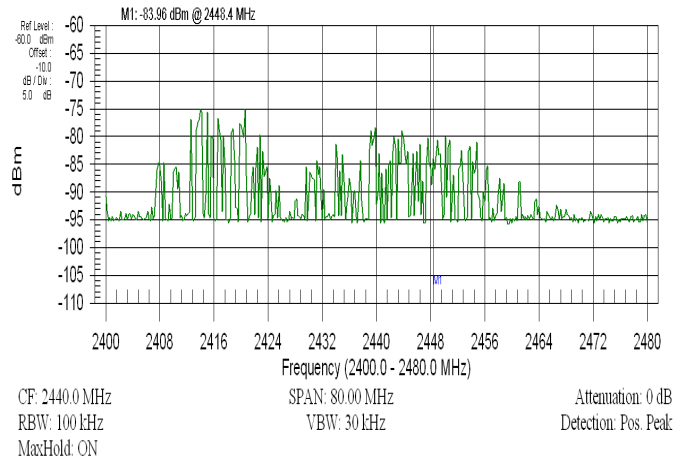

(a)

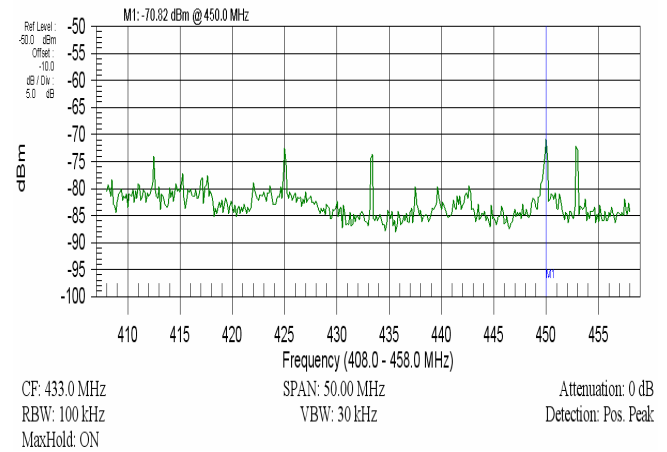

(b)

Figure 5. Noise Detection Using Max Hold Mode in the (a) Zigbee and (b) ISM Band for the Immunology Lab

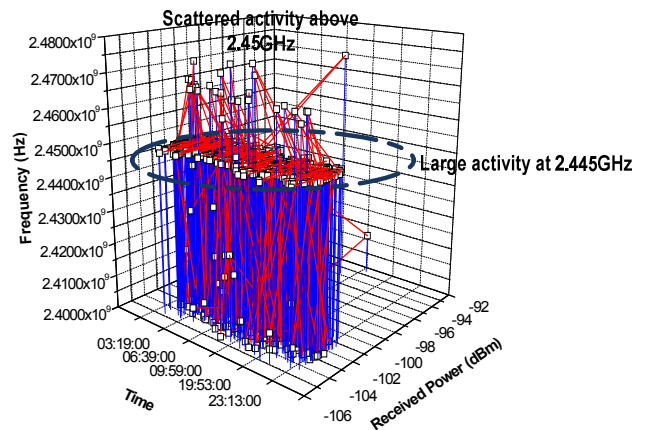

(a)

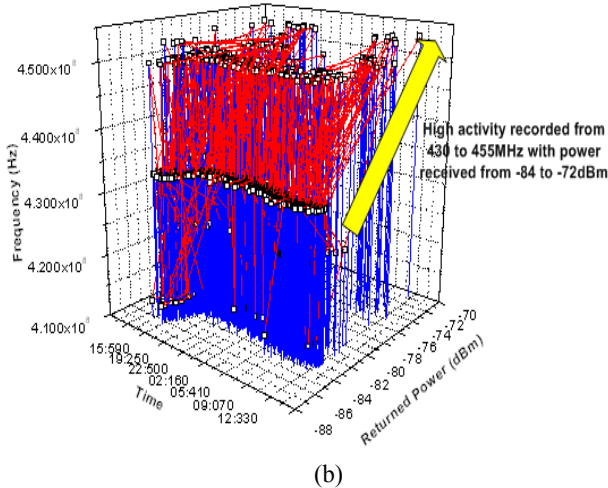

Figure 6. Surface Plots of the 24 Hours Spectral Monitoring in (a) Zigbee and (b) ISM Bands

The motes sample their sensors (temperature, humidity and light) every 3 min and send the readings over IEEE802.15.4 wireless link to the particular base mote. The base mote is connected over USB link to a gateway (GW) device.

The GW devices, providing a wireless backbone layer, are Soekris [7] embedded PCs with IEEE802.11 (WiFi) based wireless network interfaces. The GWs relay sensor data into a database.

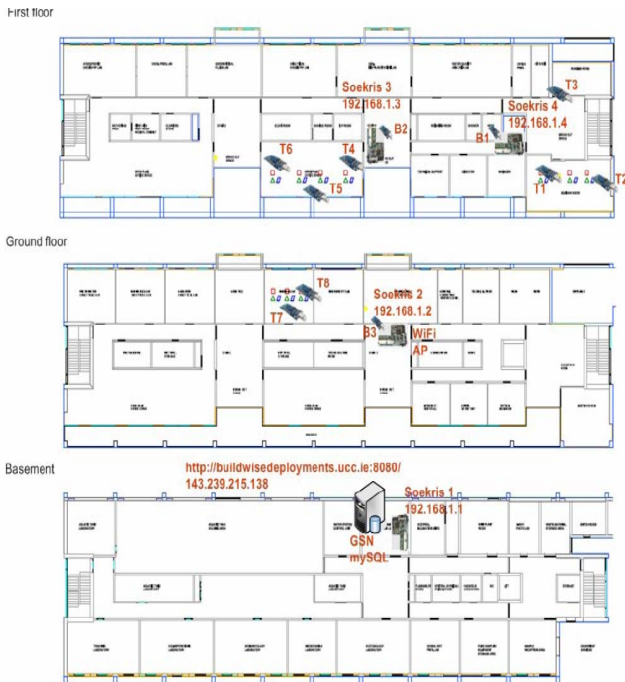

Figure 7. The established small scale WSN

The PC server layer is running a MySQL database for storing the data from the sensors. In order to get convenient access to the stored data over internet the GSN middleware [8] is used. The GSN is an open-source platform designed to be used with sensors networks and provides sufficient interface functionality to see sensor data in real-time as well as allows analyzing historical data. The system is currently on-line and accessible from the internet <http://143.239.215.138:8080/> as shown in Figure 8.

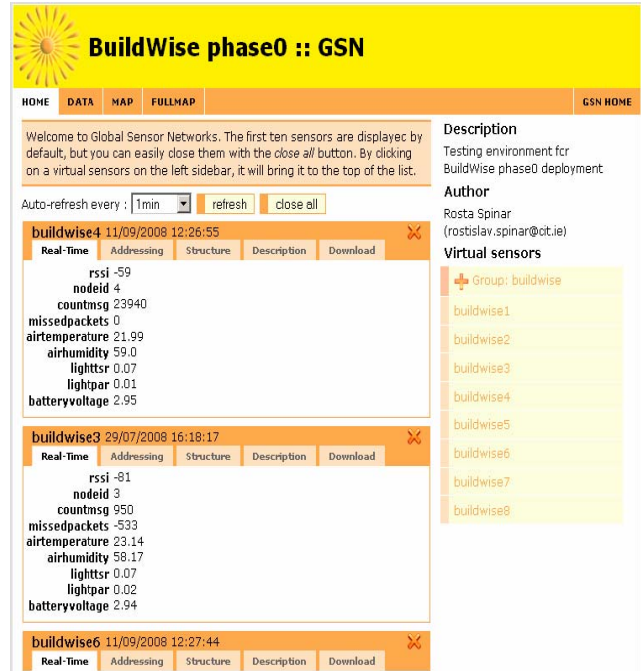

Figure 8. GSN web based WSN Interface

V. PERFORMANCE ANALYSIS

The GSN publishes received data to the web and the web interface can be queried to plot graphs of the received sensor data or parameters over a specified period of time. At a glance, data from each sensor can easily be analyzed.

Figures 9 & 10 below depict the graphical representation of some of the measured quantities as displayed by the data viewer of the GSN.

The ERI Building Management Systems has a wired sensor network in place and the sensed data is stored in the BMS' database (Oracle). The wired sensors are configured to send data every 15 minutes i.e. 4 readings in an hour. A comparison of the data sent by the wired sensors and the data from the wireless sensor network showed the wireless sensors have a greater sensitivity to change in the environment probably because the sensors are open, not covered (protected) and embedded into the walls of the building.

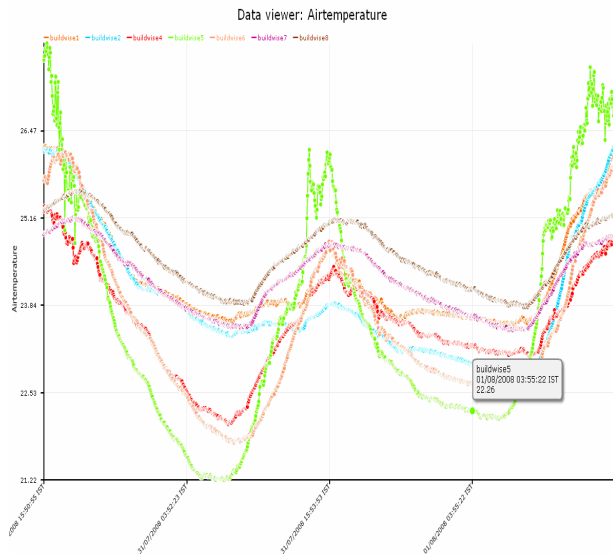

Figure 9. Full Graphical View of Temperature over 4 days



Figure 10. Full Graphical View of RSSI over 4 days

The graphs plotted from the sensed data, showing temperature readings over the same two day period for the wired sensors and the wireless sensors are represented in Figures 11 & 12.

The graphs depict the temperature readings between the 3rd and 4th of August for wired and wireless sensors located in the same spot (the wireless sensor was placed on top of the casing for the wired sensor) in the seminar room. Both sensors start with a value of about 24.3°C then falls below 24°C. The first day shows a noticeable difference in the temperature readings with the wireless sensor having a consistently higher value (a minimum difference of 1.4°C

and a maximum difference of 1.7°C) and the second day shows much closer readings with quite negligible differences in values. The wireless sensor also had consistently higher readings with a difference of about 0.3°C and a maximum difference of 1.5°C.

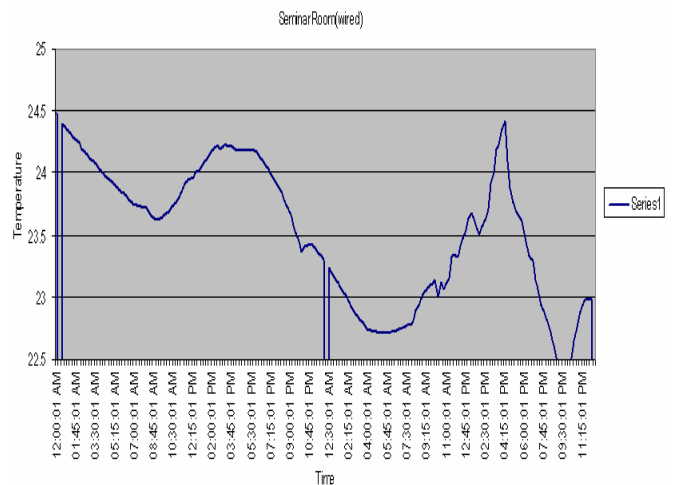

Figure 11. Seminar Room Temperature Statistics for Wired Sensors

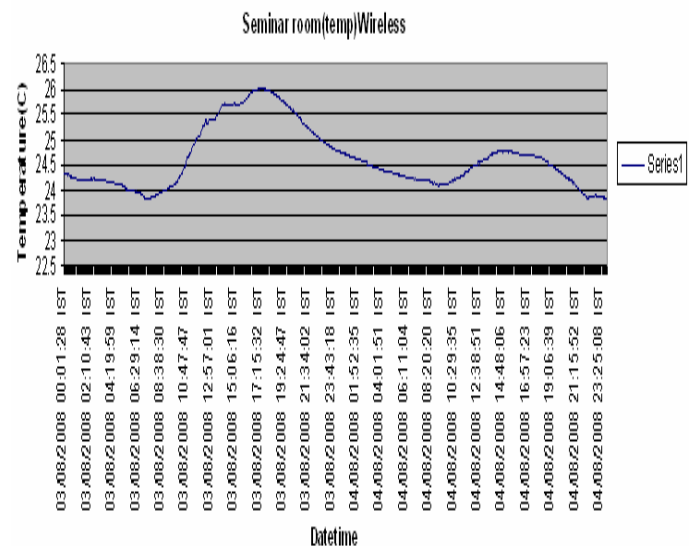

Figure 12. Seminar Room Temperature Statistics for Wireless Sensors

A pattern was discovered from the daily monitoring of the received data and from graphical representation of the received data: the RSSI fluctuates during the day when people (i.e. researchers) are present in the building and it is stable at night when people are all gone and no one is present in the building. However, the best signal quality is during the day when people are in the building and this is maintained (with variations) over office hours i.e. the work period, during the night the signal quality is much lower though stable with little or no variations. While the highest RSSI

values were recorded during the day, the fluctuation in values is a measure of instability that has to be accounted for. To ensure reliable transmission of the sensed data the collection protocol has to make allowance for the instability of the RSSI values.

VI. CONCLUSIONS

In this study, the RF noise and 24 hours spectral activity were measured for different places at the ERI building to get a clear image about the building RF noise and interferences that might disturb any future deployed wireless sensor network (WSN). The rooms are distributed as follows: one in the ground floor, one in the first floor, and three in the second floor.

Noise activity was noticed to be higher in Zigbee than ISM band especially in some places like the Immunology Lab as the presented results display. The higher interference and noise activity was generated by the different equipments and devices existed either inside the room or nearby.

The 24 hours RF surveys were graphed in 3D scattered plots to visualize the actually daily activity. Generally two behaviors were noticed, uniform at a certain frequency or/and scattered at different frequency regions.

All these measured effects were taken into consideration when small scale wireless network has been established and nodes deployed in order to guarantee the proper performance of these wireless nodes and also minimize the effects of the RF noise and interference.

The stability of the established small scale WSN has been analyzed in using the RSSI signal measurements and it was found that signal quality is much stronger during the day with more fluctuations than the night time due to the activity and movements of occupants.

REFERENCES

- [1] Gutierrez, J.A.: On the use of IEEE Std. 802.15.4 to enable wireless sensor networks in building automation. *International Journal of Wireless Information Networks*, 14(4), pp. 295-301, 2007.
- [2] Osterlind, F., Pramsten, E., Roberthson, D., Eriksson, J., Finne, N., Voigt, T.: Integrating building automation systems and wireless sensor networks. *IEEE Symposium on Emerging Technologies and Factory Automation*, pp. 1376-1379, 2007.
- [3] Kurata, N., Spencer Jr., B.F., Ruiz-Sandoval, M.: Risk monitoring of buildings with wireless sensor networks. *Structural Control and Health Monitoring*, 12 (3-4), pp. 315-327, 2005.
- [4] Kintner-Meyer, M.: Opportunities of wireless sensors and controls for building operation. *Energy Engineering: Journal of the Association of Energy Engineering*, 102 (5), pp. 27-48, 2005.
- [5] Kikiras, P.K., Drakoulis, D.K., Dres, D.A., Stamoulis, G.I. Wireless sensor networks: Business models and market issues. *6th Conference on Telecommunication Techno-Economics (CTTE)*, Finland, 2007.
- [6] S. J. Bellis, K. Delaney, B. O'Flynn, J. Barton, K. M. Razeeb, and C. O'Mathuna, "Development of field programmable modular wireless sensor network nodes for ambient systems," *Computer Communications*, vol. 28, pp. 1531-1544., 2005.
- [7] Soekris board, <http://www.soekris.com/>
- [8] GSN middleware, <http://gsn.sourceforge.net/>

ACKNOWLEDGEMENTS

The authors would like to acknowledge the support of Science Foundation Ireland (SFI) and the funding provided to the National Access Program (NAP) at the Tyndall National Institute, and Enterprise Ireland all of which have contributed to this work. Tyndall are part of the SFI funded CLARITY Centre for Sensor Web Technologies