



## USING AN INTEGRATED FUZZY INFERENCE SYSTEM AND ARTIFICIAL NEURAL NETWORK TO FORECAST DAILY DISCHARGE

*Chang-Shian Chen*

Department of Water Resources Engineering, Feng Chia University

*You-Da Jhong*

Graduate Institute of Civil and Hydraulic Engineering, Feng Chia University

*Chao-Hsien Yeh*

Department of Water Resources Engineering, Feng Chia University

---

### Abstract

Given the nonlinearity and uncertainty in the rainfall-runoff process, estimating or predicting hydrologic data often encounters tremendous difficulty. This study applied fuzzy theory to create a daily flow forecasting model. To improve the time-consuming definition process of membership function, which is usually concluded by a trial-and-error approach, this study designated the membership function by artificial neural network (ANN) with either a supervised or unsupervised learning procedure. The supervised learning was processed by the adaptive network based fuzzy inference system (ANFIS), while the unsupervised learning was created by fuzzy and self-organizing map (SOMFIS). The results indicate that the ANFIS method under increment flow data could provide more precise results for daily flow forecasting.

**Keywords:** Fuzzy Theory, Artificial Neural Networks, Discharge Forecasting, Self-Organizing Map

---

### 1. INTRODUCTION

Due to Taiwan's distinctive landform and uneven distribution of rainfall in time and space, there exist sharp differences in river discharge. Consequently, it is important to model and forecast hydrologic data. In particular, the forecasting of river daily discharge is crucial to the distribution of water resources. Characterized

---

*Correspondence Address:* Chang-Shian Chen, Department of Water Resources Engineering, Feng Chia University, 100 Wenhwa Rd., Seatwen, Taichung 40724, Taiwan. E-mail: cschen@fcu.edu.tw

by high uncertainty and complications, the hydrologic phenomenon is difficult to describe comprehensively with simple differential equations or statistical analysis. Studying the system response through the stimulus-response phenomenon, the recently developed artificial intelligence - fuzzy theory in particular - has produced some favorable research results in the modeling and prediction of hydrological data because of its ability to deal with highly nonlinear and uncertain systems. Xiong (2001) applied fuzzy set theory to estimate daily river flux, while Chang et al. (1998) employed fuzzy theory in predicting flood discharge.

However, determination of the membership function in fuzzy theory is a subjective definition based on personal understanding of the entire physical system such that the definition of membership function in turn affects the results of fuzzy inference. Consequently, recently artificial neural networks have been introduced for a more accurate membership function. Based on the learning process, artificial neural networks are categorized as supervised learning and unsupervised learning. Chang and Liang (1999) applied the adaptive network based fuzzy inference system (ANFIS) and employed the supervised Back-Propagation Network (BPN) to modify membership function. The study investigated the influence of the number of iterations on the estimation of discharge under a fixed number of membership functions. Chen et al. (2001) employed the unsupervised self-organizing mapping of neural networks coupled with fuzzy theory to establish a forecasting model for the flood discharge of Wu River.

To study the application of a neural network on the determination of membership function in fuzzy theory, this study first employed ANFIS to forecast daily discharge with different numbers of membership functions. The combination of SOM and fuzzy theory was then applied to estimate daily discharge with different shapes of membership. Finally, comparisons of the results from the two methods were made to find their advantages and applicability.

## **2. METHODOLOGY**

In this study, the Back-Propagation Neural (BPN) Network and self-organizing mapping (SOM), respectively, were combined with fuzzy theory to conduct discharge forecast. Detailed descriptions of the models are illustrated in following sections.

### **2.1 Fuzzy theory**

First proposed by Zadeh (1965), fuzzy theory operates through the following steps.

- (1) Fuzzification: The first step is to determine the definition domain of each variable based on the ranges of input and output variables in actual conditions.
- (2) Fuzzy rules determination and fuzzy inference: Based on the experience and knowledge of experts, the language rules of determination are transferred into the executable fuzzy syntax for inference. Fuzzy inference rules are usually written using the following syntax:

$$\begin{aligned} & \left\{ \leftarrow \text{fuzzy proposition} \rightarrow \right\} \rightarrow \left\{ \leftarrow \text{fuzzy inference} \rightarrow \right\} \\ R^i : & \text{if } R_{t-2} \text{ is } \mu_{\Delta R_{t-2}} \text{ and } \Delta E_{t-1} \text{ is } \mu_{\Delta E_{t-1}} \text{ then } \Delta E_t \text{ is } \mu_{\Delta E_t} \quad i = 1, 2, \dots, n \end{aligned}$$

where  $R^i$  is the  $i$ th fuzzy rule;  $i$  is the number of fuzzy rule;  $R_{t-2}$  and  $\Delta E_{t-1}$  are the input variables of fuzzy proposition;  $\Delta E_t$  is the output variable of fuzzy inference; and  $\mu_{R_{t-2}}, \mu_{\Delta E_{t-1}}, \mu_{\Delta E_t}$  are the degrees of membership of fuzzy set.

- (3) Defuzzification: The fuzzy inference outputs are finally transformed back into crisp values. To do so, this study implemented the center-of-gravity method, which is simple and suitable for programming and execution. The calculation equation is written as follows:

$$\Delta E_t = \frac{\sum_{i=1}^n (\mu_i \times X_i)}{\sum_{i=1}^n (\mu_i)} \quad i = 1, 2, 3, \dots, n$$

where  $\Delta E_t$  is the output of fuzzy logic;  $\mu_i$  is the degree of applicability of the  $i_{th}$  proposition of fuzzy rule; and  $X_i$  is the value corresponding to the center of the membership function for  $i_{th}$  proposition of fuzzy rule.

## 2.2 Adaptive network based fuzzy inference system (ANFIS)

Developed by Jang J.-s. R. of Tsing Hua University in Taiwan, the adaptive network based fuzzy inference system (ANFIS) is a fuzzy inference system executed in an adaptive network. It can establish an input-output relation through the back-propagation process with an artificial intelligence style (if-then rules of fuzzy inference). In terms of modeling, ANFIS can easily establish non-linear functions, and it can forecast time sequence of no qualitative relations. Furthermore, ANFIS can identify the non-linear constitutive factors in a control system and produce favorable results in the fields described above (Jang, 1993; Nayak, 2004).

A fuzzy inference system has, for example, two inputs, one output, five layers of framework (shown in Fig. 1), and two learning stages. In the first layer (input

layer), the input variables are mapped into fuzzy sets to estimate their degrees of membership with the designated membership functions. In the second layer (rule layer), the prerequisite conditions of fuzzy logic rules are matched with input variables in order to obtain the weights, i.e., firing strength, of the rules which are the multiplication results of all inputs using the T-norm multiplication operation. In the normalization layer (the third layer), the relative ratios of weights of all rules are calculated for the nodes in this layer. Then, the relative weights are multiplied by the functions of factor sets in the conclusion inference layer (the fourth layer). In the last and fifth layer (output layer), all the information from the previous layer is aggregated to calculate the output variable, just as in the defuzzification procedure. From the calculation of the five layers, it is clear that the function of ANFIS is similar to that of Sugeno model (Nayak et al., 2004).

FIGURE 1

The framework of adaptive network based fuzzy inference system (ANFIS).

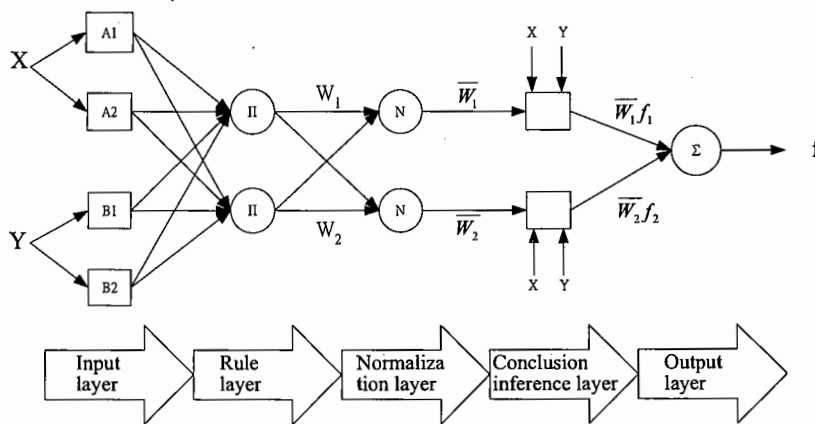

### 2.3 Self-Organizing Mapping (SOM) Network

Self-Organizing Mapping Network is a model of unsupervised learning processes, proposed by Kohonen (1997), and it is still a paradigm of this kind. Rooted in the characteristics of brain structure, the basic principles of SOM imitate these characteristics, i.e. brain cells with similar function will aggregate, so that SOM can obtain training examples from the question domain and learn clustering rules from these learning examples. When the learning process of the network is finished, the output process units interact with each other so that, in turn, neighboring units will have similar functions, i.e. similar weights (Chen et al., 2004).

The learning framework of SOM network, shown in Fig. 2, includes two layers: the input variables of the network - i.e. the input vectors of training model - are shown in the input layer; in the output layer, the clustering of training model will be output from the network. The latter layer is similar to the hidden layer of the BPN although it does not have the concepts of network topology and neighborhood.

FIGURE 2

The learning framework of Self-Organizing Map (SOM) Network.

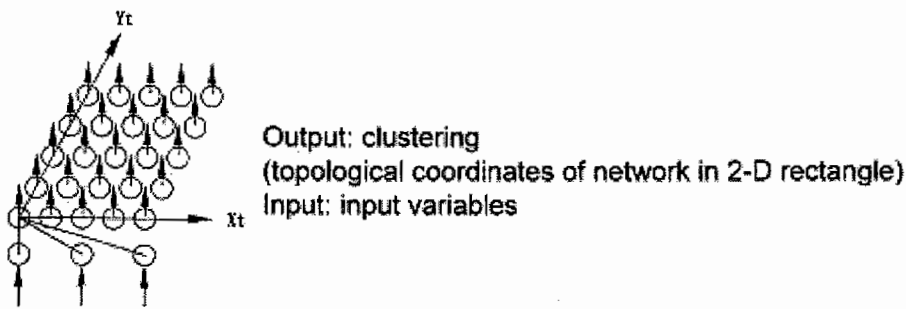

### 3. DEVELOPMENT AND APPLICATION OF MODEL

#### 3.1 Introduction of study field

In this study, the Wu River basin was selected as study field for forecasting of flood discharge in watershed. Discharge data from discharge stations upstream (Dali River drainage: CeiNan Bridge Station; Maoluo River drainage: NaKung Bridge Station; Wu River main discharge in upstream: ChenFung Bridge Station) were used to forecast the daily discharge in the downstream of Wu River (Da-Du Bridge Station). The locations of the stations are shown in Fig. 3.

#### 3.2 Data processing

Daily discharge data from four stations (CeiNan Bridge Station, NaKung Bridge Station, ChenFung Bridge Station, and DaDu Bridge Station) between 1990 and 1999 were collected as learning data, while the daily discharge data from 2000 to 2001 were taken as testing data

FIGURE 3

The location of hydrological stations in the Wu Rive basin.

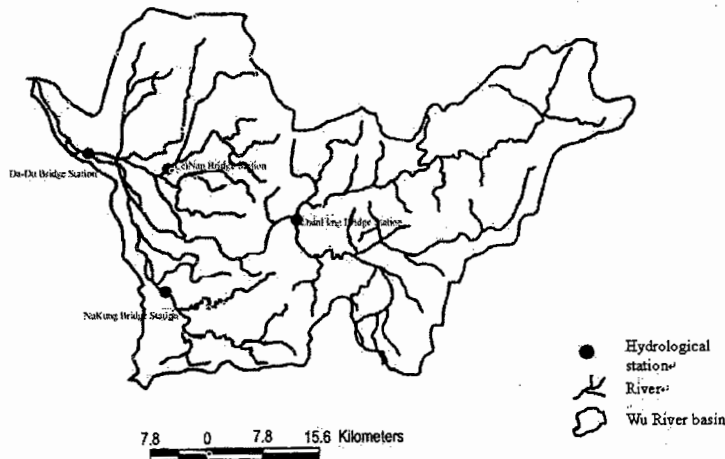

### 3.3 Development of the model

#### 3.3.1 Input data

Instead of using the original discharge in previous studies, the differential values of discharge data at each station were transformed by linear transfer function (LTF) and then used to determine the most appropriate impact order on the discharge data of the outlet station. The results indicate that the daily discharge of the first order in CeiNan Bridge Station and NaKung Bridge Station, and that of the first three orders in ChenFung Bridge Station show significant influence on the discharge at DaDu Bridge Station.

#### 3.3.2 Framework of ANFIS model

- (1) The operations in this study were conducted by the toolbox of ANFIS in Matlab.
- (2) The number of input membership functions with the shape of Gauss function was designated. The ordered data based on their input values were also divided into groups so that each group of data had one membership function.
- (3) The shape of MF was modified by back propagation approach.
- (4) Stop criterion for training iterations was set to 2000 based on the observation that the output and actual discharge data converged in a

- stable manner with acceptable error when the number of learning iterations reached 2,000.
- (5) After setting the parameters, the increment discharge data were utilized for training.
  - (6) Fuzzy inference was then applied to the learning data and the testing data were used to forecast discharge in order to create a model.
  - (7) In the study, suitability analysis on the number of Gauss functions in ANFIS was conducted to obtain the modules that performed best. With possible values from 3 to 6 for ChenFung Bridge, NaKung Bridge Station, and CeiNan Bridge Station, a total of 64 models were compared.

The construction procedure is shown as Fig. 4.

FIGURE 4

The construction procedure for discharge estimation in ANFIS

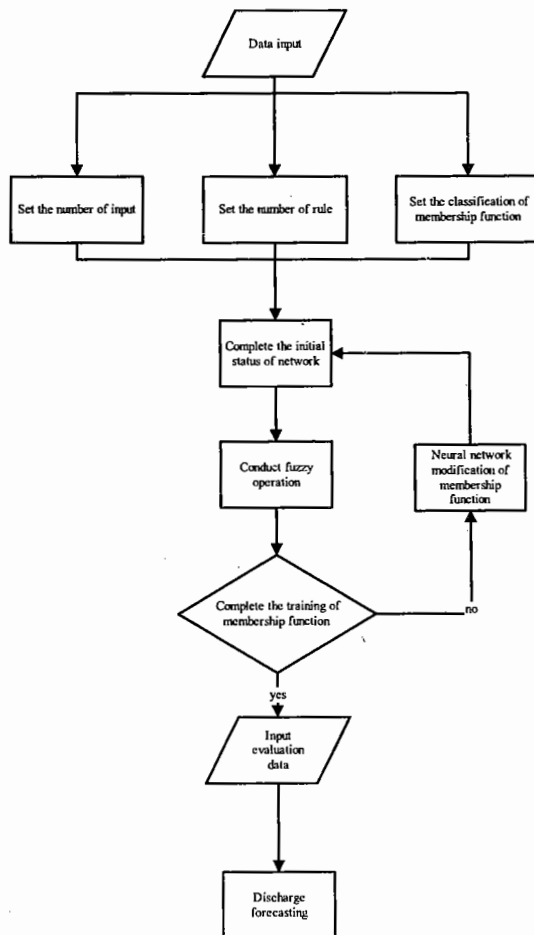

### 3.3.3 Framework of SOMFIS model

- (1) The classification operations of the three upstream stations were conducted using the SOM toolbox in Matlab.
- (2) SOM parameters, i.e. 0.9, 0.02, and 5 were designated as learning speeds in the sequencing stage, tuning stage, and neighborhood in the tuning stage, respectively. A rectangular neighborhood was set as the initial topological permutation and Euclidean distance was used to calculate topological distance.
- (3) To minimize the number of the empty points in the topological network, a network of  $12 \times 12$  was identified by some pre-tests. If any testing data fell into an empty point, the data were replaced by a topological network point with the shortest Euclidean distance.
- (4) According to observation, when the number of learning iterations reached 2,500, the topological network had extended into a stable shape without significant change. Therefore, the stop criterion for training iterations was set to 2500.
- (5) After setting the parameters, the original and increment discharge data were utilized for training.
- (6) After SOM classification, it was found that one or more discharge data could fall into one topological point. The mean value and standard deviation of these discharge data were calculated such that the mean value was set as the center of the Gauss function and the standard deviation was the standard error of the Gauss function. The Gauss function was then designated as the MF function of the fuzzy inference at that topological point.
- (7) With the classification results from the previous procedure, the forecast outflow discharge was found by fuzzy inference. The model was named Gauss.
- (8) To increase the precision of the model under conditions of higher discharges, the membership functions numbered 100 to 144 of the SOM topological points were set as S functions, named as S-100 to S-144 (45 in total), after sorting all the topological points. Fuzzy inference was subsequently conducted.

The construction procedure is shown as Fig. 5.

Since increment can be positive or negative, output with negative values could result from the increment learning and testing stages in ANFIS and SOMFIS models. Because it violates the physical interpretation, the negative discharge was replaced by base flow discharge.



FIGURE 5

The construction procedure for discharge estimation in SOMFIS.

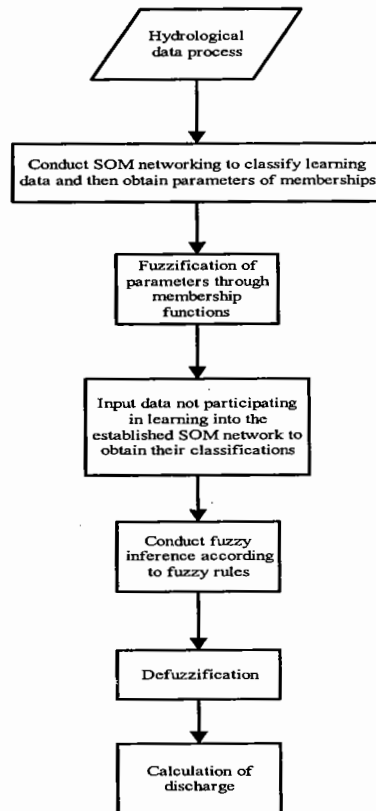

### 3.4 Assessment standard

There are seven indexes for the assessment of the models presented in this study.

- (1) Correlation of efficiency (COR): If COR approaches 1, the discrepancy between the model's result and actual data is small, indicating higher accuracy. COR is calculated by following equation:

$$COR = \frac{\sum (Q_{obs} - \bar{Q}_{obs})(Q_{est} - \bar{Q}_{est})}{\sqrt{\sum (Q_{obs} - \bar{Q}_{obs})^2 \sum (Q_{est} - \bar{Q}_{est})^2}}$$

where,  $Q_{est}$  is the estimated discharge from the model,  $\bar{Q}_{est}$  is the mean value of the estimates,  $Q_{obs}$  is the observed discharge, and  $\bar{Q}_{obs}$  is the average of observed discharge.

- (2) Error of peak Discharge (EQp): If  $EQ_p > 0$ , the estimated discharge peak is larger than the observed one; if  $EQ_p < 0$ , the estimated discharge peak is smaller. EQp is calculated by following equation:

$$EQ_p = \frac{Q_{pest} - Q_{pobs}}{Q_{pobs}}$$

where,  $Q_{pest}$  and  $Q_{pobs}$  are the model-estimated and observed peak discharges, respectively.

- (3) Error of time to peak (ETp) is calculated by the following equation and smaller  $|ETP|$  indicates a more accurate time to peak estimated by the model.

$$ET_p = T_{pest} - T_{pobs}$$

where,  $T_{pest}$  and  $T_{pobs}$  are the model-estimated and observed time to peak flow, respectively.

- (4) Mean Absolute Error (MAE) indicates the discrepancy between forecasted and actual values, it is calculated by the following equation:

$$MAE = \frac{1}{M} \sum_{l=1}^M |Z_{t+l} - \hat{Z}_t(l)|$$

where, M is the number of forecasted values,  $Z_{t+l}$  is the lth observed value, and  $\hat{Z}_t(l)$  is the lth estimated value.

- (5) Mean Absolute Percentage Error (MAPE) is another index for the discrepancy between forecasted and actual values, and the following equation can be used to calculate MAPE:

$$MAPE = \left( \frac{1}{M} \sum_{l=1}^M \left| \frac{Z_{t+l} - \hat{Z}_t(l)}{Z_{t+l}} \right| \right) \times 100\%$$

where, M is the number of forecasted values,  $Z_{t+l}$  is the lth observed value, and  $\hat{Z}_t(l)$  is the lth estimated value.

- (6) Coefficient of Persistence (PC) in the k stage, i.e.  $PC(k)$ , is calculated by the following equation.

$$PC(k) = 1 - \frac{\sum_{i=m+k}^n (Q_i - \hat{Q}_i)^2}{\sum_{i=m+k}^n (Q_i - Q_{i/p(k)})^2}$$

If  $Q_{i/p}(k)$  equals  $Q_{i-k}$ , the forecasted discharge of the  $i$ th stage can be obtained from that of  $i-k$ th stage under the assumption of persistence. If  $Q_{i/p}(k)$  is zero, the forecasted discharge of the  $i$ th stage equals that of  $i-k$ th stage. If  $Q_{i/p}(k)$  approaches 1, the forecasted value from the model is more accurate than that obtained from the assumption of persistence.

- (7) Coefficient of Extrapolation (EC) at the  $k$ th stage, i.e.  $EC(k)$ , is calculated using the following equation from  $Q_{i-k}$  and  $Q_{i-k-1}$ , i.e. the forecasted values of the  $i$ th stage and the  $i-k$ th stage.

$$EC(k) = 1 - \frac{\sum_{i=m+k}^n (Q_i - \hat{Q}_i)^2}{\sum_{i=m+k}^n (Q_i - Q_{i/e}(k))^2}$$

If  $EC(k)$  approaches 1, the forecasting value from the model is more accurate than that from the extrapolation.

## 4. RESULTS AND DISCUSSION

### 4.1 Adaptive network based fuzzy inference system

For the increment discharges in this study, the best ANFIS model with the best COR index was the 656 learning model, i.e. the numbers of Gauss functions for ChenFung Bridge, NaKung Bridge Station, and CeiNan Bridge Station are 6, 5, and 6, respectively. The observations versus estimates in the learning and evaluation models of the 656 model are plotted as Fig. 6 to Fig. 9, while the assessment criteria of the provisional models are listed in Table 1.

FIGURE 6

Comparison between the observations and the estimated results of ANFIS in the 656 learning model

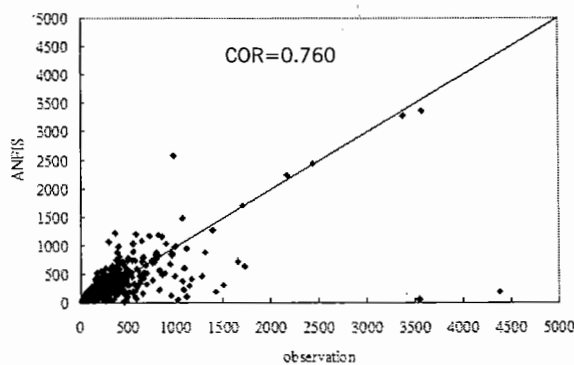

FIGURE 7

Comparison between the observations and the estimated results of ANFIS in the 656 evaluation model

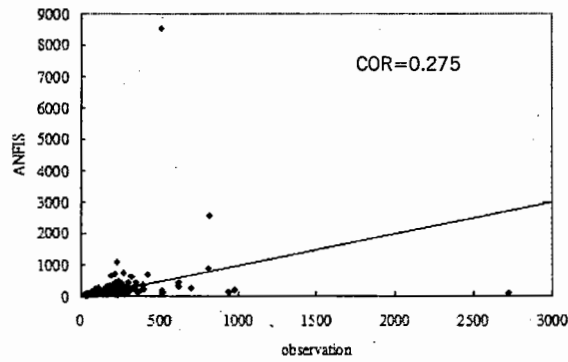

FIGURE 8

The hydrograph of ANFIS in the learning model

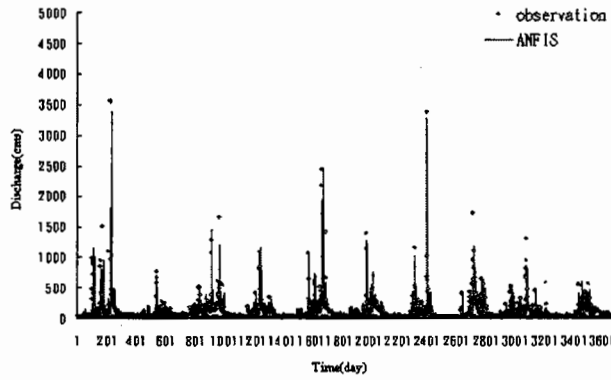

FIGURE 9

The hydrograph of ANFIS in the evaluation model

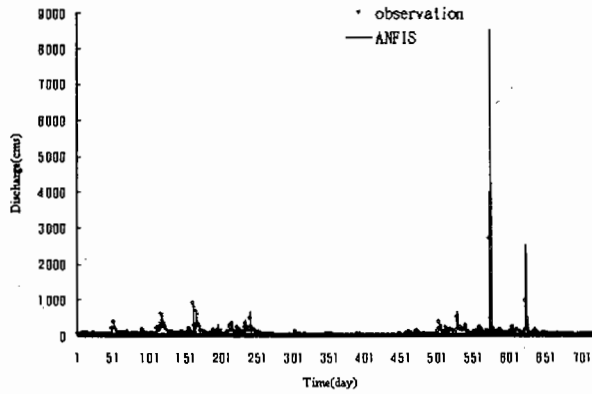

TABLE 1

The assessment criteria for learning and forecasting assessments in ANFIS

Model	Learning (1990~1999)							Model	Forecast assessment (2000~2001)						
	COR	EQP	ETP	MAE	MAPE	EC	PC		COR	EQP	ETP	MAE	MAPE	EC	PC
333	0.71	-0.184	-1449	31.084	16.791	0.661	0.198	333	0.443	-0.067	1	32.15	16.569	0.644	0.029
444	0.715	-0.263	-1449	31.2	17.388	0.673	0.226	444	0.301	1.218	1	36.772	17.748	0.032	-1.639
555	0.737	-0.203	-1448	30.344	16.704	0.689	0.263	555	0.227	3.223	1	44.898	19.15	-2.077	-7.386
656	0.76	-0.23	-1449	30.106	18.697	0.721	0.339	656	0.275	2.134	1	44.062	20.968	-0.835	-4.001
666	0.719	-0.216	-1449	30.602	17.326	0.678	0.236	666	0.267	1.768	1	38.698	18.271	-0.4	-2.815

In the learning stage for ANFIS with increment discharge, the 656 model performed the best with the COR between 0.760 and 0.708, the 653 model outperformed the other models with the MAE between 32.076 and 28.620, and the 656 model performed the best with the EC values of 0.661 to 0.721 and the PC values between 0.339 and 0.198. Consequently, the 656 model was selected as the representative model. However, its simulation results in the evaluation stage were not favorable, as shown in Fig. 7; the 333 model had better results, as indicated in Table 1.

4.2 Fuzzy and Self-Organizing Map (SOMFIS)

The estimated results by SOMFIS in the learning and evaluation models are plotted against observations shown in Fig. 10 to Fig. 13. The assessment criteria of the models are listed in Table 2.

FIGURE 10

Comparison between the observations and the estimated results of SOMFIS in the learning model

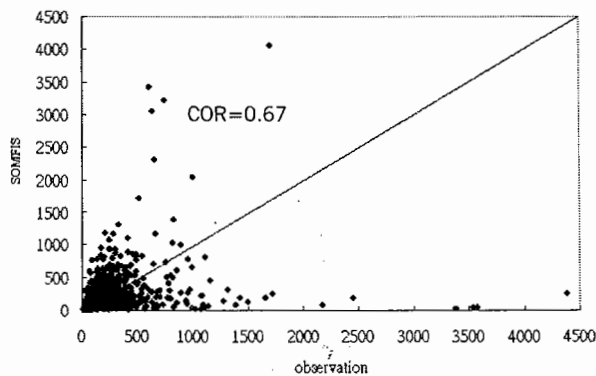

FIGURE 11

Comparison between the observations and the estimated results of SOMFIS in the evaluation model

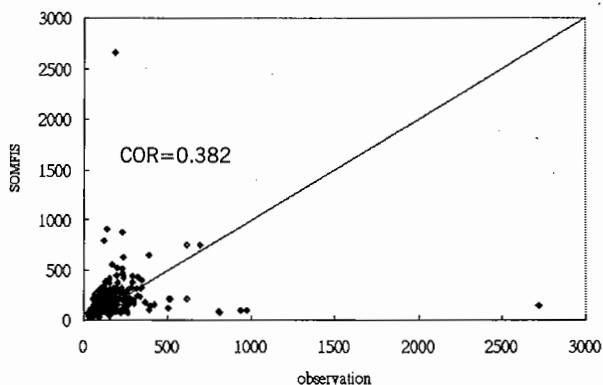

FIGURE 12

The hydrograph of SOMFIS in the learning model.

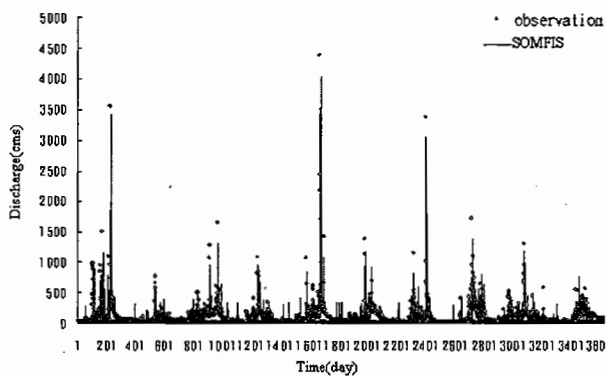

FIGURE 13

The hydrograph of SOMFIS in the evaluation model.

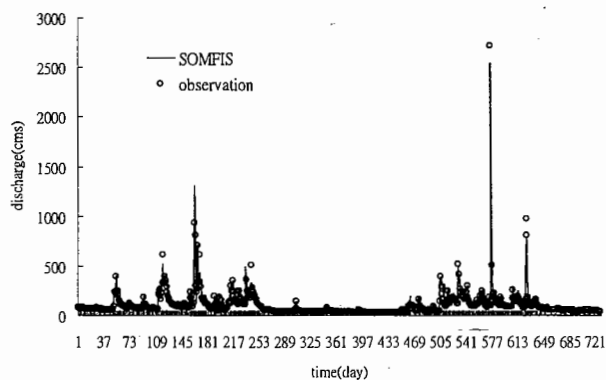

TABLE 2

The assessment criteria for learning and forecast assessment in SOMFIS

Model	Learning (1990-1999)							Model	Forecast assessment (2000-2001)						
	COR	EQP	ETP	MAE	MAPE	EC	PC		COR	EQP	ETP	MAE	MAPE	EC	PC
gauss	0.67	-0.076	1	36.894	22.544	0.602	0.056	gauss	0.382	-0.023	1	46.145	38.217	0.626	-0.019
S-100	0.662	-0.076	1	40.352	27.664	0.577	-0.003	S-100	0.441	0.087	1	47.388	36.377	0.571	-0.17
S-110	0.668	-0.076	1	38.952	24.588	0.589	0.026	S-110	0.434	-0.023	1	45.588	37.109	0.624	-0.025
S-120	0.668	-0.076	1	38.887	24.448	0.589	0.027	S-120	0.423	-0.023	1	45.754	37.369	0.624	-0.026
S-130	0.668	-0.076	1	38.544	24.224	0.591	0.03	S-130	0.409	-0.023	1	45.884	37.606	0.624	-0.026
S-140	0.669	-0.076	1	37.109	22.932	0.601	0.055	S-140	0.392	-0.023	1	45.887	37.842	0.626	-0.019
S-141	0.669	-0.076	1	37.093	22.879	0.601	0.055	S-141	0.39	-0.023	1	45.917	37.868	0.626	-0.019
S-142	0.67	-0.076	1	36.996	22.756	0.602	0.056	S-142	0.388	-0.023	1	45.985	37.979	0.626	-0.018
S-143	0.67	-0.076	1	36.995	22.754	0.602	0.056	S-143	0.386	-0.023	1	45.976	37.97	0.626	-0.018
S-144	0.67	-0.076	1	36.933	22.633	0.602	0.056	S-144	0.384	-0.023	1	45.976	37.97	0.626	-0.018

When learning classification of fuzzy inference in SOMFIS, the Gauss model performed the best with COR, MAE, EC, and PC values of 0.67~0.662, 40.35~36.89, 577~0.602, and -0.003~0.056, respectively. However, the simulation results of the Gauss model were not favorable, as shown in Fig. 11. The S-100 model had better evaluation results than the others, as indicated in Table 2.

4.3 Discussions

Since ANFIS represents each input variable with several membership functions, ANFIS is able to grasp variations in hydrological events on the basis of other combinations of hydrological events. By contrast, SOMFIS is an overall classification method for learning events where fewer membership functions can reflect the variances of the variables, and this caused larger inference errors with off-peak results.

In this study, there were more low discharge data than high discharge data. Since SOM is an unsupervised learning procedure, the distribution of topological classification for low discharge data was denser and more sensitive, which easily led to errors in inference results. On the other hand, fewer high discharge data resulted in insufficient classifications and larger errors in forecasting.

The results using ANFIS or SOMFIS showed that successive large discharges often resulted in under-forecasting since most learning data indicated that a smaller discharge would follow a larger one.

In Taiwan, rainfall usually affects the river discharge in a few hours only. Consequently, the daily discharges of a few days beforehand are generally ordinary in value regardless of whether the discharge forecasting is high or low. Therefore, the SOMFIS classification of daily discharge may produce an output discharge of high or low value depending on the rainfall of that rainy day, despite the same input discharges of previous days. The consequence of this averaging effect leads

to slightly higher forecasting on small discharges and slightly lower forecasting on large discharges.

With intense and abrupt rainfall in Taiwan, sudden increases in discharge cannot be reflected in the previous daily discharges at the upstream stations. The model, therefore, failed to forecast a sudden increase in discharge due to a typhoon or storm, and this resulted in a one order delay in the ETP index.

A sudden increase of discharge due to a typhoon flood generates the points showing a large deviation under the diagonals in Figs. 6, 7, 10, and 11 for the one order delay in the model. The model received the input of a large discharge the following day when the discharge had in fact decreased, and this led to the occurrence of points with large deviation over the diagonals in the figures.

## 5. CONCLUSIONS AND SUGGESTIONS

Even with annual precipitation over 2,500 mm, most of the runoff from the rainfall in Taiwan will drain into the oceans within hours if no facility of flow control or storage is applied along the river system. Over 80% of the annual precipitation is concentrated in the rainy season, i.e., from July to October, and it causes a water resources management problem of whether to retain or release the discharge during and after the storm events. The forecasting of the daily discharge based on rainfall records will provide essential information for better decision-making on the balancing of water resources utilization and disaster prevention.

In this study, ANFIS using different number membership functions and SOMFIS using increment discharge data were compared, and the results indicated that the ANFIS method provides more accurate results on daily discharge forecasting. Since the runoff from rainfall in Taiwan usually lasts a few hours, the input data do not correlate well with the outputs of the two models employed in the study. In large watersheds, the higher discharge can last for a few days, and thus the model is expected to perform better and the one order delay can be improved.

Because SOMFIS can only take one classification and one Gauss function for fuzzy inference, errors often occur during off-peak conditions. Therefore, the original classification along with the classifications within the vicinity of the Euclidean distance can be included into membership functions to enhance the accuracy of off-peak forecasting. Since there were only a few topological classifications in SOMFIS, a large discharge tended to be under-estimated. If the number of topological classifications can be increased, flood peak forecasting can be improved.

The sharp increase of typhoon flooding results in poor forecasting of daily discharge. To improve the accuracy of forecasting, the authors suggest that typhoon flood data over the years should be separated so that another forecasting model can be developed and used for forecasting during typhoon events.



## References

- Chang-Shian Chen, K.-C. T., Yin-Long Huang (2001). Neural-Fuzzy Network Algorithm Apply to Forecast Catchment's Outflow. *Journal of The Chinese Institute of Civil and Hydraulic Engineering*, 13(2), 395-403.
- Chang-Shian Chen, Q.-J. W., You-Da Jhong (2004). Use Recurrent Neural Network at Daily Stream Flow Forecasting Application. *Journal of Chinese Soil and Water Conservation*, 35(3), 187-195.
- Fi-John Chang, J.-M. L. (1999). A Study of Artificial Neural-Fuzzy inference Model for Hydrosystems. *Journal of Taiwan Water Conservancy*, 47(2), 1-12.
- Jang, J.-s. R. (1993). ANFIS Adaptive-Network-Based Fuzzy Inference System. *IEEE Trans. Systems, Man, and Cybernetics*, 23(3), 665-685.
- Kohonen, T. (1997). *Self-Organizing Map*. New York: Springer-Verlag.
- Liang-Cheng Chang, C.-C. Y., Chang-Shian Chen (1998). *Application of Fuzzy Control Algorithm on Flood Forecasting*. Paper presented at the The 9th Hydraulic Engineering Conference.
- Lihua Xiong, A. Y. S., Kieran M. O'Connor (2001). A non-linear combination of the forecasts of rainfall-runoff models by the first-order Takagi-Sugeno fuzzy system. *Journal of Hydrology*, 245, 196-217.
- P.C. Nayak, K. P. S., D.M. Rangan, K.S. Ramasastry (2004). A neuro-fuzzy computing technique for modeling hydrological time series. *Journal of Hydrology*, 52-66.
- Zadeh, L. A. (1965). Fuzzy sets. *Information And Control*, 8, 338-353.

---

## Resumo

A não linearidade e a incerteza dos diversos processos de previsão dos dados hidrológicos têm criado enormes dificuldades. Este estudo aplica a teoria *fuzzy* para criar um modelo de previsão de fluxo diário. Para o processo de definição da função de pertinência, o qual é geralmente recorre à abordagem da tentativa e erro, o presente estudo utiliza Redes Neurais com processo de aprendizagem supervisionada e não supervisionada. O processo de aprendizagem foi processada por uma rede adaptativa baseada num sistema de inferência *fuzzy*, enquanto a aprendizagem não supervisionada foi criada por *fuzzy and self-organizing maps*. Os resultados indicam que o sistema de inferência *fuzzy* com incremento de fluxos de dados dá resultados mais precisos para a previsão do fluxo diário.

**Palavras chave:** Teoria *fuzzy*; Redes Neurais; *Discharge Forecasting*; *Self-Organizing Maps*.

---

