



Kent Academic Repository

Della Corte, V., Ferretti, S., Piccirillo, A.M., Zakharov, V., Di Paolo, F., Rotundi, A., Ammannito, E., Amoroso, M., Bertini, I., Di Donato, P. and others (2023) *DISC - the dust impact sensor and counter on-board Comet Interceptor: Characterization of the dust coma of a dynamically new comet. Advances in Space Research, 71 (8). pp. 3457-3467. ISSN 0273-1177.*

Downloaded from

<https://kar.kent.ac.uk/106688/> The University of Kent's Academic Repository KAR

The version of record is available from

<https://doi.org/doi:10.1016/j.asr.2023.01.049>

This document version

Publisher pdf

DOI for this version

Licence for this version

CC BY (Attribution)

Additional information

Versions of research works

Versions of Record

If this version is the version of record, it is the same as the published version available on the publisher's web site. Cite as the published version.

Author Accepted Manuscripts

If this document is identified as the Author Accepted Manuscript it is the version after peer review but before type setting, copy editing or publisher branding. Cite as Surname, Initial. (Year) 'Title of article'. To be published in **Title of Journal**, Volume and issue numbers [peer-reviewed accepted version]. Available at: DOI or URL (Accessed: date).

Enquiries

If you have questions about this document contact ResearchSupport@kent.ac.uk. Please include the URL of the record in KAR. If you believe that your, or a third party's rights have been compromised through this document please see our [Take Down policy](https://www.kent.ac.uk/guides/kar-the-kent-academic-repository#policies) (available from <https://www.kent.ac.uk/guides/kar-the-kent-academic-repository#policies>).



DISC - the dust impact sensor and counter on-board Comet Interceptor: Characterization of the dust coma of a dynamically new comet

V. Della Corte^{a,*}, S. Ferretti^{a,b}, A.M. Piccirillo^{a,k}, V. Zakharov^{a,c}, F. Di Paolo^{a,b},
A. Rotundi^{a,b}, E. Ammannito^d, M. Amoroso^e, I. Bertini^{a,b}, P. Di Donato^b, G. Ferraioli^b,
S. Fiscale^k, M. Fulle^f, L. Inno^b, A. Longobardo^a, E. Mazzotta-Epifani^g,
M.T. Muscari Tomajoli^k, G. Sindoni^d, L. Tonietti^k, H. Rothkaehl^h, P.J. Wozniakiewiczⁱ,
M.J. Burchellⁱ, L.A. Alesbrookⁱ, M.E. Sylvest^j, M.R. Patel^j

^a *Istituto di Astrofisica e Planetologia Spaziali, Istituto Nazionale di Astrofisica, Via fosso del cavaliere, 100, 00133 Rome, Italy*

^b *Dipartimento di Scienze e Tecnologie, Università degli Studi di Napoli “Parthenope”, CDN, IC4, 80143 Naples, Italy*

^c *LESIA, Observatoire de Paris, Université PSL, Sorbonne Université, Université de Paris, 5 place Jules Janssen, 92195 Meudon, France*

^d *Italian Space Agency, via del Politecnico snc, 00133 Roma, Italy*

^e *Italian Space Agency, Centro di Geodesia Spaziale ‘Giuseppe Colombo’, 75100 Matera, MT, Italy*

^f *Osservatorio Astronomico di Trieste, Istituto Nazionale di Astrofisica, Trieste, Italy*

^g *Osservatorio Astronomico di Roma, Istituto Nazionale Astrofisica, Monteporzio Catone, Italy*

^h *Centrum Badań Kosmicznych PAN Warszawa, Poland*

ⁱ *Department of Physics and Astronomy, School of Physical Sciences, Ingram Building, University of Kent, Canterbury, Kent CT2 7NH, UK*

^j *School of Physical Sciences, The Open University, Milton Keynes MK7 6AA, UK*

^k *International PhD Programme / UNESCO Chair “Environment, Resources and Sustainable Development”, Department of Science and Technology, Parthenope University of Naples, Italy*

Received 11 March 2022; received in revised form 29 December 2022; accepted 23 January 2023

Available online 26 January 2023

Abstract

The Comet Interceptor space mission, selected by ESA in June 2019 as the first F-Class mission, will study a dynamically new comet or an interstellar object by a unique multi-point ‘snapshot’ measurement. The mission design will allow to complement previous single spacecraft’s fly-by cometary observations. The Dust Impact Sensor and Counter (DISC), devoted to the dust coma characterization, is part of the payload selected for Comet Interceptor. It will be mounted on-board two of the three spacecraft, as part of the Dust-Fields-Plasma (DFP) suite, dedicated to understand further: 1) dust in the coma; 2) magnetic field; 3) plasma and energetic neutral atoms. DISC architecture originates from the Impact Sensor subsystems, part of the Grain Impact Analyzer and Dust Accumulator (GIADA) that successfully flew on-board the ESA/Rosetta spacecraft. DISC main scientific objectives are: 1) to define the dust mass distribution for particles in the mass range $10^{-15} - 10^{-8}$ kg ejected from the cometary nucleus; 2) to count dust particles with mass $> 10^{-15}$ kg; 3) to constrain dust particle density/structure.

* Corresponding author.

E-mail address: vincenzo.dellacorte@inaf.it (V. Della Corte).

In this paper, we describe DISC design, aims, methods, feasibility and performances evaluations, carried out by real and simulated dust impacts and by retrieving the number of particles, and their corresponding momentum, using the Comet Interceptor's Engineering Dust Coma Model.

© 2023 Published by Elsevier B.V. on behalf of COSPAR. This is an open access article under the CC BY license (<http://creativecommons.org/licenses/by/4.0/>).

Keywords: Comets; Dust; Instrument; Dust detector; Hypervelocity impacts

1. Introduction

Giotto, the first deep space ESA mission [Reinhard, 1986], returned the most detailed images of comet 1P/Halley “small and dark” nucleus, characterized by intense activity from discrete areas [Keller et al. 2020]. Three decades later, the Rosetta/ESA space mission observed comet 67P/Churyumov-Gerasimenko, continuously for two years, inbound to and outbound from perihelion, contributing to a major advance in comet science and planetary formation processes [Taylor et al., 2017]. The forthcoming ESA/Comet Interceptor space mission, which will be launched in 2029, will study a Dynamically New Comet (DNC) providing a critical connection with cometary dust ejection observed by Rosetta [Della Corte et al., 2015; 2016a; 2019]. DNCs, a subset of the long-term comets that originate from the Oort cloud, are more pristine than those visited so far by previous space missions [Weissman 1990]. Exploring DNCs in situ is a challenging task: they are generally discovered close to perihelion, i.e. from a few months to a year earlier, a time lapse incompatible with standard mission planning timelines. Targeting them for the following perihelion passage would not be feasible due to their orbital periods of thousands of years. Comet Interceptor solves this issue because, after launch, the spacecraft will be inserted in a “parking orbit” to L2 of the Sun-Earth system, awaiting target discovery and selection. This mission profile is designed thanks to a powerful ground-based telescope, the Vera Rubin Large Synoptic Survey Telescope (VR-LSST) that from 2023 will continuously monitor the sky and will identify incoming DNCs with a few years' notice [Jones et al., 2020].

Comet Interceptor is composed of a primary spacecraft, S/C A, which also acts as a communication hub, and two sub-spacecraft, housed on S/C A during the L2 parking and cruise phases, S/C B1 (provided by JAXA) and S/C B2 (provided by ESA). This configuration will allow multi-point observations of the DNC and its surrounding environment [Snodgrass et al., 2019]. After DNC detection, the multiprobe will move from L2 towards the selected target. When close to the target, the three S/C will separate, with S/C A remaining at larger distance (flyby closest approach at about 1000 km) and S/Cs B1 and B2 will flyby closer (at about 300 km) to the DNC.

The payload on-board the three S/C includes:

- S/C A: CoCa (Comet Camera), DFP (Dust, Field and Plasma), MANIaC (Mass Analyzer for Neutrals and Ions at Comets), MIRMIS (Multispectral InfraRed Molecular and Ices Sensor);
- S/C B1: HI (Hydrogen Imager), PS (Plasma Suite), WAC (Wide Angle Camera);
- S/C B2: DFP (Dust, Field, and Plasma), EnVisS (Entire Visible Sky coma mapper), OPIC (Optical Imager for Comets).

The suite Dust, Field and Plasma (DFP) is designed to characterize: the cometary dust environment, charged gases, energetic neutral atoms and magnetic fields. Dust Impact Sensor and Counter (DISC), part of the DFP suite and housed on the RAM direction panel of both S/C A and S/C B2, will characterize the DNC coma dust environment. DISC, during the DNC fly-by that will occur at a not yet defined speed in the range 10 – 70 km/s, will count individual dust particles and measure their momentum. DISC on S/C A, due to the large distance from the DNC nucleus is expected to detect a smaller dust flux. Thanks to the reduced number of dust impacts and less restriction on data volume for S/C A, DISC data will be more informative: downloading complete data acquisition will allow a deep post-download analysis of PZT signals that will provide additional information on dust physical properties (e.g. density, porosity, tensile strength).

2. Comet Interceptor high-level scientific and measurements requirements for dust characterization

Previous cometary missions (in particular Rosetta) raised new important fundamental questions:

- What cometary properties are primordial and reflect the process of comet formation, and what are evolutionary features?
- How do these properties control cometary activity?
- Are the differences in composition seen in the coma and solar wind interaction spatial or temporal in origin?

Comet Interceptor is designed to address these open questions by making unique multi-point measurements in the coma of a pristine comet.

Table 1

Dust related science traceability matrix listing DISC measurement requirements and expected performances, partially depending on the speed of the fly-by, still to be defined in the range 10–70 km/s.

High level scientific requirement	Dust measurement requirements	DISC requirements
Characterise the dust in the coma and how it interacts with plasma.	Determine dust fluxes and particles' mass and size.	Dust particle mass: $10^{-15} - 10^{-8}$ kg; Dust particle size: 2–200 μm .
	Determine the dust spatial distribution and coma structures.	Dust detection rate up to 200 particles/second.
	Compare electron, ion and dust densities, to constrain dust charging.	Dust flux and dust spatial distribution. At max flyby speed (70 km/s) the spatial resolution will be 70 m, at lowest flyby speed (10 km/s) it will be 10 m.

Cometary activity will be investigated by combining detailed observations of the nucleus surface and of the coma, potentially linking the coma structures to nucleus surface features. The scientific theme on cometary activity focuses on the following questions:

- 1) What is the composition of the gas and dust in the coma?
- 2) How does the coma connect to the nucleus, i.e. how does cometary activity work?
- 3) What is the nature of coma- solar wind interaction?

To answer these questions, the high-level scientific requirement is to characterize the dust in the coma and to determine how it interacts with plasma.

DISC will contribute to these scientific aims by means of measurement requirements and with expected performances reported in the dust related science traceability matrix (Table 1).

3. DISC design

DISC, designed to count individual dust particles and measure their momentum, consists of a single parallelepiped-shaped aluminum box ($121 \times 115,5 \times 46 \text{ mm}^3$) containing two electronic boards, housed at the bottom of the mechanical box, and the sensing plate, located at the top of the box and exposed to the dust environment (Fig. 1). A dust shield is mounted between the sensing plate and the electronics to protect it from hypervelocity dust particles, possibly crossing the DISC sensing plate. To save mass and improve efficiency, the dust shield is made of an aerogel layer (2 cm thick) installed within a lightweight aluminum frame. The dust shield, as demonstrated by real hyper-speed dust impacts [Ferretti et al., 2022], is able to protect the undermounted electronic boards from dust impacts with kinetic energy up to 400 Joule. The aerogel capability to slow down and stop hyper-speed particles was demonstrated by the NASA/Stardust space mission [Brownlee et al., 2006]. The use of an aerogel dust shield allowed us to maintain DISC mass (0.5 kg) within the allowed budget, saving about 90 % of mass with respect to a conventional dust shield design.

The design of the DISC sensing device is inherited by the GIADA-IS (Grain Impact Analyser and Dust Accumulator-Impact Sensor), flown successfully on-board the ESA/Rosetta space probe [Della Corte et al., 2014; Rotundi et al. 2015.,]. While on the GIADA-IS five piezoelectric transducers (PZTs) were mounted underneath the aluminum sensing plate, for DISC the sensing aluminum plate (0.5 mm thick, with a sensitive area of $84 \times 84 \text{ mm}^2$) is equipped with three PZTs, glued at the plate corners (Fig. 1C). Three PZTs mounted in the selected configuration is the minimum number of PZTs to measure position and momentum of the dust impact. A larger number of PZTs, e.g. as for GIADA-IS, would have guarantee measurement redundancy, which is not mandatory for Comet Interceptor mission concept. The PZTs detect the bending Lamb waves, i.e. elastic waves whose particle motion lies in the plane that contains the direction of wave propagation and the direction perpendicular to the plate [Lamb, 1917], generated by the dust impact and propagating across the plate. The resulting electrical signal has an amplitude proportional to the momentum of the impacting particle by a restitution coefficient derived by calibration [Della Corte et al., 2016b]. An additional PZT transducer is glued under the fourth corner of the DISC aluminum plate to act as a calibrator. When powered, the calibrator produces a repeatable excitation of the sensing plate allowing to monitor DISC responsivity during in-flight operations.

DISC electronics (Fig. 2) consist of two boards: one for the digital processing and the other for the sensor's analog signal conditioning. The latter is dedicated to the signal filtering and amplification, it can be adapted to the flyby speed in order to maintain constant the measurable particle mass range. The digital board manages the settings for: signal elaboration, power distribution and data interface with the DFP control unit. The control logic is implemented in ad hoc FPGA firmware. DISC continuously acquires signal from the PZTs, when the digitized signal becomes higher than a settable value, the event (impact) acquisition is enabled and registered. The signal from the PZTs is acquired for 200 microseconds at 1 MHz sampling rate. From signal analysis it is possible to retrieve the impact position and the particle momentum.

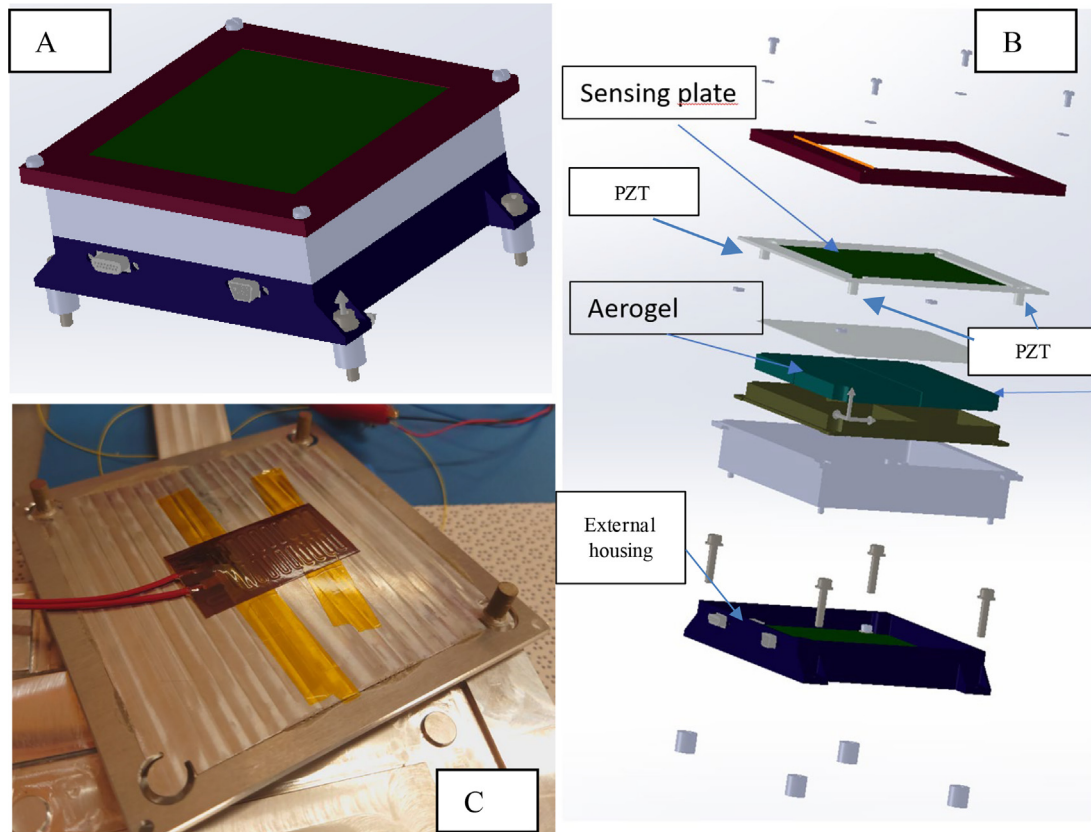

Fig. 1. A) DISC instrument 3D CAD model; B) DISC exploded view: sensing plate equipped with piezoelectric transducers, aerogel dust shield, electronic boards, external housing; C) DISC sensing plate with 3 PZT glued at the corners.

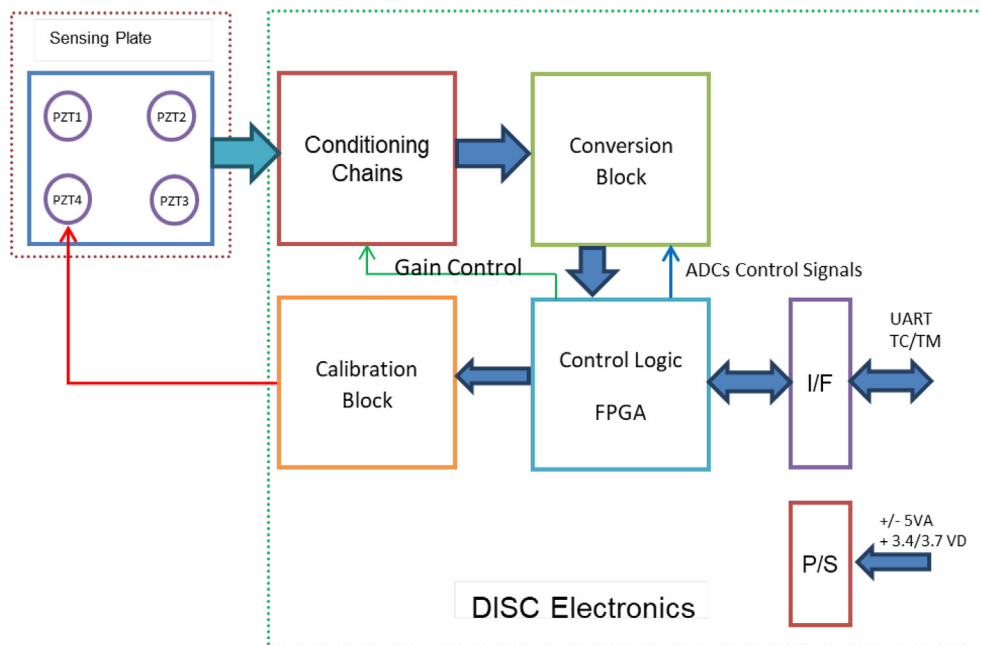

Fig. 2. DISC electronics functional blocks diagram.

Table 2

Dust particle momentum calculated for max and min flyby speeds and for different dust particle sizes, with an average density of $\approx 800 \text{ kg m}^{-3}$ [Fulle et al. 2017].

Dust Particle Size [micron]	Dust Particle Momentum [kg m/s] (flyby speed = 10 km/s)	Dust Particle Momentum [kg m/s] (flyby speed = 70 km/s)
1	3,35E-11	2,35E-10
2	2,68E-10	1,88E-09
5	4,18E-09	2,93E-08
10	3,35E-08	2,35E-07
20	2,68E-07	1,88E-06
50	4,18E-06	2,93E-05
100	3,35E-05	2,35E-04
200	2,68E-04	1,88E-03

4. DISC aims and methods

DISC is a monitoring instrument: the instrument is continuously ON and data acquisition is triggered by the dust impacts; when the PZT signal (impact momentum) is above DISC sensitivity, the acquisition of the dust event is enabled.

DISC main scientific objectives are:

- to map the dust distribution along the spacecraft trajectory in the selected DNC coma and to retrieve a 3D dust map, combining DISC measurements with dust coma model [Zakharov et al., 2021a; Zakharov et al., 2021b];
- to determine the dust mass distribution combining momentum measurements with the dust speed, that coincides with the spacecraft speed;
- to disentangle two dust particle populations in the DNC coma: 1) those ejected from the nucleus and directly impacting DISC (direct particles); and 2) those impacting DISC after deflection due to solar radiation pressure and/or gravity (reflected particles). This will be possible as DISC will measure the dust mass distribution contemporarily at different distances from the nucleus (DISC on S/C A and DISC on S/C B). Combining DISC data with the spacecraft trajectories, it will be possible to disentangle the reflected and the direct dust particle populations, providing the global cometary dust flux with no bias due to their mixing;
- to retrieve information on dust density and structural properties analysing the PZTs signal acquired inflight with the signal obtained with laboratory DISC calibration performed with cometary analogue particles [Ferrari et al., 2014].

DISC measurements during/after the close encounter will:

- provide the dust mass distribution for particles with mass in the range $10^{-15} - 10^{-8} \text{ kg}$, corresponding to particle sizes from approximately $1 \mu\text{m}$ up to $200 \mu\text{m}$;
- count impacting dust particles with mass $> 10^{-15} \text{ kg}$;
- characterize DISC sensing surface damages, after the DNC close encounter, using the internal calibrator and considering the modification in wave propagation

as done for aeronautical structures failures monitoring [Chinchilla et al., 2021, De Fenza et al., 2015, Wan et al., 2014].

In Table 2 we report the momentum values expected to be measured by DISC; they are calculated for maximum and minimum values of the dust speed (corresponding to the upper and lower speed limits foreseen for the spacecraft during the flyby, the actual value will depend on the selected target), for dust particles with sizes of $1 - 200 \mu\text{m}$ and a dust average density of $\approx 800 \text{ kg m}^{-3}$ (obtained by GIADA on-board Rosetta [Fulle et al. 2017]). Particle momentum that DISC will measure, combined with the actual spacecraft speed, will provide individual dust particle mass.

5. DISC expected performances

In order to define DISC expected performances in terms of detectable events, sensitivity limits and measurement capabilities, we used the Engineering Dust Coma Model (EDCM), developed to predict the hazard for Comet Interceptor during the flyby due to the dust environment [Zakharov et al., 2021a; Zakharov et al., 2021b; Marschall et al., 2022]. EDCM is composed of three modules:

- a dust dynamical module, to calculate the dust spatial distribution, considering the expanding nature and asymmetry of the gas coma and the dust dynamics, driven by the gas drag force, the gravity and the solar radiation pressure;
- a module to scale the dust volume densities, which performs dust column integration, considering the dust scattering and a size distribution, to obtain the brightness A_fp (defined by A'Hearn et al., 1984);
- a payload module, to extract the number dust density encountered along a specific spacecraft trajectory.

By means of the EDCM many possible dust environments, with different levels of activity and dust production, have been simulated; among these, we used two cases to estimate DISC performances: the average and the maximum level of cometary activity foreseen for a DNC consid-

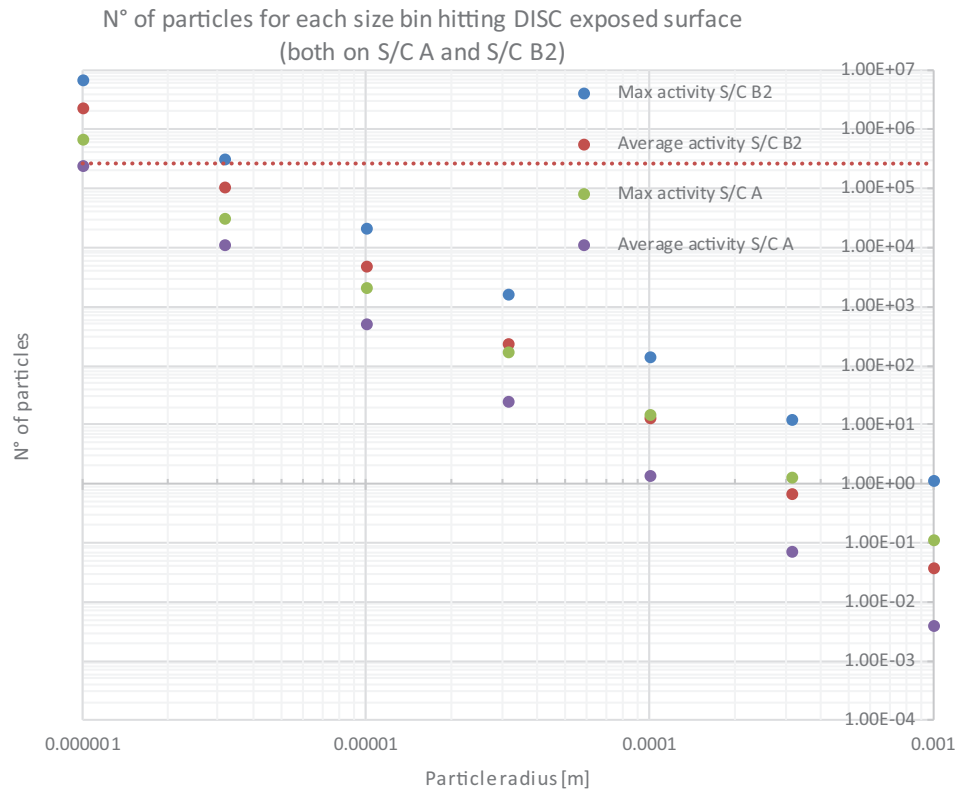

Fig. 3. Estimated total number of dust particles impacting the sensing plate of DISC, on S/C A and S/C B2, along the whole flyby, for each size bin and for max and average level of cometary activity.

ered feasible for Comet Interceptor. We estimated the total number of particles hitting the DISC sensing surface ($84 \times 84 \text{ mm}^2$) along the whole flyby, considering, as closest flyby distances for the S/C A and S/C B2, 1000 km and 300 km, respectively (Fig. 3). Starting from the GIADA heritage, the lower limit of the sensitivity varies over the sensing area and the maximum sensitivity is focused on a reduced area [Rotundi et al., 2015.]. Thus, to estimate the number of particles that will be actually measured by DISC, it is necessary to rescale by a factor of 10 the number of particles foreseen to impact DISC sensing surface, reported in Fig. 3. For DISC on-board S/C B2 we estimated approximately 10^6 and 5×10^5 particle detections for the maximum and average level of cometary activity, respectively. For DISC on-board S/C A, due to the larger fly-by distance, we expect a factor of 10 fewer events.

The maximum impact rate detectable by DISC, evaluated by HIV impact numerical simulation, is about 200 particles/s (see next paragraph). We compared this intrinsic DISC performance with the expected dust environment. From the derived dust spatial density (Fig. 4) expected along the fly-by (S/C A and S/C B2), we can conclude that: 1) for S/C A the resulting number of dust impacts per second is far from the DISC limit (200 particles/s), even in the case of the maximum flyby speed (70 km/s); 2) for S/C B2 the number of particles per second is close to the DISC limit only when the maximum flyby speed is considered. We can conclude that DISC performances are suitable for the predicted dust environment.

6. DISC feasibility study and performances evaluation

To study the feasibility of using the GIADA Impact Sensor working principle, designed and tested in a low speed impact regime, to the Hyper Velocity Impact regime in which DISC is expected to work, we ideated a multi-methodology study. The study allowed us also to evaluate DISC performances in the frame of Comet Interceptor fly-by.

Comet Interceptor flyby speed will depend on DNC selection, but for sure it will be within the range 10–70 km/s, thus coinciding with dust speed; DISC is designed to measure the momentum of particles between 1 and 200 μm in size. These speed and size intervals result in particle momenta to be measured by DISC ranging between 10^{-11} – 10^{-3} kg m/s . These momentum values imply that the DISC sensing plate will be impacted by particles with energies up to 10^3 J [Di Paolo et al., 2021]. These high energy impacts prevent making a DISC performances evaluation and calibration in laboratory. For this reason, we have devised a performance evaluation approach implying different techniques/methods:

1. Hyper Velocity Impacts of real projectiles on the DISC breadboard at accelerator facilities.
2. Hyper Velocity Impacts simulated by means of a high-power laser on the DISC breadboard.
3. Numerical simulation of Hyper Velocity Impacts on a simulated DISC sensing plate.

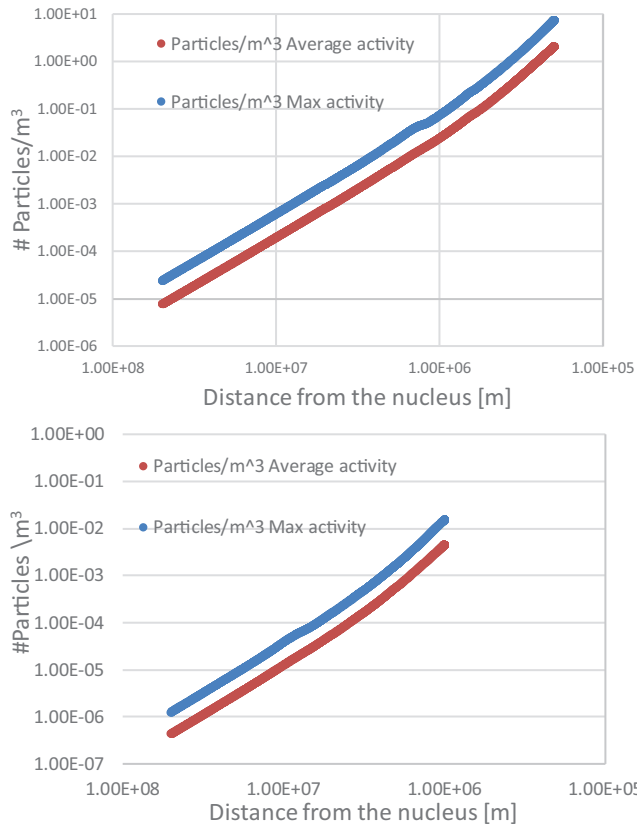

Fig. 4. Dust particles spatial density that DISC will encounter along the S/C A flyby (top panel) and along the S/C B2 fly-by (bottom panel).

This approach allows to: 1) overcome the unfeasibility of performing in laboratory HVI in the speed range foreseen for Comet Interceptor; 2) anticipate DISC performances; and 3) consider the processes involved in HVI regime, e.g. light flash, ionization, formation of ejecta, that can modify the momentum transfer to the DISC sensing element.

6.1. Hyper velocity impacts with real projectiles on the DISC breadboard at accelerator facilities

Hyper Velocity Impact tests are performed on the DISC breadboard using two different accelerator facilities at the Open University, UK: i) a Light Gas Gun (LGG), achieving impact velocities up to 7 km/s [e.g., McDonnell 2006; Hibbert et al., 2017] and ii) a Van de Graaff accelerator (VdG), achieving impact velocities up to 20 km/s [e.g., Friichtenicht, 1962]. While the former facility is used mainly to verify DISC mechanical performances, e.g. to investigate the dust shield efficiency, the latter is used

Table 3

Particle parameters used as projectiles at the Light Gas Gun and Van de Graaff accelerators to study DISC response in the lower range of the hyper velocity regime. For the reported particle compositions, individual particles can only be shot for diameters down to ~ few hundred-microns. For smaller particles at the LGG accelerator a buckshot projectile configuration must be used and only multiple particle impacts can be tested.

	Radius (μm)	Density (kg/m ³)	Velocity (km/s)
LGG	50–1500	1000 (polystyrene) 7800 (stainless steel)	5–7
VdG	3–5	7874 (iron)	5–20

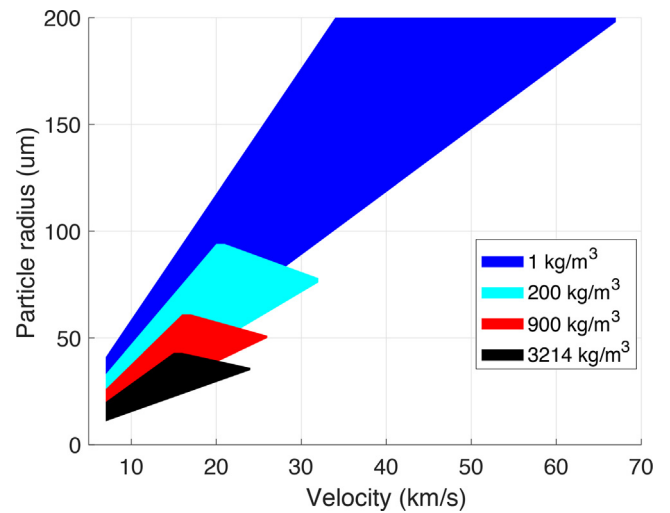

Fig. 5. Particle velocity/radius ranges, for different particle densities, whose hyper velocity impacts can be simulated by a Nd:YAG pulsed laser.

mainly to verify DISC-PZTs performances in an HVI regime, in combination with the other two methods listed above. Table 3 summaries physical parameters of dust particles that can be shot with the abovementioned facilities. Both accelerators are well suited to perform the tests needed for our scopes. The former was already used to support the NASA Stardust mission to comet 81/P-Wild-2 [Hörz et al., 2006] and the latter was employed to simulate interplanetary dust impacts on satellites [Mocker et al., 2011]. By considering different projectile densities and sizes for the two accelerators, DISC response is characterized in the lower part of the hyper velocity regime.

With respect to the LGG, at the VdG facility smaller particles (close to the lower limit of DISC measurement range) can be used, the projectiles have to be denser than $\approx 800 \text{ kg m}^{-3}$, i.e. than those expected for cometary dust [Fulle et al., 2017]. The combination of particle physical properties results in a particle momentum regime well suited for DISC performance. We use the outcome of these Hyper Velocity Impact tests as a benchmark for the simulated impacts approach. In addition, these tests are used to verify the effectiveness of the DISC dust shield (see the DISC design section).

6.2. Hyper velocity impacts simulated by means of a high-power laser on the DISC breadboard

In the frame of DISC performances evaluation, in order to extend the range of impact parameters, e.g. momentum,

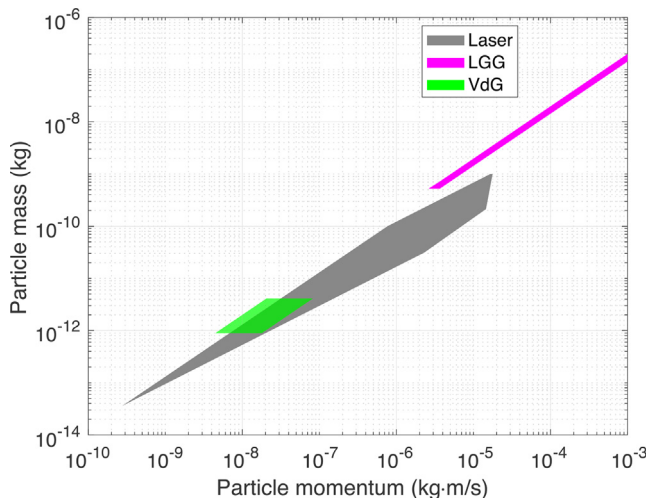

Fig. 6. Momentum and mass ranges for: particles simulated by a Nd:YAG laser (gray); real particles shot with by LGG (magenta) and VdG (green).

speed, energy, we designed and realized an experimental set up exploiting laser-simulated Hyper Velocity Impacts. This approach takes advantage of the late stage equivalence [Pirri, 1977]: by choosing appropriate laser intensity, beam radius, and pulse duration, the effect of HVIs on a DISC breadboard is reproduced. By means of a Nd:YAG (wavelength 1064 nm) pulsed laser, energies up to about 1.2 J and pulses around 3–6 ns can be reached, reproducing HVI of particles with different velocities, sizes and contact times. In Fig. 5 we report the results of the study we performed to identify particle speed and radius ranges to reproduce hyper velocity dust impacts by means a Nd:YAG pulsed laser. We identified the velocity/radius ranges at different particle densities, representative of cometary dust: fluffy aggregates (in blue) [Fulle et al., 2015]; porous aggregates

(in cyan and red) [Flynn et al., 2013]; and olivine grains with zero porosity (in black) [Marsh, 1980].

We determined, considering the particle density interval 1–3214 kg/m³, the ranges of particle momentum and mass that can be simulated by a Nd:YAG pulsed laser. We report these ranges in Fig. 6 (gray area) together with the corresponding momentum and mass values of real particles used for HVIs at the LGG (magenta) and VdG (green) facilities. It is noticeable that the laser-simulated HVI and the VdG real particle impacts cover a common range of particle parameters; by this superposition we can confirm the capability of the high-power pulsed laser technique in simulating dust hypervelocity impacts.

6.3. Numerical simulation of hyper velocity impacts on a simulated DISC sensing plate

We setup a dedicated numerical simulations chain able to characterize the effects of an HVI on a surface, describing in details the impact mechanical process and retrieving the simulated PZTs signal. Combining particle-based Smoothed-Particle Hydrodynamics (SPH) and element-based Finite Elements (FE), the chain provides a balanced model configuration to guarantee both calculation efficiency and results accuracy. In fact, SPH alone can well characterize the material distortion and compression induced by HVI, but it would lead to unmanageable calculation time. The strategy we followed implies to apply: 1) SPH to the region close to the impact, characterized by heavy distortion and compression of the impacted material; 2) FE for the discretization of the whole impacted surface with linear elastic response. The DISC response to HVI was analyzed applying in cascade SPH and FE by means of AUTODYNTM and ANSYSTM platforms,

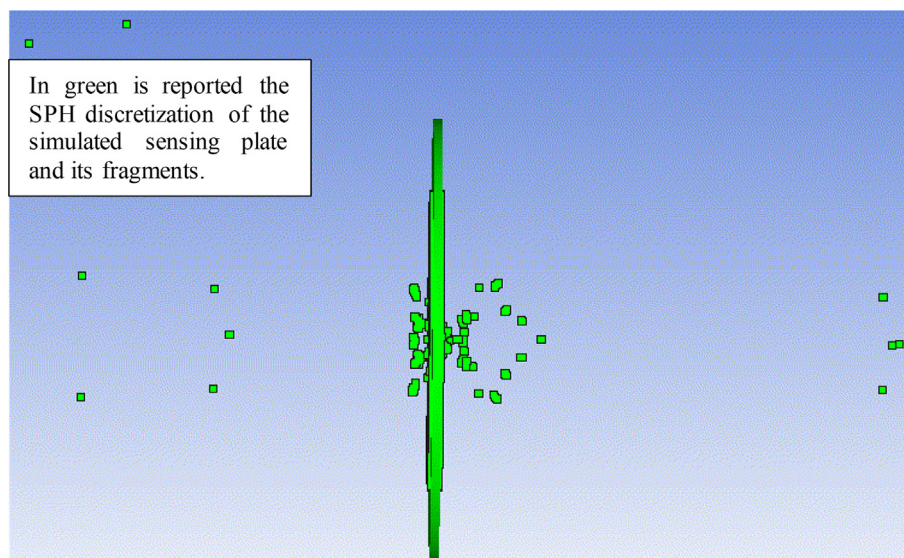

Fig. 7. Example of SPH simulation of a hyper velocity impact (60 km/s) of a 0.2 mm in diameter projectile impacting a simulated DISC aluminum sensing plate. The simulation involves only the vicinity of the impact point at 5×10^{-6} s after the impact. The numerical simulation well reproduces the hyper speed impact with the formation of ejecta from the sensing plate.

respectively. The effect of a particle impacting on the DISC sensing plate is simulated in two steps:

1. As a first step we apply SPH to simulate dust particle impact in a region very close to the impact point, starting from the contact time up to about 10^{-6} s after it. The simulation reproduces the impact and the consequent changes of the impacted surface due to the shockwaves. Large deformations and material detachments occur until, relatively far from the impact point, Lamb waves form and the elastic regime is set (Fig. 7).
2. The second step foresees the FE simulation for the transient structural analysis, applied from 0 s up to 3×10^{-4} s

after the HVI. The output of the first step is used as input for this second one, which is applied to the whole DISC sensing plate in order to obtain the HVI effects till to the edges, where the PZTs are placed. In order to simulate DISC output, i.e. the expected PZT signal processed by the DISC proximity electronics, FE simulation includes the PZTs characteristics.

The simulations were also used to evaluate the dead time of the DISC sensing plate. We carried out simulation till when the signal registered at PZT extinguished. With this procedure we obtained, for the upper limit of particles momentum, a maximum extinction time of about 2 ms. DISC dead time is linked to the extinction time of the

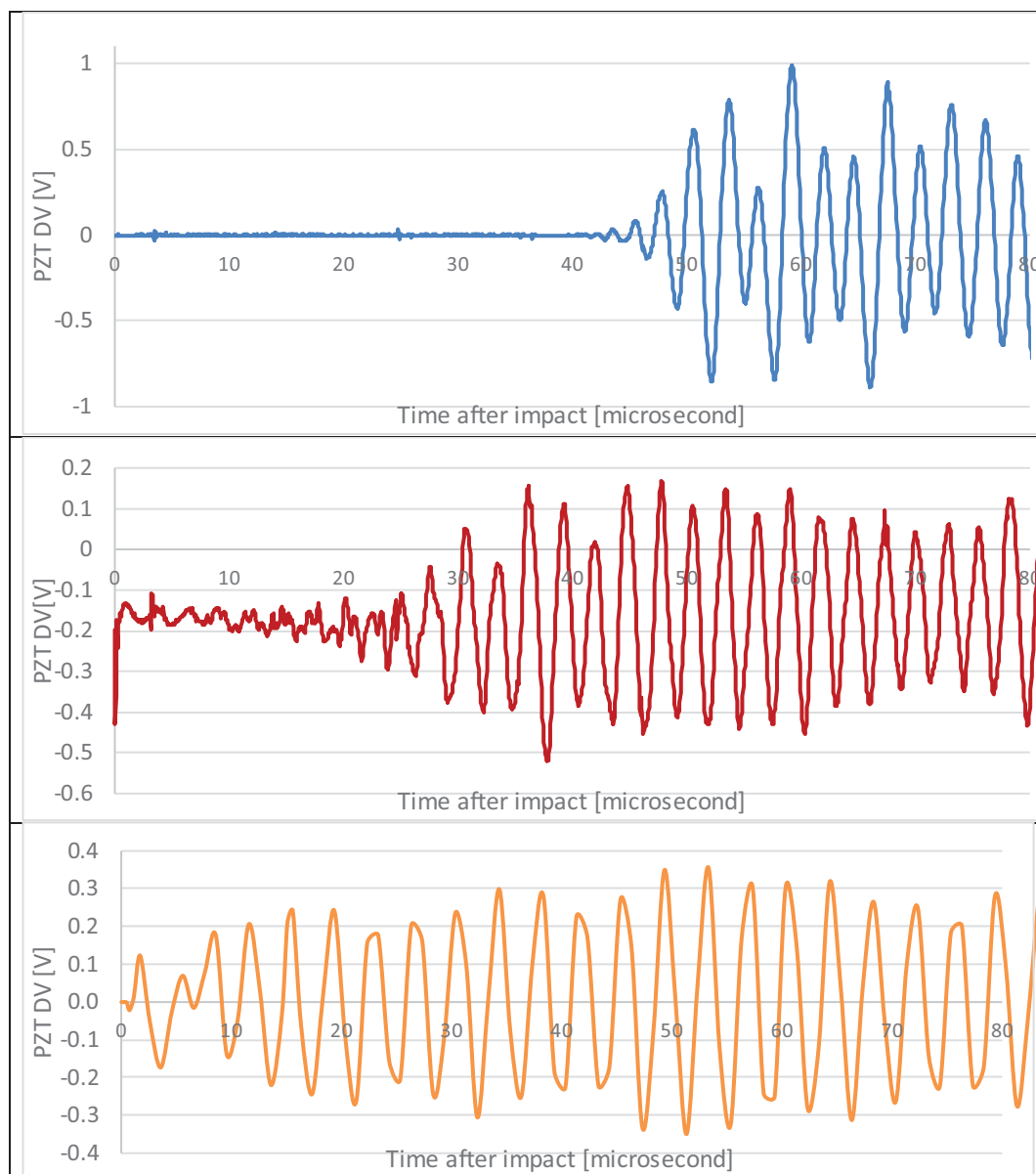

Fig. 8. Comparison between Lamb waves generated by: a 1 mm sphere impacting on the DISC breadboard sensing plate at about 0.01 km/s (upper panel); a laser simulated HVI on the DISC breadboard sensing plate (laser energy 50 mJ corresponding to a 50 μ m particle at about 8 km/s) (middle panel); a numerical simulated HVI (25 μ m particle at 15 km/s), on the DISC simulated sensing plate (lower panel). Signals start at different time because of the different distances from the PZT of the real or simulated impact.

Lamb waves, i.e. the time needed to extinguish the vibration in the sensing plate after each impact.

In Fig. 8 we report the comparison between Lamb waves generated with different methods: 1) registered by a PZT after a real low velocity dust impact (<10 m/s) on the DISC sensing plate (upper panel); 2) induced on the DISC sensing plate by a HVI simulated by means of a high power laser pulse (middle panel); and 3) resulting from simulated HVI on the DISC sensing plate. The comparison confirms that the DISC sensing plate has a similar elastic behavior for simulated HVI (far from the impact point) and for low-speed impacts [Liu et al., 2016; Piccirillo et al., 2021.]. The comparison of signals from GIADA Impact Sensor measurements with those obtained by simulated Hyper Velocity Impacts (HVI) on the DISC sensing plate shows the suitability of the GIADA Impact Sensor working principle in the frame of Comet Interceptor requirements.

7. Conclusions

The DISC instrument is dedicated to the in-situ dust characterization of the coma environment of a Dynamically New Comet, the target of the Comet Interceptor/ESA space mission. DISC is a direct evolution of the GIADA-Impact Sensor subsystem, successfully flown onboard the ESA/Rosetta space probe. In this paper, we showed that the working principle conceived for the GIADA-Impact Sensor, foreseen and tested for slow to medium velocity impacts, is valid also in the Hyper Velocity Impacts (HVI) regime. We report the DISC expected performances, in terms of detectable events, sensitivity limits and measurement capabilities, that we derived by means of the Engineering Dust Coma Model. In addition, we evaluated the DISC performances, concluding that they fulfill the main scientific requirements to obtain the coma dust mass distribution of a Dynamically New Comet, with a multi-methods strategy:

- 1) HVI tests firing real particles onto the DISC breadboard sensing plate by means of two laboratory facilities, a Light Gas Gun providing impact velocities up to 7 km/s and a Van de Graaff accelerator providing impact velocities up to 20 km/s;
- 2) HVI on the DISC breadboard sensing plate where the impact effects are simulated by a Nd:YAG laser;
- 3) Numerical simulations, that foresees the coupling of SPH and FE methods, of HVI on a modelled DISC sensing plate.

The comparison between DISC PZT signals induced with different methods:

- i) real low speed dust impact;
- ii) high power laser pulse;
- iii) numerically simulated;

confirms that the DISC sensing plate has an elastic behavior for Hyper Velocity Impacts similar to low/medium speed particle impacts. The latter already successfully applied for the GIADA Impact Sensor measurements in the 67P/Churyumov–Gerasimenko coma. These results demonstrate that the Impact Sensor design used for GIADA is still valid for DISC in the frame of Comet Interceptor. The only difference will be in the restitution coefficient, necessary to retrieve the particle momentum from the PZT signal, which will be defined by on ground DISC calibrations.

Declaration of Competing Interest

The authors declare that they have no known competing financial interests or personal relationships that could have appeared to influence the work reported in this paper.

Acknowledgement

We thank; the Italian Space Agency (ASI) within the ASI-INAF agreements I/024/12/0 and 2020-4-HH.0; Europlanet 2024 RI has received funding from the European Union's Horizon 2020 research and innovation programme under grant agreement No 871149; ESA that supported this study with the contract 3-17164/21/NL/GP/pbe COMET INTERCEPTOR-IT-3; the PhD program PON "Ricerca e Innovazione" 2014-2020, DM n.1061 (10/08/2021) and n. 1233 (30/07/2020).

References

- A'Hearn, M. F.; Schleicher, D. G. ; Millis, R. L. ; Feldman, P. D. ; Thompson, D. T., Comet Bowell 1980b, *Astronomical Journal* (ISSN 0004-6256), vol. 89, April 1984, p. 579-591.
- D. Brownlee, Tsou P., Aleon J., Alexander C. M. O'D., Araki T., Bajt S., Baratta G. A., Bastien R., Bland Ph., Bleuet P., Borg J., Bradley J. P., Brearley A., Brenker F., Brennan S., Bridges J. C., Browning N. D., Brucato J. R., Bullock E., et al., Comet 81P/Wild2 under a microscope. *Science*, 314, 1711-1716 (2006).
- Chinchilla, S.C., Aranguren, G., Royo, J.M., Chiachío, M., Etxaniz, J., Echenique, A.C., 2021. Structural health monitoring using ultrasonic guided-waves and the degree of health index. *Sensor* 21, 993.
- De Fenza, A., Sorrentino, A., Vitiello, P., 2015. Application of artificial neural networks and probability ellipse methods for damage detection using lamb waves. *Compos. Struct.* 133, 390–403.
- Della Corte V., Rotundi A., Fulle M., et al., 2016a. 67P/C-G Inner Coma dust properties from 2.2 AU inbound to 2 AU outbound to the Sun, *Monthly Notices of the Royal Astronomical Society*, 462, pp. S210-S219, DOI: 10.1093/mnras/stw2529.
- Della Corte V., Rotundi A., Zakharov V. et al. 2019. GIADA microbalance measurements onboard Rosetta: sub-micron to micron-sized dust particles flux in the coma of comet 67P/Churyumov-Gerasimenko, *A&A*, Volume 630, id.A25, 13 pp..
- Della Corte, V., Rotundi, A., Accolla, M., et al., 2014. GIADA: its status after the Rosetta cruise phase and on ground activity in support of the encounter with comet 67P/Churyumov -Gerasimenko. *JAI* 03 (01), 1350011. <https://doi.org/10.1142/S22511713500116>.
- Della Corte, V., Rotundi, A., Fulle, M., et al., 2015. GIADA: shining a light on the monitoring of the comet dust production from the nucleus of 67P/Churyumov-Gerasimenko. *Astron. Astrophys.* 513.

- Della Corte, V., Sordini, R., Accolla, M., et al., 2016b. Giada–grain impact analyzer and dust accumulator–onboard rosetta spacecraft: extended calibrations. *Acta Astron.* 126, 205–214.
- Di Paolo, F., Della Corte, V., Bertini, et al. 2021. Dust Impact Sensor and Counter (DISC) for Comet Exploration: Laser Simulations of Hypervelocity Impacts. In *Lunar and Planetary Science Conference* (No. 2548, p. 1238).
- Ferrari, M., Della Corte, V., Rotundi, A., Rietmeijer, F.J.M., 2014. Single minerals, carbon- and ice-coated single minerals for calibration of GIADA onboard ROSETTA to comet 67P/Churyumov–Gerasimenko. *Planet. Space Sci.* 101, 53–64.
- Ferretti S., Della Corte V., Piccirillo A., et al. 2022. Analysis of dust shield and detection system response to hypervelocity impacts for Comet Interceptor Dust Impact Sensor and Counter. *EPSC Abstracts Vol. 16, EPSC2022-1163*, 2022.
- Flynn, G.J., Wirick, S., Keller, L.P., 2013. Organic grain coatings in primitive interplanetary dust particles: implications for grain sticking in the Solar Nebula. *Earth Planets Space* 65 (10), 1159–1166.
- Friichtenicht, J.F., 1962. Two-million-volt electrostatic accelerator for hypervelocity research. *Rev. Sci. Instrum.* 33 (2), 209–212.
- Fulle, M., Della Corte, V., Rotundi, A., et al., 2015. Density and charge of pristine fluffy particles from comet 67P/Churyumov–Gerasimenko. *Astrophys. J. Lett.* 802 (1), L12.
- Fulle M., Della Corte V., Rotundi A., et al., 2017. The dust-to-ices ratio in comets and Kuiper belt objects. *MNRAS.*, 469, Issue Suppl_2 S45–S49, <https://doi.org/10.1093/mnras/stx983>.
- Hibbert, R., Cole, M.J., Price, M.C., Burchell, M.J., 2017. The hypervelocity impact facility at the University of Kent: recent upgrades and specialized capabilities. *Procedia Eng.* 204, 208–214.
- Hörz, F., Bastien, R., Borg, et al. 2006. Impact features on Stardust: Implications for comet 81P/Wild 2 dust. *science*, 314(5806), 1716–1719. DOI: [10.1126/science.1135705](https://doi.org/10.1126/science.1135705)
- Jones, R.L., Bannister, M.T., Bolin, B.T., et al. 2020, preprint, .
- Keller, H.U., Kühr, E., 2020. Cometary Nuclei—From Giotto to Rosetta.”*Space Science Review*”, 216, 14. <https://doi.org/10.1007/s11214-020-0634-6>
- Lamb, H. “On Waves in an Elastic Plate.” *Proc. Roy. Soc. London, Ser. A* 93, 114–128, 1917.
- Liu, M., Su, Z., Zhang, Q., and Long, R., 2016. “Modeling Hypervelocity-Impact-Induced Shock Waves for Characterizing Orbital Debris-Produced Damage.” *ASME. J. Appl. Mech.* August 2016; 83(8): 081010. <https://doi.org/10.1115/1.4033679>.
- Marschall, R., Zakharov, V., Tubiana, C., Kelley, M.S.P., van Damme, C. C., Snodgrass, C., Jones, G.H., Ivanovski, S.L., Postberg, F., Della Corte, V., Vincent, J.-B., Muñoz, O., La Forgia, F., Levasseur-Regourd, A.-C. and the Comet Interceptor Team, Determining the dust environment of an unknown comet for a spacecraft fly-by: The case of ESA’s Comet Interceptor, *A&A*, 666 (2022) A151, DOI: <https://doi.org/10.1051/0004-6361/2022>.
- Marsh, S.P., 1980. *LASL shock Hugoniot data*, Vol. 5. Univ of California Press.
- McDonnell, J.A.M., 2006. The Open University planetary impact facility: a compact two-stage light gas gun for all impact angles. *Int. J. Impact Eng.* 33 (1–12), 410–418.
- Mocker, A., Bugiel, S., Auer, et al., 2011. A 2 MV Van de Graaff accelerator as a tool for planetary and impact physics research. *Review of Scientific Instruments*, 82(9), 095111.
- Piccirillo, A. M., Della Corte V., Rotundi A. et al. 2021. EPSC Abstract, Vol 15 EPSC2021-618, European Planetary Science Congress 2021.
- Pirri, A.N., 1977. Theory for laser simulation of hypervelocity impact. *Phys. Fluids* 20 (2), 221–228.
- Reinhard, R., 1986. The Giotto encounter with comet Halley. *Nature* 321 (6067), 313–318.
- Snodgrass, C., Jones, G.H., 2019. The European Space Agency’s Comet Interceptor lies in wait. *Nat. Commun.* 10 (1), 1–4.
- Rotundi, A., Sierks H., Della Corte V., et al 2015 *SCIENCE* Vol 347, Issue 6220 • DOI: [10.1126/science.aaa3905](https://doi.org/10.1126/science.aaa3905).
- Taylor M. G. G. T., Altobelli N., Buratti, B. J. and Choukroun M. The Rosetta mission orbiter science overview: the comet phase. *Philosophical transactions of the royal society A mathematical, physical and engineering sciences*. Volume 375, Issue 2097 Published:29 May 2017 <https://doi.org/10.1098/rsta.2016.0262>.
- Wan, X., Zhang, Q., Xu, G., Tse, P.W., 2014. Numerical simulation of nonlinear lamb waves used in a thin plate for detecting buried microcracks. *Sensors* 14, 8528–8546.
- Weissman, P., 1990. The Oort cloud. *Nature* 344, 825–830. <https://doi.org/10.1038/344825a0>.
- Zakharov V.V., Rotundi A., Della Corte V., et al., 2021a. On the similarity of dust flows in the inner coma of comets Icarus, Volume 364, , 114476, ISSN 0019-1035, <https://doi.org/10.1016/j.icarus.2021.114476>
- Zakharov, V.V., Rodionov, A.V., Fulle, M., et al., 2021b. Practical relations for assessments of the gas coma parameters. *Icarus* 354. <https://doi.org/10.1016/j.icarus.2020.114091>