

This is the author's copy of the publication as archived with the DLR's electronic library at <http://elib.dlr.de>. Please consult the original publication for citation, see e.g. <https://ieeexplore.ieee.org/document/10521422>

## EDEN Versatile End-effector (EVE): An Autonomous Robotic System to Support Food Production on the Moon

A. Fonseca Prince, J.P. Lutze, M. Maier, W. Friedl, D. Leidner, C. Philpot, V. Vrakking, E. Ksenik, D. Schubert

Spacefaring nations have already expressed their plans for a sustainable human and robotic exploration on the Moon. This endeavor highlighted in the Global Exploration Roadmap (GER) foresees the development of infrastructures such as habitats, greenhouses, science labs, power plants, and mining facilities. Following this long-term vision, the German Aerospace Center (DLR) EDEN LUNA Project presents a Moon-analogue greenhouse facility which can demonstrate nearly closed-loop bio-regenerative life support systems technology and aim to produce fresh food for astronauts on the Moon in the near future. To optimize the food production and overcome challenges inherent to space missions, the EDEN Versatile End-effector (EVE) is integrated to the EDEN LUNA Greenhouse. This support system is a valuable payload which will automatize the tasks of the entire plant cultivation process: from germination to harvesting. The automatization is particularly relevant when the food production is intensified either seasonally or in a future scaled-up scenario. The EVE system encompasses a linear rail system installed on the ceiling of the greenhouse, a 7-Degrees of Freedom (DOF) autonomous robotic arm with high precision joint configuration, a sensorized robotic hand which can grasp delicate objects, and a sophisticated computer vision camera with plant monitoring capabilities. When in operation, the EVE system uses shared autonomy features. Thus, while it maintains the human in the loop for some of the decision-making processes, it can also function with some level of autonomy. A set of tasks previously defined by an astronaut in the end of an operational day and carried out autonomously during the night by the EVE system is one example of this human-robot collaboration. In addition, an optimized motion planning will ensure that the EVE system can perform constrained manipulation tasks in a limited workspace observing energy efficiency and safety requirements. This is explained in the paper with the abstraction of the different robotic control levels which range from the high-level view for non-experts in robotics to the motion planning level and their interconnections. The EVE system is currently in development at the DLR Robotic and Mechatronics Center (RMC) in Oberpfaffenhofen. In 2024, it will be integrated to the EDEN LUNA Greenhouse at the DLR Institute of Space Systems in Bremen. Finally, by the end of 2025, it will start operations in the ESA/DLR LUNA facility at the European Astronaut Centre (EAC) in Cologne.

### Copyright Notice

©2024 IEEE. Personal use of this material is permitted. Permission from IEEE must be obtained for all other uses, in any current or future media, including reprinting/republishing this material for advertising or promotional purposes, creating new collective works, for resale or redistribution to servers or lists, or reuse of any copyrighted component of this work in other works.

A. F. Prince et al., "EDEN Versatile End-effector (EVE): An Autonomous Robotic System to Support Food Production on the Moon," 2024 IEEE Aerospace Conference, Big Sky, MT, USA, 2024, pp. 1-9, doi: 10.1109/AERO58975.2024.10521422.

# EDEN Versatile End-effector (EVE): An Autonomous Robotic System to Support Food Production on the Moon

Andre Fonseca Prince, Jean-Pascal Lutzé,  
Maximilian Maier, Werner Friedl,  
and Daniel Leidner  
German Aerospace Center (DLR)  
Institute of Robotics and Mechatronics  
Münchener Str. 20  
82234 Wessling, Germany  
Andre.FonsecaPrince@DLR.de

Claudia Philpot, Vincent Vrakking,  
Eugen Ksenik, and Daniel Schubert  
German Aerospace Center (DLR)  
Institute of Space Systems  
Robert-Hooke Str. 7  
28359 Bremen, Germany

*Abstract*—Spacefaring nations have already expressed their plans for a sustainable human and robotic exploration on the Moon. This endeavor highlighted in the Global Exploration Roadmap (GER) foresees the development of infrastructures such as habitats, greenhouses, science labs, power plants, and mining facilities. Following this long-term vision, the German Aerospace Center (DLR) EDEN LUNA Project presents a Moon-analogue greenhouse facility which can demonstrate nearly closed-loop bio-regenerative life support systems technology and aim to produce fresh food for astronauts on the Moon in the near future. To optimize the food production and overcome challenges inherent to space missions, the EDEN Versatile End-effector (EVE) is integrated to the EDEN LUNA Greenhouse. This support system is a valuable payload which will automatize the tasks of the entire plant cultivation process: from germination to harvesting. The automatization is particularly relevant when the food production is intensified either seasonally or in a future scaled-up scenario. The EVE system encompasses a linear rail system installed on the ceiling of the greenhouse, a 7-Degrees of Freedom (DOF) autonomous robotic arm with high precision joint configuration, a sensorized robotic hand which can grasp delicate objects, and a sophisticated computer vision camera with plant monitoring capabilities. When in operation, the EVE system uses shared autonomy features. Thus, while it maintains the human in the loop for some of the decision-making processes, it can also function with some level of autonomy. A set of tasks previously defined by an astronaut in the end of an operational day and carried out autonomously during the night by the EVE system is one example of this human-robot collaboration. In addition, an optimized motion planning will ensure that the EVE system can perform constrained manipulation tasks in a limited workspace observing energy efficiency and safety requirements. This is explained in the paper with the abstraction of the different robotic control levels which range from the high-level view for non-experts in robotics to the motion planning level and their interconnections. The EVE system is currently in development at the DLR Robotic and Mechatronics Center (RMC) in Oberpfaffenhofen. In 2024, it will be integrated to the EDEN LUNA Greenhouse at the DLR Institute of Space Systems in Bremen. Finally, by the end of 2025, it will start operations in the ESA/DLR LUNA facility at the European Astronaut Centre (EAC) in Cologne.

## TABLE OF CONTENTS

1. INTRODUCTION.....	1
2. THE EDEN LUNA PROJECT .....	2
3. EDEN VERSATILE END-EFFECTOR (EVE) .....	3
4. AUTONOMOUS ROBOTIC OPERATIONS CONCEPT .....	4
5. ROBOTIC CONTROL LEVELS.....	5
6. DISCUSSION .....	6

7. SUMMARY .....	7
ACKNOWLEDGMENTS .....	8
REFERENCES .....	8
BIOGRAPHY .....	8

## 1. INTRODUCTION

In-situ food production for astronauts on the lunar surface is one of the goals which follows the sustainable principles stated by the Global Exploration Roadmap (GER) [1]. To enable sustained human living and working on the Moon, nutritional sources are needed by the crew to keep them healthy and productive. While resupplying all the food from Earth will increase the global mission cost and the logistics complexity, the local food production is a necessary step to avoid these barriers and to benefit the sustained human presence on the Moon. Growing plants can fulfill this necessity with the advantage of producing oxygen, removing carbon dioxide from the atmosphere, and recycling water [2]. Thus, we present the EDEN LUNA Moon analogue greenhouse as a possible solution to this sustainability challenge.

The greenhouse depends on the crew to be operational. While this operation can be done manually and creates a positive psychological effect on astronauts, it is also true that it takes time from the crew schedule which could be used for scientific tasks. In this context, the EVE system is incorporated to the EDEN LUNA greenhouse to support the activities of the plant cultivation cycle. With the shared autonomy capability, the EVE system can perform the plant cultivation tasks autonomously while the human is kept in the loop. This means that the operator focuses only on the high level goals (place and task selection for example) while the robot schedules the sequence of actions and executes them autonomously. Therefore, the astronaut is free to perform other activities at the same time that the robot is taking care of the plants. In a scaled-up scenario with several greenhouses deployed on the lunar surface, a unique astronaut (not necessarily on the Moon) can manage all of them with the support of the EVE system. In addition, the initial missions to the Moon do not intend to have humans continuously on the lunar surface. An autonomous robotic system such as the EVE system will be key to support remote operations from the Lunar Gateway or the Earth in preparation for future human lunar missions.

The paper is organized as follows: Sec. 2 provides an overview of the EDEN LUNA project. In Sec. 3, we describe the EVE system with its main subsystems and its software architecture. Details of the autonomous robotic operations concept and the control levels to carry out the tasks are

provided in Sec. 4 and Sec. 5. Finally, we discuss the capabilities of the EVE system with the hypothesis of a future lunar surface deployment in Sec. 6 and we summarize in Sec. 7.

## 2. THE EDEN LUNA PROJECT

### *The LUNA facility*

A lunar analogue facility named LUNA [3] is currently in development by the European Space Agency (ESA) and the German Aerospace Center (DLR) in Cologne, Germany. The main hall has an area of 700m<sup>2</sup> and will be filled with lunar regolith simulant (EAC-1). It is planned that astronaut training, robotic operations and scientific activities are carried out in this testbed. Besides several features such as solar simulator (for lunar light conditions), In-situ Resource Utilization (ISRU) experiments, and reduced gravity operations with an offloading system, external modules are expected to be installed as part of the LUNA facility. Amongst them, the Future Lunar EXploration Habitat (FLEXHab) for astronaut multi-day isolation simulation, an off-grid regenerative energy system, and the EDEN LUNA as a ground demonstrator for plant cultivation in extreme environments.

### *EDEN LUNA*

The EDEN LUNA project, as part of the LUNA project, focuses on developing a (semi-) closed loop Controlled Environment Agriculture (CEA) greenhouse. EDEN LUNA will build on the successful heritage of EDEN ISS [4], where DLR and a consortium of international partners developed the Mobile Test Facility (MTF) greenhouse and operated it in a space-analogue environment near the German Neumayer Station III in the Antarctic from 2018 to 2022. After this period, the MTF was disassembled and transported back to Germany, where it will be refurbished and outfitted with new payloads for the EDEN LUNA project. This includes the EVE robotic payload. Data gathered from operations in the Antarctic indicated that a significant amount of crew time was required to carry out nominal and off-nominal tasks, such as cleaning and plant handling [5]. The EVE system is intended to demonstrate the capability to carry out such tasks and thereby reduce the required crew time demand.

### *EDEN LUNA Subsystems and Payloads*

Apart from the EVE robotic payload, the EDEN LUNA project have several subsystems (Fig. 1) located on the Future Exploration Greenhouse (FEG) and the Service Section (SES) containers. These subsystems are described as follows.

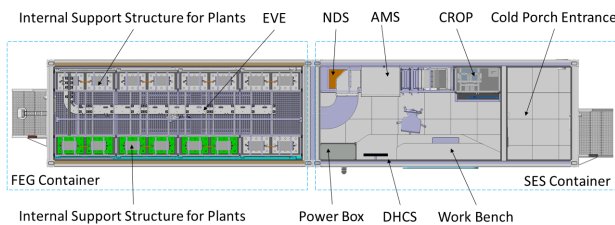

**Figure 1:** Top view of the EDEN LUNA Greenhouse.

The Nutrient Delivery System (NDS) has two bulk nutrient solutions for leafy greens and fruiting crops. It is connected directly to the different plant cultivation trays through a sys-

tem of pumps, pipes and automated valves to supply nutrient solution to the crops.

The Atmosphere Management System (AMS) is responsible for controlling the internal atmospheric conditions, maintaining temperature and relative humidity at desired levels, removing contaminants and ensuring a safe atmospheric composition.

The Combined Regenerative Organic food Production (C.R.O.P. ®) biofilter developed by DLR will be integrated into the greenhouse to demonstrate the capability of recycling urine into nutrient solution for plant cultivation.

The Power system, redesigned with reduced complexity and size, has the function to distribute power to the different subsystems and components, monitor power consumption, and provide backup power in case of a power supply issue.

The Data Handling Control System (DHCS) has a dedicated subsystem and payload controllers which will interface with a redundant DHCS on-board computer (OBC). The OBC will receive and transfer telemetry and telecommands from/to the several subsystems inside the greenhouse. It will also provide Fault Detection, Isolation and Recovery (FDIR) functionality.

The Lighting Control System (LCS) has liquid-cooled light-emitting diode (LED) panels to provide four different individually controllable wavelengths. Light intensity, spectrum and duration can be changed according to the needs of the selected crops and cultivars.

And finally, the Thermal Control System (TCS) which corresponds to the fluid loop system. This system collects the heat from the EDEN LUNA subsystems/payloads and transfers it to the external environment.

### *EDEN Next Generation (NG)*

EDEN LUNA is an incremental step towards a future lunar surface greenhouse based on the EDEN ISS heritage. However, there are still significant challenges to address before a greenhouse on the Moon can become a reality. In addition, not all of these challenges can be addressed with EDEN LUNA given the constraints from the existing EDEN ISS hardware. For this reason, DLR has initiated the EDEN NG project (Fig. 2), in collaboration with the Canadian Space Agency (CSA) and potentially other partners, to develop a new Ground Test Demonstrator (GTD) which will build on the experience from EDEN ISS and EDEN LUNA.

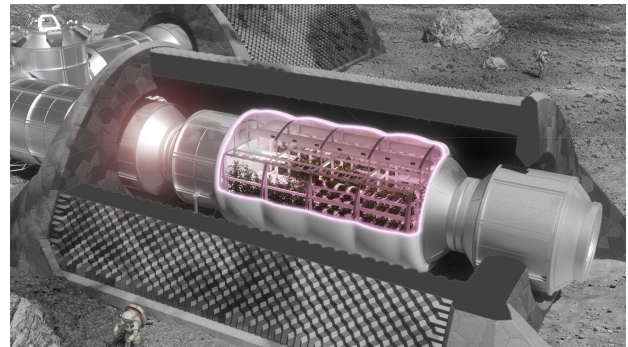

**Figure 2:** Greenhouse concept on the Moon (Image: DLR, public domain)

The GTD will include a habitat simulator, to test the interfaces between habitat and greenhouse, in particular considering air and gas exchange. Following the GTD operations, the aim will be to incorporate all the lessons learned towards a final, space-ready, lunar greenhouse design. Preliminary design, possible science case and a potential mission scenario for EDEN NG have been presented in [6].

### 3. EDEN VERSATILE END-EFFECTOR (EVE)

The EVE system (Fig. 3) is a robotic system to automatize the plant cultivation tasks of the EDEN LUNA greenhouse. The execution of the tasks happens in a shared-autonomous manner as we explain in Sec. 4. The entire system weighs about 170 Kg and the expected power consumption is 700 W. The main subsystems and the software architecture are explained as follows.

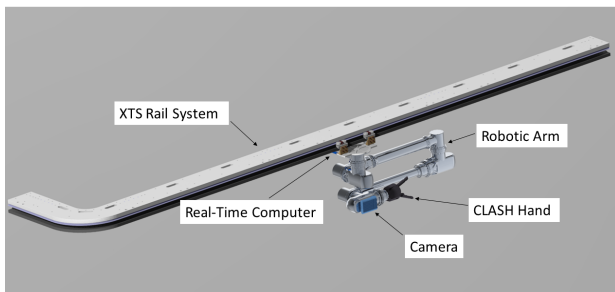

Figure 3: The EVE System.

#### Robotic Arm

The seven degrees of freedom (DOF) robotic arm is based on the This Is Not an Arm (TINA) technology [7] previously developed in DLR. As heritage of a series of light weight robotic arms, this manipulator is modular and can be customized for different applications. For example, each shoulder section containing two to three joints are connected by rigid tubular links. While shoulders can be removed to lower the DOFs, the tubular links can be shrunk to reduce the length of the arm. We remind that this modular aspect is bounded to the design phase and not to a plug-and-play operational mode. For the EDEN LUNA project, we decided to have all the seven joints and to not shorten the length of the links. This guarantees the high degree of manipulability in a very constrained space and a good reachability taking advantage of the full length of the arm. The arm weighs 18 Kg, has 2-m length, and can hold payloads up to 5 Kg. It is built with three shoulder sections and two links. Each shoulder section has one roll and one pitch axis as shown in Fig. 4. An additional roll axis (axis 3) is added to the base shoulder section to improve the workspace of the arm.

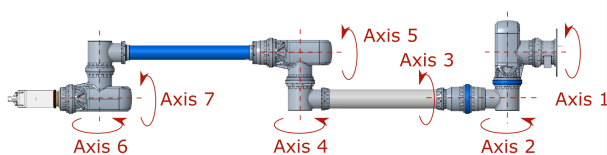

Figure 4: The Robotic Arm.

The robotic arm operates in 28 Vdc (power) and 24 Vdc (control). Each shoulder section has up to three electronic units dedicated to motor control, power management and communication. The electronic architecture is built around the Field Programmable Gate Array (FPGA) (Microsemi RT3PE) which manages the communication infrastructure, the motor drive unit, and a series of sensors (Current, Voltage, Torque and Position). The implemented communication between the electronic unit and the external real-time computer is SpaceWire with 3 kHz and up to 200 Mbit/s bandwidth. The motor controller relies on the Texas Instruments brushless DC Motor Controller (DRV8332) and the driving signals generated by the FPGA. This combination allows the selection between field-oriented control method or simpler motor switching modes such as six or twelve-step commutation scheme. Current/Voltage and Torque sensors need to be digitized by Analog-to-digital converters (ADC) before sampled while the Resolver and Hall-effect sensors are read directly.

#### Robotic Hand

The Compliant Low-Cost Antagonistic Servo Hand (CLASH) [8] is a sensorized robotic hand which can handle soft objects such as strawberries. It weighs 640 g and can hold a maximum payload of 2 Kg. It operates in 28 Vdc and it has USB interface connection. Fig. 5 shows the geometry of the robotic hand with one thumb, two fingers and the main body of the hand (including the palm on the top of the main body close to the thumb and fingers).

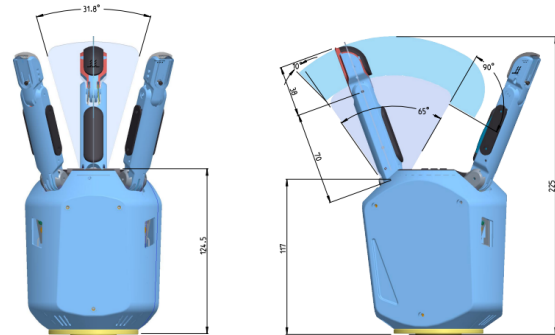

Figure 5: The Robotic CLASH Hand.

The electronics architecture of the CLASH hand includes two microcontrollers (Atmel Mega32U4) which can control the servo motors (Bluebird BMS-3900 MH) with Pulse-width modulation (PWM) signal. One is dedicated to the thumb and another to the two fingers. They calculate the fingers and thumb position (via the Potentiometer values) and the tendon forces (via Hall sensors lever angles). The palm has a sensor board equipped with an Inertial Measurement Unit (IMU) to get the orientation values of the hand, a proximity sensor to identify the objects before they are grasped, and a piezoresistive tactile sensor to provide data from fingers and thumb once the object is gripped. These sensors ensure accurate torque-based control and allow the target object to be lifted without being damaged. The communication via USB provides payload packets of 32 bytes in both directions and data rate of 1 kHz.

#### Rail System

The eXtended Transport System (XTS) rail system from Beckhoff is a modular rail system which can be mounted in different configurations. Particularly for our application, the

22 motor modules and guidance rails will be configured in L-shape. This will allow that the robotic arm can drive in the entire 5 m longitudinal extension of the FEG greenhouse and can be stowed in a parking position when not in use. Two 10-pole magnetic movers and one mounting plate can hold the assembly composed by the robotic arm, the camera and the robotic hand. The two movers are expected to move with the velocity up to 10 cm/s. The entire system weighs about 145 Kg and operates with 48 Vdc (power) and 24 Vdc (control). The communication protocol is EtherCAT and the control of the rail system is carried out by a dedicated industrial Programmable Logic Controller (PLC).

### Camera

The camera system Azure Kinect DK has a sophisticated computer vision capability. It includes two cameras: one 1-MP depth sensor and one 12-MP RGB camera. It also has an accelerometer and an IMU for sensor orientation and spatial tracking. The image frequency range this camera provides is from 5 to 30 frames per second (fps). This camera is integrated to the wrist of the robotic arm and supports its manipulation as well as the hand grasping task. Its power consumption is around 6 W and the communication interface is USB.

### Software Architecture

The software architecture for the EVE system is described as follows (Fig. 6). The main agents involved in the task execution process are the Graphical User Interface (GUI) in a mission control remote computer, the DHCS OBC installed in the EDEN LUNA greenhouse, the EVE real-time computer, the rail system PLC with the rail controller, and the hardware parts of the EVE system (rail system, robotic arm, robotic hand, and camera).

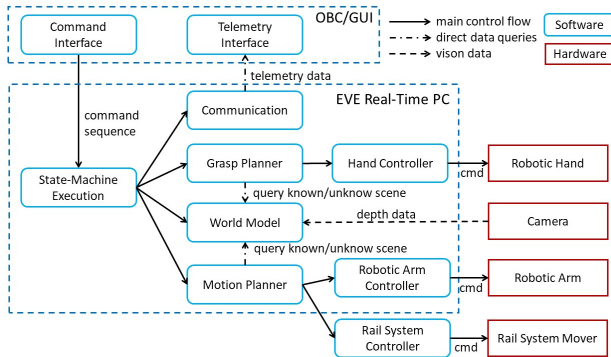

**Figure 6:** Software architecture for the EVE system interacting with the hardware components.

The operator seating in the mission control room sends a command through the *Command Interface* with specific parameters to the EVE real-time computer which is inside the EDEN LUNA greenhouse. This command sequence is first encapsulated to PUS-CCSDS packets, then reaches the DHCS OBC through the communication network, and finally is routed to EVE real-time computer. These packets are de-encapsulated before reaching the *State-Machine Execution* which manages and controls individual components of the EVE system. Apart from the control flow, the data collected through the *Camera* (depth data) is stored in the *World Model*. This software piece also stores the prior known environment based on CAD models. The state-machine execution selects the information from environment (known/unknown) and match them with the command sequence. Then, it queries

the *Motion Planner* and the *Grasp Planner* to compute the safe motions of the robotic arm, the rail system, and the robotic hand. The collision avoidance is determined by the queries from the motion planner and the grasp planner to the world model. The calculated motions are forwarded to the *Robotic Arm Controller*, the *Rail System Controller*, and the *Hand Controller*. The outputs from these controllers accurately move the two *Rail System Movers*, the *Robotic Arm*, and the *Robotic Hand* to accomplish the task commanded. The sequence of steps carried out in the state-machine and the housekeeping data are gathered in the *Communication* framework. It then routes this telemetry data (with same initial data encapsulation/de-encapsulation process) to the remote computer where it can be read through the *Telemetry Interface*.

## 4. AUTONOMOUS ROBOTIC OPERATIONS CONCEPT

### Operations

To understand the sequence of steps the EVE system will perform when in operation, first we need to have a close look in the plant cultivation phases and which tasks are required in each phase.

Fig. 7 give us the idea of the four different plant cultivation phases which will be developed in a period of approximately four months: germination, transfer, growth, and harvesting. During germination, the seeds are placed on the rock wool plugs. In the transfer phase, the tray carrying the rock wool plugs are moved to the shelf where the plants will grow. During the growth phase, maintenance activities such as cleaning, cutting and monitoring are carried out. Finally, during harvesting, vegetables, fruits, and leaves are collected. The basic functionalities of the EVE system can support plant cultivation in these different phases. EVE is capable of handling the rock wool plugs in the germination phase, manipulating the trays during the transfer phase, monitoring the crops during the growth phase, and grasping fruits and vegetables in the harvesting phase. Although there are a few limitations of the EVE system such as grasping seeds, cleaning, and cutting leaves, we are developing solutions to bridge these gaps. In the germination phase, a suction pump tool is foreseen to place the seeds inside the rock wool plugs. In the growth phase, this same tool can help with the cleaning tasks by removing old fallen leaves. In addition, a cutting tool will be implemented to cut leaves either in the growth or harvesting phase.

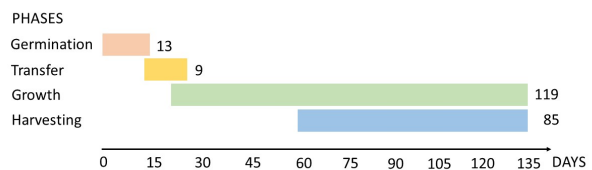

**Figure 7:** Plant Cultivation phases and duration.

The task execution process is displayed in Fig. 8. The command triggered by the operator initiates the execution (H1). This initial command normally contains the target location and the type of task to be executed by the EVE

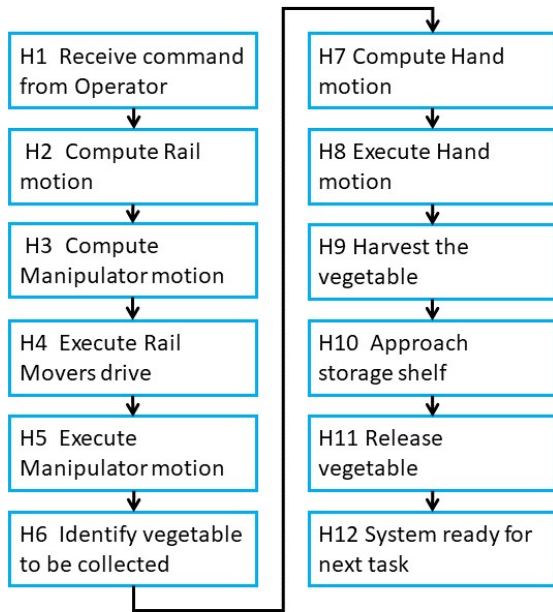

**Figure 8:** Operational steps for the EVE system. Harvesting task example.

system. The EVE system software computes the two rail movers and the manipulator motion (H2 & H3) planning the best trajectories to reach the target shelf where the plants are located. Then, the execution of the two rail movers and manipulator movement is carried out (H4 & H5). Once the manipulator is in position (in front of the plant on the target shelf), the camera needs to provide an image (depth data) to the robot so the identification of the vegetable is executed (H6). The information provided is the input to the calculation of the hand motion (H7) and its subsequent movement (H8). The hand's fingers then close touching the vegetable and applying the correct force to harvest it (H9). With the vegetable collected, the EVE system approaches the storage shelf where all the harvested vegetables are placed (H10). It releases the vegetable by opening the hand fingers (H11), and finally it is ready for the next task (H12) in standby mode. If in this last step, there is no task to be executed, the EVE system will return to the parking position (stowage area in the upper corner of the EDEN LUNA greenhouse).

#### Shared-Autonomy

The concept of shared-autonomy means that we keep the human in the loop in the process of the EVE task execution. With the operator focused on the task solution (high level goal) rather than operating the robot, the low level task execution is performed using the local intelligence of the robotic system [9].

As previously stated in the software architecture description (Sec. 3), the state-machine execution is a key element to enable the autonomous functionality of the EVE system. This hierarchical state-machine framework, which includes models of robotic skills or capabilities, orchestrates and controls the several EVE components [10]. A certain robotic skill such as *harvest vegetable* can be decomposed in a few subsets of state-machines: drive rail mover, move arm, identify object, and grasp object. These subsets are connected via control and data flow lines in a logical sequence which allows the task to

be completed. Skills and subsets can be reused and combined in different manners to execute various tasks. This essential piece of the software is constantly interacting with the world model for environment knowledge, the motion planner for safe motion, and the robot controller for actual task execution. Although part of the decision-making process happens locally in the robotic system, the human as mission planner has the authority to make the most important decisions.

#### Motion Planning

One of the requirements of the EDEN LUNA project is that the EVE system shall not collide with its own parts nor the environment when executing a task. Therefore, the motion planner computes collision free motions of the robotic system to ensure that the robotic hand reaches the commanded target coordinates. This computation relies on an algorithm [11] which finds an optimal solution in a high dimensional search space considering the non-linear kinematics of the system and constraints such as joint torque limits. As briefly explained in the software architecture (Sec. 3), the motion planner queries the environment information from the world model. Then, all world model geometric representations are loaded into a common scene graph and potential collisions between the robot and the environment are verified. After this verification, the robot selects the optimal path and executes it. Fig. 9 shows a set of motions calculated by the motion planner when harvesting a vegetable and bringing it to the storage tray. For this reason, we see two arms in the figure. They represent the initial and final positions of the trajectory the entire system performs to accomplish this step of the task.

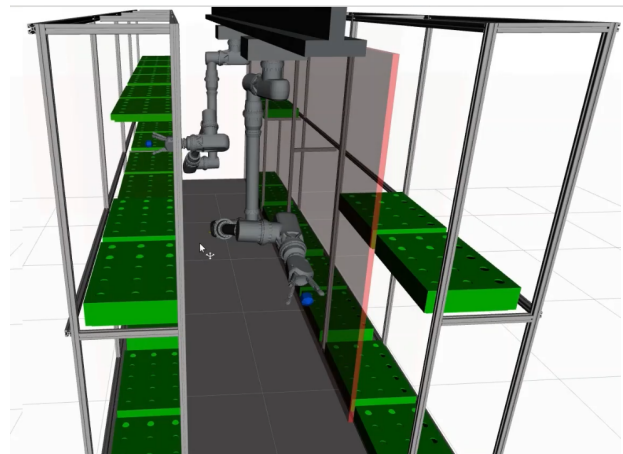

**Figure 9:** EVE motion when harvesting a vegetable and bringing it to the storage tray, computed by the Motion Planner.

## 5. ROBOTIC CONTROL LEVELS

The EDEN LUNA project exemplifies the intricate interplay between a controlled environment and automation systems which navigate and interact within it. At the core of this project lies a greenhouse, which serves dual roles:

1. **Static Components:** The mechanical structure and other non-changing elements.
2. **Dynamic Components:** The living organisms, primarily the plants, which evolve over time.

Considering these prerequisites, we describe and explain the different control levels, their main agents and their interconnections (Fig. 10).

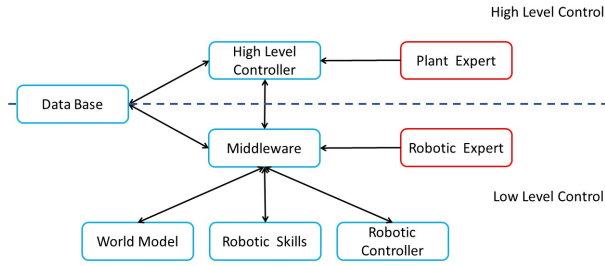

**Figure 10:** Robotic Control Levels and its interactions.

### Data Generation in the Greenhouse

The greenhouse, as an entity, generates a significant amount of data. This data is derived from various sources such as the watering system, and the cameras strategically placed within the environment. On a more granular level, individual plants also contribute to this data pool. The plants, from the moment they are seeded, grow and undergo daily changes which need to be closely monitored. This data needs to be stored in a *Data Base*.

### Robot-Plant Interaction

A typical scenario involves the development of fruits or vegetables on plants, such as tomatoes. Once these tomatoes reach maturity, or become ripe, the system must recognize and categorize them. The robot is then tasked with identifying these mature tomatoes, ensuring they are tracked logically so that they can be accessed when necessary. Once ripe, these tomatoes must be harvested. The robot, equipped with a precise motion planner, ensures that its movements avoid any collision within the greenhouse. Here we see the interactions of the *World Model*, *Robotic Skills*, and *Robotic Controller* in the low level control.

### Motion Planning and Task Execution

To achieve seamless movement and task execution, a *world model* of the entire greenhouse was developed. This model aids the motion planner in predicting and planning robot motions, ensuring safety and efficiency. However, motion alone is not enough. The robot must be aware of its tasks. A skill set was devised, detailing each task the robot might need to undertake. For instance, if the robot needs to harvest a specific tomato, it references the world model and data base to locate the tomato, approaches it, and then employs the grasp skill to collect it. In this case, the elements of the low level control interact with the data base.

### Human-Robot Interaction

While automation is a key component, human intervention remains essential. The humans and the robot communicate via a defined *Middleware*. For instance, an operator might peruse the data base, identify a ripe tomato, and then instruct the robot to harvest it. Given the volume of data the greenhouse generates, this method is feasible only for specific tasks or when anomalies occur. For daily operations, a *high level controller* is indispensable. This controller continuously scans the data base, identifies tasks such as ripe tomatoes needing harvesting, and instructs the robot accordingly.

However, the inherently non-deterministic nature of plants dictates the necessity of human oversight. An interactive visual interface allows humans (*Plant Expert*) to adjust thresholds, monitor plant behavior, and dynamically assign new tasks to the robot if any are overlooked. Here, elements of the high level control and low level control are interacting.

In conclusion, the EDEN LUNA project is a testament to the intricate multi-layered control challenges in modern agriculture. At each level, data is both generated and acted upon, making it a unique and groundbreaking endeavor.

## 6. DISCUSSION

In this section we discuss the EVE system capabilities, the potential scenario with a deployment on the Moon, and a brief trade-off analysis between the DOFs of the robotic arm and its mass.

### EVE Capabilities

From the EVE subsystems description to the autonomous operations concept and the different robotic control levels, we were able to understand what the EVE system can do in the EDEN LUNA greenhouse. To have a good overview of these capabilities presented in the paper, we summarized them in Table 1. The five highlighted capabilities are: the *plant cultivation task execution*, the *shared autonomy*, the *high manipulability*, the *modularity*, and the *versatility*.

They are critical for the EDEN LUNA project functionality and for what is expected from a robotic system operating inside a greenhouse. However, the system flexibility does not tie it to a single application. It can also be adapted to different applications foreseen in a future Moon base.

**Table 1:** The EVE Capabilities.

Capabilities	Description
Plant Cultivation Task Execution	Handle plugs (germination), manipulate trays (transfer), monitor crops (growth), harvest fruit/vegetable (harvesting)
Shared Autonomy	Initial command (operator) triggers autonomous operation
High Manipulability	Ability to operate in a highly constrained space
Modularity	Rail system & robotic arm different configuration (by design)
Versatility	Perform different tasks, installation in diverse structures, exchange end-effector

### Deployment on the Moon

As explained previously, the EDEN LUNA project foresees the implementation of the EVE system in an analogue environment. Therefore, as the EDEN LUNA greenhouse is

an evolution of the EDEN ISS project, the next step is the development of a design towards the space qualification and integration to available space launchers and lunar landers. The EDEN NG, which was presented in Sec. 2, is this long-term concept to incorporate the technology used in the EDEN LUNA greenhouse to a space system context. The EVE system, as part of the EDEN LUNA greenhouse, will also be adapted and space qualified for this potential opportunity to fly into space. Currently, only the robotic arm has started the space qualification process.

In a baseline mission scenario as described in [6], the EDEN NG greenhouse would be launched with the existing launch vehicle Falcon 9 and then dock with a transfer vehicle using orbital stage. Once it arrives on lunar orbit, it would dock to a lander to soft-land on the surface. A scaled-up scenario is foreseen with the launch of subsequent missions. The greenhouse modules would be connected to each other forming an agricultural complex to cultivate plants and provide food to the astronauts. As the EVE system is part of the infrastructure of the greenhouse, it would be integrated to the ceiling of the module on Earth. The robotic arm of the EVE system stays in the parking position (stowage area dedicated to the robotic arm) during launch, transfer and landing phases. Once the greenhouse is deployed on lunar surface it can start operation similarly to the operational steps designed for the EDEN LUNA project.

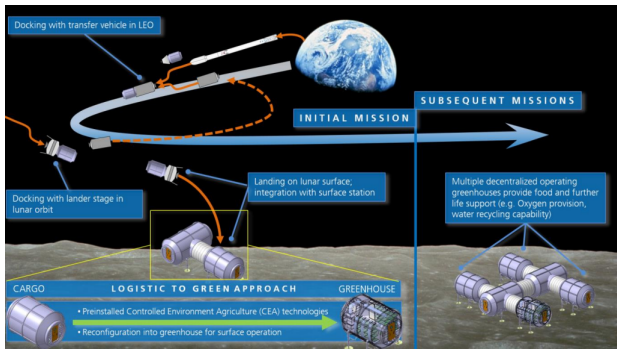

**Figure 11:** Baseline mission scenario with the deployment of the greenhouse on the lunar surface [6].

### Trade-off DOF vs Mass

We use a 7-DOF robotic arm to perform the plant cultivation tasks in the EDEN LUNA project because this configuration allows a high degree of manipulability and versatility in a very constrained space: the greenhouse. Also, we have proven in past DLR projects [12][13] that robotic manipulators with such degree of manipulability can perform several tasks with precision as close as humans would perform them. However, the modularity of this robotic arm allows us to reconfigure it (by design) with a lower amount of DOFs. Therefore, we can have a trade-off analysis between the amount of DOFs and the mass of the robotic arm, even though the robotic arm corresponds only to 10 % of the EVE system total mass and 0.1 % of the greenhouse total weight. This analysis is presented in Table 2 with the amount of DOFs, the robotic arm mass, the launch cost to Low Earth Orbit (LEO) and to the Moon, and the degree of manipulability.

We considered that the mass of each joint of the robotic arm is 1.9 Kg, the payload cost to send a cargo to LEO 20 kUSD/kg [14] while the cost for the Moon 2000 kUSD [15]. As the manipulability analysis is very extensive and would constitute a separate study by itself, we simplified the classification of

the manipulability degree as low, medium, high and very high.

**Table 2:** Trade-off Analysis DOF vs Mass.

	4-DOF	5-DOF	6-DOF	7-DOF
Weight (Kg)	12	14	16	18
Cost LEO (kUSD)	240	280	320	360
Cost Moon (kUSD)	24000	28000	32000	36000
Manipulability	Low	Medium	High	Very High

It is possible to see that while the saving by reducing the mass of the robotic arm for LEO is not so high (only 40 kUSD per DOF), for the lunar surface it can impact the budget depending on the mission (4000 kUSD per DOF). One can always argue that the high investment is valid to avoid limitations during mission operations. We believe that based on the complexity of a lunar mission and the diversity of activities foreseen in a future moon base, the use of a 7-DOF arm is applicable. It will not only be able to accomplish tasks in constrained spaces, but also serve different applications. With its versatility, it can be integrated to warehouses, mining facilities, and supporting landers. In addition, the indirect costs that a limited robotic arm with low degree of manipulability can generate in a such challenging environment should not be ignored. A robotic arm with low DOFs forces the architecture of the structure (in this case the greenhouse) to be designed in function of the arm and not the contrary. Normally, for space missions, this is not the type of constraint that we want to have.

## 7. SUMMARY

In this work, we described our developed technologies to enable the implementation of an autonomous robotic system in a greenhouse which operates in an analogue Moon environment. This is part of the initial steps to deploy such a system on the lunar surface in the near future.

First, we introduced the EDEN LUNA project with its main subsystems and payloads, how it is part of the LUNA project, and its heritage of EDEN ISS. Then, we described the key components of the EVE system and its software architecture. We also presented the operations concept highlighting the shared autonomy functionality and the motion planning as well as the different robotic control levels and its interactions. Finally, we discussed the EVE system capabilities and the foreseen scenario of deployment on the Moon.

In conclusion, the EVE with all its functionalities represents a necessary system to ensure the sustained human presence on the Moon and beyond. It serves well the plant cultivation application employed in the EDEN LUNA greenhouse, but its versatility allows its utilization in alternative structures for logistics, resources extraction, and habitats. Also, the challenges of robot-human interaction, different levels of



control, and autonomous operation can be easily transferred to agricultural applications in extreme environments on Earth. This can be integrated to the pool of solutions to the food security challenges we face today.

The EVE system is currently in development at the DLR Robotic and Mechatronics Center in Oberpfaffenhofen. In 2024, it will be integrated to the EDEN LUNA Greenhouse at the DLR Institute of Space Systems in Bremen. By the end of 2025, it will start operations in the ESA/DLR LUNA facility at the European Astronaut Centre (EAC) in Cologne.

## ACKNOWLEDGMENTS

The authors, the entire LUNA and EDEN LUNA project team, want to acknowledge and thank the government of North Rhein Westphalia for the funds received to finance the outfitting of the LUNA facility. We also thank all the colleagues not mentioned in the author list and partners who have contributed to this project.

## REFERENCES

- [1] ISECG, “Global Exploration Roadmap,” *International Space Exploration Coordination Group*, 2018.
- [2] P. Zabel, M. Bamsey, D. Schubert, and M. Tajmar, “Review and analysis of over 40 years of space plant growth systems,” *Life Sciences in Space Research*, vol. 10, pp. 1–16, 2016.
- [3] A. E. M. Casini, P. Mittlera, J. Schlutz, T. Uhlig, F. Rometscha, L. Ferra, A. Cowley, and B. Fischer, “Lunar missions’ simulations in analogue facilities: the operational concept and the first commissioning of the esa-dlr luna facility,” in *Proceedings of the International Astronautical Congress (IAC)*. International Astronautical Federation, 2022.
- [4] P. Zabel, C. Zeidler, V. Vrakking, M. Dorn, and D. Schubert, “Biomass production of the eden iss space greenhouse in antarctica during the 2018 experiment phase,” *Frontiers in Plant Science*, vol. 11, 2020.
- [5] —, “Crewtime in a Space Greenhouse based on the Operation of the EDEN ISS Greenhouse in Antarctica,” in *49th International Conference on Environmental Systems*, 2019.
- [6] V. Maiwald, K. Kyunghwan, V. Vrakking, and C. Zeidler, “From Antarctic prototype to ground test demonstrator for a lunar greenhouse,” *Acta Astronautica*, vol. 212, pp. 246–260, 2023.
- [7] M. Maier, T. Bahls, R. Baver, M. Bihler, M. Chalon, W. Friedl, N. Hoeger, C. Hofmann, A. Kolb, A. M. Sundaram, M. Pfanne, H.-J. Sedlmayr, and N. Seitz, “TINA: The Modular Torque Controlled Robotic Arm - A Study for Mars Sample Return,” in *2021 IEEE Aerospace Conference (50100)*, 2021, pp. 1–10.
- [8] W. Friedl and M. A. Roa, “CLASH — a compliant sensorized hand for handling delicate objects,” *Frontiers in Robotics and AI*, vol. 6, 2019.
- [9] D. S. Leidner, *Cognitive Reasoning for Compliant Robot Manipulation*. Springer, 2019.
- [10] S. G. Brunner, F. Steinmetz, R. Belder, and A. Dömel, “Rafcon: A graphical tool for engineering complex, robotic tasks,” in *2016 IEEE/RSJ International Confer-*

*ence on Intelligent Robots and Systems (IROS)*. IEEE, 2016, pp. 3283–3290.

- [11] P. Lehner, R. Sakagami, W. Boerdijk, A. Dömel, M. Durner, G. Franchini, A. Prince, K. Lakatos, D. L. Risch, L. Meyer, B. Vodermayr, E. Dietz, S. Frohmann, F. Seel, S. Schröder, H.-W. Hübers, A. Albu-Schäffer, and A. Wedler, “Mobile Manipulation of a Laser-induced Breakdown Spectrometer for Planetary Exploration,” in *2023 IEEE Aerospace Conference*, 2023, pp. 1–19.
- [12] G. Hirzinger, A. Albu-Schaffer, M. Hahnle, I. Schaefer, and N. Sporer, “On a new generation of torque controlled light-weight robots,” in *Proceedings 2001 ICRA. IEEE International Conference on Robotics and Automation (Cat. No.01CH37164)*, vol. 4, 2001, pp. 3356–3363.
- [13] C. Schlenk, T. Bahls, S. Tarassenko, J. Klodmann, M. Bihler, and T. Wuesthof, “Robot Integrated User Interface for Physical Interaction with the DLR MIRO in Versatile Medical Procedures,” *Journal of Medical Robotics Research*, vol. 0, pp. 1–10, 2013.
- [14] H. W. Jones, “The Recent Large Reduction in Space Launch Cost,” in *48th International Conference on Environmental Systems*, 2018.
- [15] Astrobotic, “Peregrine Lunar Lander Payload User’s Guide,” in *Astrobotic*, 2018.

## BIOGRAPHY



**Andre F. Prince** received his M.Sc. degree in Mechatronics Engineering from the Politecnico di Torino, Italy in 2020. Since then, he has been working in the Robotics and Mechatronics Institute at the German Aerospace Center (DLR) as Mechatronics engineer. He has contributed to the firmware development of the Martian Moons Exploration (MMX) rover’s locomotion subsystem. He has worked on the mechatronics interfaces, power management and data handling systems in the multi-robot ARCHES project. Within EDEN LUNA, he is the system engineer responsible for the design, development and integration of the EVE system. His fields of interest are electronics communication, motor control, and power electronics within robotic planetary exploration.



**Jean-Pascal Lutze** received his B.Eng degree in Robotic and Automation from Heilbronn University of Applied Sciences. Since 2017, he is part of the Institute of Robotics and Mechatronics at the German Aerospace Center (DLR). He obtained his Master degree in Robotics, Cognition, Intelligence at the Technical University of Munich (TUM) in 2022. His main research focus is space robotics.



**Maximilian Maier** is working as project manager, electrical engineer and group leader at the German Aerospace Center (DLR) since 2009. He contributed to the electronics of the MASCOT asteroid lander. He is currently the project manager of TINA, a modular robotic arm for exploration and small satellite missions. His current research interests include haptic devices, robotic arms and hands

for space missions.



**Werner Fredl** received his Dipl.-Ing.(FH) in Mechatronic at the University of Applied Sciences in Munich and starts at DLR in 2004. In 2006 he developed the torso of DLR Humanoid Justin. In the DLR Hand-Arm- project he developed the forearm of the AWIWI hand and AWIWI II. Since 2015 he is responsible for the mechanical hand development at DLR. His main research focus includes

variable stiffness actuation, tendon driven hands and grasping.



**Daniel Leidner** received his diploma degree in communications engineering in 2010, and his M.Sc. degree in information technology in 2011 with distinction from the Mannheim University of Applied Sciences, Mannheim, Germany. In 2017 he received the Ph.D. degree in artificial intelligence from the University of Bremen, Bremen, Germany. His dissertation was honored with the

Georges Giralt PhD Award as well as the Helmholtz Doctoral Prize. He is currently leading the Rollin Justin Team and the Semantic Planning Group at the Institute of Robotics and Mechatronics, German Aerospace Center (DLR), Wessling, Germany. As Co-Investigator of the Surface Avatar experiments, he investigates artificial intelligence in the context of astronaut-robot collaboration.



**Claudia Philpot** holds a diploma degree in Aerospace Engineering and is the Project Manager for EDEN LUNA. Her expertise as a satellite operations engineer for Galileo IOV and Eu:Cropis in Industry and Research as well as ESA-DLR programmatic experience in Industry-Driven ISS utilization (GoSpace) supports her role. She has completed several experiments on ISS

such as Wireless Compose and SpaceTex.



**Vincent Vrakking** received his M.Sc. degree in Aerospace Engineering from the Delft University of Technology in the Netherlands. Since 2015 he is part of the German Aerospace Center's Institute of Space Systems in Bremen, Germany, working on Bio-regenerative Life Support and Controlled Environment Agriculture systems within the Planetary Infrastructures research group. He previously worked on EDEN ISS, contributing to the subsystem design, focusing primarily on the structure design and

configuration. Currently, he is the system engineer for the EDEN LUNA project. His research interests include CEA technologies, and habitat-greenhouse interface design.

configuration. Currently, he is the system engineer for the EDEN LUNA project. His research interests include CEA technologies, and habitat-greenhouse interface design.



**Eugen Ksenik** received his Dipl.-Ing. (FH) in Aerospace Engineering at the University of Applied Sciences in Aachen in 2008 and starts at the German Aerospace Center (DLR) in 2009. Since then he has worked in several projects (MASCOT, HP3 Insight, ROBEX and ReFEx) as mechanical engineer and AIV engineer. With great experience in CAD design, structures and configuration,

he is the mechanical engineer responsible for the EDEN LUNA greenhouse configuration in the EDEN LUNA project.



**Daniel Schubert** studied at the Technical University of Berlin and has an engineering diploma in industrial engineering with an emphasis on aerospace and production techniques. In 2011, he initiated the EDEN group at the DLR Institute of Space Systems for technology investigations on Bio-regenerative Life Support Systems and since served as the team leader of this group. His research

expertise is set on habitat interface analysis and plant accommodation and dynamic plant production planning. Through-out many projects for ESA, EU, Bundesministerium für Bildung und Forschung (BMBF), Wirtschaftsförderung Bremen (WfB), Dr. Schubert proved his management- and team leading skills. Outstanding is the EDEN ISS project. He led this project with 15 international partners, including the organization of the deployment mission of the greenhouse system at the Antarctic research station Neumayer III in 2017/18.