



MANGEMENT OF TURF IRRIGATION SYSTEM UNDER USING GRAY WATER

[14]

Shimaa, E. Abd Elfattah, Abdel-Aziz, A.A. and El-Bagoury K.F.

Agric. Engineering Dept., Fac. of Agric., Ain Shams Univ., P.O. Box 68 Hadyek Shoubra 11241,
Cairo, Egypt

*Corresponding author: shimaa20130@gmail.com

Received 10 February, 2019,

Accepted 5 March, 2019

ABSTRACT

This research aimed to obtain identify the effect of low-quality water (gray water) (reused water after its nomination in the special filtration stations) on the performance analysis of the turf irrigation system. The Experiment was carried out at EL-Rhap site, the area under investigation was 450 m², it was divided into 6 plots, and the geometrical has 5 m × 15 m. Investigated variables were gray water and tap water plots were; have been while the investigated parameter was the percentage of the applied amounts of irrigation water with a percent of 100%; 85%; 75%. The response of plant growth landscaping parameters due to irrigation water types were color, length, density and its coverage on the after heads, the effect of gray water and fresh water on the turf irrigation system was compared through the study of (uniformity, Surface roughness, Clogging ratio, flow, pressure), of sprinklers during same the irrigation period. Results of the applied could be summarized as followed.

The Accumulative clogging ratio by using gray water was (1.50 – 1.56 – 1.6) % and tap water was (1.22 – 1.25 – 1.28) % at (100% - 85% - 75%) of quantity the water required for the plant. Illustrates in tap water turf quality rate was (8.50 – 8.00 – 8.00) for color, very good quality rate was (8.00 – 8.00 – 7.50) for density also very good ground cover quality rate was (8.00 – 7.50 -7.50). Meanwhile, illustrates in gray water turf quality rate was (8.50 – 8.50 – 8.00) for color, very good quality rate was (8.50 – 8.00 – 8.00) for density also very good ground cover quality rate was (8.00 – 8.00 – 7.50) at (100% - 85% - 75%) of quantity the water required for the plant. Surface roughness in the

main irrigation lines was measured after the use of gray water and tap water. The erosion was (17.93– 65.35) Mm and the sediments were (15.48 – 58.22) Mm in gray while the erosion of tap water was (10.45– 34.89) Mm and the sediments were (9.06– 45.22) Mm.

Keywords: sprinkler system, gray water, landscape, turf grasses.

INTRODUCTION

Insufficient water supply is as yet one of the major challenges in developing countries specially arid and semi-arid condition. The Joint Monitoring Programmed (JMP) for Water Supply and Sanitation, implemented by the World Health Organization (WHO) and UNICEF, reports that 783 million people in the world (11% of the total population) have no entrance to safe water, 84% of whom live in rural areas. Around 187 million people use surface water for drinking purposes; 94% of them are rural inhabitants and they are concentrated in sub-Saharan Africa (**Sorlini et al 2013**). The increased water use is largely for landscape irrigation. Therefore, irrigating landscapes with reclaimed water can conserve tremendous amounts of fresh water. Reclaimed water and other non-potable waters have been used for decades for irrigating field crops and landscapes such as golf courses, landscapes, and parks in many areas of the United States (**Pedrero et al 2010**)

Gray water signifies wastewater that incorporates water from showers, showers, hand bowls, clothes washers, dishwashers, and kitchen sinks, yet rejects streams from toilets. A few creators avoid kitchen wastewater from the other Gray water streams. Wastewater from the washroom, in-

cluding showers and tubs, is named light dark water. Gray water that incorporates increasingly tainted waste and from clothing offices, dishwashers and, in a few occasions, kitchen sinks is called dull dark Gray water (Albalawneh and Chang, 2015). However, municipalities in the southwest have encouraged the use of reclaimed water for landscape irrigation, because municipal water consumption increases two- to twofold in summer months compared with the winter season.

Turf grass lawns are now a central part of urbanized landscapes throughout North America. It is estimated that total turf grass area, including residential, commercial, and institutional lawns, golf courses, Estimated 163,800 km² in the U.S., and this area is expanding because of rapid urbanization. In Ohio, there was nearly 0.97 million ha of turf in 1989. With highly developed root system and dense shoots above ground, turf grass provides many environmental benefits, including soil erosion control, water runoff and leaching reduction, contributing to carbon sequestration, moderating temperature, lessening noise, glare, and visual pollution .often schedule -based applications of water-soluble fertilizers and pesticides. (Cheng et al 2008)

Irrigation from a pop-up sprinkler system has become the accepted practice for irrigating turf grasses. Pop-up systems can provide high-quality turf and can also help conserve water if they provide uniform and efficient irrigation. However, An efficient irrigation system avoids unnecessary losses due to wind drift, surface runoff, deep percolation, and evaporation from standing water, which occurs when application rates do not match infiltration rates or the soil water-holding capacity. To ensure uniform irrigation and water spray patterns that match the shape of the area, equal consideration must be given to the hydraulics(water pressure and flow, pipe sizing) and to sprinkler head configuration (triangular vs. square configuration), spacing (head to head), and nozzle selection. In a rectangular lawn, for example, nozzle sizes should be "matched" so that corner sprinklers(which cover a 90o arc) and edge sprinklers (which cover a 180o arc) have stream rates that are 25% and half separately, of full circle sprinklers (which cover a360o arc). (Leinauer and Smeal, 2012)

Water management includes using the perfect amount of water, in the right place, at the right time. Using a water budget program, whether it is on the computer or a simple hand written tracking sheet is an excellent way to make sure the amount

of water you're using is within the budget for a particular site. (Juan G, 2014)

The objectives of this study are

1. The aim of this study is to know the effect of using gray water on turf grass and on the irrigation network, evaluate amounts of irrigation water, which can be provided using scheduling system.
2. Study the effect of gray water on the network distributors (sprinkler) such as (pressure- flow - roughness - clogging radlios etc) .

MATERIALS AND METHODS

Materials

* In this experiment, Gray water and fresh water used to identify the effect of them on the turf grass and the sprinkler irrigation network.

Experiment Location

The experiment was conducted Al Rehab Gate 6, Cairo at 30°3'13"N 31°29'26"E

Soil properties and irrigation water analyses

Samples of representative soil were collected from different parts of the experimental site. The similar depths of the soil samples were mixed thoroughly and a composite sample were taken for each depth for different analyses. Some of the physical and chemical properties of the experimental soil as show in **Table (1)**.

Table 1. Some soil properties of AL-Rhap site when using gray water.

Soil properties	parameter	Value
Soil-mechanical Analysis and Hydro-physical.	As (g/cm ³)	1.37
	FC (%)	11.24
	WP (%)	6.44
	AW (%)	4.80
	Coarse Sand	50.32
	Fine Sand	46.62
	Silt + Clay	3.06
	Organic Mater (%)	2.34
	pH	7.5
	EC (ds/m)	1.45

F.C: Field capacity %, AW: Available water %, As: apparently density (g/cm³).

Chemical and Biological analyses of irrigation water were carried out by using the standard methods and presented in **Table (2)**. Escherichia coli (E. coli) were used as organism indicator to determine the total numbers' of pathogens in gray water, according to **(Eklund and Tegelberg, 2010)**.

Table 2. Some biological characteristics for gray water

con- tent	TPC	TCC	FC C	B. C	ymo- coccus	TF C
c/w/g	55x1 04	28x 10	0	0	20x10	.02

TPC: Total bacteria count (c/w/g),
 TCC: Total coliform count (c/w/g),
 FCC: Faecal coliform count (c/w/g),
 B.C: Bacillus ceruss (c/w/g),
 Staph: Staphylococcus(c/w/g),
 TFC: Total fungi count (c/w/g).

Irrigation network

The experiment was carried out in Al-Rehab, the area of the experiment (30 m x 15 m) divided into 6 treatments area of treatment (5 m x 15 m). The first, second and third treatment of gray water and fresh water was 100%- 85% - 75% of the water required for the plant.as show in **Fig. 1**.

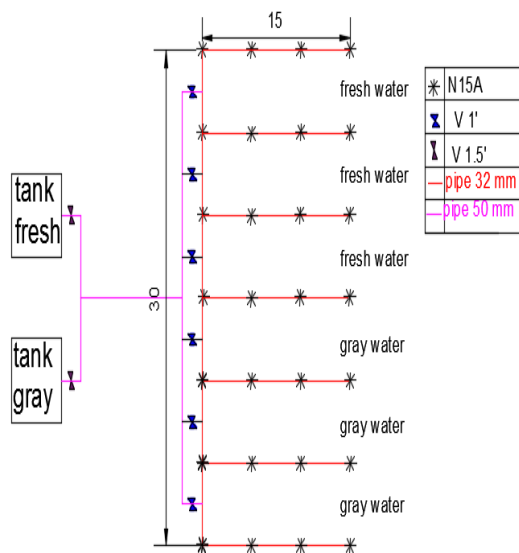

Fig. 1. layout of the experimental site turf irrigation system and water irrigation' treatments.

Irrigation network components

A- Pump: it derived by electrically motor as show in **Table (3)**.

Table 3. Technical specification of the Pumping unit

pump	Model	CM
	Flow (50Hz)	3 m3/h
	Pressure Head	10 bar/174 PSI
	Power	0.25 - 7.5 kW 0.3 Hp - 10 Hp
	Temp	-30°C - +120°C - 22°F - +248°F
Electronically Speed-controlled motor	Voltage	1*200-230 v SAV-ER, 60 Hz
		3*440-480 V SAV-ER, 60 HZ
		3*380-500 V SAV-ER, 60 HZ
		3*460-480 V 60 HZ

B- Filter: used automatic disc filter Model Nylon 1 inch with element with 2" backwash valves, controller. Automation available in 220V, with one Tank, min flow 12 m³/h, max flow 20 m³/h, filtration measurement .26 m², as show in **Table (4)**.

C- Sprinkler: used PRO Spray (pop up) nozzle 15A Black, It made of polyethylene, operated under operating pressure 2.0 bar (200 kpa) as show in **Table (4)**.

Table 4. Sprinkler, Nozzle 15A Black.

Arc	pressure		Radius M	Flow		Precip mm/hr.	
	Bar	KPa		m³/hr	l/min	■	▲
90	1.0	100	3.4	0.14	2.39	50	57
	2.0	200	4.6	0.21	3.50	40	46
	2.5	250	5.2	0.24	3.95	35	40
180	1.0	100	3.4	0.29	4.77	50	57
	2.0	200	4.6	0.42	6.99	40	46
	2.5	250	5.2	0.47	7.90	35	40

D- Control Panel: Model **ESP-Me** was used in experiment in site as show in **Table (5)**.

Table 5. Technical specifications of the Control panel ESP-Me

Support Stations	22 stations
memory	Permanently (100 year)
Station timing	from 1 minute to 6 hours
Seasonal adjust	5% to 200%
Maximum temp	149° F (65 ° C)
Features	Delay Watering up to 14 days.
	Manual Watering option by program or station
	Adjustable delay between valves (default set to 0)
	Upgradeable for Wi-Fi-based remote monitoring and control via iOS and Internet-based weather information can be used to make daily
	Internet-based weather information can be used to make daily

Description of landscaping plants

Experiment was conducted on an herbaceous plant Paspalum 10, it was green, The width was within 3-4 mm and the length was within 1 cm, It can tolerate high salinity levels In 8,000 - 10000 ppm and, It bears high temperatures, Bear with bad ventilation, Resistant to pests and insects, It grows in an average state in the shade, it will endure running and walking. Irrigation water requirement values were presented in Results.

Fertilization: The landscape are fertilized, maintained and irrigation as show in **Table (6)**.

Table 6. Periodic maintenance of the surface .

Activity	April	May	June
Cut plant	4/month	4/month	4/month
Challenges	4/month	4/month	4/month
Remove the strange	4/month	4/month	4/month
Fertilization	Urea	Micro elements	Urea
Irrigation	Daily	Daily	Daily

Calculated and Measurements experiment

A- Climate data in experiment

The data were taken from the meteorological station as show in **Table (7)**.

Table 7. Climate data of experiment location in EIRhap

Month	Min Temp	Max Temp	Humidity	Wind	Sun	Red	Eto
	c	C	%	Km/day	hours	Mj/m ² /day	mm/day
April	14.70	32.00	32.1	397.4	9.71	23.26	7.03
May	17.50	34.20	29.10	371.5	10.69	25.81	8.44
June	20.40	34.40	31.10	319.7	11.67	27.76	9.06

Temp. Min: Minimum temperature in C;

Temp. Max: Maximum temperature in C;

Eto : Value of evaporation, Sun shine fraction in percentage; Wind speed at 2 meter above the surface in m/s and Eto = Reference evapotranspiration in mm/d (**FAO, 2001**).

B- Calibration sprinklers

Show that the relationship between pressure (kpa) and flow rate (l / h). When the pressure is 150, 200, 250 when the bow (90) and arc (180) in AL-Rhap when using fresh water and gray.

C- The validity of irrigation water on turf grasses.

Measuring the effect of gray water and fresh water on turf grasses in AL-Rhap use on the plant in terms of color, density, and ground cover as show in **Table (8)** Indicates turf quality index and represents color, density, and ground .

Table 8. Cover percent for lawn plant (paspalum). (**Khaseeva, 2013**)

Type of turf	Color	Density	Ground cover
Paspalum	0-9	0-9	1-9

E- Measurement of surface roughness

Pipes samples were taken from different parts of the network (main lines - sub main lines - manifold lines), five grinding operations were carried out at the cutting site to study surface roughness after 3 months. The samples were placed under electronic microscope with zoom (1:1000), to study the roughness on part of the circumference of the pipes by a distance, in the production Laboratory of Faculty of Engineering.

Methods

Estimating water needs for landscape plantings

Costello et al (1993) derived plant water requirement on ETo as a reference to a cool-season grass species with a specified height (typically 7-15 cm tall) under particular growing conditions, this reference must be adjusted to better fit the plant water requirement of a specific plant species in the landscape setting. The landscape coefficient KI is used to adjust ETo to determine the plant water requirement (PWR) of a specific plant species.
 $KI = Ks \times Kmc \times Kd \dots\dots\dots(1)$

Where:

- KI = Landscape coefficient (dimensionless).
- Kmc = Adjustment factor for microclimate influences upon the planting (dimensionless)
- Ks = Adjustment factor representing characteristics for a particular plant species (dimensionless).
- Kd= Adjustment factor for plant density (dimensionless).

Awady et al. (2003) used two formulas to estimate water needs for landscape plantings:

- The landscape evapotranspiration formula and,
- The landscape coefficient formula.

Water needs of landscape plantings can be estimated using the landscape evapotranspiration formula:
 $ETI = KI \times ETo \dots\dots\dots(2)$

Estimating of irrigation requirements

From the following equation (**Abrol et al1988**)

$$IR = \frac{ET_{crop} \times (LR + A)}{Ea} \dots\dots\dots (3)$$

Where

- IR = irrigation requirement, L/day; LR= Leaching requirement, (20%);
- Ea = Irrigation uniformity (68%) (Measured in the field); A= Area of tree (m²);
- ETcrop = Potential Evaporation-Transpiration.

The Flow rate

Measure the water collected from sprinkler nozzle using a 1000 ml graduated cylinder. Determine the flow rate from following equation (**Melvyn, 1983**).

$$Q = \frac{V}{T} \dots\dots\dots (4)$$

Where:

- Q = the flow rate of sprinkler in m³/h.
- V = the collecting water volume in m³.
- T = time of collecting water in h.

3-2-4- Sensitive for clogging

Emitter nozzles are designed with diameter ranging from (0.25 mm- 2.5 mm) and this cause in clogging. (**Al-Amoud, 1997**)

Following formula was used to calculate clogging ratio.

$$\text{Clogging ratio} = \left(\frac{q1-q2}{q1} \right) \times 100 \dots\dots\dots (5)$$

Where:

- Q1= Average flow rate at start up operating (l/h).
- Q2= Average flow rate at the end operating (l/h).

Distribution uniformity

Plastic catch cans 95 mm diameter; 120 mm height were located under impact Sprinkler in a quarter circle. The catch cans were distributed according to (**ASAE Standard, 2001**). Fig.8: shape of Regularity of Distribution:

$$CU = 100 * \left\{ 1 - \frac{\sum |x - x^-|}{n x^-} \right\} \dots\dots\dots (6)$$

Where:

- CU = the Christiansen's coefficient of uniformity in %.
- x = Numerical deviation of individual observation from average application rate, mm.
- x^- = mean of collectors amount in mm.
- n = number of catch cans.

Precipitation rate

The precipitation rate of sprinkler was calculated by the following formula (**James, 1988**):

$$Pr = k \frac{Q}{a} \dots\dots\dots (7)$$

Where:

- Pr= the precipitation rate in mm / h.
- Q = the flow rate of sprinkler in L/ min.
- a= the wetted area of sprinkler in m².
- K= unit constant.

Irrigation schedule when using water

The Irrigation scheduling process was started a week after the primary irrigation of cultivation. Afterwards, the irrigation was given approximately every day, in April, May and June. The total water

consumption was 1696.912 m³/fed as show in **Table (9)**.

Table 9. Irrigation water requirements in ELRhap

The month	Apr	May	June
Et _o (mm/day)	7.03	8.44	9.06
Growth period (day)	30 day	31 day	30 day
(Kc)	1	1	1
ETc (mm ³ /day)	7.03	8.44	9.06
ETc (mm ³ /month)	210.9	261.64	271.8
ETc Total (mm ³ /season)	744.34 (mm ³ /season)		
IR 100% (m ³ / season/ fed)	744.34 *(.2+1)* 4.2/.9= 4168.30 m ³ /season/ fed		
IR 85 % (m ³ /season/fed)	3543.06 m ³ /season/ fed		
IR 75 % (m ³ /season/fed)	3126.23 m ³ /season/ fed		

Calibration for sprinkler

Calibration for sprinkler relationship in between pressure and flow rate

Showed the relationship between pressure (100– 200– 250) kpa and flow rate (l/h) at arc (90°,

180°). showing an increase in flow rate by increasing pressure, where at pressure (100 – 200– 300) kpa at arc (90°) flow rate was (138.45- 201.68– 229.94) l/h, (118.64- 170.24 - 194.59)l/h and (104.34 - 152.45 - 173.29) l/h and at arc (180°) flow rate was (281.92 - 414.47 - 457.78) l/h, (240.73 - 353.42 - 389.56) l/h and (210.91 - 311.38 - 343.36) l/h in gray water at (100% - 85% - 75%) of quantity the water required for the plant. Meanwhile, the flow rate was at arc (90°) flow rate was (140.34 – 207.47– 234.37) l/h, (119.26 – 176.27 – 200.18) l/h and (106.46 – 133.68 – 174.47) l/h and at arc (180°) flow rate was (285.78– 416.34 – 471.28) l/h, (243.79 – 353.32 – 401.84) l/h and (181.65–265.93 – 300.72) l/h in tap water at (100% - 85% - 75%) of quantity the water required for the plant as show in **Figs.(2) and Fig.(3)**. Moreover the flow rate increased while the pressure increased, these data are agreement with many that had been observed (**Cesar et al 2004 and Li & Rao, 2004**).

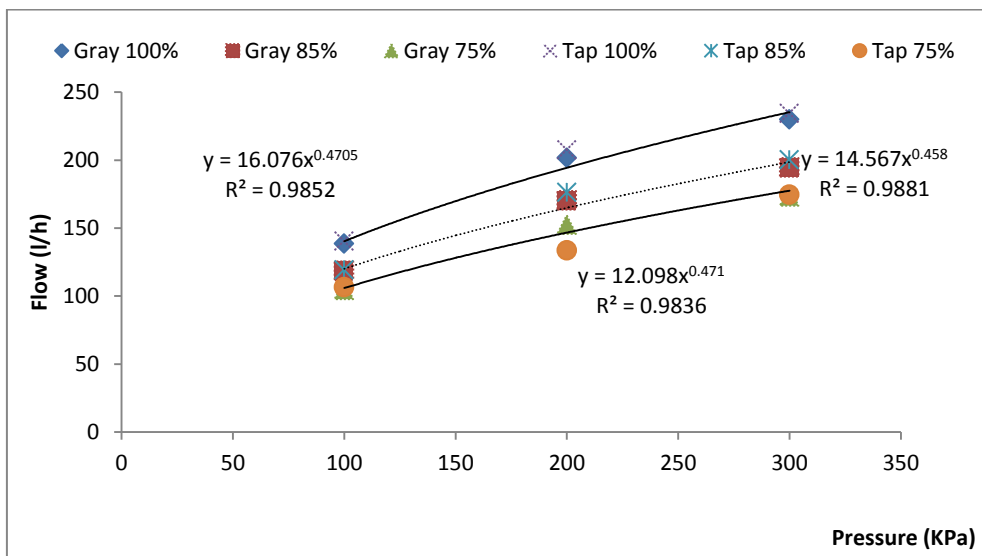

Fig. 2. Relation between pressure and flow rate in gray and tap water at arc (90).

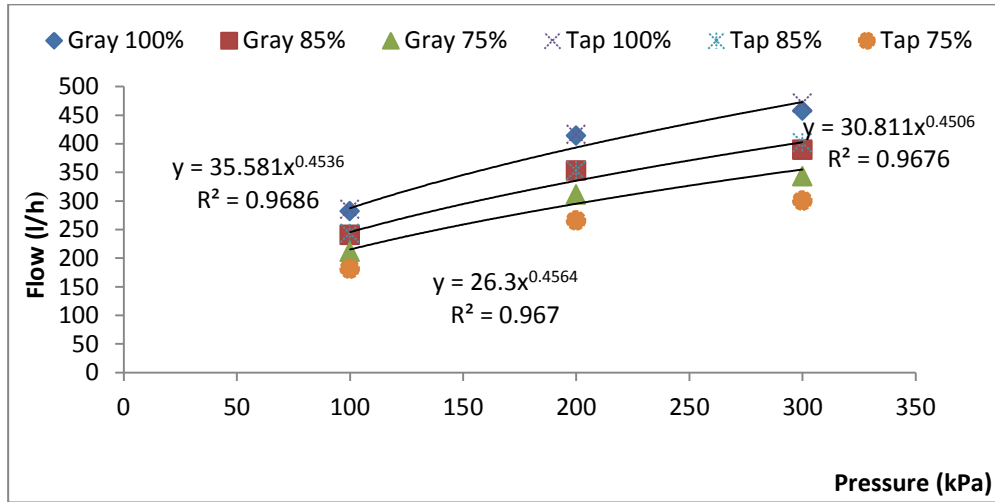

Fig. 3. Relation between pressure and flow rate in gray and tap water at arc (180).

Calibration for sprinkler in relationship between flow rate and time

The relationship between pressure flow rate (l/h) and time (3 months) by using gray water and tap water .As show in **Figs.(4) and Fig.(5)**, Showing decrease in flow rate by the time, where at pressure (200 kpa) at arc (90° - 180°), flow rate at arc (90°) was (204.83– 195.24.18- 187.68) l/h, (174.28– 169.46 - 162.28) l/h and (154.16- 148.85 - 143.21) l/h, at arc (180°) (414.24 - 404.93-

396.00) l/h, (352.83 - 342.92 - 340.23) l/h and (308.76 - 300.28 - 294.75) l/h using gray water. Meanwhile, the flow rate in arc (90°) was (208.37 - 206.90 - 206.23) l/h, (176.15 – 174.95 - 174.01) l/h and (156.34 - 155.36 - 154.25) l/h, at arc (180°) (417.37 - 413.46 - 413.29) l/h, (354.34 - 352.21- 350.78) l/h and (310.06 - 309.08 - 305.33) l/h using tap water. At (100% - 85% - 75%) of quantity the water required for the plant .Hence, that the performance rate for sprinkler nozzles by using tap water was better than the gray water.

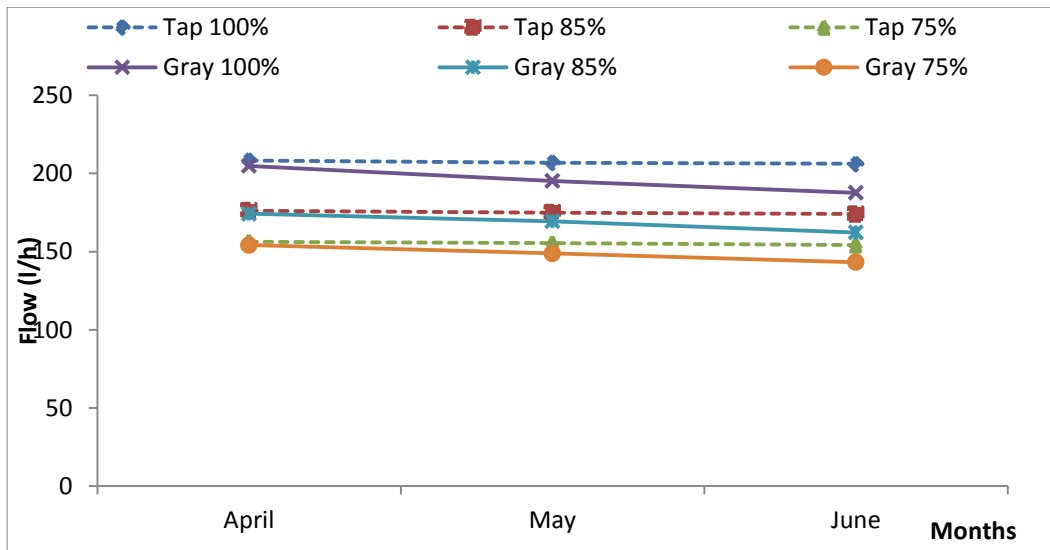

Fig. 4. Evaluate between time and flow rate in gray water and tap water at arc (90°).

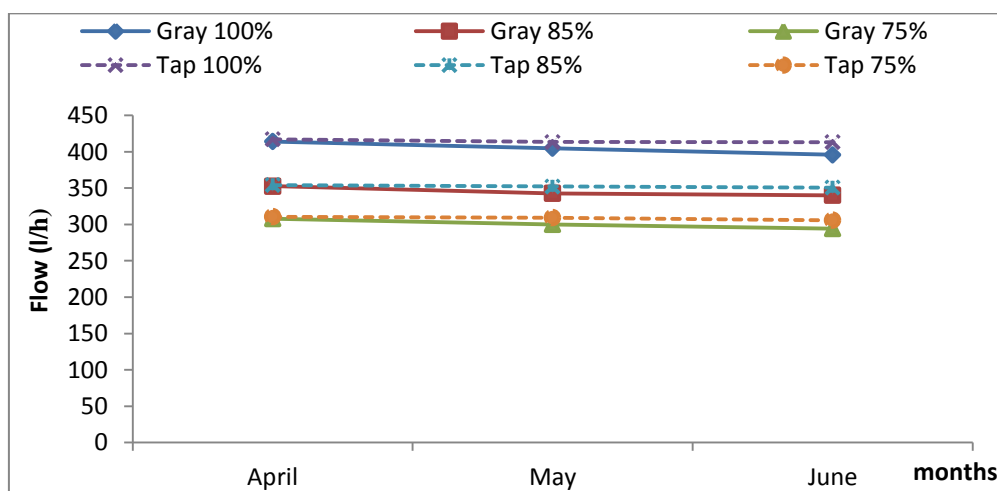

Fig. 5. Evaluate between time and flow rate in gray water and tap water at arc (180°).

The validity of irrigation water on turf grasses.

Show the measuring the effect of tap water and gray water use on the plant in terms of color, density and ground cover at (100% - 85% - 75%) of quantity the water required for the plant. illustrates in tap water turf quality rate was (8.50 – 8.00 – 8.00) for color, very good quality rate was (8.00 – 8.00 – 7.50) for density also very good ground cover quality rate was (8.00 – 7.50 -7.50). Meanwhile, illustrates in gray water turf quality rate was (8.50 – 8.50 – 8.00) for color, very good quality rate was (8.50 – 8.00 – 8.00) for density also very good ground cover quality rate was (8.00 – 8.00 – 7.50) at (100% - 85% - 75%) of quantity the water required for the plant.

Results are also in agreement with (pinto et al 2010) results who reported that no significant difference was observed in silver beet growth over 60 days when it was irrigated with fresh water and gray water. The data suggest that small difference may be observed in plant growth when irrigated with gray water depending on soil type and plant

specific factors.4-1-1-Growth measurements for length, dentistry, color for plant the existence of spaces.

Clogging ratio

The Accumulative clogging ratio by using gray water was (1.50 – 1.56 – 1.6) % and tap water was (1.22 – 1.25 – 1.28) % at (100% - 85% - 75%) of quantity the water required for the plant as show in fig. (6). Hence, that the accumulative clogging ratio by using gray water higher than using tap water and agree with many author.

The weight of the impurities was measured from network irrigation every month for three month which was in tap water was (2.64 – 2.96 – 3.13) g/m², (2.25 – 2.66 – 2.54) g/m² and (2.04 – 2.31 – 2.28) g/m² as show in fig.(10). The impurities was measured in gray water (3.92 – 4.15 – 4.16) g/m², (3.32 - 3.21 – 3.28) g/m² and (3.10 – 2.97 – 2.93) g/m² at (100% - 85% - 75%) of quantity the water required for the plant as show in Fig. (7) and Fig.(8).

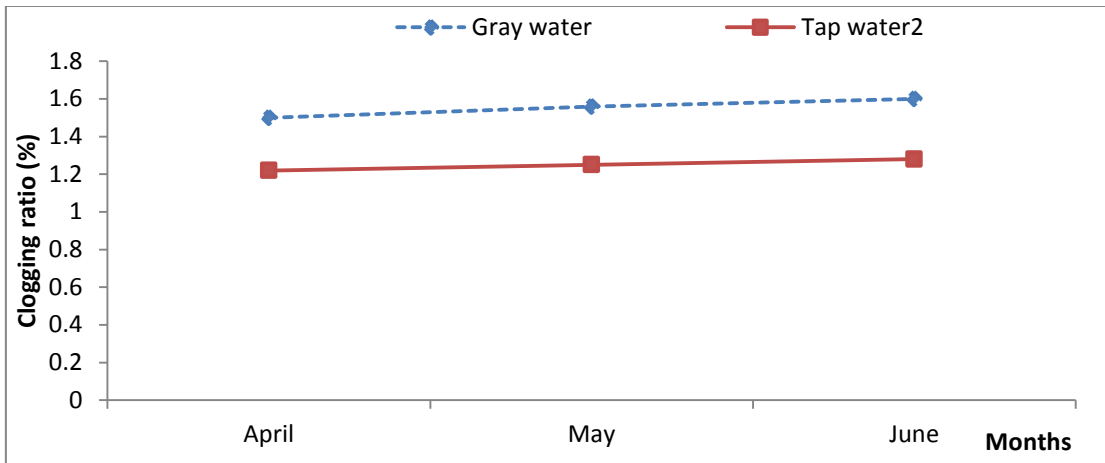

Fig. 6. The Accumulative clogging ratio by using gray water and tap water.

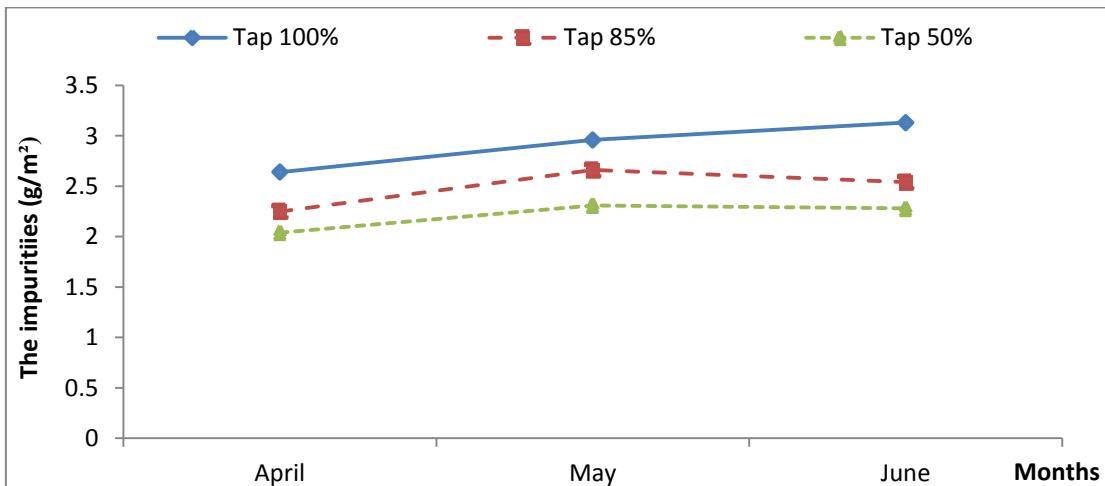

Fig. 7. Measurement of impurities on the irrigation with tap water.

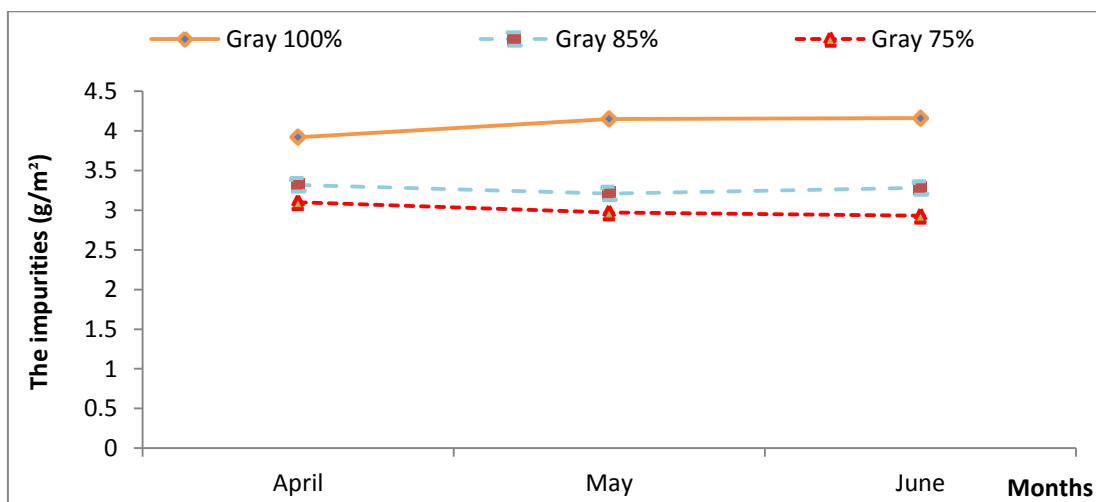

Fig. 8. Measurement of impurities on the irrigation with gray water.

4-5- Distribution uniformity

The coefficient of uniformity (CU) during the three months of experimentation of the gray and tap water where in the first, second and third month the distribution uniformly using tap (92.17 –

90.85– 87.50) %, (92.23 – 91.00 – 87.66) % and (92.14– 90.75– 87.00) % ,by tap water was (91.40– 89.80 – 84.70) %, (91.95 – 88.66 – 85.90) % and (91.34 – 88.52 – 85.33) % at (100% - 85% - 75%) of quantity the water required for the plant as show in **Fig.(9)**.

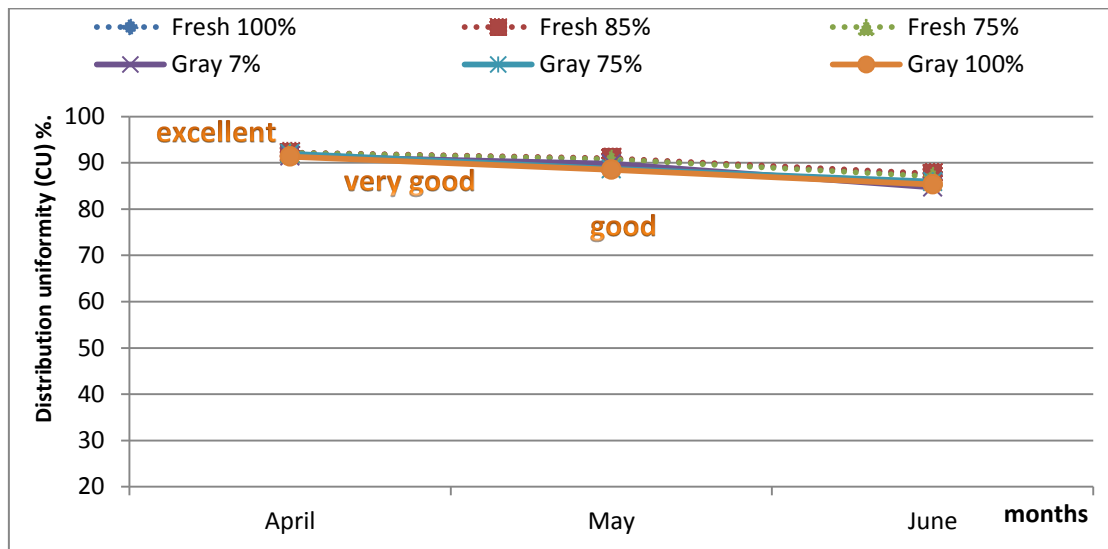

Fig. 9. Distribution uniformity (CU) in fresh water and gray water .

Surface roughness

4-6-1- Main irrigation lines

Surface roughness in the main irrigation lines was measured after the use of gray water and tap water. The erosion was (17.93 – 65.35) Mm and the sediments were (15.48 – 58.22) Mm in gray while the erosion of tap water was (10.45 – 34.89) Mm and the sediments were (9.06 – 45.22) Mm in **Fig. (10)**. Hence, roughness is shown by using gray water more than fresh water. This roughness is due to total suspended solids.

Sub main irrigation lines

The using the electronic microscope, the roughness in the sub main irrigation lines was

measured after the use of gray water and tap water. The erosion was (10.50 – 35.94) Mm and the sediments was (10.11 – 32.55) Mm for the gray while tap water erosion was (9.11 – 30.93) Mm and the sediments was (7.50 – 20.48) Hence, roughness is shown by using gray water more than tap water. As shown in **Fig. (11)**.

Manifold irrigation lines

The roughness in the manifold irrigation lines was measured after the use of gray water and tap water. The erosion was (4.54 – 12.37) Mm and the sediments was (4.22 – 12.47) Mm for gray water while tap water erosion was (3.36 – 7.57) and the sediments was (3.36 – 6.35) Mm. Hence, roughness is shown by using gray water more than tap water. As show in **Fig. (12)**.This roughness is due to total suspended solids, and agrees with author.

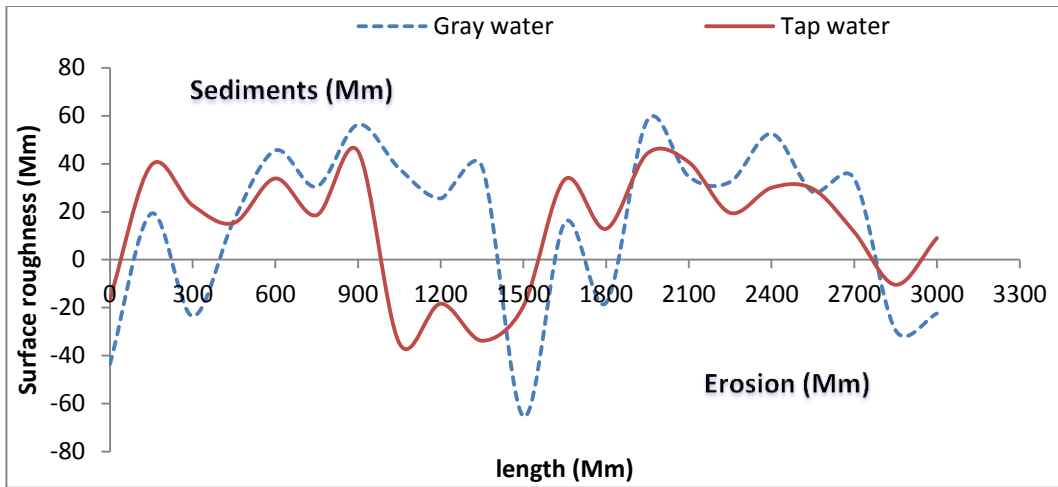

Fig. 10. Surface roughness for main lines by using tap and gray water.

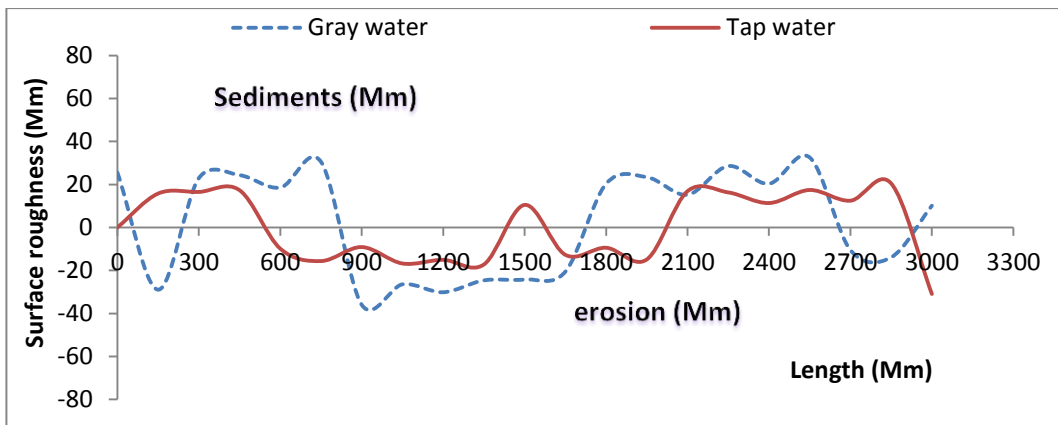

Fig.11. Surface roughness for sub main lines by using tap and gray water .

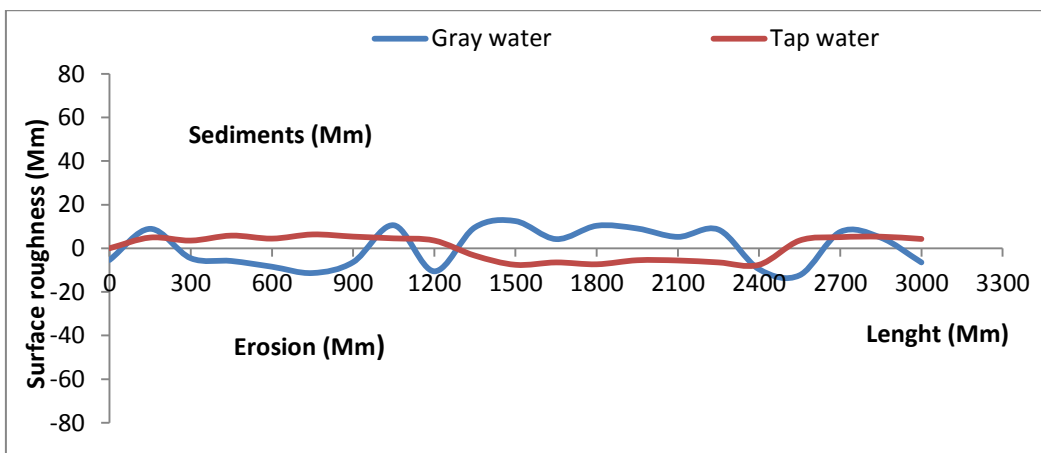

Fig. 12. Surface roughness for manifold lines by using tap and gray water .

Precipitation rate:

The sedimentation rate, mm/h, radius wettability was measured using tap water, and gray water, and showed a decrease in performance rate using tap water and gray water. The rate of performance of the sprinkler using tap water was better than the use gray water. This decrease is due to the total outstanding solids as show in table (10).

Table 10. Performance rate of sprinkler using gray water and tap water .

Month		Gray water		Tap water	
		Wettability radius, m	Sedimentation Rate, m ³ /h	Wettability radius, m	Sedimentation Rate, m ³ /h
April	Arc(90°	4.4	.19	4.5	.20
May)	4.3	.18	4.4	.19
June		4.3	.18	4.4	.19
April	Arc(180°	4.4	.40	4.5	.40
May)	4.3	.38	4.4	.39
June		4.3	.37	4.4	.39

SUMMARY AND CONCLUSION

In this study trying to find non-conventional solutions to compensate severe shortage of water using treated wastewater and study effect on performance of irrigation systems and landscape plant.

The results showed that the gradual increase of all the growth measurements during the study period under gray water irrigation showed better growth and good appearance (color, Density and Ground Cover) than fresh water, Because there are useful elements in gray water. It was also shown that the percentage of blockages accumulated by using gray water is higher than the use of fresh water, which is due to the total suspended solids, The results also showed that gray water does not have an effect on increasing the flow when increasing the pressure, But the flow rate in using gray water is less than disposition in using fresh water, and this imbalance is due to the total downtime solids.

Recommendations:

It is also recommended to expand the use of grey water as provides approximately 4-5 billion m³ of treated water per year under Egyptian conditions.

-It is recommended to use grey water because it is better in terms of quality of the plant than the color and density of the elements necessary for plant growth, But the disadvantage is that they need regular maintenance and regular work to avoid obstruction, They also use it at a lower cost per square meter of purified water.

-It is recommended to use gray water with filters suitable for the diameters of water contaminants with the sprayers used for this water.

REFERENCE

- Abrol I.P., Yadav J.S.P. and Massouad F.I. 1988.** Salt-affected Soils and their Management. Water Quality and Crop Production, FAO.
- Albalawneh, A. and T.K. Chang. 2015.** Review of the greywater and proposed greywater recycling scheme for agricultural irrigation reuses. *International Journal of Research-Granthaalayah*, 3(12), 16-35.
- AL-Amoud, A.I. 1997.** Trickle irrigation system, King Sand University, pp. 137-143.
- ASAE Standard., 2001.** Procedure for sprinkler testing and performance reporting. *ASAE, Standard S398.1 JAN01*, pp. 880 - 882.
- Awady, M.N., Vis E.G., Kumar R. and Mitra S., 2003.** Distribution uniformity from popup sprinklers and landscape water-saving. *The 11th Annual Conference of Misr Society of Agricultural Eng., Egypt, 15-16 Oct, pp.181-194*
- Cesar, J.H., A.M. Silva, F.A. Rocha and C.R. Mello. 2004.** Technical evaluation of a gun sprinkler of the turbine type. *Ciencia e Agro-tecnologia. Universidade Federal de Lavras, Brazil, 28(4), 932-941.*
- Cheng, Z., Richmond, D.S., Salminen, S.O. and Grewal, P.S. 2008.** Ecology of urban lawns under three common management programs. *Urban Ecosystems*, 11(2), 177-195.
- Costello, L.R., N.P. Matheny and J.R. Clark., 1993.** Estimating water requirements of landscape plantings, the landscape coefficient method, Crop. Ext., U.C. Div. Ag. And Natural Reso, Leaflet 21493, cited from **Mona M. El-Dib, 2017. Expert System for Turf Irrigation Management. Ph.D. Thesis, Ain Shams Univ., pp.11-12.**
- Eklund O.C. and Tegeolberg L. 2010.** Small-scale Systems for Greywater Reuse and Disposal A Case Study in Ouagadougou, Uppsala University. pp. 10-20.

- FAO, 2001.** FAO AQUASTAT. FAO's Information System on water and Agriculture: climate Information tool. AQUASTAT climate characteristics. <http://www.fao.org/nr/water/aquastat/gis>.
- James, L.G. 1988.** Principles of farm irrigation system design. New York: John Wiley and Sons. 545 p.
- Juan G. 2014.** Water quality and water-use efficiency in landscapes, a training manual developed for landscape maintenance, personnel Water Wise Consulting, Inc. 300 S. Raymond Ave., Suite 20 Pasadena, pp. 626-793.
- Khaseeve, K.A., 2013.** Evaluation of turf quality for cool season species and cultivars, Russian St. Ag.U., **MOSCOW, Russia, 92(8),115-129.**
- Leinauer, B. and Smeal, D. 2012.** Turfgrass Irrigation. Circular 660. NMSU and the U.S. Dep. of Ag. Cooperating, 12p.
- Li, J. and M. Rao. 2004.** Crop yield as affected by uniformity of sprinkler irrigation system. **Agricultural Eng. Int. The CIGR J. Sci. Res. Dev. 111 p.**
- Melvyn, K., 1983.** Sprinkler irrigation, equipment and practice. Batsford Academic and Educational, London. 120 p., cited from **Doaa M. Sayed 2016, Effect of some Engineering Factors of Sprinkler Irrigation on Sprinkler Performance, M.Sc., Thesis, Ain Shams Univ., pp. 21-22.**
- Pedrero, F.I., Kalavrouziotis J.J. and Koukoulakis P.T. 2010.** Use of treated municipal. wastewater in irrigated agriculture-Review of some practices in Spain and Greece. **Agricultural Water Management, 97(9), 1233-1241**
- Pinto, U; B. Maheshwari and H. Grewal., 2010.** Effects of Gray water irrigation on plant growth, water use and soil properties. **Resources, Cons and Recy. 54(7), 429-435.**
- Sorlini, S., Palazzini, D., Sieliechi, J.M. and Ngassoum, M.B., 2013.** Assessment of physical-chemical drinking water quality in the Logone Valley (Chad-Cameroon). **Sustainability, 5(7), 3060-3076.**



إدارة نظام الري بالرش باستخدام المياه الرمادية

[14]

شيماء عويس عبدالفتاح- أحمد أبوالحسن عبدالعزيز- خالد فران الباجوري

قسم الهندسة الزراعية- كلية الزراعة- جامعة عين شمس- ص.ب. 68- حدائق شبرا 11241- القاهرة- مصر

*Corresponding author: shimaa20130@gmail.com

Received 10 February, 2019,

Accepted 5 March, 2019

الموجز

القائم للمسطح "90° لكل من المياه الرمادية ومياه الصنبور (0.13 - 0.18 - 0.20) م³ / م³ س م 3 / س، (0.14 - 0.20 - 0.22) م³ / س على التوالي، في حين كان متوسط معدل التساقط عند القطر الوتري القوس (180°) كان (0.23 - 0.38 - 0.43) م³ / س م³ / س، (0.26 - 0.39 - 0.46) م³ / س على التوالي، عند النسب (100% - 85% - 75%) من المقننات المائية المطلوبة للنباتات المنزرعة. في نهاية التجربة "بكافة معاملاتها" كانت نسبة الانسداد نتيجة لتراكم الشوائب باستخدام المياه الرمادية (1.50% - 1.56% - 1.60%) ومياه الصنبور العادية (1.22% - 1.25% - 1.28%)، عند النسب (100% - 85% - 75%) من المقننات المائية المطلوبة للنباتات المنزرعة. تم قياس خشونة خطوط الري الرئيسية بعد استخدام المياه الرمادية والمياه العذبة. وفي نهاية التجربة باستخدام المجهر الإلكتروني كان التآكل (17.93 - 65.35) ملم (10.45 - 34.89) ملم للمياه الرمادية والعذبة على التوالي، في حين كانت الرواسب في المياه الرمادية والمياه العذبة (15.48 - 45.22) ملم (9.06 - 45.22) ملم على التوالي.

الكلمات الدالة: الري بالرش، مياه الرمادية، الباسبالم

يهدف البحث إلي معرفة تأثير المياه منخفضة الجودة (المياه الرمادية) على نظام الري بالرش ومكوناته ونمو الزراعات المختلفة للمساحات الخضراء للحدائق والمنتزهات والملاعب النجيلية وما يتخللها من زراعات مختلفة. أجريت تجارب البحث في مدينة الرحاب على مساحة مساحات خضراء 30 م × 15 م مقسمة إلى 6 معاملات بمساحة 5 م × 15 م / معاملة. تم ري المعاملات الأولى والثانية والثالثة بالمياه الرمادية وباقي المعاملات بالمياه الأساسية المستخدمة في الري لباقي المساحات بالمناطق المجاورة (المياه العذبة). وتم ري المعاملات بنسب 100% - 85% - 75% من المقننات المائية المطلوبة للنباتات المنزرعة. تم تحليل عينات من التربة والمياه "الرمادية والصنبور" فيزيقياً ثم مقارنة تأثير كل من نوعي المياه بكافة المعاملات على نمو النبات من خلال دراسة لون وطول وكثافة النبات ومساحة سطح تغطيته. كما تم دراسة تأثير المياه بنوعيهما على مكونات نظام الري بالرش المستخدم "رشاشات البوب" وذلك من خلال دراسة تأثير نوعية المياه علي إنتظامية التوزيع. وفي نهاية فترة الري كان متوسط معدل التساقط في الركن