



## INVESTIGATION ON THE USE OF MICROPILES FOR SUBSTITUTION OF DEFECTED PILES BY THE FINITE ELEMENT METHOD

Dr. Mohammed Y. Fattah  
Assistant Professor, Building and  
Construction Engineering  
Department, University of  
Technology.

Dr. Yousif J. Al –Shakarchi  
Professor, Civil Engineering  
Department, University of  
Baghdad.

Yasser M. Kadhim  
Formerly graduate student, Civil  
Engineering Department,  
University of Baghdad.

### ABSTRACT

Micropiles are small diameter, cast in – place or grouted piles with steel pipes of (50 to 300 mm) diameters and driven by boring machine. Despite their small wall thickness, high bearing capacity of micropiles provides both axial and pullout resistance.

This paper is directed to study the behavior of micropiles under static and dynamic loading conditions using the finite element method.

The program OpenSees is used in the analysis, it is open – source program, provides information about the software architecture, access to the source code, and the development process. The program is based on the basic commands, which are written in Tcl (pronounced, "tickle"; tool command language).

A model for groups of laterally loaded pipe piles in sand was adopted to study the effect of defects on their lateral performance. The geometric arrangement consisted of group series of 2, 4 and 6 equally spaced piles. Eight node brick elements are used to model the pile and the surrounding soil.

It was concluded that the deflection of laterally loaded piles decreases when inserting steel micropiles beside the defect pile at two opposite directions. The increase in the group deflection is greater when the defected pile is modeled in the front row.

### تحري عن استعمال الركائز المصغرة كبديل عن الركائز المتضررة بطريقة العناصر المحددة

#### الخلاصة:

الركائز المصغرة، هي ركائز تكون باقطار صغيرة، اما ان تصب موقعا او بواسطة ادخال انابيب حديدية بقطر (50-300) ملم ويتم ادخال هذه الانابيب بواسطة آلة ثقوب. على الرغم من ان الركائز المصغرة ذات سمك قليل الا ان التحمل العالي للركائز المصغرة يعطي مقاومة للاحمال المحورية ومقاومة لقوى السحب. ان هذه البحث موجه نحو دراسة تصرف الركائز المصغرة تحت تأثير الاحمال الساكنة والاحمال الديناميكية وباستخدام طريقة التحليل بالعناصر المحددة

تم اعتماد البرنامج (OpenSees) في التحليل, وهو برنامج عام يقوم بتزويد معلومات الكترونية عن المنشأ ويكون خاضعاً لمجموعة قوانين محددة وكذلك يعتمد على طبيعة تطور المعالجة. ان هذا البرنامج يعتمد على اوامر لغة الحاسوب والتي تكتب بلغة (Tcl) و وهي مختصر لما يسمى بلغة ادوات الاوامر (Tool Command Language). تم تبني دراسة نموذج من مجموعة من الركائز المحملة جانبياً في تربة رملية لغرض دراسة تأثير الخلل في الركائز على فعالية السلوك الجانبي للركائز. الركائز تتألف في هينتها من مجاميع مكونة من 2, 4 و 6 ركائز موزعة على مسافات متساوية فيما بينها. تم استخدام عناصر محددة طابوقية ذات ثمانية عقد (Eight-node brick elements) لتمثيل الركيزة والتربة التي تحيط بها. و قد تم التوصل الى ان الانحراف الجانبي لمجموعة الركائز المحملة جانبياً يقل عند غرس ركائز مصغرة بجانب الركيزة المتضررة من اتجاهين متقابلين. ان الزيادة في الانحراف للمجموعة يكون اكبر عندما تكون الركيزة المتضررة ممثلة في السطر الامامي للمجموعة .

## INTRODUCTION

Micropiles are often used to improve the bearing capacity of the foundation against applied loading. In many cases, steel pipes of 50 to 200 mm diameters are used as micropiles. The strengthened ground acts as coherent mass and behaves remarkably well, capable of sustaining high compressive loads at defined settlement or alternatively defined loads at reduced movement. Lizzi (1982) and Plumelle (1984) showed that micropiles create an in-situ coherent composite reinforced soil system and the engineering behavior of micropile-reinforced soil is highly dependent on the group and network effects that influence the overall resistance and shear strength of composite soil- micropile system. Juran et al. (1999) presented a state of art review, covering all the studies and contributions, on the state of practice using micropiles. Considerable information on single micropile design, evaluation of load bearing capacity, movement estimation models as well as effect of group and network effect have been covered in considerable detail. They also reviewed geotechnical design guidelines in different countries for axial, lateral load capacities and approach for movement estimation.

The use of small-diameter piles and micropiles in seismic retrofitting or in new construction in seismic zones requires a thorough analysis of the seismic induced response for groups of flexible piles with inclined elements. As a matter of fact, as the stiffness and resistance of vertical flexible piles to lateral loading is generally small, the use of inclined small-diameter piles presents a potential alternative to withstand inertial forces and to ensure stability of the foundations system under seismic loading.

As reported by Gazetas and Mylonakis (1998), in recent years evidence has been accumulating that inclined piles may, in certain cases, be beneficial rather than detrimental both for the structure they support and the piles themselves. One supporting evidence to this issue was noted during the Kobe earthquake. It was noted that one of the few quay-walls that survived the disaster in Kobe harbor was a composite wall relying on inclined piles, conversely, the near wall, supported on vertical piles, was completely devastated.

## ADVANTAGES OF MICROPILES:

Micropiles are installed by drilling mainly to increase the vertical bearing capacity of the soil. The advantages of micropiles are that high capacity piles would require fewer elements for support than standard H-pile foundations, and the micropiles could also be constructed from underneath an existing super-structure with low headroom constraints. Additionally, as the design progressed, the micropiles could be installed around the utilities in a confined space. Therefore, the pier construction could be completed without interfering with rail traffic and any movement of the existing piers during foundation installation would be minimized by

utilizing the micropile foundations, with low noise, and vibration during installation process. It can be used for any type of soil, but with conditions for rock soil, regardless of the kind of soil or the presence of water table; or its accessibility, (Hronek, et al., 2007).

Notably, micropiles require small area of footing when they are utilized as foundation piles, they also promise easy construction of batter and staggered piles. Similar to other conventional piles, micropiles can be used both individually as bearing piles and in groups for soil strengthening. The typical illustration of a high capacity micropile system is presented in Figure (1).

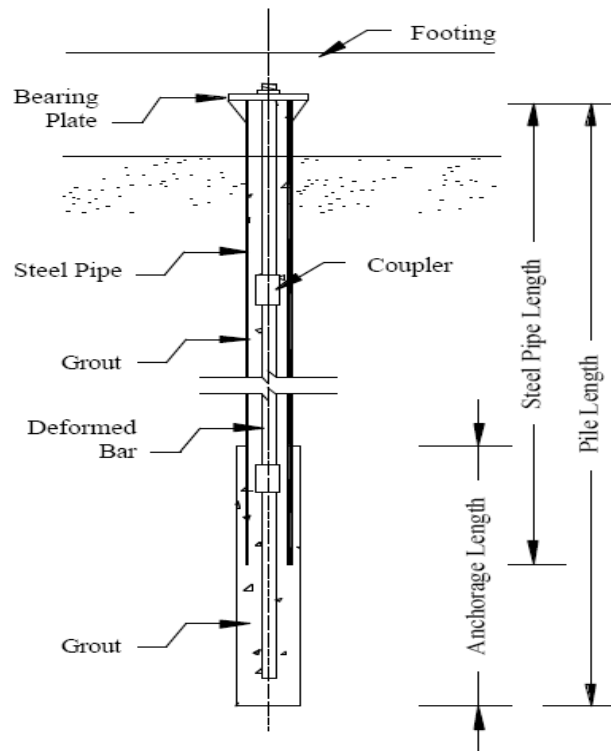

**Figure (1): Details of Micropiles System (Kalkan, 2003).**

#### **COMPUTER PROGRAM USED:**

OpenSees has advanced capabilities for modeling and analyzing the nonlinear response of systems using a wide range of material models, elements, and solution algorithms. The program is designed for parallel computing to allow simulations on high-end computers or for parameter studies. The program interpreter is an extension of the Tcl (pronounced "tickle"). Tcl comes from "Tool Command Language" is a non-typed language, that means an expression can always be seen as a numeric value, a string or another value, conversions are done on-the-fly. All types are implemented as string, even lists are strings with embedded separating spaces) language for use with OpenSees. The Tcl scripting language was chosen to support the OpenSees commands, which are used to define the problem geometry, loading, formulation and solution, (Silvia et al., 2005).

#### **OpenSees Analysis Capabilities:**

Linear equation solvers, time integration schemes, and solution algorithms are the core of the OpenSees computational framework. The components of a solution strategy are interchangeable, allowing analysts to find sets suited to their particular problem. Outlined

here are the available solution strategies. New parts of the solution strategy may be seamlessly plugged into the existing framework (Silvia et al., 2005).

### **BRICK UP ELEMENT:**

It is an 8-node hexahedral linear isoparametric element. Each node has 4 degrees of freedom (DOF): DOFs 1 to 3 for solid displacement (u) and DOF 4 for fluid pressure (p). This element is implemented for simulating dynamic response of solid-fluid fully coupled material, based on Biot's theory of porous medium.

This element is used in this paper to model the pile and the surrounding soil.



### **USE OF MICROPILES FOR SUBSTITUTION OF DEFECTED PILES:**

A model for groups of laterally loaded hollow pipe piles in sand was made by Ata, and El-Kilany, (2006). Tests were performed to study the effect of anomalies (defects) on their lateral performance. The geometric arrangement consisted of a group series of 2, 4 and 6 equally spaced piles. The defect pile was introduced as 50% necking or reduction in the thickness of the pipe pile at selected depths. It is attempted here that two steel micropiles are inserted in the model surrounding the defect pile in two opposite sides with diameter of (6 mm) in order to study the effect of the micropile on the load-deflection relationship as shown in Table (1). Each geometric series contained only one defective pile and the location of the defective pile was varied within the rows of the group. Each pile consisted of a hollow steel pipe of 16 mm inside diameter, 3 mm wall thickness and a length of 650 mm. Model pile groups of 2, 4 and 6 piles spaced at 3 times the diameter (in both directions) were assembled in place at the center. Pile caps were modeled using 25-mm thick steel plate. The load was applied incrementally by 100 N and up to the maximum total load of 2000 N. All series of pile groups were laterally loaded under similar conditions with no constraint on the pile heads as shown in Figure (2) which shows the finite element mesh for the pile cap while the mesh of elements around the piles is not shown in order to clarify the pile locations. The bottom of the mesh was restrained against horizontal movement in x- and z- directions while the side boundaries of the mesh are restrained against vertical movement in y- direction. In order to prevent concentration of stresses on small zone, the lateral loads were applied on the pile cap as distributed loads within an area of 3D (three pile diameters) as shown in Figure (2).

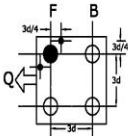
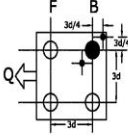
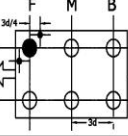
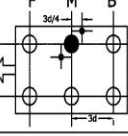
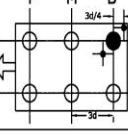
**Table (1): Cases Due To Presence of Defected Piles with Proposed Micropile.**

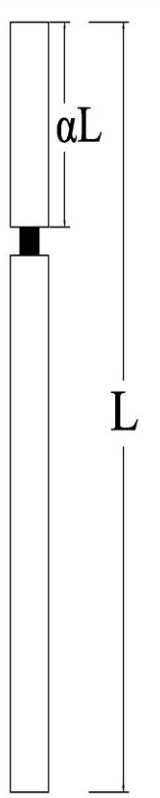
Group Configuration	Depth of Defect ( $\alpha L$ )	
	Case 1	Case 2
	0.2L	
	0.3L	
	0.4L	
	0.5L	
	0.2L	
	0.3L	
	0.4L	
	0.5L	
	0.2L	
	0.3L	
	0.4L	
	0.5L	
	0.2L	
	0.3L	
	0.4L	
	0.5L	
	0.2L	
	0.3L	
	0.4L	
	0.5L	



-  non-defective pile.
-  defective pile.

The lateral deflection of the group was calculated at the head of the piles. The defected piles were prepared by assuming 50% off the wall thickness of the pipes to model a necking anomaly and extending for a length of 3 mm. The location of the defect was set at four different locations below the pile head represented by a fraction  $\alpha$  of the total length  $L$ , where the value of  $\alpha$  was 0.2, 0.3, 0.4 and 0.5 as shown in Table (1). The properties of the soil – micropile –structure are shown in Tables (2), (3), and (4).

It is intended in this study to model the micropiles that are used as a substitute to the defected piles. The micropiles used have the properties listed in Table (5). The load–deflection curve for this condition will be compared with other cases.

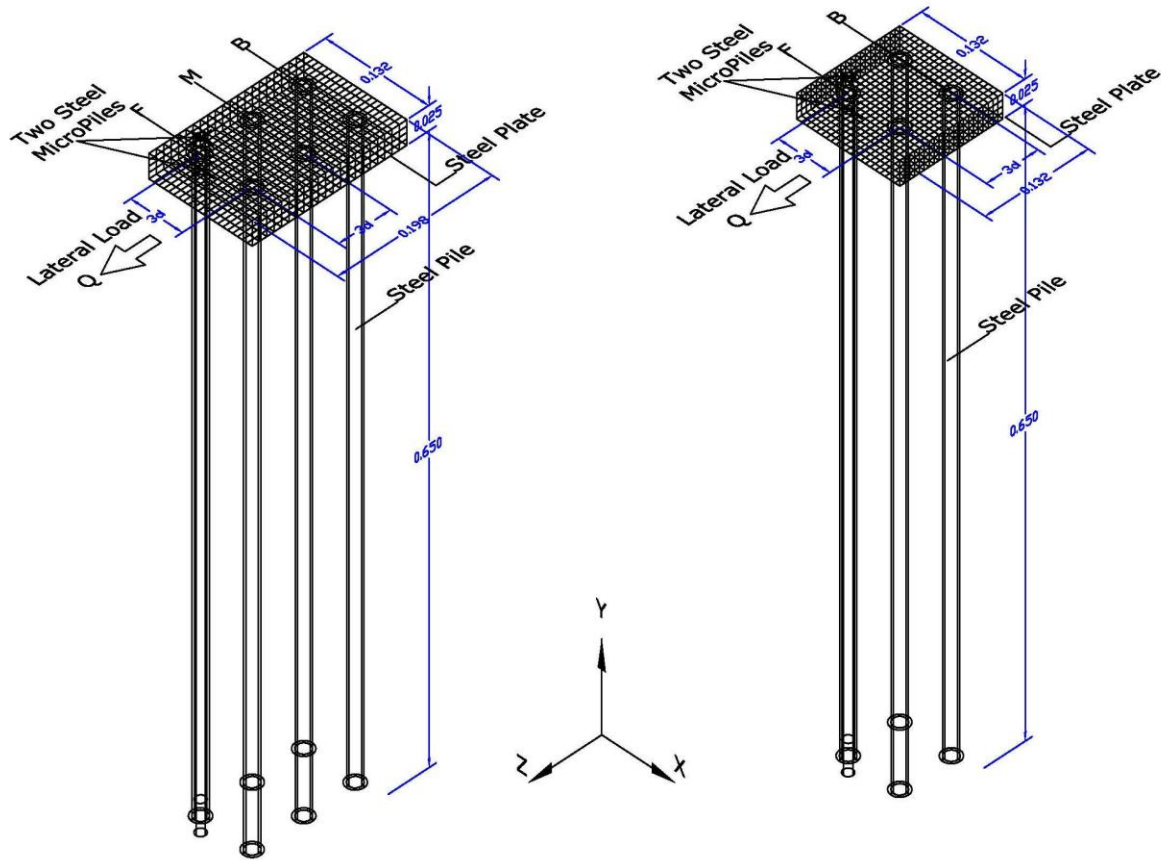

**Figure (2): Finite Element Mesh Used for Modeling  
 4-Pile Group and 6-Pile Group for Different Cases  
 in the Program OpenSees.**

**Table(2):Properties of the Soil, (Ata, and El-Kilany, 2006).**

Type of Soil	Unit Weight $\gamma_t$ ( $kN/m^3$ )	Modulus of Elasticity $E$ (kPa)	Poisson's Ratio ( $\nu$ )	Internal Friction $\phi$ (degrees)
Sandy Soil	17.20	8000	0.45	39



**Table (3): Properties of piles (steel pipe), (Ata, and El-Kilany, 2006).**

Unit Weight $\gamma_t$ (kN/m <sup>3</sup> )			Modulus of Elasticity $E$ (MPa)		Poisson's Ratio ( $\nu$ )		
78.33			205000		0.3		
$A_x$ (mm <sup>2</sup> )	$I_z$ (mm <sup>4</sup> )	$I_y$ (mm <sup>4</sup> )	$I_p$ (mm <sup>4</sup> )	Outer Diameter (mm)	Inner Diameter (mm)	Wall thickness $t$ (mm)	Length (mm)
179.1	8280	8280	16560	22	16	3	650

**Table (4): Properties of Pile Cap, (Ata, and El-Kilany, 2006).**

Type	Unit Weight $\gamma_t$ (kN/m <sup>3</sup> )	Modulus of Elasticity $E$ (MPa)	Poisson's Ratio( $\nu$ )
Steel Plate	78.33	205000	0.3

**Table (5): Properties of Micropiles.**

Type	Unit Weight $\gamma_t$ (kN/m <sup>3</sup> )	Modulus of Elasticity $E$ (MPa)	Poisson's Ratio( $\nu$ )	Outer Diameter (mm)	Wall thickness $t$ (mm)	Length (mm)
Steel Pipe	78.33	205000	0.3	6	0.82	650

**FOUR-PILE GROUP:**

The results of the total group load versus top deflection for the 4-pile group are presented in Figures (3) through Figure (6). The figures show results of four series of analysis with defects introduced at depths of 0.2L, 0.3L, 0.4L and 0.5L as considered from the top of the piles. For each analysis, three relationships are shown:

- a) no defective piles or reference case,
- b) one defective pile at back row.
- c) one defective pile at front row.
- d) one defective pile at back row surrounded by two proposed steel micropiles.
- e) one defective pile at front row surrounded by two proposed steel micropiles.

It should be noted that in each group, only one defected pile was modeled either in the back row or the front row. The results show that the deflection of the piles increases when a defect is present in one of the piles. The increase in the group lateral deflection is greater when the defected pile is modeled in the front row. The results also indicate that the deflection of the piles decreases as the depth ratio ( $\alpha L$ ) of the anomaly increases from 0.2L to 0.5L. The results also indicate that the deflection of the piles decreases when inserting the steel micropiles beside the defect pile at two opposite directions as shown in the figures.

Figures (7) and (8) present the variation of the pore water pressure as predicted at top of the pile with the lateral load for different conditions of the piles. It can be noticed that the shape of this relationship is similar to load- deflection relation and the maximum values of pore water pressure are generated at the top of the piles where maximum deflection is expected.

### SIX-PILE GROUP:

Figures (9) through (13) present the results for the 6-pile group model. Six series of model are shown with defects introduced at depths of  $0.2L$ ,  $0.3L$ ,  $0.4L$  and  $0.5L$  considered from the top of the piles. For each series, four relationships are shown:

- no defective piles or reference case.
- one defective pile at back row.
- one defective pile at middle row .
- one defective pile at front row.
- one defective pile at back row surrounded by two proposed steel micropiles.
- one defective pile at middle row surrounded by two proposed steel micropiles.
- one defective pile at front row surrounded by two of steel micropiles.

Again, only one defect was modeled in one pile, which was placed alternatively in three rows. The results show that the pile head deflection increases as the defective pile is moved from the back row to the middle row and then to the front row. Similar to the cases of the 4-pile groups, the results indicate that the deflection of the piles decreases as the depth ratio ( $\alpha L$ ) of the defect increases from  $0.2L$  to  $0.5L$ . The results also indicate that the deflection of the piles decreases when inserting the steel micropile beside the defect pile at two opposite directions as shown in the figures.

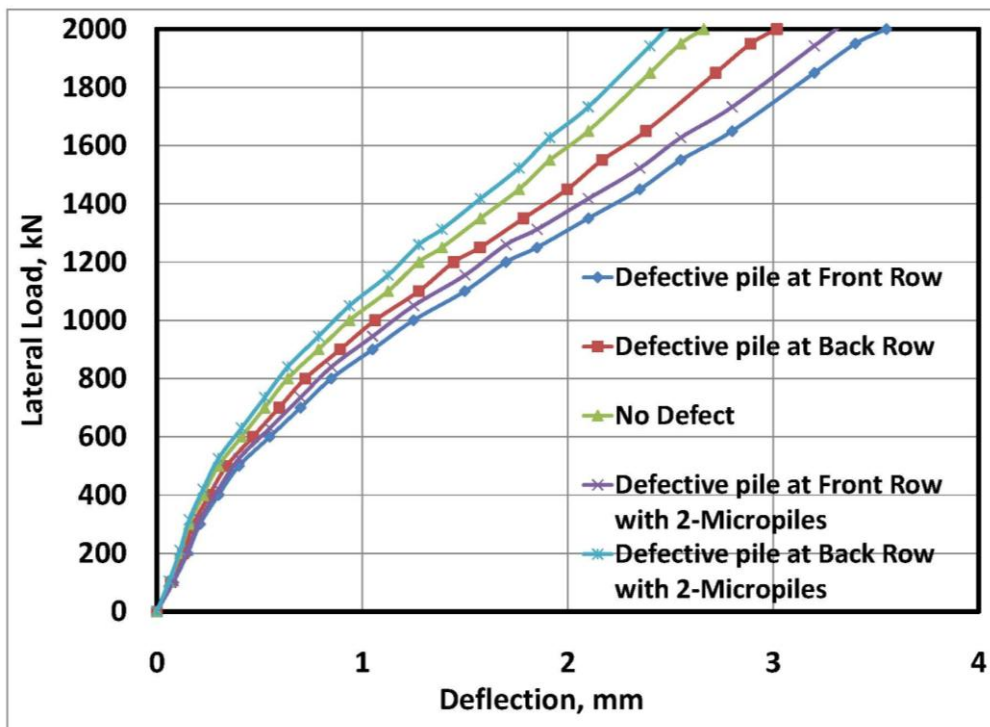

Figure (3): Load-Deflection Curves for 4-Pile Group with Defect at Depth Ratio ( $0.2L$ )

Using the Program OpenSees.



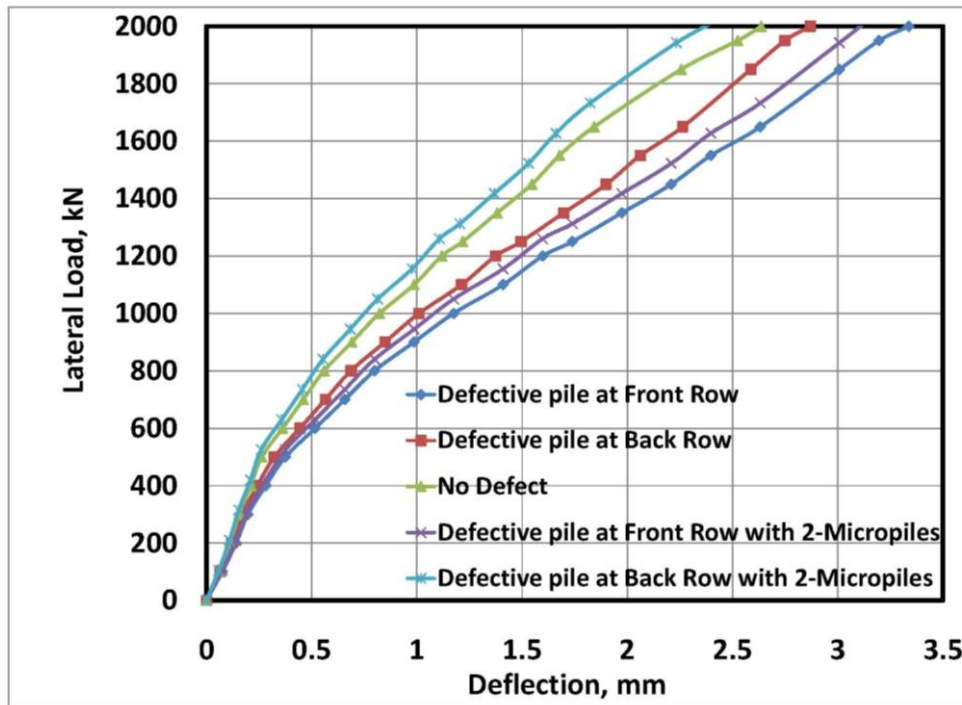

Figure (4): Load-Deflection Curves for 4-Pile Group with Defect at Depth Ratio (0.3L)  
Using the Program OpenSees.

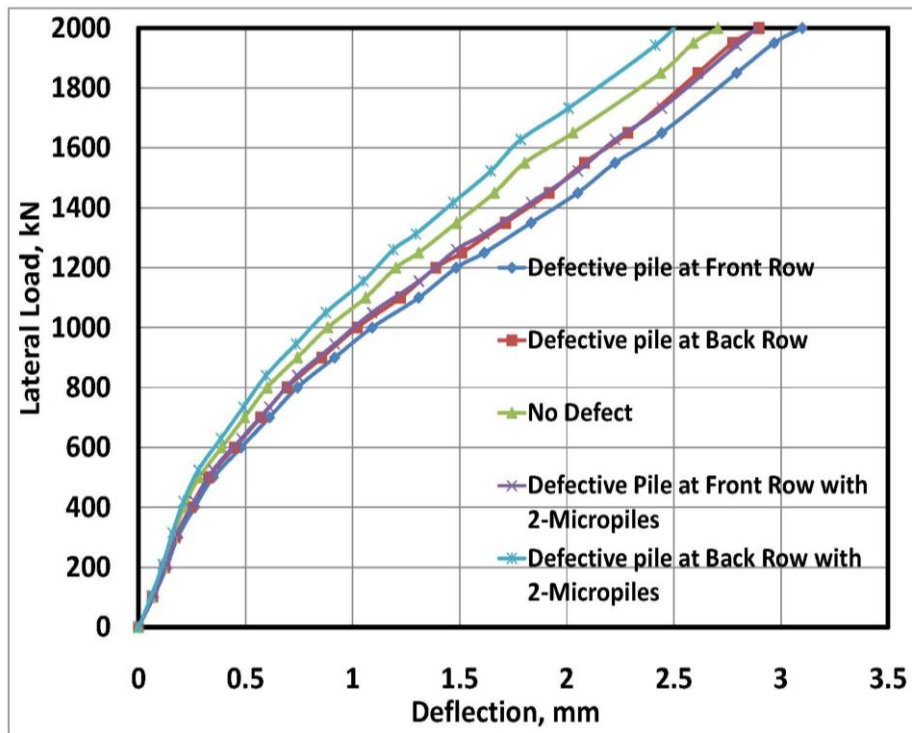

Figure (5): Load-Deflection Curves for 4-Pile Group with Defect at Depth Ratio (0.4L)  
Using the Program OpenSees.

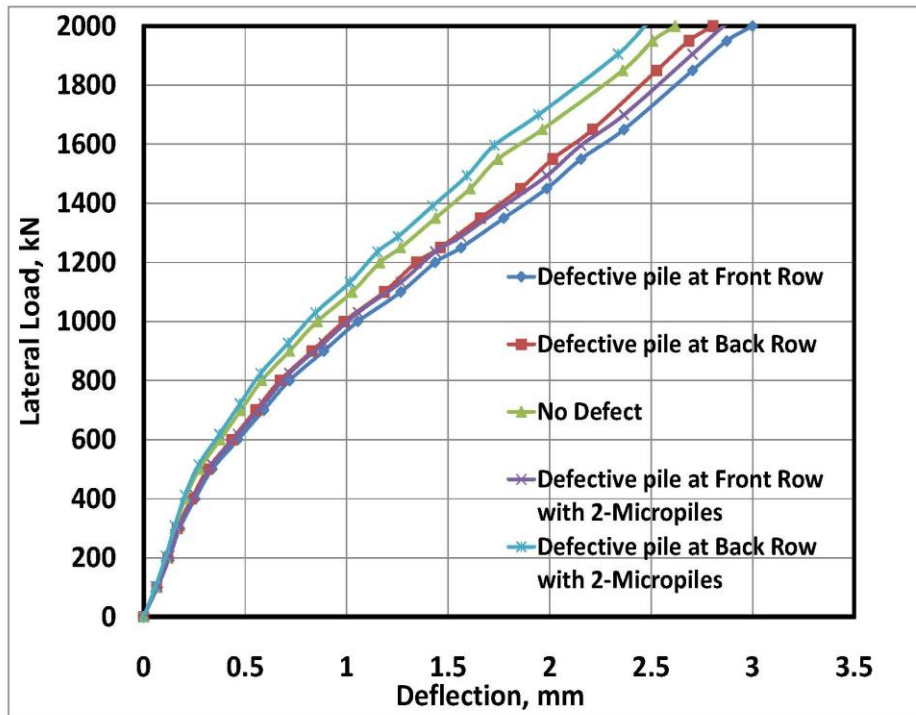

Figure (6): Load-Deflection Curves for 4-Pile Group with Defect at Depth Ratio (0.5L) Using the Program OpenSees.

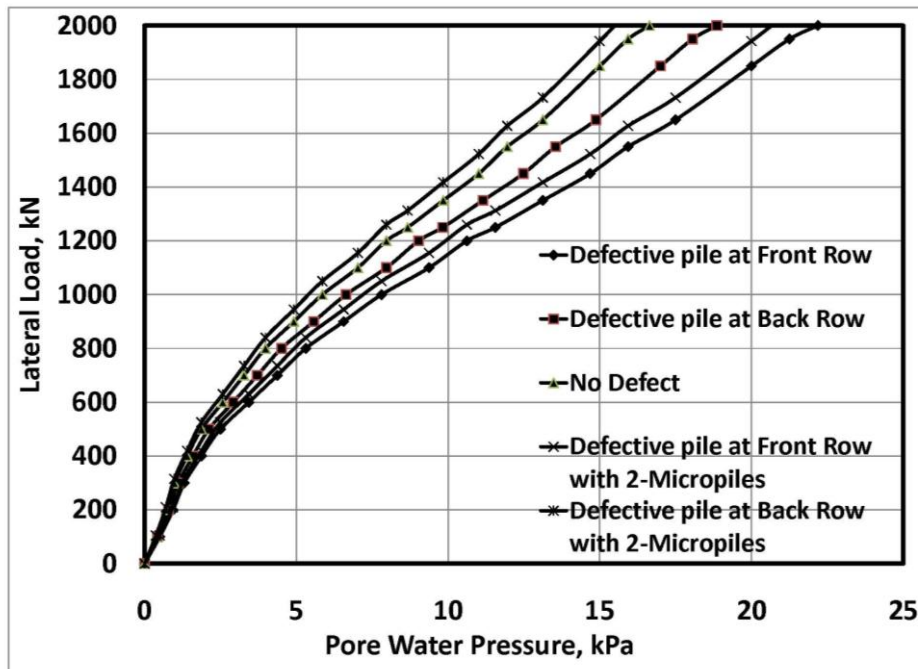

Figure (7): Max. Variation of Pore Water Pressure with Lateral Load for 4-Pile Group with Defect at Depth Ratio (0.2L) Using the Program OpenSees.

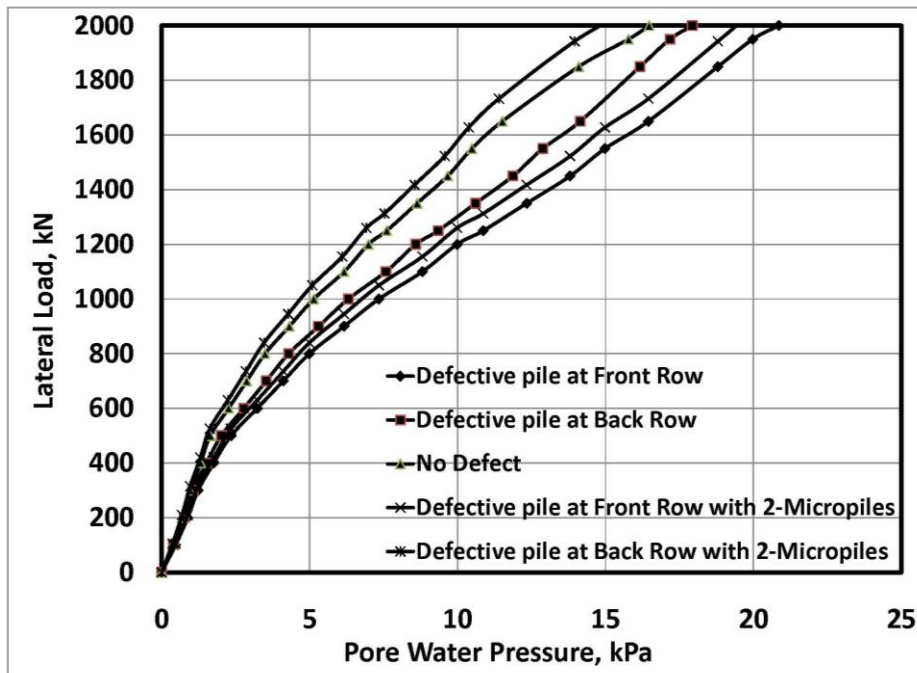

Figure (8): Max.Variation of Pore Water Pressure with Lateral Load for 4-Pile Group with Defect at Depth Ratio (0.3L) Using the Program OpenSees.

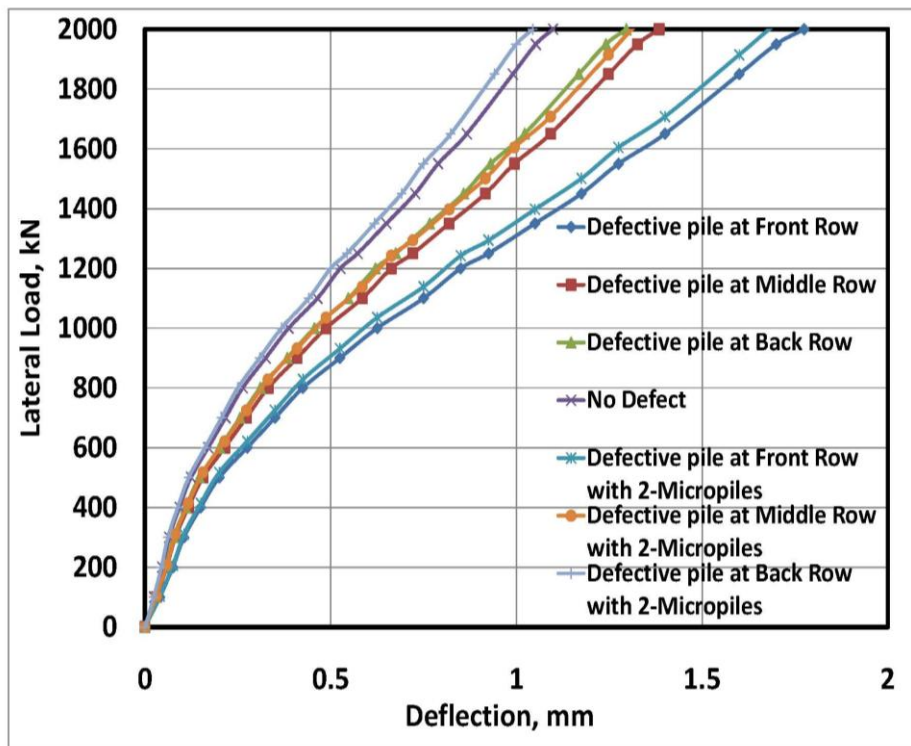

Figure (9): Load-Deflection Curves for 6-Pile Group with Defect at Depth Ratio (0.2L) Using the Program OpenSees.

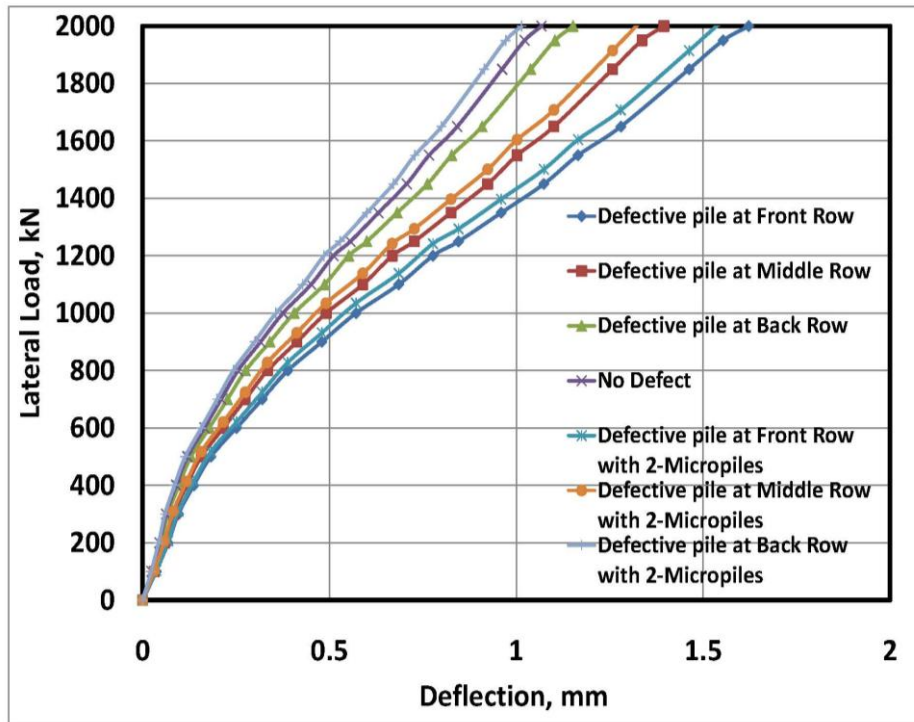

Figure (10): Load-Deflection Curves for 6-Pile Group with Defect at Depth Ratio (0.3L) Using the Program OpenSees.

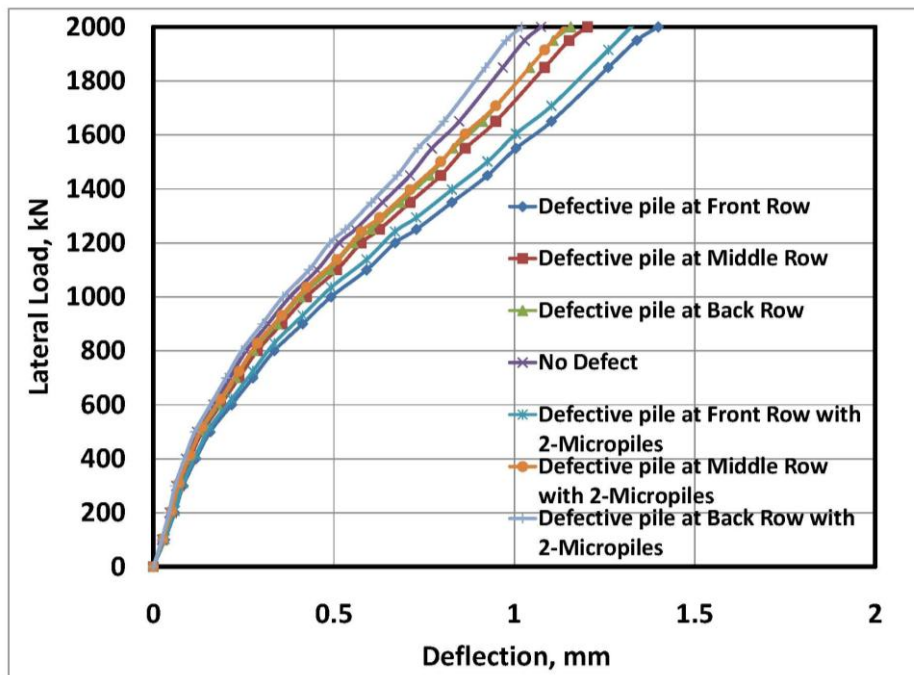
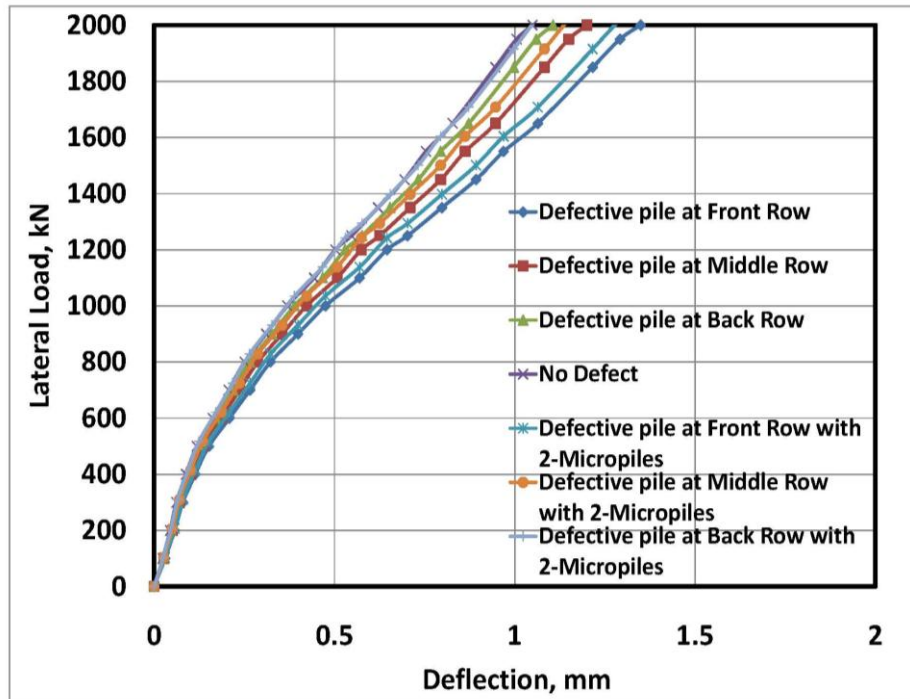

Figure (11): Load-Deflection Curves for 6-Pile Group with Defect at Depth Ratio (0.4L) Using the Program OpenSees.



**Figure (12): Load-Deflection Curves for 6-Pile Group with Defect at Depth Ratio (0.5L) Using the Program OpenSees.**

#### PROPOSED AMPLIFICATION FACTORS:

A simplified method is proposed for quantifying the effect of presence of a defect in one defective pile within a group of piles spaced center-to-center by the distances of  $3d \times 3d$ . In this method, an amplification factor is calculated by dividing the top deflection of the group containing the defective piles by the deflection of the same group arrangement without defects. In addition, another amplification factor is evaluated by dividing the top deflection of the group containing the defective piles by the deflection of the group treated by adding two micropiles, (Kadhim, 2008)

The results of the calculated amplification factors for the cases of 4-pile and 6-pile groups are presented in Figures (13) and (14). The data indicate that for the case of 4-pile group, the amplification factor ranges between 1.06 and 1.34 while for the case of 6-pile group, the amplification factor ranges between 1.02 and 1.65, depending on the position of the defective pile within the group.

These values for the case of 4-pile group become 1.03 and 1.31 while for the case of 6-pile group they become 1.00 and 1.61 when micropiles are inserted. This means that using micropiles for substituting defected piles leads to a decrease in the amplification factor of lateral deflection. In all cases, the decrease is in the order of 2-4%.

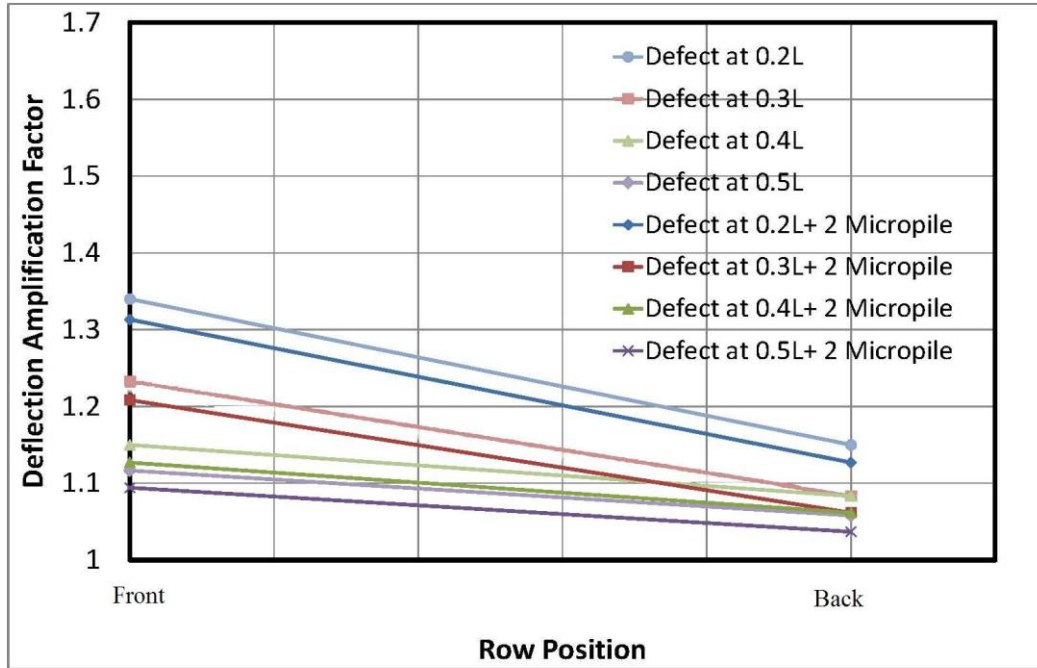

Figure (13): Effect of Defect Location with Respect to Pile Depth and Row Position for 4-Pile Group.

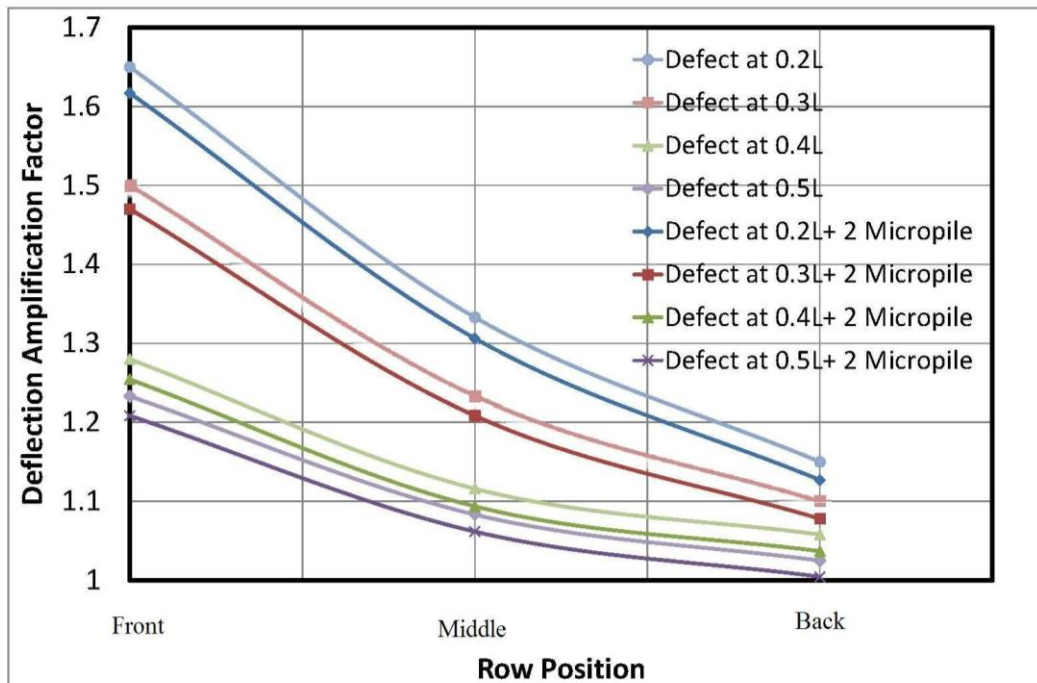

Figure (14): Effect of Defect Location with Respect to Pile Depth and Row Position for 6-Pile Group.



## CONCLUSIONS:

- The increase in the group deflection is greater when the defected pile is modeled in the front row. The deflection of the piles decreases as the depth ratio ( $\alpha L$ ) of the defect increases from 0.2L to 0.5L. The deflection of the piles decreases when inserting two steel micropiles beside the defected pile at two opposite directions.
- The pile head deflection increases as the defective pile is moved from the back row to the middle row and then to the front row. Similar to the cases of the 4-pile groups, the deflection of the piles of the 6-pile group decreases as the depth ratio ( $\alpha L$ ) of the defect increases from 0.2L to 0.5L. The lateral deflection of the piles decreases when inserting two steel micropiles beside the defected pile at two opposite directions.
- The amplification factor (the top deflection of the group containing the defective piles divided by the deflection of the same group arrangement without defects) for the case of 4-pile group ranges between 1.06 and 1.34 while for the case of 6-pile group the amplification factor ranges between 1.02 and 1.65, depending on the position of the defective pile within the group. These values for the case of 4-pile group become 1.03 and 1.31 while for the case of 6-pile group they become 1.00 and 1.61 when micropiles are inserted. This means that using micropiles for substituting defected piles leads to a decrease in the amplification factor of lateral deflection. In all cases, the decrease is in the order of (2-4) %.

## REFERENCES:

- Armour, T.P.E., Paul, G. P.E., James, K. P.E. and Sunil S. P.E., (2000), “**Micropile Design and Construction Guidelines**”, U.S. Department of Transportation, Federal Highway Administration, Priority Technologies Program.
- Ata, A. and El-Kilany, M. (2006), “**Effect of Anomalies on the Behavior of Laterally Loaded Pile Groups**”, Proceedings of the 4th Jordanian Civil Engineering Conference, 10-13 April 2006, Amman – Jordan.
- Hronek, J.W. Madlyn, P.E., and Guarino, G., (2007), “**Developing Foundation Support for the Reconstruction of Bridge Over Como Avenue, Minneapolis, MN**”, Report from Internet.
- Juran, I., Bruce, D.A., Dimillio, A., and Benslimane, A., (1999), “**Micropiles: The State of Practice. Part II: Design of Single Micropiles and Groups and Networks of Micropiles**”. Ground Improvement, Vol. 3, pp. 89-110.
- Kadhim Y.M., (2008), “**Investigation on the Use of Micropiles as Foundation Support Elements**”, Ph.D. Thesis, College of Engineering, University of Baghdad, Iraq.
- Kalkan E., (2003), “**Nonlinear Modeling of Micropile Foundation Systems**”, University of California, Davis, U.S.A., Report from Internet.
- Lizzi, F., (1982), “**The Pali Radice (Root Piles)**,” Symposium on Soil and Rock Improvement Techniques including Geotextiles, Reinforced Earth and Modern Piling Methods, Bangkok, December, Paper D<sub>1</sub>, ( as Cited by Armour, et al., 2000).
- Plumelle, C., (1984), “**Improvement of the Bearing Capacity of Soil by Inserts of Group and Reticulated Micropiles**”, International Symposium on In-situ Reinforcement of Soils and Rocks, Paris, ENPC Press, pp. 83-89.
- Silvia M., Frank M., and Gregory L. F., (2005), “**OpenSees Command Language Manual**”, OpenSees v. 1.6, Printed on 31 January.