



## Durham E-Theses

---

### *Mosquito borne diseases in England:: past, present and future risks, with special reference to malaria in the Kent Marshes.*

Hutchinson, Robert A.

#### How to cite:

---

Hutchinson, Robert A. (2004) *Mosquito borne diseases in England:: past, present and future risks, with special reference to malaria in the Kent Marshes.*, Durham theses, Durham University. Available at Durham E-Theses Online: <http://etheses.dur.ac.uk/3067/>

#### Use policy

---

The full-text may be used and/or reproduced, and given to third parties in any format or medium, without prior permission or charge, for personal research or study, educational, or not-for-profit purposes provided that:

- a full bibliographic reference is made to the original source
- a [link](#) is made to the metadata record in Durham E-Theses
- the full-text is not changed in any way

The full-text must not be sold in any format or medium without the formal permission of the copyright holders.

Please consult the [full Durham E-Theses policy](#) for further details.

---

Academic Support Office, Durham University, University Office, Old Elvet, Durham DH1 3HP  
e-mail: [e-theses.admin@dur.ac.uk](mailto:e-theses.admin@dur.ac.uk) Tel: +44 0191 334 6107  
<http://etheses.dur.ac.uk>

**Mosquito Borne Diseases in England: past, present  
and future risks, with special reference to malaria in  
the Kent Marshes.**

A copyright of this thesis rests  
with the author. No quotation  
from it should be published  
without his prior written consent  
and information derived from it  
should be acknowledged.

**Robert A Hutchinson**

**Department of Biological & Biomedical Sciences  
University of Durham**

**Submitted for the degree of Doctor of Philosophy  
March 2004**



28 FEB 2005

**Mosquito Borne Diseases in England: past, present and future risks,  
with special reference to malaria in the Kent Marshes.**

Malaria was once common in the marshes of southern England. In this study I investigated why a disease called benign tertian malaria became known as the killer of the marshes and looked at the present and future threat from malaria returning to these marshes. The main focus of research was carried out on the Isle of Sheppey, one of the last places in England to experience an epidemic of malaria.

An historical analysis of malaria was carried out by analysing births and deaths using Parish and Hospital records. Here I make the case that the deaths associated with malaria were more likely to be caused by diarrhoeal diseases and acute respiratory infections.

The present risk of malaria was assessed using several methods. Field surveys showed that populations of *An. atroparvus* on Sheppey were small and severely limited by the few over-wintering sites and the filamentous surface algae needed for the aquatic stages to develop. Local residents found mosquitoes a major nuisance during the summer months, but few of these were likely to be malaria vectors. Overall the risk of local malaria transmission is extremely low and far below that needed to maintain the disease. Searches of 52 aircraft arriving at Gatwick Airport from Africa revealed no malaria vectors suggesting that the risk of importing exotic mosquitoes by aircraft is remote.

Finally, I developed a simple surveillance system that could be used for assessing the threat of future vector borne diseases, using West Nile virus as a model. Routine sampling with MosquitoMagnet traps, a carbon-dioxide baited trap, was extremely efficient at collecting large numbers of potential disease vectors and could be used as a tool for risk assessment programmes.

These studies indicate that malaria is extremely unlikely to ever return to the United Kingdom.

## Acknowledgements

Working in the field is hard but enjoyable. Importantly it gets you to where mosquitoes actually live. Days spent romping around in the field, even in the freezing ice and snow are still inordinately superior to those sitting staring at a computer screen. For this reason alone I wish to thank the following people. Firstly, Professor Steve Lindsay, who has been an inspiration and a constant optimist over the last four years. I thank him for his time, my freedom and his friendship. When conducting any prolonged field work you will meet and greet all manner of people willing to help you. The following people are those I can remember and made life just that bit simpler in the field. Bob Gomes, Alan Johnston, Todd Read, Ken Elms and Barry on the RSPB reserve Isle of Sheppey were all instrumental in enabling me to study mosquitoes in the field.

At Durham I would like to thank Professor Brian Whitton, Dr Nabie Bayoh, Michael Bone and Matt Kirby for their input into my research.

A large part of my research was carried out in libraries and archives and I wish to thank the staff at Sheerness, University of Durham, The Wellcome Trust, The London School of Hygiene and Tropical Medicine and the British Library. Particular thanks go to the staff at the Centre for Kentish Studies, Maidstone for their help with the parish records data.

I wish to thank Professor Chris Curtis, Shahida Begum and Yomi Akinpelu at The London School of Hygiene and Tropical Medicine for helping with PCR and blood meal analysis work.

During the course of this research I have pulled heavily on the resources of my family and friends. I would like to heartily thank Mr William Clark for all his help both in the field and with the microscopy work. My mother helped over a period of many weeks with collecting parish data from microfilms, I thank her for this and all the lunches she bought me.

Lastly I thank my wife Jackie and two children, Sam and Megan for their patience and tolerance over the last four years.

This work was funded by the Natural Environment Research Council grant NER/S/A/2000/03292.

## Table Of contents

Title page	.....	1
Abstract	.....	2
Acknowledgements	.....	3
Table of contents	.....	4
List of table/figure legends	.....	5-9
Declarations	.....	10
Forword	.....	11-15
Chapter 1: History of malaria in the English marshes	.....	16-37
Chapter 2: Present and future risk of malaria in the UK	.....	38-49
Chapter 3: Causes of excessive mortality in coastal marshland communities in early modern southern England	.....	50-79
Chapter 4: Resting behaviour of adult <i>Anopheles atroparvus</i> on the Isle of Sheppey, Kent	.....	80-100
Chapter 5: Identifying the aquatic habitats of <i>Anopheles atroparvus</i> on the Isle of Sheppey	.....	101-125
Chapter 6: The risk of African malaria vectors arriving in the UK by aircraft	.....	126-136
Chapter 7: Perceived nuisance of mosquitoes on the Isle of Sheppey, Kent, UK	.....	137-149
Chapter 8: Mosquito surveillance for vector-borne diseases in southern and central England	.....	150-174
Chapter 9: Conclusions	.....	175-181

<b>Table and Figure Legends</b>		
	<b><i>Foreword</i></b>	
Figure 1	Top right outline of the UK with area in green showing location of Isle of Sheppey. Areas in pink on large map show fields sites used on the Isle of Sheppey.	Page 15
	<b><i>Chapter 1</i></b>	
Table 1.1	Clinical Symptoms of malaria	Page 18
Figure 1.1	Proportion of ague deaths compared to all cause mortality taken from the bills of health London.	Page 21
Table 1.2	Human Blood Index (HBI) of <i>Anopheles atroparvus</i> .	Page 24
Table 1.3	Minimum temperature for parasite development.	Page 26
	<b><i>Chapter 2</i></b>	
Figure 2.1	Annual cases of malaria reported to the PHLs Malaria Reference Laboratory, UK. Where open circle represent all cases of malaria and closed circles are those due to <i>P. falciparum</i> .	Page 43
	<b><i>Chapter 3</i></b>	
Figure 3.1	Father Thames introducing his offspring to the fair city of London (1858).	Page 51
Figure 3.2	Map of North Kent showing parish boundaries and three regions used for baptism burial data.	Page 55
Table 3.1	Comparisons of wealth between different geographical locations by monies and properties left in wills in Lincolnshire.	Page 58
Table 3.2	Decadal census data for all parishes in the three regions used in this analysis showing population figures.	Page 59
Figure 3.3	Regression analysis for the parish of Eastwell, Kent 1801 – 1921 comparing two methods of indices of mortality. Error bars show 95% C.I.	Page 60
Figure 3.4	Comparison of Baptism Burial ratios for 2 marsh communities parishes (Sheppey & Thanet) and 1 inland community (North Downs) using a 7 year moving average 1680 – 1925.	Page 61
Figure 3.5	Monthly mean crude death rates for children aged 0-9yrs in two marsh regions (Sheppey & Thanet) and one inland region (North Downs) 1813 – 1925.	Page 61

Table 3.3	Results of Tukey's Test showing differences between mean baptism/burial ratios for 3 regions over 5 time periods. Regions in columns compared to regions in rows.	Page 62
Figure 3.6	Mean number of deaths for four regions. Graph A shows absence of peak in August-September whilst B & C show peaks during this period. Graph D shows Durham parishes an area in which vivax was never considered a problem but still showing a September peak.	Page 63
Figure 3.7	Seasonality of cases of respiratory and gastro-intestinal diseases in children under 9 years old at Kent General Hospital for a period when malaria was extremely uncommon. 1881-1924.	Page 64
Table 3.4	Results of paired t-tests for the mean number of deaths in June – July compared with August – September over a 225 year period for three regions in Kent.	Page 65
Table 3.5	Results of paired t-tests for mean number of deaths in March compared with April for three regions in Kent.	Page 65
Figure 3.8	Seasonality of all salmonella infections in the UK 1997-2000.	Page 66
Table 3.6	Main cause of death for different age groups recorded at Kent General Hospital 1881 – 1924.	Page 67
Table 3.7	Comparison of mortality between <i>P. falciparum</i> and <i>P. vivax</i> malaria.	Page 68
Figure 3.9	Major causes of death among children under five. Data from Child and Adolescent Health Progress Report 2000-2001.	Page 68
	<b>Chapter 4</b>	
Plate 4.1	Female <i>Anopheles atroparvus</i> over-wintering in a concrete pipe on the Isle of Sheppey.	Page 81
Figure 4.1	Spitend hide. A bad over-wintering site.	Page 88
Figure 4.2	Old School House. A good over-wintering site.	Page 88
Figure 4.3	Experimental design for resting site experiment. Six black bins were either raised to a height of 1m from the ground (n = 3) or situated directly on the ground (n = 3).	Page 89
Figure 4.4	Mean number of indoor resting males and females from five buildings on the Isle of Sheppey 2001 – 2002.	Page 91



Figure 4.5	Mean number of fed and unfed <i>An. atroparvus</i> collected from five resting sites on the Isle of Sheppey, Kent.	Page 92
Table 4.1	Blood meal analysis of 104 <i>An. atroparvus</i> from four resting sites on the Isle of Sheppey.	Page 93
Table 4.2	Ovarian stages of 232 <i>An. atroparvus</i> for the year 2002	Page 93
Figure 4.6	Proportion of parous <i>An. atroparvus</i> collected resting in building from November 2001 until March 2003.	Page 94
Figure 4.7	Log <sub>10</sub> time in minutes at each temperature range in positive or negative over-wintering sites within ten temperature zones.	Page 94
Figure 4.8	Cumulative survival for two cohorts of 60 <i>An. atroparvus</i> mosquitoes at two sites on the Isle of Sheppey, Kent from 29 <sup>th</sup> November 2001 – 4 <sup>th</sup> April 2002.	Page 95
<b>Chapter 5</b>		
Plate 5.1	Larval site for <i>Anopheles atroparvus</i> showing dense growths of vegetation favoured by this species.	Page 102
Figure 5.1	Map of the Isle of Sheppey showing the populated northern part and the marshland areas of the south. Regions shaded represents areas covered in larval survey.	Page 106
Table 5.1	Water bodies used for larval sampling	Page 107
Plate 5.2	Collecting with larval dipper.	Page 108
Figure 5.2	Daily maximum and minimum surface water temperature taken by a surface mounted temperature probe from a weather station, Isle of Sheppey.	Page 110
Figure 5.3	Daily maximum and minimum air temperature taken from a weather station, Isle of Sheppey. Day 1 starts at 14 <sup>th</sup> June 2003 ending at 26 <sup>th</sup> September 2003.	Page 110
Figure 5.4	PCR results of <i>An. atroparvus</i> . Lanes 1-4 Laboratory strain from London School of Hygiene & Tropical Medicine. Lanes 5-8 adults raised from larvae from larval sites on the Isle of Sheppey. Lane 9 is negative control. Number to right show Base Pair sizes of ladder marker. <i>An. atroparvus</i> at 117 bp.	Page 111

Table 5.2	Independent t-test results for water measurements at sites either positive or negative for <i>An. atroparvus</i> larvae.	Page 111
Table 5.3	Independent t-test results for water measurements at sites with or without <i>Enteromorpha</i> and with or without other species of Algae.	Page 112
Table 5.4	Results of logistic regression model	Page 113
Plate 5.3	Typical <i>An. atroparvus</i> breeding habitat showing surface algae	Page 114
Table 5.4	Species collected in addition to <i>An. atroparvus</i> during larval survey.	Page 115
Figure 5.5	Proportion of life stages for a sample of 751 larvae (stage I to IV) and pupae collected from June to September 2002.	Page 116
Figure 5.6	Proportion of larval stages for four months. N = number of sites sampled.	Page 117
<b>Chapter 6</b>		
Plate 6.1	Aircraft such as this Boeing 747 are able to transport mosquitoes across continents in a few short hours.	Page 127
Plate 6.2	Aircraft Insecticide containing d-phenothrin 2%W/W	Page 128
Figure 6.1	Numbers of passengers on domestic and international flights during 1990-1999, and numbers of total cases of imported malaria into the UK.	Page 130
Plate 6.3	Cabin searches using a torch and pooter (shown left). Searching under seats (shown right).	Page 131
Figure 6.2	Diagram showing total numbers of invertebrates found in 52 aircraft arriving at Gatwick, London from Africa.	Page 132
Table 6.1	Taxonomic groups found on aircraft arriving from six African destinations at Gatwick, London during June, July, August and September 2001.	Page 133
<b>Chapter 7</b>		
Plate 7.1	<i>Ochlerotatus flavescens</i> biting.	Page 138
Table 7.1	Questionnaire used for telephone survey of Isle of Sheppey residents.	Page 142

Table 7.2	Protective measures against mosquito bites (n = 27, multiple answers possible).	Page 144
	<i>Chapter 8</i>	
Plate 8.1	MosquitoMagnet <sup>®</sup> trap used for West Nile surveillance in the UK	Page 151
Table 8.1	Some of the possible Mosquito Vectors of WNV in the UK (have been shown to transmit WNV, or are thought to have transmission potential in the UK)	Page 157
Figure 8.1	Map of England and Wales showing position of four sites used to for mosquito surveillance	Page 158
Plate 8.2	CDC light trap baited with CO <sub>2</sub> with auto switching for night-time release of gas and lighting used as part of West Nile virus surveillance	Page 159
Figure 8.2	Cross section of a MosquitoMagnet <sup>®</sup> trap. Image courtesy of American Biophysics	Page 160
Table 8.2	Total catch data for CDC light traps and Mosquito Magnet <sup>®</sup> traps from June – September 2003 at four sites in south-east England	Page 162
Table 8.3	Total trap catches for two trap types at four sites in South-East England	Page 162
Table 8.4	Full factorial analysis of variance on Ln (n+1) catch for CDC light traps and MosquitoMagnet <sup>®</sup>	Page 163
Table 8.5	Geometric means of daily catch for all species trapped from June – September 2003	Page 164
Figure 8.3	Regression of mean total catch for CDC light traps and MosquitoMagnet <sup>®</sup> traps	Page 165
Table 8.6	Months when mosquitoes were collected outdoors.	Page 166

## Declaration

None of the material contained in this thesis has been previously submitted for a degree in this or any other university. Chapter 8 has appeared in an altered format as a report to the Department of Health as part of the funding requirement for this research.

Copyright: "The copyright of this thesis rests with the author. No quotation from it should be published without their prior written consent and information derived from it should be acknowledged."

## Foreword

This thesis is the culmination of three years research into vivax malaria in the United Kingdom (UK). This is not purely an ecological study nor a historical account, but an amalgamation of several areas of research including medical history, epidemiology, ecology and entomology. The Isle of Sheppey in Kent was the last place in England to experience a malaria epidemic. This study was carried out on and around the island in order to answer the questions of why malaria was considered to be an important cause of mortality in the marshlands and the likelihood of vivax malaria making a return to UK shores.

### Chapter 1

This chapter provides an overview of malaria in the UK; from the long association of unhealthy coastal marshes, through to the current status of the mosquito vector *Anopheles atroparvus* in the coastal marshes of north Kent.

### Chapter 2

Here I review the current literature on malaria in the UK looking at the possible effects of global warming and changes in human behaviour on malaria transmission.

### Chapter 3

A historical analysis that questions the importance of vivax malaria as a major cause of mortality based on an analysis of data collected from new historical sources.

#### Chapter 4

The ecology of a vector is vital in understanding its potential to transmit disease. This chapter presents the seasonality and adult ecology of *Anopheles atroparvus*, and examines why they select certain sites to over-winter, records how their physiological state and behaviour changes throughout the year.

#### Chapter 5

Larval breeding habitats are described in detail in order to identify what makes a good breeding habitat for *Anopheles atroparvus*. Larval surveys over a wide area of salt marsh provides the first detailed investigation for this species in the UK.

#### Chapter 6

This chapter reports on searches of aircraft arriving at Gatwick airport to examine the likelihood of malaria-infected mosquitoes being brought into the UK from Africa. In 1999 9.8 million people travelled from or to the UK from malarious countries. The potential for both the importation of vectors into the UK by aircraft and a steady inflow of malaria parasites in passengers is a constant risk. The results of searches over a 4 month period are presented.

#### Chapter 7

Chapter seven presents the first UK survey of the attitudes and practises of residents on the Isle of Sheppey in respect to being bitten by mosquitoes. The Isle of Sheppey has a

long history of mosquitoes and malaria but the perceptions and effects on this modern community by the mosquitoes they share it with have not been explored.

## Chapter 8

New and emerging diseases have given cause for concern in many countries. Chapter 8 reports on the implementation of a surveillance program developed to trap and screen British mosquitoes using the possible presence West Nile virus as a model system.

### ***Research Goals***

Vivax malaria was thought to be responsible for the high mortality in the marshes of southern England in the past. The main goals of this research were to find out why malaria disappeared from the Isle of Sheppey, where the last epidemic outbreak of English malaria occurred, and to determine the likelihood of vivax malaria returning to the marshes.

Primary research objectives were;

- ▶ Compare mortality in marshland areas along the north Kent coast with an inland area.
- ▶ Measure the survival, host feeding preferences, resting sites, gonotrophic cycle, and seasonality of *An. atroparvus* on the Isle of Sheppey.
- ▶ Identify the preferred larval habitat of *An. atroparvus*.
- ▶ Assess the nuisance value of biting mosquitoes within the local community on the Isle of Sheppey.
- ▶ Estimate the risk of importation of anophelines via aeroplanes at Gatwick airport.

### ***Study Area***

The vast majority of fieldwork was conducted in the Isle of Sheppey, Kent in South-East England. Separated from the UK mainland by the river Swale, Sheppey is 14.5km long and 5.6km wide (Fig. 1). Sheppey covers an area of 8960 hectares, has a resident population of 30,000 and has one of the largest docks in the UK. The south part of the Isle is low lying and mostly formed from rich clay soils. Here the land is cultivated for arable farming with extensive herds of cattle and sheep. The northern part of the Isle is higher, reaching 70m above sea level. These cliffs, formed from deposits of London clay frequently erode dropping into the sea causing the loss of many hundred of hectares. Most of the population is located in the northern parts of the Isle and all areas of salt marsh are found in the south bounded by the river Swale to the south and the A249 and B2231 roads to the north.



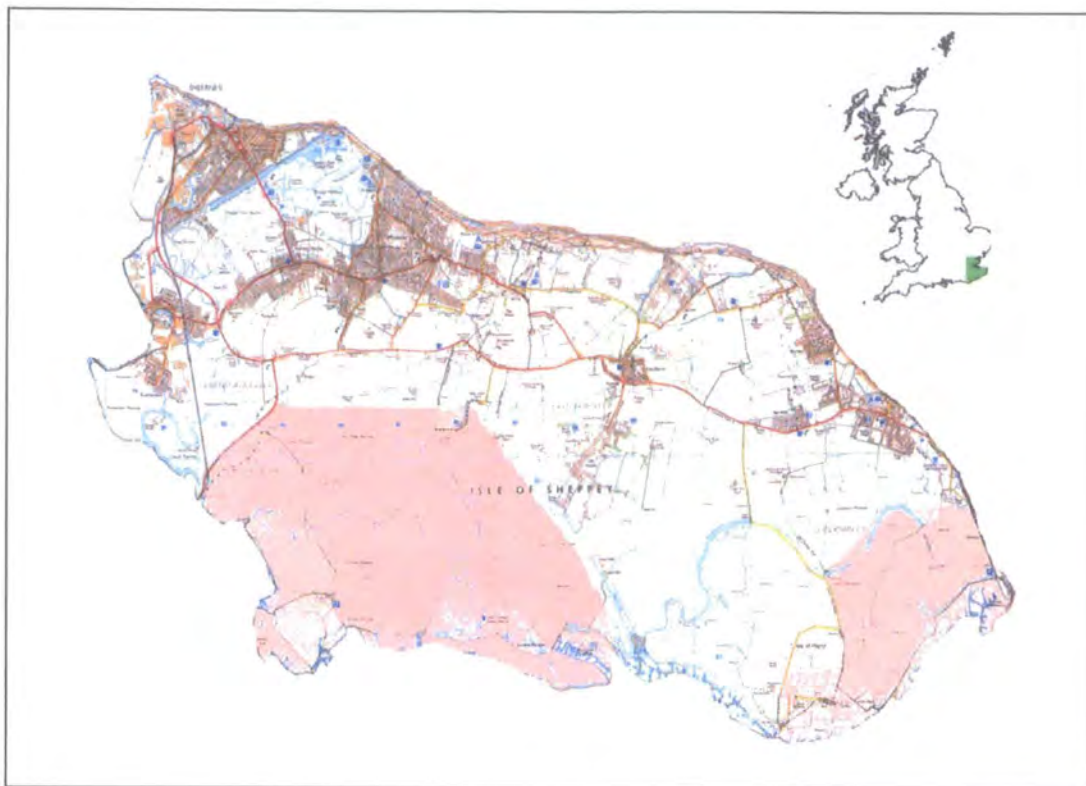

**Figure 1** Top right outline of the UK with area in green showing location of Isle of Sheppey. Areas in pink on large map show fields sites used on the Isle of Sheppey.

## **Chapter 1**

### **History of malaria in the English marshes**

#### **Summary**

##### **Introduction**

Britain has a long history of locally-transmitted malaria. In the UK those areas most badly affected included the Fens, Thames estuary, South-East Kent, the Somerset levels and the Severn Estuary. Malaria was known as tertian fever, quartan fever, intermittent fever and the ague. Malaria in England started to decline from the 1840s onwards, but there was still indigenous malaria in parts of Kent and other low-lying parts of the country at the beginning of the twentieth century. The most recent significant outbreaks occurred in Queenborough, on the Isle of Sheppey, and the Isle of Grain in 1917 and 1918, when there were at least 330 cases of vivax malaria.

##### **Methods**

Literature searches at the libraries of Durham University, The Wellcome Trust, The London School of Hygiene and Tropical Medicine and The British Library were used to search for articles on English malaria.

##### **Results**

Many historical accounts and works of literature describe fevers that support the presence of vivax malaria in the Kent and Essex marshes. The effective use of quinine to successfully treat a proportion of these fevers indicates that at least some of the fevers were indeed malaria. By the 1840's malaria had declined to low levels and had virtually disappeared by the time of the Isle of Sheppey outbreak in 1917.

##### **Interpretation**

There is clear evidence that malaria was present along the salt marshes of the Thames estuary. Decline in malaria was probably due to improved sanitation and changes in animal husbandry.

## Chapter 1

### History of malaria in the English Marshes

#### Global Malaria

Malaria is one of the world's most important infectious diseases causing enormous suffering throughout the tropics and reducing the capacity of many countries to develop economically (Sachs & Malaney, 2002). At present a child dies of malaria every 30 seconds with over 300 million people suffering annually from the disease (WHO, 2003). Most of these deaths occur in Tropical Africa and it is the very young and pregnant women who are most at risk. Despite attempts to control malaria it is estimated that there are between 300-500 million clinical cases each year (WHO, 1994). Of the four species of human malaria, *Plasmodium falciparum* is the most lethal and is widespread throughout the tropics. *P. vivax* is less harmful, but is still responsible for much illness and occurs in both temperate and tropical regions. The problem of malaria is particularly worrying because of the rapid spread of drug-resistant strains of the parasite and the nightmare scenario exists of untreatable forms of malaria occurring. The disease is transmitted by inoculation of the parasite during feeding by certain anopheline mosquitoes, which have breeding sites in both fresh and brackish water.

The malaria parasite is a protozoan and is taken in with the bloodmeal when an anopheline mosquito feeds (Wernsdorfer & McGregor, 1988). The parasite develops within the mosquito, breaking through the gut wall and into the body cavity of the mosquito where it replicates itself inside cyst like structures called oocysts. These eventually rupture releasing sporozoites into the mosquito body cavity. They migrate to the mosquito's salivary glands and enter the blood stream of the next person the mosquito bites. In the human host the sporozoites make their way to the liver and form spherical bodies inside liver cells, called schizonts. These undergo asexual replication producing thousands of merozoites that enter the bloodstream where they invade red blood cells. Each merozoite now becomes a trophozoite inside a red blood cell and here the parasite of *P. falciparum* divide every 48 hours and burst out from the red blood cell. It is this 48 hour cycle of dividing and bursting out of blood cells that

**Table 1.1** Clinical symptoms of malaria

Type	Geographical Distribution	Average Incubation*	Clinical Features	Dormant Liver Phase
<i>Plasmodium falciparum</i>	Tropics and sub-tropics Predominant form of malaria in Africa	9 – 14 days	Fever less regular but approximately 24, 36 or 48 hours Complications include: Cerebral malaria, pulmonary oedema, acute renal failure, profound anaemia, black water fever. Duration of untreated infection 6 – 17 months	No
<i>Plasmodium vivax</i>	Main parasite where malaria is endemic outside of Africa. Range will extend into temperate regions	12 – 17 days Can be prolonged for months or even years	Fever every 48 hours Relatively benign Duration of untreated infection 5 – 8 years	Yes
<i>Plasmodium ovale</i>	Tropical Africa, especially West African coast, occasionally from Asia & South America	16 – 18 days Can be prolonged for months or even years	Fever every 48 hours Relatively benign Duration of untreated infection 12 – 20 months	Yes
<i>Plasmodium malariae</i>	Sub-tropical, tropical and temperate areas	18 – 40 days Can be prolonged for months or even years	Fever every 72 hours Relatively benign Duration of untreated infection 20 – 50 years	No

- There is considerable variation in both the upper limits of incubation times and the period of becoming infected and displaying symptoms.

Data from Gilles & Warrell 1993

causes the typical clinical symptoms of fever in patients. After several cycles of replication in the red blood cells some merozoites develop into micro and macrogametocytes. If these are taken up within a bloodmeal by a suitable mosquito the male and female gametes join inside the mosquito gut to form a zygote called an ookinete, this passes through the gut wall and the cycle begins again. In vivax malaria some sporozoites remain in the liver cells becoming dormant and periodically release merozoites into the blood, giving rise to relapses of the disease. This dormant liver stage does not occur with falciparum malaria. The clinical symptoms of four human malaria parasites are show in Table 1.1.

### English Malaria

English malaria throughout this work refers to *P. vivax* malaria as all evidence from the works of Talbor 1672, Sydenham 1848, Newman 1919, James, 1929 and Shute, 1944 and others suggest. For the period of history being studied here the distribution of mosquitoes and the coastal distribution of vivax rules out the possibility of *P. falciparum* malaria, as seen on the African continent today, causing infections in the UK. Only one species currently in the UK can possibly act as a vector for *P. falciparum* malaria, but it does not have a coastal distribution. There is a possibility that the European strain of *P. falciparum* malaria could have been transmitted in the past, but this strain is now extinct and the question can never be answered with a sufficient degree of accuracy. Descriptions of fevers and ague have left little doubt that vivax occurred along coastal tracts but it was Dobson who made the association between high mortality in people living in marsh communities along the southern UK coastline and malaria. This conclusion by Dobson however seems to over look the benign nature of vivax malaria. This study looks at mortality, the only measure possible for health using parish registers to see if other more plausible diseases could have resulted in the particularly unhealthy marshes.

Britain has a long history of locally-transmitted malaria. Indeed it is thought to have been a leading cause of death in many marshland communities around the English coast between the 16<sup>th</sup> and 19<sup>th</sup> centuries (James, 1929; Dobson, 1994). The high prevalence of malaria in the 16<sup>th</sup> century coincided with the arrival of many Dutch refugees who came to England's marshes to escape the Catholic persecution in

Holland (Cracknell, 1959). Malaria was endemic in Holland (Shute, 1944) and it likely that many Dutch refugees would have brought *P. vivax* with them.

In the UK those areas most badly affected included the Fens, Thames estuary, South-East Kent, the Somerset levels, the Severn Estuary, the Holderness of Yorkshire (Dobson, 1994) and coastal districts of the Firth of Forth (Ritchie, 1920) in Scotland. Using Parish records to estimate mortality, Dobson showed that burials exceeded baptisms for much of the 17<sup>th</sup> and 18<sup>th</sup> centuries in the marshland communities of Kent and Essex (Dobson, 1980; 1989c; 1994). Whilst crude death rates were around 20-30 deaths/1000 people in inland Kent, Essex and Sussex, in the marsh parishes in these counties rates were often twice as great (50 deaths/1000 people). Similarly infant mortality was often three times higher near the coast and estuaries compared with inland areas. The high mortality associated with vivax malaria is unusual since it is usually a non-lethal infection, as seen today in many regions of Asia (Chirimumimba, *et al.*, 1997; Prybylski *et al.*, 1999; Singh *et al.*, 2000). It has been suggested that the high attrition of children may be a result of a particularly lethal form of vivax malaria (Dobson 1994) but this seems unlikely as *P. vivax* has had an association with humans for many hundreds of years, so why would virulence suddenly diminish from the 19<sup>th</sup> century. More likely is that other potentially life-threatening infections, such as acute respiratory diseases and diarrhoea played a much greater role.

Typically there were two peaks of mortality in the marsh parishes: one between January and April with a second smaller peak in the autumn (Dobson, 1994). However, the pattern of malaria cases observed by Newman (1919) revealed that 85% (81/95) of malaria cases occurred in August and September. Basset-Smith reported in Newman (1919) that 67% (4/6) of relapses occurred in April and May. Although this is comparing mortality data with malaria cases Dobson is saying that many of these deaths may have been due to vivax, so the comparison is being made assuming the mortality peaks reported by Dobson, are in part at least caused by vivax malaria. The use of the word ague deserves particular scrutiny as much of the research into English malaria is based on historical accounts referring to ague cases (Nuttal *et al.*, 1901; James 1929; Dobson 1980, 1982b, 1989c, 1994). The word "ague" means acute and is usually used to describe a fever. The word is thought to have originated from Paris or Montpellier in the 12<sup>th</sup> century and was in common use by the 14<sup>th</sup> century

(Bruce-Chwatt, 1976). There are many literary uses of the word throughout the last six centuries from Chaucer (1340-1400), Dickens (1812-1870) and Shakespeare (1564-1616). In *The Merchant of Venice*, Salarino says;

“My wind cooling my broth would blow me to an ague, when I thought what harm a wind too great at sea might do.”

Shakespeare makes further use of the word in *Macbeth*;

“Hang out our banners on the outward walls;  
The cry is still 'They come:' our castle's strength  
Will laugh a siege to scorn: here let them lie  
Till famine and the ague eat them up...”

The use of the word is synonymous with ill health and used to portray a person who is shivering with a chill.

Malaria was also encompassed under other descriptive names such as tertian fevers, quartan fevers or intermittent fevers. The difficulties of such general descriptive terms is the degree of accuracy to which they refer to a particular disease. The liberal use of the word ague is amply demonstrated in the Bills of Mortality for

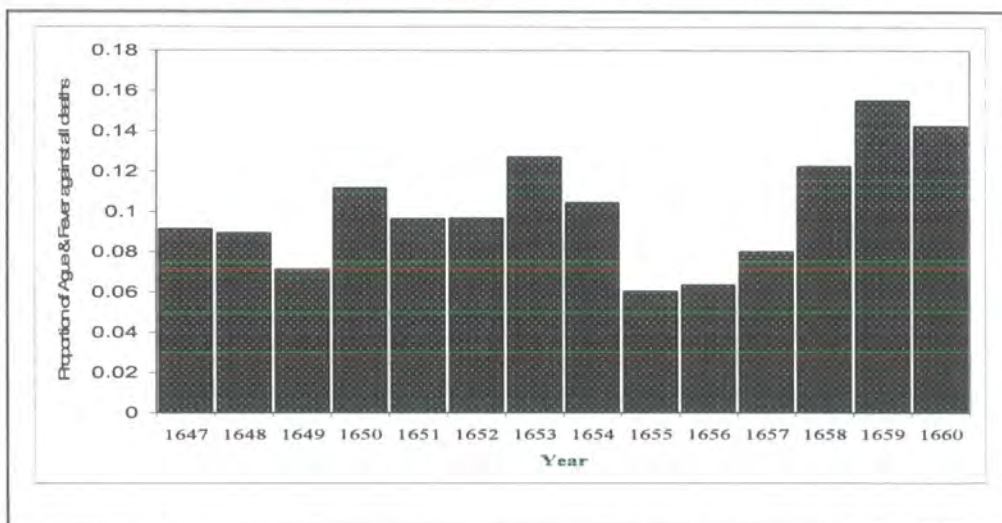

**Figure 1.1** Proportion of ague deaths compared to all cause mortality taken from the bills of mortality London

London which began in 1603 (Grant, 1662). The proportion of deaths attributed to ague in the years 1650 to 1654 and 1658 to 1660 (figure 1.1) comprised of between 10% and 15% of all deaths in London. Even today in highly malarious parts of the

world acute fever is a poor indicator of clinical malaria (Luxemburger, *et al.*, 1998; Luxemburger, *et al.*, 1999; Snow, *et al.*, 1999).

The report by Newman (1919) suggests that the vivax parasite, which was indigenous in the Kent marshes, did not become extinct in the 19th century but was still being transmitted by local *Anopheles atroparvus* in the early part of the 20th century. Certainly this parasite did not exhibit the severity of disease as reported only a century before as patients with parasites in their blood often showed very little sign of infection, reporting only a mild shivering (Newman, 1919).

Malaria was also endemic in London and was once common in the marshes of Lambeth, Westminster and Pimlico (Nuttall *et al.*, 1901). Between 1852 and 1859, 1-6% of patients attending St Thomas's Hospital in London (Nuttall *et al.*, 1901) and 30% in Gravesend hospital were suffering from ague (MacArthur, 1951). Many London cases of malaria may have been contracted in Kent, when Londoners travelled to Kent to pick hops during the summer months (Nuttall *et al.*, 1901). The hop pickers slept together in large numbers in barns and huts, the exact localities in which we find *An. atroparvus* resting today (Dobson, 1994). Such seasonal workers would have provided a yearly influx of parasites to London and served to maintain transmission. Malaria was also a common ailment in the Scottish borders during the 18<sup>th</sup> century, but had disappeared by the beginning of the 19<sup>th</sup> century (Graham, 1901; Nuttall *et al.*, 1901, Ritchie, 1920). Needless to say that all such insalubrious haunts were well-recognised as such by local people and, those that could afford to, lived away from the marshes.

Newcomers to the marshes were highly susceptible to malaria. When Daniel Defoe visited the Essex Marshes in 1722 (Defoe, 1742), he found the local men, raised in the marshes, to be a hardy lot. But they married women from the interior who seldom lasted more than six months in the marshes before contracting ague. As a consequence of this mortality, many men had had more than five wives. Such was the influence of malaria in these regions that it was the men and boys who would milk the sheep, as women were more likely to suffer from the ague when exposed to the foulness of the marsh airs (Cracknell, 1959).



Malaria in England started to decline from the 1840s onwards (James, 1929; Nicholls, 2000), but there was still indigenous malaria in parts of Kent and other low-lying parts of the country at the turn of this century (Ross, 1918). The most recent significant outbreaks occurred in Queenborough, the Isle of Sheppey (James, 1929) and the Isle of Grain (Newman, 1919) in 1917 and 1918. This outbreak originated from infected soldiers returning from Salonika in Greece carrying *P. vivax* parasites resulting in at least 330 cases of vivax malaria. From 1917 to 1952 there were 566 cases of indigenous malaria of which 90% were in or near coastal areas of South-East England (Shute, 1944). Most of these occurred between 1917 and 1921, after which outbreaks were sporadic with rarely more than two cases reported from an individual county each year. Only 34 such cases were reported between 1941-1948 (Shute, 1949). All of these reported cases were of vivax malaria, except for one case of falciparum malaria in Liverpool (Blacklock & Carter, 1920b; Blacklock, 1921). However, this case is such an unusual occurrence that an infective mosquito brought in from overseas, rather than local vectors, may have transmitted it. The last known cases of indigenous vivax malaria occurred in London in 1953 when two people were discovered suffering from malaria. The vector in this case was most likely *An. plumbeus* which was found breeding in a tree hole near to the house of one of the patients (Curtis & White 1984).

#### Mosquito vectors

Of the many different species of mosquito, it is only the anophelines that transmit human malaria. There are currently 18 species of anophelines in Europe of which five occur in the UK. All UK species are capable of transmitting malaria, but because of their different ecologies vary markedly in their efficiency as vectors. Two of these, *An. atroparvus* and *An. messeae*, belong to the *An. maculipennis* complex and are morphologically indistinguishable, being separated only by patterns on the eggs (Falleroni, 1926) and by polymerase chain reaction. Throughout Eurasia the main vector species is *An. sacharovi* but in northern Europe *An. atroparvus* is probably the most important vector for a number of reasons. Importantly, it feeds readily on people. The proportion of blood meals taken from humans (human blood index) varies from 20% to 84% in adult females collected indoors; (table 1.2) levels comparable to that found with some African vectors (Lindsay & Birley, 1996). *An. atroparvus* spends much of its adult life indoors and females continue to feed indoors during the winter without developing eggs. Swellengrebel and Nyhamp (1934) found 60% to

80% of indoor-resting females in bedrooms. It can also occur in large numbers, and over 50 have been collected from one house and an estimated 10,000 from a single farm on the Isle of Grain in Essex in 1920 (Vaile & Miles, 1980). It breeds in brackish water more extensively than freshwater and is often found in pools and ditches along the South-East coast, although it may occur inland occasionally (Nuttall *et al.*, 1901; Rees & Snow, 1990 ).

**Table 1.2** Human Blood Index (HBI) of *Anopheles atroparvus*

Country	Resting place	Number	HBI (%)	Reference
Spain			24	(Garrett-Jones <i>et al</i> 1980)
Spain	Houses		40	(Pittaluga 1932)
Netherlands			84	(Swellengrebel & De Buck 1938)
Netherlands			20-60	(Swellengrebel & De Buck 1938)
Netherlands	Stables	400	16-60	(Swellengrebel & Nykamp 1934)
Netherlands	Houses	2	40	(Olavarria & Hill, 1935)

In the past increased numbers of human deaths occurred in summers suffering drought and this was thought to result from the marshes drying out, forming pools, ideal for the production of mosquitoes (Dobson, 1994). In addition, the warmer weather would enhance transmission by increasing the rate at which mosquitoes and parasites develop (Lindsay & Birley, 1996). When all these factors are considered together, it is perhaps not surprising that the distribution of *An. atroparvus* coincides fairly well with past patterns of vivax malaria. In contrast, *An. messeae*, the other British member of the *maculipennis* complex, breeds in freshwater, is highly zoophilic, rarely found near the coast and goes into complete hibernation (meaning they suspend blood feeding and egg production, although they are still able to fly and move throughout winter) in early autumn (Shute & Maryon, 1974). *An. messeae* is a vector of vivax malaria in parts of Russia however where it is seems more anthropophilic probably due to vector density (Nikolaeva, 1996). *An. claviger* prefers shaded sites in both fresh and brackish water, and breeds in a variety of habitats including ponds, ditches and rain barrels. *An. plumbeus* is specialised for breeding in flooded tree holes, and is not uncommon in woodland and inner city parks. *An. plumbeus* may have acted as the primary vector in Scotland as *An. atroparvus* has not been recorded in Scotland. *An. algeriensis* is rare, being found only in Norfolk, (Edwards, 1932) and Anglesey (Morgan, 1987; Rees & Rees, 1989). However, it is interesting to see a predominantly

Mediterranean mosquito living within the UK. Dr Edwards who first discovered this species proposed that *An. algeriensis* may have been introduced by plane from its native habitat in the Mediterranean (Marshall, 1938), where it is found in Algeria, Greece, Sicily, Sardinia, Portugal and Spain (Ramsdale & Snow, 2000). *An. claviger* and *An. algeriensis* rarely enter houses and although *An. plumbeus* does, it does not remain there. Thus of all our anophelines, *An. atroparvus*, is considered the most important vector. However, the current status of this insect and the other anophelines in the British Isles is poorly documented and needs to be addressed in order to better quantify the risk of malaria today. Recent evidence appears to be shifting towards *An. plumbeus* as a future threat as this species seems capable of transmitting the *P. falciparum* parasite (Eling, *et al.*, 2003) and has been incriminated in recent *falciparum* cases in Germany (Kruger *et al.*, 2001).

Typically the larvae of *An. atroparvus* appear in early May (Newman, 1919). The adults that emerge will feed indoors and return later to the marshes to lay their eggs. It is a multivoltine species with two to three generations a year (Snow, 1990). In August or September it may feed every other day indoors, but the ovaries will not develop, as the insect prepares to over-winter (Shute, 1945). Although females will feed at intervals throughout winter, they are able to over-winter without feeding, thus they are not obligate winter feeders and prevention of blood feeding over winter will not eliminate a successive generation (De Buck & Swellengrebel, 1934).

### Malaria transmission

It is likely that the more benign malaria parasites, *Plasmodium vivax*, and possibly *P. malariae*, were transmitted in the past, and not the more lethal *P. falciparum*. *Vivax* malaria is better adapted to temperate climates than is *P. falciparum* and clinical surveys carried out in England early in the 20<sup>th</sup> century found only *vivax* parasites (Newman, 1919; James, 1920, 1929; James, 1931). *Vivax* malaria is well suited to temperate climates (Boyd, 1949) since whilst adult mosquitoes undergo a period of quiescence, resting indoors through the winter, the parasites sequester in the liver of a person as hypnozoites. In the spring, when conditions for transmission improve, merozoites are released from the liver to infect red blood cells, before producing gametocytes, the stage infective to the mosquito. This spring release results from an

approximate, 7 month dormancy in the liver. In the mosquito vivax malaria needs 1-2°C lower temperature to maintain the same development rate as falciparum parasites thus enabling vivax populations to expand rapidly at cooler temperatures than can falciparum. Few parasites develop in mosquitoes below 15°C (table 1.3) and thus the season for transmission occurs mainly between June and September (Shute, 1944).

**Table 1.3** Minimum temperature for parasite development.

Parasite	Country	Temp °C	Reference
<i>P. falciparum</i>	India	21.1	Knowles & Basu 1943
<i>P. falciparum</i>	UK	19	MacDonald, 1957
<i>P. falciparum</i>	Italy	18	Grassi, 1901
<i>P. falciparum</i>	Russia	16	Moshkovsky & Rashina, 1951
<i>P. falciparum</i>	Palestine	15	Kligler & Mer 1937
<i>P. vivax</i>	Italy	17.5	Grassi 1901
<i>P. vivax</i>	UK	16	James 1929; Stratman-Thomas 1940;
	Portugal		Cambournac 1942
<i>P. vivax</i>	Russia	15.5	Knowles & Basu 1943
<i>P. vivax</i>	UK	15-16.9	Jancso cited in Newman, 1919
<i>P. vivax</i>	UK	15	MacDonald, 1957
<i>P. vivax</i>	Russia	14.5	Moshkovsky & Rashina, 1951

August to November were reported as the months of highest mosquito survival by James (1931). Hill (1937; quoted in Jetten & Takken 1994) however states that during the height of summer *An. atroparvus* survived for 6 weeks, whilst Shute and Ungureanu (1939) found 60% of *An. atroparvus* survived 3 weeks between 15 - 27° C. These data suggest that the highest rate of survival is between June and November spanning the time of highest transmission, June to August. Dobson (1994) shows that mortality in the marshes produced two yearly peaks, an autumn peak, which she suggests, fits with primary malaria cases, and a spring peak, which was the result of relapses, with possibly a few primary attacks as well. Usually a primary attack of vivax malaria will occur two weeks after an infective bite (James, 1931). If the primary attack is treated, relapses may occur 7-10 months later (James, 1931). Therefore an infection between July and September will result in a clinical attack of malaria in April and May of the following year (James, 1929). In this way the parasite has adapted to overcoming adverse conditions in winter and appears in the blood stream when higher numbers of mosquitoes are biting in the warmer months of the year. Often relapses are repetitive, occurring monthly during the first year of infection. Gametocytes may be present before the relapse as well as during a relapse (Shute, 1945), raising the intriguing possibility that the parasite may initiate fever in

patients in order to increase attractiveness to vectors and increase the probability of transmission.

### Parasite Strains

There is experimental evidence that *An. atroparvus*, *An. messeae*, *An. claviger* and *An. plumbeus* are capable of transmitting six strains of vivax, both from the temperate climates and the tropics (Shute, 1940; 1954). Whilst *An. atroparvus* transmitted European strains of *P. falciparum* (3 from Italy, 1 from Sardinia and 2 from Rumania) (Shute, 1945) they are completely refractory to strains from the tropics (West and East Africa, Malaya and India) (James, 1931; Shute, 1940; Dashkova & Rasnicyn, 1982). There is evidence to show that *An. plumbeus* is able to support tropical *P. falciparum* development to the oocyst stage (Marchant *et al.*, 1998) and recent work has shown it can support complete development under laboratory conditions (Eling *et al.*, 2003) although it is highly unlikely that the parasite could develop within *An. plumbeus* in the UK due to low temperatures. In other words, it is highly unlikely that English vectors could transmit falciparum malaria, the most lethal form, although the potential for vivax transmission remains. It is also unlikely that *P. malariae* will be transmitted locally as it is poorly infective to *An. maculipennis* (James, 1931; Shute, 1945) although such fevers are documented by quacks and physicians of the past (Sydenham, 1848-50; Talbour, 1672). *An. atroparvus* can transmit *P. ovale* (Shute, 1945), but this parasite is rare and of little importance.

### Why did malaria decline?

There is no one simple explanation for the disappearance of malaria from the UK. It probably resulted from a number of different changes occurring at a similar time. As with many examples of public health in Britain, perhaps the most important changes were related to environmental changes rather than therapeutic innovations (McKeown & Record, 1962; McKeown, 1976, Kühn *et al.*, 2003). As Newman stated in 1919, malaria risk is largely dependent on 'the degree to which there is close and continuous association between the malaria carrier, the anopheline, and the susceptible person'. Drainage schemes introduced in the marshlands during the 18<sup>th</sup> century shrank the mosquito breeding sites. The Romans probably initiated marshland reclamation in the UK around 100AD, but the major reclamation was carried out by the Dutchman,

Cornelius Vermuyden, during the 17<sup>th</sup> century (Thirsk, 1957). 40,000 acres of marshland were drained on the Bedford level in Cambridgeshire. As a result of this work surrounding farmland sank as much as 6 metres. During the drainage, which took over 20 years, many watercourses stopped flowing and created ever-diminishing pools, ideal breeding sites for mosquitoes. It is therefore likely that malaria transmission may have intensified, before it abated.

Housing improved and became less suitable for resting mosquitoes that prefer damp and dark quarters. Again the Dutch may have been influential, since Morant wrote in his *History of Essex* in 1765 (Morant, 1768) how the Dutch cottages had two stories with upstairs bedrooms, thus removing the people from their livestock below at night. Clay tiles from such buildings carried dates of 1510, indicating that the numbers of thatched roofs were starting to decline from this period onwards (Cracknell, 1959). Homes became better ventilated, well lit and white washed. Ceilings closed off the roof space favoured by resting mosquitoes. And people changed their sleeping behaviour. Where in the past, due to large family size and low income it was common for people to sleep in the same room, now in the 19<sup>th</sup> century house construction linked with increasing wealth allowed occupants to sleep in separate rooms (James, 1929), often upstairs (Nuttall, 1901), making it more difficult for a mosquito to track down a human bloodmeal. Other ameliorating interventions were related to changes in cattle husbandry. In the past, large numbers of cattle were slaughtered at the end of the autumn because of the lack of winter fodder. But when farmers began growing root crops to feed cattle over the winter months, the number of cattle stabled rose (MacArthur, 1951), providing an alternative source of blood and reducing the chances of malaria transmission. Moreover, people began to keep cattle away from human habitation. Recent studies in the cold highlands of Ethiopia suggest that keeping cattle indoors increases the risk of malaria in people sharing the same room (Ghebreyesus *et al.*, 2000). Other research has shown that domestic animals can enhance rather than reduce malaria transmission when vectors are zoophilic, the infection rate low, and the human:cattle ratio high (Bouma & Rowland, 1995).

At the same time as the environmental changes were taking place, improvements in medical practice also occurred. Quinine, an effective antimalarial, was introduced in the mid-17<sup>th</sup> century, but could only be afforded by the rich. By 1892 the price had

fallen significantly, making it more accessible to those most in need (Shute & Maryon, 1974). There was also better health provision; clinicians moved into the marshes in greater numbers and the roads improved allowing easier access to health facilities (James, 1929). It was also a time to focus on disease prevention by vaccinating against the major killers of smallpox and typhoid. Nutrition improved and there was a gradual improvement in hygiene. The late 18<sup>th</sup> century through to the middle of the 19<sup>th</sup> century saw agricultural prosperity, however as cheap grain began to arrive from New England many workers left the land to work in the towns which provided non-seasonal work and wages. Such migration would have further enhanced the decline of malaria in the lowland marshes (MacDonald, 1949).

Quinine was the first effective medicine against malaria. A plant derivative it is manufactured from the bark of the South American trees *Cinchona succirubra*, *C. ledgeriana*, *C. calisaya* and *C. officinalis*. The discovery by a European of the barks efficacy against malaria is thought to have been first reported around 1623 in the writings of a Genoese physician, Sebastianus Baldus, who had acquired knowledge of cinchona from a priest named Federicus Conti (Jarcho, 1993). The American Indians obtained the bark from an area called Loxa, which in the 17<sup>th</sup> century belonged to Peru, but is now part of Ecuador. There is an apocryphal story that in Lima around 1623 the countess of Cinchona became ill with a tertian fever. An official of the court informed the countess of the virtues of an Indian bark for curing such fevers. The bark was duly obtained and cured the countess. The countess then acquired a large amount of the powdered bark and the famous Jesuit, Juan Cardinal de Lugo, tested it in Italy. This is only one account of several as to the discovery of cinchona (Jarcho, 1993; Rocco, 2003), but although the stories differ the dates remain essentially the same. The bark contains 25 closely related alkaloids and the bark of the roots was particularly rich in these chemicals. Cinchona remained the most effective antimalarial until the isolation of quinine from the bark by two French scientists, Joseph Pelletier and Bienaime Caventou in 1820.

The introduction of cinchona into the UK occurred around 1650, but was not used widely until some 30 years later. Its use is documented by the writings of two prominent exponents, one a trained physician Thomas Sydenham and the other a quack called Robert Talbor. Sydenham writes in his *Observationes medicae* in 1676

(Sydenham, 1848-50) that spring agues (probably due to vivax malaria) should be left to themselves stating that:

“no one that I know of has ever died from them.”

But carries on to explain that for treatment of quartan fevers (due to *P. malariae*) “the only valid drug is the Peruvian bark.”

Robert Talbor born in 1642 moved to Essex in 1671 to study ague and to administer his remedy to the local population. He published his findings in *Pyretologia, a rational account of the cause and cure of agues* (Talbor, 1672). Whilst working in Essex he successfully treated a French nobleman who later introduced him to King Charles II. Charles visited the naval base at Sheerness docks on the Isle of Sheppey on the 7<sup>th</sup> June 1672, and was informed by the French nobleman who had been treated by Talbor of how this “strange ignorant man” had given him a potion that had cured his ague. In July 1672 Talbor was appointed Physician to the King, and later knighted (Siegel & Poynter, 1961). Talbor's ague cure was cinchona, which although available to many physicians, was often not effective due to either incorrect dosage or poor quality. Talbor administered his cinchona, in the form of white powder in wine. A letter, (discovered by Rudolph Siegel in a copy of Leclerc's *Histoire de la Medecine* 1702) written by the French nobleman Talbor had cured describes Talbor's cure as:

“...a powder steeped in a large glass of white wine, the whole of which he order me to drink three times in 24 hours. But the mixture was so thick that my stomach could not tolerate the weight of more than two repeated doses. This however was sufficient to protect me from the fit in such a manner that I was able to embark on my week's service at the Court of King Charles II, who however had to go by water to Sheerness, the most fever-ridden place in the whole of England. I told this little doctor, who gave me permission not only to go there, but also to amuse myself swimming, and even in debauchery if I felt inclined.”

Thus Talbor obviously had extreme confidence in his dosage regime, and more importantly had a supply of good quality cinchona.

Many people also believed in gentian root as a cure for ague, and even in 1690 sizeable quantities were being imported. 342 pounds of gentian root were imported into London between 1682-83, which increased to 3205 pounds in 1694-95 (Jarcho,



1993). This shows that cinchona still had some considerable way to go to becoming known as the single most effective antimalarial treatment.

The use of cinchona was slow to disseminate across the UK, one reason for this was the religious implications of its use, seen as a predominantly Catholic substance many Protestants refused to use the "Jesuits bark". It was also expensive, an advertisement in the London Gazette in 1680 showed the price to be a Guinea for two doses.

Although two doses gives no indication of the amount in weight, it was probably enough to make two of Talbot's wine and powder infusions. Another problem is that the Guinea had no fixed value until 1717 when it was fixed at 21 shillings. At the time of the advert a Guinea was worth between 20 and 30 shillings, but this was a considerable sum of money. In 1820 when quinine was isolated from cinchona bark a very effective and consistent drug was available. This too was expensive initially, costing £1.00 per drachm in 1840, 8s. 6d per ounce between 1875 - 1887, and less than 10d in 1892 (James, 1929). Its widespread use is cited as a factor in the decline of malaria in the UK. Although cinchona was in common use in the Kent marshes by the 1770's quinine was not introduced there until around 1840.

Malaria was present in the UK until after the outbreak of 1918 albeit at a very low level, this is supported by James reporting in 1929 that locals on the Isle of Sheppey reported vivax symptoms the previous summer to the outbreak caused by parasite carrying soldiers. Widespread infections of the disease in coastal areas were greatly reduced by the 1840's. The disease was reported along many of the coastal parishes in South-East England from the 16<sup>th</sup> Century and evidence shows that marsh folk consider it to be a common infection with frequent references to agues. Changes in land use and house construction have removed the vector from its previous close association with man.

Although there is little dispute over the presence of vivax malaria in the UK it is strange that vivax malaria considered globally to be benign was such a killer during the 16<sup>th</sup> to 18<sup>th</sup> centuries along the coastal tracts of the UK. This was why I chose to detail a case study in the Isle of Sheppey where one of the last epidemics of malaria occurred in the UK.

## References

- Blacklock, B. & Carter, H. F. (1920b). Observations on *Anopheles (Coelodiazesis) plumbeus* Stephens, with special reference to its breeding-places occurrence in the Liverpool district, and possible connection with the spread of malaria. *Annals of Tropical Medicine and Parasitology*, **13**: 421-444.
- Blacklock, B. (1921). Notes on a case of indigenous infection with *P. falciparum*. *Annals of Tropical Medicine and Parasitology*, **15**: 59-72.
- Bouma, M. & Rowland, M. (1995). Failure of passive zooprophylaxis: Cattle ownership in Pakistan is associated with a higher prevalence of malaria. *Transactions of the Royal Society of Tropical Medicine and Hygiene*, **89**: 351-353.
- Boyd, M. F. (1949). *Malariology, a comprehensive survey of all aspects of this group of diseases from a global standpoint*. Saunders Company, London. .
- Bruce-Chwatt, L. J. (1976). Ague as Malaria, an essay on the history of two medical terms. *Journal of Tropical Medicine and Hygiene*, **79**: 168-176.
- Cambournac, F.J.C. (1942). *Sobre a epidemiologia do sezonismo en Portugal*. Sociedade Industrial de Tipografia, Lisboa.
- Chirimumimba, G., Tshimanga, M. & Marufu, T. (1997). Factors contributing to high inpatient malaria case fatality rate at Bindura provincial hospital. *Clinical Epidemiology*, **50**: 15S.
- Cracknell, B. E. (1959). Canvey Island: The history of a marshland community. *University of Leicester Occasional Papers*, **12**: 3-47.
- Curtis, C. F. & White, G.B. (1984). *Plasmodium falciparum* transmission in England: entomological and epidemiological data relative to cases in 1983. *Journal of Tropical Medicine and Hygiene*, **87**: 101-114.
- Dashkova, N.G. & Rasnitsyn, S.P. (1982). Review of data on susceptibility of mosquitoes in the USSR to imported strains of malaria parasites. *Bulletin of the World Health Organization*, **60**: 893-897.
- De Buck, A. Swellengrebel, N.H. (1934). Behaviour of dutch *Anopheles atroparvus* and *messeae* in winter under artificial conditions. *Rivista di Malariologia*, **13**: 404-416.
- Defoe, D. (1742-6). *A tour though the whole island of Great Britain*. London. Penguin Classics.
- Dobson, M.J. (1980). "Marsh Fever" - the geography of malaria in England. *Journal of Historical Geography*, **6**: 357-389.
- Dobson, M. J. (1982b). When malaria was an English disease. *Geographical Magazine*, **54**: 94-9.

- Dobson, M. J. (1989c). History of malaria in England. *Journal of the Royal Society of Medicine, supplement 17*, **82**: 3-7.
- Dobson, M. J. (1994). Malaria in England: A geographical and historical perspective. *Parassitologia*, **36**: 35-60.
- Edwards, F. (1932). *Anopheles algeriensis* Theobald (Diptera, Culicidae) in Norfolk. *Journal of the Entomological Society of the South of England*, **1**: 25-27.
- Eling, W., Curtis, C. F., van Gemert, G. J., Curtis, J. and Akinpelu, O. (2003). Susceptibility of *Anopheles plumbeus* to *Plasmodium falciparum*. *European Mosquito Bulletin* **15**: 12 - 13.
- Falleroni, D. (1926). Fauna anofelica italiana e suo 'habitat' (paludi, risae, canali). Metodi di lotta contro la malaria. *Rivista di Malariologia*, **5**: 553-593.
- Garrett-Jones, C., Boreham, P.F.L. & Plant, C.P. (1980). Feeding habits of anophelines (Diptera: Culicidae) in 1971-78, with reference to the human blood index: a review. *Bulletin of Entomological Research*, **70**: 165-185.
- Ghebreyesus, T. A., Haile, M., Witten, K.H., Getachew, A, Yohannes, M, Lindsay, S.W. & Bypass, P. (2000). Household risk factors for malaria among children in the Ethiopian highlands. *Transactions of the Royal Society of Tropical Medicine and Hygiene*, **94**: 17-21.
- Gilles, H.M. & Warrell, D.A. (1993). Bruce-Chwatt's Essential Malariology. Edited by Gilles, H.M. & Warrell, Edward Arnold Division of Hodder & Stoughton, London, England.
- Graham, H.G. (1901). *The social life of Scotland in the eighteenth century*. Adam and Charles Black. London.
- Grant, J. (1662). *Natural and political observations mentioned in a following index, and made upon the bills of mortality*. London, Roycroft: 26.
- Grassi, B. (1901). *Die malaria: studien enines zoologen*. Gustav Fischer. Jena.
- Hill, R.B. (1937). The length of life of *Anopheles maculipennis atroparvus*. *Southern Medical Journal*, **30**: 952-953.
- James, S. P. (1920). Malaria at home and abroad. Jonn Bale, Sons & Danielsson, Ltd. London.
- James, S. P. (1929). The disappearance of malaria from England. *Proceedings of the Royal Society of Medicine* **23**: 71-85.
- James, S. (1931). Some general results of a study of induced malaria in England. *Transactions of the Royal Society of Tropical Medicine and Hygiene*, **24**: 477-525.

- Jetten, T.H. & Takken, W. (1994). Anophelism without malaria in Europe: A review of the ecology and distribution of the genus *Anopheles* in Europe. *Wageningen Agricultural University Papers*, 94.5: 1-61.
- Jarcho, S. (1993). Quinine's predecessor. Baltimore, The John Hopkins University Press.
- Kliger, I.J. & Mer, G. (1937). Studies on the effect of various factors on the infection rate of *Anopheles elutus* with different species of Plasmodium. *Annals of Tropical Medicine*, 31: 71-83.
- Knowles, R. and Basu, B. C. (1943). Laboratory studies on the infectivity of *Anopheles stephensi*. *Journal of the Malaria Institute of India*, 5: 1-29.
- Kruger; A., Rech, A., Su, X-Z. & Tannich, E. Two cases of autochthonous *Plasmodium falciparum* malaria in Germany with evidence for local transmission by indigenous *Anopheles plumbeus*. *Tropical Medicine & International Health*, 6: 983-985.
- Lindsay, S. W. and Birley, M. H. (1996). Climate change and malaria transmission. *Annals of Tropical Medicine and Parasitology*, 90: 573-588.
- Luxemburger, C., van Vugt, M., Jonathan, S., McGready, R., Looareesuwan, S., White, N. J. and Nosten, F. (1999). Treatment of vivax malaria on the western border of thailand. *Transactions of the Royal Society of Tropical Medicine and Hygiene*, 93: 433-438.
- Luxemburger, C., Nosten, F., Kyle, D.E., Kiricharoen, L., Chongsuphajaisiddhi, T. and White, N.J (1998). Clinical features cannot predict a diagnosis of malaria or differentiate the infecting species in children living in an area of low transmission. *Transactions of the Royal Society of Tropical Medicine and Hygiene*, 92: 45-49.
- MacArthur, W. (1951). A brief story of English malaria. *British Medical Bulletin*, 8: 76-79.
- MacDonald, K. R. (1949). *The Isle of Sheppey and Swale*. M.A. Thesis University College London.
- MacDonald, G. (1957). *The epidemiology and control of malaria*. London. Oxford University Press.
- Marchant, P., Eling, W., van Gemert, G.J., Leake, C.J. & Curtis C.F. (1998). Could British mosquitoes transmit Falciparum malaria? *Parasitology Today*, 14: 344-345.
- Marshall, J. F. (1938). *The British mosquitoes*. London, The British Museum.
- McKeown, E. (1976). *The modern rise of population*. London, Edward Arnold.

- McKeown, T. & Record, R. G. (1962). Reasons for the decline of mortality in England and Wales during the 19th century. *Population Studies*, **16**: 92 - 122.
- Morant, P. (1768). The history and antiquities of Essex. Colchester, J. Fenno.
- Morgan, J. (1987). Re-appearance of *Anopheles algeriensis* Theobald in Britain. *British Mosquito Group Newsletter* **4**: 1.
- Moshkovsky, S.D. & Rashina, M.G. (1951). Epidémiologie et parasitologie médicale à l'usage des entomologistes, Moscow (In Russian, unknown publisher).
- Newman, G. (1919). Reports and papers on malaria contracted in England in 1918. Reports to the Local Government Board on Public Health and Medical Subjects **New Series No 123**: .
- Nicholls, A. (2000). Fenland ague in the nineteenth century. *Medical History*, **44**, 513-530.
- Nikolaeva, N. (1996). Resurgence of Malaria in the former Soviet Union (FSU). *Society for Vector Ecology Newsletter*, **27**: 10-11
- Nuttall, G. H., Cobbett, L. & Strangeways-Pigg, T. (1901). The geographical distribution of *Anopheles* in relation to the former distribution of ague in England. *Journal of Hygiene*, **1**: 4-44.
- Olivaria, J. & Hill, R.B. (1935). Algunos datos sobre las preferencias hématicas de las *A. maculipennis*. *Medicine de los Paises Calidos*, **8**: 169.
- Pittaluga, G. (1932). Le paludisme dans les 'deltas' (Études sur certaines conditions naturelles et experimentales de l'anophelisme dans le delta de l'Ebre, 1926-1930). *Archives Roumaines de Pathologie et Expérimentales et de Microbiologie*, **5**: 5-131.
- Prybylski, D., Khaliq, A., Fox, E., Sarwari, A.R. & Strickland, G.T. (1999). Parasite density and malaria morbidity in the Pakistani Punjab. *The American Journal of Tropical Medicine and Hygiene*, **61**: 791-801.
- Ramsdale, C. & Snow, K. (2000). Distribution of the genus *Anopheles* in Europe. *European Mosquito Bulletin*, **7**: 1-26.
- Rees, A.T. and Rees, A.E. (1989). *Anopheles algeriensis* on Anglesey: the story so far. *British Mosquito Group Newsletter*, **6**: 1-5.
- Rees, A. T. and Snow, K.R. (1990). The distribution of the genus *Anopheles* in Britain. *Dipterists Digest*, **6**: 7-19.
- Ritchie, J. (1920). *The influence of man on animal life in Scotland*. Cambridge, Cambridge University Press.
- Rocca, F. (2003) *The Miraculous Fever Tree*. London. Harper Collins.

- Ross, R. (1918). Mosquitoes and malaria in Britain. *South East Naturalist*, **23**: 52-7.
- Sachs, J. and Malaney, P. (2002). The economic and social burden of malaria. *Nature*, **415**: 680-685.
- Siegel, R. & Poynter, F. (1962). Robert Talbor, Charles II and Cinchona: A contemporary document. *Medical History*, **6**: 82-85.
- Shute, P.G. & Ungureanu, E. (1939). Preliminary report of the longevity of the races of *Anopheles maculipennis*. World Health Organisation, Geneva.
- Shute, P. G. (1940). Failure to infect English specimens of *Anopheles maculipennis* var. *atroparvus* with certain strains of *Plasmodium falciparum* of tropical origin. *Journal of Tropical Medicine and Hygiene*, **43**: 175-8.
- Shute, P. G. (1944). Indigenous malaria and mosquito control in England after the war. *Journal of the Royal Sanitary Institute*, **64**: 85-94.
- Shute, P. G. (1945). Malaria in England. *Public Health*, **58**: 62-5.
- Shute, P. G. (1949). A review of indigenous malaria in Great Britain after the War of 1939-1945, compared with the corresponding period after the 1914-1918 War (with some observations on the aetiology). *Monthly Bulletin of the Ministry of Health*, **8**: 2-9.
- Shute, P. G. (1954). Indigenous *Plasmodium vivax* malaria in London believed to have been transmitted by *Anopheles plumbeus*. *Monthly Bulletin of the Ministry of Health and Public Health Laboratory Service*, **13**: 48-51.
- Shute, P. G. & Maryon, M. (1974). Malaria in England past, present and future. *Journal of the Royal Society for Health*, **94**: 23-29.
- Singh, N., Mishra, S.S., Singh, M.P. & Sharma, V.P. (2000). Seasonality of *Plasmodium vivax* and *P. falciparum* in tribal villages in central India (1987-1995). *Annals of tropical medicine and parasitology*, **94**: 101-112.
- Snow, K. R. (1990). *Mosquitoes*. Naturalists' Handbooks 14, Slough, Richmond Publishing Co.
- Snow, K. (1999). Malaria and mosquitoes in Britain: the effect of global climate change. *European Mosquito Bulletin*, **4**: 17-25.
- Snow RW, Craig M, Deichmann U and Marsh K (1999). Estimating mortality, morbidity and disability due to malaria among Africa's non-pregnant population. *Bulletin World Health Organization*, **77**: 617-618.
- Stratman-Thomas, W. K. (1940). The influence of temperature on *Plasmodium vivax*. *American Journal of Tropical Medicine*, **20**: 703 - 714.

- Swellengrebel, N. H. Nykamp., J.A. (1934). Observation on the invasion of the Wieringmeerpolder by *Anopheles maculipennis*. *Quarterly Bulletin Health Organisation*, **3**: 441-460.
- Swellengrebel, N. & De Buck, A. (1938). *Malaria in the Netherlands*. Amsterdam. Scheltema and Holkema.
- Sydenham, T. (1848-50). *The works of Dr Thomas Sydenham*. London, Sydenham Society.
- Talbor, R. (1672). *Pyretologia; a rational account of the cause and cure of agues, with a successful method for the cure of quartans*. London, R. Robinson.
- Thisk, J. (1957). *English Peasant Farming: The Agrarian History of Lincolnshire from Tudor to Recent Times*. Routledge & Kegan Paul. London.
- Vaile, M. & Miles, S.J. (1980). Mosquitoes and malaria in the North Kent marshes. *Community Medicine*, **2**: 298-301.
- Wernsdorfer, W. H. & McGregor, I. (1988). *Malaria. Principles and practice of malariology*. Edinburgh, Livingston.
- WHO (1994) Control of Tropical Disases. 1. Progress report. Second meeting on interested parties on the control of tropical diseases. World Health Organisation, Geneva.
- WHO (2003). *The African malaria report 2003*. Geneva, World Health Organization: 112.

## Chapter 2

### Present and future risk of malaria in the UK

#### Summary

##### Introduction

Over the last five years there has been considerable interest in the possibility of malaria returning to the United Kingdom (UK). Modelling vivax malaria transmission in the UK using the medium-high climate change scenario shows a spread in the risk of transmission from the South-East of England northwards to the Scottish lowlands by 2020. Since the principal malaria vector in the UK is the mosquito *Anopheles atroparvus*, a brackish water breeder, its distribution will be largely dictated by the extent and location of saltmarshes. Here I discuss how environmental changes may affect the relative abundance and range of this mosquito in the future.

##### Methods

Searches of contemporary literature were undertaken using Web of Science, Ovid Gateway, and CAB Abstracts to assess the risk of malaria in the UK.

##### Results

*An. atroparvus* is thought to be relatively common in the salt marshes of southern England. *An. labranchiae* is a possible new vector with an ecology similar to that of *An. atroparvus*, whilst recent work has shown that *An. plumbeus* can transmit *P. falciparum* malaria. Malaria cases are a concern near international airports and since 1969 there have been 83 such cases reported from Belgium, France, Germany, Italy, Netherlands, Spain, Switzerland, Luxembourg and the UK.

##### Interpretation

The risk of malaria returning to the UK is very remote due to insufficient parasites, few vectors biting people and the prompt treatment of people entering the UK with malaria. However there is a paucity of data on the current status of *An. atroparvus* in the UK and the numbers of vectors reaching UK shores in aircraft remains unexplored.



## Chapter 2

### Present and future risk of malaria in the UK

Over the last five years there has been considerable interest in the possibility of malaria returning to the United Kingdom (Marchant, *et al.*, 1998; Lindsay & Thomas, 2001; Snow, 1999; Snow, 2000), and the effects globally of climate change on vector borne diseases (Hay, *et al.*, 2002; Rodgers & Randolph, 2000; Rodgers & Packer, 1994; Sutherst, 1998; Martens, 1998; Martens, 1999; Martens, *et al.*, 1999). Although the use of modelling and literature reviews certainly have an important place in the research there is no substitute for fieldwork to test predictions made by others. Since the last time that fieldwork on malaria transmission was carried out in the UK was in the 1920s there is clearly a large gap in our knowledge about the present risk of malaria in the country. Present-day distribution maps of mosquitoes (Rees & Snow, 1990) have not been collected in any systematic manner and probably reflect the distribution of entomologists who mostly sample in areas which are convenient to work in and travel to. Models of malaria risk based on ambient air temperature do little to account for the extreme endophilic nature of *An. atroparvus*. Just because the air temperature is below a laboratory based minimum threshold for parasite development means little if the mosquito is resting inside a stable which may be several degrees warmer. Mosquitoes, like all animals will move to an environment that is best suited to their survival. Thus the research reported here takes the novel approach of looking at the current ecology of malaria mosquitoes in the field.

#### Malaria and climate

Temperature and rainfall help govern the level of malaria transmission (Lindsay & Birley, 1996). Temperature is important because it controls how quickly mosquitoes develop, how often the adult females take a blood meal (and thus acquire parasites), it affects adult mosquito survival and governs the length of time taken for the parasites to mature within the mosquito. Rainwater contributes to the breeding sites for many mosquitoes and helps produce a humid environment, conducive for vector survival.

### Malaria and climate change

Health authorities need to remain alert to the possibility of future malaria outbreaks. In Italy, after 40 years of being free of malaria, there have been reports suggesting that local transmission of vivax malaria has reappeared (Baldari, *et al.*, 1998; Simini, 1997). Similarly in 1993 there was a reported outbreak of falciparum malaria in New York in an area where malaria was not previously endemic (Layton *et al.*, 1995). Such outbreaks may well occur in the UK in the future. But they are likely to be small scale and it will be difficult to predict when and where they occur with any great certainty. One of the objectives of the present study was to assess just how likely it is that people would be bitten by malaria mosquitoes in these marshland communities.

Modelling vivax malaria transmission in the UK using the medium-high climate change scenario shows a spread in the risk of transmission from the South-East up into the Scottish lowlands by 2020 (Lindsay & Thomas, 2001). Current areas at risk are aligned with those that show a past history of malaria during the 19<sup>th</sup> century which includes most of South-East England.

The most recent climate change scenarios for the UK using the HadCM2 scenario predict that by 2050 the South-East of England will become 0.9-2.3°C warmer than the 1961-90 mean, and 0.7-1.9°C warmer in Scotland (Doody, 1990). Spring and the summer in particular will become drier in South-East England by as much as 10-20% by 2080, but the north west will become wetter. Year to year variability in precipitation will also increase making the possibility of outbreaks more likely in some years than in others. The diurnal temperature range will also decrease slightly making conditions more suitable for mosquitoes. Predicted accumulated degree days above a maximum temperature threshold of 25°C trebles by 2080 which would shorten larval development rates of vectors, possibly allowing an extra generation of mosquitoes within a season. For outdoor-resting vectors such as *An. plumbeus* the increase in warm days will also allow faster parasite development and thus the period to infectivity will be shorter. Hotter summers may therefore result in longer periods of transmission due to extra generations of mosquitoes, faster development of both parasite and vector and higher biting frequencies.

Since the principal malaria vector is *An. atroparvus*, a brackish water breeder, its distribution will be largely dictated by the extent and location of saltmarshes. The total

area of saltmarsh in the UK is 42,251 ha, with the largest concentration along the Greater Thames Estuary in Essex and Kent 8,525 ha (Davidson *et al.*, 1991). Predicting the future of British coastal wetlands is difficult since drainage and other land 'improvements' are reducing some marshes, whilst others are being created (DEFRA, 2001). Moreover movements in the earth's crust are causing the sea-level to rise by 1-2 mm/year in the South-East (Shennan, 1989), and in some areas by as much as 3mm/ year (Davidson *et al.*, 1991). Mean sea-level rise of 20cm by 2030 and 65cm by 2100 are anticipated (Doody, 1990). Sea level rises by 41cm in East Anglia by 2050s under the Medium-high scenario, Climatic Research Unit (CRU). Sea-level defences around our estuaries prevent the lowlands adapting naturally to saltwater inundation and in such places a rapid rise in sea-level is likely to result in erosion of sediment and salt marshes. On the other hand saltwater intrusion into coastal lowlands (Doody, 1990) may act to increase the breeding sites of *An. atroparvus*.

### New vectors

One cause of concern is the introduction and establishment of new vectors in the country. *An. labranchiae* and *An. sacharovi* are the most efficient vectors in Western Europe (Bruce-Chwatt & Zulueta, 1980). Both have coastal distributions in the Balkans and Italy, breeding in brackish water (Bruce-Chwatt & Zulueta, 1980). Development of *An. sacharovi* can occur at 10°C–12°C (Saliternik, 1957) whilst *An. labranchiae* needs 20°C (Monsa, 1937). Although *An. labranchiae* has a higher optimal developmental temperature than *An. atroparvus* its ecology is similar since it is an indoor-resting mosquito, feeding readily on people, with a quiescent stage in the colder months spent in buildings. With the increased interchange of goods, labour and tourists throughout Europe the risk of importation of mosquitoes is one that will increase in the future. Just such an introduction has already occurred. *An. algeriensis*, a mosquito predominantly found in the Mediterranean, was recognised in the UK 70 years ago. Predicting when and where such outbreaks will occur is extremely difficult, but it is possible to define suitable areas if the climate envelope in which the vector resides can be identified and mapped (Lindsay *et al.*, 1998; Sutherst, 1998; Rogers & Packer, 1994).

### Airport and imported malaria

Aircraft travelling from malaria-endemic countries may bring infected mosquitoes into non-endemic countries. Such outbreaks occur around international airports and since 1969 there have been 83 such cases reported from Belgium, France, Germany, Italy, Netherlands, Spain, Switzerland, Luxembourg and the UK (Danis *et al.*, 1999; Guillet *et al.*, 1998; White, 1985; Bruce-Chwatt, 1982; Gratz *et al.*, 2000). Attacks of falciparum malaria can be severe in those that lack immunity with a case fatality rate of 40% if untreated (WHO, 2003). An excellent example of airport malaria is given by Curtis and White (1984) who documented two cases of falciparum malaria presumably transmitted by a mosquito brought in by plane from Africa.

As the world heats up, areas suitable for supporting malaria vectors and the malaria parasite they transmit will expand into temperate regions and the tropical highlands (Martens, 1998; Sutherst, 1998; Lindsay *et al.*, 1998) although it is likely that there will also be areas where malaria transmission will disappear. Although there can be additional or even other reasons for the presence of malaria in previously free regions (Hay *et al.*, 2002). As malaria endemic areas expand and as jet travel continues to increase the likelihood of travellers returning to the UK with malaria is likely to grow. Currently air travel is growing at approximately 11% per annum based on Civil Aviation Authority data from 1990 to 1999 (CAA, 2000). Flights globally have increased from 56.9 million in 1990 to 133.5 million in 1999. Despite the initial drop in travel after the events of September 11<sup>th</sup> in New York air travel is expected to remain a growth sector. On the other hand it is hoped that major international initiatives will reduce malaria worldwide, including the Roll-Back malaria programme (WHO, 2002); The Global Fund to Fight AIDS, Tuberculosis & Malaria (Global Fund, 2002) and the Bill & Melinda Gates Foundation (Annual Report, 2002).

Although malaria is a notifiable disease in the UK many people, especially Asians and Africans, are asymptomatic or only passing through the UK and these infections are not reported, these people provide a parasite load without exhibiting symptoms, yet would be just as likely to receive a mosquito bite (Bruce-Chwatt *et al.*, 1974; Bruce-Chwatt, 1975; Bruce-Chwatt, 1982; Bradley, 1989). Presently there are over 2,000 cases of malaria reported each year to the Public Health Laboratory Service Malaria Reference Laboratory (figure 2.1) and of these around 67% are infections with *P. falciparum*.

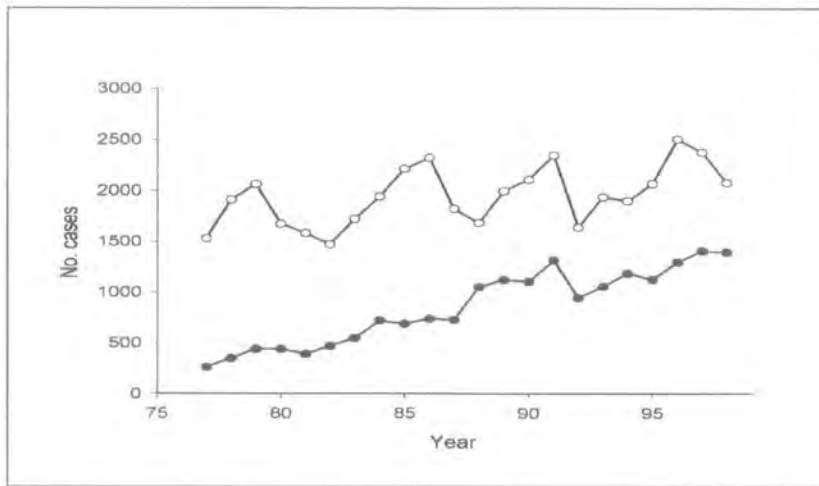

**Figure 2.1** Annual cases of malaria reported to the PHLS Malaria Reference Laboratory, UK. Where open circle represent all cases of malaria and closed circles are those due to *P. falciparum*.

Data courtesy of Dr David Warhurst

What is of concern here is the inexorable rise in falciparum cases. In the last 10 years there have been 81 deaths, 95% of these due to falciparum malaria. From 1973 -80 73% of imported vivax cases came from Asia. For the period 1975-80 immigrants accounted for 31.2 % of malaria patients in the UK. Other groups at risk were tourists (10.6%) and business travellers (7.1%; Bruce-Chwatt, 1982). In 1999 there were 2045 cases of which 73.5% were *P. falciparum* and 18.3% *P. vivax*. In this same year there were 14 deaths. The number of imported falciparum cases is increasing whilst vivax malaria seems to be falling, this may be due to better use of prophylaxis, or just increasing numbers of people travelling to areas with falciparum, or possible both these factors. A major problem, that is unlikely to be resolved in the immediate future, is the growing problem of multi-drug resistant parasites, particularly in South-East Asia (Bradley, 1989; Potkar *et al.*, 1995; Memon *et al.*, 1998; Na *et al.*, 1999; Singh, 2000; Croft & Geary, 2001; Wellems & Plowe, 2001). The possibility of encountering totally drug resistant parasites in the future is a real possibility. Travellers need to be told that there is no vaccination against malaria, that personal prophylaxis should be practised, that malaria is widespread as ever and is likely to remain so for many years (Shute & Maryon, 1974).

*P. vivax and public health in the UK.*

The overwhelming majority of cases of malaria diagnosed in the UK occur in people who have been infected abroad. Occasionally, however, cases of malaria occur in the UK where the route of acquisition is not immediately apparent from travel history. These cases can be termed “cryptic”. Firstly the different mechanisms of contracting malaria need to be explained. Indigenous malaria means malaria contracted by a person in the UK from the bite of a mosquito which also became infected in the UK. The first generation of this malaria, where the mosquito was infected from an imported case, is known as introduced malaria. This should not to be confused with induced malaria, which is where malaria has been contracted from an inoculation other than by a mosquito bite (eg from a blood transfusion). The onset of clinical symptoms also needs some explanation. If fever (and parasites) returns after a gap of several weeks or more after an initial attack of malaria, this is called a *relapse*. Malaria relapse due to activation of liver stages is known as *recurrence* (seen in *P. vivax* and *P. ovale*), but if it is the result of the persistence of red blood stages (seen in *P. falciparum* and *P. malariae*) is called *recrudescence*.

A person may not have travelled recently but may have become infected with malaria some time ago in an endemic area. The infection may even be detected incidentally in the course of a blood examination taken for some other indication. The incubation period of the less severe types of malaria may be very prolonged. In addition, *P. vivax* and *P. ovale* have latent liver phases and so recurrence may occur some time after an initial clinical infection, which may have been missed or unreported. Around 8% of both vivax and ovale malaria cases present more than a year after returning to the UK. Sub-clinical infection or recrudescence may also occur with plasmodium species that do not have a latent liver form, for example in people who have spent considerable time in endemic areas and may have developed partial immunity. About 0.8% of falciparum malaria cases present later than six months after the stated date of arrival in the UK, and 0.3% later than one year after arrival. There is ethnic variation in this proportion as those of Caucasian origin present earlier (only 0.3% later than six months after arrival) than those of African or South Asian origin (over 1.3% present after six months and around half of these after more than one year) (Bruce-Chwatt & Abela-Hyzler 1975; Wernsdorfer & McGregor, 1988; Bradley, 1989).

Although person-to-person transmission is considered rare, malaria can be directly transmitted without the intervention of a mosquito by transfusion of infected blood

(Mingai, *et al.*, 2001), implantation of other infected human tissues (Fischer, *et al.*, 1999), or by mother to child transmission during pregnancy. It can also be transmitted by injecting drug users sharing needles (Bastos, *et al.*, 1999). By analogy with other blood borne infections, sharing of other personal equipment such as razors/toothbrushes may also pose a theoretical risk. Transmission to a healthcare worker has been documented by a needlestick injury from an infected patient (CDSC, 1997). Although transmission has not been documented as a result of infected healthcare workers performing exposure prone procedures on patients, this has been thought to be the most likely, though unproven, explanation in at least one incident (CDSC, 2003). Nosocomial transmission can also occur via cross contamination of materials/fluids used invasively.

Recent changes in health policy have seen the establishment of the Health Protection Agency (HPA) which advises the Department of Health on issues of vector borne diseases and their surveillance. The HPA has provided guidelines for the detection and treatment of cryptic cases of malaria in the UK. The healthcare system within the UK has procedures in place to identify practically all cases of malaria presenting to a healthcare facility. Travel history provides a clear indication of risk and the period of time since travel should allow for recurrence, recrudescence and relapse. With the current distribution of potential malaria vectors within the UK having minimal contact with malaria parasite carriers the public health infrastructure in the UK need only to remain vigilant and aware of the need for effective prophylaxis for travellers.

## **Conclusion**

The risk of malaria returning to the UK is very remote due to insufficient parasites and vector/host interaction. The likelihood of people returning with malaria, developing gametocytes, visiting an area at the right time to be bitten by an anopheline, that mosquito surviving long enough, within an environment with suitable temperatures and then biting another person who is susceptible is extremely remote. . There is a paucity of data on the current status of *An. atroparvus* in the UK and the numbers of vectors reaching UK shores in aircraft. The aim of this research is to provide these data allowing a more accurate assessment of malaria in the UK to be made based on actual current data.

## References

- Baldari, M., Tamburro, A., Sabatinelli, G., Romi, R., Severini, C., Cuccagna, G., Fiorilli, G., Allegri, M.P., Buriani, C. & Toti, M. (1998). Malaria in Maremma, Italy. *Lancet*, **351**: 1246-1247.
- Bastos FJ, Barcellos C, Loundes CH, Friedman SR. (1999). Co-infection with malaria and HIV in injecting drug users in Brazil: a new challenge to public health? *Addiction*, **94**:1165-7411.
- Bill & Melinda Gates Foundation Annual Report. (2002). <http://www.gatesfoundation.org>
- Bradley, D. J. (1989). Current trends in malaria in Britain. *Journal of the Royal Society of Medicine: supplement 17* **82**: 8-13.
- Bruce-Chwatt, L., Southgate, B. & Draper, C. (1974). Malaria in the United Kingdom. *British Medical Journal*, **2**: 707-711.
- Bruce-Chwatt, L. J. & Abela.-Hyzler. P. (1975). Malaria and its surveillance in the United Kingdom. *Health Trends*, **7**: 18-23.
- Bruce-Chwatt, L. J. (1975). Letter: Malaria in Britain. *British Medical Journal*, **4**: 104.
- Bruce-Chwatt, L. J. & de Zulueta, J. (1980). The rise and fall of malaria in Europe. London, Oxford University Press.
- Bruce-Chwatt, L. J. (1982). Imported malaria: an uninvited guest. *British Medical Bulletin*, **38**: 179-185.
- CAA (2000). Civil Aviation Authority. Statistics for number of European and worldwide flights are available for download at: <http://www.caa.co.uk/erg/default.asp>
- CDSC. (1997). Needlestick malaria with tragic consequences. *Communicable Disease Report Weekly*, **7**:247.
- CDSC. (2003). Cryptic Malaria cases in England, 2002. *Communicable Disease Report Weekly*, **13**: 9 – 11.
- Croft, A. M. and Geary, K. G. (2001). The malaria threat. *Médecine Tropicale: Revue Du Corps de Sante Colonial*, **61**: 63-66.
- Curtis, C. F. & White, G.B. (1984). *Plasmodium falciparum* transmission in England: entomological and epidemiological data relative to cases in 1983. *Journal of Tropical Medicine and Hygiene*, **87**: 101-114.
- DEFRA (2001). High level target 9 biodiversity. Department of the Environment And Rural Affairs: 8. London.



- Doddy, P. (1990). Sea-level rise (coastal conservation). North Sea Report 1990. Marine Forum, London.
- Danis, M., Mouchet, M. Giacomini, T., Guillet, P., Legros F. & Belkaid., M. (1999). Indigenous, introduced and airport malaria in Europe. *Médecine et Maladies Infectieuses*, **26**: 393-96.
- Davidson, N., D. d'A Laffoley, D., Doody, J.P., Way, L.S., Gordon, J., Key, R., Pienkowski, M.W., Mitchell, R. & Duff, K.L. (1991). *Nature conservation and estuaries in Great Britain*. Peterborough, Nature Conservancy Council.
- Fischer L, Sterneck M, Claus M, Costrad Jackle A. (1999). Transmission of malaria tertiana by multi-organ donation. *Clinical Transplantation*, **13**: 491-510.
- Guillet, P., Germain, M.C., Giacomini, T., Chandre, F., Akogbeto, M., Faye, O., Kone, A., Manga, L. & Mouchet, J. (1998). Origin and prevention of airport malaria in France. *Tropical Medicine and International Health*, **3**: 700-705.
- Gratz, N.G., Steffen, R. & Cocksedge, W. (2000). Why aircraft disinsection? *Bulletin of the World Health Organization*, **78**: 995-1004.
- Hay, S. I., Cox, J., Rodgers, D. J., Randolph, S. E., Stern, D. I., Shanks, D. G., Myers, M. F. and Snow, R. W. (2002). Climate change and the resurgence of malaria in the east African highlands. *Nature*, **415**: 905 - 909.
- Layton, M., Parise., M.E. Campbell, C.C., Advani, R., Sexton, J.D. & Bosler, E.M. (1995). Mosquito-transmitted malaria in New York City, 1993. *The Lancet*, **346**: 729-731.
- Lindsay, S.W, & Birley, M.H. (1996). Climate change and malaria transmission. *Annals of Tropical Medicine and Parasitology*, **90**: 573-588.
- Lindsay, S.W., Parson, L. & Thomas C.J. (1998). Mapping the ranges and relative abundance of the two principal African malaria vectors, *Anopheles gambiae sensu stricto* and *An. arabiensis* using climate data. *Proceedings of the Royal Society of London: B*, **265**: 847-853.
- Lindsay, S. W. & Thomas, C. J. (2001). Global warming and risk of vivax malaria in Great Britain. *Global Change and Human Health* **2**: 80-84.
- Marchant, P., Eling, W., van Gemert, G.J., Leake, C.J. & Curtis C.F. (1998). Could British mosquitoes transmit Falciparum malaria? *Parasitology Today*, **14**: 344-345.
- Martens P.(1998). Health & climate change. London: Earthscan.
- Martens, P. (1999). How will climate change affect human health? *American Scientist*, **87**: 534-541.
- Martens, P., Kovats, R. S., Nijhof, S., de Vries, P., Livermore, M. T. J., Bradley, D. J., Cox, J. and McMichael, A. J. (1999). Climate change and future populations at risk of malaria. *Global Environmental Change*, **9**: S89-S107.

- Memon, I. A., Kanth, N. and Murtaza, G. (1998). Chloroquine resistant malaria in children. *Journal of the Pakistani Medical Association*, **48**: 98-100.
- Mingai, M, Tegtmeier, G, Chamberland, M, Parise, M. (2001). Transfusion-transmitted malaria in the United States from 1963 through 1999. *New England Journal of Medicine*, **344**: 1973-89.
- Monsa, E. (1937). Sulle caratteristiche termiche dei focolai di *Anopheles maculipennis*. *Rivista di Parassitologia* **1**: 139 - 153.
- Na, D. J., Han, J. D., Cha, D. Y., Song, I. K., Choi, H. W., Chung, E. A., Park, C. W. & Choi, J. S. (1999). Imported tertian malaria resistant to primaquine. *Korean Journal of International Medicine*, **14**: 86-9.
- Potkar, C. N., Kshirsagar, N. A. and Kathuria, R. (1995). Resurgence of malaria and drug resistance in *Plasmodium falciparum* and *Plasmodium vivax* species in Bombay. *Journal of the Association of Physicians India*, **43**: 336-8.
- Rees, A. T. and Snow, K. R. (1990). The distribution of the genus *anopheles* in Britain. *Dipterists Digest* **6**: 7-19.
- Rogers, D. J. and Packer, M. J. (1994). Vector-borne diseases, models, and global change. Health and climate change. London, *The Lancet*: 19-21.
- Rogers, D. J. and Randolph, S. E. (2000). The global spread of malaria in a future, warmer world. *Science*, **289**: 1763-1766.
- Saliternik, Z. (1957). *Anopheles sacharovi* (favre) in Israel. *Rivista di Parassitologia* **18**: 249 - 265.
- Shennan, I. (1989). Holocene crustal movements and sea-level changes in Great Britain. *Journal of Quaternary Science*, **4**: 77-89.
- Shute, P. G. & Maryon, M. (1974). Malaria in England past, present and future. *Journal of the Royal Society for Health*, **94**: 23-29.
- Simini, B. (1997) First case of indigenous malaria reported in Italy for 40 years. *The Lancet*, **350**: 717.
- Singh, N., Mishra, S.S., Singh, M.P. & Sharma, V.P. (2000). Seasonality of *Plasmodium vivax* and *P. falciparum* in tribal villages in central India (1987-1995). *Annals of Tropical Medicine and Parasitology*, **94**: 101-112.
- Snow, K. (1999). Malaria and mosquitoes in Britain: the effect of global climate change. *European Mosquito Bulletin*, **4**: 17-25.
- Snow, K. (2000). Could malaria return to Britain? *Biologist*, **47**: 176-180.

Sutherst, R. (1998) Implications of global change and climate variability for vector-borne diseases: generic approaches to impact assessments. *International Journal of Parasitology*, **28**: 935-945.

The Global Fund to Fight AIDS, Tuberculosis & Malaria Annual Report (2002/2003).  
<http://www.theglobalfund.org>

Wellems, T. E. & Plowe, C. V. (2001). Chloroquine-resistant malaria. *Journal of Infectious Disease*, **184**: 770-6.

Wernsdorfer, W. H. & McGregor, I. (1988). *Malaria. Principles and practice of malariology*. Elsevier Science Health Science. London.

WHO (2002). Communicable diseases 2002 global defence against the infectious disease threat. Geneva, World Health Organization: 188.

WHO (2003) Africa Malaria Report World Health Organisation, Geneva.

White, G. B. (1985). Airport malaria and jumbo vector control. *Parasitology Today*, **1**: 177-179.

## Chapter 3

### Causes of excessive mortality in coastal marshland communities in early modern southern England

#### Summary

##### Introduction

Mortality in the coastal marshes of South-East England from the 16<sup>th</sup> to the 18<sup>th</sup> century was substantially higher than found inland. Historical evidence strongly suggests that the unhealthiness of the marshes was associated with a regularly occurring fever. Many researchers believe that malaria was the re-occurring fever and that it was the prime reason for this increased mortality in the marshes.

##### Methods

Evidence from the historical literature, baptism and burial data from 13 parishes in inland and marshland communities in Kent from 1701-1925 and inpatient admissions records for Kent General hospital from 1881- 1924 were collected.

##### Results

Anecdotal evidence suggests that water-quality was poor in marshland communities compared with inland where spring water was often used as drinking water. Childhood mortality in the marshes peaked during August and September, coinciding with peaks in common childhood diseases such as diarrhoea and malaria. This peak was still pronounced at the end of the 19<sup>th</sup> century when malaria had virtually disappeared from the UK suggesting that diarrhoea was the major childhood killer, not malaria.

##### Interpretation

Vivax malaria kills few people and increased mortality in the marshes is most likely due to waterborne diseases, including typhoid fever, enteric fever and diarrhoea, in common with many deprived communities today.

## Chapter 3

### Causes of excessive mortality in coastal marshland communities in early modern southern England



Figure 3.1 Father Thames introducing his offspring to the fair city of London (1858).  
Source: Punch, July 3, 1858

#### Introduction

There is overwhelming evidence that lowland coastal marsh regions were less healthy than inland areas at higher elevations during the 16<sup>th</sup> to 18<sup>th</sup> centuries (Dobson 1980; Dobson 1989; Dobson 1994; Dobson 1997). Support for this comes from two main sources: historical records, such as diaries, surveys and travellers accounts which give important, although often anecdotal information on conditions in the marshes (Defoe 1742-6; Hasted 1797-1801), and the more quantitative approach using Anglican parish registers of burials and baptisms to study demographic trends through time (Wrigley & Schofield, 1981). Historical evidence strongly suggests that the unhealthiness of the marshes was associated with a regularly occurring fever. This fever was common

enough throughout the marshes of South-East England to acquire several colloquial names including; “marsh fever” “tertian fever” “intermittent fever” and “ague”(Bruce-Chwatt, 1976).

This fever is commonly believed to have been malaria caused by the malaria parasite, *Plasmodium vivax*. Descriptions of the fevers often show close similarity with the symptoms of vivax (Hunter & Gregory, 1988). Patients with vivax malaria experience headache, malaise, aches and pains especially in the back and legs, lassitude, anorexia and sometimes gastro-intestinal pains and upsets. These symptoms present at a similar time of day every few days. Infection in a fully susceptible person will often result in extended periods of fever lasting days, the name tertian is thought to have been derived from observation in partially immune individuals where the periodicity of fevers is most frequently 48 hours (Kitchen in Boyd, 1949). Vivax malaria is often a chronic infection characterised by bouts of fever with a mean incubation time is 13.4 days. The disease is benign in nearly all cases (Boyd, 1949).

Diagnosis of malaria before 1901 were based solely on clinical signs and symptoms. More compelling evidence that *P. vivax* was the causal agent was provided in 1917 when the parasite was identified by blood films from patients exhibiting the same symptoms as those described over a century earlier (James, 1920). Further evidence that the fever of the marshes was malaria was that the conditions responded to treatment with quinine. The introduction of cinchona into the UK occurred around 1650, but was not used widely until some 30 years later. Its widespread use is cited as a factor in the decline of malaria in the UK (Hackett, 1937). Although cinchona was in common use in the Kent marshes by the 1770's, described by the works of Talbor and Sydenham (Talbor, 1672; Sydenham, 1848) quinine was not introduced there until around 1840.

It is not the case that people suffering from malaria present with a well defined set of symptoms which gives an easy diagnosis. Even today patients with malaria are frequently misdiagnosed. In 1991 in the UK a study of 51 cases of imported malaria showed 16% had diarrhoea, whilst only 12% had splenomegaly, a characteristic often taken as a common occurrence in malaria sufferers (Brook & Bannister, 1993). In Thailand researchers studied clinical predictors of malaria in 1,527 children aged 2-15 years (Luxemburger, *et al.*,1998). Clinical symptoms or signs associated with malaria

were; fever, headache, muscle and/or joint pain, nausea, clinical anaemia, palpable spleen, palpable liver, absence of cough and absence of diarrhoea. None of these symptoms either alone or in combination proved good indicators of malaria. Using only these clinical predictors 28 – 29% of non-malaria febrile episodes were given antimalarial drugs whilst only 49% of actual malaria cases were given antimalarials. Such studies serve to remind that many of the fevers reported as ague were just as likely to have been a non-malarial fever. So although there is little doubt as to the presence of the disease, the extent to which it shaped the mortality patterns through the centuries is uncertain.

The focus of the research reported here is based around the Isle of Sheppey, the last location in the UK to have autochthonous cases of malaria during the 1920s. Obtaining data on deaths for the 18<sup>th</sup> and 19<sup>th</sup> century is possible only through limited sources of records. The most frequently used, and often the only available sources are the parish registers of Anglican churches. These registers were kept by vicars and church wardens in individual parishes and record the ecclesiastical events which occurred in the parish. Information in these parish registers includes; baptisms, burials, marriages and accounts. Although it is generally accepted that these records are not perfect they often represent the only source of such data and have become the main source for historical demographers until civil registration started in 1837. Under-recording due to nonconformist beliefs, deaths occurring before baptism and lost data are all factors which degrade parish register data. These problems have been partially dealt with by applying inflation factors when using registers at a national level but such techniques are not appropriate for comparative studies for either individual or small numbers of parishes due to large local variations in under-recording (Wrigley & Schofield, 1981).

To follow on from Dobson's work that points towards vivax malaria as causing high levels of mortality in marshland populations the following literature and study sites were chosen. This work looks at both the parish records in areas where we know vivax malaria occurred but also looks at evidence from a new source, hospital records that actually show cause of death.

## Methods

### *Literature search*

A literature search was conducted using web based resources including ScienceDirect, Scirus, Medline, and Catchword. In addition to these the libraries of The Wellcome Trust, London School of Hygiene and Tropical Medicine, University of Durham, Sheerness, Maidstone and Canterbury Public Libraries and Records Centres were all used. Two main searches were conducted, firstly for mortality data linked with vivax malaria and secondly the accounts of ague and the use of chinchona. Searches were conducted using the following search terms: Vivax, mortality, seasonality, ague, morbidity, diarrhoea, symptoms, Jesuits bark, quinine and childhood mortality.

### Study sites

Three areas (figure 3.2) were selected for analysis, based primarily on geographical location and availability of parish records. First, The Isle of Sheppey was selected since it is a lowland salt marsh area with a well documented history of malaria. This island has 226 km<sup>2</sup> of marsh land below 5m above mean sea level. The second area was Thanet which is 90km to the east of Sheppey. It is a coastal area but at a slightly higher elevation ranging on average 10 –15m above sea level with a smaller area of salt marsh of approximately 25 km<sup>2</sup>. The third area was the North Downs, 70 km from Sheppey, selected to serve as a non-malarious area due to its higher elevation, 170 m and no marsh.



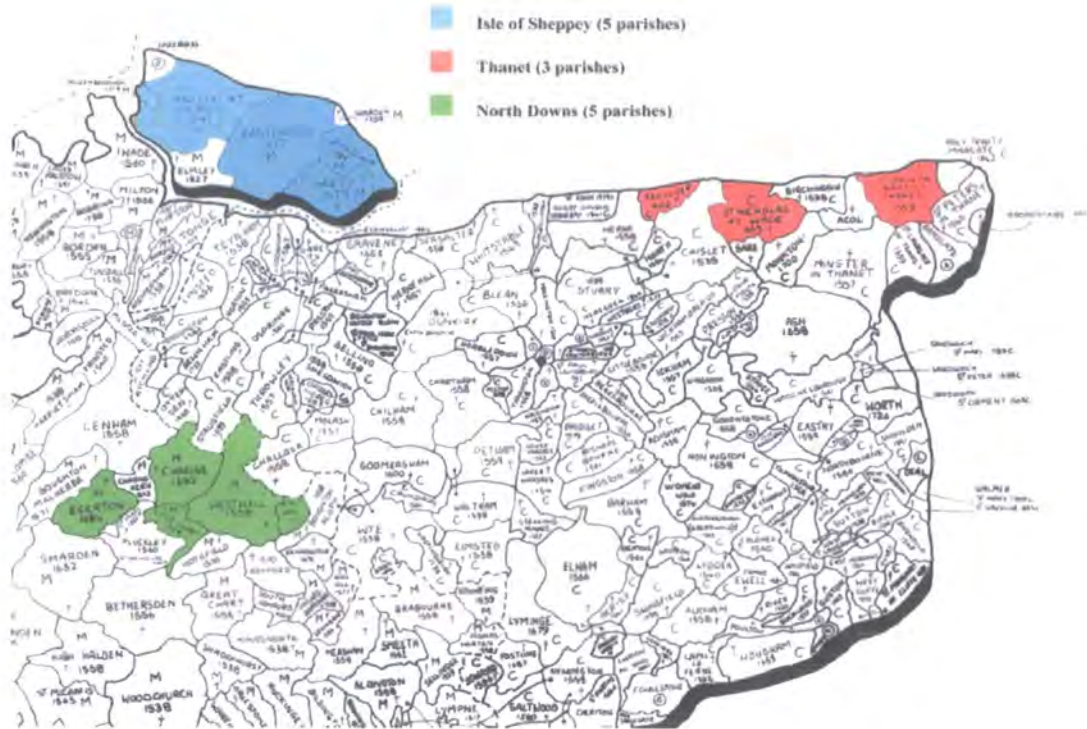

Figure 3.2 Map of North Kent showing parish boundaries and three regions used for baptism burial data.

### Parish records

When collecting parish records an attempt was made to choose parishes that were as close to each other as possible. However this was not always possible as the parish records of some adjacent parishes were not complete for the time period investigated. Records of baptisms and burials were collected from the Centre for Kentish Studies (CKS) at Maidstone, Kent and the Canterbury Cathedral Archives, Kent. Records from 13 parishes were collected dating from 1701 to 1925. Parishes were grouped by geographic region into three areas; Isle of Sheppey (parishes of Queenborough, Minster, Harty, Leysdown and Eastchurch), Thanet (St Nicholas at Wade, St John the Baptist and Reculver) and the North Downs ( Eastwell, Westwell, Little Chart, Charing and Egerton). All parishes with the exception of one (Leysdown) were archived on microfilm and the data transcribed noting the month and year of all burials and baptisms. Records for Leysdown were mostly archived but the original documents for un-archived data was obtained from Father Searle, Eastchurch in Sheppey.

From 1701 to 1813 records only provided the month of each death and not the age of the deceased. After this period, age at death was also collected. Decadal census data for these parish regions was obtained from the Office of National Statistics (ONS) in London.

### Hospital records

Disease data was collected from the admissions register for Kent General hospital at the CKS. This hospital opened in 1832 in Maidstone North-East Kent and served the surrounding region, including the Isle of Sheppey. Data was collected from the inpatient admissions register from 1881 to 1924. All deaths were recorded with the sex, age, year, month and cause for each individual. In addition, all fevers were recorded irrespective of whether the patient died or recovered. Current data on the seasonality of diarrhoea was obtained from published research and the Public Health Laboratory Service at Collindale, London.

### Data analysis

#### *Environmental*

Areas of salt marsh were visualised using ordinance survey maps of the three sites. In terms of amount of salt marsh at each site the following order was noted: Isle of Sheppey > Isle of Thanet > North Downs.

#### *Demography*

Baptism burial ratios (BBR) were calculated using the formula:

$$\text{BBR} = (B_1/B_2) \times 100$$

Where,  $B_1$  = the number of baptisms in time  $t$  and  $B_2$  = the number of burials in time  $t$ .

Decadal census data from 1801 for all parishes was used to compare the crude death rate (CDR) per 1000 with the baptism burial data for each of the parishes used in this study that had census available (table 3.2). CDR was calculated using the following method.

Number of deaths in a year × 1000

Years Population

Comparisons were made using simple linear regression of ratios against CDR. As census data was only available every 10 years a linear approach was used to calculate the intermediate years.

Long term mortality patterns were studied using a 7 year moving average of baptism burial ratios following the protocol of Dobson (Dobson, 1994). As no population data were available until the first census in 1801 crude death rates could not be calculated for nearly half the data set. Monthly seasonality was plotted as mean deaths per month pre-1813 then as CDR per 1000. From 1813 onwards all data was divided into age classes from infants,  $\leq 2$  years, then  $\leq 2-4$  years and subsequent classes in 5 year intervals up to 90 years then a final ten year group. ANOVA was used to look for differences between baptism burial ratios between the three regions for five time periods. Deaths of unknown age were excluded from any analysis but recorded to allow the percentage of lost data to be calculated. Associations between age, month and mean temperature at death were analysed using the regression curve fitting function selecting for linear, quadratic and cubic models. All data was analysed using SPSS software.

## Results

### Analysis of the historical literature

Descriptions emphasizing the poor health of salt marsh areas were found in several sources.

Harris in 1699 reported the Isle of Sheppey to have suffered greatly from malaria, stating that malaria attacks are;

*“in some countries more dangerous in their nature, and difficult of cure, than they are in others; as they are said to be with us in the Hundreds of Essex, and in the Isle of Sheppey”.*

In Hasted’s history of Kent (Hasted 1797-1801) he describes Harty on the Isle of Sheppey as:

*“the unhealthiness of the air deterring all others from attempting to dwell in it”.*

Hasted refers to the ‘lookers’, or ‘marsh men’ who frequented the marshes due to the superior pasture afforded by the marsh environment. It is interesting to note that despite being regions renowned for its unhealthiness, the marshes were productive sites rewarding their inhabitants with increased yields and wealth (table 3.1) over the healthier higher pastures (Thirsk 1957).

Table 3.1 Comparisons of wealth between different geographical locations by monies and properties left in wills in Lincolnshire.

<u>Location</u>	<u>Median Wealth 1530s</u>	<u>Median Wealth 1590s</u>
Marshlands	£24 16s 8d	£70.9s 2d
Wolds	£15 4s 8d	£49.7s 2d
Heath	£15 4s 8d	£49.7s 2d
Fen	£10.16s 10d	£41.12s 0d
Claylands	£10.9s 4d	£30.10 8d

Source: Thirsk 1957.

Data from wills left in different types of environment (table 3.1) show that those living in the marshes were 66% wealthier than those living in heathland and the Wolds (uplands) in the 1530s and 43% wealthier in the 1590s.

### Parish records

A total of 66,717 deaths were recorded from the parish registers. The number of occasions where age of death was not recorded on the burial data for the period 1813 onwards was 6.5% (904) at Sheppey, 1.4% (258) at Thanet and 1.3% (70) at the North Downs. Non-recording was due mainly to suicides and drowned bodies. Most of these deaths were described as “mans body” or “workhouse” age unknown. 74% of records with no age were from these two categories at Sheppey (673), 55% at Thanet (142) and 62% in the North Downs (44).

Table 3.2 Decadal census data for all parishes in the three regions used in this analysis showing population figures.

<b>Sheppey</b>	<b>1801</b>	<b>1811</b>	<b>1821</b>	<b>1831</b>	<b>1841</b>	<b>1851</b>	<b>1861</b>	<b>1871</b>	<b>1881</b>	<b>1891</b>	<b>1901</b>	<b>1911</b>	<b>1921</b>
Queenborough	545	805	8414	786	634	772	973	820	982	1050	1544	2468	3081
Minster	5561	7003	23	7983	8684	11082	-	-	-	-	1306	3207	3059
Leysdown	88	66	45	191	310	272	215	244	196	218	222	151	221
Eastcurch	392	444	21	851	1019	952	996	1013	983	854	784	915	1141
Harty	-	-	-	-	-	-	159	131	157	125	81	87	96
<b>Thanet</b>													
St John the Baptist					5981*								
St Nicholas at Wade	520†	480†	590†	726†	679†	604†			582	548	510	495	
Reculver	252	265	1675	297	286	273	254	257	298	244	256	444	631
<b>North Downs</b>													
Eastwell	136	131	134	97	106	88	126	160	113	125	128	66	77
Westwell	629	684	867	861	1082	1030	1009	988	968	947	926	901	849
Little Chart	217	224	303	315	300	296	304	270	276	313	313	357	265
Charing	851	912	1103	1237	1241	1321	1285	1298	1349	1314	1170	1223	1207
Egerton	731	776	890	866	880	830	816	862	871	795	698	728	682

\* Data from census return for 1841 from microfilm, Canterbury. Empty cells means no data were available. † Data from Religious Worship in Kent, The Census of 1851 Kent Records. (Ed). Margaret Roake 1999. All other data from the Office of National Statistics, London. All data SIC

The high number of unknown deaths recorded in Sheppey was due mainly to the large numbers of adults drowning in the Sheerness dockyards. These deaths were excluded from all calculations as the main focus of this study was on child deaths under 10 years old.

Comparisons of CDR obtained from the census data shown in table 3.2 and the number of births per year for each parish showed very poor correlation to the baptism

– burial ratio for the same period of time. Using linear regression to look at the relationship of the two data sets showed all parishes to exhibit poor correlations. Figure 3.3 shows the relationship for the parish of Eastwell comparing CDR with baptism – burial ratios from 1801 to 1921. This parish gave the best correlation ( $r^2$  0.41,  $P > 0.05$ ).

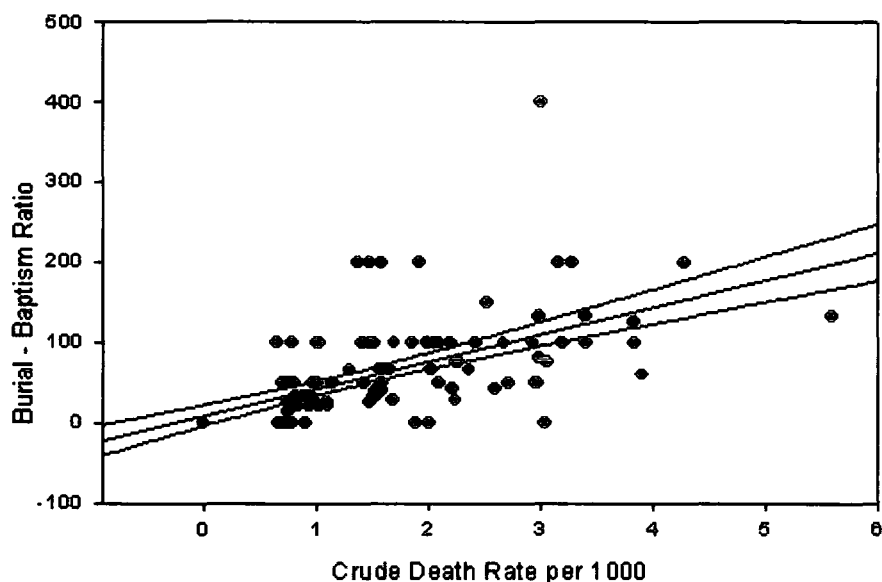

Figure 3.3 Regression analysis for the parish of Eastwell, Kent 1801 – 1921 comparing two methods of indices of mortality. Error bars show 95% C.I.

As each parish was pooled into one of three regions a comparison was made of mean CDR against mean baptism – burial ratios. The relationship for all three regions was poor giving correlation coefficients of; Sheppey  $r^2$  0.026. Thanet,  $r^2$  0.12 and North-Downs  $r^2$  0.28  $P > 0.05$  in all cases.

### Seasonality

Yearly fluctuations in mortality (figure 3.4) shows the excess deaths compared to births, where the value of 1 equals the same number born as dying. Sheppey shows a clear excess of deaths until the 1890s whilst the distinction between Thanet and the North Downs is much less pronounced, although Thanet is less healthy showing more

years with excess deaths than the North Downs.

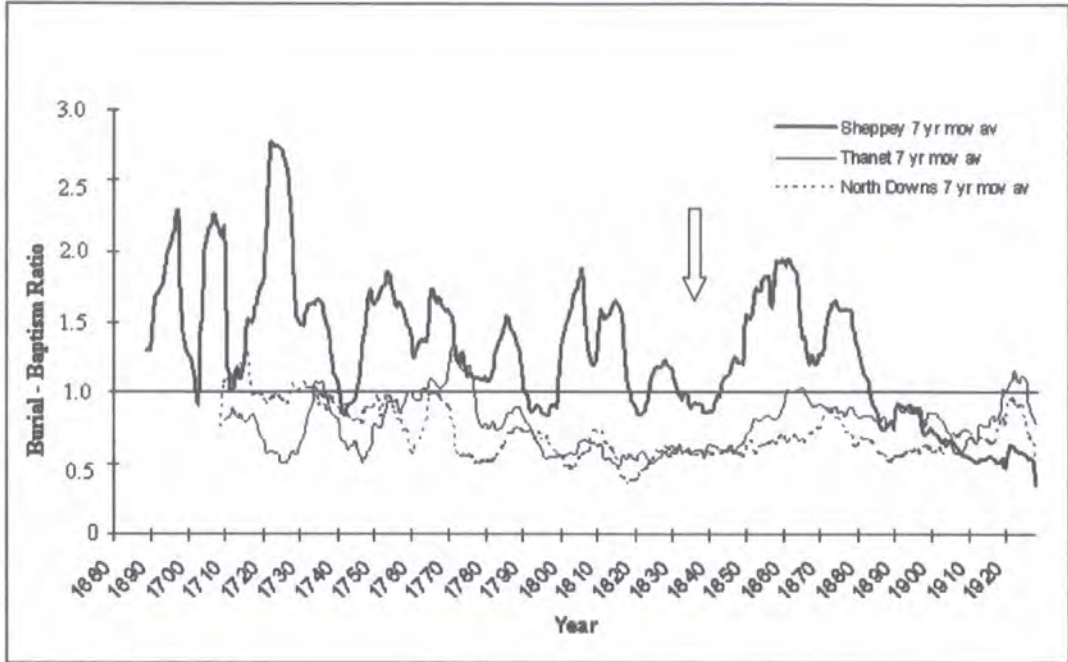

Figure 3.4 Comparison of Burial Baptism ratios for 2 marsh communities parishes (Sheppey & Thanet) and one inland community (North Downs) using a 7 year moving average 1680 – 1925. Arrow indicates point at which malaria all but disappeared in South-East England.

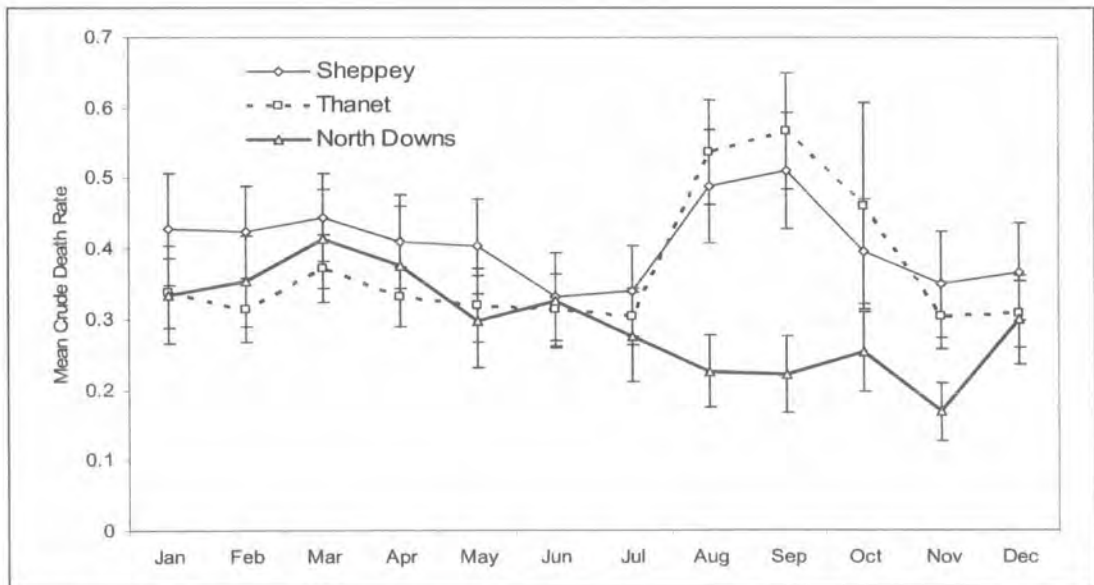

Figure 3.5 Monthly mean crude death rates for children aged 0-9yrs in two marsh regions (Sheppey & Thanet) and one inland region (North Downs) 1813 – 1925. Error bars show ± 95% C.I.

The ANOVA showed significant differences between the three regions at all five time periods ( $P < 0.002$ ). Multiple comparisons were then conducted using Tukeys test to show which region had higher mortality in each given time period (table 3.3). The Isle of Sheppey had on average 2.3 fold higher burial/baptism ratio than both Thanet and the North Downs from 1701 to 1900.

Table 3.3 Results of Tukeys Test showing differences between mean baptism/burial ratios for 3 regions over 5 time periods. Regions in columns compared to regions in rows.

Year / Place	Isle of Sheppey		Thanet		North Downs	
1701 – 1750	q	P	q	P	q	P
Thanet	8.12	0.001				
North Downs	8.01	0.001	6.23	0.001		
1751 – 1800						
Thanet	6.96	0.001				
North Downs	10.21	0.001	3.25	NS		
1801 – 1850						
Thanet	11.3	0.001				
North Downs	12.22	0.001	0.92	NS		
1851 – 1900						
Thanet	16.93	0.001				
North Downs	20.68	0.001	3.76	NS		
1901 – 1925						
Sheppey			5.04	0.05	3.36	0.05
North Downs			1.68	NS		



Mean CDRs per month of under 10 year olds for the three areas show distinctive peaks in August and September for marshland parishes but not for the North Downs parishes (figure 3.5).

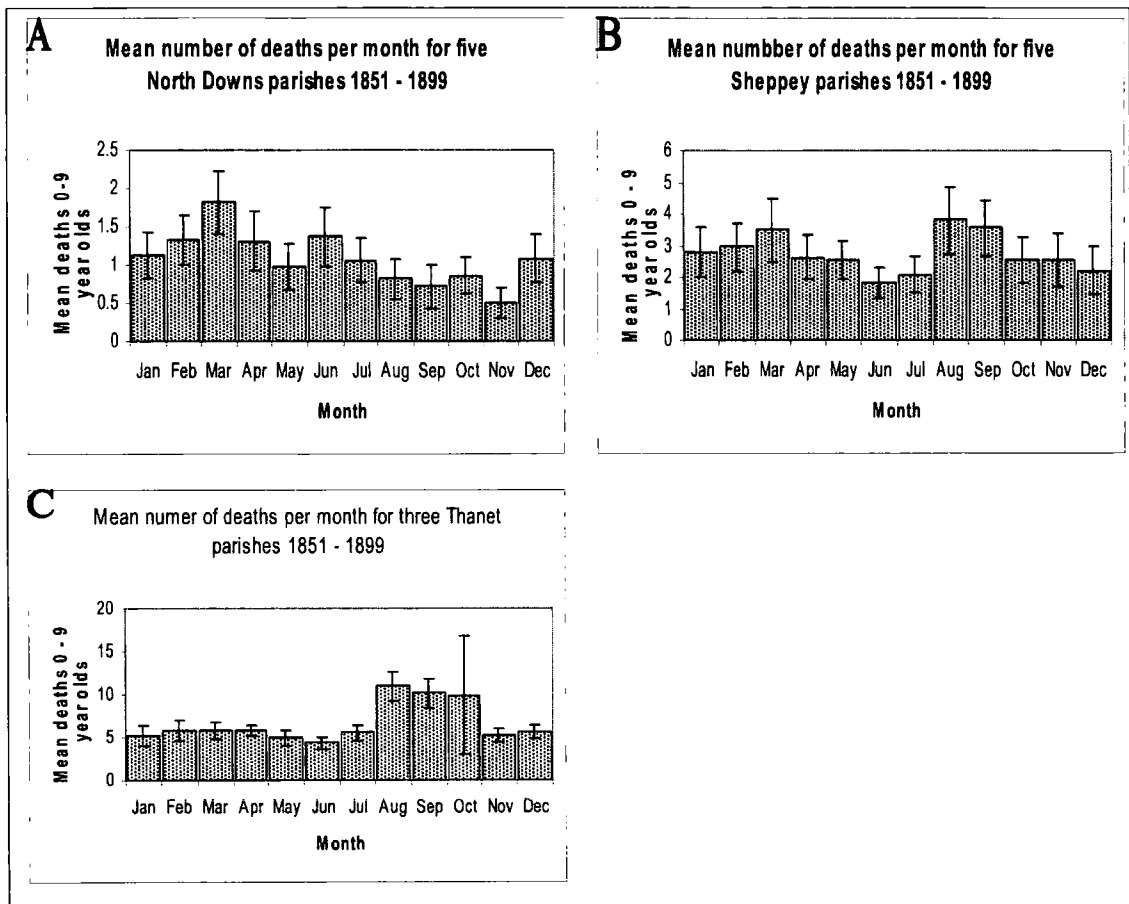

Figure 3.6 Mean number of deaths for four regions. Graph A shows absence of peak in August-September whilst B & C show peaks during this period.

Figure 3.6 shows monthly mean deaths for under 10 year olds for a 50 year period from 1851 to 1899 when vivax was extremely rare in England (James, 1929). The two marshland communities of Sheppey and Thanet both demonstrate a peak in deaths in August and September, unlike in the North Downs. To test the validity of these peaks paired t-tests were used to compare the mean deaths occurring in August – September

with the number of mean deaths in the two preceding months (table 3.4). The same process was used to look at the March peak but using the proceeding month (table 3.5).

### Hospital Data

A total of 23,044 cases were admitted into the Kent General Hospital from 1881–1924. From this total all deaths were collected (n =1626) and all cases with diseases falling into, respiratory illness, fever or gastro-intestinal diseases. When looking at children under 10 years old the biggest killer was pneumonia with 49 deaths, with 47 deaths from all gastro-intestinal diseases, and 45 who died from burns (table 3.6).

The data from the hospital records (figure 3.7) show that gastro-intestinal cases peaked in children under 10 years old in September, showing remarkable similarity with the CDR peak for Thanet and Sheppey. Furthermore these peaks can still be found today (figure 3.8) when studying cases of reported Salmonella infection.

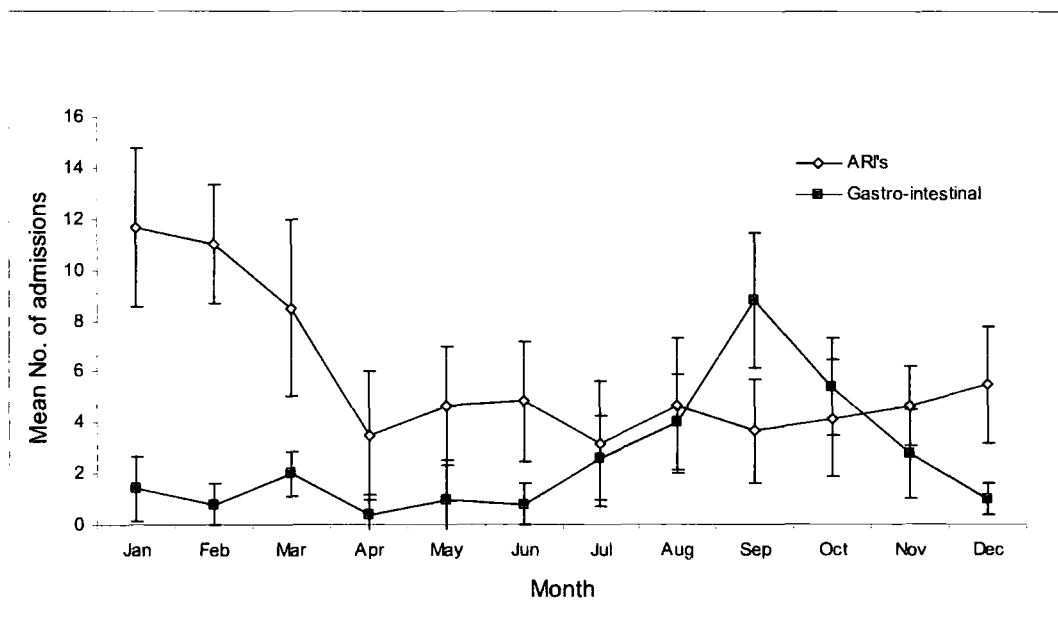

Figure 3.7 Seasonality of cases of respiratory and gastro-intestinal diseases in children under 9 years old at Kent General Hospital for a period when malaria was extremely uncommon. 1881-1924. Error bars show 95% C.I.

Table 3.4 Results of paired t-tests for the mean number of deaths in June – July compared with August – September over a 225 year period for three regions in Kent.

Year	<u>Sheppey</u>			<u>Thanet</u>			<u>North Downs</u>		
	Jun/Jul Mean	Aug/Sep Mean	<i>P</i>	Jun/Jul Mean	Aug/Sep Mean	<i>P</i>	Jun/Jul Mean	Aug/Sep Mean	<i>P</i>
1701-1750	9.9 (6.84)	13.9 (7.90)	0.001	12.1 (4.75)	14.84 (3.65)	0.002	5.82 (2.51)	5.54 (3.16)	0.6
1751-1812	23.61 (15.60)	23.48 (13.40)	0.9	24.31 (10.6)	25.29 (10.28)	0.3	5.71 (3.00)	6.11 (2.84)	0.5
1813-1850†	13.32 (5.81)	17.47 (7.66)	0.001	8.74 (5.09)	12.82 (6.55)	0.003	2.82 (1.78)	2.13 (1.61)	0.46
1851-1900†	3.82 (3.14)	7.26 (6.21)	0.001	9.8 (4.05)	21.18 (9.53)	0.001	2.38 (1.81)	1.50 (1.40)	0.002‡
1901-1925†	1.36 (1.29)	1.88 (1.62)	0.2	2.4 (4.71)	4.64 (10.21)	0.1	0.36 (0.57)	0.72 (0.89)	0.26

† All analysis for these years is for <10 year olds.

‡ Denotes the only period when more deaths occurred in June-July than in August-September

Figures in parenthesis are Standard Deviation.

Table 3.5 Results of paired t-tests for mean number of deaths in March compared with April for three regions in Kent.

Year	<u>Sheppey</u>			<u>Thanet</u>			<u>North Downs</u>		
	March Mean	April Mean	<i>P</i>	March Mean	April Mean	<i>P</i>	March Mean	April Mean	<i>P</i>
1701-1750	7.06 (4.27)	7.76 (4.57)	0.3	8.14 (3.26)	7.98 (2.98)	0.8	3.73 (2.12)	3.06 (1.94)	0.09
1751-1812	15.02 (10.66)	13.29 (10.21)	0.047	15.10 (6.71)	13.61 (5.91)	0.03	4.36 (2.41)	4.08 (2.08)	0.5
1813-1850†	6.76 (3.23)	7.58 (3.64)	0.2	4.03 (2.41)	4.13 (2.49)	0.8	1.55 (1.20)	2.03 (1.94)	0.18
1851-1900†	3.49 (3.51)	2.61 (2.47)	0.02	5.81 (3.34)	5.84 (2.22)	0.9	1.82 (1.49)	1.31 (1.39)	0.02
1901-1925†	1.46 (2.02)	0.85 (0.83)	0.2	1.73 (2.79)	1.31 (2.51)	0.2	0.54 (0.76)	0.23 (0.51)	0.02

† All analysis for these years is for <10 year olds.

Figures in parenthesis are Standard Deviation.

The data set from 1813 was grouped into 3 periods: 1813 – 1850, 1851 – 1899 and 1900 – 1925. The under 10 year age class shows a peak in deaths in August and September in both Sheppey and Thanet for both the 1813 – 1850 and the 1851 – 1899 time classes. In the last year class, 1900 – 1925, Sheppey had a higher peak of deaths in February and March whilst Thanet maintained an August and September peak. Data for the North Downs showed a March and April peak until 1900 – 1925 when the peaks move to May and September with June, July and August being the lowest months for deaths.

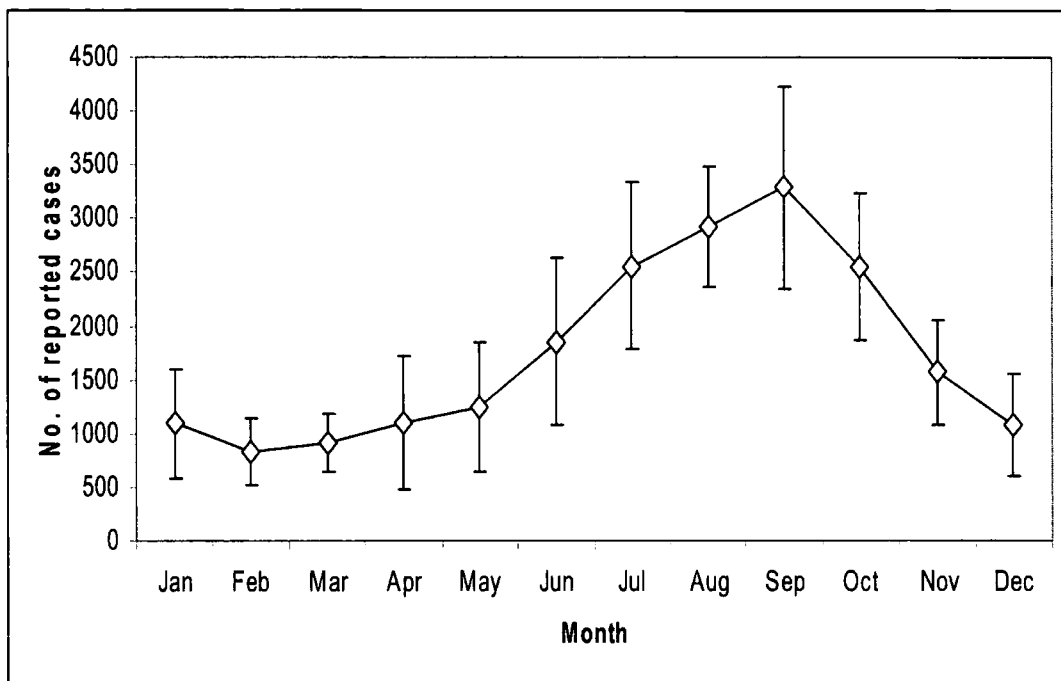

Figure 3.8 Seasonality of all salmonella infections in the UK 1997- 2000. Error bars show 95% C.I.. (Modified from Communicable Disease Report 2001).

Table 3.6 Main cause of death for different age groups recorded at Kent General Hospital 1881 – 1924

Disease	Age (yrs)					Description
	All Ages	< 1	< 10	11 - 60	> 60	
<b>Infectious diseases</b>						
Pneumonia	117	19	49	62	6	Inflammation of lungs
TB	50	4	18	30	2	Infection of tissue of an organ
Enteric Fever	38	2	9	29	0	Infection of intestines (Typhoid)
Phthisis	31	0	3	26	2	TB of the lungs
Meningitis	30	6	18	12	0	Inflammation of lining around brain
Bronchitis	18	4	5	8	5	Inflammation of bronchial tubes
Enteritis	12	8	9	3	0	Inflammation of small intestine
Diarrhoea	10	9	9	1	0	Frequent bouts of waters stools
Typhoid	9	0	0	9	0	Infection of intestines
Influenza	6	0	3	3	0	Infection of respiratory tract
Diphtheria	4	0	4	0	0	Infection of mucous membranes
Measles	2	0	2	0	0	Infectious disease with skin rash
<b>Totals</b>	<b>327</b>	<b>52</b>	<b>129</b>	<b>183</b>	<b>15</b>	
<b>Non-communicable diseases</b>						
Carcinoma	45	1	1	28	16	Cancer of epithelial tissue
Intestinal Obstruction	44	1	1	29	14	Blockage of gut
Appendicitis	40	1	4	35	1	Inflammation of appendix
Heart Disease	31	0	2	22	7	Defective heart
Abscess	25	1	4	21	0	Collection of puss in a cavity
Ulcer	25	0	0	23	2	Breach in the epithelium
Cancer	25	0	0	19	6	A malignant growth
Morbus Cordis	20	0	3	11	6	Latin term for heart disease
Nephritis	18	0	2	13	3	Kidney degeneration
Diabetes	16	1	1	13	2	Insulin deficiency
Prostate	14	0	0	0	14	Defective prostate gland
Chorea	12	0	5	7	0	Nervous disorder- jerky movements
Brights Disease	12	0	1	10	1	Kidney disease
Ovarian Cyst	10	0	0	10	0	Fluid filled cyst on ovary
Marasmus	9	9	9	0	0	Progressive emaciation
Rheumatic fever	7	0	1	6	0	Disorder affecting mainly heart
Peritonitis	6	0	2	4	0	Inflammation of peritoneum
Pleurisy	4	0	0	4	0	Inflammation of pleura (lungs)
Anaemia	4	0	1	3	0	Reduction of red blood cells
Pericarditis	3	0	0	2	1	Inflammation of pericardium
Myelitis	2	0	0	2	0	Inflammation of spinal cord
Haemophilia	2	0	1	0	1	Tendency to haemorrhage
Syphilis	2	0	0	2	0	Sexually transmitted disease
<b>Totals</b>	<b>376</b>	<b>14</b>	<b>38</b>	<b>264</b>	<b>74</b>	
<b>Surgical cases</b>						
Fracture	93	3	7	62	24	Broken bones
Burnt	58	12	45	7	6	Burning by fire hot liquid or acid
Hernia	14	0	0	9	4	Protrusion of an organ from normal
Cut throat	12	2	2	1	9	Deep wound to the neck
Accident	8	1	1	6	1	Covers advent resulting in harm
Amputation	4	0	0	3	1	Removal of a limb
<b>Totals</b>	<b>189</b>	<b>18</b>	<b>55</b>	<b>85</b>	<b>45</b>	

### Vivax and current day mortality

Few recent clinical studies have documented cases of vivax mortality and the only mortalities reported were due to complications with other diseases. Most studies reported no mortality due to vivax malaria (table 3.7).

Table 3.7 Comparison of mortality between *P. falciparum* and *P. vivax* malaria

Country	Year	Mortality		Source
		<i>P. falciparum</i>	<i>P. vivax</i>	
Ethiopia	1997	15.8%	NR*	(Gebreyesus 2000)
India	1997	41.3%†	NR	(Pal 1997)
Mozambique	1989-90	15.5%	NR	(Granja 2001)
Thailand	1977-87	1.2%†	0.22%†	(Wattanagoon 1994)
Canada	1980-91	0%†	0.41%†	(Svenson, et al., 1995)
Mozambique	1989-93	19.7%	NR	(Granja 1998)
India	1994	11.7%	NR	(Kochar 1997)
Brazil	1998-99	NR	0%	(Camargo 1999)

\*NR Vivax malaria either not recorded or not reported.

† Figures represent case fatality rates of hospital patients being treated for malaria.

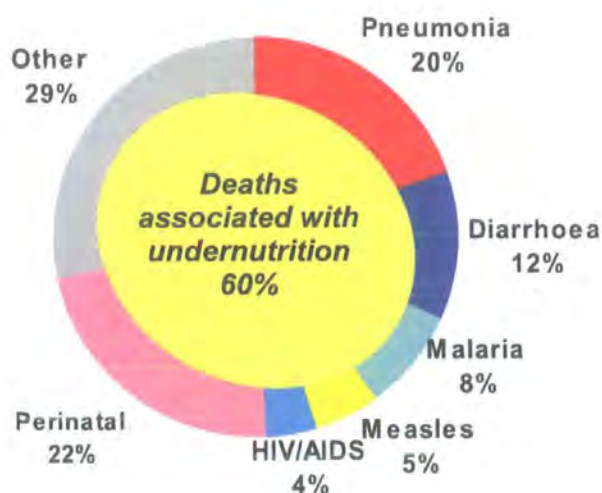

Figure 3.9 Major causes of death globally among children under five. Data from Child and Adolescent Health Progress Report 2000-2001.

Current data shows that pneumonia and diarrhoea account for 32% of all deaths in children under 5 (figure 3.9).

## Discussion

The insalubrious conditions of the saltmarshes during the 16th and 17th centuries were well recognized (DeFoe, 1742; Hasted, 1797; Talbor, 1672), but were people dying from malaria as suggested by Mary Dobson and others? The emphasis on malaria as the main cause of the high marshland mortality is based on a number of factors.

Firstly, parish data show clear evidence of higher mortality in littoral marshland areas where malaria was endemic. In rural parishes in South-East England the average death rates were approximately 20 – 30 deaths per 1000, but in the marshland communities straddling the Thames death rates were often 70 - 80 deaths per 1000 (Dobson 1994). Secondly, the descriptions of the disease fit that for vivax malaria. Historical observations describe fevers which occurred in the spring and autumn, fitting the aetiology of vivax malaria in which there is a primary infection in late autumn followed by a relapse the following spring. Clinicians had become familiar with different types of fevers by the 1670s, with Talbor (1672) and Sydenham (1848) both describing tertian fevers and enlarged spleens, termed “ague cakes”. Thirdly, English ague responded to treatment with chinchona, the Peruvian bark, which contained quinine, an active and effective anti-malarial (Sydenham 1848-50).

Fourthly, the salt marshes fringing large parts of the southern coast of England are the favoured breeding habitat of *An. atroparvus*, the most likely vector of vivax malaria in the UK due to its readiness to feed on humans and its incrimination in other countries such as The Netherlands. Mortality in marshland communities declined as changes in farming practices and hygiene improved reducing the level of mosquito human interaction (Dobson, 1994; Hackett, 1937; Bruce-Chwatt & de Zulueta, 1980). During the 18<sup>th</sup> century improvements in both construction of living dwellings and sanitation helped to separate people from the vectors. The building of cow sheds, sties and stables all removed livestock from within the living quarters of farmers and would have taken a large proportion of the vectors with them. Finally, a mathematical model of vivax transmission shows that the coastal marshes of southern England are warm enough to support the transmission of this parasite (Lindsay & Thomas, 2001).

Whilst it is highly plausible that vivax malaria once occurred in the marshes of southern England it is questionable whether this disease resulted in the elevated mortalities found in the marshland communities. One of the main arguments for

malaria being the main cause of death in the marshes is the seasonal patterns of deaths. Parish records for marsh communities show a bimodal peak of mortality with a spring peak in March – April, followed by an autumn peak in October (Dobson, 1994). A similar pattern in mortality during March and a larger peak in September is seen in the data collected in this study. When James studied the Queenborough outbreak in 1918 he found that most new infections occurred in October with relapses peaking in April (James 1929). These infections late in the year fit well with the expansion of the adult mosquito population which was largest in September (James 1920). Infections which occurred in April-May are thought to have resulted from mosquitoes that had survived the winter as adults since the new generation of mosquitoes did not appear until the end of May. Such bimodality in deaths exhibited in the parish data appears to fit well with the pattern of primary and relapse cases of malaria, an association first made by Dobson (Dobson, 1980). The main problem with this association is that the parish data is showing mortality whilst James data is showing malaria cases and not mortality, no deaths occurred in the Queenborough malaria outbreak.

Deaths during August and September were significantly greater than those seen in the two months preceding them for all but one time period up until 1901 in both Sheppey and Thanet. The North Downs showed only one period of greater deaths during August and September over the same timescale. Higher mortality in March than April is greater in the North Downs than for Sheppey or Thanet. The seasonal peak in deaths seen in September in the parish data for Sheppey and Thanet coincides with the seasonality of gastro-intestinal diseases seen in children in historical data from Kent General Hospital and with the incidence of one major cause of diarrhoea, Salmonella, today. Gastro-intestinal infections such as enteric fever, diarrhoea and gastroenteritis are associated with poor hygiene and water quality.

Such conditions were likely to have been rife in the salt marshes. On the Isle of Sheppey drinking water was a rare commodity and the first borehole well was not sunk until 1782 in Sheerness although this was almost exclusively for navy personnel (Tyler, 1994). Water both prior to and after the sinking of this well was imported from mainland Chatham in an iron container carrying 40 tons of water (Tyler, 1994). Priority was given to the navy and dockyard workers and it was not until 1860 that there were any real improvements to the supply of quality drinking water. Water was so scarce in parts of Sheppey that water was collected as runoff from the church roof



at Eastchurch and the water butts used to collect water were not removed until 1905 (Tyler, 1994). An interesting association between poor-quality drinking water and disease was described by Miller *et al.*, 1873 (Nicholls, 2000).

*“in the parish of Houghton, almost the only family which escaped ague at one time was that of a farmer who used well water, while all the other persons drank ditch water”*

This statement clearly indicates that drinking from ditches was not uncommon and was likely to have been a source of diarrhoeal diseases including those caused by *Salmonella*, *Shigella* and *Escherichia coli*. Further evidence for the poor drinking water quality was reported by John Snow in 1855 (Snow, 1855). In his book, “On the Mode of Communication of Cholera.” Snow has a whole section entitled “Instances in which ague was caused by impure water.” He writes: *“In all the instances I have just quoted, the cause of ague, whatever it may be, was swallowed with the water, not inhaled with the air; and on questioning two patients, ill with this complaint, in St. George's Hospital, after harvesting in Kent, they told me that they had often been obliged to drink water from the ditches.”*

This contrast with the water found in the North Downs which even today is still bottled as Spring Water 464 and exported around the world. Modern day examples of mortality due to infected drinking water are plentiful (Shier, 1996; Hussain, 1999; Jinadu, *et al.*, 1999; Iyuna & Okeb, 2000; Bhan, 2000). In 2000 diarrhoeal disease accounted for over 1.7 million deaths. Of these 88% had unsafe water, sanitation and hygiene as contributing risk factors (Ezzati, *et al.*, 2003). Indeed the modern day picture in many developing countries essentially mirrors that seen in the past in the UK.

Mc Keown has claimed that modern medicine had only a small effect on falling childhood mortality until after 1935 and suggests that a rise in living standards, particularly nutrition was the main reason for falling childhood mortality (McKeown, 1967). Age specific mortality rates for four marsh parishes from the 1780's to 1812 showed a mean mortality of 95.3 per 1000 live births in under 5 year olds. Modern day studies show Arab States with under 5's mortality of 73 per 1000 live births and Sub-saharan Africa with 174 per 1000 live births (Folasade, 2000). Folasade's study

in Nigeria showed that in two towns the mortality rate per 1000 in under 5's was highest for those children using stream water 58.8 and 123.6 or an outdoor tap/tanker 81.12 and 80.66 than those using water from an indoor tap 50.12 and 46.3. This shows nearly a two fold increase in mortality rate for those children drinking stream water than those drinking tap water. Another study by the same author describes a coastal region with areas of salt water creeks and very little fresh drinking water; "*the community now relies on brackish, but more salty with oil pollutants for their drinking water several km from the villages, as well as rain water harvested from the thatch and corrugated iron sheet roofs during the rainy season.*" (Folasade, 2000). This description of water collection in modern Nigeria mirrors that of the parish of Eastchurch, Sheppey a century earlier.

Removal of water-company intakes in the UK from the lower Thames during the 1850s in addition to filtration practices and the abolition of cesspools is thought to have made a substantial contribution to the reduction of enteric fever (Metropolis Water Bill, 1851). This is not surprising when one considers that many thousands of gallons of sewage from London, Rochester, Chatham and Gillingham were pumped untreated into the Thames and Medway rivers throughout the 17<sup>th</sup>, 18<sup>th</sup> and 19<sup>th</sup> centuries. These rivers converge at the Isle of Sheppey and would have carried faecal contaminated water to the island. Similarly the parishes at Thanet may have been on the receiving end of effluent from Margate, a large port town, just 5km to the east. Finally many bacterial waterborne diseases are notoriously associated with shellfish. *Salmonella*, *Escherichia* and *Shigella* can all survive after being concentrated by filter-feeding shellfish, including mussels and oysters (Jones, 1994). The Isle of Sheppey had two areas which had oyster beds, one at Shellness, the most easterly part of the Isle and another at Queenborough at the western end. Maps of the Isle show that the oyster beds at Queenborough were in use in 1898 but had become disused by 1908. These beds would certainly have provided shellfish to the local population. A further consideration here is that *Salmonella typhi* has a phase which causes fever and splenomegaly, the "classic" symptoms of malaria.

Respiratory diseases such as pneumonia, tuberculosis, including phthisis, were highest in the colder winter months of January, February and March. This supports the well known observation that deaths from respiratory diseases increases as temperatures drop (Donaldson & Keatinge, 1997; Donaldson & Keatinge, 1997; Donaldson, *et al.*,

1998). Conversely warmer temperatures show an increase in the number of gastrointestinal infections and deaths (Hardy, 1993). I suggest that the most plausible explanation for the winter peak in mortality seen in the parish data was due to respiratory diseases, whilst the autumn peak was due to diarrhoeal diseases.

### Mortality

It has been argued that the English strain of vivax malaria must have been particularly aggressive resulting in many deaths (Dobson, 1994; Dobson, 1997; Snow, 2000). If this is correct, this was the only place in the world where it was lethal. Nowhere else in the world has vivax been shown to have been a significant cause of mortality. Indeed vivax malaria was once commonly known throughout the world as benign tertian malaria because it was not a lethal disease. In the 20<sup>th</sup> century deaths from vivax infections were extremely rare and usually associated with complicated co-infections of other diseases and malnutrition (Williams *et al.*, 1997; Gupta & Varma, 2001).

The classic work of Christophers in the Punjab is a wonderful historical source of malaria epidemiology. In 1908 there was a large widespread malaria epidemic, mortality in Amritsar totalled 10,202 deaths. 7000 of these were attributed to the malaria epidemic and of the 10,202 deaths over half were in under 5 year olds. Christophers detailed study looked at spleen rates and type of malaria infection. He stated that in the Shahpur district the epidemic had been very mild or had even not affected the death rate (Christophers, 1911). What defined this district was the absence of malignant tertian, or *P. falciparum* malaria, and the presence of only benign tertian, or vivax malaria. Hence we see again that in this region the presence of vivax malaria was noticeable due to the lack of mortality. Somewhat later, and on another continent, Pinto attributed the high mortality of the Rio Grande Do Norte region in Brazil, 1938 to vivax malaria (Soper & Wilson, 1943). Mortality ranged from 6% - 15% and the validity of Pintos' suggestion was immediately questioned by Schwetz on the basis that *P. falciparum* was transmitted by *An. gambiae* which was now present in Brazil (Soper & Wilson, 1943). Further investigation suggested that the erroneous conclusion towards vivax mortality was based around an inadequate number of examinations during a period of low transmission of *P. falciparum*, but high vivax transmission.

In the UK statistics from the annual reports of the Registrar General, which give cause of death from 1848 onwards, ague deaths formed a very small proportion of all deaths. For the counties of Lincolnshire, Norfolk, Suffolk, Cambridgeshire and Huntingdonshire ague deaths fell from a high of 56 in 1848 to 5 deaths in 1899 (Nicholls 2000). The admission records for Kent General Hospital from 1881 -1924 show five cases of malaria, none of which were fatal.

The proposed high levels of mortality caused by malaria in the 16<sup>th</sup>, 17<sup>th</sup> and 18<sup>th</sup> centuries have been blamed on a particularly virulent strain of the parasite (Dobson, 1994; Snow, 2000). Strains of the parasite exist that exhibit differences in latency before the onset of a primary attack. Comparisons between a Dutch strain and a Madagascar strain showed that 38% of patients infected with the Dutch strain had infections which were latent, meaning a period of longer than a week between receiving an infectious bite and exhibiting symptoms, whilst only 7% of those infected with the Madagascar strain showed latent infections. There was also considerable difference in the relapse rate between these two strains, 10% for the Dutch strain and 80% for the Madagascar strain (Korteweg, 1931). Despite the evidence of strains and differing aetiology between strains there is no evidence of increased virulence between strains which would account for the high mortality rates in the 16<sup>th</sup> – 18<sup>th</sup> centuries. Some researchers state that it is clear that the vivax parasite of the past was more virulent than that we encounter today (Snow, 2000). It has been suggested that the parasite of the past and its biology may have been so different from that we see today that comparisons are pointless (Snow, 2000). This is a fanciful explanation as records from The Netherlands show large numbers of vivax malaria infections but very few deaths. With the constant commerce and travelling of tradesmen between these two countries in the 17<sup>th</sup> and 18<sup>th</sup> centuries (Ormrod, 2003) it seems unlikely that a virulent strain would be contained along the coastal regions of the UK and yet not occur in The Netherlands.

Nowhere in the world is, vivax malaria, otherwise known as *benign tertian malaria* particularly lethal. Despite this we are told by historians that English malaria was the exception and caused high levels of mortality. Could there be an alternative, more plausible explanation for the high mortality experienced in the salt marshes of southern England?

The major childhood killers from the 17<sup>th</sup> to the 19<sup>th</sup> centuries were diarrhoeal diseases and acute respiratory infections (Snow, 1855; Hussian *et al.*, 1999; Huck, 1997). Even in malaria endemic countries today, these two infections are responsible for most mortality in young children (Black, *et al.*, 2003; Bryce, *et al.*, 2003). The interpretation of the parish, hospital, and historical data is that malaria was present in the marshes but did not kill. Hygiene and sanitation were poor due to the lack of quality drinking water and high mortality rates were due to diarrhoeal disease in August and September and respiratory disease in March and April.

## References

- Black R, Morris S, & Bryce J. (2003). Where and why are 10 million children dying every year? *Lancet*, **361**: 2226-34.
- Brook, M. G. & Bannister, B. A. (1993). The clinical features of imported malaria. *Communicable Disease Report*, **3**: R28-R31.
- Bryce J, El Arifeen S, Pariyo G, Lanata C, Gwatkin D, Habicht JP and the Multi-Country Evaluation of IMCI Study Group. (2003). Reducing child mortality: Can public health deliver? *Lancet*, **362**:159-64.
- Huttly SR, Morris SS, Pisani V. (1997). Prevention of diarrhoea in young children: abundant experience in developing countries. *Bulletin World Health Organization*, **75**:163-74.
- Bhan, M. K. (2000). Current and future management of childhood diarrhoea. *International Journal of Antimicrobial Agents*, **14**: 71 - 73.
- Boyd, M. F. (1949). *Malariology. A comprehensive survey of all aspects of this group of diseases from a global standpoint*. Philadelphia and London, Saunders, W.B.
- Brook, M. G. Bannister, B.A. (1993). The clinical features of imported malaria. *Communicable Disease Report*, **3**: R28-R31.
- British Atmospheric Data Centre <http://www.badc.rl.ac.uk>
- Bruce-Chwatt, L. J. (1976). Ague as Malaria, an essay on the history of two medical terms. *Journal of Tropical Medicine and Hygiene*, **79**: 168-176.
- Bruce-Chwatt, L. J. & Zulueta, J. de (1980). *The rise and fall of malaria in Europe*. London, Oxford University Press.

- Camargo, E. P. A., F. & Pereira da Silva, L. H. (1999). Symptomless *Plasmodium vivax* infections in native Amazonians. *Lancet*, **353**:1415-6.
- Child & Adolescent Health & Development Progress Report 2000-2001.  
[http://whqlibdoc.who.int/hq/2002/WHO\\_FCH\\_CAH\\_02.19.pdf](http://whqlibdoc.who.int/hq/2002/WHO_FCH_CAH_02.19.pdf)
- Christophers, S. R. (1911). *Malaria in the Punjab*. Superintendent Government Printing. India.
- Cracknell, B. E. (1959). Canvey Island: The History of a Marshland Community. *University of Leicester Occasional Papers*, **12**: 3-47.
- Defoe, D. (1742-6). *A tour though the whole island of Great Britain*. Penguin Classics. London.
- Dobson, M. (1980). Marsh Fever - the geography of malaria in England. *Journal of Historical Geography*, **6**: 357-389.
- Dobson, M. J. (1989). History of malaria in England. *Journal of the Royal Society of Medicine: supplement 17*, **82**: 3-7.
- Dobson, M. (1994). Malaria in England: a geographical and historical perspective. *Parassitologia*, **36**: 35-60.
- Dobson, M. J. (1997). *Contours of death and disease in early modern England*. Cambridge University Press. Cambridge.
- Donaldson, G. C., Tchernjavskii, V.E., Ermakov, S.P., Butcher, K. & Keatinge, W.R. (1998). Winter mortality and cold stress in Yekaterinburg, Russia: interview survey. *British Medical Journal*, **316**: 514 - 518.
- Donaldson, G. C. & Keatinge, W.R. (1997). Early increases in ischaemic heart disease mortality dissociated from, and later changes associated with, respiratory mortality, after cold weather in south-east England. *Journal of Epidemiological and Community Health*, **51**: 643 -648.
- Donaldson, G. C. & Keatinge, W.R. (1997). Mortality related to cold weather in elderly people in southeast England, 1979-94. *British Medical Journal*, **315**: 1055 - 1056.
- Ezzati, M., Vander Hoorn, S., Rodgers, A., Lopez, A.D., Mathers, C.D. & Murray, C.J.L. Estimates of global and regional potential health gains from reducing multiple major risk factors. *The Lancet*, **362**, 271 – 280.
- Folasade, I. B. (2000). Environmental factors, situation of women and child mortality in southwestern Nigeria. *Social Science & Medicine*, **51**: 1473 - 1489.
- Gebreyesus, K. & Morrow, R. H. (2000). Teaching mothers to provide home treatment of malaria in Tigray, Ethiopia: a randomised trial. *Lancet*, **356**, 550-555.

- Granja, A. M., F; Gomes, A; Bergström, S. & Brabin, B. (1998). Malaria-related maternal mortality in urban Mozambique. *Annals of Tropical Medicine and Parasitology*, **92**: 257-263.
- Granja, A. C., Machungo, F., Gomes, A. & Bergstrom, S. (2001). Adolescent maternal mortality in Mozambique. *Journal of Adolescent Health*, **28**: 303-306.
- Gupta, G. B. and Varma, S. (2001). Effect of intravenous quinine on capillary glucose levels in malaria. *Journal of the Association of Physicians India*, **49**: 426-9.
- Hackett, L. (1937). *Malaria in Europe: an ecological study*. Oxford University Press. London.
- Hardy, A. (1993). *Typhoid. The Epidemic streets: infectious disease and the rise of preventive medicine, 1856 - 1900*. Oxford, Clarendon Press.
- Harris, W. (1699). *A description of the king's royal palace and gardens at Loo*. London, K. Roberts.
- Hasted, E. (1797-1801). *The History and Topographical Survey of the County of Kent*. W. Bristow. Canterbury.
- House of Commons. Select Committee on the Metropolis Water Bill (1851). Minutes of evidence taken before the select committee on the metropolis water bill; with an index. London, HMSO: 814.
- Huck, P. (1997). Shifts in the seasonality of infant deaths in nine towns during the 19th century: A case for reduced breast feeding? *Explorations in Economic History*, **34**: 368-386.
- Hunter, M.C. & Gregory, A. (1988). *An Astrological Dairy of the Seventeenth Century. Samuel Jeake of Rye 1652-1699*. Oxford, Clarendon Press.
- Hussain, A., Keramat, S.M. & Kvale, G. (1999). Determinants of mortality among children in the urban slums of Dhaka city, Bangladesh. *Tropical Medicine and International Health*, **4**: 758-764.
- Iyuna, F. B. & Okeb, A. E. (2000). Ecological and cultural barriers to treatment of childhood diarrhea in riverine areas of Ondo State, Nigeria. *Social Science & Medicine*, **50**: 953-964
- James, S. P. (1920). *Malaria at home and abroad*. Jonn Bale, Sons & Danielsson, Ltd. London.
- James, S. P. (1929). The Disappearance of Malaria from England. *Proceedings of the Royal Society of Medicine*, **23**: 71-85.
- Jinadu, M. K., Olusi, S. O., Agun, J.I. & Fabiyi, A.K. (1991). Childhood diarrhoea in rural Nigeria. I. Studies on prevalence, mortality and socio-environmental factors. *Journal of Diarrhoeal Diseases Research*, **9**: 323-327.
- Jones, K. (1994). Waterborne Diseases. *New Scientist*, **143**: 4.

- Keatinge, W. R. & Donaldson, G.C. (1997). Cold exposure and winter mortality from ischaemic heart disease, cerebrovascular disease, respiratory disease, and all causes in warm and cold regions of Europe. *The Lancet*, **349**: 1341 - 1346.
- Kochar, D., Kumawat, B.L., Karan, S., Kochar, S.K. & Agarwal, R.P. (1997). Severe and complicated malaria in Bikaner (Rajasthan), western India. *Southeast Asian Journal of Tropical Medicine and Public Health*, **28**: 259-267.
- Kolsky, P. J. (1993). Diarrhoeal disease: current concepts and future challenges. Water, sanitation and diarrhoea: the limits of understanding. Transactions of the Royal Society of Tropical Medicine and Hygiene, **87**: Suppl 3: 43-6.
- Korteweg, P. C. (1931). What is the normal type of fever in primary cases of benign tertian malaria? Is it tertian or quotidian? *Journal of Tropical Medicine*, **34**: 129.
- Laursen, E., O. Mygind, et al. (1994). Gastroenteritis: a waterborne outbreak affecting 1600 people in a small Danish town. *Journal of Epidemiology and Community Health*, **48**: 453-8.
- Lindsay, S. W. & C. J. Thomas (2001). Global warming and risk of vivax malaria in Great Britain. *Global Change and Human Health*, **2**: 80-84.
- Luxemburger, C., Nosten, F., Kyle, D. E., Kiricharoen, L., Chongsuphajaisiddhi, T. and White, N. J. (1998). Clinical features cannot predict a diagnosis of malaria or differentiate the infecting species in children living in an area of low transmission. *Transactions of the Royal Society of Tropical Medicine and Hygiene*, **92**: 45-9.
- McKeown, T. (1967). *The role of medicine: Dream, Mirage or Nemesis*. Nuffield Provincial Hospitals Trust. London.
- Newman, G. (1919). Reports and papers on malaria contracted in England in 1918. Reports to the Local Government Board on Public Health and Medical Subjects New Series No 123: 1-42.
- Nicholls, A. (2000). Fenland Ague in the Nineteenth Century. *Medical History*, **44**: 513-530.
- Ormrod, D. (2003). *The Rise of Commercial Empires. England and the Netherlands in the Age of Mercantilism, 1650–1770*. Cambridge University Press. Cambridge.
- Pal, P. K., Vengamma, B., Naik, K.R. & Saroja, A.O. (1997). Prognostic factors in cerebral malaria: A study of 80 cases. *Journal of Neurological Sciences*, **150**: S131.
- Shute, P. G. (1944). Indigenous malaria and mosquito control in England after the war. *Journal of the Royal Sanitary Institute*, **64**: 85-94.



- Shute, P. G. (1949). A review of indigenous malaria in Great Britain after the War of 1939-1945, compared with the corresponding period after the 1914-1918 War (With some observations on the aetiology). *Monthly Bulletin of the Ministry of Health*, **8**: 2-9.
- Shier, R. P., Dollimore, D.A., Binka, F.N., Quigley, M. and Smith, P.G. (1996). Drinking water sources, mortality and diarrhoea morbidity among young children in northern Ghana. *Tropical Medicine and International Health*, **1**: 334-341.
- Snow, J. (1855). *On the Mode of Communication of Cholera*. John Churchill. London.
- Snow, K. (2000). Could Malaria Return To Britain?. *Biologist*, **47**: 176-180.
- Soper, F. L. and Wilson, D. B. (1943). *Anopheles gambiae in Brazil*. The Rockefeller Foundation. New York.
- Svenson, J. E., MacLean, J. D., Gyorkos, T. W. and Keystone, J. (1995). Imported malaria. Clinical presentation and examination of symptomatic travelers. *Archive International Medicine*, **155**: 861-8.
- Sydenham, T. (1848-50). *The Works of Thomas Sydenham*. London. The Classics of Medicine Library L.B. Adams Jr.
- Talbor, R. (1672). *Pyretologia; a rational account of the cause and cure of agues, with a successful method for the cure of quartans*. London. R. Robinson.
- Thirsk, J. (1957). *English peasant farming : the agrarian history of Lincolnshire from Tudor to recent times*. London, Routledge & Kegan Paul.
- Tyler, L. (1994). *The History of Sheppey*. Sheerness. Fitch, B.A.
- Wattanagoon, Y., Srivilairit, S., Looareesuwan, S. & White, N.J. (1994). Convulsions in childhood malaria. *Transactions of the Royal Society of Tropical Medicine and Hygiene*, **88**: 426-428.
- Williams, T. N., Maitland, K., Phelps, L., Bennett, S., Peto, T. E., Viji, J., Timothy, R., Clegg, J. B., Weatherall, D. J. and Bowden, D. K. (1997). Plasmodium vivax: A cause of malnutrition in young children. *Monthly Journal of the Association of Physicians*, **90**: 751-757.
- Wrigley, E.A. and Schofield, R.S. (1981). *The population history of England, 1541 - 1871: A reconstruction*. Cambridge and New York, Cambridge University Press.

## Chapter 4

### Resting behaviour of adult *Anopheles atroparvus* on the Isle of Sheppey, Kent.

#### Summary

##### Introduction

*Anopheles atroparvus* rests in stables and cattle sheds during the winter. However, not all such sites act as resting harbourages. Here I look at some of the factors that affect adult survival during the winter.

##### Methods

Fortnightly inspections were made for *An. atroparvus* at 11 sites on the marshlands on the Isle of Sheppey over two years. Temperature was recorded at these sites and observations made on the gonotrophic state, feeding preference and survival of adults.

##### Results

*An. atroparvus* only occur in sites where the winter temperature was above freezing, using brick, concrete or wooden buildings. Adults selected sites with entrances less than 1m above ground and took bloodmeals throughout the winter. Males do not overwinter and only nulliparous females with gonoactive ovaries at Christophers Stage II survived the winter.

##### Interpretation

Adults selected sites for overwintering close to the ground and where temperatures remain above freezing. The mechanism for selecting sites that do not freeze during winter is uncertain. The loss of farm buildings with animals on the Isle of Sheppey would have contributed to the disappearance of malaria from the marshes.

## Chapter 4

### Resting behaviour of adult *Anopheles atroparvus* on the Isle of Sheppey, Kent.



Plate 4.1 Female *Anopheles atroparvus* over-wintering in a concrete pipe on the Isle of Sheppey

#### Introduction

Adult female mosquitoes spend a great deal of their life resting (Beaty & Marquardt, 1996). This is due to the need to digest large blood meals and the avoidance of predators. Active flight for females is used to locate a host, find an oviposition site or to move to a resting site. If a mosquito exhibits endophilic behaviour then often they will stay in close proximity to their host thus reducing the need for prolonged host-seeking flights. With a host blood meal close by the longest flight will be that taken to the larval site in order to deposit an egg batch before returning indoors.

There is considerable variation in the behaviour of different mosquito species in respect to their preferred resting sites. In the early 1920's Wesenberg-Lund described how 'he was amazed' at the vast numbers of *An. maculipennis* hanging from the ceiling of a stable in Holland (Wesenberg-Lund, 1921). Conducting a detailed search

he discovered that most females were blood fed and there were few males. In stark contrast to this, studies in the Nile valley in Egypt showed few if any mosquito populations in stables, houses or cow sheds because the dominant species, *Anopheles pharoensis* and *An. sergentii*, rests outdoors in the rice fields (El Said *et al.* 1986). In temperate climates mosquitoes are faced with the additional problem of surviving the cold winter months. Many species select a site to over-winter that will provide an environment enabling them to survive and produce offspring the following spring.

Over-wintering insects are commonly divided into two classes; those that remain active and those that do not. Although frequently thought of as essentially warmth seeking insects, perhaps more than any other eukaryotic taxon, have evolved the ability to thrive in environments at very low temperatures (Lee, 1991). In the order Diptera examples of cold hardiness are seen in the Himalayan midge, *Diamesa kohshimai*, which remains active at temperatures of  $-16^{\circ}\text{C}$  (Kohshima, 1984), the Chironomid, *Belgica antarctica*, which survives in the soil as larvae at  $-5^{\circ}\text{C}$  (Baust, 1979) and the fleshfly, *Sarcophaga crassipalpis*, which can survive as a diapausing pupa at  $-23^{\circ}\text{C}$  (Lee, 1987). Insects often employ special biochemical and physiological strategies to survive these extremely low temperatures. Many over-wintering insects use a cryoprotectant, such as glycerol, glucose, fructose and trehalose (Lee 1991) that often allows them to survive temperatures that would be lethal to the summer generation of the same species. Trends in cold survival and cold tolerance are associated with varying water volume of insects. Examples are seen in ants, collembola and insect eggs where smaller size results in smaller water content and therefore greater cold tolerance. This is probably one reason why many insects opt to over-winter as larvae or eggs. Another alternative to staying in the larval stage over the winter, or to become saturated with cryoprotectants is to select environmentally favourable sites that provide a suitable temperature range to maintain physiological function in the adult form.

This strategy has been adopted by just a few species of mosquitoes in the UK. Of the 32 species of mosquitoes found in the UK only seven over-winter in the adult form. These include: *Culiseta subochrea*, *C. annulata*, *Culex pipiens* “molestus form”, *Cx. pipiens* “typical form”, *Cx. torrentium*, *Anopheles messeae* and *An. atroparvus*. Of these seven only the last four over-winter exclusively as adult females

whilst the other three can be found in all developmental stages throughout the year. The last two species are members of the maculipennis complex, being identical morphologically but exhibiting distinct over-wintering behaviours (Marshall, 1938; Vaile & Miles, 1980; Ramsdale & Wilkes, 1985).

Females of *An. messeae* and *An. atroparvus* have both been vectors of vivax malaria throughout parts of northern Europe (Hackett, 1937). In the UK the principal malaria vector was *An. atroparvus* due essentially to its ecology that brought it into close association with humans and its anthropophilic tendency. *An. messeae* is more zoophilic and has not been incriminated as a vector in the UK. Both species rest throughout the winter months in out houses and derelict buildings. Adult males disappear by the end of September and females then select a suitable site to over-winter. All females entering the over-wintering stage have mated and viable sperm is held within the spermatheca ready to inseminate the first egg batch the following April. The main difference between the two species during the winter period is that *An. messeae* enters a period of complete hibernation (de Buck (1934) used the term *gonotrophic concordancy*, meaning no feeding and no eggs) using fat reserves laid down during the warmer Autumn months. These fat reserves are the result of switching from blood feeding to exclusively feeding on nectar during September and early October. This switch in feeding may allow a concentration of glucose which could enable this species to over-winter in colder sites where it is found rather than the warmer sites used by *An. atroparvus* (Marshall, 1938). In addition the fat reserves resulting from nectar feeding provide adequate reserves allowing them to remain dormant throughout the whole winter period.

*An. atroparvus* also spends the winter mated with sperm held in the spermatheca. However there is no switch to nectar feeding in late autumn and periodic blood meals are taken if available and used to maintain the female through the winter months, (de Buck (1934) termed this *gonotrophic dissociation*, feeding without producing eggs). Although blood meals are taken during the winter period they are not essential for survival being a facultative behaviour rather than an obligate one. It appears that females that have recently entered their over-wintering state may need to devote a proportion of blood meals taken in this early period of hibernation to metabolic functions as laboratory studies have shown that five to six blood meals and

approximately 25 days are needed before an egg batch is developed in October (de Buck, 1934). This number of blood meals and development time is reduced during the winter until only one or two meals and five to seven days are needed by February. Although these experiments were not conducted under natural conditions they indicate that reactivation is slower at the earlier stages of over-wintering.

Current knowledge on the over-wintering behaviour of these species is that only mated females seem to survive the winter. *An. messeae* over-winter in cold unoccupied outbuildings, whilst *An. atroparvus* choose warmer sites usually containing a host such as cattle sheds or stables.

Although much is already known about the over-wintering habits of *An. atroparvus* this is mainly restricted to temporal behavioural patterns and gonotrophic state as females pass through the winter months. When females decide to select a site for over-wintering due to falling temperatures and reduced day length, do some select unsuitable sites that become too cold as the winter progresses resulting in death? Variation in the response to day length occurs in *An. messeae* according to latitude. At 60° adults start to respond to shortening day length around 19h 44m whilst at 46° they begin to respond at 16h 32m. In addition to this variation between populations at different latitudes there is also variation between individuals with between 15 to 30 days between the first females entering gonotrophic concordancy and the total population entering (Shipitsina, 1964). This shows that there is variation both between and within populations of the *An. maculipennis* complex.

This work aims to study the physiological state of over-wintering females, monitor the resting population density throughout the winter and determine whether ambient air temperature and relative humidity are important environmental variables in over-wintering sites.

## **Methods**

An initial survey was carried out during November and December of 2000 to select suitable sites for the collection of over-wintering females. Seventeen sites were chosen, representing the different types of building available to female mosquitoes on the Isle of Sheppey. The sites consisted of four wooden bird hides (figure 4.1), two

concrete pillboxes, six barns, either brick built or of new sheet steel construction, and four derelict buildings (figure 4.2) one of which was a disused brick-built tunnel and one stable block with five horses. From the 8<sup>th</sup> January 2001 these site were visited fortnightly until the 19<sup>th</sup> February 2001 allowing four collections at each site. However, due to the outbreak of foot and mouth disease on the Isle of Sheppey no further collections were made until November the same year. The number of sites selected was reduced to 11 when collections commenced in November 2001. This decision was taken to reduce travelling across tracts of farmland and all sites dropped from the survey were negative.

Temperature data loggers (TinyTalk<sup>®</sup> II, Gemini, UK) were placed at five sites, (two negative and three positive), and the ambient air temperature logged every 30 minutes throughout the winter. Loggers were placed as near to the resting adults as possible. Usually this meant fixing the logger to the ceiling, except in the school house where the logger was placed inside a concrete pipe where the adults rested. Two sites, (one negative and one positive) also had relative humidity loggers recording at 30 minute intervals. In addition an automatic weather station (Skye Instruments) was placed on the Elmley bird reserve to record outside air temperature, water temperature, humidity, rainfall, wind speed and wind direction.

### Identification

Due to *An. atroparvus* being morphologically identical to *An. messeae* samples of female mosquitoes collected at over-wintering sites that were not gravid or blood fed were kept over silica gel and analysed by Polymerase Chain Reaction (PCR) using the protocol described by Proft *et al.*, 1999. A total of 60 adults were identified from over-wintering sites on Sheppey. A diagnostic rDNA (deoxyribonucleic acid) PCR assay was used testing for *An. messeae* and *An. atroparvus*. The method uses species-specific nucleotide sequences in the ITS2 (intergenic spacer 2) rDNA.

DNA extraction of whole adults was conducted by adding an equal volume of PCI (phenol, chloroform and isoamyl alcohol) to the DNA solution to be purified in 1.5 ml microcentrifuge tube. These were then vortexed vigorously for 10 seconds and

centrifuged at 10000rpm for 15 seconds at room temperature. The top aqueous phase containing the DNA was removed using a 200 µl pipette and transferred to a new eppendorf tube. A 1 in 10 volume of 3M sodium acetate (pH 5.2), was added to the solution of DNA then mixed by vortexing for 10 seconds. To this solution 2 - 2.5 volumes (200 - 300 µl) of ice cold 100% ethanol were added and again vortexed for 10 seconds. The eppendorf was placed in crushed dry ice for 5 minutes and spun at 13,000 rpm for 20 minutes and the supernatant removed.

1 ml of 70% ethanol was added and the tube inverted several times to ensure mixing and then centrifuged at 13,000rpm for 15 minutes. The supernatant was removed and the dry pellet desiccated under a hood for 15 minutes. 200 µl TE buffer (Made from 1 M stock of Tris-Cl (pH 7.5) and 500 mM stock of EDTA (pH 8.0) added and the mixture incubated at 65° C for 10 minutes. 200 µl of 5M LiCl was added and the tube left 1 hour at -20° C. The tube was then spun at 13000rpm for 8 minutes then left to precipitate by adding 1ml of 100% ethanol for 1 hour. The mixture was finally spun at 13,000rpm for 20 minutes and the supernatant removed. The pellet was washed with 1ml of 70% ethanol and spun at 13,000rpm for 5 minutes. The supernatant was removed and the pellet left for 15 minutes under a hood. The pellet was re-suspended in TE buffer in 50 µl samples and stored at - 20° C until use in PCR. A diagnostic rDNA (deoxyribonucleic acid) PCR assay was used testing for *An. messeae* and *An. atroparvus*. The method uses species-specific nucleotide sequences in the ITS2 (intergenic spacer 2) rDNA. PCR was carried out in 50-µl volume containing 10mM Tris-HCL, 50mM KCL, 1 mM Mg Cl<sub>2</sub>, 0.5 mM dNTPs, 0.6mM universal primer, 0.3mM specific primer and 2.5 units of Taq polymerase. Samples were run on a 2.5% agarose gel containing ethidium bromide for 1.5 hours at 80 V. Products were visualised using short-wave ultraviolet light captured on Polaroid film.

### Over-wintering Collections

At each site all visible mosquitoes were collected with a pooter for 5 minutes and specimens transported to the laboratory. Here they were identified to species, or to *Anopheles maculipennis s.l.*, and sex. Blood fed females were squashed onto Whatman No1 filter paper and stored for use in blood meal analysis. Unfed females were dissected to determine the parity state, if they were fertile and at what stage of



ovarian development they had reached. A subset of females and males were kept over silica gel to provide samples for PCR analysis to distinguish the two sibling species *An. messeae* and *An. atroparvus*.

#### Blood Meal Analysis

Blood meals were analysed using the precipitin ring test, first used for blood meal identification in mosquitoes in 1923 (Bull & King, 1923). Each blood sample was cut from the Whatman No1 filter paper and placed in a 1.5ml eppendorf tube with 400µl of PBS at 4°C and left over night. Following 12 hours at 4°C the filter paper was carefully removed, using a fresh pipette tip for each sample. The samples were then spun for 5 minutes at 5000rpm. Whole serum for anti-human, sheep, cow and horse from Sigma (Sigma Laboratories, Missouri, USA) were diluted to a 1:10 solution using PBS (50mM Tris.CL, pH 9.0, 20 mM GSH). A 100µl of supernatant from the spun blood samples was carefully pipetted into a capillary test tube, then 140µl of anti-horse serum added on top. All samples were tested for horse first as 74% of all blood meals originated from a horse stable. All samples testing positive for horse were not tested for any other host. Positive samples were identified by the development of a white ring of precipitation at the interface between the blood meal supernatant and the whole anti-serum. A total of 104 samples were tested.

#### Over-wintering Survival

To measure the survival of over-wintering female mosquitoes cohorts were followed from the 29<sup>th</sup> November 2001 until all females were dead on the 4<sup>th</sup> April 2002. Six cohorts, each of 20 females, were placed into net covered wire frame cages measuring 155mm × 155mm × 155mm. Females were collected from two sites and subjected to the same conditions of movement and handling. Three cages were placed in a site where females over-wintered and three cages at a site where no over-wintering females were found. Cages were not provisioned with water or any food source. All females were unfed when placed into the cages. Every two weeks the cages were checked and all dead mosquitoes counted and removed. At both sites ambient air temperature was measured using a data logger (TinyTalk<sup>®</sup> II, Gemini, UK) at 30 minute intervals to the nearest 0.1 °C.



**Figure 4.1** Spitend hide.  
A bad over-wintering site  
for *An. atroparvus*



**Figure 4.2** Old School House. A good  
over-wintering site for *An. atroparvus*.

#### Outdoor resting and emerging adults

Sweep netting was carried out in June, July, August and September 2002 at sites close to adult indoor resting sites and larval breeding sites. A large white canvas sweep net (aperture diameter 600mm) was used to sample vegetation including long grass and tall stands of reeds, *Typhus* spp., to search for any outdoor resting *An. atroparvus*. Sweeping was conducted along approximately 100m transects running adjacent to breeding sites with a 2m width being covered thus giving 200m of coverage for each transect. A total of twelve transects were used giving a total area of 2400m. In August 2002 two large tents were erected, both close to larval breeding sites to attract newly emerged *An. atroparvus*. Tents were approximately 4m in diameter and 2.5m high. Tents were erected so the bottom edge was raised 400mm from the ground to allow easy entry of mosquitoes. These tents were checked approximately every 2-3 days for resting adults for a period of 3 weeks in July, 2002.

### Selection of over-wintering sites

To examine the behaviour of resting *An. atroparvus* a simple choice experiment was developed. Six large black bins (1200mm × 800mm) were arranged in a line 4m apart. All bins were completely enclosed other than a 100mm × 100mm hole cut into the bottom of the side (figure 4.3). Three bins were fixed directly to the ground using rope secured with tent pegs and three bins fixed onto wooden posts so the bottom opening was 1m above ground level. The bins were placed alternatively, one on a post one on the ground, in a row outside of, and approximately 2m away from the old school house, a known over-wintering site. Bins had tightly fitted lids secured with rope. Collections were made by first looking for resting mosquitoes through the 100mm entrance hole using a torch then gently removing the lid and collecting any other adults. Although some mosquitoes escaped during collecting, the loss was small (less than 10%) and would be similar between different bins and collections. Collections started on the 6<sup>th</sup> January 2003 and finished 2<sup>nd</sup> October 2003. All mosquitoes were collected and brought into the laboratory, sexed and identified.

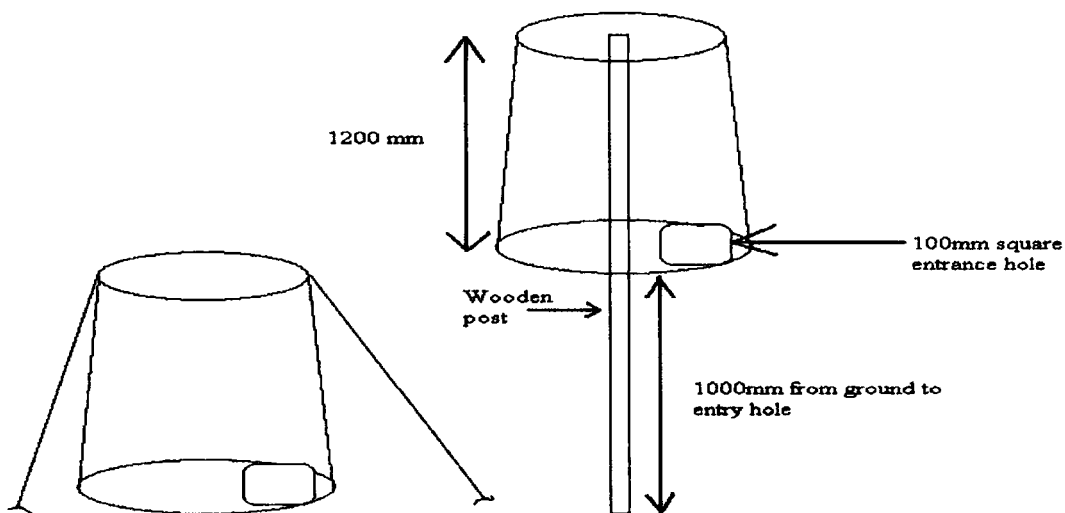

Figure 4.3 Experimental design for resting site experiment. Six black bins were either raised to a height of 1m from the ground (n = 3) or situated directly on the ground (n = 3).

### Malaria risk

To assess the risk of vivax malaria on Sheppey the basic reproductive rate or  $R_0$  was calculated. This represents the number of malaria cases which derive from one

infective case. A value greater than one will result in the disease becoming established, a value of less than one means the disease will become extinct. Values for calculating  $R_0$  which takes the form:

$$R_0 = \frac{ma^2bp^n}{-\ln(p)r}$$

Where  $ma$  = number of bites per person per day,  $a$  = the proportion of meals taken from a human rather than another source,  $b$  is the proportion of female mosquitoes which develop parasites after taking an infective bloodmeal,  $p$  = the daily survival probability,  $n$  = the time for the parasite to develop in the mosquito and  $r$  = the recovery rate in humans.

Values of each parameter in this equation were taken from data collected during the fieldwork described here or from previously calculated values (Lindsay & Thomas, 2001). Field data collected at Sheppey over a two week period give a mean biting average ( $ma$ ) of 2.5/per day or 912.5 over one year.  $a$  is calculated by taking the proportion blood fed and dividing by the length of the gonotrophic cycle (length of time between taking a bloodmeal and laying an egg batch). Bloodmeal analysis of *An. atroparvus* on Sheppey gives a value of 0.02, gonotrophic cycle is taken as 9 days (Shute, 1933).  $b$  is the proportion of female mosquitoes which develop parasites after taking an infective bloodmeal, here the value 0.19 (James, 1931) was used from the historical outbreak of vivax malaria on Sheppey.  $p$  is the daily survival probability taken as 0.175/day and was derived from the upper range of survival for laboratory data (Jetten & Takken, 1990),  $n$  is the time for the parasite to develop in the mosquito, taken from the literature as 9 days (Jetten & Takken, 1990).  $r$  is the recovery rate in humans, using data from Boyd, 1949, the value of 0.0167/day assumes a patent period of 60 days.

### Statistical analysis

A non-parametric Kaplan-Meier method was used to analyse the survival data. The cumulative survival is initially 1 and represents the proportion of adults alive over time. The Kaplan-Meier method allows an escaped mosquito to be censused in the analysis. Censusing is assumed to occur at the end of the day. This means the number at risk the following day is reduced by the number lost the previous day. To

test survival between the two sites a log rank test was used which compared expected and observed deaths at the two sites, assuming no difference in survival between the two. ANOVA and t-test analysis used for site selection data were conducted in SPSS (Statistic Package for Social Sciences, Inc).

## Results

A total of 1297 *An. atroparvus* were collected from the 1<sup>st</sup> November 2001 until 17<sup>th</sup> April 2003. Most were females, 1044 (80%) with only 253 males (20%) collected.

### Identification

A total of 60 adults were identified all of which showed PCR product in agreement with *An. atroparvus*. These results were confirmed by analysing 10 mosquitoes from the same over-wintering sites at the London School of Hygiene & Tropical Medicine.

### Indoor-resting population

A total of 1007 adult mosquitoes were collected over 11 months (1<sup>st</sup> November 2001 – 4<sup>th</sup> October 2002) from indoor resting sites. A ratio of 3.5 : 1 females for each male were collected. Adult males were absent at indoor resting sites from November 2001 until June 2002. Resting females were found throughout the winter months declining in numbers from a September peak to a low in May (figure 4.4).

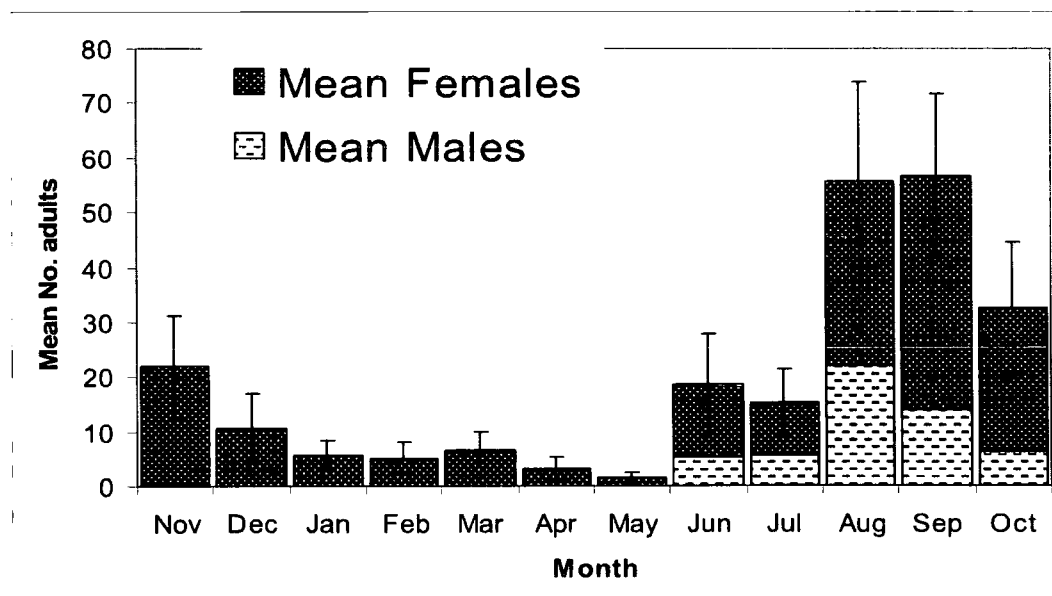

Figure 4.4 Mean number of indoor resting males and females from five buildings on the Isle of Sheppey 2001 – 2002.

Error bars show 95% C.I. for total mean numbers collected.

The data for blood-fed females collected from November 2001 until October 2002 (figure 4.5) shows the presence of blood-fed females throughout the year. Most blood-fed females were found in August and 76% (185/242) of all bloodfeds were found at the horse stable; the only site with hosts inside. This bias in sites for blood-fed females gives rise to the large error bars in figure 4.5.

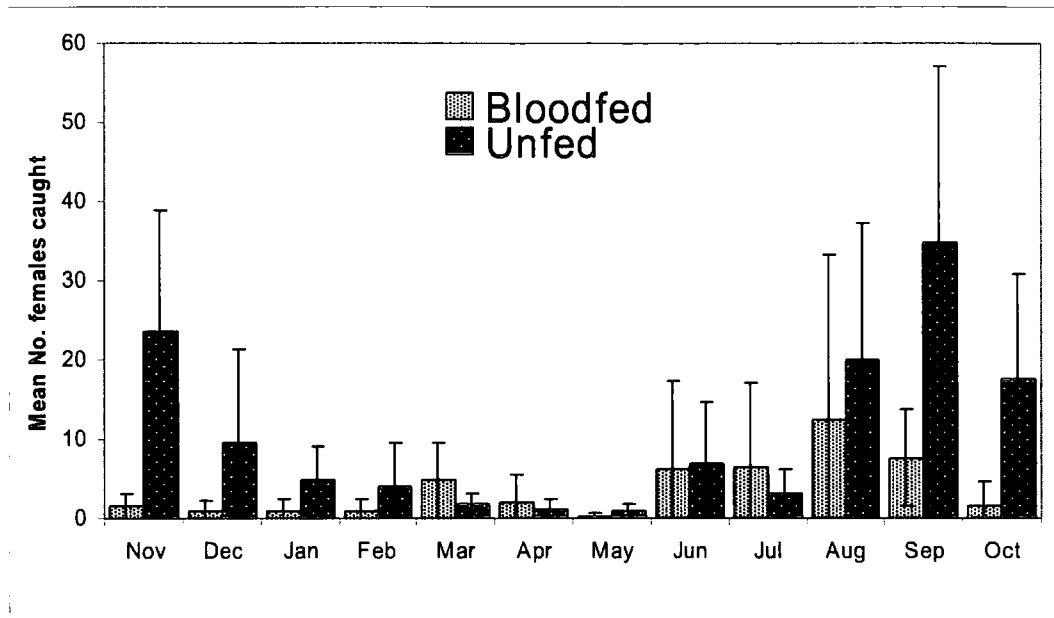

Figure 4.5 Mean number of fed and unfed *An. atroparvus* collected from five resting sites on the Isle of Sheppey, Kent.

Blood-meal analysis shows that most mosquitoes fed on horses, despite there being a much larger number of cattle than horses (table 4.1). In the year that these blood samples were collected there were 10,545 cattle and only five horses. The presence of a human-blood fed mosquito in an uninhabited shelter shows that there is some movement between sites but only 8% of mosquitoes sampled from the stable had fed on either cattle or a human host. At uninhabited shelters (three sites) 12% of mosquitoes had fed on a horse.

Table 4.1 Blood meal analysis of 104 *An. atroparvus* from four resting sites on the Isle of Sheppey.

Site	Host			
	Human	Horse	Cattle	Unknown
Stables†	1	58	5	13
Derelict Cottage	0	1	1	1
Derelict School	0	2	12	3
Pillbox	1	0	2	4

† only site housing large domestic animals

The proportion of human blood fed mosquitoes from the 83 known samples gives a Human Blood Index (HBI) of 0.02.

The parity of females shown in figure 4.6 clearly shows the similar seasonal pattern between females that have laid an egg batch and those that have not. The only month where no parous females were found was February. Table 4.2 shows the pattern of ovarian development for the same year. The first gravid female was found in April and the last in September.

Table 4.2 Ovarian stages of 232 *An. atroparvus* for the year 2002

Month	No. Dissected	Christophers Stages				
		I	II	III	VI	V
Jan	23	0	23	0	0	0
Feb	21	0	21	0	0	0
Mar	17	0	16	1	0	0
Apr	8	0	2	1	3	2
May	6	0	1	1	1	3
Jun	22	0	2	5	9	6
Jul	34	5	6	7	3	13
Aug	66	16	22	9	7	12
Sep	6	0	0	0	4	2
Nov	17	6	9	2	0	0
Dec	12	2	10	0	0	0
<b>Total</b>	<b>232</b>					

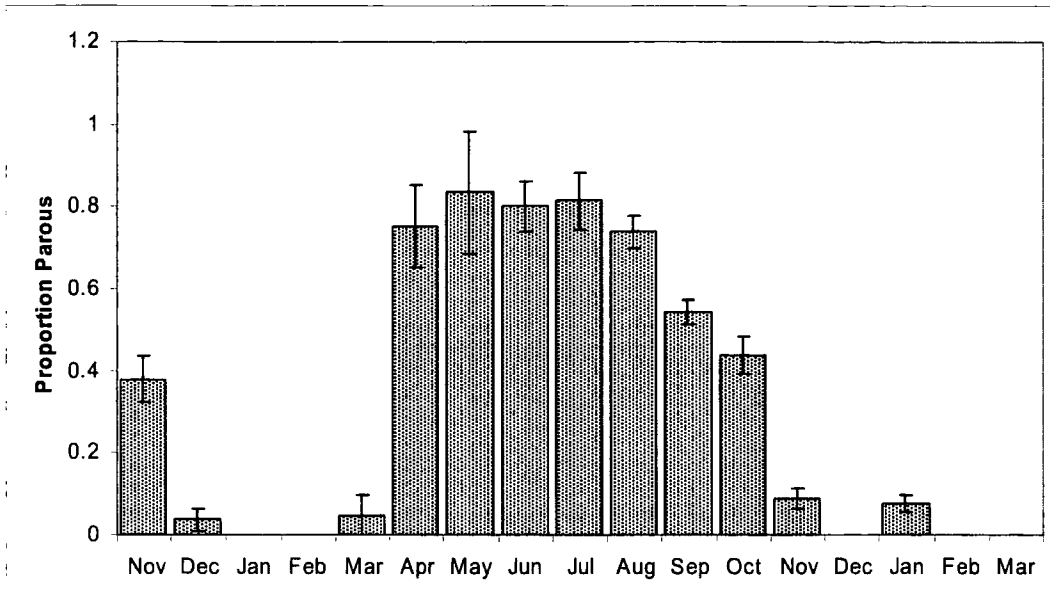

Figure 4.6 Proportion of parous *An. atroparvus* collected resting in building from November 2001 until March 2003. Error bars show  $\pm 95\%$  C.I.

The data from the temperature loggers shown for 4 sites in figure 4.7 show that only negative sites drop below 0 °C.

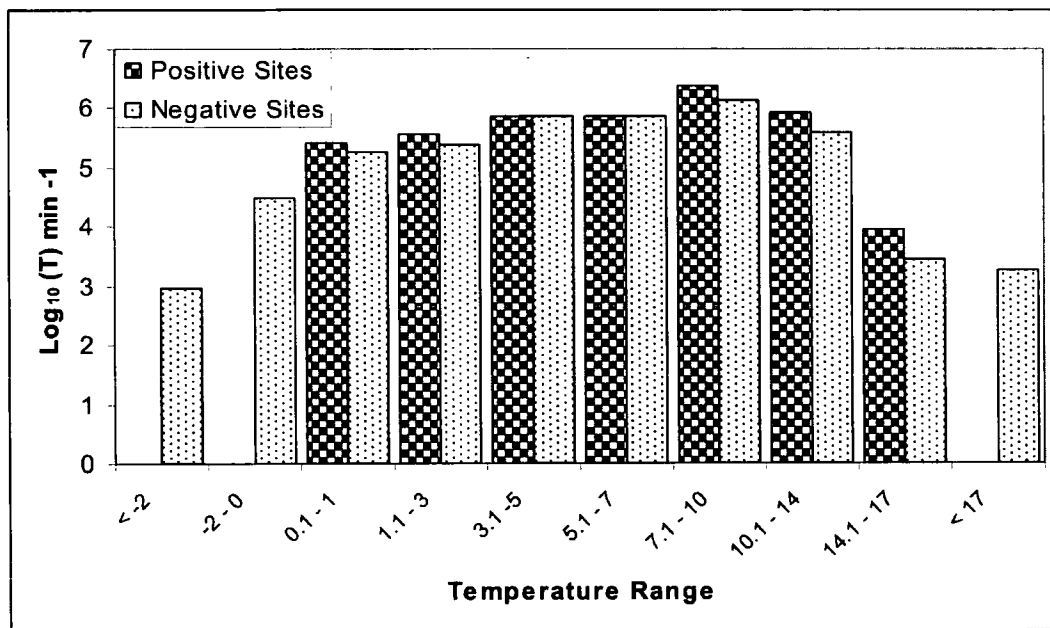

Figure 4.7 Log<sub>10</sub> time in minutes at each temperature range in positive or negative over-wintering sites within ten temperature zones.



### Over-wintering survival

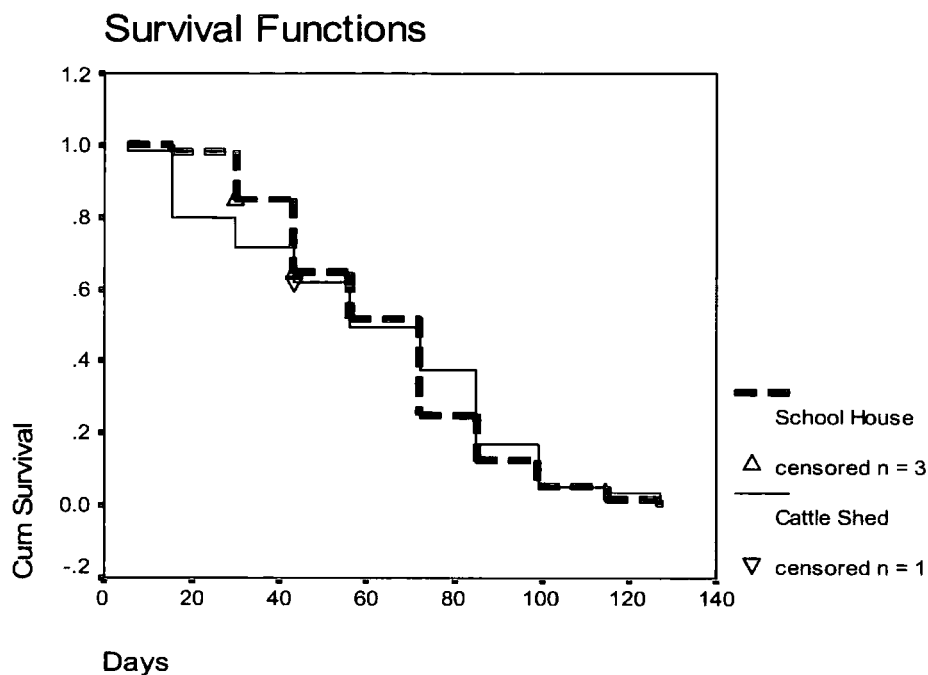

Figure 4.8 Cumulative survival for two cohorts of 60 *An. atroparvus* mosquitoes at two sites on the Isle of Sheppey, Kent from 29<sup>th</sup> November 2001 – 4<sup>th</sup> April 2002.

Survival between over-wintering sites at a positive site and negative site were similar after two months (positive site = 63.6; 95% C.I.= 57.19-70.07; negative site 60.6, 95% C.I.= 52.3-69.0). The survivorship range varied from 15 to 127 days.

Survivorship curves shown in figure 4.8 show the similar survival pattern at both sites.

### Outdoor resting and emerging adults

Attempts to attract resting adults newly emerged from larval sites in the large tents failed. No mosquitoes were found resting in any tents during the three-week period or were found in sweep net samples.

### Selection of over-wintering sites

In the experiment designed to find out whether mosquitoes preferred to enter potential resting sites close to the ground or not, 202 *An. atroparvus* were collected. Of these 195 (94 males and 101 females) were collected in bins with entrances close to the

ground and only 7 (1 male and 6 females) were found in bins 1m above ground level (ANOVA,  $F = 39.8$ ,  $df = 26$ ,  $P < 0.001$ ), showing a significant orientation to entering sites at a low level.

### Malaria risk

Basic reproductive rate or  $R_0$  gave a value of 0.004.

### **Discussion**

In this study I recorded the life history of *An. atroparvus* during one year, the first time this has been recorded in the UK. *An. atroparvus* over-winters as adult females. This is relatively uncommon in British mosquitoes since only 7 of the 32 species over-winter as adults (Marshall, 1938). From January, when the number of females over-wintering indoors has stabilized, females rarely move and feed. Between the end of March and early April they begin to leave their over-wintering sites and lay eggs. These results support the earlier findings of Ramsdale and Wilkes who found that occupied over-wintering sites had numerous females in February but the number declined in March (Ramsdale & Wilkes, 1985). The first gonoactive females above the diapausing stage II development appeared in March, suggesting that photoperiod is beginning to activate the females by this time. It is possible that the first larvae are present during March although it was April until any fully gravid individuals were found.

Shortly after egg laying these females die. Some females leave their over-wintering site later than others, as there are always low numbers during the cold spring months. The proportion of parous females, those that have laid at least one batch of eggs, rises sharply in April. This rise in parous mosquitoes suggests that over-wintering females return to their over-wintering sites after egg laying, rest before they die. The high mortality in these reactivated females has also been reported by other authors (Detinvo, 1962, 1968; Ramsdale & Haas, 1978).

The first generation of adult females in the year is relatively small and occurs from May to June. These females have a short summer life because of the elevated temperatures and it is their offspring that gives rise to the larger adult population seen in August and September. This second generation results in many young females at the end of September, which then mate, and enter a stage of gonotrophic dissociation; where they may take a blood meal, but not use it to produce an egg batch. As daylight shortens and temperatures drop parous females and males die, leaving the fertile nulliparous females to complete the annual cycle by over-wintering.

The only month when parous females were not found was in February, meaning females from the previous summer can survive into January before they die. Males were only found for five months of the year, being present until the end of October in resting sites.

Selection of over-wintering sites is an interesting facet of this species ecology. Reading through previous research it is easy to gain the opinion that the sites used for over-wintering are either left empty in the summer, or that different sites are selected for summer and winter resting (Marshall, 1938, Snow 1990). This study clearly shows that resting adults are found in the same sites all year round, and that sites without winter resting females were also negative throughout the summer. The results from the temperature loggers shows that no sites with adult mosquitoes fell below freezing at any time during the winter, whereas the negative sites did, as did the ambient air temperatures as measured by the weather station. This is of clear survival advantage to the mosquito since, as with many insects, the formation of ice crystals within cells will disrupt the normal functions and result in the animal's death (Leather, *et al.*, 1993). The unanswered question is how do the females know when they select a site in autumn that it is unlikely to freeze during the winter? The selection for sites may be as simple as the presence of conspecifics or the existence of aggregation pheromones as occurs with over-wintering ladybirds (Cope, 1983). This could be tested by the removal of over-wintering mosquitoes over an entire season and seeing if it is re-colonised the following year. My findings show that the mortality at a negative and a positive site were similar, although the negative site did not fall below freezing during the study period when survival was monitored. Mortality in the cages was higher than expected under natural conditions as normally, resting adults

are mobile and would move within the resting site in response to external stimuli such as draughts and temperature. Obviously those mosquitoes placed in a netted cage are limited in their movements and unable to seek a more favourable location.

Interestingly it was observed that when temperatures were very low, the characteristic anopheles resting stance of the body held at an angle of 45° was lost and the body of the insect was held parallel to the resting surface in a similar posture to that exhibited by resting culicines.

The presence of hosts at sites did not attract mosquitoes, as modern cattle and sheep barns containing 30 – 50 sheep and cattle failed to act as a resting site for *An. atroparvus*. A wooden constructed stable with five horses provided 74% of all blood fed mosquitoes despite the presence of 10,545 cattle approximately 200-500m away. The only apparent difference in structure was that the stables were well constructed and quite small compared to very large and draughty barns containing the cattle and sheep. Logger data revealed no detectable differences between negative and positive sites in September and October which could have been used to detect a potential overwintering site. This is assuming that a 0.1 °C measurement, as recorded by the loggers was sufficient to detect any subtle differences.

There is no doubt that these mosquitoes use certain cues for selecting resting sites, as demonstrated by the finding that nearly all mosquitoes will largely enter sites where there is an entrance close to the ground and few enter those where the entrance is raised 1 m from the ground. This result explains why I failed to find any *An.*

*atroparvus* resting in bird hides on stilts. The phenomenon of mosquitoes flying and seeking for blood meals close to the ground is not a new discovery. A simple way to avoid mosquitoes was known even in ancient Egypt, when people living near marshes would sleep on elevated platforms to reduce bites (Lindsay *et al*, 2002).

The failure of the tents to attract any resting mosquitoes was most likely due to their construction. Being canvas and with large sections of netting along the side they were well light and draughty, unlike sites that harboured resting adults. This species of mosquito is limited in its adult habitat by its need to rest in suitable shelters. Despite the Isle of Sheppey apparently providing ample numbers of resting sites, fieldwork quickly uncovered that only a few select buildings are suitable for resting. Such a discovery adds considerable weight to the idea that improved housing and modern

barn construction led to the reduction of both *An. atroparvus* and vivax malaria. This is an insect clinging onto survival with its best years firmly behind it. If efforts were made to remove the few resting sites it is hard to imagine that this mosquito would remain established on the Isle of Sheppey. With this knife edge existence and a basic reproductive rate of 0.004, much less than the value of 1 needed to maintain infection in the local community, the threat of malaria returning to Sheppey seems an extremely unlikely event.

## References

- Baust, J. G. & Edwards, J. S (1979). Mechanisms of freezing tolerance in an Antarctic midge, *belgica antarctica*. *Physiological Entomology*, **4**: 1 - 5.
- Beaty, B.J. & Marquardt, W.C. (1996). *The Biology of Disease Vectors*. University Press of Colorado, Niwot.
- Bull, C.G. & King, V.W. (1923). The identification of the bloodmeal of mosquitoes by means of the precipitin test. *American Journal Of Tropical Medicine and Hygiene*. **3**: 491-496.
- de Buck, A. & Swellengrebel, N. H. (1934). Behaviour of Dutch *Anopheles atroparvus* and *messeae* in winter under artificial conditions. *Rivista di Malariologia*, **13**: 404-416.
- Detinova, T.S. (1968). *Age-grouping methods in Diptera of medical importance*. World Health Organisation. Monograph Series No. 47. Geneva, Switerland.
- El Said, S., Beier, J. C., Kenawy, M. A., Morsy, Z. S. & Merdan, A. I. (1986). Anopheles population dynamics in two malaria endemic villages in Faiyum governorate, Egypt. *Journal of the American Mosquito Control Association*, **2**: 158-163.
- Cope, N. H. (1983). Temperature-dependent behaviours and cluster formation by aggregating ladybird beetles. *Animal Behaviour*, **31**: 424- 430.
- Hackett, L. (1937). *Malaria in Europe: An ecological study*. London, Oxford University Press.
- Kohshima, S. (1984). A novel cold-tolerant insect found in a Himalayan glacier. *Nature*, **310**: 661 - 671.

- Leather, S.R., Walters, K.F.A. & Bale, J.S. (1993) *The Ecology of Insect Overwintering*. Cambridge University Press, Cambridge.
- Lee, R. E. and Denlinger, D. L. (1985). Cold tolerance in diapausing and non-diapausing stages of the flesh fly, *Sarcophaga crassipalpis*. *Physiological Entomology*, **10**: 309-315.
- Lee, R. E., Strong-Gunderson, J. M., Lee, M. R., Grove, K. S. & Riga, T. J. (1991). Isolation of ice nucleating active bacteria from insects. *Journal of Experimental Zoology*, **257**: 124-127.
- Lindsay, S.W., Emerson, P.M. Charlwood, J.D. (2002). Reducing malaria by mosquito-proofing houses. *Trends in Parasitology*. **18**: 510-514.
- Marshall, J. F. (1938). *The British mosquitoes*. London, The British Museum.
- Vaile, M. & Miles, S. J. (1980). Mosquitoes and malaria in the north Kent marshes. *Community Medicine*, **2**: 298-301.
- Ramsdale, C. D. & Haas, E. (1978). Some aspects of the epidemiology of resurgent malaria in Turkey. *Transactions of the Royal Society Medicine and Hygiene*, **72**: 570 – 580.
- Ramsdale, C. D. and Wilkes, T. J. (1985). Some aspects of overwintering in southern England of the mosquitoes *Anopheles atroparvus* and *Culiseta annulata* (Diptera: Culicidae). *Ecological Entomology*, **10**: 449-454.
- Shipitsina, N. K. (1964). Transmission season and the zones of malaria in the Soviet Union. In: *Problems of medical parasitology and prevention of infectious diseases*. (Ed: Moshkovski, M.F.) Moscow, USSR, The Martsinovskij Institute of Medical Parasitology and Tropical Medicine.
- Shute, P.G. (1933). The life-history and habitats of British mosquitoes in relation to their control by anti-larval operations. *Journal of Tropical Medicine and Hygiene*, **36**: 83-88.
- Snow, K. R. (1990). *Mosquitoes*. Slough, Richmond Publishing.
- Wesenberg-Lund, C. (1920-21). Contributions to the biology of the Danish Culicidae. *Det Kongelige Danske Videnskabers Selskabs Skrifter 8 R*, **7**: 1-208.

## Chapter 5

### Identifying the aquatic habitats of *Anopheles atroparvus* on the Isle of Sheppey.

#### Summary

##### Introduction

*Anopheles atroparvus* is a salt marsh mosquito, once famous as a vector of vivax malaria along the coast of southern England. With the affects of global warming and rising sea level some believe that malaria could return to places like the Isle of Sheppey . This survey characterised the typical larval habitat of this mosquito.

##### Methods

210 different water bodies were surveyed for the presence of the aquatic stages of *An. atroparvus* using standard dipping techniques. At each site pH, salinity, temperature and depth was measured and samples of associated insects and vegetation recorded.

##### Results

*An. atroparvus* larvae were found only in small surface pools on top of thick algal mats comprised mainly of *Enteromorpha* spp. Here it is 4 °C (95% C.I. = 18.5-26.7) warmer, pH is 9.0 (95% C.I. = 8.1 – 9.9), 1.8 higher than negative sites, and salinity is lower (2200mg/L) compared to sites without larvae (3400mg/L). On these algal mats there are fewer predators and these pools may trap pollen and seeds from bank side plants providing a rich food resource for the aquatic stages of this mosquito.

##### Interpretation

Freshwater pools in floating islands of algae provide ideal nurseries for maximising the production of *An. atroparvus*. This highly specialised breeding habitat allows the aquatic stages to develop faster, with less predation and may lead to larger adults than other sites. The reduction of such sites by dredging, drainage and removal, may have contributed to the disappearance of malaria from England.



## Chapter 5

### Identifying the sources of *Anopheles atroparvus* on the Isle of Sheppey.



Plate 5.1 Larval site for *Anopheles atroparvus* showing dense growths of vegetation favoured by this species.

#### Introduction

Homometabolous insects such as mosquitoes exploit an entirely different resource during their larval stages than do adults. Mosquito larvae are small, soft bodied, nutritious and easy prey to the myriad predators that inhabit their aquatic habitat. A relatively simple step to reduce the chance of predation is to utilise ephemeral bodies of water. Such strategies have been adopted by many species of mosquitoes. Examples of ephemeral breeding sites include hoof prints, tyres, bamboo stumps, bromeliads, tree holes, leaf axils, snail shells, crab-holes, fallen leaves and fruit husks (Laird, 1988). Some species have become highly specialised at selecting a particular type of larval habitat. Good examples of this are seen with *Wyeomyia smithii* which breeds only in *Sarracenia* spp. of pitcher plants, and *Armigeres dolicocephalus*, found exclusively in bored bamboo (Hamilton, 2002). Often specialists evolve mechanisms



that allow them to maximise survivorship even under extreme conditions. For example, *W. smithii* can be found within frozen blocks of ice within pitcher plants with little subsequent mortality (Armbruster *et al.*, 1999).

One of the commonest sites for mosquitoes to inhabit are small pools or ponds. Even these apparently uniform habitats can represent a range of ephemeral breeding sites depending on the presence or absence of vegetation, the amount of direct sunlight, water quality and movement. Each microhabitat will favour particular species of mosquitoes. The use of vegetation by mosquito larvae falls into two basic categories. Firstly there are those species that belong to the genera *Mansonia* and *Coquillettidia* that use vegetation as an airline. They plug into the plant stem to obtain an oxygen supply, thus circumventing the need to be at the surface. Secondly several species, including many *Culex* spp and *Anopheles albimanus* are found in close association with thick filamentous algae, probably due to the protection it affords from predators (Rejmankova *et al.*, 1993; Service, 1996).

The impact of predators on mosquito larval stages has been studied often (Kramer & Garcia, 1989; Mogi, *et al.*, 1980; Sunish & Reuben, 2002). Although the idea of mosquito suppression through the use of invertebrate predators is inherently appealing it has proved difficult to show the direct affect predators have on larval survivorship. Kramer and Garcia (1989) tried to determine both the biotic and abiotic factors influencing the development of *Culex tarsalis* in Californian rice fields (Kramer & Garcia, 1989). Using a step-wise multiple regression approach no significant effect was shown. In their work Kramer and Garcia grouped all predators as a single variable within the analysis whilst Mogi *et al.*, (1980) have shown that mortality in *Cx. tritaeniorhynchus* is due to a complex of predators (Mogi *et al.*, 1980). Sunish & Reuben (2002) found that Notonectid nymphs and adults, Dytiscids, Anisopterans and Zygopterans could all have a negative effect on *Cx. tritaeniorhynchus*, *Cx. vishnui* and *Cx. pseudovishnui* survival up to and including the pupal stage (Sunish & Reuben, 2002). The copepod *Mesocyclops* has been used successfully to control and eradicate the mosquito *Aedes aegypti* in northern Vietnamese villages in but this seems to be the only example of sustained biological control of mosquito larvae (Nam *et al.*, 1998).

The UK has 32 species of mosquito which range from specialist niche breeders like *An. plumbeus* and *Aedes geniculatus* which breed almost exclusively in tree-holes of deciduous trees (Kitching, 1971; Armbruster *et al.*, 2000) to those with more catholic preferences such as *Cx. pipiens*, with larval sites including ponds, streams, pools, hoof prints, containers and marshes in either clean or foul water. *An. atroparvus* and *An. messeae* belong to the thirteen strong *An. maculipennis* group (White, 1978). *An. atroparvus* and *An. messeae* are morphologically identical but can be separated by their differing ecologies and patterning of their eggs. In the UK only *An. atroparvus* has been incriminated as a vector of *P. vivax* due mainly to its readiness to feed on humans, whilst *An. messeae* feeds almost exclusively on livestock, although it has been incriminated as a *vivax* malaria vector in western Russia (Sokolova & Snow, 2002). However *An. messeae* has been incriminated as a vector in Sweden (Jaensson *et al.*, 1986) and Russia (Hackett, 1937). A recent study looking at a species specific length of the internal transcribed spacer, ITS2 of the rDNA concluded that Russian and UK populations of *An. messeae* were not genetically different and that the differing blood feeding habits of the two populations were the result of vector and host population density (Lee, 2001). The larval ecology of both *An. atroparvus* and *An. messeae* also differ. *An. atroparvus* breeds predominantly in brackish, still or very slow flowing water associated with coastal marshland (Snow, 1987), whilst *An. messeae* breeds in essentially similar habitat but in fresh water (Snow, 1987) having a lower tolerance of salinity than *An. atroparvus* (Jaensson *et al.*, 1986).

The cause for the decline of malaria in the UK is not fully understood and was most likely the result of several factors, including changes in water management and increases in cattle numbers (Kühn, *et al.*, 2003). Over the past 300 years extensive areas of salt marsh in the UK were re-claimed for grazing and arable crops irrigated with freshwater (Thirsk, 1957; Eddison, 2000). More recently there have been active measures to restore some of the lost salt marsh. The Department of Environment Food & Rural Affairs has several ongoing schemes that have and continue to create salt marsh. On the Essex coast along the River Blackwater two areas have been returned to salt marsh since 1996 when tidal breaching of the sea wall was allowed. This is an area situated in the historically malarious region of the Dengie peninsula. The Royal Society for the Protection of Birds is also implementing similar schemes. A managed retreat at Havergate Island in Suffolk is using newly created areas of salt

marsh to protect the Island from sea level rises. At Freiston Shore nature reserve on the Wash coast new sea defences have been completed behind the existing sea wall and the old sea walls will be breached to create salt marsh and lagoons.

Recent concerns over the re-introduction of malaria into areas that, historically, have suffered from the disease, or into previously malaria free areas has led to many countries investigating the current status of anopheline distribution, suitable breeding sites of potential vectors and the effect of environmental changes on malaria transmission (Singal *et al.*, 1977; Packard, 1986; Hira *et al.*, 1988; Anon, 1998; Baldari *et al.*, 1998; Guarda *et al.*, 1999; Arshi *et al.*, 2000; Baranova & Sergiev, 2000; Bødker *et al.*, 2000; Lindsay & Thomas, 2001). Here I investigated the abundance, and distribution of the aquatic stages of *An. atroparvus*, an efficient vector of vivax malaria, on the Isle of Sheppey, the last place in England to experience a large epidemic of malaria (Newman, 1919; James, 1929; Shute, 1945; Service, 1970; Shute & Maryon, 1974; Dobson, 1980; Vaile, 1980; Dobson, 1989, 1994, 1997). This is the first study to systematically describe the distribution of this vector species in the UK.

## **Materials and methods**

### Field Site

The Isle of Sheppey is detached from the mainland of South-East England by a narrow stretch of water, the River Swale (figure 5.1). The Isle is formed from London clay deposits washed down the Thames and Swale river systems. It is approximately 6.5km wide and 14.5 km long with an area of 22,400 hectares. The north of the Isle is at a higher elevation (70 – 30m) than the south (10-5m) and is populated by the inhabitants of Queenborough, Sheerness, Eastchurch, Minster and Warden with a total population of approximately 30,000. The south of the island is mainly agricultural land used for grazing sheep and cattle; the name Sheppey comes from the Saxon word for sheep. Region 1 (figure.1) is bounded along the shore by a sea wall with the interior land laying approximately at sea level. Region 2 is not protected along the coast and is frequently flooded during the winter months.

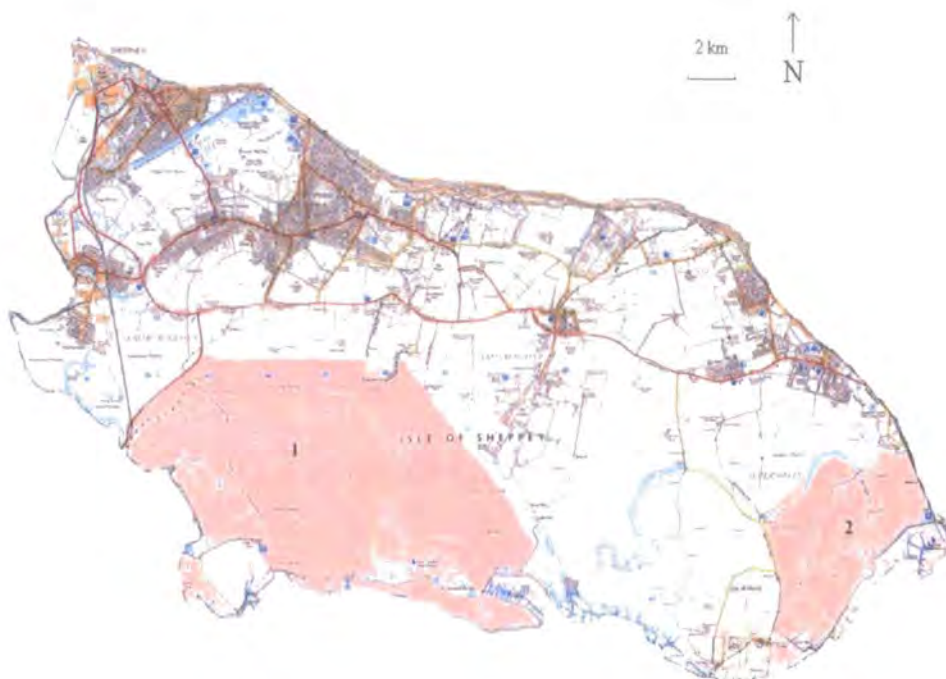

Figure 5.1 Map of the Isle of Sheppey showing the populated northern part and the marshland areas of the south. Regions shaded represents areas covered in larval survey.

Both areas have extensive drainage channels 1 to 10m wide. Many of the main channels are kept clear by dredging and the water ranges in salinity from fresh to seawater. Region 2 has many channels that are tidal and in direct contact with the sea at high tide. Most surveying took place in region 1 as previous work on adult populations had shown this to be the most productive area on the Isle.

#### Weather Data

Region 1 (figure 5.1) had an automatic weather station (Skye Instruments, Llandrindod, Wales) situated in close proximity to larval breeding sites and recorded the surface water temperature, air temperature, humidity, rainfall, wind speed and wind direction every 30 minutes. This data was collected for the entire period of larval sampling allowing daily maximum and minimum temperatures to be determined.

### Larval Sampling

A total of 210 water bodies were sampled for the presence or absence of mosquito larvae from the two regions shown in figure 5.1 from 14<sup>th</sup> June to 26<sup>th</sup> September 2002. Water bodies were categorised into 8 different classes (table 5.1)

Table 5.1 Water bodies used for larval sampling

Type of water body	Definition
Flowing drainage channel	Man-made channel approximately 2m in width with algae
Non-flowing drainage channel	2m across with heavy plant growth
Shallow saline pools	Little or no vegetation cover
Large open channel	Greater than 10m wide with no algae
Narrow shallow channel	Less than 1m wide
Slow flowing channel	5m wide with emergent reeds and algal mats at edge
Flowing drainage channel	Approximately 2m in width with no algae
Lake	Surrounded by <i>Typha</i>

At each site a total of 10 dips were taken using a plastic dipper (BioQuip<sup>®</sup>) with a 220mm diameter and a 350ml capacity when full. Each dip was taken approximately 1m apart and the minimum distance between different sites was 5m. All mosquito larvae were collected into glass tubes and brought back to the laboratory for keying and rearing. Adults of the *An. maculipennis* complex were kept on silica gel for analysis by a polymerase chain reaction (PCR) assay. Each larval stage was recorded and any other insect species which occurred in the dipper with the larvae was also kept and keyed out to the best taxonomic level possible using diagnostic features from couplet keys (Cranston, 1982; Macan, 1982; Cranston, 1987; Elliott, 1988; Guthrie, 1989; Harker, 1989; Savage, 1989; Hynes, 1993; Miller, 1995; Savage, 1999).

In addition, at each collection site water temperature at the surface and approximately 300 mm beneath it were taken, along with the pH, salinity and dissolved oxygen using a water sampling kit (WTW Multi 340i, Ft Myers, USA). Salinity was converted from mS/cm to mg/L by calibrating the probe with known amounts of NaCl solution

from fresh water to sea water so all field collected values fell within the calibrations undertaken in the laboratory. Water depth was measured at each site and the amount of vegetation covering the surface area of one square meter was estimated visually. Samples of algae were collected from 25 sites and sent to Professor B. Whitton for identification. As algae are best identified when fresh, samples of algae and aquatic plant were taken the year following the larvae survey for identification.



Plate 5.2 Collecting with larval dipper.

### Mosquito Identification

Due to the difficulties of separating the larvae of *An. atroparvus* and *An. messeae* 43 4<sup>th</sup> stage larvae were raised individually to adults and identified using PCR following the protocol described by Proft *et al.*, 1999. DNA extraction and PCR procedures were those already described in chapter 4.

### Data analysis

Data were compiled into a single SPSS data file and all data analysis was carried out using SPSS v10. Independent t-tests were used for univariate analysis for the presence or absence of larvae with measured parameters. Binary logistic regression

analysis was used to build a predictive model for potential larval breeding sites. A stepwise forward conditional method was used for the model. Using data for all species trapped during larval surveying a coefficient of similarity was used to compare invertebrates associated with positive or negative sites. The Bray and Curtis modified Sørensen coefficient was used:

$$C_N = 2jN/(aN+bN)$$

Where aN = number of species at positive sites

bN = number of species at negative sites

jN = sum of lesser values for species present at sites a+b

## Results

Air and water temperature readings measured by the meteorological station at the field site during the course of larval sampling are shown in figures 5.2 and 5.3. Surface water temperature was 4.0 °C warmer in sites with larvae compared to those without. The temperature of the sub-surface water, measured 300mm below the surface, was 2.1 °C degrees warmer at sites with larvae and the pH 1.8 higher than in sites without larvae. Dissolved oxygen was also higher at positive sites by 1.7 mg/L and the salinity of the water less by 1200 mg/L at positive sites. All these differences were significant ( table 5.2). A total of 751 *An. atroparvus* larvae and pupae were collected between 14<sup>th</sup> June and 26<sup>th</sup> September 2002. Only two other species were also collected; *Ochlerotatus caspius* from a saline pool and a number of *Culex pipiens* s.l. from a water butt. No larvae of other mosquito species were found at the same sites as those of *An. atroparvus*. Mean larvae per 10 dips was 0.79 with a range of 0.1 – 4.1 for positive sites. The numbers of each larval stage over this period were; LI 332, LII 191, LIII 137, LIV 68 and 23 pupae, LI represents 1<sup>st</sup> larval stage and so on.



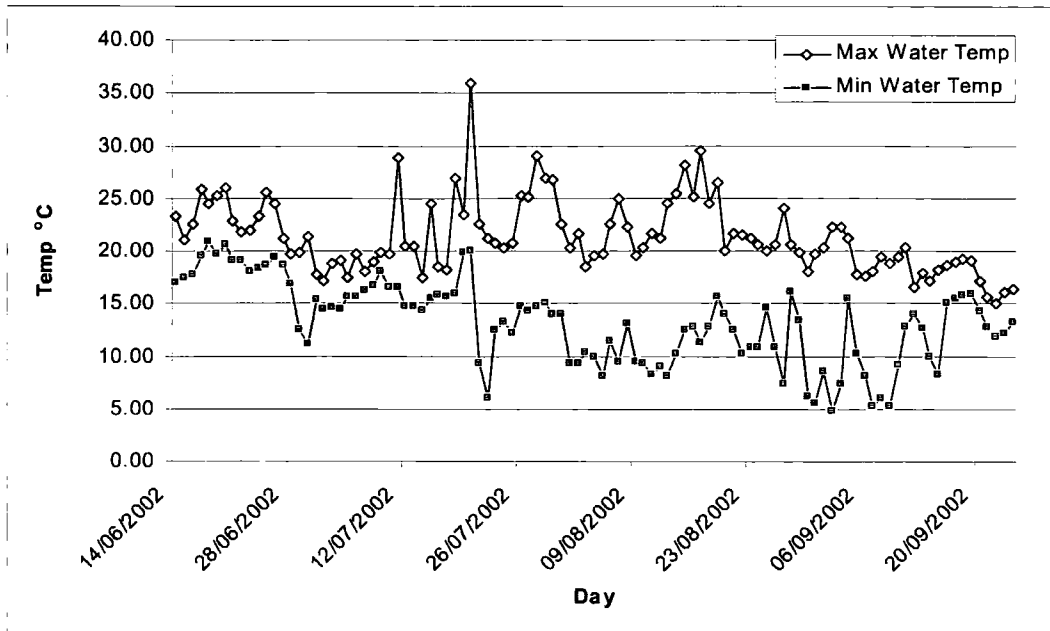

Figure 5.2 Daily maximum and minimum surface water temperature taken by a surface mounted temperature probe from a weather station, Isle of Sheppey.

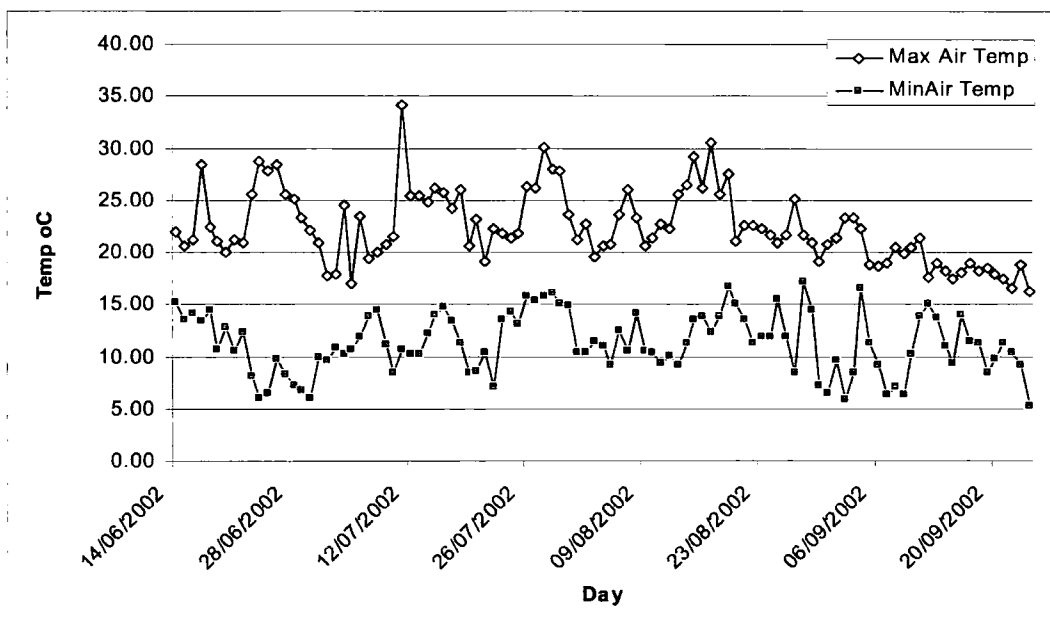

Figure 5.3 Daily maximum and minimum air temperature taken from a weather station, Isle of Sheppey. Day 1 starts at 14<sup>th</sup> June 2003 ending at 26<sup>th</sup> September 2003.

All 43 mosquito samples raised from larvae were identified as *An. atroparvus* because they showed a PCR product of 117bp (figure 5.4)



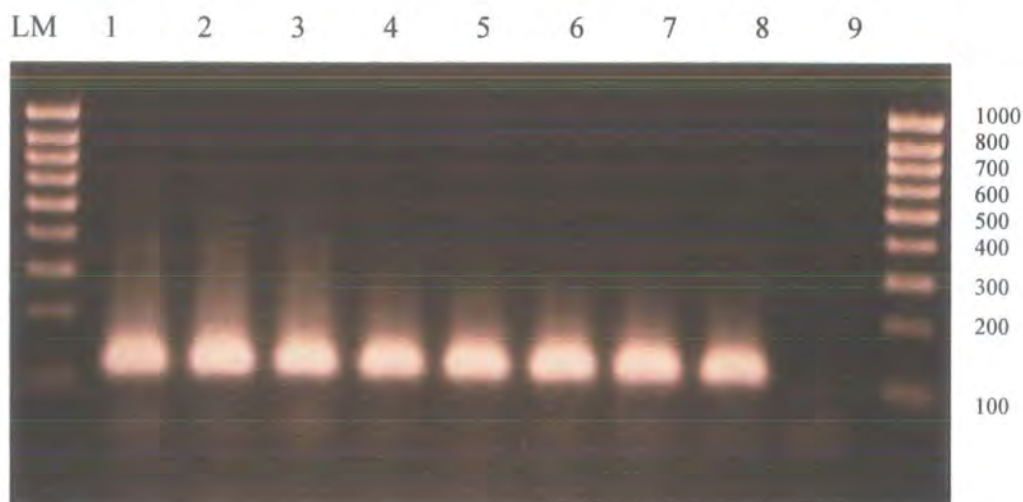

Figure 5.4 PCR results of *An. atroparvus*. Lanes 1-4 Laboratory strain from London School of Hygiene & Tropical Medicine. Lanes 5-8 adults raised from larvae from larval sites on the Isle of Sheppey. Lane 9 is negative control. Number to right show Base Pair sizes of ladder marker. *An. atroparvus* at 117 bp.

Data were pooled into two groups, composed of positive sites for *An. atroparvus* and negative sites.

Table 5.2 Independent t-test results for water measurements at sites either positive or negative for *An. atroparvus* larvae.

Parameter	Present Mean (95% CIs) (n = 95)	Absent Mean (95% CIs) (n = 115)	P
Surface H <sub>2</sub> O temperature (° C)	23.5 (22.6 - 24.4)	19.4 (18.9 - 20.0)	<0.001
Submerged H <sub>2</sub> O temperature (° C)	20.3 (19.5 - 21.0)	18.2 (17.7 - 18.8)	<0.001
pH	9.0 (8.9 - 9.1)	8.2 (8.2 - 8.4)	<0.001
O <sub>2</sub> (mg/L)	7.1 (6.3-7.8)	5.4 (4.8-5.9)	<0.001
Salinity mg/L	2200 (1900 - 2400)	3400 (2700 – 4000)	<0.001
Water Depth (mm)	541.1 (495.4 -586.9)	437.0 (390.5 - 483.7)	<0.05
% Surface cover	43.7 (37.0 - 50.5)	15.2 (11.3 - 19.3)	<0.001

Table 5.3 Independent t-test results for water measurements at sites with or without *Enteromorpha* and with or without other species of Algae.

Parameter	Present Mean (95% CIs)	Absent Mean (95% CIs)	P
<b>Enteromorpha (n = 128) (n = 82)</b>			
Surface H <sub>2</sub> O temperature (° C)	24.1 (23.3 - 24.9)	19.5 (18.9 - 20.1)	<0.001
Submerged H <sub>2</sub> O temperature (° C)	20.9 (20.3 - 21.5)	18.1 (17.5 - 18.6)	<0.001
pH	8.9 (8.7 - 9.1)	8.4 (8.3 - 8.5)	<0.001
O <sub>2</sub> (mg/L)	6.8 (6.0 - 7.6)	5.7 (5.1 - 6.3)	<0.03
Salinity mg/L	2300 (1800 - 2600)	3400 (2800 - 3900)	<0.001
Water Depth (mm)	545.9 (377.6 - 580)	444.7 (276.4 - 478.8)	<0.003
<b>Other Algae (n = 122) (n = 88)</b>			
Surface H <sub>2</sub> O temperature (° C)	22.7 (21.9 - 23.5.)	19.4 (18.8 - 20.0)	<0.001
Submerged H <sub>2</sub> O temperature (° C)	19.8 (19.1 - 20.4)	18.4 (17.8 - 19.0)	<0.003
pH	8.9 (8.7 - 9.0)	8.2 (7.4 - 8.7)	<0.001
O <sub>2</sub> (mg/L)	7.0 (6.3 - 7.7)	4.9 (4.5 - 5.3)	<0.001
Salinity mg/L	2300 (2100 - 2600)	3600 (2700 - 4300)	<0.001
Water Depth (mm)	537.4 (493.3 - 581.5)	410.3 (362.7 - 458.0)	<0.001

There was a strong correlation between the presence of both filamentous surface algae ( $X^2 = 118.2$ , Relative Risk, RR = 68.5, 95% C.I. = 9.7 – 482.2, P < 0.001) and the presence of *Enteromorpha spp.* ( $X^2 = 119.12$ , RR = 6.2, 95% C.I. = 4.1 – 9.5, P < 0.001) with larval sites. In fact no positive sites were found without one or other of these algae being present. Due to the obvious importance of algae at larval sites the

water parameters that were associated with these algal species were studied (table 5.3).

The most common *Enteromorpha* species was *E. fluxia* but sites also had some *Enteromorpha intestinalis*, therefore the use of *Enteromorpha* spp., was used as the two species are similar and could not be separated at survey sites. Tables 5.2 and 5.3 clearly show the similarities between the site parameters for larvae, *Enteromorpha* spp and algae. All preferred warmer water at a higher pH containing more dissolved O<sub>2</sub> in deeper water that was less saline.

Water salinity fell within the range of 783 mg/L to 22794 mg/L with most sites (97.62%) falling within the ranges classified as slightly saline 500 – 1500 mg/L or moderately saline 1500 – 7000 mg/L (Rhoades *et al.*, 1992). A single site was fresh rain water from a water butt, which contained *Culex pipiens s.l.* larvae. Two sites were classified as very highly saline with over 22000 mg/L one of which contained *Ochlerotatus caspius* larvae, and two sites which were approximately 8000 mg/L. There was no relationship between the number of larvae and the salinity of larval sites using linear regression for log<sub>10</sub> salinity by number of larvae per dip.

Binary logistic regression analysis was used to build a predictive model for identifying the characteristics of potential larval breeding sites. A stepwise forward conditional method was used for the model using positive or negative sites as the dependent variable and water parameters plus the presence or absence of algae and *Enteromorpha* as factors. The best model was based on only four factors (table 5.4) giving an overall predictive power of 89.5 % for the prediction of positive and negative sites.

Table 5.4 Results of logistic regression model

Variable	$\beta$	SE	P
Surface H <sub>2</sub> O Temp	0.166	0.078	0.03
pH	1.627	0.464	<0.001
<i>Enteromorpha</i>	2.218	0.611	<0.001
Algae †	10.576	27.507	0.701
Constant	-28.139	27.894	<0.3

† All algae excluding *Enteromorpha*

During the analysis a problem with coefficient testing occurred due to an undesirable property of the Wald statistic. When an absolute value of the regression coefficient becomes large, the estimated standard error is too large. This then produces a Wald statistic that is too small, leading to the rejection of the null hypothesis that the coefficient is 0, when it should in fact be accepted. To overcome this problem the model was built both with and without the variable, in this case the presence or absence of algae and the change in the value of the log-likelihood used. The log-likelihood value increased from 75.8 with the inclusion of algae in the model to 101.7 without its inclusion thus leading to the conclusion that it was an important factor in the model despite the Wald statistic suggesting it was not a good predictive factor. This problem arose due the absence of any sites being negative for larvae but positive for filamentous algae. It is somewhat academic using a multiple variable model when a univariate analysis using the presence or absence of algae gives an 87% prediction of positive sites.



Plate 5.3. Typical *An. atroparvus* breeding habitat showing surface algae

A total of 26 invertebrate species were collected in addition to *An. atroparvus* during larval collections. At sites positive for *An. atroparvus* larvae 22 associated species were found and at negative sites 24 species were found.

Table 5.4 Species collected in addition to *An. atroparvus* during larval survey.

Species	Sites†		Species	Sites	
	+	-		+	-
<i>Culex pipiens</i> House mosquito‡	0	1	<i>Libellula quadrimaculata</i> Four-spotted Chaser	1	0
Tipulide Crane fly	4	11	Corduliidae Dragonfly	2	1
<i>Ischnura elegans</i> Blue-tailed Dameselfly	6	8	<i>Cleon dipterum</i> Mayfly	28	11
<i>Notonecta glauca</i> Backswimmer	30	12	<i>Ochlerotatus caspius</i> Mosquito	0	1
<i>Gammarus</i>	1	13	Haliplidae spp	10	1
<i>Llyocoris cimicoides</i> Saucer bug	66	18	Corixidae spp Water Boatman	22	10
Ephemerotera spp Mayfly	4	12	<i>Anax imperator</i> Emperor Dragonfly	0	4
Dytiscidae spp Water Beetle	17	9	Syrphidae Hoverfly	3	0
Chironomidae Non-biting Midge	14	16	Decapoda Shrimp	0	29
Daphina spp Water flea	2	9	<i>Ranatra linearis</i> Water Stick Insect	6	1
Copepoda	26	31	<i>Gerris lacustris</i> Pond Skater	48	27
Ceratopogonidae Biting Midge	26	13	<i>Hyrometra stagnorum</i> Water Strider	3	7
Acariformes Red Water Mite	4	3	Rana spp Marsh Frog	14	3

† Sites are either + positive for *An. atroparvus* or – negative. ‡ Common name of species or order.

There was a considerably degree of overlap between species found at sites either negative or positive for *An. atroparvus* with only the mosquitoes *Oc. caspius* and *Cx. pipiens*, dragonfly nymphs *Anax imperator* and Decapoda being found exclusively at sites without *An. atroparvus* larvae. Each of the 26 species was categorised into one of three feeding guilds: filter feeder, predator or grazer. The proportions of each gave an almost equal division between the three types at 0.31 filter feeders, 0.35 for



predators and 0.33 grazers across all sites. For positive sites only the proportion of filter feeders fell to 0.19, the proportion of grazers remained the same and the proportion of predators fell to 0.31. When looking at the total number of predators across positive and negative sites there were 177 individual predators at positive sites and 86 at negative sites. The main predator species associated with positive larval sites were the saucer bug *Llyocoris cimicoides* forming 37.3 % of the total and the pond skater *Gerris lacustris* forming 27.0 %. Both species were also the most common predators at negative sites but in reverse order, *G. lacustris* forming 31.4 % and *L. cimicoides* forming 21% of predators.

Using  $C_N = 2jN/(aN+bN)$  the coefficient of similarity is :

Therefore  $C_N = 2 \times 169/(337 + 251)$

$$C_N = 0.58$$

A similarity of 1 denotes no difference between sites (Bray & Curtis 1957).

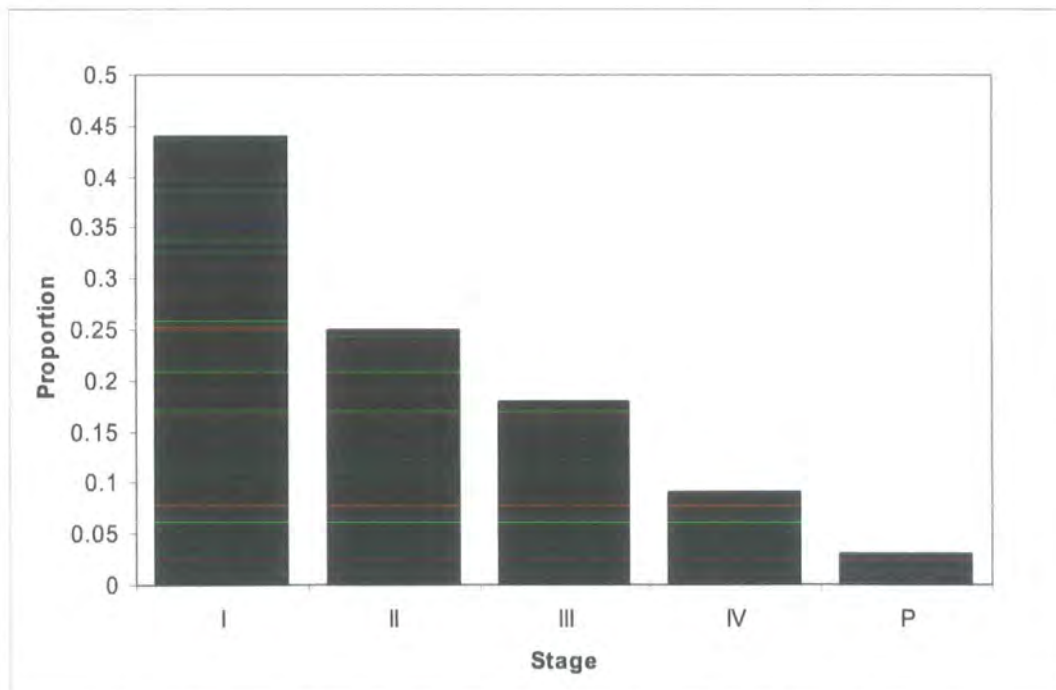

Figure 5.5 Proportion of life stages for a sample of 751 larvae (stage I to IV) and pupae collected from June to September 2002.

The proportion of larval stages showed a linear relationship between increasing development and decreasing number of individuals (figure 5.5). The proportion of each life stage by month shows a different outcome (figure 5.6) with a large peak for all stages except pupa seen during August.

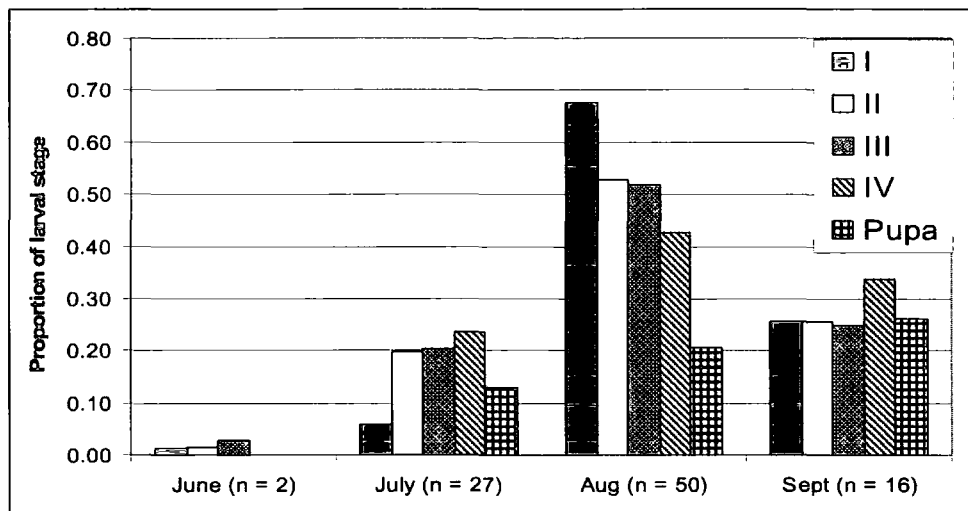

Figure 5.6 Proportion of larval stages for four months. N = number of sites sampled.

## Discussion

This survey shows that the best historical vector of malaria in England, *An. atroparvus*, still occurs within distinct and highly localised habitats on the Isle of Sheppey. Breeding habitat is restricted to a small number of drainage channels that accumulate a high density of aquatic vegetation. Of the 210 sites sampled only two other species of mosquito were found, both in different larval habitats to that of *An. atroparvus*. A water butt containing rainwater had a large number of *Cx. pipiens* s.l. larvae whilst a saline pool in a tidal region of the salt marsh had a few *Oc. caspius*. All sites with *An. atroparvus* contained the algae *E. flexuosa* or *E. intestinalis* or other filamentous algae. The reason for this association with aquatic vegetation is not known although other research has also found a similar association with *An. maculipennis* s.l. and plants (Takken, *et al.*, 2002). In The Netherlands the most common vegetation found at *An. maculipennis* s.l. larval sites were *Phragmites australis* and *Enteromorpha* species followed by *Ceratophyllum demersum* and

*Eloдея nutalii*. Despite noting an association the relationship between positive sites and vegetation was not explored in any detail.

The choice of larval habitat is determined by the behaviour of ovipositing females, although it is possible that highly efficient predators may remove the aquatic stages from a habitat. Site preference is unlikely to be selected by the larvae since in still or slowly moving water mosquito larvae have little chance of moving any great distance to find a more suitable development site. The question raised by the strong association with algae and larval sites is how does an ovipositing female select such a site? Some mosquito species elicit positive aggregation responses to the presence of con-specifics in the larval habitat (Nakamura, 1978). In some *Culex* species, there is an oviposition pheromone that will attract females to lay their eggs near those of other females (McCall & Cameron, 1995). *Culex* spp select nutrient rich water bodies as larval sites which have the capacity to support dense aggregations of larvae. The eggs themselves are laid in a closely compact manner, forming a floating raft. *Aedes* and Anopheline mosquitoes lay their eggs singly, often in waters without the rich nutrients frequently found in *Culex* sites. Aggregation then, it would seem, is advantageous when the limiting factor is other than nutrients.

The larvae of *An. atroparvus* were found within shallow pools formed on the surface of the algal mats and dense islands of submerged aquatic plants. These pools were normally little more than 10-20mm in depth and were 4°C warmer than the surrounding water. These island nurseries provide an ideal environment for rearing mosquitoes; the warmth and increased oxygen content speeds development, whilst the mats protect the young mosquitoes from predation by fishes and the pools may be especially nutritious. These sites heat up due to incident light heating the thin film of water lying over the thick vegetation. This larval habitat has been adopted by other anopheline species around the world. *An. sundaicus* is found in the brackish coastal waters of India, Indonesia and Malaya. In addition to its close association with saline waters it prefers sites with dense surface vegetation, particularly thick mats of algae such as *Enteromorpha* and *Cladophora* (Swellengrebel & Swellengrebel-Graaf, 1919). *An. albimanus* was found in association with saline water and dense growths of algae in Cuba (Carr, 1943) and the elimination of algae due to dense shade caused



the larvae to disappear. Other mosquitoes showing this preference for dense algal growths include *An. coustani*, *An. crucians* and *An. subpictus subpictus* (Laird, 1988).

Most importantly the thick algal mats protect the developing larvae from predation by fishes, which are probably the most efficient predators of the aquatic stages of mosquitoes (Singh, *et al.*, 1977; Wickramasinghe & Costa, 1986). However, I found that such sites had double the number of predators than sites without larvae. The saucer bug, *L. cimicoides* was the most common predator on the algal mats. These bugs attack their prey within the water column piercing its prey and injecting a toxin. The saucer bug is not a surface predator and is able to carry an air bubble under its elytra in order to dive into the water column. These bugs may be using the mats as a convenient diving platform with which to hunt in deeper water and not be significant predators of anopheline larvae. *G. lacustris* were also common on the mats. These are surface feeders that mostly prey on small insects that fall onto the water surface. It is possible they would take mosquito larvae from under the surface but this predator was more numerous at negative sites than positive sites suggesting that mosquito larvae is not its main source of food.

The island pools may also provide a highly nutritious environment for the aquatic stages of *An. atroparvus*. Gut dissections of *An. messeae* larvae in Russia showed that around 50% of the gut content was pollen grains from bank side plants (Dr N. Nikolaeva per comm.). The two common plants found in association with all larval sites on Sheppey were reed mace, *Typha latifolia*, and sea club rush, *Scirpus maritimus*. Both plants flower at the end of June and July providing an important resource for larvae. Reed mace produces inflorescences, each one of which is capable of producing 200,000 seeds (Lombardi, *et al.*, 1997). These inflorescences dry in the wind and the seeds are wind dispersed, a process which occurs until the end of August.

*Enteromorpha* and other species of floating algae selected particular types of water bodies. Both preferred warmer water at a higher pH in deeper water that was less saline. The higher dissolved oxygen content within the water at sites with algae and *Enteromorpha* is likely to be due to plant respiration. This may be beneficial to 1<sup>st</sup> instar larvae that have a surface area to volume ratio suitable for cuticular respiration.

This would allow the smallest larval stage to submerge itself into the mesh of algae and still respire without the need to contact the surface. The absence of *An. atroparvus* larvae in area 2 of the study site is most likely due to the tidal flow of water and the very high salinity. Salinity testing shows that nearly all larvae were found in water which was slightly saline, water conditions which were found more widely dispersed in area 1 of the survey sites than area 2.

Adult females leave their over-wintering sites between the end of April and early May and seek a suitable host for a blood meal before laying their eggs. The low numbers of larvae present in June indicates that there are relatively few ovipositing females at this time of year. By July IV stage larvae were more common, and the first pupae were found. This was followed by a surge of 1<sup>st</sup> instars in August, when the second generation commenced. By September this generation had matured to 4<sup>th</sup> stage larvae, providing the adults which would later overwinter. The temperature threshold required for the development for *An. atroparvus* is about 10° C (Artemiev, 1980) which was seen from June to September. The optimum development temperature is between 25° C and 30° C, at these temperatures development takes approximately 14 days from egg to pupa (Artemiev, 1980).

The proportion of life stages collected over the entire sampling period shows a high proportion of 1<sup>st</sup> instars, comprising nearly half of all stages collected. However this is due to the high number of 1<sup>st</sup> instars collected during August, the second generation resulting from the offspring of those few egg batches laid by the over-wintering females in April and May. In July and September IV instars were collected more frequently. The larvae found in June would be the first generation from these over-wintering females.

Due to the close association of *An. atroparvus* larvae and floating mats of algae, suitable larval sites are likely to be rare. This is due mainly to the drainage of salt marsh areas which happened slowly over several centuries but really became popular in the 17<sup>th</sup> century when James I claimed huge tracts of coastal marsh for the crown (Thirsk, 1957). The next four centuries saw much reclamation and a huge reduction in salt marsh (Thirsk, 1957). At the same time pastures were being created for an increasing number of sheep and cattle. In order to keep the water as fresh as possible

for the livestock dredging and routing of the drainage channels to water cattle was important. Standing water quickly became saline due to leeching of salts from the surrounding soil. There were many salt pans on the Isle of Sheppey and standing water would become too saline for livestock. Channels could not be left to become choked with algae and plants. It is likely that larval sites would have become increasingly rare for *An. atroparvus*, as flowing channels would have little or none of the vegetation they needed for the development and survival of the aquatic stages.

The association between *An. atroparvus* larvae and algae is extremely strong. Although it is likely that females may use certain olfactory and possibly visual cues to select larval sites, this can only be suggested by the association as there is no empirical evidence to support this. Such dense mats of algae are used in other regions of the world by other species of mosquito, and probably confer similar protective properties to the developing larvae in addition to providing the most suitable environment. Such dependence on a particular type of larval site has led to a reduction in suitable sites as drainage channels are now managed by large mechanical diggers and have been straightened and altered over many years to improve the drainage of the marshes. Ultimately, this pressure on decreasing larval sites will have contributed to the disappearance of malaria in these regions.

## References

- Anon, A. (1998). World malaria situation in 1994. *Weekly Epidemiological Record*, **72**: 285-92.
- Armbruster, P., Bradshaw, W. E., Steiner, A. L. and Holzapel, C. M. (1999). Evolutionary responses to environmental stress by the pitcher-plant mosquito, *Wyeomyia smithii*. *Heredity*, **83**: 509 - 519.
- Armbruster, P., Hutchinson, R. A. and Linvell, T. (2000). Equivalent inbreeding depression under laboratory and field conditions in a tree-hole-breeding mosquito. *Proceedings of the Royal Society of London Series B-Biological Sciences*, **267**: 1939 - 1945.
- Arshi, S., Barough, M. R. and Zareh, M. (2000). The malaria situation in the Islamic Republic of Iran. *Medical Parasitology*, **2**: 1-21.
- Artemiev, M.M. (1980). Anopheles mosquito- main malaria vectors in the USSR. In: International scientific project on ecologically safe methods for the control of malaria and its vectors; Collected Lectures 2: 45-71. The USSR state

committee for science and technology (GKNT) United Nations Environment Programme (UNEP).

- Baldari, M., Tamburro, A., Sabatinelli, G., Romi, R., Severini, C., Cuccagna, G., Fiorilli, G., Allegri, M. P., Buriani, C. and Toti, M. U. (1998). Malaria in Maremma, Italy. *The Lancet*, **351**: 1246-1247.
- Baranova, A. M. and Sergiev, V. P. (2000). The malaria situation in the Russian Federation (1997-1999). *Meditssinskaia Parazitologiia i Parazitarnye Bolezni*, **1**: 22-5.
- Bødker, R., Kisinza, W., Malima, R., Msangeni, H. and Lindsay, S. (2000). Resurgence of malaria in the Usambara mountains, Tanzania, an epidemic of drug-resistant parasites. *Global Change and Human Health*, **1**: 134-153.
- Bray, J. R. & Curtis, C. T. (1957). An ordination of the upland forest communities of southern Wisconsin. *Ecological Monographs*, **27**: 325-349.
- Carr, R. (1943). Reconocimiento del paludismo en Cuba. Inst Finlay. Serie monográfica No.8. La Habana:1-75
- Cranston, P. S. (1982). A key to the larvae of the British Orthocladiinae (Chironimidae). Ambleside, Freshwater Biological Association.
- Cranston, P. S., Ramsdale, C.D., Snow, K.R. & White, G.B. (1987). Adults, larvae and pupae of the British mosquitoes (Culicidae). Ambleside, Freshwater Biological Association.
- Dobson, M. (1980). Marsh fever - the geography of malaria in England. *Journal of Historical Geography*, **6**: 357-389.
- Dobson, M. J. (1989). History of malaria in England. *Journal of the Royal Society of Medicine supplement 17*, **82**: 3-7.
- Dobson, M. J. (1994). Malaria in England: A geographical and historical perspective. *Parassitologia*, **36**: 35-60.
- Dobson, M. J. (1997). Contours of death and disease in early modern England. Cambridge, Cambridge University Press.
- Eddison, J. (2000). *Romney marsh survival on a frontier*. Stroud, Tempus.
- Elliott, J. M., Humpesch, U.H. & Macan, T.T. (1988). Larvae of the British Ephemeroptera. Ambleside, Freshwater Biological Association.
- Guarda, A. J., Asayag, R. C. and Witzig, R. (1999). Malaria re-emergence in the Peruvian Amazon region. *Emerging Infectious Disease*, **5**: 209-15.

- Guthrie, M. (1989). *Animals of the surface film*. Slough, Richmond Publishing Co. Ltd.
- Hackett, L. (1937). *Malaria in Europe: An ecological study*. London, Oxford University Press.
- Hamilton, R. D., R.M. (2002). Novel observations of midge and mosquito population dynamics in leaves of the northern pitcher plant, *Sarracenia purpurea* l. *Hydrobiologia*, **482**: 191-196.
- Harker, J. (1989). *Mayflies*. Slough, Richmond Publishing Co. Ltd.
- Hira, P. R., Al-Ali, F., Soriano, E. B. and Behbehani, K. (1988). Aspects of imported malaria at a district general hospital in non- endemic Kuwait, Arabian Gulf. *European Journal Epidemiology*, **4**: 200-5.
- Hynes, H. B. N. (1993). Adults and nymphs of British stoneflies (Plecoptera). Ambleside, Freshwater Biological Association.
- Jaensson, T., Lokki, J. & Saura, A. (1986). Anopheles and malaria in Europe with special reference to Sweden. *Journal of Medical Entomology*, **23**: 68-75.
- James, S. P. (1929). The disappearance of malaria from England. *Proceedings of the Royal Society of Medicine*, **23**: 71-85.
- Kuhn, K.G., Campbell-Lendrum, D.H., Armstrong, B. & Davies, C.R. (2003). Malaria in Britain: Past, present and future. *Proceeding of the National Academy of Sciences*, **100**: 9997-10001
- Kitching, R. L. (1971). An ecological study of water-filled tree-holes and their position in the woodland ecosystem. *Journal of Animal Ecology*, **36**: 1 - 30.
- Kramer, V. L. and Garcia, R. (1989). An analysis of factors affecting mosquito abundance in California wild rice fields. *Bulletin of the Society of Vector Ecology*, **14**: 87 - 92.
- Laird, M. (1988). *The natural history of larval mosquito habitats*. London, Academic Press.
- Lee, A. S. (2001). A comparison of *Anopheles messeae* in England and Russia. MSc Thesis. London, London School of Hygiene and Tropical Medicine.
- Lindsay, S. W. & Thomas, C. J. (2001). Global warming and risk of vivax malaria in Great Britain. *Global Change and Human Health*, **2**: 80-84.
- Lombardi, T., Fochetti, T., Bertacchi, A. & Onnis, A. (1997). Germination requirements in a population of *Typha latifolia*. *Aquatic Botany*, **56**: 1 – 10.
- McCall, P.J. & Cameron, M.M. (1995). Oviposition pheromones in insect vectors. *Parasitology Today*, **11**: 352-355.

- Macan, T. T. (1982). *The study of stoneflies, mayflies and caddis flies*. Hanworth, The Amateur Entomologists' Society.
- Miller, P. L. (1995). *Dragonflies*. Slough, The Richmond Publishing Co. Ltd.
- Mogi, M., Mori, A. and Wada, Y. (1980). Survival rates of *Culex tritaeniorhynchus* (Diptera: Culicidae) larvae in fallow rice fields before summer cultivation. *Tropical Medicine*, **22**: 47 - 59.
- Nakamura, H. (1978). Oviposition preference of *Culex pipiens molestus* and *C. tritaeniorhynchus summorosus* on the waters conditioned by the egg rafts or the larvae. *Japanese Journal of Sanitation and Zoology*, **29**:117-123.
- Nam, V. S., Yen, N. T., Kay, B.H., Marten, G.G. & Reid, J.W. (1998). Eradication of *Aedes Aegypti* from a village in Vietnam, using copepods and community participation. *The American Journal Of Tropical Medicine & Hygiene*, **59**: 657-660.
- Newman, G. (1919). Reports and papers on malaria contracted in England in 1918. Reports to the Local Government Board on Public Health and Medical Subjects New Series No **123**: 1-42.
- Packard, R. M. (1986). Agricultural development, migrant labour and the resurgence of malaria in Swaziland. *Social Science and Medicine*, **22**: 861-867.
- Pates, H. V., Takken, W., Stuke, K. and Curtis, C. F. (2001). Differential behaviour of *Anopheles gambiae sensu stricto* (Diptera: Culicidae) to human and cow odours in the laboratory. *Bulletin of Entomological Research*, **91**: 289-296.
- Proft, J., Maier, W. A. and Kampen, H. (1999). Identification of six members of the *anopheles maculipennis* complex (Diptera: Culicidae) by a polymerase chain reaction assay. *Parasitology Research*, **85**: 837-843.
- Rejmankova, E., Roberts, D., R., , Harbach, R. E., Pecor, J., Peyton, E. L., Manguin, S., Krieg, R., Polanco, J. and Legters, L. (1993). Environmental and regional determinants of anopheles (Diptera: Culicidae) larval distribution in Belize, central America. *Environmental Entomology*, **22**: 978 - 992.
- Rhoades, J. D., Kandiah, A. and Mashali, A. M. (1992). The use of saline waters for crop production. Rome, FAO - Food and Agriculture Organization of the United Nations: Report 48 pages 62.
- Savage, A. A. (1989). Adults of the British aquatic Hemiptera Heteroptera. Ambleside, Freshwater Biological Association.
- Savage, A. A. (1999). Key to the larvae of British Corixidae. Ambleside, Freshwater Biological Association.
- Service, M. W. (1970). Mosquito control in Britain. *Environmental Health*, **78**: 569-570.

- Service, M. W. (1996). *Mosquitoes (Culicidae). Medical insects and arachnids*. R. P. C. Lane, R.W. London, Chapman & Hall: 120 - 221.
- Shute, P. G. (1945). Malaria in England. *Public Health*, **58**: 62-5.
- Shute, P. G. and Maryon, M. (1974). Malaria in England past, present and future. *Journal of the Royal Society for Health*, **94**: 23-29.
- Singal, M., Shaw, P. K., Lindsay, R. C. and Roberto, R. R. (1977). An outbreak of introduced malaria in California possibly involving secondary transmission. *American Journal of Tropical Medicine & Hygiene*, **26**: 1-9.
- Singh, S. B., Dey, R. K. & Reddy, P. V. G. K. (1977). Observations on feeding of young grass carp on mosquito larvae. *Aquaculture*, **12**: 361 – 363.
- Snow, K. R. (1987). Control of mosquito nuisance in Britain. *Journal of the American Mosquito Control Association*, **3**: 271-275.
- Sokolova, M. I. & Snow, K. R. (2002). Malaria vectors in European Russia. *European Mosquito Bulletin*, **12**: 1-6.
- Sunish, I. P. and Reuben, R. (2002). Factors influencing the abundance of Japanese encephalitis vectors in rice fields in India - ii. Biotic. *Medical and Veterinary Entomology*, **16**: 1 - 9.
- Swellengrebel, N.H. & Swellengrebel-Graaf, J.M.H. (1919). Description of the Anopheline larvae of Netherland's India, so far as they are known till now. *Mededeelingen van den Burgerlijken Geneeskundigen Dienst*, **6**: 1 – 47.
- Takken, W., Geene, R., Adam, W., Jetten, T.H., van der Velden, J.A. (2002). Distribution and dynamics of larval populations of *Anopheles messeae* and *A. atroparvus* in the delta of the rivers Rhine and Meuse, The Netherlands. *Ambio*, **31**: 212 - 218.
- Thirsk, J. (1957). *English peasant farming : The agrarian history of Lincolnshire from Tudor to recent times*. London, Routledge & Kegan Paul.
- Vaile, M. M., S.J. (1980). Mosquitoes and malaria in the north Kent marshes. *Community Medicine*, **2**: 298-301.
- van Seventer, H. A. (1969). *The disappearance of malaria in the Netherlands*. Amsterdam, University of Amsterdam: 86.
- White, G. B. (1978). Systematic reappraisal of the *Anopheles maculipennis* complex. *Mosquito Systematics*, **10**: 13-44.
- Wickramasinghe, M. B. & Costa, H. H. (1986). Mosquito control with larvivorous fish. *Parasitology Today*, **2**: 228-230

## Chapter 6

### The risk of African malaria vectors arriving in the UK by aircraft.

#### Summary

##### Introduction

Increasing air traffic is causing rising concerns to the future risk of airport malaria both in Europe and globally. Here I assessed the likelihood of vector mosquitoes being imported into the UK from Africa on commercial aircraft arriving at Gatwick Airport, UK.

##### Methods

Planes were searched that had flown directly from Accra (Ghana), Nairobi (Kenya), Entebbe (Uganda), Lagos (Nigeria), Harare (Zimbabwe) and Abuja (Nigeria) and had left in the evening, when African mosquitoes are searching for a bloodmeal. 52 aircraft were searched immediately on landing during the months of June, July, August and September 2001. All sections of each plane were searched comprising of the cockpit, passenger cabin, flight attendants quarters, front and rear baggage holds.

##### Results

Three non-indigenous mosquitoes were discovered, 1 male and 2 female *Culex quinquefasciatus*. No malaria mosquitoes were found.

##### Interpretation

The low numbers of mosquitoes indicates that aircraft disinsection is being implemented and the risk of imported malaria vectors by this route is extremely low.



## Chapter 6

### The risk of African malaria vectors arriving in the UK by aircraft.



Plate 6.1 Aircraft such as this Boeing 747 are able to transport mosquitoes across continents in a few short hours.

#### Introduction

The idea that aircraft had the potential to import exotic species into new regions was given consideration as far back as the 1930's (Griffitts & Griffitts, 1931; Sinton, 1938). The consequences of importing an effective disease vector are amply demonstrated by the events which occurred in Brazil in the 1930's. *Anopheles gambiae* was introduced, probably from Senegal via a French naval vessel, and quickly spread in this favourable environment. A successful eradication programme was achieved but not before some 300,000 cases of malaria resulting in 16,000 deaths (Soper & Wilson, 1943).

Concrete evidence of the dangers of importation of mosquito vectors was seen in the wake of the Brazilian outbreak. After the successful eradication of *Anopheles gambiae* from Brazil aircraft arriving from Africa were searched. From 1941-42 seven aircraft were found to have the *An. gambiae* mosquito onboard. In India the government in the 1930's implemented disinsection of aircraft in order to prevent yellow fever from gaining a foothold in the country. Aircraft were sprayed on arrival

prior to opening the cabin doors (Sullivan, *et al.*, 1962). Under the International Health Regulations (WHO, 1983), aircraft travelling from malarious to non-malarious



Plate 6.2 Aircraft Insecticide containing d-phenothrin 2%W/W

countries should be disinfected. This procedure has been laid down by the World Health Organization (WHO, 1977) after studies carried out mostly on stationary aircraft or during pilots training flights (Sullivan *et al.*, 1962, 1979; Brook & Evans, 1971). Currently planes are sprayed by airline personnel using 100g canisters (plate 6.2), one can treats an area of 250m<sup>3</sup>, with a Boeing 747 requiring 4 cans.

Experimental studies of mosquito survival on aircraft has shown that *Culex quinquefasciatus* and *An. gambiae* are able to survive the pressurised and humidified conditions inside unsprayed aircraft cabins for at least 6 hours, in which time a plane can travel from Lagos to Gatwick, London. Further work showed that spraying at less than the WHO recommended dosage had little

effect on mosquito survival with 12.5% mortality when only 28.5% of the recommended dose was used (Curtis & White, 1984). In addition to the "blocks away" spraying of all internal areas of the aircraft except the cockpit WHO also recommends the treatment of wheel bays. This is probably not as rigorously adhered to as spraying other areas of the aircraft due to the difficulties of access to these areas. Survival of *Cx. quinquefasciatus*, the house fly *Musca domestica* and flour beetles *Tribolium confusum* within wheel bays of Boeing 747's have been studied by placing cages containing these insects into wheel bays on long haul flights. Mosquito survival averaged 84% even on flights of nearly nine hours. Although external temperatures can fall below -40 °C in flight, the non-pressurised wheel bays do not drop below +8 °C and can provide an adequate harbourage during flight (Russell, 1987).

Since this time there have been thousands of insects transported around the world. A 13 year study conducted by the US Public Health Service discovered over 20,000 insects onboard aircraft, a list which included 92 species of mosquito (Huges, 1961).

More recently there have been many cases of what is termed airport malaria occurring at European airports. Airport malaria is defined as people who contract malaria but have not been to a malaria endemic country but have been in or near an airport which receives international flights from malarious countries. Other ways of which malaria can be contracted via airports is baggage malaria, where vectors are imported in people's baggage, often transported long distances, and then transmit the disease upon escaping. Another is runway malaria, which is when passengers onboard an aircraft travelling from and to non-malarious countries stop at an endemic country but passengers stay on board. Cases of malaria have occurred due to the aircraft standing on the runway in malarious countries with its doors open (Oswald & Lawrence, 1990; Csillag, 1996). A recent study has shown that for a thirty year period, 1969 -1999 the following European countries have all had cases of airport malaria; France, Belgium, Switzerland, UK, Italy, Luxembourg, Germany, Netherlands and Spain (Gratz *et al.*, 2000).

In 1983 in the UK two cases of falciparum malaria were contracted in residents living no further than 15 km from Gatwick airport. Neither of the two patients had been to a malarious country and it is believed that an imported vector was the cause (Whitfield *et al.*, 1984). Most airport malaria in European countries occurs during the summer. Guillet *et al* (1998) reported that of 65 cases of airport malaria in Europe between 1969 and 1997 only 3 occurred in winter, all of which were baggage malaria. This clearly indicates the importance of suitable conditions for vectors on leaving the aircraft.

Figures from the Civil Aviation Authority show that the number of passengers being carried each year is increasing at around 5%. In addition people are more likely to travel to exotic locations for both business and holidays. The last decade has seen a steady rise in both European and international flights (figure 6.1).

This study conducted searches for the first time in eighteen years for mosquitoes being imported into the UK on British Airways (BA) aircraft arriving from African countries with endemic malaria. BA was selected as it is the largest carrier from Africa into Gatwick comprising of 90% of all flights. All these flights leave Africa during the evening, a time when *An. gambiae* is active. Gatwick airport was selected due to its history of airport malaria, and its rural setting which could provide exotic mosquitoes with suitable breeding sites. Searches were conducted during the summer months when temperatures would be most favourable for mosquito survival.

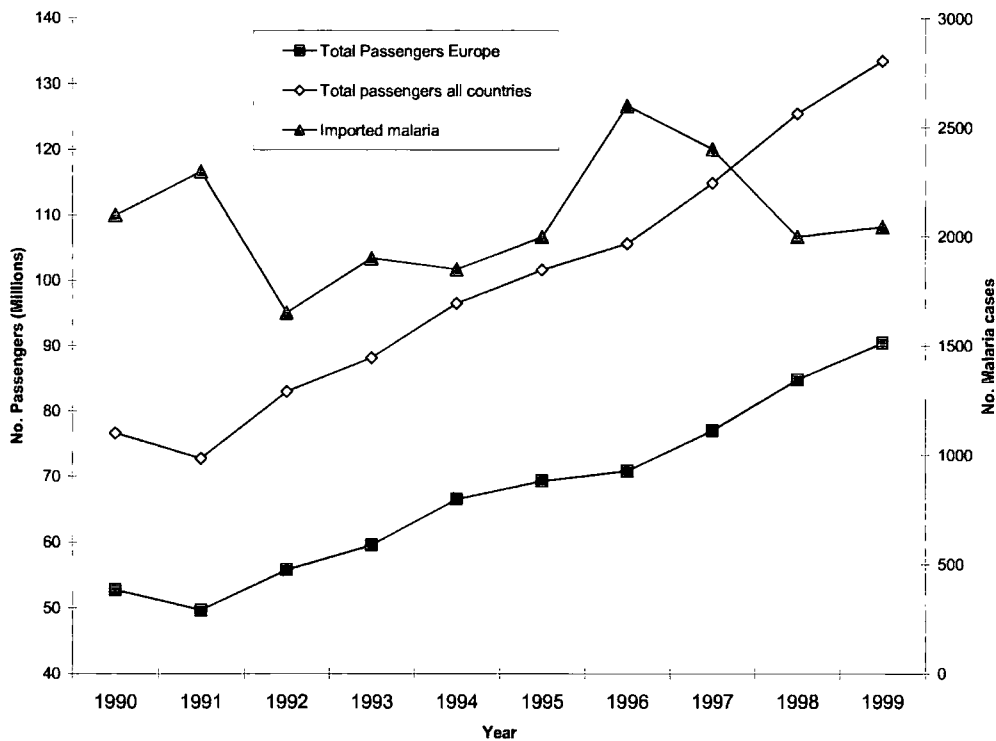

Figure 6.1 Numbers of passengers on domestic and international flights during 1990-1999, and numbers of total cases of imported malaria into the UK.

Passenger data from Civil Aviation Authority. Malaria data from Malaria Reference Laboratory, London School of Hygiene and Tropical Medicine.

**European countries** - Belgium, Switzerland, Irish Republic, Germany, Spain (excluding Canaries), Italy, France, Netherlands, Portugal (excl Madeira), Denmark, Greece, Canary Islands, Turkey, Eastern Europe. **Total countries** is all of above plus-Canada, Caribbean, United States, Middle East, Australia and Far East.

## Methods

Aircraft originating from Africa were searched immediately after landing at Gatwick airport, London. All flights landed from 05.00hrs to 07.30hrs with between three and four aircraft landing each day. Searches were undertaken for four consecutive days during the months of June, July, August and September of 2001.





Plate 6.3 Cabin searches using a torch and pooter (shown left). Searching under seats (shown right).

On landing the luggage crates containing the passengers luggage was searched as soon as it was off-loaded. Searching was conducted by unfastening the plastic sheeting on the side of the crates and visually checking the inside using a torch. As the baggage handlers work to a tight schedule only four to six crates were checked from each aircraft, the total number of luggage crates per aircraft was approximately twelve.

Once the luggage crates had been off loaded and searched the hold of the aircrafts were searched. The planes have split holds with the front section being only minimally heated to 0 °C to prevent any ice build up around the door. The rear hold can be heated to 6° C and is used to carry any livestock or perishable goods. Once all crates were removed both holds were searched using a torch and any specimens caught using a pooter. Searching a hold took approximately ten to fifteen minutes for two inspectors. All areas of the cabin were searched, including the cockpit, crew sleeping areas, under passenger seats and overhead lockers (plate 6.3). Cabin searches took approximately 15 – 20 minutes for two inspectors.

The taxonomic group, origin of flight and place where found was recorded for all samples collected. A total of 52 aircraft were searched over the entire study.

## Results

Planes were searched that had flown directly from Accra (Ghana), Nairobi (Kenya), Entebbe (Uganda), Lagos (Nigeria), Harare (Zimbabwe) and Abuja (Nigeria). The aircraft were either Boeing 747's (n = 28) or Boeing 777 (n = 24) with a passenger capacity of 416 - 524 and a cargo hold of 170.5m<sup>3</sup>.

Only three live mosquitoes were found; one male in a luggage compartment in the cabin on a flight from Lagos and two females from the holds, one on an Entebbe flight and one on a Harare flight. All mosquitoes were *Cx quinquefasciatus*. A breakdown of taxonomic groups found are shown in table 6.1. 91.6% of all samples were found in either the front or rear hold. Only one insect was caught in the baggage crates, a *Musca domestica* which is common in the UK and may have flown in whilst the crate was on the runway. Cabins only yielded two samples, a tropical hunting spider not indigenous to the UK. This spider was found on the hand of a passenger and handed to us when we boarded the plane. The other was the male mosquito already mentioned. The location of samples found on aircraft is shown in figure 6.2.

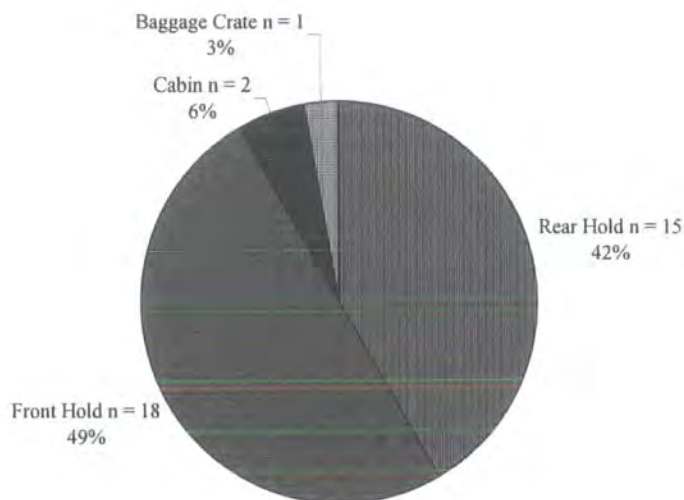

Figure 6.2 Diagram showing total numbers of invertebrates found in 52 aircraft arriving at Gatwick, London from Africa.

Table 6.1 Taxonomic groups found on aircraft arriving from six African destinations at Gatwick, London during June, July, August and September 2001.

Taxa	Lagos	Nairobi	Abuja	Accra	Entebbe	Harare	Total	% Alive
Diptera	3	2	2	2	3	1	13	100
Hymenoptera	1	2 (1)	3	0	0	0	6	16.6
Orthoptera	4 (4)	0	0	0	0	0	4	0
Coleoptera	2	2 (2)	0	0	0	0	4	50
Decapoda	1 (1)	0	0	0	0	0	1	0
Lepidoptera	0	1 (1)	0	0	0	0	1	0
Arachnid	2	0	2	0	1	0	5	100
Dictyoptera	0	1 (1)	0	0	0	0	1	0
Dermaptera	0	0	0	0	1	0	1	100
<b>Totals</b>	<b>13</b>	<b>8</b>	<b>7</b>	<b>2</b>	<b>3</b>	<b>1</b>	<b>36</b>	<b>70.6</b>

Figures in brackets show numbers collected dead. All aircraft were sprayed using d-phenothrin

## Discussion

The discovery of so few mosquitoes in this study is similar to that found by Curtis & White (1984) during their searches, also at Gatwick, in 1983. Their study found four *Cx. quinquefasciatus* after searching 67 aircraft whilst this study found three in 52 aircraft. Table 6.1 shows that Diptera are the most abundant invertebrates found on these aircraft. The presence of such a large warm object emitting substantial quantities of carbon dioxide and human host odours standing against a dark backdrop on the runway during a warm evening is likely to be extremely appealing to a number of flying insects, especially endophilic mosquitoes. The fact that diptera are the most common of imported insects is most likely due to their attraction to light and their mobility. Numerous studies conducted from the 1930's onwards have shown that mosquitoes are attracted into aircraft (Soper & Wilson, 1943; Csillag, 1996; Guillet, *et al.*, 1998; Danis, *et al.*, 1999) although there have been no direct studies as to what cues these insects are using to locate planes standing on runways.

In 1994 it was estimated that between 2000 and 5000 anophelines were imported into France during just three weeks. Within this period it was estimated that 250 to 300 aircraft arrived from malaria endemic countries, with each aircraft bringing between 8 to 20 mosquitoes. During this period there were six cases of airport malaria at Roissy-Charles de Gaulle (Giacomini, 1995). Such large numbers of imported mosquitoes demonstrates the necessity for aircraft disinsection. It also clearly demonstrates that disinsection is frequently either completely neglected or incorrectly implemented. However, in the present study the results show that if airlines follow

correct procedure on all flights arriving from malaria endemic countries then the importation of potential malaria vectors can be reduced to an almost non-existent level. BA are by far the largest carrier into Gatwick from malarious regions comprising of over 90% of flights fitting into the at risk category. That is aircraft arriving at Gatwick airport that left Africa after 18.00hrs, the time the main malaria vectors, *An. gambiae sensu lato* and *An. funestus* begin searching for a blood meal and are most likely to enter aircraft. The absence of any cases of airport malaria in the UK since two cases in 1983 in addition to finding no anopheline mosquitoes during this study is testament to the effective treatment of aircraft. It could be argued that anophelines simply do not enter aircraft but the searches at Charles-de-Gaulle (Giacomini, et al., 1995 ) show that large numbers will and do.

The presence of *Cx quinquefasciatus* in this study and others (Guillet, 1998; Pillai & Ramalingan, 1984; Curtis & White, 1984), indicate that this species with its high resistance to pyrethroids is able to travel and survive in disinfected aircraft. Although not a malaria vector it is a vector of filariasis across urban East Africa and Asia (Hamon, et al., 1967). With the growing spread of pyrethroid resistance close vigilance should be undertaken to monitor the effectiveness of disinsection using the current pyrethroid based insecticides on aircraft. What is of far greater concern is the importation of malaria parasites by travellers since currently over 2000 cases of imported malaria (figure 6.2) occur in the UK each year.

### **Conclusion**

The searches carried out over the 4 months produced only 3 mosquitoes, none of which were malaria vectors. This indicates that BA is maintaining a high standard of aircraft disinsection. In this study I found 0.06 mosquitoes per plane compared to the 8 – 20 mosquitoes per plane reported by Giacomini in his 1994 study. The presence of live mosquitoes even in these small numbers does serve to remind all in the aircraft industry that disinsection should be an integral part of travel when flying into and out of malarious areas.



## References

- Brooke, J.P. & Evans, M. (1971). Disinsection of aircraft with pressure packs containing the Pyrethroids, Resmethrin and Bioresmethrin. *Pesticide Science*, **2**: 133
- Csillag, C. (1996). Mosquitoes stow away on aircraft. *Lancet*, **348**: 880.
- Curtis, C.F. & White, G.B. (1984). *Plasmodium falciparum* transmission in England: entomological and epidemiological data relative to cases in 1983. *Journal of Tropical Medicine and Hygiene*, **87**: 101-114.
- Danis, M., Mouchet, M., Giacomini, T., Guillet, P., Legros, F. and Belkaid, M. (1999). Indigenous, introduced and airport malaria in Europe. *Médecine et Maladies Infectieuses*, **26**: 393-96.
- Giacomini, T., Mouchet, J., Mathieu, P. & Petithory, J. C. (1995). Study on six cases of malaria contracted near Roissy-Charles de Gaulle in 1994. Preventive measures necessary in airports. *Bulletin de l'Académie Nationale de Médecine*, **179** : 335-353.
- Guillet, P., Germain, M.C., Giacomini, T., Chandre, F., Akogbeto, M., Faye, O., Kone, A., Manga, L. & Mouchet, J. (1998). Origin and prevention of airport malaria in France. *Tropical Medicine and International Health*, **3**: 700-705.
- Graz, N.G., Steffen, R. & Cocksedge, W. (2000). Why aircraft disinsection? *Bulletin of the World Health Organization*, **78**: 995-1004.
- Griffitts, T.H.D. & Griffitts, J.J. (1931). Mosquitoes transported by airplanes. Staining methods used in determining their importation. *United States Public Health Service Public Health Report*, **46**: 2775-2782.
- Hamon, J., Burnett, G.F., Adam, J.P., Rickenbach, A. & Grjebine, A. (1967). *Culex pipiens fatigans* Wiedemann, *Wuchereria bancrofti* Cobbold, et le développement économique de l'Afrique tropicale. *Bulletin of the World Health Organisation*, **37**: 217-237.
- Huges, J.H. (1961). Mosquito interceptions and related problems in aerial traffic in the United States. *Mosquito News*, **21**: 93-100.
- Oswald, G. & Lawrence, E.P. (1990). Runway malaria. *Lancet*, **335**: 1537.
- Pillai, J.S. & Ramalingan, S. (1984). Recent introduction of some medically important Diptera in the Northwest, Central and South Pacific (including New Zealand). In: Laird, M. Ed. *Commerce and the spread of pests and disease vectors*. Praeger, New York. p 81-101.

- Russell, R.C. (1987). Survival of insects in the wheel bays of a Boeing 747B aircraft on flights between tropical and temperate airports. *Bulletin of the World Health Organization*, **65**: 659-662.
- Sinton, J.A. (1938). Suggestions with regard to the prevention of the spread of yellow fever to India by air traffic with special reference to insect transmission. Delhi, Government of India. *Health Bulletin No. 20 2<sup>nd</sup> Edition*.
- Soper, F.L. & Wilson, D.B. (1943). *Anopheles gambiae in Brazil 1930 to 1940*. Rockefeller Foundation. New York.
- Sullivan, W.N., Cawley, B.M., Schechter, M.S., Morgan, N.O. & Pal, R. (1979). Aircraft disinsecting: the effectiveness of freon-based and water based phenothrin and permethrin aerosols. *Bulletin of the World Health Organization*, **57**: 619
- Sullivan, W.N., Keiding, J. & Wright, J.W. (1962). Studies on aircraft disinsection at "blocks away". *Bulletin of the World Health Organization*, **27**: 263
- Whitfield, D., Curtis, C.F., White, G.B., Targett, G.A.T., Warhurst, D.C., Bradley, D.J. (1984). Two cases of falciparum malaria acquired in Britain. *British Medical Journal*, **289**: 1607-1609.
- World Health Organization. (1977). Aircraft disinsecting. *Weekly Epidemiological Record*, **52**: 377.
- World Health Organization. (1983). International Health Regulations (1969). Third annotated Edition. Geneva.

## **Chapter 7**

### **Perceived nuisance of mosquitoes on the Isle of Sheppey, Kent, UK**

#### **Summary**

##### **Introduction**

Despite the presence of 32 different species of mosquito in the UK there has been little research looking at the impact mosquitoes have on people in the country. Although work in the 1970's looked at how councils dealt with complaints by its residents, no research has asked residents themselves whether they considered mosquitoes to be a serious nuisance.

##### **Methods**

A telephone survey was performed by randomly selected residents living on the Isle of Sheppey. Respondents were asked open or closed questions about mosquitoes and their answers recorded onto a questionnaire form. The postcode of each respondent was used to find their house location, which was mapped and analysed to look for spatial clustering of people reporting a biting nuisance.

##### **Results**

A total of 92 people were interviewed, giving a compliance of 46%. 46 of the respondents (50%) complained of being bitten in their house or garden in the previous year. Most people complained of being bitten during the summer (72%), nine (41%) stated either, summer and autumn or just autumn. Most reported being bitten most frequently during the evening and night (39%), with evening only (35%) being the second most commonly reported time. 8% of people questioned had travelled to a malarious country in the previous five years.

##### **Interpretation**

Mosquitoes on Sheppey have a considerable effect on the way people behave, particularly during the summer evenings and nights. The rate of parasite introduction onto the Isle of Sheppey from people returning from malarious countries averages one every 20 years.

## Chapter 7

### Perceived nuisance of mosquitoes on the Isle of Sheppey, Kent, UK



Plate 7.1 *Ochlerotatus flavescens* biting. Photo courtesy of Dale Parker

#### Introduction

The extent to which mosquitoes are considered a nuisance in the United Kingdom (UK) is poorly described. Despite a wealth of historical literature describing malaria in the UK from the 16<sup>th</sup> to the 20<sup>th</sup> century (James 1920; Bruce-Chwatt & Zulueta 1980; Dobson 1997) there has been no systematic attempt to quantify the problem of mosquito biting. This is surprising since the UK currently has 32 indigenous mosquito species, many of which will feed readily on people. With warmer summers, the growth of outdoor activities, combined with increased public awareness about the capacity of biting insects to transmit disease, contact between people and insects is likely to increase and become more unacceptable.

In the last 30 years only three surveys into mosquito nuisance have been carried out (Service 1970; Snow 1970; Snow 1996). These studies were conducted by a postal questionnaire of local authorities throughout Britain to ascertain if a mosquito problem had been reported by residents. In 1986, 81 of 482 authorities reported complaints during the previous 25 years. In 1996 there were 10 local authorities in the UK who had implemented active mosquito control programmes in the previous year. These ranged from flushing areas with sea water, reclamation of land, and treating larval and adult sites with insecticide.

The Essex and Kent coasts have a recognised mosquito problem (Ramsdale & Snow 1995). Areas around the Thames and Medway estuaries have been the subject of long-term mosquito control efforts due in part to the insistence of local residents and the history of malaria in the area (Invest *et al.*, 1982). In 1981 at the town of Sandwich, Kent, an extremely high biting rate of 200 mosquitoes per hour was recorded and the local authority introduced mosquito control measures (Ramsdale & Snow 1995). Despite the history of mosquito nuisance there are currently no control programmes operating in either Essex or Kent. Today people are expected to protect themselves against mosquitoes.

It is difficult to predict the impact of future environmental changes on mosquitoes. Summers are expected to get warmer (Hulme & Jenkins, 1998), allowing faster development of mosquitoes and the possible establishment of exotic mosquitoes could increase the risk of disease transmission. Warmer summers would result in increased outdoor activities, increasing mosquito-people contact, and extend the number of months favourable for malaria transmission - although future outbreaks are considered

unlikely (Lindsay & Thomas, 2001). Sea level rises may make the cost of protecting low-lying coastal regions expensive. If sea defences are allowed to deteriorate there is likely to be an expansion of salt marsh, ideal breeding habitats for our indigenous malaria mosquitoes. On the other hand, predicted drier summers may reduce the extent of wetlands and reduce mosquito numbers.

Here we present the results of a telephone questionnaire survey to assess the nuisance caused by biting insects on the Isle of Sheppey, a location notorious for mosquitoes and the last place in England to experience a malaria outbreak (James, 1929).

## **Methods**

### *Questionnaire survey*

A pilot questionnaire was administered by telephone in July 2001 to 20 residents of Sittingbourne, Kent. Based on this survey a final questionnaire was constructed comprising 10 open or closed questions (table 7.1). Each respondent was asked if they suffered from mosquito bites. If they answered yes, they were asked to describe where and when they were bitten, and what measure they took against mosquitoes. Respondents were also asked if they had travelled to malarious countries in the last five years in order to assess the risk of imported malaria parasites.

A list of 2600 households on of the Isle of Sheppey was compiled from the Medway area phone directory. A total of 200 people (1 in 150 people) were selected using a sequential randomisation procedure. Every fifth person on the list was selected, starting from a number between 1 and 10 selected at random. SaTScan software (Kuldorff 1998) was used to look for spatial clustering of biting nuisance.

### *Spatial analysis*

Using geographical coordinates obtained from respondents' post codes entered into multimap ([www.multimap.com](http://www.multimap.com)) the positions of all respondents were compared to positions of positive respondents using a Bernoulli model. Positive and negative respondents were expressed as a 0/1 variable. Using a likelihood function SatScan identifies areas that constitutes the most likely cluster. This is the cluster that is least likely to have occurred by chance. The likelihood ratio for this area is noted and constitutes the maximum likelihood ratio test statistic. Its distribution under the null-hypothesis and its corresponding p-value is obtained by repeating the same analytical exercise on a large number of random replications of the data set generated under the null hypothesis, in a Monte Carlo simulation.

Table 7.1 Questionnaire used for telephone survey of Isle of Sheppey residents.

Question	Choices
Sex of respondent	
1) Does anyone in your house or garden get bitten by mosquitoes?	
2) If yes, what months of year are you bitten?	
3) Can you sit in your garden in the evening when mosquitoes are about?	
4) Do you get bitten mostly inside or outside of your house?	
5) What time of day are you most frequently bitten?	
6) Do you respond badly to mosquito bites?	
7) Do you protect yourselves against mosquitoes?	
8) If yes what?	
9) Have you travelled to a tropical country in the last 5 years?	
10) If yes, what country(s)?	



## Results

A total of 92 people agreed to be interviewed, giving a compliance of 46%. 20 (22%) of these were male and 72 were female (78%). 46 (50%) respondents complained of being bitten in their house or garden in the previous year. Thus at least 23% of the total sample considered there was a problem with biting insects. Most people complained of being bitten during the summer (72%), nine (41%) stated either, summer and autumn or just autumn. One person (2%) said winter and another said spring as the period when they were bitten most and two people (4%) said that they were bitten throughout the year. Most reported being bitten most frequently during the evening and night (39%), with evening only (35%) being the second most commonly reported time. Six people (13%) reported biting only at night and four people (9%) in the afternoon and evening only. Daytime biting was reported only twice; one person (2%) reported biting at times between 11:00-17:00hrs and another during early afternoon, 12:00-15:00hrs.

18 respondents (39%) said they were unable to sit in their garden in the evening when mosquitoes were biting and 29 (63%) people said that they were bitten mostly or entirely in their garden. 28 (61%) respondents reacted badly to mosquito bites and 27 (59%) took protective measures against being bitten (table 7.2). 56% of people using protective measures used only repellents. One person reported that they slept under a mosquito net during the summer months. Seven people who complained about being bitten had travelled to a malaria endemic country in the last five years: two to Turkey, two to Kenya and three to South Africa.

Table 7.2 Protective measures against mosquito bites (n = 27, multiple answers possible).

Method	Response	% of responses
Repellents	19	70
Close all windows	8	31
Cover up with clothes	2	7
Window or door screens	1	4
Insecticide spray	1	4
Stay indoors	1	4
Sleep under bednet	1	4

The spatial distribution of positive and negative questionnaires were analysed looking for clusters of people suffering from mosquito bites using SatScan software. No clusters were identified at the  $P < 0.05$  level.

### Discussion

Compliance of about 50% is not unusual for telephone surveys which have the disadvantage of having to be short, below ten minutes, with questions having to be simple (Groves & Bieler *et al.*, 1988). Obviously telephone surveys will exclude those households without a telephone, often low income families, and ex-directory numbers, which include a high percentage of women living alone. At least 23% of people interviewed thought that mosquitoes were a problem on the Isle of Sheppey. With a population size on the island of approximately 30,000, potentially 6,900 people may be bitten by mosquitoes on the island each year. This is likely to be an underestimate of biting nuisance for two reasons. Firstly, it makes no allowance for the influx of holiday-makers that come to Sheppey during the summer. Secondly, a proportion of the people who declined the interviews may also have considered mosquitoes a nuisance, but were unwilling to be interviewed by telephone.

The spatial distribution of people who suffer from mosquito bites, is not clustered, and is widespread across the whole island, suggesting that the mosquito problem is not limited to the edges of towns on the island. Often, people who complained about mosquitoes lived in the same street, as those people who do not complain. This may reflect the common finding that some people are more attractive to mosquitoes than others (Lindsay *et al.*, 1993), or are able sustain bites better and maybe less sensitive.

The mosquito problem on Sheppey was so bad that at least 39% of respondents were unable to sit in their garden during the summer evenings due to mosquitoes. Although people are bitten by mosquitoes all year, most biting occurs in the summer. At this time of year large numbers of *Ochlerotatus detritus*, a common nuisance mosquito in marshland are biting, whilst *Culex pipiens* s.l., *Anopheles atroparvus* and *Culiseta annulata* are most likely to be the cause of biting through the winter months (Ramsdale & Snow 1995). Trap catches of mosquitoes on the Isle of Sheppey in 2003 showed *Coquillettidia richardii* is also common and will readily feed on people.

It is likely that most people who complained about being bitten by insects were actually bitten by mosquitoes since the island is ideal for mosquitoes, with many marshland areas intersected with drainage channels that graduate from fresh to brackish water. Mosquitoes are unlikely to be confused with other biting and flying insects likely to be found on Sheppey. Horseflies generally feed in the open during the day in marsh areas, and do not normally feed close to human habitation. Stableflies will not readily bite people and are found only in close proximity to horses.

Reactions to mosquito bites vary between individuals. Usually most people suffer only slight discomfort after a mosquito has fed. However some suffer considerably after only a few mosquito bites, with symptoms including urticaria and erythema (Martinez-Molero, 1999), asthma (Gupta *et al.*, 1990) and, exceptionally, anaphylaxis (Galindo *et al.*, 1998; Hassoun *et al.*, 1999). Since mosquito biting is so common it is likely that mosquito bites on the Isle of Sheppey results in adverse reactions in a large number of people each year. This is emphasised by recent articles in the Sheppey local press and complaints made to the council that highlight the high numbers of mosquitoes on Sheppey and the nuisance they cause.

8% of people questioned had travelled to a malarious country in the previous five years. Thus around 2,400 people returned from malarious regions over a five year period, or 480 each year. Approximately 2,000 people return with malaria parasites to the UK each year and less than half of these have vivax malaria that can be transmitted by *An. atroparvus* (Behrens *et al.*, 1996). Since 9.8 million people travel to malarious countries each year, on average a person with malaria parasites will come to the Isle of Sheppey every 20 years. Thus the likelihood of locally-transmitted malaria is remote, especially since patients with malaria are likely to be sick and receive prompt medical treatment to eliminate malaria parasites. Prompt medical treatment greatly reduces the period of time that people will act as gametocyte carriers and therefore be infective to mosquitoes that may bite them. A study in Italy (Romi, *et al.*, 2001) has shown that the average time people returning with malaria take from having symptoms of malaria to receiving treatment is 8.2 days.

Our results show that those who report a mosquito problem often go to considerable lengths to avoid being bitten. In one case a person slept under a bednet during the

summer. This respondent slept in a converted attic, a favourite resting site for certain mosquitoes. However, by far the most common protective measure against mosquitoes was the use of a topical repellent. These are easy to apply and provide good protection for several hours (Curtis *et al.*, 1990). It was also common for people to close their windows at night, although this made sleeping on warm summer nights extremely uncomfortable, but was considered preferable to being bitten. It is interesting that nobody questioned had attempted to eradicate potential sources of mosquito breeding sites. For example, no one had covered a water butt or filled in a pond due to mosquitoes. Whilst most gardens ponds are not productive breeding sites for mosquitoes due to the presence of predators, water butts can produce considerable numbers of *Cx. pipiens* s.s., although these feed almost exclusively on birds (R. Hutchinson, unpublished data). Other people protected themselves by screening their homes and wearing long-sleeved clothes at night.

Although this survey covered a small area of Kent, it is likely that other places in the UK would also be subjected to mosquito nuisance. The UK has 42,251 ha of salt marsh, with the largest concentration situated along the Greater Thames Estuary in Essex and Kent (Davidson *et al.*, 1991). Mean sea-level rises of 20cm by 2030 and 65cm by 2100 are anticipated with a rise of 41cm in East Anglia by 2050s. Sea-level defences around our estuaries prevent the lowlands adapting naturally to saltwater inundation and in such places a rapid rise in sea-level is likely to result in erosion of sediment and salt marshes. On the other hand saltwater intrusion into coastal lowlands (Doody, 1990) may increase the breeding sites of *An. atroparvus* and *Oc. detritus*. Current climate change predictions indicate that parts of southern England are likely to have warmer summers and milder winters, conditions more favourable to

mosquitoes. This survey demonstrates that mosquito biting is a nuisance on the Isle of Sheppey and there is a need to determine how widespread this problem is in communities living near wetlands in the UK. This is important for the general well-being of local people and for the surveillance of mosquito-borne diseases.

## References

- Behrens, R.H., Bradley, D.J., Snow, R.W., Marsh, K. (1996). Impact of UK malaria prophylaxis policy on imported malaria. *Lancet*, **348**: 344-345.
- Bruce-Chwatt, L. & de Zulueta, J. (1980.) *The rise and fall of malaria in Europe*. London: Oxford University Press.
- Curtis, C.F., Lines, J.D., Baolin, L. Renz, A. (1990). Natural and synthetic repellents. In: C. F. Curtis (ed) *Appropriate Technology in Vector Control*. Boca Raton, Florida: CRC Press, pages 75-92.
- Davidson, N., d'A Laffoley, D., Doody J.P., Way, L.S., Gordon, J., Key, R., Pienkowski, M. W., Mitchell, R. & Duff, K.L. (1991). *Nature conservation and estuaries in Great Britain. Peterborough*. Peterborough: Nature Conservancy Council.
- Dobson, M. J. (1997). *Contours of death and disease in early modern England*. Cambridge: Cambridge University Press.
- Doody, P. (1990). Sea-level rise (coastal conservation).North Sea Report 1990. London: Marine Forum.
- Galindo, P.A., Gomez, E., Borja, J., Feo, F., Garcia, R., Lombardero, M. & Barber, D. (1998). Mosquito bite hypersensitivity. *Allergologia et Immunopathologia*, **26**: 251-4.
- Groves, R.M., Bieler, P.P. Lyberg, L.E., Massey, J.T., Nicholls, W.L., & Waksberg, J. (eds.) (1988) *Telephone Survey Methodology*. London. John Wiley and Sons.
- Gupta, S., Jain, S., Chaudhry, S. & Agarwal, M. (1990). Role of insects as inhalant allergens in bronchial asthma with special reference to the clinical characteristics of patients. *Journal of the British Society for Allergy and Clinical Immunology*, **20**: 519-524.
- Hassoun, S., Drouet. M. & Sabbah, A. (1999). Anaphylaxis caused by a mosquito: 2 case reports. *Allergologia et Immunopathologia*, **31**: 285-7.

- Hulme, M. & Jenkins, G. (1998). Climate change scenarios for the United Kingdom. Norwich, Climate Research Unit.
- Invest, J.F., Slatter, R. & Bowron, M.J. (1982). A mosquito problem on the Isle of Grain. *International Pest Control*, **3**: 80-81.
- James, S.P. (1920). *Malaria at home and abroad*. London: John Bale, Sons & Danielsson, Ltd.
- James, S.P. (1929) The disappearance of malaria from England. *Proceedings of the Royal Society of Medicine*, **23**: 71-85.
- Kuldorff, M., Rand, K., Gherman, G., Williams, G. & De Francesco, D. (1998). SatScan v 2.1: Software for the spatial and spacetime scan statistics. Bethesda, MD: National Cancer Institute Available at: <http://dcp.nci.nih.gov/bb/satscan.html>.
- Lindsay, S.W., Adiamah, J. H., Miller, J. E., Pleass, R. J. & Armstrong, J. R. M. (1993) Variation in attractiveness of human subjects to malaria mosquitoes (Diptera: culicidae) in The Gambia. *Journal of Medical Entomology*, **30**: 368-373.
- Lindsay, S.W. & Thomas, C. J. (2001). Global warming and risk of vivax malaria in Great Britain. *Global Change and Human Health*, **2**: 80-84.
- Martinez-Molero, M.I. (1999). Round Table: Urticaria caused by arthropod bites and stings (excluding Hymenoptera). *Allergologia et Immunopathologia*, **27**: 96-104.
- Ramsdale, C. D. & Snow, K.R. (1995) *Mosquito control in Britain*. London: University of East London.
- Service, M.W. (1970) Mosquito Control in Britain. *Environmental Health*, **78**: 569-570.
- Snow, K. (1996). Mosquito nuisance and control in Britain: Results of new research. *Environmental Health*, **104**: 294-297.
- Snow, W.F. (1970). The effect of a reduction in expired carbon dioxide on the relative attractiveness of human subjects to mosquitoes. *Bulletin of Entomological Research*, **60**: 43-48.

## Chapter 8

### Mosquito surveillance for vector-borne diseases in southern and central England

#### Summary

##### Introduction

Rapidly changing environments and an increase in movement of people around the globe has contributed to a rise in the number of new and re-emerging diseases. Malaria has returned to many former Soviet states and West Nile virus was seen for the first time in New York in 1999. The threat posed to the United Kingdom (UK) by such diseases is uncertain and there is a real need to understand the distribution, seasonality and behaviour of potential vectors in the country.

##### Methods

A standard surveillance trap for mosquitoes, the CDC light trap was compared to MosquitoMagnet<sup>®</sup> traps at four sites in central and southern England. A total of 16 traps were run at four sites from June to September, 2003. Collections were also compared to Mbita traps, a human-baited trap, at one site to give a comparison between human catch and mosquito trap catch

##### Results

Both CDC light traps and MosquitoMagnets<sup>®</sup> were efficient at catching mosquitoes. A total of 5,414 mosquito species were trapped, comprising of 16 species. MosquitoMagnet<sup>®</sup> traps caught 2.7 more mosquitoes than CDC light traps ( $F = 42.7$   $df 1 P < 0.001$ ). Mbita traps were run for 480 hours total and caught no mosquitoes although MosquitoMagnet<sup>®</sup> traps at the same site and time caught 67 mosquitoes.

##### Interpretation

Both CDC light traps and MosquitoMagnets<sup>®</sup> worked well in the field. However, MosquitoMagnet<sup>®</sup> traps caught 2.7 more mosquitoes and a wider range of species than CDC light traps (16 species vs 11). MosquitoMagnet<sup>®</sup> traps were run for up to 8 weeks with no maintenance in contrast to the CDC light trap which would run at most for 48 hrs without attention. MosquitoMagnets<sup>®</sup> provided ideal surveillance tools for monitoring mosquito populations in the UK.



## Chapter 8

### Mosquito surveillance for vector-borne diseases in southern and central England



Plate 8.1 MosquitoMagnet<sup>®</sup> trap used for West Nile surveillance in the UK.

#### **Introduction**

New emerging vector borne diseases have often been known for many years at their place of origin. The transportation of a disease into a new region causes it to be classified as a new emerging disease. There is nothing new about emerging diseases. Throughout the 20<sup>th</sup> century diseases have frequently been introduced into previously unaffected areas. The difference today is our greater ability to track diseases on a global scale. The increase in both speed and volume of travel now means that an emerging disease in Asia can have a direct effect on countries in Europe. New emerging diseases occur in all

countries around the globe, they have no boundaries and often find new hosts and vectors when they arrive at a new location.

The emergence and rapid spread of West Nile virus (WNV) by mosquitoes in the United States illustrates the dramatic speed at which diseases can travel from continent to continent. Beginning in 1999 WNV has spread rapidly across the USA and in 2002 4161 people were reported infected with 277 deaths (DoH, 2002). The recent finding of WNV in migrants and non-migrant birds in Dorset and Cambridgeshire gives rise to serious concern at the possibility of transmission to the human population (Buckley, *et al.*, 2003). Since the ecology of the UK is changing due to changes in land use and global climate change (Doody, 1990; DEFRA, 2001), there may be new opportunities for the virus to become established in the UK. If this occurs, it may represent an appreciable threat to the health of both people and wildlife, resulting in a considerable degree of anxiety in communities living close to mosquito-breeding sites. There are also major cost implications for the control and treatment of the disease. During the first year of the highly publicised WNV outbreak in New York, around \$3 million was spent on disease control.

WNV is a flavivirus which belongs to the Japanese encephalitis antigenic complex. The name of the virus derives from the location of its discovery in a woman in the West Nile district of Uganda in 1937 (Smithburn, *et al.*, 1940). In Europe it has caused several outbreaks of both the human and equine disease. In 1962 an outbreak occurred along the western Mediterranean and southern Russia and lasted until 1964. The first isolation of the virus in Europe was in 1963 from both patients and mosquitoes in the Rhône Delta (Hannoun, *et al.*, 1964). WNV has been subsequently isolated in Portugal, Slovakia, Moldavia, Ukraine, Hungary, Romania, Czech Republic and Italy (Filipe, 1972; Labuda, *et al.*, 1974; Chumakov, *et al.*, 1974; Vinograd & Obukhova, 1975; Molnár, *et al.*, 1975; Hubálek, *et al.*, 1998; Tsai, *et al.*, 1998). The incidence in Europe is infrequent and sporadic. Outbreaks have been seen in France, southern Russia, Spain, south-western Romania, Belarus, western Ukraine and Czech Republic since the 1960s.

There are around 43 vectors of WNV in the old world. The largest represented genus is *Culex* with 20 species and *Cx. pipiens* is the principal vector. Other important vectors in Europe include *Cx. modestus* and *Coquillettidia richardii*.

In Europe there appears to be two main transmission cycles. The first is a sylvatic cycle, in a rural environment involving mainly wetland birds and bird feeding mosquitoes. The second is a synanthropic cycle in urban environments with domestic birds and mosquitoes which bridge the gap between birds with virus and humans. This involves mainly *Cx. pipiens* s.l. Viremia in birds remains high for prolonged periods, in ducks and pigeons for over 20 days (Semenov, *et al.*, 1973). This means that migratory birds are important in the introduction of the virus into new geographical regions. A small number of mammals have been shown to harbour the virus including; the Nile Rat (*Arvicanthis niloticus*), the Yellow Necked Mouse (*Apodemus flavicollis*), the Bank Vole (*Clethrionomys glareolus*), the European Hare (*Lepus europaeus*), the Fruit Bat (*Rousettus leschenaultia*), the Lesser bush Baby (*Galago senegalensis*) and less often, camels, dogs, horses, cattle and humans (Karabatsos, 1985; Peiris & Amerasingh, 1994). Horses and Lemurs seem to be the only mammals that support viremia at levels suitable for transmission cycles. Kostyukov and co-workers have shown that the Marsh Frog, *Rana ridibunda*, is capable of maintaining a virus load at levels that will infect *Cx. pipiens* under laboratory conditions (Kostyukov, *et al.*, 1986).

Recent attempts to estimate the threat from vector-borne diseases in the UK (Lindsay & Thomas 2001; DOH, 2001), (Randolph *et al.*, 2002) has exposed serious gaps in our knowledge about what vectors are present in the country, where they occur and in what numbers they are found. This lack of fundamental data seriously compromises our ability to predict the risk of all major human and veterinary vector-borne diseases in the UK. At present range maps of insect and tick vectors largely reflect the distribution of entomologists, rather than where the vectors actually occur. Many of these are also out of date, with some nearly 100 years old. It was not until the outbreak of malaria in the

Medway estuary in Kent 1917 that the distribution maps of mosquito vectors in the UK was considered an important tool for disease monitoring. In 1918 the first map of anopheline distribution in England and Wales was produced (Lang, 1918). By 1927 a map for Scotland had been produced (Ashworth, 1927). Other than anti-malarial operations undertaken by the government the only other long term mosquito research in the UK was that established by John Marshall in 1920 at Hayling Island near Chichester. In 1998 new mosquito distribution maps were provided (Snow *et al.*, 1998). These maps were based mainly on amateur entomologists' records, rather than using any systematic sampling frame.

Recently mathematical models have been used to capture the climate envelopes of vector borne diseases or the vectors themselves and used to create distribution maps (Lindsay & Thomas, 2001; Rogers *et al.*, 2001, Rogers *et al.*, 2002). However, none of these models have been validated by field surveys of biting insects so we do not know whether these are accurate or not. There is thus an urgent strategic need to map the distribution and abundance of the most important vector species in the UK based on field surveys. This need was alluded to by the chief medical officer Sir Liam Donaldson. When discussing UK mosquitoes that could potentially transmit WNV he said, "Their relative importance to the potential of an epidemic of West Nile fever in the United Kingdom therefore remains unknown" and "to assess the distribution of different mosquito species in central and southern England. This work is vital. It will help us to assess the risk of human West Nile virus infection occurring in the United Kingdom." (DoH, 2002). Without this essential information we will still be guessing about which human or animal populations are most at threat from new and emerging vector-borne diseases. In a rapidly changing world it is imperative that we know where the threat from vector-borne diseases lies.

As the UK has many possible vectors of WNV (table 8.1) including the principal vector in Europe, *Cx. pipiens*, a program of mosquito surveillance, supported by the Department of Health, was carried out during 2002. This study was the first large scale mosquito

surveillance undertaken in the UK. It aimed to target as large a range of mosquitoes as possible to provide baseline data of mosquito diversity and activity in a range of different habitats in central and southern England.

CDC (Centre for Disease Control) light traps are the standard tool for trapping mosquitoes in the American WNV surveillance programme and have been used extensively around the world for mosquito surveillance (Miller, *et al.*, 1969; Magnarelli, 1975; Emord & Morris, 1984; Reiter *et al.*, 1986). However, these traps have not been used in the UK before as a surveillance tool for mosquitoes and need to be evaluated. In order to confirm that these traps catch mosquitoes that feed on people in the UK, the catching efficiency of two traps was compared with landing collections.

## **Methods**

### Field sites

Mosquitoes were collected from Epping Forest, Wicken Fen, Isle of Sheppey and Chadwell Heath from June to September, 2003. Epping Forest (51° 39' 00" N 000° 03' 00" E) is 2,400 ha of deciduous woodland with a rich diversity of mosquito species. Close to London, situated to the east, the forest is visited by a large number of people and has many horse stables around its borders. Wicken Fen (52° 18' 00" N 000° 18' 00" E) has over 350 ha of fresh water fenland. This site was selected due to antibody positive birds for WNV being identified in this area (Buckley, *et al.*, 2003) and it has a known species list of eleven mosquitoes. The Elmley RSPB reserve on Sheppey (51° 23' 00" N 000° 48' 00" E) at 1240 ha is the largest grazing marsh remaining in the south-east of England. The reserve is host to many species of waders including redshanks (*Tringa tetanus*) and lapwings (*Vanellus vanellus*), migrant birds include whinchats (*Saxicola rubetra*), wigeons (*Anas penelope*), pintails (*Anas acuta*), Brent geese (*Brenta bernicla hrota*) and golden plovers (*Pluvialis apricaria*), these migrants may be a source of virus in the UK.

Four suburban gardens to the east of London, Chadwell Heath (51° 35' 00" N 000° 12' 00" E) were also used.

At each site a trap monitor was employed. This person was given training on how to start and stop the traps, charge the batteries and empty the collection chambers of each trap. Daily catches from each trap were kept separate in a refrigerator. All sites were visited weekly to collect the trap catches.

Table 8.1 Some of the possible Mosquito Vectors of WNV in the UK (have been shown to transmit WNV, or are thought to have transmission potential in the UK). (Higgs, et al., 2003)

Mosquito	Currently present in UK?	Bites people?	Found with virus?
<i>Culex pipiens</i> 'typical' form	Yes - ubiquitous	Rarely (mainly birds)	Yes
<i>Culex pipiens</i> 'molestus' form	Yes	Yes	Yes
<i>Culex territans</i>	Yes	Yes – not prolifically (mainly birds and cattle)	Yes – In US
<i>Culex modestus</i>	Unlikely. Recorded in UK in 1944-45 but not since. Native to Mediterranean areas.	Yes	Yes. Main vector implied in human transmission of WNV in Europe.
<i>Aedes cinereus</i>	Yes	Yes	Yes – In US
<i>Aedes vexans</i>	Yes. Limited scattered locations in UK.	Yes	Yes. Well established vector for WNV in US.
<i>Ochlerotatus caspius</i>	Yes - limited scattered locations	Yes	Yes - in Europe.
<i>Ochlerotatus cantans</i>	Yes - widespread	Yes – not prolifically (mainly cattle)	Yes - in Europe.
<i>Coquillettidia richiardii</i>	Yes - widespread	Yes	Yes - in Europe.
<i>Anopheles maculipennis s.l.</i>	Yes. Two species of this complex in UK	Yes	Maybe Has been found in <i>An. maculipennis</i> s.s.

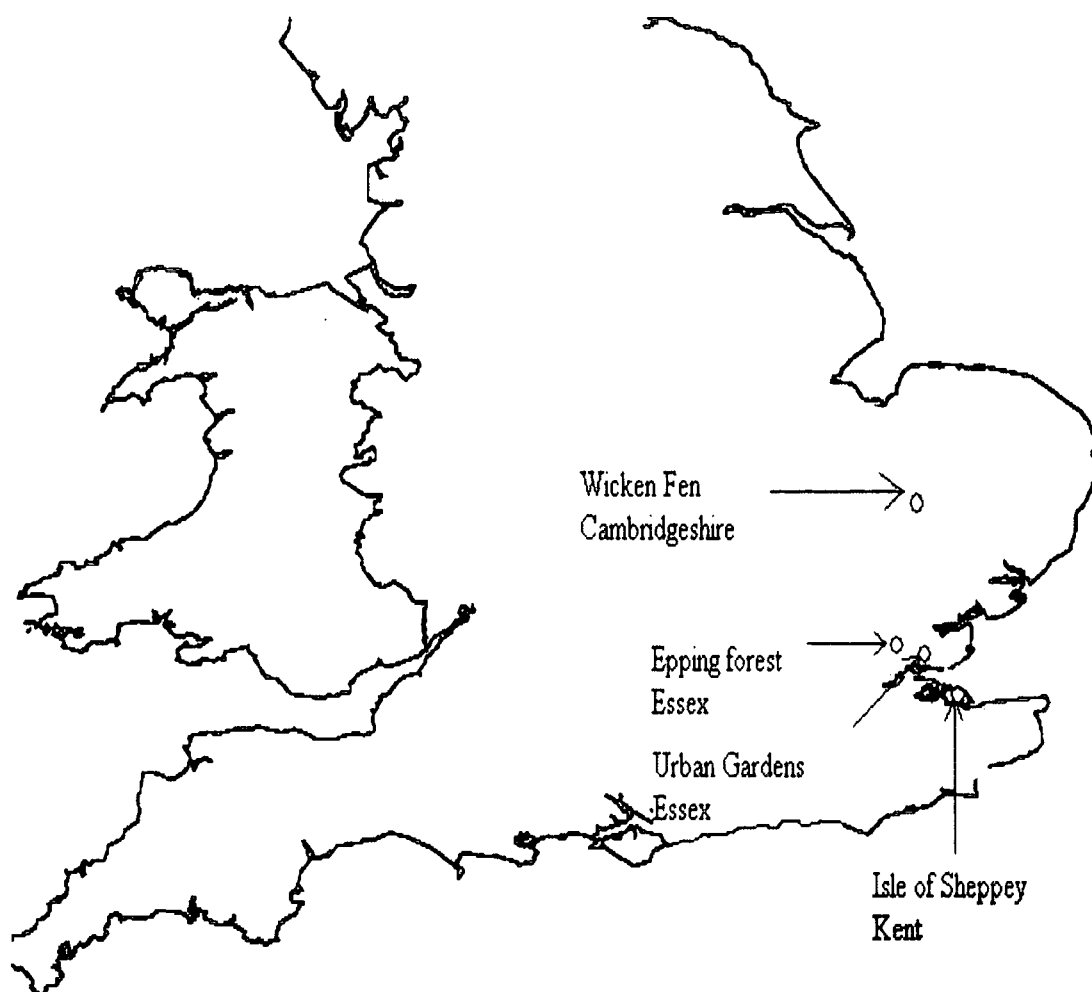

Figure 8.1 Map of England and Wales showing position of four sites used to for mosquito surveillance.

### Traps

Two carbon dioxide baited traps, CDC (Centre for Disease Control) light traps and MosquitoMagnet<sup>®</sup> traps were used for sampling mosquitoes (plate 8.1).

The trap is baited using CO<sub>2</sub> vapour from a gas cylinder. A cylinder would last four nights. In addition to the CO<sub>2</sub> a small light to attract mosquitoes is also attached at the



top of the trap (plate 8.2). The traps were powered from 6v gel batteries that need recharging every 48 hours.



Plate 8.2 CDC light trap baited with CO<sub>2</sub> with auto switching for night-time release of gas and lighting used as part of West Nile virus surveillance.

MosquitoMagnet<sup>®</sup> traps attract mosquitoes using carbon dioxide, water vapour and heat. Each trap is powered by a propane gas cylinder (23Kg). The trap converts the gas into CO<sub>2</sub> which is also heated.

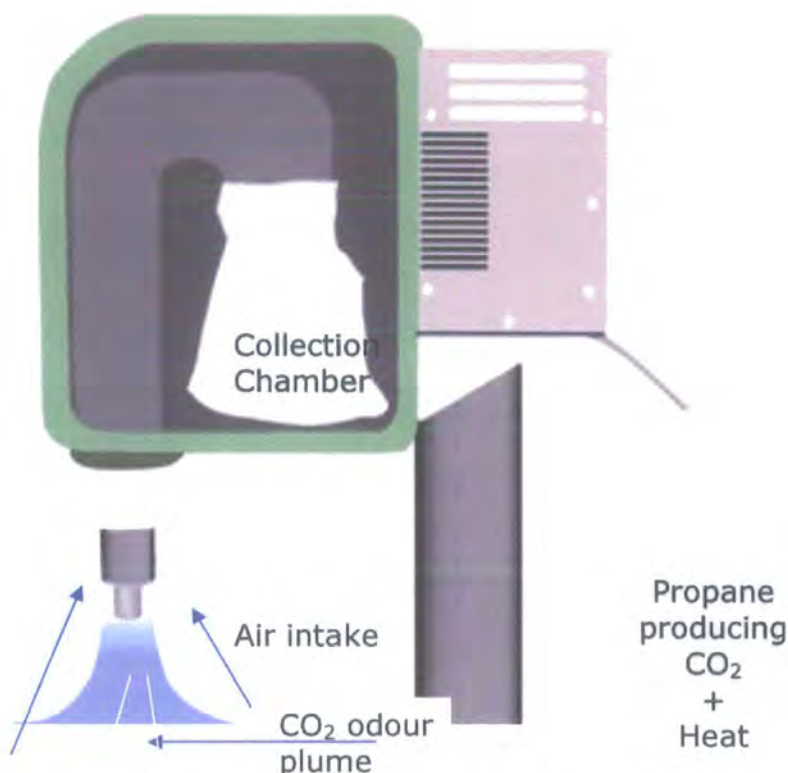

Figure 8.2 Cross section of a MosquitoMagnet<sup>®</sup> trap. Image courtesy of American Biophysics.

Both traps work on the basic principle that mosquitoes are attracted to the CO<sub>2</sub> and orientate towards the trap. Both traps have fans which create an air current sucking the mosquitoes into a holding net, escape is prevented due to the constant air current passing through the net. The MosquitoMagnet<sup>®</sup> is a counter flow trap where the air flow is bi-directional, blowing out baited heated air from a central pipe and sucking in air from a larger pipe (figure 8.2). Gas was replaced weekly for the CO<sub>2</sub> vapour used with CDC light traps and every eight weeks for propane gas used with MosquitoMagnet<sup>®</sup> traps. Gas was supplied by BOC (British Oxygen Company). Release rate for CO<sub>2</sub> was 0.5 litres/min, approximating the release rate of a calf.

Mosquitoes were collected routinely in all sites in southern and central England (Cambridge, Epping Forest, Isle of Sheppey and Chadwell Heath) from June to September 2003 (except urban sites that ran from August to October 2003) covering peak

population times for most mosquitoes. Traps were run from dusk to dawn at all sites from Monday to Thursday and emptied daily each morning. Each site was provided with a refrigerator and daily catches transferred into Petri dishes and stored. Trap catches were collected weekly, specimens transported in cool boxes and identified in the laboratory. Samples were pooled by species and month into batches of 25 and at the end of each month sent to the Health Protection Agency (HPA) for WNV screening.

### Octenol comparison

At Wicken Fen the effect of octenol on bait catch was compared by running one MosquitoMagnet<sup>®</sup> trap for two weeks without the bait, whilst the other trap used octenol (1-Octen-3-ol) as supplied by the trap manufacturer.

### Human Landing Catches

Landing catches were made from 6 young adults for 20 nights from 11<sup>th</sup> August until 5<sup>th</sup> September 2003. The collectors sat under a Mbita trap comprised of two mosquito nets: the inner one intact, the outer one had a large central hole at its top to let mosquitoes enter. Mbita traps were suspended from timber frames to form a tent-like structure under which the volunteers sat (Mathenge *et al.*, 2003). In this manner, mosquitoes could be collected routinely between the two layers of netting and the collectors were not bitten by mosquitoes. This research was conducted at the Epping Forest site from 5pm to 9pm Monday to Friday.

### Statistical analysis

All data were transformed using  $\ln(n + 1)$  to normalize the data. A full factorial model was used, with trap catch as the dependent variable and site, day and trap as factors. Main effects and interactions between factors were used in the model using SPSS software.

### Ethics

Ethical approval for this study was approved by the Ethics Advisory Committee, University of Durham.

## Results

A total of 5414 mosquitoes were collected during the study. This total comprised of 16 species, or 50% of the total species list for the UK (table 8.2). There were large differences between sites in both mosquito abundance and species diversity. Wicken Fen had the greatest diversity of mosquitoes and also provided 66% (3576/5414) of specimens.

Table 8.2 Total catch data for CDC light traps and Mosquito Magnet<sup>®</sup> traps from June – September 2003 at four sites in south-east England.

Species	Sites				Totals
	Epping	Isle of Sheppey	Wicken Fen	Urban	
<i>Cq. richiardii</i>	73	44	1170	0	1287
<i>An. claviger</i>	5	05	1215	1	1226
<i>Cs. annulata</i>	772	17	191	38	1018
<i>Oc. annulipes</i>	0	0	603	0	603
<i>Cx. pipiens</i>	25	215	120	37	397
<i>Oc. flavescens</i>	0	307	0	0	307
<i>Cx. torrentium</i>	1	211	29	2	243
<i>Cs. morsitans</i>	0	0	107	0	107
<i>An. maculipennis</i> *	4	40	60	1	105
<i>Oc. caspius</i>	0	9	49	0	58
<i>Oc. geniculatus</i>	10	0	10	0	20
<i>Oc. detritus</i>	0	14	0	0	14
<i>Oc. cantans</i>	0	0	11	0	11
<i>Oc. rusticus</i>	0	0	10	0	10
<i>An. plumbeus</i>	1	0	0	6	7
<i>Oc. puntor</i>	0	0	1	0	1

Table 8.3 Total trap catches for two trap types at four sites in South-East England.

Site	CDC	MosquitoMagnet <sup>®</sup>	Site Totals
Isle of Sheppey	499	363	862
Epping forest	39	852	891
Wicken Fen	921	2655	3576
Urban	17	68	85
Totals	1476	3938	5414

*Coquillettidia richardii* (23%) was the most abundant mosquito found in traps followed by *An. claviger* (22%). *Culiseta annulata* (19%) *Cx. pipiens* (7.3%), *Cx. torrentium* (4.5%), *Anopheles maculipennis* (1.9%) and *An. claviger* were found at all sites. In overall numbers of mosquitoes trapped the MosquitoMagnet<sup>®</sup> trap did considerably better than the CDC light trap, catching 2.7 times the amount of the CDC light traps (F = 42.7 df 1 95% C.I. 0.83 – 1.04 P < 0.001). Table 8.3 illustrates the larger trap catch of the MosquitoMagnet<sup>®</sup> compared to the CDC light trap when pooling data across all sites.

Table 8.4 Full factorial analysis of variance on Ln (n+1) catch for CDC light traps and MosquitoMagnet<sup>®</sup>.

	Outcome				
	df	SS	MM	F	P
Day	61	77.4	1.29	1.9	0.001
Site	3	117.1	39.0	58.8	0.001
Trap	1	42.5	42.53	64.0	0.001
Day × Site	141	110	0.78	2.3	0.001
Site × Trap	3	48.78	16.3	47.1	0.001
Day × Trap	61	20.48	0.34	0.97	0.5
Trap × Species	21	48.64	2.3	2.45	0.001

Table 8.4 shows that there was a significant difference between traps for overall catch and species caught. The MosquitoMagnet<sup>®</sup> caught significantly more mosquitoes at Epping Forest (t = 2.47, P < 0.03) than did CDC light traps. The MosquitoMagnet<sup>®</sup> also caught more mosquitoes at Wicken Fen and the Urban site but not significantly more. On the Isle of Sheppey the overall catch was slightly higher in CDC light traps than the MosquitoMagnet<sup>®</sup> trap.

Table 8.5 Geometric means of daily catch for all species trapped from June – September 2003.

Species	Sites							
	Epping Forest		Isle of Sheppey		Wicken Fen		Chadwell Heath <sup>†</sup>	
	Light trap	Magnet trap	Light trap	Magnet trap	Light trap	Magnet trap	Light trap	Magnet trap
<i>An. maculipennis</i>	0	1.02 (0.01-2.0)	1.2 (0.11-2.3)	1.0 (0.01-2.0)	1.0 (0.01-2.0)	1.2 (0.12-2.3)	0	1.0 (0.01-1.9)
<i>Cx. torrentium</i>	0	1.0 (0.01-2.0)	1.25 (0.1-2.4)	1.0 (0.01-1.9)	1.0 (0.03-2.2)	0	1.0 (0.01-2.0)	0
<i>Cx. pipiens</i>	1.1 (0.02-2.2)	1.07 (0.03-2.1)	1.12 (0.02-2.4)	0	1.4 (0.3-2.5)	1.0 (0.01-2.0)	1.1 (0.04-2.2)	1.2 (0.13-2.3)
<i>Cq. richiardii</i>	1.0 (0.01-2.0)	1.22 (0.1-2.3)	1.09 (0.04-2.1)	1.0 (0.01-2.0)	1.8 (0.6-3.0)	2.77 (1.6-4.0)	0	0
<i>Oc. puntor</i>	0	0	0	0	0	1.0 (0.01-2.0)	0	0
<i>Oc. cantans</i>	0	0	0	0	0	1.0 (0.01-2.0)	0	0
<i>Oc. rusticus</i>	0	0	0	0	0	1.0 (0.01-2.0)	0	0
<i>Oc. flavescens</i>	0	0	1.0 (0.01-2.0)	1.54 (0.4-2.7)	0	0	0	0
<i>Oc. detritus</i>	0	0	0	1.0 (0.01-2.0)	0	0	0	0
<i>Oc. annulipes</i>	0	0	0	0	1.25 (0.13-2.4)	2.0 (0.9-3.1)	0	0
<i>Oc. caspius</i>	0	0	0	1.0 (0.01-2.0)	1.0 (0.01-2.0)	1.17 (0.09-2.3)	0	0
<i>Oc. geniculatus</i>	1.0 (0.01-2.0)	1.02 (0.01-2.0)	0	0	0	1.0 (0.01-2.0)	0	0
<i>An. claviger</i>	1.0 (0.01-2.0)	1.02 (0.01-2.0)	1.0 (0.01-1.9)	1.0 (0.01-2.0)	1.17 (0.1-2.2)	5.12 (3.9-6.3)	0	1.0 (0.01-2.0)
<i>An. plumbeus</i>	0	1.0 (0.01-2.0)	0	0	0	0	0	1.0 (0.01-1.9)
<i>Cs. annulata</i>	2.27 (1.2-3.3)	3.56 (2.4-4.8)	1.14 (0.08-2.2)	1.0 (0.01-2.0)	1.1 (0.05-2.2)	1.7 (0.6-2.8)	0	1.3 (0.2-2.4)
<i>Cs. morsitans</i>	0	0	0	0	0	1.0 (0.01-2.0)	0	0

Figures in parenthesis 95% C.I. <sup>†</sup> Urban traps ran from August – October

CDC light traps trapped 11 species of mosquito and MosquitoMagnet<sup>®</sup> trapped 16, including all species trapped by CDC traps. Species found in MosquitoMagnet<sup>®</sup> traps only were *Oc. punctor*, *Oc. cantans*, *Oc. rusticus*, *Oc. detritus* and *An. plumbeus*.

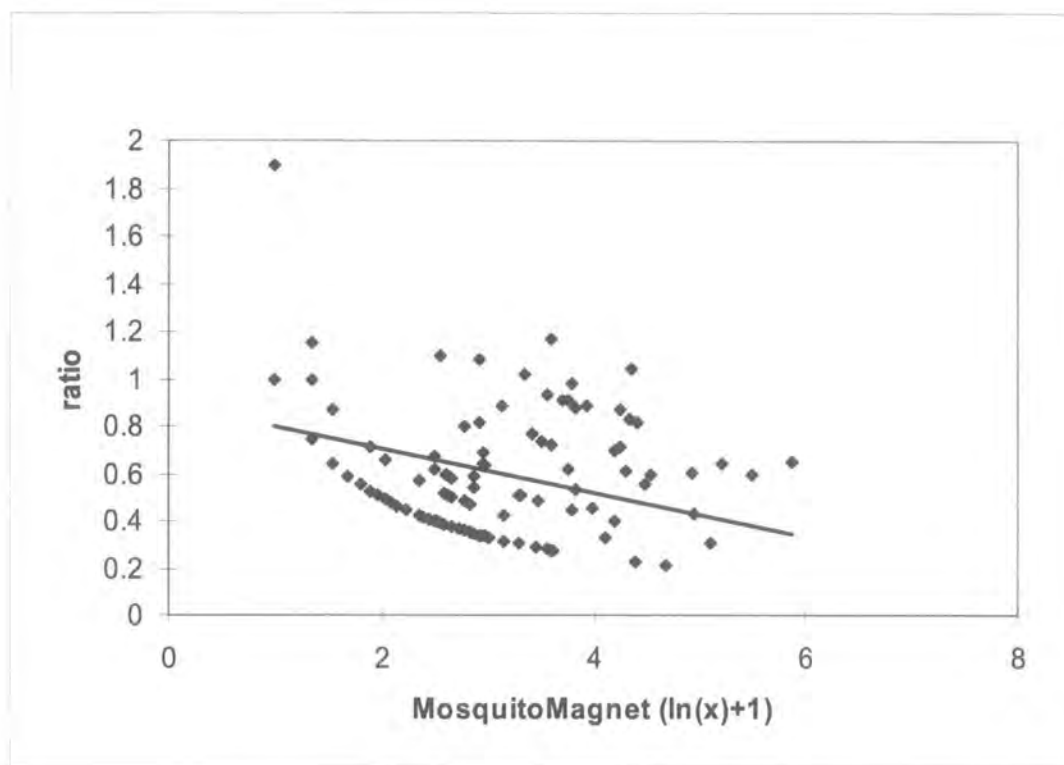

Figure 8.3 Regression of mean total catch for CDC light traps and MosquitoMagnet<sup>®</sup> traps.  $r = 0.15$   $n = 147$   $P < 0.05$ .

Simple linear regression plotting the ratio of the two traps (CDC against MosquitoMagnet<sup>®</sup>) against the catch at the MosquitoMagnet<sup>®</sup> shows a significant correlation (Fig 8.3). The slope of the regression shows the MosquitoMagnet<sup>®</sup> trap performs better than the CDC light trap ( $r^2 = 0.15$   $P < 0.05$ ), although the ratio falls indicating that the MosquitoMagnets<sup>®</sup> perform better overall but that the biggest difference is seen at the lower end of the catch spectrum where the ratio between the two traps is greatest. Mosquito collections during the trapping period (table 8.6) shows that

mosquitoes are still active until at least the end of October when the last traps were stopped.

Table 8.6 Months when mosquitoes were collected outdoors.

Species	June	July	August	September	October†
<i>Cx. pipiens</i>	5	272	60	41	20
<i>Cs. annulata</i>	199	345	337	163	8
<i>Oc. caspius</i>	7	11	35	2	
<i>An. claviger</i>	189	411	473	202	
<i>Cq. richiardii</i>	28	944	285	6	
<i>Cs. morsitans</i>	4	22	50	30	
<i>An. maculipennis</i>	9	46	40	12	
<i>Oc. annulipes</i>	383	189	4		
<i>Oc. geniculatus</i>	15	2	2		
<i>An. plumbeus</i>			4	2	
<i>Oc. cantans</i>	9	2			
<i>Oc. rusticus</i>	7	3			
<i>Oc. flavescens</i>	285	21			
<i>Oc. detritus</i>	14				
<i>Cx. torrentium</i>	195	48			
<i>Oc. puntor</i>			1		

† October results are for urban site only. June – July exclude urban site

#### Octenol comparison

There was borderline difference in the number of mosquitoes collected in the octenol-baited trap compared with the non-baited trap ( $t = 2.346$ ,  $df 6$ ,  $P = 0.057$ ). The non-octenol baited trap caught 5.5 (95% C.I. 5.38 - 5.68) compared to 8.4 (95% C.I. 8.14 – 8.58) at the baited trap. The two traps caught exactly the same species, indicating that



octenol did not have any repellent effect for those species trapped during the two week period. The species number over the period of the comparison was six, *An. maculipennis*, *Cq. richiardii*, *Oc. caspius*, *An. claviger*, *Cs. annulata* and *Cs. morsitans*.

### Human Landing Catches

No mosquitoes were collected from the 6 baited Mbita traps over 20 nights. Trap catches at the baited CDC light traps and MosquitoMagnet<sup>®</sup> were also low over the same period with only 67 *Cs. annulata* being trapped during the same period.

### **Discussion**

There are 32 different species of mosquito in the UK, yet although many are potential disease vectors very little is known about their basic ecology. *Cx. pipiens* s.l. is the most likely vector of West Nile virus due to its bird feeding habit. With migratory birds bringing in the virus and a large *Cx. pipiens* population in the UK this species has to be the most likely candidate. It is further complicated by the two forms of the species. One is said to feed almost exclusively on birds whilst the other, the molestus form, is more anthropophilic living in a more urban environment. *Cq. richardii* can be very abundant in certain localities, it a known vector of WNV and will readily bite people (Higgs, *et al.*, 2004). It was very common at Wicken Fen as the larvae stages need plenty of aquatic plants with anchored stems which they attach to. *An. atroparvus* may act as a suitable vector although they have a preference for feeding on livestock rather than humans. *Oc. cantans* and *Oc. caspius* are known vectors of WNV (Higgs, *et al.*, 2004) and were found during this survey, albeit at low numbers.

Both traps seemed to work well and there were few significant differences between the two traps. Trap comparison was not a priority for this research as it was fundamentally a mosquito surveillance study. Because of this and the difficulties in logistics of running 16 traps at four sites there was no experimental design to compare the effects of location within each site and data analysis showed that there were clear differences between trap

sites within each location. This is of no surprise as most research using traps show an effect of site on trap number (Lines, *et al.*, 1991; Gunasekaran, *et al.*, 1994; Kline & Lemire 1995). Trap catches of mosquitoes in Florida using Magnet traps varied from 100 – 1000 mosquitoes a night depending on trap placement (Taverne, 2001). Trap catches also varied from day to day which reflects both the change in seasonal abundance of mosquitoes and local weather conditions affecting catches. Both types of traps are suitable for different environments. Magnet traps should be placed in an open environment away from buildings and vegetation that would disrupt the odour plume. Magnet traps are much larger than CDC light traps and therefore cannot be placed as easily as the lighter more mobile CDC traps. All CDC light traps were hung from trees and thus would be more likely to attract mosquitoes such as *Cx. pipiens*, which they did. *Cx. pipiens* feed predominantly on birds in the tree canopy (Marshall, 1938). Whilst Wicken Fen is a particularly rich site for mosquitoes, people who visit the Fen rarely complain about being bitten during the day. The traps used here were run from dusk to dawn when most people have left the reserve, which would explain the high numbers of mosquitoes, but low number of complaints. In terms of mosquito-human contact it is the urban environment which is of most interest. The WNV outbreak in New York occurred within a large city, not on a nature reserve or within a national park. The study conducted here used three such sites out of the four because this research was interested in maximizing the number of mosquitoes trapped so they could be tested for the presence of WNV. However, the fourth urban site was used, although somewhat later than the other three sites, to look at the number and species of mosquito encountered in a typical London garden. What is important here, at these urban sites is that *Cx. pipiens* was a common mosquito with 1-2 being caught on some nights.

The effectiveness of using traps over visual collections made by people is well demonstrated by the example of *Oc. flavescens* on the Isle of Sheppey. By the time traps were running on Sheppey I had carried out three years of collecting mosquitoes on the Island. This work included extensive searches of resting sites and the collection of mosquito larvae from sites. At no time during these studies did I encounter any adult or

larvae of *Oc. flavescens*, yet several hundred were trapped in the Magnet traps throughout June and July.

The use of octenol with Magnet traps appears to have a beneficial result on trap catch although this result was marginal and would need to be repeated over a longer period of time.

Magnet traps would be selected over CDC light traps for use in the UK as a monitoring tool for mosquitoes. They trap a wider number of species (16 vs 11) and caught more specimens than did the light traps (3938 vs 1476). Magnet traps are also more robust in construction, being able to take rough handling and transporting and they are more reliable in the field. They also require no power source, as all power is derived from the propane gas, and the collection bag is contained within a waterproof housing, preventing the catch from becoming wet and difficult to identify, which was often the case with the CDC light traps. They can run continuously for eight weeks off one bottle of propane. The biggest draw back of Magnet traps is the cost of the unit. It is possible to purchase three or four CDC light traps, and the necessary regulators, batteries and chargers for the same price as one magnet trap.

Baited traps work very well in the UK, trapping a wide range of mosquitoes, many of which are potential vector species. Magnet traps would be used preferentially over CDC light traps as they catch more mosquitoes.

#### Acknowledgements

This work was funded by the Department of Health. Also co-operation at each site was essential in order for this surveillance to be successful. We would like to thank Adrian Colston (Wicken Fen), Alan Johnston (Elmley RSPB, Isle of Sheppey), Jeremy Dagley (Epping Forest) and Steven Cox (Urban sites) for their permission and help in running traps.

#### References

- Ahmad, K. (2003). No funds to control meningitis outbreak in Africa. *The Lancet Infectious Diseases*, **3**: 119.
- Buckley, A., Dawson, A., Moss, S.R., Hinsley, S.A., Bellamy, P.E. & Gould, E. A. (2003). Serological evidence of West Nile virus, Usutu virus and Sindbis virus infection of birds in the UK. *The Journal of General Virology*, **84**: 2807-2817.
- Chumakov, M.P., Bashkirtsev, V.N., Golger, E.I., Dzagurova, T.K., Zavodova, T.I. & Kononov, Y.N. (1974). Isolation and identification of Crimean hemorrhagic fever and West Nile virus from ticks collected in Moldavia (in Russia). *Medicinskaya Virusologia*, **22**: 45-49.
- DEFRA (2001). High level target 9 biodiversity. Department of the Environment And Rural Affairs: 8. London.
- Department of Health. (2002) West Nile virus reborn in the USA. Health Check: Chief Medical Examiners Annual Report DoH, p 27 – 33.
- Doddy, P. (1990). Sea-level rise (coastal conservation). North Sea Report 1990. Marine Forum, London.
- Emord, D.E. and C.D. Morris. (1982). A host-baited CDC trap. *Mosquito News*, **42**:220-224.
- Filipe, A.R. (1972). Isolation in Portugal of West Nile virus from *Anopheles maculipennis* mosquitoes. *Acta Virology*, **16**: 208-211.
- Gunasekaran, K., Jambulingam, P., Sadanandane, C., Sahu, S. S. and Das, P. K. (1994). Reliability of light trap sampling for *Anopheles fluviatilis*, a vector of malaria. *Acta Tropica*, **58**: 1-11.
- Hannoun, C., Panthier, R., Mouchet, J. & Eouzan, J.P. (1964). Isolement en France du virus West Nile à partir de malades et du vecteur *Culex molestus*. *Ficalbi Compte Rendu de l'Académie des Sciences*, **D259**, 4170-4172.
- Hardy, I.R.B., Sutter, R.W. & Dittman, S. (1996). Current situation and control strategies for resurgence of diphtheria in newly independent states of the former Soviet Union. *The Lancet*, **347**: 1739-1744.
- Higgs, S., Snow, K. & Gould, E.A. (2004). The potential for West Nile virus to establish outside of its natural range: a consideration of potential mosquito vectors in the United Kingdom. *Transactions of the Royal Society of Tropical Medicine and Hygiene*, **98**: 82-87.

- Hubálek, Z., Halouzka, J., Juricová, Z. & Šebesta, O. (1998). First isolation of mosquito borne West Nile virus in the Czech Republic. *Acta Virology*, **42**: 119-120.
- Hurlbut, H.S. (1956). West Nile virus infection in arthropods. *American Journal of Tropical Medicine and Hygiene*, **5**: 76-85.
- Karabatsos, N. (1985). *International catalogue of arboviruses, including certain other viruses of vertebrates*. 3<sup>rd</sup> Edition. American Society of Tropical Medicine and Hygiene, San Antonio.
- Kay, B. A. & Mintz, E.D. (1992). Cholera in the Americas: Crisis and catalyst. *Clinical Microbiology Newsletter*, **14**: 156-158.
- Kerr, C. (2001). Meningitis hits West Africa. *Trends in Microbiology*, **9**: 203.
- Kistemann, T., Munzinger, A. & Dangendorf, F. (2002). Spatial patterns of tuberculosis incidence in Cologne (Germany). *Social Science & Medicine*, **55**: 7-19.
- Kline, D. L. & Lemire, G. F. (1995). Field evaluation of heat as an added attractant to traps baited with carbon dioxide and octenol for *Aedes taeniorhynchus*. *Journal of the American Mosquito Control Association*, **11**: 454-6.
- Kostyukov, M.A., Alekseev, A.N., Bulychev, V.P. & Gordeeva, Z.E. (1986). Experimental infection of *Culex pipiens* mosquitoes with West Nile virus by feeding on infected *Rana ridibunda* frogs and its subsequent transmission. *Medical Parasitology*, **6**: 76-78.
- Kumate, J., Sepúlveda, J. & Gutiérrez, G. (1998). Cholera epidemiology in Latin America and perspectives for eradication. *Bulletin de l'Institut Pasteur*, **96**:217-226.
- Labuda, M., Kozuch, O. & Grešiková, M. (1974). Isolation of West Nile virus from *Aedes cantans* mosquitoes in west Slovakia. *Acta Virology*, **18**: 429-433.
- Lindsay, S. W. & Thomas, C. J. (2001). Global warming and risk of vivax malaria in Great Britain. *Global Change and Human Health*, **2**: 80-84.
- Lines, J. D., Curtis, C. F., Wilkes, T. J. and Njunwa, K. J. (1991). Monitoring human-biting mosquitoes (Diptera: Culicidae) in Tanzania with light traps hung beside mosquito nets. *Bulletin of Entomological Research*, **81**: 77-84.
- Mathenge, E.M., Killeen, G. F., Oulo, D. O., Irungu, L., Ndegwa, W. P. N., & Knols, B. G. J. (2002). Development of an exposure-free bednet trap for sampling Afrotropical malaria vectors. *Medical and Veterinary Entomology*, **16**: 67-74.
- Marshall, J. F. (1938). *The British Mosquitoes*. London, The British Museum.

- Magnarelli, L. A. (1975). Relative abundance and parity of mosquitoes collected in dry-ice baited and unbaited CDC miniature light traps. *Mosquito News*, **35**:350-353.
- Miller, T. A., R. G. Stryker, R. N. Wilkinson and S. Esah. (1969). Notes on the use of CO<sub>2</sub> baited CDC miniature light traps for mosquito surveillance in Thailand. *Mosquito News*, **29**:688-689.
- Morbidity Mortality Weekly Report (2003). West Nile virus activity--United States, November 13-19, 2003, MMWR, **52**: 1132.
- Molnár, E., Gulyas, M.S., Kubinyi, L., Nosek, J., Kozuch, O. & Ernek, E. (1976). Studies on the occurrence of tick-borne encephalitis in Hungary. *Acta Veterinaria Academiae Scientiarum Hungaricae*, **26**: 419-438.
- Monath, T.P. (2001). Yellow fever: an update. *The Lancet Infectious Diseases*, **1**: 11-20.
- Mostashari, F., Kuldorff, M., Hartman, J., Miller, J. & Kulasekera, V. (2003). Dead bird clusters as an early warning system for West Nile virus activity, *Emerging Infectious Diseases*, **9**: 641-646.
- Mutebi, J.P. & Barrett, D.T. (2002). The epidemiology of yellow fever in Africa. *Microbes and Infection*, **4**: 1459-1468.
- Parola, P & Raoult, D. (2001). Tick-borne bacterial diseases emerging in Europe. *Clinical Microbiological Infection*, **7**: 80-83.
- Peiris J.S.M., Amerasingh, F.P. (1994). *West Nile fever*. In: Beran, G.W. Steele, J.H. Eds. Handbook of Zoonoses Section B: Viral 2<sup>nd</sup> ed. CRC Press, Boca Raton.
- Randolph, S. (2002). Tick-borne encephalitis, *Environnement, Risques et Sante*, **1**: S70-S73
- Randolph, S.E., Chemini, C., Furnanello, C., Genchi, C., Hails, R.S., Hudson, P.J., Jones, L.D., Medley, G., Norman, R.A., Rizzoli, A.P., Smith, G. & Woolhouse, M.E.J. (2002). The ecology of tick-borne infections in wildlife reservoirs. In *The Ecology of Wildlife Diseases* (ed. P.J. Hudson, A.P. Rizzoli, B.T. Grenfell, J.A.P. Heesterbeek & A.P. Dobson), ch. 7, pp 119-138. OUP.
- Raviglione, M.C., Dye, C., Schmidt, S. & Kochi, A., (1997). Assessment of worldwide tuberculosis control. *The Lancet*, **350**: 624-629.

- Reiter, P., W.L. Jakob, D.B. Francy & J.B. Mullenix. 1986. Evaluation of the CDC gravid trap for the surveillance of St. Louis encephalitis vectors in Memphis, Tennessee. *Journal of the American Mosquito Control Association*, **2**:209-211.
- Rich, V. (1991). Soviet Union: Diphtheria tightens its grip. *The Lancet*, **338**: 1004.
- Rieder, H.L., Zellweger, J.P., Raviglione, M.C., Keizer, S.T. & Migliori, G.B. (1994). Tuberculosis control in Europe and international migration. *European Respiratory Journal*, **7**: 1545–1553.
- Rogers, D. J., Randolph, S.E., Lindsay, S.W. & Thomas, C.J. (2001). Vector-borne diseases and climate change. In *Health Effects of Climate Change in the UK* (ed. R. Maynard). pp. 101-138. Institute for Environment and Health (Leicester), for Department of Health, UK.
- Rogers, D.J., Randolph, S.E., Snow, R.W. & Hay, S.I. (2002). Satellite imagery in the study and forecast of malaria. *Nature*, **415**: 710-715.
- Semenov, B.F., Chunikhin, S.P. Karmysheva, V.Y. & Yakovleva, N.I. (1973). Studies of chronic arbovirus infections in birds. 1. Experiments with West Nile, Sindbis, Bhanja and SFS viruses. *Vestnik Akademii Mediciskikh Nauk SSSR*, **2**: 79-83.
- Smithburn, K.C., Hughes, T.P., Burke, A.W. & Paul, J.H. (1940). A neurotropic virus isolated from the blood of a native of Uganda. *American Journal of Tropical Medicine & Hygiene*, **20**:471-492.
- Snow, K.R., Rees, A.T. & Bulbeck, S.J. (1998) *A provisional atlas of the mosquitoes of Britain*. University of East London Press.
- Solomon, T. & Mallewa, M. (2001). Dengue and other emerging flaviviruses. *Journal of Infection*, **42**: 104-115.
- Taverne, J. (2001). Magnetic Mosquitoes on the net. *Trends in Parasitology*, **17**: 601-602.
- Tsai, T.F., Popovici, F., Cernescu, C., Campbell, G.L. & Nedelcu, N.I. (1998). West Nile encephalitis epidemic in south-eastern Romania, *The Lancet*, **352**: 767-771.
- United Nations. (1999). Will it reach on time? Emerging and re-emerging infectious diseases. *United Nations Chronicle*, **36**: 1.
- United Nations AIDS (2002). Report on the global HIV/AIDS epidemic. <http://www.unaids.org> (accessed Jan, 2004).

- Vinograd, I.A. & Obukhova, V.R. (1975). Isolation of arboviruses from birds in western Ukraine (in Russia). *Sbornik Trudov Instituta Virusologi*, **3**: 84-87.
- Watts, S. (1997). *Epidemics and history, disease power and imperialism*. Yale University Press, New Haven.
- Wheeler, A. (2002). A comparative Study of Three Commercially Available Mosquito Traps for Monitoring Mosquito Populations. Cayman Islands Mosquito Research & Control Unit Report. Available online:  
[http://www.mosquitobait.com/files/test\\_cayman\\_islands.pdf](http://www.mosquitobait.com/files/test_cayman_islands.pdf)
- Zalesky, R., Leimans, J. & Pavlovska, I., (1997). The epidemiology of tuberculosis in Latvia. *Monaldi Archive of Chest Disorders*, **52**: 142–146.



## Chapter 9

### Conclusions

Malaria was endemic in the UK, particularly the South-East of England, for several centuries (Dobson, 1994; 1997). It probably arrived in the country with the Romans around 43 AD (Boyd, 1949) and was endemic at low levels until the 20<sup>th</sup> century. The major decline in malaria in the coastal parishes began around the 1840s, with the last major outbreak of malaria occurring in 1917/18. In this epidemic over 330 people were infected with vivax malaria on the Isle of Sheppey, the main field site used during this study (James, 1929). There were two main reasons for the decline in malaria in the marshes. Firstly, drainage of the saltmarshes would have substantially reduced the breeding habitat required for *Anopheles atroparvus*, the primary vector. Secondly, house construction changed, from large single roomed dwellings housing livestock and farmers together, to partitioned houses with closed ceilings and attic space, with better fitting doors and windows. This improved housing would have removed the vector from its previous close association with people.

It has been argued that during the 16<sup>th</sup> to 19<sup>th</sup> centuries, malaria in the saltmarshes resulted in increased mortality in these communities, compared with inland ones (Dobson, 1994;1997). In this thesis I suggest that the increase in mortality was not due to malaria, but due largely to diarrhoeal diseases. The most important factor for the reduced mortality seen in Sheppey is improved sanitary conditions, particularly those associated with the provision of clean drinking water.

Anecdotal evidence suggests that water quality was poor in marshland communities compared with those inland, where clean spring water was often used as drinking water. Childhood mortality in the coastal marshes peaked during August and September, unlike inland parishes, and these peaks coincided with peaks in diarrhoea, that are even seen today. Moreover, this peak was still pronounced at the end of the 19<sup>th</sup> century, when malaria had virtually disappeared from the UK, suggesting that diarrhoea was indeed the major childhood killer, not malaria. Vivax malaria kills few

people anywhere in the world today or in the past, which is why vivax malaria is commonly known as benign malaria. Increased mortality in the marshes is most likely due to a plethora of waterborne diseases, including typhoid fever, enteric fever and diarrhoea caused by the bacteria *Salmonella typhi*, *Shigella sonnei*, *Campylobacter jejuni* and *Escherichia coli* and rotaviruses, in common with many deprived communities today. To attribute high mortality through the ages to a benign infection seems fanciful. *Plasmodium vivax* may in a few cases have contributed to an increased mortality in children with life-threatening infections, like acute respiratory infections or diarrhoeal diseases, but its absence would not have miraculously made saltwater marshes a healthier place to live.

Even today on the Isle of Sheppey mosquitoes still have an impact on every day life for a number of people. Speaking to residents on Sheppey and asking them about mosquitoes gave some enlightening insights into both peoples' perception of these insects and the effect they can have on everyday behaviour. Half of the people who answered a telephone questionnaire had been bitten by mosquitoes, and 70% of these respondent had used repellents. There was even one person who used a bednet during the summer to avoid being bitten. Although this survey covered a small area of Kent, it is likely that other places in the UK would also be subjected to similar mosquito nuisance. The UK has 42,251 ha of salt marsh, with the largest concentration situated along the Greater Thames Estuary in Essex and Kent (Davidson *et al.*, 1991). Mean sea-level rises of 20cm by 2030 and 65cm by 2100 are anticipated with a rise of 41cm in East Anglia by 2050s. Sea-level defences around our estuaries prevent the lowlands adapting naturally to saltwater inundation and in such places a rapid rise in sea-level is likely to result in erosion of sediment and salt marshes. On the other hand saltwater intrusion into coastal lowlands may increase the breeding sites of *An. atroparvus* and *Ochlerotatus detritus*. Current climate change predictions indicate that parts of southern England are likely to have warmer summers and milder winters, (Doody, 1990) conditions more favourable to mosquitoes. This survey demonstrates that mosquito biting is a major nuisance on the Isle of Sheppey and there is a need to determine how widespread this problem is in communities living near wetlands in the UK. This is important for the general well-being of local people and for the surveillance of mosquito-borne diseases.

Today's health concerns with vector borne disease is often associated with increased travel and the faster speed with which diseases are transported around the world. In the UK there has been an inexorable rise in *P. falciparum* cases. In the last 10 years there have been 81 deaths, 95% of these due to *P. falciparum* malaria. In 1999 there were 2,045 cases of imported malaria of which 73.5% were *P. falciparum* and 18.3% *P. vivax*. In this same year there were 14 deaths (Guillet *et al.*, 1998; Gratz *et al.*, 2000). Whilst the number of imported *P. falciparum* cases is increasing, those of vivax malaria remain fairly constant. Increasing air traffic is also causing concern about the threat posed by the introduction of vectors to airports in Europe and elsewhere. Searches of 52 aircraft arriving at Gatwick Airport from Africa, belonging to the largest carrier with daily flights into the UK, found few mosquitoes indicating that aircraft disinsection is successful.

Rapidly changing environments and increased movement of people around the globe has increased the risk of new and re-emerging diseases occurring. Malaria has returned to many former Soviet states and West Nile virus (WNV) was seen for the first time in New York in 1999. The threat posed to the United Kingdom (UK) by such diseases is uncertain and there is a real need to understand the distribution, seasonality and behaviour of potential vectors in this country. Since the work of James in 1929, there has been scant research on the medical importance of UK mosquitoes. This is perhaps not surprising since the UK is seen primarily as a country free from human vector borne diseases. However although the risk of vector-borne diseases in the past has been low, there is no guarantee that this will remain so in the future. The newest vector borne disease to attract the attention of governments, health agencies and scientists alike is WNV. Although found in many European countries the UK has always been considered free from WNV, although this may not be the case since the recent discovery of migrant and indigenous birds in the UK that were antibody positive for WNV, indicating that bird to bird transmission by English mosquitoes may be happening (Buckley, *et al.*, 2003).

Due in part to the discovery of these antibody-positive birds and the current outbreak that is still sweeping across the United States (DoH, 2002) a surveillance program was established in the UK. Using a standard surveillance trap for mosquitoes, the CDC light trap was compared to MosquitoMagnet<sup>®</sup> traps at four sites in central and

southern England. Running 16 traps at four sites showed that the UK has a large diverse population of mosquitoes. Particular species such as *Culex pipiens* s.l. and *Culiseta annulata* are widespread existing in markedly different habitats, from freshwater fenland to urban gardens. The MosquitoMagnet<sup>®</sup> trap caught 2.7 × more mosquitoes and 5 × more species than the light traps. Unfortunately I was unable to show that the collections from magnet traps were similar to those attracted to human baits. Mbita traps (Mathenge *et al.*, 2003) baited with human volunteers failed to trap any mosquitoes over a 20 night period, although low numbers were caught in MosquitoMagnet<sup>®</sup> traps over the same period. MosquitoMagnet<sup>®</sup> traps were run for up to 8 weeks with no maintenance in contrast to the CDC light traps which would run at most for 48 hrs without attention. MosquitoMagnets<sup>®</sup> provided ideal surveillance tools for monitoring mosquito populations in the UK.

Field studies were carried out to determine whether *An. atroparvus*, the English malaria vector, remained a threat to public health. This mosquito was extremely localised in its distribution and found in small numbers. Females rested within mainly derelict buildings at sites that did not drop below freezing during winter and had entrances at or close to ground level. Males did not over winter and only nulliparous females with gonoactive ovaries at Christophers Stage II survive the duration of the winter. *An atroparvus* are extremely endophilic. The mechanism for selecting sites that do not freeze during winter is uncertain. It may be as simple as the presence of con-specifics or the presence of some aggregation pheromone. Field work on Sheppey failed to catch any mosquitoes outside of their resting sites, including attempts using human landing catches and CO<sub>2</sub> -baited traps. Traps placed outside of resting sites trapped no mosquitoes whilst when placed inside, 118 were trapped within two hours. Blood feeding on horses and cattle form the majority of blood meals taken by these mosquitoes (60%), whilst only 2% of blood meals were taken from people. This clearly demonstrates that the chances of being bitten by this malaria vector are virtually zero. Suitable over-wintering sites are very limited with only five being found across the whole of Sheppey. As these sites are important in keeping fertile females alive to produce the following year's population the number of sites will have a limiting effect on population numbers.

Equally specialised and limiting are the larval sites. *An. atroparvus* larvae were found only in small surface pools on top of thick algal mats comprised mainly of *Enteromorpha* spp. Here it is 4 °C warmer, pH is 9.0 i.e. 1.8 higher than negative sites, and salinity is lower (2.2mg/L) compared to sites without larvae (3.4mg/L). On these algal mats there are fewer predators and these pools may trap pollen and seeds from bank side plants providing a rich food resource for the aquatic stages of this mosquito. Warm water pools in floating islands of algae provide ideal nurseries for maximising the production of *An. atroparvus*. This highly specialised breeding habitat allows the aquatic stages to develop faster, with less predation and may lead to larger adults than other sites. As with many animals that become extremely specialised they are prone to loss of habitat and the reduction of such larval sites. Such sites are not common and ditch maintenance often means that suitable sites are destroyed by the removal of aquatic plants. Due to the limits placed on population size, their endophilic behaviour and low human biting rate the return of malaria in the UK is extremely unlikely. In addition to these ecological parameters, the healthcare systems of the UK and western Europe in general swiftly treat malaria carriers, greatly reducing the time people have gametocytes circling within their blood stream (Romi, et al., 2001). This greatly reduces the chances of an anopheline mosquito taking blood when a person is infective.

I propose that the high levels of mortality experienced in the marshes in the past were the result of diarrhoeal and gastro-intestinal diseases and not deaths from benign tertian malaria. Mosquitoes still have considerable impact on the day-to-day lives of many people on Sheppey because of nuisance biting caused most likely by *Cx. pipiens*, *Cs. annulata*, *Oc. caspius* and *Oc. detritus*. All will bite people but are not malaria vector species. The risk of importing exotic vectors by aircraft is low and is considered here to be less of a risk than other type of importation methods, including tyres and non-indigenous plants. Current populations of *An. atroparvus* are localised and limited by their particular requirements for overwintering and larval breeding. The first wide scale mosquito surveillance in the UK has shown that mosquito populations are wide spread in South-East of England and viral diseases like WNV pose a more realistic threat than malaria due to the large numbers of suitable vectors. Future requirements for monitoring vector borne diseases in the UK needs to be

centred around good case detection and reporting combined with vector surveillance and mapping.

Malaria in the UK is not a current threat and unlikely to become a realistic threat in the future. With small populations, isolated in derelict building, feeding mainly on animals *An. atroparvus* poses little risk as a malaria vector.

## References

- Boyd, M. F. (1949). *Malariology. A comprehensive survey of all aspects of this group of diseases from a global standpoint*. Philadelphia and London, Saunders, W.B.
- Buckley, A., Dawson, A., Moss, S.R., Hinsley, S.A., Bellamy, P.E. & Gould, E. A. (2003). Serological evidence of West Nile virus, Usutu virus and Sindbis virus infection of birds in the UK. *The Journal of General Virology*, **84**: 2807-2817.
- Davidson, N., D. d'A Laffoley, D., Doody, J.P., Way, L.S., Gordon, J., Key, R., Pienkowski, M.W., Mitchell, R. & Duff, K.L. (1991). *Nature conservation and estuaries in Great Britain*. Peterborough, Nature Conservancy Council.
- Department of Health. (2002) West Nile virus reborn in the USA. Health Check: Chief Medical Examiners Annual Report DoH, p 27 – 33.
- Dobson, M. (1994). Malaria in England: a geographical and historical perspective. *Parassitologia*, **36**: 35-60.
- Dobson, M. J. (1997). *Contours of death and disease in early modern England*. Cambridge University Press. Cambridge.
- Doddy, P. (1990). Sea-level rise (coastal conservation). North Sea Report 1990. Marine Forum, London.
- Guillet, P., Germain, M.C., Giacomini, T., Chandre, F., Akogbeto, M., Faye, O.,

- Kone, A., Manga, L. & Mouchet, J. (1998). Origin and prevention of airport malaria in France. *Tropical Medicine and International Health*, **3**: 700-705.
- Graz, N.G., Steffen, R. & Cocksedge, W. (2000). Why aircraft disinsection? *Bulletin of the World Health Organization*, **78**: 995-1004.
- James, S. P. (1929). The Disappearance of Malaria from England. *Proceedings of the Royal Society of Medicine*, **23**: 71-85.
- Mathenge, E.M., Killeen, G. F., Oulo, D. O., Irungu, L., Ndegwa, W. P. N., & Knols, B. G. J. (2002). Development of an exposure-free bednet trap for sampling Afrotropical malaria vectors. *Medical and Veterinary Entomology*, **16**: 67-74.
- Romi, R., Sabatinelli, G. & Majori, G. (2001). Could malaria reappear in Italy? *Emerging Infectious Diseases*, **7**: 915-919.

