



## Durham E-Theses

---

### *Desire and the drives: a new analytical approach to the harmonic language of Alexander Skryabin*

Smith, Kenneth

#### How to cite:

---

Smith, Kenneth (2008) *Desire and the drives: a new analytical approach to the harmonic language of Alexander Skryabin*, Durham theses, Durham University. Available at Durham E-Theses Online: <http://etheses.dur.ac.uk/2548/>

#### Use policy

---

The full-text may be used and/or reproduced, and given to third parties in any format or medium, without prior permission or charge, for personal research or study, educational, or not-for-profit purposes provided that:

- a full bibliographic reference is made to the original source
- a [link](#) is made to the metadata record in Durham E-Theses
- the full-text is not changed in any way

The full-text must not be sold in any format or medium without the formal permission of the copyright holders.

Please consult the [full Durham E-Theses policy](#) for further details.

---

Academic Support Office, Durham University, University Office, Old Elvet, Durham DH1 3HP  
e-mail: [e-theses.admin@dur.ac.uk](mailto:e-theses.admin@dur.ac.uk) Tel: +44 0191 334 6107  
<http://etheses.dur.ac.uk>

The copyright of this thesis rests with the author or the university to which it was submitted. No quotation from it, or information derived from it may be published without the prior written consent of the author or university, and any information derived from it should be acknowledged.

## **Desire and the Drives: A New Analytical Approach to the Harmonic Language of Alexander Skryabin**

---

Kenneth Smith  
University of Durham  
Thesis Submitted for the Degree of PhD  
2008



- 6 MAY 2009

## Abstract

---

The aims of this project are two-fold. Firstly, it aims to correlate the erotically charged philosophy of Alexander Skryabin with the progressive harmonic structures of his music. Secondly it proposes a new harmonic theory which is designed to offer a deeper understanding of the ways in which music can represent and embody the mechanisms of the human 'drive'. This involves unravelling the numerous strands of thought – both esoteric and mainstream – that constructed Skryabin's idiosyncratic and highly eccentric world-view. To understand fully this complex body of ideas it appeals to 20<sup>th</sup> century psychoanalysis in the Freudian tradition. This vital link connects Skryabin's interest in psychology and philosophy to his compositional procedures whilst showing that certain of Freud's ideas were crystallised in writings on desire from the 1960s which also brought the various contradictions betrayed in Skryabin's writings into the spotlight. In some cases, Skryabin's music itself offers safe paths out of his philosophical quagmire, where the formal propositions of his writings fail.

Whilst the harmonic theory proposed is deeply rooted in the philosophy that Skryabin himself studied, it is equally grown from a correspondence between current trends of analytical thought in music and analytical trends that have been predominant in Russia. Whilst the first chapter outlays the philosophical basis of my theory, the following three chapters explore the intricacies of my analytical system in purely musical terms to present a line of inquiry termed *drive analysis*. The remaining three chapters pick up the philosophical thread and slowly draw my various strands together in a concluding analysis of Skryabin's *Poem of Ecstasy*.



# Contents

---

	Foreword & A Note on Sources and Quotations	7
	Introduction	8
<b>Chapter 1</b>	<b>The Deconstruction of the Drive</b>	<b>10</b>
	Freud's Drive and Lacan's Deconstruction	10
	Musical Drives – “A Science of Tonal Love”?	13
	Drang	14
	Quelle	16
	Objekt & Ziel	23
	Heteronymy: Skryabin's Mystic Chord and Kristeva's Chora	28
	Sublimation versus Libidinal Intensity: Examination of the Middle to Late transition – Poem, Op. 71, no. 2 and Etude, Op. 56, no. 4	34
	Skryabin's Philosophy of Drive and Desire	42
<b>Chapter 2</b>	<b>Towards a Codification of Drive Intensities</b>	<b>47</b>
	Drive Intensity	48
	The Drives	57
	Evaluation of Uses and Limitations of Drive Analysis	77
<b>Chapter 3</b>	<b>Drive Analysis and its Vicissitudes</b>	<b>78</b>
	Libidinal Intensity	78
	Polytonal Drive Configurations and Patterns	84
	Parallel Discharges	85
	Contrary Discharges	89
	Discharge Combinations	92
	Nested Discharges	93
	Drive Analysis and the Russian Tradition: Varvara Dernova	94
	Dernova and Polytonality	96
	Critique of the ‘Tritone Link’	100
	Drives and Stylistic Change	110
	(1) Middle tendencies (1903-1908)	110
	(2) Late Tendencies (1909-1915)	111
	Complete <i>Drive Analysis: Désir</i> and <i>Caresse dansée</i> , Op. 57	115
	The Way Forward	124
<b>Chapter 4</b>	<b>‘Ordering the Drives’: Navigating Drives and Desires Through Tonal Pitch Space</b>	<b>125</b>
	Pitch Spaces: Mapping the Body	125

	A Dialectic of Spaces: Ernő Lendvai with Fred Lerdahl	127
	Poem, Op. 32, no. 2	129
	Substitution and <i>bii</i>	135
	Middle – Late Style Rotation: <i>Feuillet d'album</i> , Op. 58	141
	Prelude, Op. 67, no. 1	141
	Circularity and Linearity	144
	A Linear Model	145
	A Circular Model	146
	Skryabin: Synthetic Model	148
	Macrocosmic Fifth Rotation: Sonata no. 6, Op. 62	149
	Formalities	152
	Summary	156
	Discharges	157
	Compositional Freedom	159
	Sonata in Focus: Skryabin's Sonata no. 10, Op. 70	162
	Middleground: Tonal Functionality in 'Cohn Space'	170
	Foreground: Functional Discharge <i>Within</i> Cycles	171
	The Integration of Minor Third and Major Third Related Drives	172
	Background: Functional Specificity or Arbitrary Assignment?	175
	The Way Ahead	179
<b>Chapter 5</b>	<b>Eros &amp; Thanatos: Melodic Drives and Their Gendered Roles in Skryabin's Philosophy</b>	180
	Melodic Drives	180
	Motive ♀ and femininity	182
	Motive ♂ and Masculinity	184
	A Polarity Act? Erotic Experience in Sonata no. 4	185
	Masculine and Feminine/Life and Death: Freud, Skryabin and Russian Culture	198
	Two Aspects of the Feminine: The Seductress and the Maternal	203
	Masculinity – The 'Life Drive'	211
<b>Chapter 6</b>	<b>Evolution of the Musical Subject: Panpsychism from Theosophy to Musical Form</b>	216
	Philosophy: Blavatsky's Conundrum and 20 <sup>th</sup> Century Gender Politics	219
	Mother or Father?	221
	A Dialectical Interchange	223
	Father of Individual Prehistory`	224
	Music	225
	Skryabin's <i>Vers La Flamme</i> , Op. 72	228
	Drive Analysis I	232
	Melodic Analysis	233
	The Pinnacle of Evolution	235
	Poiesis	240

In the Beginning was the Word	242	
Drive Analysis II	245	
Disjuncture of Philosophy and Music: A Way Out?	247	
<b>Chapter 7</b>	<b>A Hegelian Model of Desire and <i>The Poem of Ecstasy</i></b>	<b>248</b>
The Poem of Ecstasy: The Text and its Dialectic	248	
Skryabin's New Direction: Absorption of Hegel Through a Dialectical-Materialist Filter	251	
Negative Thematic Evolution: Theme D and the 'Struggle for Recognition'	258	
Struggle for a Social, Stable Whole: The Unrolling of a Rugged, Diatonic Epilogue	262	
Harmonic Tension, Cycles and Dialectic Leaps	266	
(1) The Mechanisms of Structural Rotation: Negation of the Cadence	269	
(2) Cycles as Negation: Dernova's 'Major Enharmonic Sequence'	270	
(3) Harmonic Negation: The Subdominant as Antithesis of the Tonic: Poem, Op. 71, no. 2	273	
The Tonic as <i>objet petit a</i>	283	
The Return Journey	286	
<b>Conclusion</b>	<b>292</b>	
<b>Bibliography</b>	<b>295</b>	
<b>Appendix A</b>	<b>Key to the Appendices</b>	<b>I</b>
<b>Appendix B</b>	<b><i>Désir</i>, Op. 57</b>	<b>ii</b>
<b>Appendix C</b>	<b><i>Caresse Dansée</i>, Op. 57</b>	<b>iii</b>
<b>Appendix D</b>	<b>Sonata no. 6, Op. 64</b>	<b>v</b>
<b>Appendix E</b>	<b>Sonata no. 10, Op. 70</b>	<b>xv</b>
<b>Appendix F</b>	<b><i>Vers la Flamme</i>, Op. 72</b>	<b>xxviii</b>
	<b><i>Poem of Ecstasy</i>, Op. 54</b>	<b>xxxii</b>

## Acknowledgements

---

As with any four-year project undertaken by an individual, there are many people who have either purposefully or inadvertently helped it along. I would therefore like to take the opportunity to offer expressions of gratitude as appropriate. First and foremost is the support and guidance of Dr. Michael Spitzer which has been truly over-whelming. Michael's enthusiasm for my work and his critical engagement with it has refined my ideas immeasurably. When I think back to the embarrassingly crude state of my academic development when I first entered his office four years ago, I realise my inability to adequately thank him. Professor Max Paddison too, for his constant interest in my work and his availability for discussions and ability to offer fresh perspectives, has been a fantastic source of encouragement. Other academics both at home and in the States helped to orientate my research, particularly in its very early stages. To this group belong Ellon Carpenter, Susie Garcia and Stephen Downes. I extend thanks to the staff of the University's friendly Russian Department – Mariana, Branka, Irene, Veronica and Lada (in order of appearance) – who offered me the opportunity to sit in on undergraduate language seminars and provided invaluable support for a struggling Russian student. On a similar note, Patrick Zuk must be thanked for his interest in my Russian translations and his readiness to correct and amend them. Other friends have directly helped by proofreading extracts of the completed text. Joris de Henau, in exchange for a set of golf clubs, read some sections, whilst Ken Smith and Lizzie Wills checked others (free of charge). Mention must also be made of Stephen Clarke who created fig.4-15 using specialist design software. Financially, the whole enterprise would have been impossible without the support of the AHRC; their generous interest in my work was also a great encouragement. In connection with this I remember my former supervisors from King's College, London – Dr Michael Fend and Christopher Wintle – who acted as referees for my application, and who I neglected to adequately thank. The support of family is certainly not taken for granted. Judith and Mike have provided support in very practical ways – culinarily, financially and hospitably – whilst Ken's low rent expectations have given me space to work in physical and financial comfort. Lizzie Wills also played a vital role in helping to maintain my sanity in the latter stages of the project through the purchase of a Gameboy Advance<sub>TM</sub> and some accompanying games, although as she sits next to me now, using this same equipment to catch Pokémon, I realise that her motives were probably selfish. The Tavistock Society have also offered constant diversion when needed, and despite their efforts to formally sabotage my attempts to write-up whilst on a camper-van trip in the South of France, they have helped me immeasurably, and it is to this group of misfits that I dedicate this project.

## A Note On Sources and Quotations

---

The many quotations from Skryabin's music are taken from the recent Dover editions of his complete works, whilst other citations from Wagner are taken from various editions (Schirmer, Schott), made available through Indiana University's IUCAT project. Although the analysis of Chapter 7 was prepared using Dover's full score of the *Poem of Ecstasy*, Pavchinsky's piano transcription (published by Muzgiz, Moscow, 1955) offered a fairly reliable and less cumbersome document to quote. A word on transliterations: where translations are my own, I offer footnoted citations from Russian texts using their original Cyrillic format and do not offer transliterations. Transliterations on the names of key Russian figures are preserved in their most common spellings i.e. *Tchaikovsky* rather than *Chaikovsky*, despite the various inconsistencies that may arise from this. In bibliographical references, disparities occasionally arise. For example, some authors translate *Sabaneyev* as *Sabaneeff*, and I ensure that citations always reflect the author's intentions.



## Introduction

---

# Desire and the Drives: A New Analytical Approach to the Harmonic Language of Alexander Skryabin

*Skryabin was a true poet of tonal erotic caresses and he can torture and sting and torment and fondle and tenderly lull with pungent sonorities; there is a whole "science of tonal love" in his compositions. This eroticism is his most delicate and unseizable trait.<sup>1</sup>*

*Leonid Sabaneyev*

From the beginning of Skryabin's short career he earned a reputation as a half-crazed composer with bizarre philosophical pretensions and a conflated sense of self-worth that bordered on monomania. His erstwhile classmate and early biographer Leonid Sabaneyev recalls, "From time to time I heard rumours about Skryabin and his strange ideas; he was said to be 'half-mad' and wanted to combine music with philosophy."<sup>2</sup> This enterprise struck Skryabin's contemporaries as pretentious: "A philosopher! He thinks he has combined music and philosophy – indeed! "How do you reconcile his multi-coloured waist-coats and lacquered boots with philosophy?" I thought."<sup>3</sup>

That Skryabin's 'philosophy' took a decidedly erotic turn is undeniable. As another of Skryabin's close friends records: "In his dream of the end of universe, Skryabin saw some kind of grandiose sexual act."<sup>4</sup> Skryabin's fragrant poetry, so philosophical in nature, delights in the dreamy fantasies that characterise the Symbolist poetry of the Russian Silver Age (1898-1917):

The ardour of the instant gives birth to eternity,  
Lights the depths of space;  
Infinity breathes with worlds,  
Ringing sounds envelop silence.  
The great comes to pass  
And sweet delightful love  
Is born anew!<sup>5</sup>

And this erotic strain was fuelled by the rise of psychoanalytical thought in the Russian intelligentsia, a movement that, as we shall see, Skryabin was keen to accept. Among Skryabin's books are found the

---

<sup>1</sup> Leonid Sabaneyev, *Modern Russian Composers* (New York: Da Capo Press, 1975), 61.

<sup>2</sup> «Иногда до меня доходили разные смутные слухи о Скрябине, о его странных идеях, о том, что он «полусумасшедший», что он хочет соединить музыку с философией?» Leonid Sabaneyev, *Vospominaniya O Skryabine* (Moscow: Classica XXI, 2003), 19.

<sup>3</sup> «Вот-так философ, думающий музыку еще с философией соединять, - думалось мне, - как же вяжутся его пестрые жилеты и лаковые ботинки с философией?» Ibid., 20.

<sup>4</sup> Reported by Boris de Schloezer: Faubion Bowers, *The New Scriabin: Enigma and Answers* (Newton Abbot, London: David & Charles (Holdings) Ltd., 1974), 18.

<sup>5</sup> Extract from the *Prefatory Act*, Faubion Bowers, *Scriabin: A Biography 2* (New York: Dover Publications, 1996), 271.

works of Maurice de Fleury, Ernest Legouvé and Henry Lagresille, French writers who drew heavily on psychology in their sociological research. Skryabin's attendance at lectures on the experimental psychology of Wilhelm Wundt, and the heavy absorption of Wundt's ideas into his own philosophical journals, prove the impact of psychology to be more than a fleeting love affair. The composer felt that only "by analysing oneself psychologically, by studying oneself, man can explain everything, including the whole cosmos."<sup>6</sup> And this outreach into the 'cosmos' betrays another of Skryabin's major fascinations – evolutionary dramas: "Cosmic history is the awakening of consciousness, its gradual illumination, its continual evolution."<sup>7</sup>

This chain of mutually dependant enthusiasms – philosophy, psychology, eroticism and evolution – will be the major concern of this thesis, as will be the most vital link in the chain – Skryabin's music. Highly controversial, highly sophisticated, highly dramatic and highly sexed, Skryabin enjoyed great fame at home and abroad during his lifetime. But popularity waned after his untimely death, and brief resurgences of analytical interest in the 1960s did little to counteract Skryabin's marginalisation. Another hindrance to Skryabin studies is the independent exploration of either his eccentric music or his highly idiosyncratic philosophy (see Boris de Schloezer's warning that "It would be incongruous to examine his music and his philosophy separately").<sup>8</sup> Perhaps more damaging still is the superficial synthesis of the two domains that yields only tenuous points of contact.<sup>9</sup> The undertaking of this thesis is to sketch a harmonic theory that can cope with Skryabin's fluid musical language, and that correlates to Skryabin's understanding of the function of desire and its basis in the Freudian concept of 'the drives'. For this project to materialise, numerous domains of both musical and non-musical thought will be brought into dialogue. The principal disciplines are: (1) psychoanalytic / philosophical theories of desire; (2) focussed analytical theories pertaining to the current trend of Neo-Riemannian harmonic analysis; (3) data gathered from Skryabin's philosophical writings, conversations and poetry. Whilst an attempt is certainly made to show that Skryabin was a highly self-conscious composer, organising his

---

<sup>6</sup> Bowers, *The New Scriabin: Enigma and Answers*, 62.

<sup>7</sup> Boris de Schloezer, *Scriabin: Artist and Mystic* (Oxford: Oxford University Press, 1987), 231.

<sup>8</sup> Ibid. 272. This complaint is echoed by Susie Garcia: Susie Patricia Garcia, *Alexander Skryabin and Russian Symbolism: Plot and Symbols in the Late Piano Sonatas* (D.M.A.: The University of Texas at Austin, 1993), 8.

<sup>9</sup> Examples of this trend are James Baker's article, *Scriabin's Music: Structure as Prism for Mystical Philosophy*, in James M. Baker, David Beach and Jonathan W. Bernard, *Music Theory in Concept and Practice* (Rochester, NY: University of Rochester Press, 1997). See also Jason Stell's recent article: Jason Stell, 'Music as Metaphysics: Structure and Meaning in Skryabin's Fifth Piano Sonata', *Journal of Musicological Research* 23/1 (2004). Stell assembles loose programmatic clichés from Skryabin's early commentators into a 'program' for the Fifth Sonata, Op. 53. He locates "a multi-stage, ascending bass line that allegorizes a theosophical belief in cycles of birth, growth, decline, and temporal and pitch motives that depict various "ages of existence" in a theosophical cosmology" (6). Baker's own hermeneutic examination of the *Poem of Ecstasy*, Op. 54 lists seven points of contact between philosophy and music. These remain tentative, superficial and largely unsupported. See for example, his discussion of theosophical 'plains' in which the 'bass' represents the 'material' plain, whilst the melodic surface represents the 'spiritual' plain (88). No evidence suggests that Skryabin conceived his textures this way, and the discussion is left open and highly equivocal. The same is true for Baker's assertion that Skryabin's music represents the geometric properties of a crystal (78).

ideas according to strict principles, a modern critical focus will naturally highlight various issues that will critique both Skryabin's objectives and his musical products.

Chapter 1 comprises a preliminary sketch of ways in which Skryabin's theories of desire can correlate with his music through the concepts of 'desire' and 'the drives' – terms drawn from the contemporary psychoanalytical universe that wholly appealed to Skryabin. Connections between this discipline and the composer will become apparent throughout the chapter, which will tentatively propose a hypothetical model of how these two terms could be embodied and differentiated in musical discourse.

Chapter 2 retains analytical focus, concentrated on the dominant chord, hierarchically cataloguing the varieties of harmonic 'drive' of which Skryabin avails himself. Crystallising Chapter 1, this is based on the common view that Skryabin's music, though thoroughly modern, remains dominant-based. As Roy Guenther claims:

That all Skryabin's late-style should be thought of as "dominant" in origin is logical and consistent, not only with the transitional style trait of prolonging the resolution tendency, but also with Skryabin's philosophy that creativity was for him an unceasing striving for an elusive goal. The tendency of a dominant chord structure to resolve to its tonic is perhaps the strongest tension-releasing characteristic of tonal music.<sup>10</sup>

To this end, Fred Lerdahl's recent work on tonal tension will be my first port of call. This chapter and the following Chapter 3 will lead the reader through the various graphs that comprise *Appendices A to F*; they build an analytical method of microscopically scrutinising the various 'drives' that flow in Skryabin's harmonic current. Allowing psychological investigation to spill over into the analytical discussion, I will term this procedure *drive analysis*. Exploring some of Skryabin's most recurrent compositional procedures will lead to a complete analysis of two of his most intimate 'erotics': the miniatures *Désir* and *Caresse Dansée*, Op. 57.

From this analytical vantage point, *drive analysis* will widen its focus in Chapter 4, surveying Neo-Riemannian theory in an attempt to reconstruct the various 'flows' of these drives in a musical 'body'. I will explore 'functional theory', particularly the work of Ernő Lendvai and, more recently, Richard Cohn. Detailed analysis of selected miniatures, as well as two of Skryabin's late sonatas – the sixth and the tenth – will illustrate this.

---

<sup>10</sup>Roy J. Guenther, 'Varvara Dernova's System of Analysis of the Music of Skriabin' in *Russian Theoretical Thought in Music* (Ann Arbor, Michigan: UMI, 1983), 180.

In Chapters 5, 6 and 7, I move from the analytical to the cultural, concentrating on the Russian philosophical and psychological milieu in which Skryabin lived and worked. Chapter 5 will take a detour through Skryabin's portrayals of gender and eroticised experience, briefly examining certain melodic tendencies ('drives') that flowered in his 'middle period'. This will prepare for an exploration into the role of melody in my harmonic system through an examination of Skryabin's absorption of evolutionary dramas. Such dramas have strong philosophical, psychological and musical importance, which will be the focus of Chapter 6 and its analysis of *Vers la Flamme*, Op. 72. Chapter 7 will draw the various threads of the thesis together in a more radical summatory analysis of the symphonic *Poem of Ecstasy*, Op. 54. This piece is accompanied by a text, explicitly referencing Hegelian desire theories, which suggest certain ways of conceptualising tonal function and melodic structure in Skryabin's larger works.

## Chapter One

---

### The Deconstruction of the Drive

*To him [Scriabin] it was axiomatic that man is ordered exclusively from forces operating within himself.<sup>11</sup>*

Boris de Schloezer

#### Freud's Drive and Lacan's Deconstruction

We have often heard it maintained that sciences should be built upon clear and sharply defined basic concepts. In actual fact no science, not even the most exact, begins with such definitions. The true beginning of scientific activity consists rather in describing phenomena and then in proceeding to group, classify and correlate them.<sup>12</sup>

Thus begins Freud's essay, *Drives and Their Vicissitudes*. The psychoanalytic term 'drive' is often taken for granted, yet it proves difficult to pin-down. Like 'deconstruction', which Derrida claimed could not be defined, Freud left the definition of the drive open. After all, the drive is merely a hypothetical construct – "one of our myths".<sup>13</sup> Even Freud's ardent follower Jacques Lacan, who added so much to drive theory, was to call it a matter of "fiction".<sup>14</sup> Yet Freud regarded the drive as a "fundamental concept", and when Lacan recuperated the theory in his *Seminar IX: Four Fundamental Concepts of Psychoanalysis*, its status was retained. Whilst I will attempt to find a working definition from a close reading of Freud's text, this definition must remain provisional, and will be further sharpened by Lacan's so-called *deconstruction of the drive*. This deconstruction, in turn, will help sketch a theoretical outline of how Freud's *drive theory* could elucidate musical discourse. First, however, a brief explanation of drive theory.

For Freud, *drives* were the "forces that we assume to exist behind the tensions caused by the needs of the Id."<sup>15</sup> Unlike *Instinkte* – particular organic needs – Freud's *Triebe* are dynamic and variable.<sup>16</sup> *Instinkte* can be satisfied from objects in the external world such as food and water, but *Triebe* exert an interminable pressure upon the subject. Like a strong wind that can be gauged only by its effects on trees and buildings, the drives are impossible to observe in themselves; psychoanalysts can only infer

---

<sup>11</sup> Schloezer, *Scriabin: Artist and Mystic*, 221.

<sup>12</sup> Sigmund Freud, *The Complete Works of Sigmund Freud xiv* (London: Hogarth Press, 1957), 117. Strachey renders the title 'Instincts and Their Vicissitudes' for reasons discussed in due course.

<sup>13</sup> Jacques Lacan, *The Four Fundamental Concepts of Psychoanalysis* (London: Vintage, 1998), 163.

<sup>14</sup> *Ibid.*

<sup>15</sup> Matthew James, 'Freud, Lacan and the Psychoanalytic Drive', <http://www.lacan.org/drives.htm> (24/09/08). James quotes Freud's "Outline of Psychoanalysis".

<sup>16</sup> One of the earliest problems with translations of Freud was the word 'Triebe', which was often translated as 'instinct', despite the fact that the German word 'Instinkt' corresponds directly to our English 'instinct'. The Russian language is perhaps clearer: «вожделенный» and «желание» equate to 'desire'; the word for 'instinct' is «инстинкт» (Instinkt). 'Drive' is usually translated as «влечение» i.e. the "death drive" is rendered «Влечение к смерти» (literally "drive towards death") and less often «инстинкт смерти» (literally "instinct of death").

them *indexically* through the behaviour of their subject.<sup>17</sup> As Freud says, “Although instincts [drives] are wholly determined by their origin in a somatic source, in mental life we know them only by their aims.”<sup>18</sup> Drives are purely physiological reactions to stimuli in nervous substance but they affect the mental life of the human subject, where their activity can be observed. As Freud says, “If now we apply ourselves to considering mental life from a *biological* point of view, an ‘instinct’ [‘drive’] appears to us as a concept on the frontier between the mental and the somatic, as the psychical representative of the stimuli originating from within the organism and reaching the mind.”<sup>19</sup>

Although highly ambivalent, the drives are ascribed different functions (i.e. the *sadomasochistic drive*, the *death drive*, the *anal drive*, the *genital drive* etc.). However, they are distinguished only as varying intensities in topological community with parts of the human body. The only drives which differ fundamentally are the two *primal drives*: the “ego or self-preservative” drive and the “sexual” drive.<sup>20</sup> Furthermore drives are described as partial because they are bound to specific areas of the physical body, becoming a functioning totality only through mental activity. As Freud says, “This much can be said by way of a general characterization of the sexual instincts. They are numerous, emanate from a great variety of organic sources, act in the first instance independently of one another and only achieve a more or less complete synthesis at a late stage.”<sup>21</sup> This later stage of organisation, for Freud, occurs when the drives are ordered under the primacy of the *genital drive* in the mind of the mature subject.

The *object* and *aim* of each drive is a contentious issue as we shall see, but I start with the premise that drives attach to any external object. Such objects are chosen via mental apparatus that interprets and re-routes the biological drives through a process called *sublimation*:

They [drives] are distinguished by possessing the capacity to act vicariously for one another to a wide extent and by being able to change their objects readily. In consequence of the latter properties they are capable of functions which are far removed from their original purposive actions - capable, that is, of ‘sublimation’.<sup>22</sup>

Sublimation is the process that will readily become important to us. Along with *reversal*, *repression* and *turning around upon the subject’s own self*, it is one of Freud’s four ‘vicissitudes’ of the drives. The *drives*, which are incapable of achieving satisfaction, are articulated into more practical *desires*. Thus sublimation is tied to the concept of desire. Desire is a symbolic construct, deeply embedded in the world of signs and language. Because a drive has no specific goal in this outside world, its energy is

---

<sup>17</sup> ‘Index’ refers to Charles Sanders Peirce’s semiotic categorisation of signs as index, icon and symbol.

<sup>18</sup> Freud, *The Complete Works of Sigmund Freud*, 123.

<sup>19</sup> *Ibid.*, 121-122.

<sup>20</sup> *Ibid.*, 124.

<sup>21</sup> *Ibid.*, 125.

<sup>22</sup> *Ibid.*, 126.

never satisfied; it remains fully reliant on the symbolic retranslation which desire affords. Desire, as a false symbolic reconstruction of the pure material drive energy beneath, would seem to be the opposite of the drive.

But the terms are often used interchangeably, leading various commentators (Fink and Žižek for example) to clarify the separation of *drive* from *desire*. Moving the discussion into musicology, the research of Lawrence Kramer highlights current confusion. Kramer examines the transformation of images of the heat of desire into water and desire's fluidity at the turn of the 20<sup>th</sup> century. Although speaking of 'desire', he quotes Freud's *Three Essays in Sexuality* (1905), which pertains to the sexual 'drive'.<sup>23</sup> But we must not go too far; a rigorous separation of *drive* and *desire* can mistakenly lead us to view the terms as antipodal, ignoring the tensile overlap that exists between them.

As a (post-)structuralist, Jacques Lacan devotes a lecture of *Seminar XI to The Deconstruction of the Drive*, in which he blends the terms in very fruitful ways. The principle assumption that Lacan breaks apart is that the drives are primitive, unconscious bodily energies. Lacan shows how drives work within a cultured environment and are structured through a relationship with the *Symbolic Order*, primarily in the form of language.<sup>24</sup> Drives, for Freud, exist as bodily stimuli but can be restructured, reoriented or reorganised to accommodate themselves to outer stimuli, where they latch onto ideas and proliferate as desires. This is generally taken to be a 'one way' journey, but for Lacan, the return also occurs: the drives can be ordered through their relationship to the Symbolic Order via the *demands* that they articulate. Lacan's illustration is the baby that cries, thus making a specific demand. The baby, alienated from its own body, does not know its exact need and it is the parent who interprets and satisfies the demand. For Lacan this is always a *misinterpretation* that structures future demands and, in turn, structures the drives. As Lacan says, "At the moment when the subject articulates the first demands, the field of pure want has already been transformed by these objects into the field of the drives."<sup>25</sup> Hence his famous dictum, "The unconscious is structured like a language". Whereas Freud illustrated the drives with mechanical imagery (which in our own times resembles Deleuze's 'desire machines') Lacan strips them of this imagery, viewing them as socially constructed phenomena.<sup>26</sup> This deconstruction rebinds the two terms; one can no longer claim that drives are primitive and desire is cultural.

---

<sup>23</sup> Lawrence Kramer, *Music as Cultural Practice, 1800-1900* (Berkeley: University of California Press, 1990), 135-175.

<sup>24</sup> Lacan's 'Symbolic Order' relates to the social world of sign and representation from which a newborn child is initially alienated.

<sup>25</sup> Jacques Lacan, Juliet Mitchell and Jacqueline Rose, *Feminine Sexuality: Jacques Lacan and the Ecole Freudienne* (New York: W.W. Norton, 1985), 134.

<sup>26</sup> Deleuze tellingly claims, "Drives are simply desiring-machines". Gilles Deleuze and Félix Guattari, *Anti-Oedipus* (London: Continuum, 1988), 37.

Thus the issue is highly complex, but Bruce Fink, one of the best commentators on Lacan's concept of desire vs. drive, finds the most useful distinction in drive's location in the subject and desire's location in the Symbolic Order; desire orientates the drives that pulsate beneath the surface towards a transitory object in the hope of satisfying the 'real' drives beneath it. Because the drives are articulated within desire (a form of sublimation), some properties of drive hold true for the desire that engulfs them.

I now propose a theory of how Freud's drive theory, and its relationship to desire, can operate in musical harmony. As I scrutinise Freud's properties of the drive it must be understood that these are also transferable to that desire that sublimates it, and the transition between the two will become crucial to the structure of Skryabin's music. This will be explored towards the end of the chapter through an analysis of two piano miniatures.

### **Musical Drives – “A Science of Tonal Love”?**

Music itself is often a casualty of philosophical-psychoanalytical discourse in musicology. The irony is all the greater that music is mysteriously annexed-off by philosophers as the innermost sanctum of unconscious processes: Schopenhauer claimed music to be the direct copy of the *Will*: Kant's *Ding an sich*; Nietzsche also posited music as the embodiment of all things Dionysian – both are essentially unconscious phenomena.<sup>27</sup> Yet the realms of philosophy and music share an unstructured relationship. In many respects, the project of bridging this chasm between the theoretical drive and musical substance has already been long under way. Ernst Kurth analysed the 'waves of energy' which music excites, viewing chromaticism as 'will' – “an urge towards motion”, “potential energy”;<sup>28</sup> Leonard Meyer taught how musical 'tendencies' operate on a listener's expectations;<sup>29</sup> Fred Lerdahl, following his work with Ray Jackendoff, formulated mathematical models of musical 'tension';<sup>30</sup> Daniel Harrison analysed the 'discharges' flowing through Neo-Riemannian functional harmony.<sup>31</sup> Heinrich Schenker used similar language in 1935: “the fundamental line signifies motion, striving towards a goal, and ultimately the completion of the course. In this sense we perceive our own life-impulse in the motion of the fundamental line, a full analogy to our inner life.”<sup>32</sup> And again, he claims, “[each pitch] is

---

<sup>27</sup> Arthur Schopenhauer, *The World as Will and Idea* (London: J.M. Dent, 2004), 164; Friedrich Wilhelm Nietzsche, *The Birth of Tragedy Out of the Spirit of Music* (London: Penguin, 1993). Nietzsche further subdivides the will into three musical categories: (1) the 'indecipherable' (the origin of music), (2) the 'will' (its subject), (3) 'emotion' (its symbols). Carl Dahlhaus, *Between Romanticism and Modernism* (Berkeley: University of California Press, 1989), 29.

<sup>28</sup> Ernst Kurth, *Ernst Kurth: Selected Writings* (Cambridge: Cambridge University Press, 1991), 106.

<sup>29</sup> Based on Gestalt psychology, Meyer formulated various implication-realisation models. His theories, like Schenker's, are based on the basic premise that unstable (i.e. dissonant) tones have an innate pull towards a point of harmonic stability. Leonard B Meyer, *Explaining Music: Essays and Exploration* (Chicago: University of Chicago Press, 1978).

<sup>30</sup> Fred Lerdahl, *Tonal Pitch Space* (Oxford: Oxford University Press, 2001).

<sup>31</sup> Daniel Harrison, *Harmonic Function in Chromatic Music: A Renewed Dualist Theory and an Account of Its Precedents* (Chicago: University of Chicago Press, 1994).

<sup>32</sup> Candace Brower, 'A Cognitive Theory of Musical Meaning', *Journal of Music Theory* 44/2 (2000), 333.



possessed of the same inherent urge to procreate infinite generations of overtones”.<sup>33</sup> Particularly interesting in this regard is the Russian analytical tradition: Alexander Milka used the term “tyagatenie” in the 1960s, which, as Ildar Khananov shows, means “drawing to”, “need for resolution” and “urge”;<sup>34</sup> Gregory Conjus, Schenker’s contemporary, wrote about harmony’s “act of creative will” in 1933, coining the term “pulse wave” in reference to Nietzsche’s ‘will to power’ and Bergson’s ‘élan vitale’.<sup>35</sup> What are *life impulse, energy, tension, urge, tendency* and *discharge* but theories of the Freudian *drive* ‘by any other name’?

Freud lists four fundamental properties of the drive in his 1915 essay ‘Drives and Their Vicissitudes’.

1. They are a constant force, exerting pressure (*Drang*) on the subject.
2. They are multivalent and independent; arising from various sources (*Quelle*) through internal stimulation (*Reiz*).
3. They are ambivalent and have no specific aim (*Ziel*) other than to discharge themselves.
4. They are capable of being sublimated towards a specific object (*Objekt*) within a desire-structure.

Lacan’s deconstruction tackles each postulate individually although, in his dense prose, the four link together. Scrutinising each in turn, I examine possibilities for musical correlation. Working through my musical mapping of Lacan’s four deconstructions will also reveal how the musical drive is a socially constructed phenomenon. I will also show how the drive functions in harmonic language of the 19<sup>th</sup> century. But my model of the musical drive will break down as I approach the fourth of Freud’s drive properties. It is precisely this breaking point which will invite a discussion of the mystical 20<sup>th</sup> century harmonies of Alexander Skryabin.

## Drang

Jacques-Alain Miller translates *Drang* as ‘thrust’, but one can also interpret it as ‘pressure’. Lacan defines it as a “mere tendency to discharge”.<sup>36</sup> In music, as Rameau claimed, the need for a dissonant sonority to resolve “drives” all tonal music.<sup>37</sup> Naturally the archetypically tense harmonic sonority, and therefore the chord which contains the greatest *Drang*, is the chord that expresses the dominant function –

---

<sup>33</sup> Heinrich Schenker, *Harmony* (Chicago: UCP, 1906 (1968)), 28.

<sup>34</sup> Ildar Khannanov, *Russian Methodology of Musical Form and Analysis* (PhD, Santa Barbara: University of California, 2003), 181.

<sup>35</sup> *Ibid.*, 130.

<sup>36</sup> Lacan, *The Four Fundamental Concepts of Psychoanalysis*, 163.

<sup>37</sup> Thomas Street Christensen, *Rameau and Musical Thought in the Enlightenment* (Cambridge: Cambridge University Press, 1993), 120.

typically V<sup>7</sup>. And this chord is often regarded as the backbone of Skryabin's musical form.<sup>38</sup> But in his 1915 *Drives and their Vicissitudes*, Freud was clear that drives have no differentiating "quality"; they exercise different functions only in regard to their "quantity" or intensity:

Are we to suppose that the different instincts which originate in the body and operate on the mind are also distinguished by different qualities, and that that is why they behave in qualitatively different ways in mental life? This supposition does not seem to be justified; we are much more likely to find the simpler assumption sufficient – that the instincts are all qualitatively alike and owe the effect they make only to the amount of excitation they carry, or perhaps, in addition, to certain functions of that quantity.<sup>39</sup>

And this translates fluently to our harmonic drive where the dominant function embodies varying degrees of intensity. However the function manifests itself, the most potent unit within the chord is the tritone – the *diabolus in musica*. As Richmond Browne claimed, this 'rarest interval' is the strongest defining agent of tonality.<sup>40</sup> By manipulating the other pitches of the dominant sonority one can increase its tension value. Typically,  $\hat{5}$  can be augmented or diminished; even the elements of the tritone – the third or the seventh of the chord – can be chromatically altered and still retain the dominant function in some circumstances, though such modifications can weaken the levels of tension. Steve Larson clarifies this, claiming in one instance, "The absence of a root-position dominant immediately before the tonic weakens the drive from V to I".<sup>41</sup> And this form of drive – the dominant chord – will be the primary concern of this thesis. Dominant variants are not particularly exclusive to Skryabin, all of them common to the 19<sup>th</sup> century's harmonic lexicon, but here I briefly mention a few, by way of illustration.

One particularly important sonority is the V chord with diminished fifth. Peter Sabbagh discusses Skryabin's youthful absorption of this chord, discussing its relation to Chopin's style.<sup>42</sup> This example from Skryabin's early Prelude, Op. 11, no. 2 shows a B<sup>7</sup> chord with the diminished fifth – F $\natural$  – in the bass of m. 2, moving to an E minor chord, emphasised through the bass B→E motion.

---

<sup>38</sup> Varvara Dernova shows that Karatygin understood Skryabin's harmonies as dominant functioned in 1916: Roy Guenther, *Varvara Dernova's "Garmoniiia Skriabina": A Translation and Critical Commentary* (PhD: The Catholic University of America, 1979), 79.

<sup>39</sup> Freud, *The Complete Works of Sigmund Freud*, 123.

<sup>40</sup> Richmond Browne, 'Tonal Implications of the Diatonic Set', *In Theory Only* 5/6-7 (1981).

<sup>41</sup> Steve Larson, 'A Tonal Model of an 'Atonal' Piece: Schoenberg's Opus 15, Number 2', *Perspectives of New Music* 25 (1987), 421.

<sup>42</sup> Sabbagh refers to the chord as the 'Chopin Chord': Peter Sabbagh, *The Development of Harmony in Scriabin's Works* (USA: Universal Publishers, 2003), 41.

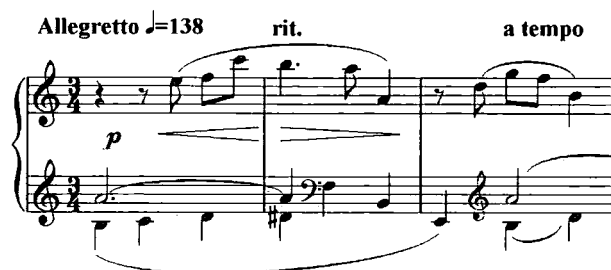

FIGURE 1-1: PRELUDE, OP. 11, NO. 2

Perhaps only slightly less common is the dominant chord with the augmented fifth.



FIGURE 1-2: PRELUDE, OP. 11, NO. 4

Here, the raised fifth – G $\sharp$  – pre-empt the more conventional resolution from F $\sharp$  to G $\natural$  in E minor. In so doing it presents an augmented chord with an added seventh.



FIGURE 1-3: PRELUDE, OP. 11, NO. 9

In m. 3 of Prelude, Op. 11, no. 9 the conventional seventh-chord is doubly altered, containing a minor third and a diminished fifth. The C $\sharp$  of the previous measure chromatically moves to C $\natural$  to create a diminished fifth. This in turn combines with the minor third – A – to create a dominant-functioned pseudo- F $\sharp$ <sup>7</sup> chord (“half-diminished”) which naturally moves towards a B<sup>7</sup> chord.

In Chapter 2, dominant-functioned chords will be collated, and Fred Lerdahl’s formulae for calculating tonal tension will help to build a hierarchal table of strengths (or intensities) for each chord. Suffice to say at this stage that modifications to the dominant function increase or decrease the *drang* – the pressure – of the dominant drive. All of these chords, and indeed the function they express, contain varying pressures – one of the chief properties of the drive.

## Quelle

Freud regarded all drives as partial, meaning that the ‘oral drive’, the ‘anal drives’ etc. are each associated with specific areas of the body. During infancy these drives are mixed and confused, pulling the subject in numerous simultaneous directions, making it ‘polymorphously perverse’.<sup>43</sup> Puberty opens up the ‘genital drive’ that draws subsidiary drives into a single fully developed totalising structure.

Lacan makes one crucial change to this Freudian paradigm. Whilst he affirms the drives as a partial representation of a single sexual function, he shows that this sexual rubric is not hegemonic. Further, these partial drives are associated with specific areas of the body as erogenous zones that are “rim-like” structures. The mouth, for instance, is regarded as an erogenous zone, but of course the oesophagus and the stomach that play an equal part in the digestive act, are not. The drives, which, in the normal functioning of a fully developed subject, are successfully repressed, become aroused only through the mediation of this “rim” – the surface that is stimulated and excited.

Where do we locate this rim musically? In other words: where can the dominant drives be activated in musical material? Through what are they initiated? Naturally this initial surface excitation occurs in various musical parameters. For example, the rim could be located spatially, at the outer edges of a chord’s articulation, either as the melodic or bass pitch. One could also explore the music’s temporal flow and find the rim at the edges of phrase constructions. Naturally, both could co-exist. The dominant drives frame musical phrases as cadence points in cooperation with melodic approaches to stability – typically the descent of  $\hat{2}$ - $\hat{1}$ . Cadences are certainly the moments where tension is released via the tonic chord; whilst David Huron calls cadences “the most predictable passages in music”, Susan McClary calls them the “cessation” or “death of energy.”<sup>44</sup> But the cadence is also the place where tension is most acutely aroused, via chord V and its linear selection in the chord progression. In this case, the syntactical position of harmonic / melodic interchanges can activate the drives.

But for Lacan and Freud, drives are aroused in two ways: (1) internally and (2) externally. How could these be musically categorised? *External stimulation* of harmonic drives, partly concerned with the rim, could describe numerous situations. As mentioned, it could refer to a melody that activates the harmony that lies beneath it; it could also be a conventionally syntactical ‘chord sequence’ which, through tradition, dictates where the dominant-drive will be placed. An example could be the I-IV-V<sup>7</sup>-I progression. These external stimulations are regulated by conventional melodic / harmonic practices – Lacan’s Symbolic Order – and in the following discussion I focus only on *internal stimulation*. Freud

---

<sup>43</sup> ‘Polymorphous perversity’: For Freud, the newborn infant finds autoerotic gratification from many indiscriminate sources.

<sup>44</sup> David Huron, *Sweet Anticipation: Music and the Psychology of Expectation* (Cambridge, Mass.: MIT, 2006), 164; McClary Susan McClary, *Feminine Endings: Music, Gender, and Sexuality* (Minneapolis: University of Minnesota Press, 1991), 127.

terms drive excitation *Reiz* but, as Lacan explains, “the *Reiz* that is used when speaking of the drive is different from any stimulation coming from the outside world, it is an internal *Reiz*”.<sup>45</sup> The drives are therefore excited from within themselves, and this radically impacts upon our musical findings. This is congruous with Schenker’s concept of musical motion: “We should get used to the idea that tones have lives of their own, more independent of the artist’s pen in their vitality than one would dare believe.”<sup>46</sup> In musical terms the conflict between drive as internal and external *Reiz* can become analogous to the debate of whether harmony (internal) or melody (external) control musical motion. Thus we enter the *Querelle des Bouffons*, and find Rameau arguing with d’Alembert that *harmony* gives rise to *melody*.<sup>47</sup> “For Rameau, harmony was ‘the sole basis of music and the source of its greatest effects’. By contrast ‘melody only obtains its force from this source [harmony], from which it proceeds directly.’”<sup>48</sup> Rameau posited that the diatonic scale arose from a single fundamental pitch, and that melody finds its roots in harmony, which therefore propels music forwards. Koch’s *Versuch* synthesises both harmony and melody through a similar demonstration. Indebted to Rameau and Marburg, he claimed, “a melody contains in itself the basis of its harmony”.<sup>49</sup> But even within Koch there are contradictions; at one point he explains that modulation is caused by the ‘arbitrary’ chromatic raising of a melodic pitch, which leads Nancy Baker to announce that, according to this idea, “the harmony arises from the melody”.<sup>50</sup> In this context then, the issue of internal / external *Reiz* is a thorny one, in great need of pruning.

Focussing on harmony – particularly the dominant to tonic motion – as a driving principle, *Reiz* is found in the various tones that shape the dominant chord and facilitate the pulsation of tension. The pure tritone is the primary form of drive and the epitome of instability; it needs to resolve to a stable chord. The interval would be static in itself, caught between two discharge possibilities; it needs other pitches to persuade it to move in a certain direction. These additional pitches – ‘within’ the chord – stimulate the tritone drive it encloses. Ernst Kurth emphasises this issue in the case of Wagner, referring to the ‘force’ of the tones: “it is common [in Wagner] for the same tone to have two directional tendencies, and this phenomenon indicates a compression of forces.”<sup>51</sup> This vertical compression is, of course, the simultaneity of the drives.

<sup>45</sup> Lacan, *The Four Fundamental Concepts of Psychoanalysis*, 164.

<sup>46</sup> Schenker, *Harmony*, xxv.

<sup>47</sup> For a handy synopsis of this series of arguments, see Jonathan Bernard, “The Principle Elements: Rameau’s ‘Controversy with D’Alembert’”, *Journal of Music Theory* 24/1 (1980).

<sup>48</sup> Nancy Baker, “Der Urstoff der Musik’: Implications for Harmony and Melody in the Theory of Heinrich Koch”, *Music Analysis* 7/1 (1988), 12-13. See also debates in Italy; S Cusick, ‘Gendering Modern Music: Thoughts on the Monteverdi - Artusi Controversy’, *Journal of The American Musicological Society* (1993), 12-16.

<sup>49</sup> Baker, “Der Urstoff der Musik’: Implications for Harmony and Melody in the Theory of Heinrich Koch”, 5.

<sup>50</sup> *Ibid.*, 9.

<sup>51</sup> Kurth, *Ernst Kurth: Selected Writings*, 113.

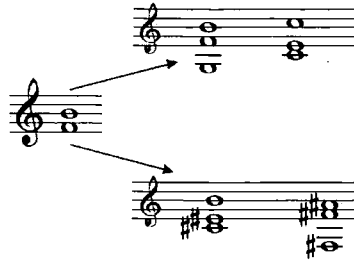

FIGURE 1-4: POTENTIAL DISCHARGE PATHS FOR THE SINGLE TRITONE

It requires a special kind of music to illustrate this organic, ‘internal’ arousal of the drive. Turning briefly to Skryabin’s *Poème-Nocturne*, Op. 61, a G-Ab-B-Bb melodic cell is answered by an F-Cb-Db-G motive in the bass. The final Eb gesture of m. 2 (and m .3) completes an enharmonically respelled G<sup>7</sup> chord, and this is the result of a five-stage process:

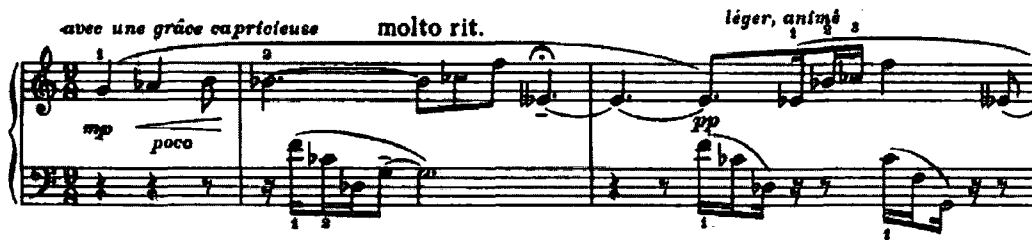

FIGURE 1-5: POÈME-NOCTURNE, OP. 61

1. The melodic fragment in m. 1 establishes G as an important pitch, but certainly not a tonal centre; the Ab, B and Bb prevent hearing it as a tonic, thus alienating it from both G major and G minor keys.
2. The left-hand articulates a tritone interval – F / Cb (B). These are ‘disconnected’ from the melody: the F could be heard as a consonant fourth-relation to the melodic Bb, but the following Cb creates a dissonant ‘jar’.
3. The Cb → Db manoeuvre now begins to suggest an incomplete Db<sup>7</sup> chord (the fifth is omitted, though it could still resonate with the Ab of m. 1).
4. The addition of G in the bass makes the previous three pitches (F, Cb, Db) sound as a G<sup>7b5</sup> chord (a *French sixth*).
5. The melody ceases its rising trajectory and an abrupt descent brings the Eb to light, emphasised through a fermata. Neither truly melodic nor truly harmonic, this pitch ‘corrects’ the b fifth of the G<sup>7</sup> chord.

Thus a complete ‘dominant drive’ is constructed entirely ‘from within’; no melodic or cadential imperative calls it into being. From its initial inception as a dissonant bass tritone figure, the drive

spreads itself out across the melodic surface, engulfing the melody entirely. The drive *can* be internally stimulated despite the fact that, in traditional harmony, it does not tend to be.

One of the principal qualities of the drive is its persistence. Lacan reminds us that Freud “cannot conceive of it as a *momentane Stosskraft* [‘instantaneous striking power’]”, and that Freud describes the drive as a constant energy (*konstante Kraft*).<sup>52</sup>

In the drive there is no question of kinetic energy; it is not a question of something that will be regulated with movement. . . The constancy of the thrust forbids any assimilation of the drive to a biological function, which always has a rhythm. The first thing Freud says about the drive is, if I may put it this way, that it has no day or night, no spring or autumn, no rise and fall. It is a constant force.<sup>53</sup>

And this is the point at which an examination of *Classical* and *Romantic* music takes leaves of the ‘drive’. In classical phrasing, ‘dominant drives’ are excited at cadence points and discharged immediately. This is because they are sublimated into object-orientated structures that will soon be called ‘desire’. In the 19<sup>th</sup> and 20<sup>th</sup> Centuries things began to change; cadences were no longer the only places where drives erupted and, in Skryabin’s late style, drive energy flows freely through the musical surface. Jean-François Lyotard begins *Libidinal Economy* with the horrifying image of a dismembered human body, the pieces reassembled to create a giant “libidinal band”.<sup>54</sup> This translates directly to Skryabin’s music where the diatonic system is ‘torn apart’ and the drives, which it previously regulated through repressive control, now take over the organic body. A glimpse at a passage such as this, from Etude, Op. 56, no. 4, illustrates that Skryabin does not arouse the drive via an external ‘rim’; the drives are highly persistent forces throughout.

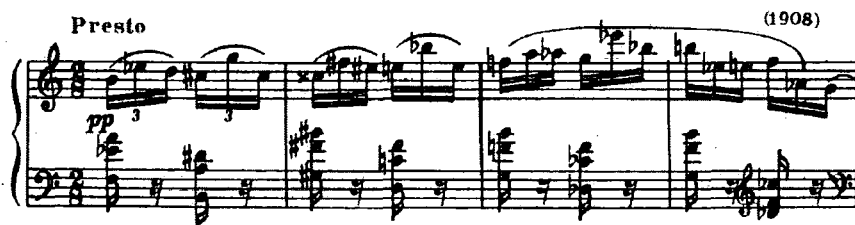

FIGURE 1-6: ETUDE, OP. 56, NO. 4

The full complexity of these drives will be analysed in due course, but even confining an analysis to the left-hand chords can illustrate Skryabin’s drive operations. An F<sup>7</sup> drive moves immediately to a B<sup>7</sup> drive and is followed by a G<sup>#7</sup> drive, a D<sup>7</sup> drive, a G<sup>7</sup> drive and a Db<sup>7</sup> drive. The D<sup>7</sup> → G<sup>7</sup> progression is the only ‘discharge’ here; the drives remain persistent and are certainly aroused ‘from within’ as an internal *Reiz*; melodic and cadential concerns do not control the flow of drives.

<sup>52</sup> Lacan, *The Four Fundamental Concepts of Psychoanalysis*, 164.

<sup>53</sup> *Ibid.*, 165.

<sup>54</sup> Jean François Lyotard, *Libidinal Economy* (London: Continuum, 2004).

Even in Skryabin's earliest compositions, cadence-points were turned inside out, often presented as openings rather than closures. Dominant drives were initiated in unusual places, often retaining their charge through changing harmonies. In the following example, again from an early Prelude, Op. 11, a cadential drive discharges in the second beat of the first complete measure as the melody rises  $\hat{5}-\hat{6}-\hat{7}-\hat{8}$ .

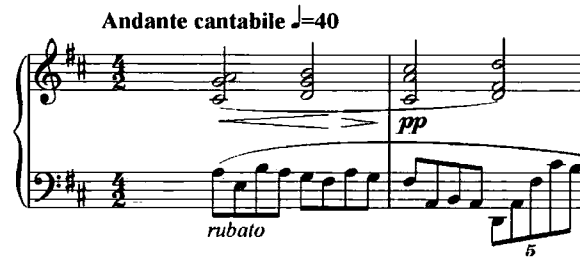

FIGURE 1-7 (A): PRELUDE, OP. 11, NO. 5

The opening chord is a seventh chord on A and assumes the role of V in the key of D. But only the leading tone of the drive is discharged as the C# pitch rises to the D; the As split into a G and B, outlining the subdominant chord of G. The third of these chords displays another dominant implication via the pitch C#, although the bass outlines the pitches F# and A in an ambiguous homogenisation of the dominant chord – A – and its relative minor – F#. The ambiguity between two keys – D major and B minor – is maintained in the following chord. A dominant → tonic discharge in the key of D also contains pre-cadential hints at the pitch B in the left-hand, suggesting an alternative discharge in the relative minor key, albeit a marginalised one. In this extract the drive is the first thing we experience, but it is attached to nothing. A more conventional opening would initiate the tonic immediately and the tritone drive would be aroused only at the point where the melody initiates the  $\hat{7}-\hat{8}$  – ‘the rim’:

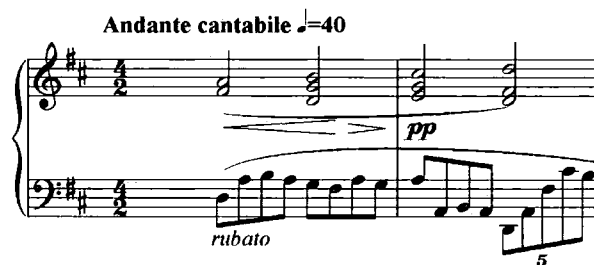

FIGURE 1-7 (B): PRELUDE, OP. 11, NO. 5 – A REINTERPRETATION

But in Skryabin's composition, a drive arises in the particular key of D major; this drive contains pressure which would lead it in a specific direction; this direction is then presented in a harmonic syntax that orientates it towards a conventional  $IV \rightarrow V \rightarrow I$  progression. Yet this fails to satisfy because this ‘symbolic’ representation of the opening drive chord in m. 2 leaves the actual pressure (*Drang*) of the drive behind (the seventh is omitted and the potent tritone is therefore absent). The drive persists



throughout the piece but suffers similar repression to allow formulaic chord progressions to articulate it as a representation – a ‘misrecognition’. But Skryabin also allows other drives to erupt beneath the surface; sonorities become highly ambiguous, indicating no single object, often working in simultaneous keys.

However, in Skryabin’s *late style*, drives pulsate irregularly in seemingly aleatory directions, resisting such orientation towards single objects. And these drives can occur simultaneously, conflicting within a single vertical sonority. Skryabin’s late opuses contain drives in numerous keys and are certainly not aroused at the rim; rather, they dominate the harmonic and melodic surface. Drive proliferation in Skryabin’s late style is revealed in the following example.

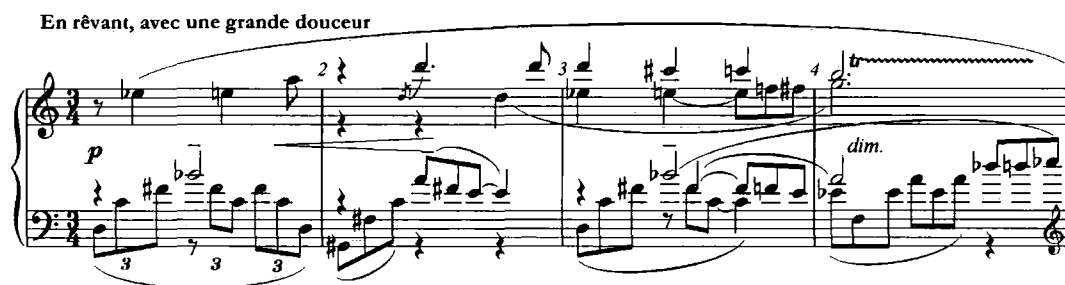

FIGURE 1-8: POEM, OP. 71, NO. 2

In these opening four measures dominant drives are harmonically fused. The left-hand articulates a  $D^7$  structure with the fifth augmented to a  $B\flat$ , driving towards G major. But the pitch E in the upper line participates in a  $C^7$  drive, arising in the middle of the measure, this time with a diminished fifth –  $F\sharp$ . These drives return in m. 3, both moving towards their objects in m. 4 – G and F. The G chord is articulated in the upper third-trills, resonating with the seventh – F – in the bass; the  $F^7$  chord is contained in the pianist’s left-hand. The entire drive structure of this piece will be examined thoroughly in due course, but this brief example illustrates that drives both synchronically and diachronically flow through a short section of music.

These drives are often broken down into their characteristic components and presented in a rather disconnected chain. In the next example, in no particular key, a consistent seventh – C and  $B\flat$  – embody a weak drive towards F major, followed by a drive based around a  $D^7$  chord: the  $B\flat$  resolves to an A (as it would in F major) and the A- $F\sharp$  motive is repeated over a D in the tenor register; the pitch C lingers in the bass.



FIGURE 1-9: POEM, OP. 63, NO. 1: “MASQUE”

Skryabin certainly recuperated classical phrase structures, choosing to articulate his material in clearly defined four-bar units, but rather than allow the drives to become excited towards phrase ends – at the rim of the structure – he chose to open the repressive barriers and allow them to flourish unfettered.<sup>55</sup> The ‘rim’ then, stops being applicable to Skryabin’s late works, which portray the drives as a constant force. This is because Lacan’s (and Freud’s) focus on the rim as it pertains to the drive is somewhat misleading. The rim is the gateway through which the drive is articulated in the Symbolic Order, it is a mechanism for release from the structures of mental repression. Skryabin’s harmony then, represents an internal *Reiz*. This will be the subject of the remainder of the thesis.

## Objekt & Ziel

What is the object of the drive? This question causes confusion amongst Lacan’s commentators. Freud is fairly strict, however, claiming that: “As far as the object of the drive is concerned, let it be clear that it is, strictly speaking, of no importance. It is a matter of total indifference.”<sup>56</sup> Lacan however, denies this ambivalence, suggesting that object choices can be traced along a metonymic chain to their root: *the lost real*. For example, the *oral drive* for food is a metonymic replacement for the maternal breast. Some go even further and regard the drive as intensely object-orientated. Žižek, in an attempt to elucidate Lacan’s drive theory through popular culture, misreads drive teleology. He examines the cinematic trope of zombies who return from the dead to seek a specific victim, refusing to be distracted by anyone else: “A drive is precisely a demand that is not caught up in the dialectic of desire, that resists dialecticisation ... it is a “mechanical” insistence that cannot be caught up in dialectical trickery: I demand something and I persist in it to the end.”<sup>57</sup> Fink takes a similar interpretation: “The drive couldn’t care less about prohibition and certainly doesn’t dream of transgressing it. The drive

<sup>55</sup> This observation – that Skryabin adhered to sonata form – is made by many, but is a particular concern of James Baker. James M. Baker, *The Music of Alexander Scriabin* (New Haven: Yale University Press, 1986), 17 ff. A thorough discussion of similar repetition / phrasing techniques in relation to Russian musical style can be found in Richard Taruskin, ‘Review: “The Music of Alexander Scriabin”, James M. Baker & “Scriabin: Artist and Mystic”, Boris de Schloezer’, *Music Theory Spectrum* 10/10th Anniversary Issue (1988).

<sup>56</sup> Lacan, *The Four Fundamental Concepts of Psychoanalysis*, 168.

<sup>57</sup> Slavoj Žižek, *Looking Awry: An Introduction to Jacques Lacan through Popular Culture* (Cambridge, Mass.: MIT Press, 1991), 21.

follows its own bent and always obtains satisfaction.”<sup>58</sup> This is something of a misnomer of course – the drive *does* have an object, but this object is never reached. As Lacan says, “By snatching at its object, the drive learns in a sense that this is precisely not the way it will be satisfied.”<sup>59</sup> Lacan claims, “*la pulsion en fait le tour*” – a double-pun in which the drive both ‘tricks’ and ‘moves around’ its object.<sup>60</sup>

In harmonic discourse this ‘indifference’ is difficult to imagine as dominant chords *do* seem have a natural object: the tonic chord. *Instability* has *stability* as its goal and this is embodied most clearly in music by the perfect cadence. But it could be argued that this form of satisfaction is transitory and ultimately unfulfilling. After a cadential point of repose, drives always re-emerge in a subsequent phrase. A composer needs to quell this tension by re-emphasising the tonic chord numerous times at increased volumes in the coda of a symphony’s finale in order to convince us that the dominant drives have been satisfied – a form of ‘repetition compulsion’.<sup>61</sup> In Skryabin’s earliest pieces this paradigm became conventional. This example from Prelude, Op. 11, no.4 is lifted from a miniature of 28 measures in length, of which the last 8 simply affirm the tonic key of E minor by repeating the V → I progression.



FIGURE 1-10: PRELUDE, OP. 11, NO. 4

Lacan notes that Freud writes ‘satisfaction’ in inverted commas, and he jokingly over-simplifies this problem: “*Well, that’s simple enough you’ll say. The satisfaction of the drive is reaching one’s Ziel, one’s aim.*”<sup>62</sup> But Lacan suggests that this was an enigma which Freud left others to solve, hinting that Freud left a key to this riddle in one of the vicissitudes of the drives – *sublimation*. Lacan illustrates that drive tension is

<sup>58</sup> Bruce Fink, *A Clinical Introduction to Lacanian Psychoanalysis: Theory and Technique* (Cambridge, Massachusetts: Harvard University Press, 1997), 208.

<sup>59</sup> Lacan, *The Four Fundamental Concepts of Psychoanalysis*, 167.

<sup>60</sup> *Ibid.*, 168.

<sup>61</sup> In 1920, Freud located the ‘repetition compulsion’ in a child’s attempt to master his toys by throwing them out of the pram and then reclaiming them. ‘Repetition compulsion’ relates to our need to relive traumatic experiences (such as a dissonant – consonant pattern) in order to deal with them. Sigmund Freud, *Beyond the Pleasure Principle* (London, Vienna, 1922).

<sup>62</sup> Lacan, *The Four Fundamental Concepts of Psychoanalysis*, 165.

discharged through sublimation. In a typically colloquial (yet illuminating) moment, Lacan claims, “for, the moment, I am not fucking, I am talking to you. Well! I can have exactly the same satisfaction as if I were fucking. That’s what it means. Indeed, it raises the question of whether in fact I am not fucking at this moment.”<sup>63</sup> But satisfaction, even through sublimation, is impossible: “the path of the subject passes between the two walls of the impossible [the possible and *the Real*].”<sup>64</sup> Sublimation is an attempt at satisfaction without repression, but *zielgehemmt* (its aim, satisfaction) is never attained.

Lacan’s primary concern was to deconstruct the object of the drive. He shows that its objective is simply to leave its circular path, move around its object, and return to its orbit: “What is fundamental at the level of each drive is the movement outwards and back in which it is structured.”<sup>65</sup> In other words, *the drive itself does not wish to be satisfied*. In *Seminar XI*, Lacan draws the following well-known diagram.

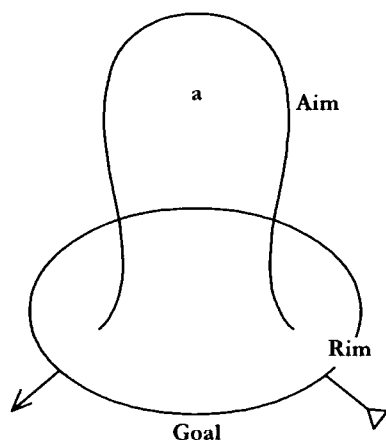

FIGURE 1-11: LACAN’S MODEL OF THE DRIVE CIRCUIT

The drive reaches out of the rim as a ‘demand’, returning to its path of its own volition. Lacan shows how “the tension is loop shaped and cannot be separated from its return to the erogenous zone.”<sup>66</sup>

Another of Lacan’s major contributions is the separation of the French word *but* into its two English equivalents: *aim* and *goal*. He interprets the ‘aim’ as the path taken to achieve the ‘goal’, which is the end-point. The drive’s purpose is its *aim* – not its *goal*: it wants to perpetually follow its course, thus it achieves satisfaction by resisting satisfaction: “If the drive may be satisfied without attaining what, from the point of view of a biological totalization of function, would be the satisfaction of its end of reproduction, it is because it is a partial drive, and its aim is simply this return into circuit.”<sup>67</sup>

<sup>63</sup> Ibid., 165-166.

<sup>64</sup> Ibid., 167.

<sup>65</sup> Ibid., 178.

<sup>66</sup> Ibid., 179.

<sup>67</sup> Ibid., 179.

Musically, this model does not apply to the conventional language of diatonicism. In a classical phrase only a glimpse of the drive can be caught during the sublimation process – typically, the cadence. This is where an analysis of Skryabin’s late ‘atonal’ music becomes necessary. Here, different dominant forms do indeed orbit the central tonic object (or objects); Skryabin replicated drive-based structures that are content to maintain their circuitous paths. In this he exemplifies this 20<sup>th</sup> century process because, more so than any other composer, he is famed for utilising dominant-based sonorities in a decidedly ‘atonal’ context.<sup>68</sup>

As discussed, the tritone is the indeterminate drive *par excellence* as it could discharge its tension via two paths into two tritonally related keys. Considering the tritone’s repression in the 14<sup>th</sup> century, its later confinement to the dominant seventh chord is a perfect model of Freud’s *sublimation*; the repressed has been rerouted to a ‘more reasonable’ form of articulation. Lacan would term this *méconnaissance*, the fundamental misrecognition of the drive’s goal by the subject; the projected tonic chord serves as a misinterpretation of drive energy. One of Lacan’s commentators, Jean-François Lyotard, calls this form of misinterpretation the *dispositif*. For Lyotard, libidinal energy invests itself in one place at the expense of many others. The excessive energy lying beneath the *dispositif* is repressed in favour of the more manageable investment. Lyotard showed that libidinal *pulsions* exist in excess of their *dispositifs* – the cathecting apparatus.<sup>69</sup> A *dispositif* then reigns autonomously, ignoring the excessive energies that created it, energies which, though repressed, still exceed the new structure that represents (and condenses) them falsely.

The *dispositifs* which channel their impulsions into theoretical discourses, and will give rise to organisms of power, are the very ones which will harden into the German party, The Bolshevik Party, these *dispositifs* are of course ‘compromise-formations’, they are so many attempts to stabilize the forces on the libidinal front...<sup>70</sup>

The tonic chord therefore acts as a *dispositif*; the drives beneath are satisfied through this exact same *sublimation*. And this is pure desire. Desire is the process by which a demand, made by the drive, is articulated in the Symbolic Order. Desire is thus a form of *interpretation*. Lacan claims: “As it draws to an end, interpretation is directed towards desire, with which, in a certain sense, it is identical. Desire, in fact, is interpretation itself.”<sup>71</sup>

---

<sup>68</sup> Many commentators adopt this view: see Richard Taruskin, 'Scriabin and the Superhuman: A Millennial Essay', in *Defining Russia Musically* (Princeton University Press, 1997); V. Dernova, *Garmonia Skriabina* (Leningrad: Izd-vo "Muzyka", 1968); George Perle, 'Scriabin's Self Analyses', *Music Analysis* 3/2 (1984).

<sup>69</sup> To cathect, for Freud, means to emotionally invest.

<sup>70</sup> Lyotard, *Libidinal Economy*, 95.

<sup>71</sup> Lacan, *The Four Fundamental Concepts of Psychoanalysis*, 176.

But what of the remainder, the drives – ignored by desire – which are not sublimated? For Lacan, desire is complex because it is intensely dialectical. His model of desire, based on Hegel’s ‘master-slave dialectic’ shows how a person desires to be ‘the desire of the other’.<sup>72</sup> In Hegel’s model, the master realises that the more he suspends the slave’s desire for food, the more value the food gains, becoming transformed into an object of desire. For Lacan ‘desire is always the desire of the other’, meaning that one always desires what the other desires in attempt to become, oneself, the object of the other’s desire. From this same Hegelian dialectic, Lacan also takes the idea that the total desire produced is greater than demand or necessity. Lacan also pre-echoes Lyotard when he says, “... desire is situated in dependence on demand – which, by being articulated in signifiers, leaves a metonymic remainder that runs under it, an element that is not indeterminate which is a condition both absolute and inapprehensible, an element essentially lacking, unsatisfied, impossible, misconstrued (*méconnu*), an element that is called desire.”<sup>73</sup> Lyotard calls this remainder the *tensor*, the incidental signs which are given off whenever a semiotic function is articulated. This *tensor* is given voice in Skryabin’s music in instances where a strong drive is continued, but a weaker drive exerts pressure regardless. It shows itself in the final measures of Etude, Op. 56, no. 4 in which, of the two tritonally linked drives – Db and G – the Db is chosen to conclude. The drive on G, which precedes the Db in the second measure of this example, exerts pressure from within the D<sup>7</sup> chord, through the b<sup>♯</sup> that makes both chords synonymous. Although the drive on Db is selected to draw the piece to a close (*a méconnaissance* of the drive energy), the drive on G is still an important libidinal force, which tries in vain to breach the surface: a perpetual *tensor*.

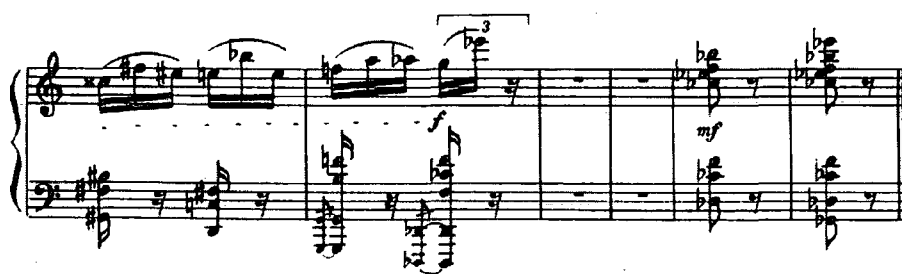

FIGURE 1-12: ETUDE, OP. 56, NO. 4: CONCLUSION

And Lacan suggests that the dialectical process of constant misrepresentation of the subject’s actual need (and its consequent formulation of signifiers and demands) is the structure of desire. The relationship between drive and desire then, is a transition; Lemaire propounds that ‘instinct’ [drive] is

<sup>72</sup> Lacan himself learned of Hegel from the Russian Kojève, lecturing at the *Ecole Pratique des Hautes Etudes* in Paris from 1933-1939.

<sup>73</sup> Lacan, *The Four Fundamental Concepts of Psychoanalysis*, 154.

misunderstood through the Symbolic Order and interpreted as a symbol, leading to the realms of desire.<sup>74</sup> Fink says, “the drive takes the object with it separating from the Other as desire”.<sup>75</sup>

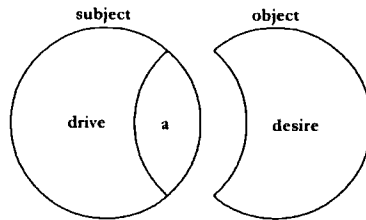

FIGURE 1-13: DIAGRAM OF SEPARATION OF DRIVE AND DESIRE

In Lacan’s diagram, *the Real* (a form of what Lacan terms the *objet petit a*) is indicated by the ‘a’ within the drive’s circle. Desire is an illusory representation of the drive that loses connection to *the Real* (the material human body where the drives originate). Thus desire is based on pure illusion, pure *phantasy*: “the impulse [*drive*] is satisfied essentially by hallucination.”<sup>76</sup> “Phantasy is the support of desire”; “the object of desire, in the usual sense, is ... a phantasy that is in reality the *support* of desire, or a lure.”<sup>77</sup> This could explain something of how the drive operates within a classical diatonic phrase. The tritone, with all of its power, is aroused and immediately ‘oedipalised’; it is placed within the triangular structure of the tonic, subdominant and dominant and its position is instantly articulated and confirmed through its dominant → tonic discharge.<sup>78</sup> In this example, an early Mazurka in F# major, a C#<sup>7</sup> chord is initiated in the first measure – the E#/B tritone arises on the second beat of the measure and in m. 2 is discharged immediately onto an F# triad. Yet despite this linear process, the *tensor* lurks beneath. The pitches B and F in m. 3 now move unconventionally to an E<sup>7</sup> chord.



FIGURE 1-14: MAZURKA, OP. 3, NO. 2

<sup>74</sup> Anika Lemaire, *Jacques Lacan* (London: Routledge & Kegan Paul, 1977), 165. Lemaire uses the term ‘instincts’ where other commentators would use the word ‘drives’, doubtless due to the translation problem which I have outlined.

<sup>75</sup> Fink, *A Clinical Introduction to Lacanian Psychoanalysis: Theory and Technique*, 277.

<sup>76</sup> Lacan, *The Four Fundamental Concepts of Psychoanalysis*, 154.

<sup>77</sup> *Ibid.*, 185-186.

<sup>78</sup> The neologism ‘Oedipalised’ is used by Deleuze to describe a child’s resolution of the *Oedipus complex*.

## Heteronymity: Skryabin's *Mystic Chord* and Kristeva's *chora*

To explore fully the function of drives in Skryabin's music I appeal to a more recent commentator, Julia Kristeva. Kristeva's model maintains this progression from drive to desire, which then bars the drive from the subject:

More precisely and concretely this subject's desire is founded on drives ("the psychosomatic articulation" [*charnière*]) that remain unsatisfied, no matter what phantasmatic identification desire may lead to because, unlike desire, drives "divide the subject from desire". Desire's basis in drives will be dismissed and forgotten so that attention may be focussed on *desire itself*.<sup>79</sup>

An important advocate of Lacanian psychoanalysis, Kristeva examines the integration of drives into desire structures. But Kristeva's greatest contribution is the formulation of drive operations within the pre-symbolic realm, in what she terms the *chora*. The *chora*, a term borrowed from Plato and meaning 'receptacle', is the realm in which drives proliferate around the maternal body. And crucially for us, these drives are *heteronymous*: "Drives involve pre-Oedipal semiotic functions and energy discharges that connect and orientate the body to the mother. We must emphasise that drives are always already ambiguous, simultaneously assimilating and destructive".<sup>80</sup> Kristeva "is careful to point out that her interest with regard to the Freudian theory of drives lies not in their 'fundamental dichotomy... ' ... but in their heteronymy."<sup>81</sup> The drives are part of one heteronymous whole: they exist as ambiguous simultaneities, occupying a shared position. Furthermore, as in the Lacanian tradition, the drives do not progress organically between each other; they are not part of a teleological chain; they share only topological community. Žižek's suggestion that *drive* is mono-directional and *desire* is multi-directional is dismantled to yield the very opposite paradigm: drives are multidirectional, converging on a single point of desire as a 'compromise formation'. In the *chora*, Kristeva, perhaps clearer than her predecessors, posits drives as spatial pluralities, a synchronic mass, become separated only in becoming diachronic, a process by which they lose connection to *the Real*.

A musical corollary to this can be indicated through a fresh look at Skryabin's most publicised sonority – *the mystic chord*, often termed *the Prometheus chord* or simply *the Skryabin chord*. Brought to light after its use in *Prometheus*, it surfaces in most of Skryabin's late miniatures. Like Wagner's *Tristan chord* or Stravinsky's *Petruschka chord*, this enigmatic sonority attracts great analytical scrutiny, yielding countless interpretations. It is variously described as a pseudo-octatonic complex,<sup>82</sup> a *dominant* structure,<sup>83</sup> or a

<sup>79</sup> Julia Kristeva, *Revolution in Poetic Language* (New York: Columbia University Press, 1984), 131.

<sup>80</sup> *Ibid.*, 27.

<sup>81</sup> John Lechte and Maria Margaroni, *Julia Kristeva: Live Theory* (London; New York: Continuum, 2004), 21.

<sup>82</sup> Perle, 'Scriabin's Self Analyses'.

<sup>83</sup> Sabbagh, *The Development of Harmony in Scriabin's Works*, 30.



hybrid of whole-tone and octatonic material,<sup>84</sup> to name only the principal explanations. Skryabin's own analysis was hardly illuminating; he claimed, "this is not a dominant chord but a basic chord".<sup>85</sup> It is important that this additional analysis must not be regarded as an end in-itself; the chord is viewed as a mere *dispositif*, 'latched onto' by Skryabin's earliest commentators, existing only as a 'compromise-formation' that blocks access to a detailed study of the intricate harmonic principles which the chord merely exemplifies. This analysis provides a basis for a much freer examination of Skryabin's wider harmonic practice; in dismantling the chord I embrace a more expansive harmonic universe in which 'polytonal' drives threaten to pull vertical segments of the chord in various temporal directions simultaneously. This is precisely how Kristeva views the human subject's unconscious drive mechanisms, as heteronomous drives within the *chora*.

The chord complex can be understood as a 'polytonal' network containing at least two dominant seventh structures, embodying drives in divergent keys. Reviewing its most conventional manifestation – with C as the *fundamental bass* – two accidentals are featured – F# and Bb.



FIG 1-15: THE MYSTIC CHORD

These pitches are tonally suggestive, reaching out of C major into its dominant and subdominant regions.<sup>86</sup> Along a *line of fifths* they present the first potential deviations from the major scale:

F# | B - E - A - D - G - C - F | Bb

FIG 1-16: THE PODHALEAN MODE

A recent article by Ann McNamee examines 'bitonality' in Szymanowski's Op. 50 Mazurkas, revealing the *Podhalean-mode* – a Polish folk-scale comprising identical pitches to the *mystic chord* – a modified C scale (C-D-E-F#-G-A-Bb).<sup>87</sup> McNamee demonstrates that Szymanowski's 'bitonal' music is constructed around the potential for cycles of fifths contained within this scale, commenting how "it is remarkable

<sup>84</sup> Jay Reise, 'Late Scriabin: Some Principles Behind the Style', *19th Century Music* 6/3 (1983), 34.

<sup>85</sup> Sabbagh, *The Development of Harmony in Scriabin's Works*, 70.

<sup>86</sup> David Temperley, 'The Line of Fifths', *Music Analysis* 19/3 (2000). Temperley's article allows for an infinite chain of fifths which are enharmonically ordered as a line rather than the more traditional circle. Given Skryabin's late style of complex enharmonic orthography which moves into very remote enharmonic regions, the line perhaps best characterises Skryabin's approach rather than the circle. See Perle, 'Scriabin's Self Analyses'.

<sup>87</sup> Ann McNamee, 'Bitonality: Mode and Interval in the Music of Karol Szymanowski', *Journal of Music Theory* 29 (1985).

that neither pitch serves to stabilize the tonic; rather, harmonic support shifts to V and IV”.<sup>88</sup> This affords a refreshingly conservative environment in which to analyse Skryabin’s music amid the climate of analytical focus on the whole-tone and octatonic collections in his ‘atonal’ music. Skryabin’s chord, which omits some of these *Podhalean* notes, is poised between two dominant seventh structures that reach towards the subdominant and the dominant via a C<sup>7</sup> chord (leading to an F triad) and a D<sup>7</sup> chord (leading to a G triad).

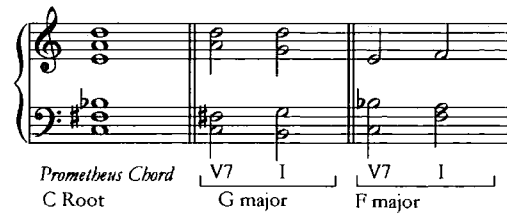

FIG 1-17: BREAKDOWN OF THE MYSTIC (PROMETHEUS) CHORD

This inner tension certainly craves dualist interpretations. Particularly apposite then is Daniel Harrison’s Neo-Riemannian functional outlook, where the dominant and the subdominant are viewed as bifurcations of the tonic function, which will be relevant to Chapters 2-4.<sup>89</sup>

I use the term ‘drive’ to describe these conflicting dominant seventh structures because these small units, full of potential, are divorced from *Classical* or *Romantic* style. And because they conflict simultaneously one cannot build up the expectation of (and desire for) a single tonal object – a tonic key –, rather, they heteronomously reach in various directions. And this is the difference between Skryabin and his immediate predecessors. Wagner’s epic meditation on the nature of desire – *Tristan and Isolde* – contains chords which spiral around the tonic, constantly pointing to but forever avoiding it. This is essentially a temporal process, a celebration of Anthony Newcomb’s “wandering tonality – recitative secco” style, experienced as linear detours.<sup>90</sup> Subscribing to the popular view of the *Tristan chord* as a *French Sixth*, accented through appoggiaturas, the opening bars of *Tristan* indicate a tonic of

<sup>88</sup> Ibid., 64. Szymanowski was certainly influenced by Skryabin (particularly his early works). See Downes’ comments that “Szymanowski used to pore over the details of the piano writing in Scriabin’s early piano works and the similarities between the two composers extend to large-scale structural issues which reflect important heroic-mythological topics” (Stephen Downes, *Szymanowski, Eroticism and the Voices of Mythology* (Ashgate: RMA, 2003), 23). Also see Jim Samson’s comparisons, reinforcing similarities between the early etudes of the two composers: Jim Samson, *The Music of Szymanowski* (London: Kahn & Averill, 1980), 29. Samson also discusses the Podhalean mode in relation to Szymanowski’s ‘Stabat Mater’ (203). Interestingly enough, Tarasti compares later Szymanowski to later Skryabin, citing the second movement of *Mythes*: Eero Tarasti, *Myth and Music: A Semiotic Approach to the Aesthetics of Myth in Music, Especially That of Wagner, Sibelius and Stravinsky* (Mouton, 1979). Downes himself discusses this piece’s relationship with psychoanalysis – its title being *Narcissus*, Stephen Downes, ‘Szymanowski and Narcissism’, *Journal of the Royal Musical Association* 121/1 (1996). The piece does in fact open with a reordered *mystic chord* that outlines the pitches A, B, D#, G, C#, F#.

<sup>89</sup> Daniel Harrison, ‘Bitonality, Pentatonicism, and Diatonicism in a Work by Milhaud’, in *Music Theory in Concept and Practice*, ed. James Baker (Rochester, NY: University of Rochester Press, 1997); Harrison, *Harmonic Function in Chromatic Music: A Renewed Dualist Theory and an Account of Its Precedents*.

<sup>90</sup> Anthony Newcomb, ‘The Birth of Music out of the Spirit of Drama: An Essay in Wagnerian Formal Analysis’, *19th-Century Music* 5/1 (1981), 50.

A.<sup>91</sup> This is sequentially stated in a string of different keys; and this is how desire is mapped in the work, perpetually rerouting the drive through different signifiers. Whilst keys – as objects – change, the desiring process remains. In Skryabin's harmonic motion however, multiple *potential* drives exert force by pulsating simultaneously. Thus drives are a form of polytonality. This is a characteristically Russian, both in compositional technique and analytical methodology. One naturally remembers Stravinsky's *Petruschka Chord*, originally interpreted as bitonal through simultaneous articulation of C and F# triads. This view is refuted by Arthur Berger who subsumed the two triads within the octatonic scale (collection III).<sup>92</sup> Despite the term polytonality's chequered history (which will be explored in Chapter 3), it appears in numerous guises in Soviet analysis, particularly in the writings of three commentators relevant to this analysis. Boleslav Yavorsky – Skryabin's earliest analyst – conceived of 'dual modality', a theory that was adapted in the 1960s by Varvara Dernova;<sup>93</sup> Viktor Belyayev also offered a recent neo-Riemannian functional analysis of *The Poem of Ecstasy* often applying the *T*, *S* and *D* functions simultaneously.

But to claim that Skryabin's late sonorities are ambiguous and chaotic is misleading. Despite their pre-symbolic ambivalence, the *chora's* drives are certainly 'ordered' for Kristeva:

the *chora* is nevertheless subject to a regulating process [*réglementation*], which is different from that of symbolic law but nevertheless effectuates discontinuities by temporarily articulating them and then starting over, again and again.<sup>94</sup>

And the mother's body that increasingly *orders the drives* in Kristeva's system activates this 'regulating process' through the opposition of drive activity and stasis.

[T]he drives, which are 'energy' charges as well as 'psychical' marks, articulate what we call a *chora*: a nonexpressive totality formed by the drives and their stases in a motility that is as full of movement as it is regulated."<sup>95</sup>

Kristeva calls the *chora* the realm of the 'semiotic' which is akin to the Lacanian 'Real', as opposed to the 'Symbolic Order', which Kristeva simply terms the 'symbolic'. Kristeva takes pains to show that the *chora* is not a 'position' that can be represented.

Although the *chora* can be designated and regulated, it can never be definitely posited: as a result, one can situate the *chora* and, if necessary lend it a topology, but one can never give it axiomatic form.<sup>96</sup>

---

<sup>91</sup> This is a particularly Anglo-American interpretation held by Piston (1970) and Goldman (1965), as discussed by Nattiez: Jean-Jacques Nattiez, 'The Concepts of Plot and Seriation Process in Music Analysis', *Music Analysis* 4/1/2 (1985), 107-118.

<sup>92</sup> Arthur Berger, 'Problems of Pitch Organization in Stravinsky', *Perspectives of New Music* 2/1 (1963).

<sup>93</sup> Dernova, *Garmonii Skriabina*; B. M. Belyayev, *Musorgskii, Skryabin, Stravinskii* (Moskva: Izdatel'stvo "Muzyka", 1972).

<sup>94</sup> Kristeva, *Revolution in Poetic Language*, 26.

<sup>95</sup> *Ibid.*, 25.

Based on English psychologist Winnicott’s concept of ‘transitional space’, the *chora* is always an impossible position because it dialectically mediates the ‘semiotic’ and ‘symbolic’.<sup>97</sup> This is achieved through the *thetic phase* where the subject’s *ego* emerges as it enters symbolisation. There are two fundamental drives which orientate the subject in Kristeva’s model: the *life-drive* and the *death-drive*: Freud’s *Eros* and *Thanatos*. These two drives conflict in the *chora*; the life drive moves towards the *thetic* phase, desire, and symbolisation, whilst the death drive aggressively demands drive stasis. Here Skryabin’s music becomes crucial. In Skryabin’s late harmonic language, our attention is focussed on these drives. In Skryabin’s last compositions the drives proliferate and refuse sublimation; he depicts the *chora* itself – *as an impossible position*. Nonetheless, as Kristeva shows, the drives are regulated between the *semiotic* and the *symbolic* realms. In order to illustrate the inscription of this principle in musical material, I now examine how the *mystic chord*, as a harmony, can unfold its drive elements in a temporal frame.

Returning to Skryabin’s late Poem, Op. 71, no. 2 – shown in figure 1-18 – the following graph of the opening measures sketches the most salient drives in ossia above and below the actual pitch graph.

The figure displays a musical score for the opening measures of Skryabin's Poem, Op. 71, no. 2. It consists of three systems of notation. The top system shows the original notation with notes and accidentals, with labels G, A, G, and Bb above the staff. The middle system shows the same notation with five vertical boxes labeled 1 through 6, each containing a simplified chord diagram. The bottom system shows a graph of the chord diagrams, with notes and accidentals (F, G, F, C) and a final chord diagram labeled C#.

FIGURE 1-18: POTENTIAL DRIVE DISCHARGES IN POEM, OP. 71, NO. 2, MM. 1-5

<sup>96</sup> Ibid., 26.

<sup>97</sup> I use the term ‘mediate’ but it must be understood that there is debate about whether the ‘motility’ between the two realms in Kristeva’s model is as ‘dialectic’ as she claims; some see Kristeva’s paradigm as a simple duality. Maria Margaroni gives a comprehensive description of various viewpoints; see Lechte and Margaroni, *Julia Kristeva: Live Theory*, 15. Winnicott is discussed in correspondence between Kristeva and Catherine Clément: Julia Kristeva & Catherine Clément, *The Feminine and the Sacred* (Basingstoke: Palgrave, 2001), 38.

This underscores the potential cadential discharges that the drives imply – the potential drives are graphically separated from the whole sonority. In the opening measure the *mystic chord* is turned ‘upside down’ – the D<sup>7</sup> lurks in the lower region rather than the upper. Thus a drive towards G is shown in the upper stave and a drive towards F in the lower. The following measure departs from the *mystic* sonority itself, widening the field in three directions: A, C# and G. The tritone relationship between G and C# indicated here enjoys prominence as the piece unfolds.

My interpretation of the *mystic chord* as a compound of dominant seventh drives is supported in m. 4 where the C<sup>7</sup> and D<sup>7</sup> implications come to fruition as Skryabin initiates simultaneous F<sup>7</sup> and a G<sup>7</sup> chords. This follows a ‘drive-exchange’ analogous to the Schenkerian ‘voice-exchange’ in m. 3, as illustrated:

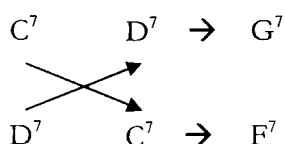

FIGURE 1-19: BITONAL VOICE-EXCHANGE & DOUBLE CADENCE

These new chords are dominants in themselves and extend the tonal boundary further to C and B $\flat$ . The drives are articulated temporally through phrases like this, in which emphasis constantly shifts. Each drive moves one ‘notch’ along the fifths cycle before returning to its origin. Thus they enter the ‘thetic phase’ with motility between a ‘semiotic’ realm of drives and their ‘symbolic’ retranslation as segments of a syntactical ‘fifths’ chain.

What happens next in this piece becomes rather complex, and in order to prepare us to follow the fortunes of these drives in such a late piece requires field-work in an earlier piece where Skryabin plots a typical move from what I would call a ‘drive-based’ economy towards a ‘desire-based’ economy as an act of sublimation.

### Sublimation versus Libidinal Intensity: Examination of the Middle to Late transition – *Poem, Op. 71, no. 2* and *Etude, Op. 56, no. 4*

I turn now to investigate two ways in which drives can be ordered; these two trends correspond to two complete Skryabin pieces from 1908 and 1914. In *Etude, Op. 56, no. 4* the drives are contained by a narrative framework that transforms them from extreme proliferation and tonal diffusion into pure triadic structures and tonal clarity. This trajectory is hardly novel; Skryabin’s earliest *Chopinesque* preludes tend to open ‘off centre’ in indefinite or unrelated keys. At the very least they begin with the dominant chord as in *Prelude, Op. 11, no. 5* (fig.1-7); cadence points are usually incompletely indicated

at phrase endings or deferred until the closing gesture. The kind of developmental progress implied by the increased clarification which cadences afford is often more associated with Scriabin's developing melodies, which have programmatic overtones for some commentators: Herbert Antcliffe finds in *Prometheus*, Op. 60 that, "the music becomes clearer with a 'contemplative' melody and a little later a joyous figure which suggests the first full consciousness of life."<sup>98</sup> This same clarification process finds its way into Scriabin's harmony, showing that the late *polytonal* drive-based search for a *single* tonal centre follows his early schemes.

1 **Presto** (1908)

pp 3

5

8

11

14

cresc.

dim.

3

<sup>98</sup> Herbert Antcliffe, 'The Significance of Scriabin', *The Musical Quarterly* 10/3 (1924), 343.



FIGURE 1-20: ETUDE, OP. 56, NO. 4

Before examining the piece's polytonal drives, let us take a brief snapshot of the bass structure, plotting it on a Riemannian *Tonnetz* – a spatio-temporal framework that charts the tonal space that Skryabin navigates. It must be noted that this bass structure underpins clear dominant drives in each case.

Riemann's *Tonnetz* proves particularly pertinent to Skryabin's music as it facilitates navigation through minor thirds and tritone relations (diagonally rising axis – right to left), major thirds (diagonal axis – left to right) as well as perfect fifths (running purely horizontally on the *Tonnetz*).<sup>99</sup>

<sup>99</sup> The *Tonnetz* is used here merely to plot the bass structure. David Lewin's methods of analysing tonal transformation using the *Tonnetz* is very different and will be more relevant to our later discussion of the *Tenth Sonata* in a later chapter.

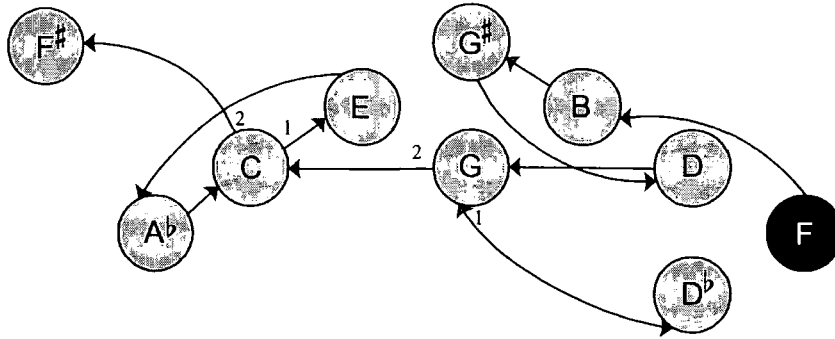

FIGURE 1-21: ETUDE, OP. 56, NO. 4, MM. 1-9

(navigation begins on the pitch F, coloured black; numbers lead a path through repeated drives)

The piece initially forges a minor third path between F and G#, outlining a diminished seventh chord. The pitch D, which is the last note of this outline, bridges the other side of the *Tonnetz*, opening tonal space to a pseudo-perfect cadence on G. As the G is initiated, Skryabin plays with a tritone-related D#, toggling between the two chords before traversing the horizontal line of fifths to C – a pure chord, heard in first inversion in m. 8. After transposed material, Skryabin recapitulates the opening at m. 13, shown in fig 1-22.

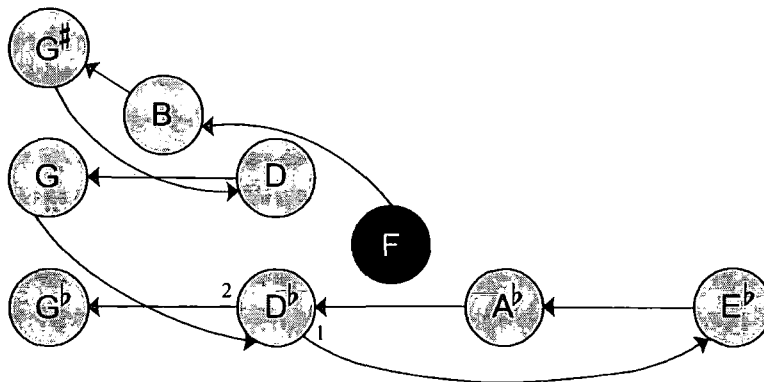

FIGURE 1-22: ETUDE, OP. 56, NO. 4, MM. 13 FF

As Skryabin alights upon the G, this time, rather than continue along the fifths axis to C, he slips towards D# and offers a clear line of fifths on the D#'s axis, reaching back to an E# before rebuilding a path to G# as the piece concludes. Throughout the piece Skryabin plays with diatonic V-I gestures at phrase-ends, using them to demarcate sections; such gestures become increasingly protracted, leading to the concluding perfect cadence. The *Tonnetz* has provided a simple background model, highlighting Skryabin's large-scale bass manoeuvre from fragmented tritone motion towards 'sublimated' perfect fifth motion along the chain of fifths. In this piece then, evanescent moments of sublimation pull drives back and forth between a 'semiotic' world of drives and a 'symbolic' world of desire. This phase is known to advocates of Kristeva as the *thetic break*, when a consciousness experiences motility



between the two worlds, moving towards full emersion in the Symbolic Order that increasingly takes hold.

Now, tightening focus around individual drives, I explore how this tonal plan communicates with the many drives on the musical surface. The *mystic* chord features in m. 1, but mm. 2-3 exposes its innate bitonal drives more clearly. Here, the classic *mystic* structure that opened Poem, Op. 71, no. 2 is replete with clear cadencing. The tritone – E/B $\flat$  – resolves conventionally to pitches F and A in the upper tessitura, forming a pseudo-cadence in F. Yet the lower part outlines a dominant seventh on D progressing to a G, as shown on fig.1-21. Thus dominant  $\rightarrow$  tonic discharges erupt in two keys, separated by a whole-tone interval. This cadence lays the foundation for an exploration of Skryabin’s polytonal drives, but now we must dig deeper and explore the drives which proliferate in the score, but are not sublimated in such a fashion.

Fig. 1-23 plots these drives in a map of the piece. The dark squares on the grid denote drives that I believe operate, whilst the light squares represent the potential tonic resolutions they could imply. The graph reads from left to right like a musical score; measure numbers are indicated above the graph to show the passage of time along the x-axis, whilst tonal centres are charted as a line of fifths on the y-axis.

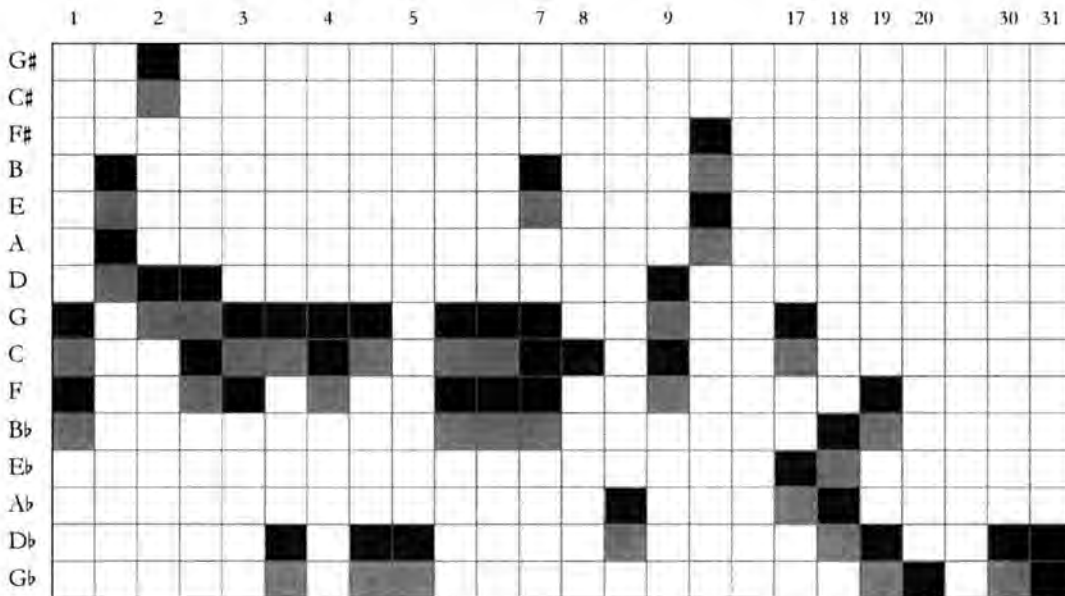

FIGURE 1-23: ETUDE, OP. 56, NO. 4 – DRIVE ANALYSIS

This diagram serves various uses and will be extended and developed in following chapters. Here it elucidates one of Skryabin’s most crucial procedures: the emergence and sublimation of a tension

between whole-tone bitonality and tritone bitonality. Further, this dichotomy reinforces the sublimation of diversity into clarity (drive to desire) that was revealed in the crude bass diagram.

In m. 1 the initial *mystic* chord indicates the keys of C and B $\flat$  (implied by G $^7$  and F $^7$  drives).<sup>100</sup> Skryabin immediately shuttles to the F's tritone relative – B $^7$  – and the G's whole-tone partner – A $^7$  – indicating the keys of E and D. Already an intimate relationship blossoms between tritonal and whole-tonal drives. One essential connection is the shared tritone between the two chords of F $^7$  (A-E $\flat$ ) and B $^7$  (A-D $\sharp$ ). These first two chords expose the link before whole-tone drive pairs alternate with tritone pairs in m. 2; the enharmonically respelled D $^7$  and G $\sharp^7$  indicate the tritonally related keys of G and C $\sharp$ . This dichotomy becomes clearest in mm. 3-8 when polarities intensify between G $^7$  and D $\flat^7$  in mm. 3-5 and between G $^7$  and F $^7$  in mm. 5-8. The G $^7$  element becomes the fixed point around which its whole-tone and tritonal drives rotate, its prominence confirmed in a perfect cadence in C major in m. 8, the first pure triad. Skryabin has shaped multifarious drives towards a specific object of tonal desire; the strongest drive has succeeded over the weaker ones – it is sublimated.

And yet the drives surrounding this G – the 'repressed' drives – are not forgotten; their energy continues to pulsate beneath the surface. In the second half of the piece a new G and D $\flat$  drama is enacted. Scanning ahead to the final measure, a pseudo-cadence in G $\flat$  is positioned with the D $\flat^7$  simultaneously preserved. This chord embodies the outcome of the drive conflict: the presence of chord V with chord I synchronically betrays a prolongation of desire, which is retained through the moment the discharge.

Skryabin's climax-building techniques also prove analytically rewarding. The chord of G became a focal point from m. 3 as fig.1-21 exposed. Incidentally, this is emphasised by an extended *Tonnetz* embracing mm. 1-13, where G becomes a hive of activity, the drive has three entry points.

---

<sup>100</sup> I interpret the opening thus, despite the lack of the pitch G because the chord in fact behaves as an 'upside down' *mystic* chord on G rather than F; we find this chord in its more 'authentic' position in m. 4. A G $^7$  drive is also present throughout much of the opening phrase.

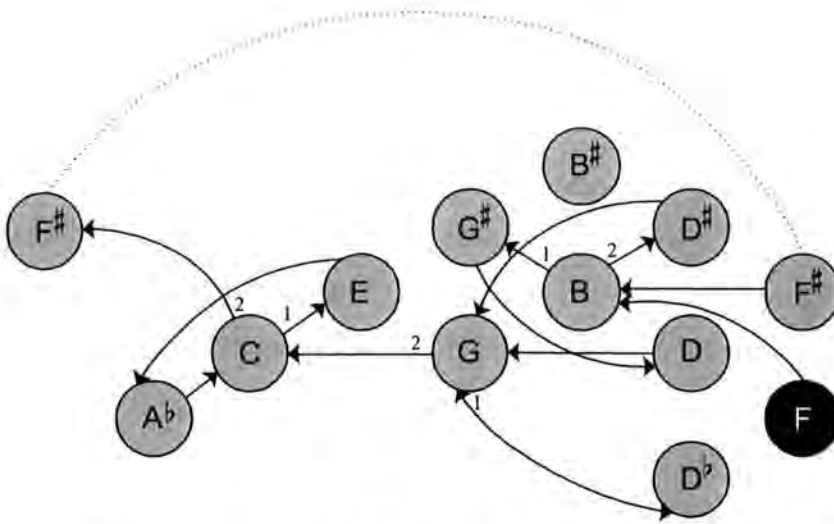

FIGURE 1-24: ETUDE, OP. 56, NO. 4, MM. 1-13 (beginning on F; ending on G)

Additionally, the G briefly moved to D $\flat$  for no apparent reason, before continuing in fifths to C, leaving the D $\flat$  alienated. In the recapitulation at m. 13, the G-D $\flat$  manoeuvre now becomes significant when the D $\flat$  is reconstituted as a solid link in an extended chain of fifths. On the drive diagram (fig. 1-23) an attractive pattern emerges: a cycle of fifths moves symmetrically in contrary motion. The E $\flat$  in the bass moves A $\flat$   $\rightarrow$  D $\flat$   $\rightarrow$  G $\flat$  whilst weaker drives in the upper voices move E $\flat$   $\rightarrow$  B $\flat$   $\rightarrow$  F. If it continued its trajectory, the upper voice would have met the G $\flat$  chord with a C chord – its tritone relation. But instead, Skryabin ends with a perfect cadence in G $\flat$ . As in psychoanalytical models, drive motions function simultaneously though they break apart and lose their heteronymy as they become sublimated.

In summary then, Skryabin has shaped primitive drive mechanisms into a teleological discourse in which the listener focuses on (and desires) a specific key through a chain of fifths. This piece was composed in 1908 when Skryabin's music mapped attempts to evolve and shape diverse drive-based chromatic music towards ever-developing desire-based tonal clarity. Careful examination of Skryabin's writings in later chapters will crystallise this psychoanalytic interpretation. Looking forwards to Poem, Op. 71, no. 2 shows how Skryabin's late style embraced the opposite aesthetic. A drive-based form of tensile motion is established but, rather than sublimate it into a desire-based mechanism based on a tonic chord, Skryabin increased the drive's authority, and he never attempts to breach its intricate network. Kristeva showed that drives tentatively discharge as *thetic* motility between the 'semiotic' and 'symbolic' (drive and desire) but Skryabin never attempts this *thetic break*.

En rêvant, avec une grande douceur

The musical score is presented in two systems, each with a grand staff (treble and bass clefs). The key signature is one flat (B-flat major or D minor), and the time signature is 3/4. The piece begins with a piano (*p*) dynamic and a tempo marking of "En rêvant, avec une grande douceur". The first system (measures 1-8) features a melodic line in the right hand with trills and slurs, and a bass line with triplets and slurs. Dynamics include *p* and *dim.*. The second system (measures 9-18) continues the melodic and bass lines, with dynamics ranging from *pp* to *mf* and *f*. Performance instructions include "avec enthousiasme" and "cresc.". The score includes various musical notations such as slurs, trills, triplets, and dynamic markings.

FIGURE 1-25: POEM, OP. 71, NO. 2, MM. 1-18

Relative stability, created by bitonal cadencing in the opening measures of Op. 71, no. 2, is shattered by the intense profusion of polytonal drives reaching out to various tonal regions. A cursory look at a *Tonnetz* charting the bass motion reveals that Skryabin exclusively articulates a diminished chord – F, D, B, G# – precluding desire-based ‘fifths’ motion.

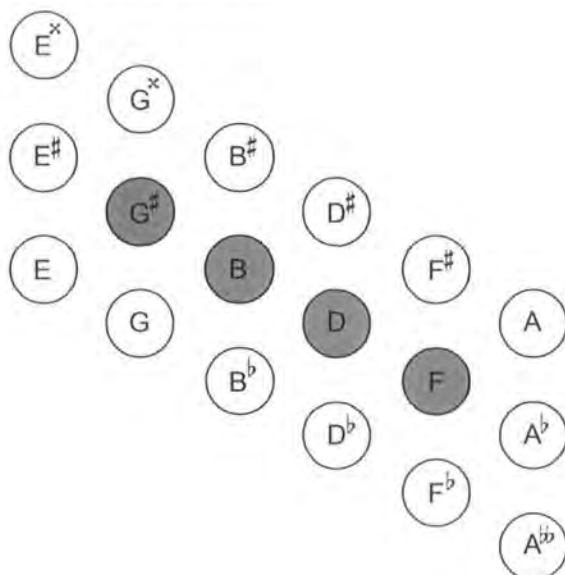

FIGURE 1-26: POEM, OP. 71, NO. 2 - BASS DIAGRAM

To appreciate Skryabin’s careful control of drive energy, a more specific diagram is required. Fig. 1-27 reveals an almost total saturation of drive energy at its mid-point (from which the remainder of the piece is a t6 transposition), where the diverse drives that feature in the piece return in mm. 16 to 18.

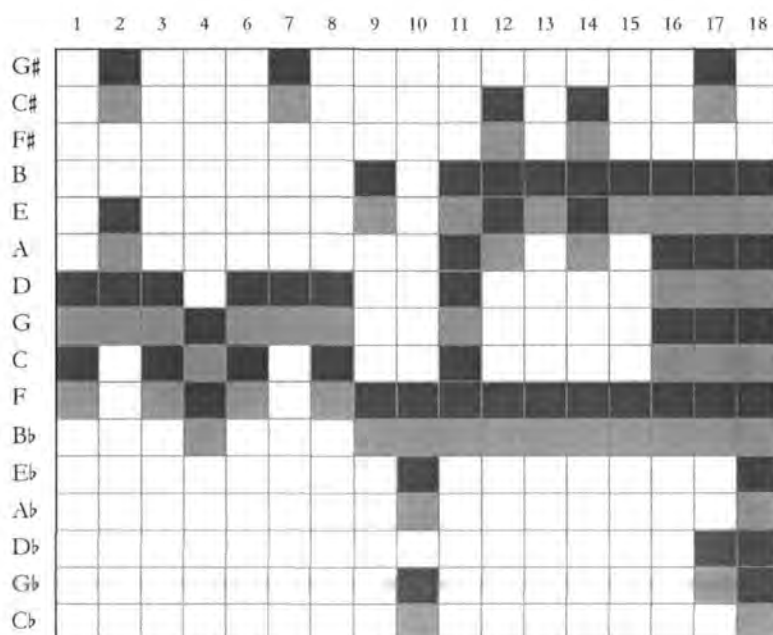

FIGURE 1-27: POEM, OP. 72, NO. 1, DRIVE ANALYSIS

The reason that Kristeva's work is so relevant to this analysis is that her *chora* is a structure which is repressed but which remains active beneath the 'text', occasionally breaking through the symbolic surface to remind us of what lies beneath. This finds numerous philosophical expressions: Freud would call it 'the return of the repressed'; Lacan – 'the return of The Real'; Adorno – '*Durchbruch*'.<sup>101</sup>

Of course similar procedures surface in the earlier, Op. 56 Etude; there is the same alternation of whole-tone and tritonal drives, there is the same vertical exploitation of the shared tritone of two dominant sevenths; there are similar chord complexes and bitonal discharges early in the piece. But what is missing is an underlying teleological diatonic motion towards a single object of desire. And this is universally true of Skryabin's late pieces; Skryabin removes the drives from dialectical desire formations, allowing them to form a *chora*-like state, regulated through alternations of stasis and motion that would attempt to project the listening subject into the 'Symbolic Order' of tonal grammar. Yet Skryabin does not allow this journey to be made.

### Skryabin's Philosophy of Drive and Desire

As supplement to Skryabin's direct musical confrontation with 'the drive', there is a wealth of accounts of its activities in his writings, showing that such musical processes are far from accidental. Skryabin's claim to be a philosopher as well as a composer was undoubtedly pretentious, nevertheless, his diaries reveal a sound comprehension of the philosophical literature, inviting and confirming psychological readings of his musical material. One entry declares, "Most of my musical poems have a specific psychological content, but not all of them need programme notes."<sup>102</sup> See also Skryabin's proud boast that his Third Symphony was the first exposition of his 'new doctrine'.<sup>103</sup> Although Skryabin was Freud's contemporary, there is no record that he accessed Freud's theories directly.<sup>104</sup> But paraphrases of experimental psychologist Wilhelm Wundt in Skryabin's notebooks certainly attest to his general

---

<sup>101</sup> *Durchbruch* generally translates as 'breakthrough', which Michael Spitzer defines as "an influx of reality"; Michael Spitzer, *Music as Philosophy: Adorno and Beethoven's Late Style* (Bloomington, Indiana: Indiana University Press, 2006), 21.

<sup>102</sup> Faubion Bowers, *The New Scriabin: Enigma and Answers* (London: David & Charles, 1974), 108.

<sup>103</sup> In a letter to Margarita Morozova, dated 20th March 1905, Skryabin referred to "the first public proclamation of my new doctrine". Bowers, *Scriabin: A Biography* 2, 41.

<sup>104</sup> Freud became seriously recognised in Russia through Dr. Nikolai Osipov who wrote the first exposé of Freud's work in 1908. But Freud was certainly read before this. His *Interpretation of Dreams* was translated as early as 1904. By 1909 Osipov and his colleague N.A. Vryubov worked on a new journal "Psychotherapy" and set to work publishing a Russian 'Psychotherapeutic Library' containing up-to-date translations of Freud, including translations of his *Lectures* and *Three Essays on Sexuality*. Through the labours of these men, Russian became the first translated language of Freud's collected works. Russians such as L. Drosnes, S. Spelrein, M. Wolff and T. Rosenthal were known to have attended Freud's psychological meetings at his home in Vienna. By 1910, a group was conceived which was explicitly modelled Freud's Viennese circle. Martin A. Miller, *Freud and the Bolsheviks: Psychoanalysis in Imperial Russia and the Soviet Union* (New Haven: Yale University Press, 1998), 24-34.

interest in psychology.<sup>105</sup> But in an idiosyncratic way, Skryabin synthesised psychoanalytical terminology with mystical cosmology into a ‘world history’. The result was a kind of *Panpsychism*:

The universal consciousness in a state of activity appears as a personality, one enormous organism which at any moment experiences a new stage of process called evolution. (At this basis lies the desire for absolute bliss. Life is an urge.)<sup>106</sup>

The universe is an unconscious process. Part of it is accepted by me as an illumination of my consciousness.<sup>107</sup>

Deferring a thorough treatment of this concept until Chapter 6, I focus here on Skryabin’s terminology. His writings contain descriptions of quantities of ‘tension’ that are essentially ‘drives’ under different names. For instance, he talks of ‘palpitations’ and ‘surges’ that motivate the world:

I begin my story. It is the story of the world – of the universe. I am, and there is nothing outside of me. I am nothing. I am all. I am one, and within me is multiplicity. I wish to live. I am life’s palpitation. I am desire. I am a dream... Desires in me are vague, and dreams dim. I do not yet know how to create you. I only know that I wish [desire] to create. I create already. The desire to create is creation ... Life is activity, striving, struggle... Oh life. Oh creative surge. Oh all-creating desire.<sup>108</sup>

From a Freudian standpoint, the word ‘desire’ would be better rendered as ‘drive’, but this psychoanalytic distinction did not exist. Faubion Bowers, Skryabin’s most thorough biographer, comments crucially that one could “translate Skryabin’s words ‘wish’ and ‘desire’ into ‘drives’”.<sup>109</sup> Skryabin was left to his own devices to make this difference understood. A close reading of Skryabin’s nomenclature clarifies that Skryabin focuses on material ‘drive’ energy rather than Lacanian dialectical ‘desire’. He variously describes ‘drive’ processes as a ‘surge’ or ‘urge’ (“Oh life, Oh creative Surge (wish [desire])! / All-creating urge”),<sup>110</sup> as a ‘pulsation’ (“Something began to glimmer and pulsate and this *something was one*”),<sup>111</sup> as ‘energy’ (“absolute unity ... will to live, desire to live, desire for the other, the new, ENERGY”),<sup>112</sup> or as ‘impulse’ (“An impulse disturbs celestial harmony”).<sup>113</sup> Like Freud, Skryabin drew on Schopenhauer’s *Will*<sup>114</sup> (“The Spirit ... creates its own World by its own creative Will”).<sup>115</sup>

---

<sup>105</sup> Even as early as 1904, Skryabin’s wife Vera records “Sasha reads a lot of philosophy and psychology and thinks all the while of his future compositions.” Bowers, *Scriabin: A Biography* 2, 72.

<sup>106</sup> *Ibid.*, 104.

<sup>107</sup> *Ibid.*

<sup>108</sup> *Ibid.*, 54. In the Russian language, the word ‘desire’ and ‘wish’ are identical: *Zhelanye*. Although it has not been possible to ascertain at this stage which word Skryabin uses in each of Bowers’ translations, Skryabin certainly uses *Zhelanye* in his wider writings. See Mitchell Bryan Morris, *Musical Eroticism and the Transcendent Strain: The Works of Alexander Skryabin, 1898-1908* (PhD Berkeley: University of California, 1998), n.72.

<sup>109</sup> Bowers, *Scriabin: A Biography* 2, 68.

<sup>110</sup> *Ibid.*, 62.

<sup>111</sup> *Ibid.*, 60.

<sup>112</sup> *Ibid.*, 68.

<sup>113</sup> *Ibid.*, 62.

<sup>114</sup> Gupta shows that Freud, whilst ignorant of Schopenhauer’s ideas at first, eventually found similarities between the *World as Will and Idea* and his own drive theory: R. K. Gupta, ‘Freud and Schopenhauer’, *Journal of the History of Ideas* 36/4 (1975).

Following Schopenhauer's example, Skryabin transforms the Kantian *thing in itself* into a mobile motivating force:

Being as a whole wishes [desires] to be ... Being is the will to live.<sup>116</sup> ...

Being is not something separate from the desire for life. It is the very same desire but objectified. Wish [desire] is the inner aspect of being.

The nature of life (action) is the desire for the other, the *one*, and *nothing else*. The consequence of desiring (experience) creates time. Action is the surge or lift of life. Surge (activity) in the highest degree is ecstasy. Absolute being is ecstasy... Ecstasy is the highest rising of activity.<sup>117</sup>

Here we also find the Lacanian concept of *jouissance* that Skryabin terms 'ecstasy'. In Lacan, such *jouissance* erupts when the drive short-circuits desire and releases its energy. Of course this is the goal – the blazing tonic chords – that Skryabin planned for many works, as will be examined in Chapter 5.

Like Lacan, Skryabin was clear that true desire existed only in dialectical relation to other desires:

When I have no desire, I am nothing; but when I experience a desire, I become the substance of my own yearning. The individual longing gives rise to all other yearnings, because it can exist only in relation to my other desires.<sup>118</sup>

And foreshadowing Lacan's insight that desire "merely seeks to go on desiring", the youthful Skryabin of 1892 grasped that desire was self-perpetuating from his readings of Schopenhauer, who Thomas Mann called "the father of modern psychology", and whose entire system is based on the gulf between "the reason and the instincts".<sup>119</sup>

Sharp desire, voluptuous and crazed yet sweet / Endlessly *with no other goal than longing* [my italics] / I would desire.<sup>120</sup>

See similar comments on the endless cycle of desire in Debussy's writings: "You could write a formula for desire: everything comes from it and returns to it."<sup>121</sup> Crucially, Skryabin focussed on the freedom of the drives' expression, revealing an acceptance that, in the world of *Maya* or representation, truth is ultimately impossible to reach: "If the world is my unique and free act then what is truth? ... Truth and freedom are mutually exclusive."<sup>122</sup> This is to say that Skryabin was, in the final analysis, a solipsistic

---

<sup>115</sup> Faubion Bowers, *Scriabin: A Biography 1* (New York: Dover Publications, 1996), 341.

<sup>116</sup> Bowers, *Scriabin: A Biography 2*, 102.

<sup>117</sup> Bowers, *The New Scriabin: Enigma and Answers*, 117.

<sup>118</sup> Schloezer, *Scriabin: Artist and Mystic*, 204.

<sup>119</sup> Fink, *A Clinical Introduction to Lacanian Psychoanalysis: Theory and Technique*, 51; Thomas Mann, *Thomas Mann Presents the Living Thought of Schopenhauer* (London: Cassel, 1939), 24.

<sup>120</sup> Bowers, *Scriabin: A Biography 2*, 333.

<sup>121</sup> Katherine Bergeron, *Mélisande's Hair*, in Mary Ann Smart, *Siren Songs: Representations of Gender and Sexuality in Opera* (Princeton: Princeton University Press, 2000), 168.

<sup>122</sup> Schloezer, *Scriabin: Artist and Mystic*, 126.



*Idealist*. Instead of searching for the *Ding an sich*, he focussed on the infinity of possibility. The phrase “Divine Play” surges up again and again in Skryabin’s notebooks, ascribed to the creative freedom of the ‘Real’, much as in the late writings of Lacan: “Then all is play – it is a game ... And this play is the highest of real realities.”<sup>123</sup> Skryabin often uses the word ‘real’, as Lacan does, to denote the preternatural world, before the birth of consciousness. “Thus the world is given me as a real, in the ideal sense of the word, unity.”<sup>124</sup> And this freedom of the will is what Skryabin achieves in his music, as perceived by one of his earliest commentators – the Symbolist poet Vyacheslav Ivanov – whose essay *Skryabin’s view of Art* claims:

he [Skryabin] musically re-created the movements of the will, the first timid tremblings and ecstatic delights of celestial spirits bathing in the universal expanses.<sup>125</sup>

Skryabin’s harmonic structure bears this ideology. Pieces such as Etude, Op. 56, no. 4 employ distinct drive formations, which sublimate and blossom as the music unfolds. But in Skryabin’s later pieces drive activity overloads the selection process of desire. In fact even in Skryabin’s earlier works, the tonic is often used to end pieces as an almost arbitrary mechanism for curtailing the drive tension, often without a carefully unfolded sublimation process. Among the most extreme instances is the luminescent F# major chord that concludes *Prometheus*, Op. 60. This grandiose apotheosis is a ‘false’ ending that cannot satisfy the drives that rage beneath the surface, as I further examine in Chapter 7. The same is true in Etude, Op. 56, where numerous drives are sublimated at certain junctures, but only one is selected for conclusion. But Skryabin, in his late style, prefers to leave the drive conflict open. Each drive expresses itself as freely at the end of the piece as at the beginning. Thus the final moment of Poem, Op. 71, no. 2 contains identical drives to the opening, though in a differently spaced chordal sonority:



FIGURE 1-28: FINAL MOMENT OF POEM, OP. 71, NO. 2

In this chapter I have highlighted possibilities for musico-psychoanalytical readings of early 20<sup>th</sup> century harmonic music, illustrating that Skryabin’s idiosyncratic compositional career shifted from a desire-

<sup>123</sup> Bowers, *The New Scriabin: Enigma and Answers*, 118.

<sup>124</sup> Bowers, *Scriabin: A Biography 2*, 102.

<sup>125</sup> Ivanov, *Selected Essays* (Evanston, Ill.: Northwestern University Press, 2003), 223.

based into a drive-based economy. The philosophical reasoning behind this late retreat will be the main focus of Chapters 5 and 7, where I access Skryabin's philosophy in depth. In these chapters I analyse similarities between Skryabin's philosophical writings and my own (post-)structurally inspired readings. But for the moment I have attempted to lay a stable enough Freudian-Lacanian foundation to allow for an exclusive focus on *the music* in Chapter 2. Here, I will utilise contemporary analytical tools to construct a more rigorous methodology for undertaking what I call *drive-analysis*.

## Chapter Two

---

### Towards a Codification of Drive Intensities

Skryabin's music has notoriously resisted attempts to squeeze it into analytical moulds. In what follows, I shall outline an analytical model more adequate to Skryabin's fluid and protean drive processes.

Firstly I build a system of analysing the drives which Skryabin utilises; secondly I illustrate how these drives function in tonal space, which will lead to an examination of how Skryabin's tonal function truly embodies his erotic theory. This second objective will be reserved for Chapters 3 and 4.

Our understanding of chromatic harmony has been greatly enhanced in recent years by approaches such as Neo-Riemannian theory. Of the diverse strands of harmonic theory that have coalesced beneath the Neo-Riemannian umbrella, some suit Skryabin's style better than others. Given that Skryabin's idiosyncratic schemes involve  $t_3$ ,  $t_6$  and  $t_9$  operations – essentially aggregates of the minor third – I have been particularly drawn to the work of Adrian Childs. Childs extends Neo-Riemannian concerns into the remit of seventh chords, and offers a valuable tool for analysing and re-formulating 'voice-leading parsimony'. Especially pertinent is the way his theory examines the relationships of seventh chords within the 'octatonic' collection.<sup>126</sup> In my interpretation of Childs' work, I am less concerned with Skryabin's actual tonal transformations than with theorising how Skryabin's chords *could* potentially discharge their tensions. Childs analyses the flow of semitonally shifting chords; my interest, by contrast, lies in understanding how the tension inherent in each chord propels it to the next – an endeavour which only partially falls within the domain of 'voice-leading parsimony'. Skryabin's harmonies are usually much fuller and richer than the basic seventh chords examined by Childs, and thus require more supple treatment. I see Fred Lerdahl's work on tonal tension and Daniel Harrison's theory of tonal function as offering equally fertile soil. Lerdahl examines the tension that is 'stored up' in individual moments of musical discourse. He provides algorithms for generating relative numerical values for many forms of tonal tension, analysing both melodic and harmonic profiles of tonal and post-tonal repertoires. Lerdahl's own admirable analysis of Skryabin's Prelude, Op. 67, no. 1 operates in 'octatonic pitch space', but I am concerned with tracking the tonal propulsions in a *variety* of tonal pitch-spaces, whether they be *whole-tone*, *octatonic*, *mystic*, *diatonic*, or *chromatic*.<sup>127</sup> I will begin by detailing the distinct spaces which Skryabin navigates, while, crucially, shifting the arena of debate from Lerdahl's cognitivism to the Freudian psychological tradition, by which music enjoys a more visceral relationship to 'the body'.

---

<sup>126</sup> Adrian P. Childs, 'Moving Beyond Neo-Riemannian Triads: Exploring a Transformational Model for Seventh Chords', *Journal of Music Theory* 42/2 (1998), 188.

<sup>127</sup> Lerdahl, *Tonal Pitch Space*, 321-333.

But first, I briefly revise, from Chapter 1, the provisional method of representing the drives graphically. I will now call this *drive analysis*. In such format, the Appendices contain six graphical analyses. The graphs are elementary: the vertical axis plots the line of fifths whilst the horizontal charts the temporal flow of harmonic motion; plain grey squares depict each ‘drive’. In Chapter 1, lightly shaded squares codified the implied tonic associated with each dominant-drive; this is no longer necessary and shall be taken as given. Realised tonics are now represented by squares within squares, and will be displayed in the ‘key to the graphs’ in due course. These graphs highlight drive fluctuations and interactions; they siphon-off the musical surface, allowing us to investigate the patterns that emerge in the residue. The simple  $D \rightarrow T$  discharge is represented by two grey squares moving diagonally downwards from left to right, whilst a  $S \rightarrow T$  motion reaches diagonally upwards.

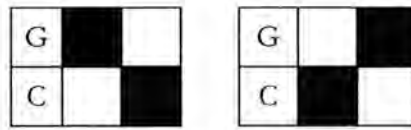

FIGURE 2-1: (a)  $D \rightarrow T$       (b)  $S \rightarrow T$   
 $G \rightarrow C$                        $C \rightarrow G$   
 $V \rightarrow I$                          $IV \rightarrow I$

This much is elementary. The leap that *drive analysis* will take in this chapter is the codified tabulation of drive intensities.

## Drive Intensity

Because drives in the Freudian tradition are based on varying intensities, a drive taxonomy must be hierarchical, showing the various grades of tensile strength inherent in each. For this purpose I turn to Fred Lerdahl’s work. Lerdahl’s project with Jackendoff in the 90s proved a highly influential, but equally problematic method of mapping tonal tension.<sup>129</sup> More fruitfully appealing is his recent work on ‘Tonal Pitch Space’. Lerdahl’s book outlays a fairly closed system, and one would balk at the idea of casually ‘dipping’ into it. Starting from first principles he carefully builds a structural edifice that numerates all conceivable parameters of musical tension within the classical style. But when Lerdahl twists his analyses into the transitional turn of the century, he attempts to hold onto a rising balloon for all it is worth. To this end he proposes cognitive switches in a listener’s mode of perception, switches caused by alternations of tonal space – hypermodulations – between ‘mystic space’, ‘octatonic space’, ‘whole-tone space’, etc. Lerdahl investigates Skryabin’s Prelude, Op. 67, no. 1, showing how the ‘*Mysterium* collection’ is a scale, drawn upon by Skryabin, comprising ‘whole-tone’ and ‘octatonic’

<sup>128</sup> I avail myself of the Riemannian nomenclature *T*, *S* and *D* to refer to Tonic, Subdominant and Dominant functions. However, I italicise these labels to avoid confusion with the pitch D. These may refer to chords, keys or regions, though this will be specified in each case.

<sup>129</sup> Fred Lerdahl and Ray Jackendoff, *A Generative Theory of Tonal Music* (Cambridge: MIT Press, 1983).

spaces. This scale, under procedures of *micromodulation* (transposition by minor thirds or tritones) and *macromodulation* (transposition by any other interval), allows various structural sonorities to work analogously to *T* and *D* functions.<sup>130</sup> But the implication that such spatial shifts are cognisable to a listener is controvertible. ‘New’ types of space were certainly not as well established as the diatonic system was (and still is), and it would seem more likely that ‘mystic’ chords and ‘octatonic’ scales are heard within conventional diatonic space either as a reaction against – or as an expansion of – diatonic expectation. I work on the same premise as Lerdahl, using his algorithms for calculating specific moments of tonal tension, but remove them from the structure with which Lerdahl surrounds them; his balloon is allowed to fly away, but only after an extremely productive game is played with it.

My argument proper begins with my hierarchical taxonomy of Skryabin’s most frequent dominant sonorities; this comprises fig. 2-9. However, to understand the theoretical underpinning of this model a short excursus through Lerdahl’s algorithms for calculating *Harmonic Attraction* may be necessary. In Lerdahl’s formulae for what he labels *Harmonic Attraction*, he utilises two other values: *Chordal Distance* and *Voice Leading Attraction*. These allow us to assess the tension that a chord contains that would drive it onto the next chord.

**Chordal Distance:**  $\delta(x \rightarrow y) = j + k^{131}$

‘Chordal Distance’ ( $\delta$ ) encapsulates the distance between two chordal sonorities ( $x \rightarrow y$ ). The basic procedure is to map each chord onto ‘basic space’. This is a revival of Deutsch and Feroe’s space that registers the appearance of a chord’s pitches at different structural levels: a chromatic level, a diatonic level, a chordal level, a fifth level and a root level.<sup>132</sup>

Octave (root) space:	C											
Fifth space:	C						G					
Chordal space:	C			E			G					
Diatonic space:	C	D	E	F	G	A	B					
Chromatic space:	C	D $\flat$	D	E $\flat$	E	F	F $\sharp$	G	A $\flat$	A	B $\flat$	B

FIGURE 2-2: LERDAHL’S ‘BASIC SPACE’: C MAJOR

But Lerdahl is concerned with pitch classes, as we are, hence:

<sup>130</sup> Lerdahl, *Tonal Pitch Space*, 321-333. In the Skryabin example, Lerdahl focuses on how spaces can ‘merge’ together to form new spaces. Spatial ‘hypermulation’ is discussed earlier the same chapter: “Prolongations in Chromatic Spaces”.

<sup>131</sup> A more complete version of this algorithm is offered which utilises value *i*, but this value, which is only required when chord changes coincide with ‘region’ changes, is redundant:  $i = 0$ .

<sup>132</sup> Lerdahl, *Tonal Pitch Space*, 47.

Octave (root) space:	0											
Fifth space:	0										7	
Chordal space:	0				4						7	
Diatonic space:	0		2		4	5				7	9	11
Chromatic space:	0	1	2	3	4	5	6	7	8	9	10	11

FIGURE 2-3: LERDAHL'S 'BASIC SPACE' IN 'PITCH CLASS' FORM: [0,4,7]

The pitch class difference between chords is calculated as value  $k$  in Lerdahl's equation: " $k$  = the number of distinct pcs in the basic space of  $y$  compared to those in the basic space of  $x$ ."<sup>133</sup> For example, a  $V \rightarrow I$  progression contains four distinct pcs, which are underlined in the second grid.

Chord V	$\rightarrow$	Chord I																																																																																																																																		
<table> <tr><td></td><td></td><td></td><td></td><td></td><td></td><td>7</td><td></td><td></td><td></td><td></td><td></td><td></td></tr> <tr><td></td><td></td><td>2</td><td></td><td></td><td></td><td>7</td><td></td><td></td><td></td><td></td><td></td><td></td></tr> <tr><td></td><td></td><td>2</td><td></td><td></td><td></td><td>7</td><td></td><td></td><td></td><td></td><td></td><td>11</td></tr> <tr><td>0</td><td></td><td>2</td><td></td><td>4</td><td>5</td><td>7</td><td></td><td>9</td><td></td><td></td><td></td><td>11</td></tr> <tr><td>0</td><td>1</td><td>2</td><td>3</td><td>4</td><td>5</td><td>6</td><td>7</td><td>8</td><td>9</td><td>10</td><td>11</td><td></td></tr> </table>							7									2				7									2				7						11	0		2		4	5	7		9				11	0	1	2	3	4	5	6	7	8	9	10	11			<table> <tr><td></td><td></td><td></td><td></td><td></td><td></td><td><u>0</u></td><td></td><td></td><td></td><td></td><td></td><td></td></tr> <tr><td></td><td></td><td></td><td></td><td></td><td></td><td><u>0</u></td><td></td><td></td><td></td><td></td><td></td><td>7</td></tr> <tr><td></td><td></td><td></td><td></td><td></td><td></td><td><u>0</u></td><td></td><td></td><td></td><td></td><td><u>4</u></td><td>7</td></tr> <tr><td>0</td><td></td><td>2</td><td></td><td>4</td><td>5</td><td>7</td><td></td><td>9</td><td></td><td></td><td></td><td>11</td></tr> <tr><td>0</td><td>1</td><td>2</td><td>3</td><td>4</td><td>5</td><td>6</td><td>7</td><td>8</td><td>9</td><td>10</td><td>11</td><td></td></tr> </table>							<u>0</u>													<u>0</u>						7							<u>0</u>					<u>4</u>	7	0		2		4	5	7		9				11	0	1	2	3	4	5	6	7	8	9	10	11	
						7																																																																																																																														
		2				7																																																																																																																														
		2				7						11																																																																																																																								
0		2		4	5	7		9				11																																																																																																																								
0	1	2	3	4	5	6	7	8	9	10	11																																																																																																																									
						<u>0</u>																																																																																																																														
						<u>0</u>						7																																																																																																																								
						<u>0</u>					<u>4</u>	7																																																																																																																								
0		2		4	5	7		9				11																																																																																																																								
0	1	2	3	4	5	6	7	8	9	10	11																																																																																																																									

FIGURE 2-4: VALUE  $k$  OF ( $V \rightarrow I$ ) = 4

Value  $j$  relates to Lerdahl's "chordal circle-of-fifths rule" which registers the number of places a chord must move around the cycle of fifths until it meets the second chord. Because I am exclusively working with  $D \rightarrow T$  discharges, this value is constant:  $j = 1$ . The following table shows the differences in value between Skryabin's most commonly featured  $D$  functioned chords and their  $T$ s.

[1,5,7,11]	$\rightarrow$	[0,4,7]																																																																																																																																				
<table> <tr><td></td><td></td><td></td><td></td><td></td><td></td><td>7</td><td></td><td></td><td></td><td></td><td></td><td></td></tr> <tr><td></td><td></td><td></td><td></td><td></td><td></td><td>7</td><td></td><td></td><td></td><td></td><td></td><td></td></tr> <tr><td></td><td></td><td>1</td><td></td><td></td><td></td><td>7</td><td></td><td></td><td></td><td></td><td></td><td>11</td></tr> <tr><td>0</td><td></td><td>1</td><td></td><td>5</td><td></td><td>7</td><td></td><td>9</td><td></td><td></td><td></td><td>11</td></tr> <tr><td>0</td><td>1</td><td>2</td><td>3</td><td>4</td><td>5</td><td>6</td><td>7</td><td>8</td><td>9</td><td>10</td><td>11</td><td></td></tr> </table>							7													7									1				7						11	0		1		5		7		9				11	0	1	2	3	4	5	6	7	8	9	10	11			<table> <tr><td></td><td></td><td></td><td></td><td></td><td></td><td><u>0</u></td><td></td><td></td><td></td><td></td><td></td><td></td></tr> <tr><td></td><td></td><td></td><td></td><td></td><td></td><td><u>0</u></td><td></td><td></td><td></td><td></td><td></td><td>7</td></tr> <tr><td></td><td></td><td></td><td></td><td></td><td></td><td><u>0</u></td><td></td><td></td><td></td><td></td><td><u>4</u></td><td>7</td></tr> <tr><td>0</td><td></td><td>2</td><td></td><td>4</td><td>5</td><td>7</td><td></td><td>9</td><td></td><td></td><td></td><td>11</td></tr> <tr><td>0</td><td>1</td><td>2</td><td>3</td><td>4</td><td>5</td><td>6</td><td>7</td><td>8</td><td>9</td><td>10</td><td>11</td><td></td></tr> </table>							<u>0</u>													<u>0</u>						7							<u>0</u>					<u>4</u>	7	0		2		4	5	7		9				11	0	1	2	3	4	5	6	7	8	9	10	11			$\delta(V^7/I) \rightarrow I/I, k = 4, \delta = 5$
						7																																																																																																																																
						7																																																																																																																																
		1				7						11																																																																																																																										
0		1		5		7		9				11																																																																																																																										
0	1	2	3	4	5	6	7	8	9	10	11																																																																																																																											
						<u>0</u>																																																																																																																																
						<u>0</u>						7																																																																																																																										
						<u>0</u>					<u>4</u>	7																																																																																																																										
0		2		4	5	7		9				11																																																																																																																										
0	1	2	3	4	5	6	7	8	9	10	11																																																																																																																											

[3,5,7,11]	$\rightarrow$	[0,4,7]																																																																																																																																				
<table> <tr><td></td><td></td><td></td><td></td><td></td><td></td><td>7</td><td></td><td></td><td></td><td></td><td></td><td></td></tr> <tr><td></td><td></td><td></td><td></td><td></td><td></td><td>7</td><td></td><td></td><td></td><td></td><td></td><td></td></tr> <tr><td></td><td></td><td></td><td></td><td></td><td></td><td>7</td><td></td><td></td><td></td><td></td><td></td><td>11</td></tr> <tr><td>0</td><td></td><td>3</td><td></td><td>5</td><td></td><td>7</td><td></td><td>9</td><td></td><td></td><td></td><td>11</td></tr> <tr><td>0</td><td>1</td><td>2</td><td>3</td><td>4</td><td>5</td><td>6</td><td>7</td><td>8</td><td>9</td><td>10</td><td>11</td><td></td></tr> </table>							7													7													7						11	0		3		5		7		9				11	0	1	2	3	4	5	6	7	8	9	10	11			<table> <tr><td></td><td></td><td></td><td></td><td></td><td></td><td><u>0</u></td><td></td><td></td><td></td><td></td><td></td><td></td></tr> <tr><td></td><td></td><td></td><td></td><td></td><td></td><td><u>0</u></td><td></td><td></td><td></td><td></td><td></td><td>7</td></tr> <tr><td></td><td></td><td></td><td></td><td></td><td></td><td><u>0</u></td><td></td><td></td><td></td><td></td><td><u>4</u></td><td>7</td></tr> <tr><td>0</td><td></td><td>2</td><td></td><td>4</td><td>5</td><td>7</td><td></td><td>9</td><td></td><td></td><td></td><td>11</td></tr> <tr><td>0</td><td>1</td><td>2</td><td>3</td><td>4</td><td>5</td><td>6</td><td>7</td><td>8</td><td>9</td><td>10</td><td>11</td><td></td></tr> </table>							<u>0</u>													<u>0</u>						7							<u>0</u>					<u>4</u>	7	0		2		4	5	7		9				11	0	1	2	3	4	5	6	7	8	9	10	11			$\delta(V^7/I) \rightarrow I/I, k = 4, \delta = 5$
						7																																																																																																																																
						7																																																																																																																																
						7						11																																																																																																																										
0		3		5		7		9				11																																																																																																																										
0	1	2	3	4	5	6	7	8	9	10	11																																																																																																																											
						<u>0</u>																																																																																																																																
						<u>0</u>						7																																																																																																																										
						<u>0</u>					<u>4</u>	7																																																																																																																										
0		2		4	5	7		9				11																																																																																																																										
0	1	2	3	4	5	6	7	8	9	10	11																																																																																																																											

[2,5,7,11]	$\rightarrow$	[0,4,7]																																																																																																																																				
<table> <tr><td></td><td></td><td></td><td></td><td></td><td></td><td>7</td><td></td><td></td><td></td><td></td><td></td><td></td></tr> <tr><td></td><td></td><td></td><td></td><td></td><td></td><td>7</td><td></td><td></td><td></td><td></td><td></td><td></td></tr> <tr><td></td><td></td><td></td><td></td><td></td><td></td><td>7</td><td></td><td></td><td></td><td></td><td></td><td>11</td></tr> <tr><td>0</td><td></td><td>2</td><td></td><td>5</td><td></td><td>7</td><td></td><td>9</td><td></td><td></td><td></td><td>11</td></tr> <tr><td>0</td><td>1</td><td>2</td><td>3</td><td>4</td><td>5</td><td>6</td><td>7</td><td>8</td><td>9</td><td>10</td><td>11</td><td></td></tr> </table>							7													7													7						11	0		2		5		7		9				11	0	1	2	3	4	5	6	7	8	9	10	11			<table> <tr><td></td><td></td><td></td><td></td><td></td><td></td><td><u>0</u></td><td></td><td></td><td></td><td></td><td></td><td></td></tr> <tr><td></td><td></td><td></td><td></td><td></td><td></td><td><u>0</u></td><td></td><td></td><td></td><td></td><td></td><td>7</td></tr> <tr><td></td><td></td><td></td><td></td><td></td><td></td><td><u>0</u></td><td></td><td></td><td></td><td></td><td><u>4</u></td><td>7</td></tr> <tr><td>0</td><td></td><td>2</td><td></td><td>4</td><td>5</td><td>7</td><td></td><td>9</td><td></td><td></td><td></td><td>11</td></tr> <tr><td>0</td><td>1</td><td>2</td><td>3</td><td>4</td><td>5</td><td>6</td><td>7</td><td>8</td><td>9</td><td>10</td><td>11</td><td></td></tr> </table>							<u>0</u>													<u>0</u>						7							<u>0</u>					<u>4</u>	7	0		2		4	5	7		9				11	0	1	2	3	4	5	6	7	8	9	10	11			$\delta(V^7/I) \rightarrow I/I, k = 4, \delta = 5$
						7																																																																																																																																
						7																																																																																																																																
						7						11																																																																																																																										
0		2		5		7		9				11																																																																																																																										
0	1	2	3	4	5	6	7	8	9	10	11																																																																																																																											
						<u>0</u>																																																																																																																																
						<u>0</u>						7																																																																																																																										
						<u>0</u>					<u>4</u>	7																																																																																																																										
0		2		4	5	7		9				11																																																																																																																										
0	1	2	3	4	5	6	7	8	9	10	11																																																																																																																											

<sup>133</sup> Ibid., 55.

[1,5,7,10]

→

[0,4,7]

						7					
						7					
	1			5		7			10		
0	1	2		4	5	7		9	10	11	
0	1	2	3	4	5	6	7	8	9	10	11

						0					
						0					
						0					
	2			4	5	7		9		11	
0	1	2	3	4	5	6	7	8	9	10	11

$\delta(V^7/I) \rightarrow I/I, \quad k = 4, \delta = 5$

[2,5,8,11]

→

[0,4,7]

										11	
										11	
		2		5		8				11	
0	1	2	3	4	5	6	7	8	9	10	11

						0					
						0					
						0					
	2			4	5	7		9		11	
0	1	2	3	4	5	6	7	8	9	10	11

$\delta(V^7/I) \rightarrow I/I, \quad k = 6, \delta = 7$

[3,7,11]

→

[0,4,7]

						7					
						7					
		3				7				11	
0	1	2	3	4	5	6	7	8	9	10	11

						0					
						0					
						0					
	2			4	5	7		9		11	
0	1	2	3	4	5	6	7	8	9	10	11

$\delta(V^7/I) \rightarrow I/I, \quad k = 4, \delta = 5$

[5,7,11]

→

[0,4,7]

						7					
						7					
				5		7				11	
0	1	2	3	4	5	6	7	8	9	10	11

						0					
						0					
						0					
	2			4	5	7		9		11	
0	1	2	3	4	5	6	7	8	9	10	11

$\delta(V^7/I) \rightarrow I/I, \quad k = 4, \delta = 5$

[2,6,7,11]

→

[0,4,7]

						7					
						7					
		2				6				11	
0	1	2	3	4	5	6	7	8	9	10	11

						0					
						0					
						0					
	2			4	5	7		9		11	
0	1	2	3	4	5	6	7	8	9	10	11

$\delta(V^7/I) \rightarrow I/I, \quad k = 4, \delta = 5$

[2,5,11]

→

[0,4,7]

										11	
										11	
		2		5						11	
0	1	2	3	4	5	6	7	8	9	10	11

						0					
						0					
						0					
	2			4	5	7		9		11	
0	1	2	3	4	5	6	7	8	9	10	11

$\delta(V^7/I) \rightarrow I/I, \quad k = 6, \delta = 7$

[2,7,11]

→

[0,4,7]

						7					
						7					
		2				7				11	
0	1	2	3	4	5	6	7	8	9	10	11

						0					
						0					
						0					
	2			4	5	7		9		11	
0	1	2	3	4	5	6	7	8	9	10	11

$\delta(V^7/I) \rightarrow I/I, \quad k = 4, \delta = 5$

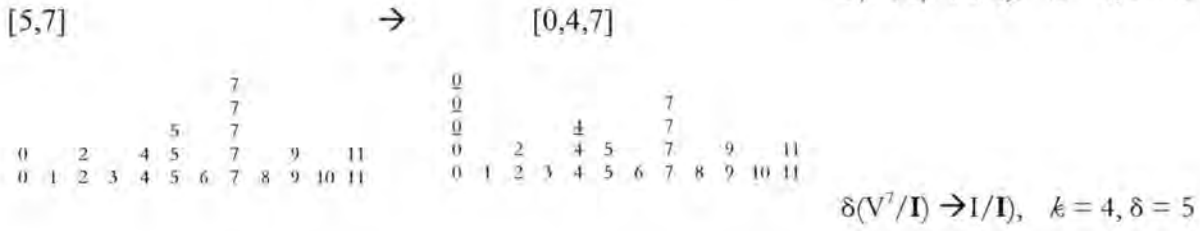
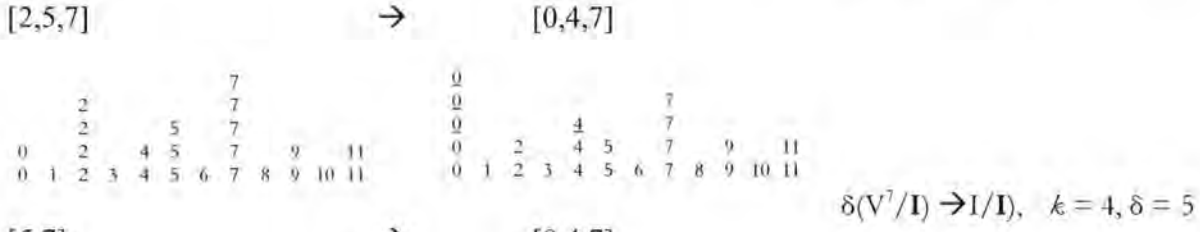
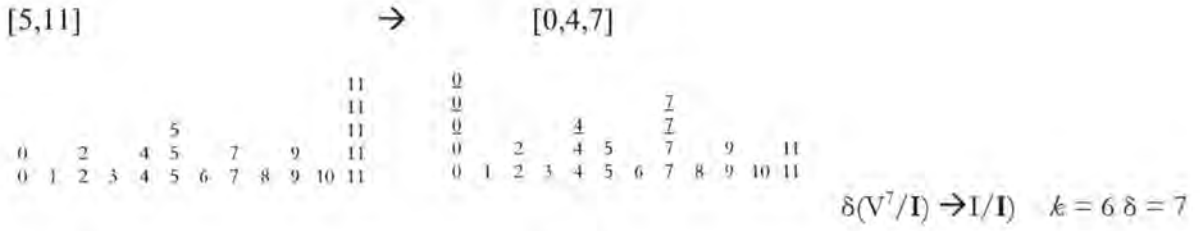
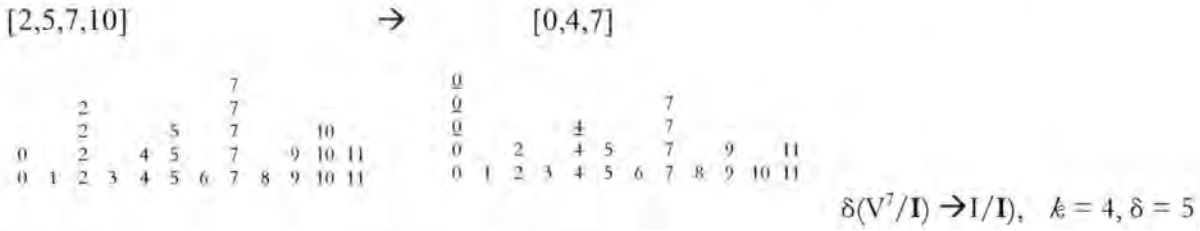
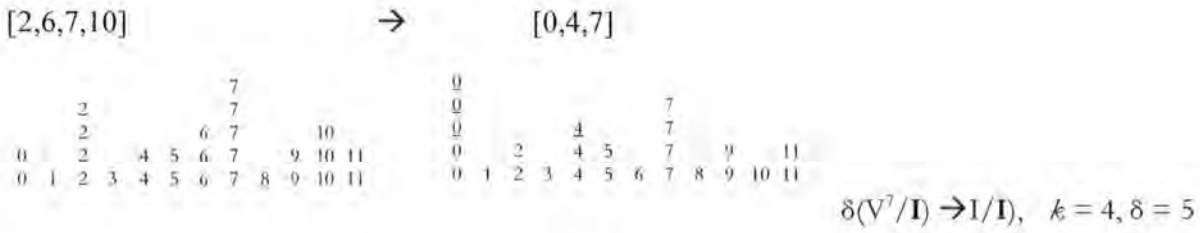

FIGURE 2-5: 'CHORDAL DISTANCE' VALUES OF SKRYABIN'S MOST FREQUENT DOMINANT SONORITIES

**Voice-Leading Attraction:**  $\alpha_{rvl}(C_1 \rightarrow C_2) = \alpha_{r1} + \dots + \alpha_{rn}$

Measuring 'chordal distance' is a relatively rudimentary enterprise; slightly more challenging, and more focussed, is the process of computing 'voice-leading attraction' ( $\alpha_{rvl}$ ).<sup>134</sup> Based loosely on the Schenkerian premise that unstable melodic tones hold an attraction towards more stable tones, this algorithm represents the tension in a chord (as compounded individual voices) moving towards another chord. The unique tension values for each unstable pitch are placed into an additive formula to cover the full chord. Thus, in Lerdahl's formula,  $C^1$  and  $C^2$  are "chords in which (at the very least) not

<sup>134</sup> 'rvl' is an acronym for 'realised voice-leading'. In other cases, the letter 'e' stands for 'expected'; 'r' stands for 'realised'.



all the pitches are identical.”<sup>135</sup>  $\alpha_{r1} + \dots + \alpha_m$  represents the value of the ‘realised (*r*) melodic attraction values’ for each of the pitches in the chord (*n*). It only remains to explain the processes by which we arrive at initial value  $\alpha$ .

Value  $\alpha$  is based on Lerdahl’s ‘anchoring principle’ which, he explains, “is the psychological need for an unstable pitch to be assimilated into an immediately subsequent and stable pitch”, based on the *Gestalt* principle of ‘proximity’.<sup>136</sup> Accordingly, the more instances of a pitch within the ‘basic space’, the stronger the ‘anchoring strength’. Lerdahl removes the level of ‘fifth space’ from this grid to make the third and the fifth share an equal anchoring strength.

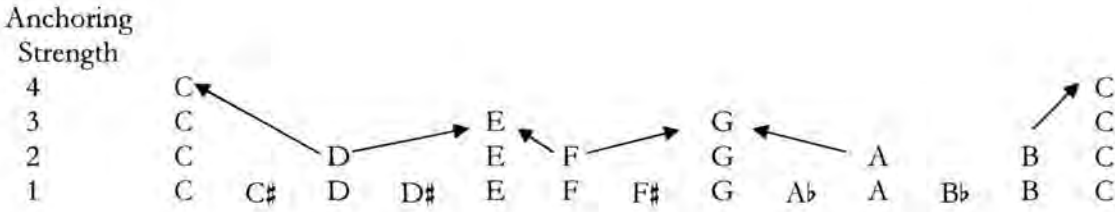

FIGURE 2-6: ‘ANCHORING STRENGTHS’ CHARTED ON THE ‘BASIC SPACE’.

In order to calculate value  $\alpha$  Lerdahl creates a formula for ‘melodic attraction’:

$$\alpha(p1 \rightarrow p2) = \frac{s^2}{s1} X^{1/n^2}$$

In this algorithm, p1 and p2 are two different pitches; s values represent each pitch’s ‘anchoring strength’, whilst n represents the number of semitone intervals between p1 and p2 (the n value is ‘squared’ in the algorithm).<sup>137</sup> The attraction of B  $\rightarrow$  C therefore computes as  $4/2 X^{1/1^2} = 4/2 = 2$ .

Where a non-diatonic pitch is initiated, its position in the basic space is elevated to the diatonic space level, affecting values s1 and s2. Thus the motion from D $\flat$   $\rightarrow$  C is equal in tension to B  $\rightarrow$  C, despite the ostensibly different anchoring strengths in figure 2-6. To convert this melodic attraction value into a harmonic value one simply compounds each pitch of the chord. The following table runs through this algorithm with each dominant-form.

<sup>135</sup> Lerdahl, *Tonal Pitch Space*, 173.

<sup>136</sup> *Ibid.*, 161.

<sup>137</sup> This is based on the Newtonian ‘inverse square law’ which states that the attraction between two elements is inversely proportional to the square of the distance between them. *Ibid.*, 163.

[1,5,7,11]		[2,6,7,11]	
$\alpha_c(F \rightarrow E)$	= 1.5	$\alpha_c(F\# \rightarrow E)$	= 0.375
$\alpha_c(D\flat \rightarrow C)$	= 2	$\alpha_c(D \rightarrow C)$	= 0.5
$\alpha_c(B \rightarrow C)$	= 2	$\alpha_c(B \rightarrow C)$	= 2
$\alpha_c(G \rightarrow C)$	= 0.05	$\alpha_c(G \rightarrow C)$	= 0.05
	$\alpha_{nl}(V^7 \rightarrow I) = 5.55$		$\alpha_{nl}(V^7 \rightarrow I) = 2.925$
[3,5,7,11]		[2,5,11]	
$\alpha_c(F \rightarrow E)$	= 1.5	$\alpha_c(F \rightarrow E)$	= 1.5
$\alpha_c(D\# \rightarrow E)$	= 1.5	$\alpha_c(D \rightarrow C)$	= 0.5
$\alpha_c(B \rightarrow C)$	= 2	$\alpha_c(B \rightarrow C)$	= 2
$\alpha_c(G \rightarrow C)$	= 0.05		$\alpha_{nl}(V^7 \rightarrow I) = 4$
	$\alpha_{nl}(V^7 \rightarrow I) = 5.05$	[2,7,11]	
[2,5,7,11]		$\alpha_c(D \rightarrow C)$	= 0.5
$\alpha_c(F \rightarrow E)$	= 1.5	$\alpha_c(B \rightarrow C)$	= 2
$\alpha_c(D \rightarrow C)$	= 0.5	$\alpha_c(G \rightarrow C)$	= 0.05
$\alpha_c(B \rightarrow C)$	= 2		$\alpha_{nl}(V^7 \rightarrow I) = 2.55$
$\alpha_c(G \rightarrow C)$	= 0.05	[2,6,7,10]	
	$\alpha_{nl}(V^7 \rightarrow I) = 4.05$	$\alpha_c(F\# \rightarrow G)$	= 1.5
[1,5,7,10]		$\alpha_c(D \rightarrow C)$	= 0.5
$\alpha_c(F \rightarrow E)$	= 1.5	$\alpha_c(B\flat \rightarrow C)$	= 0.5
$\alpha_c(D\flat \rightarrow C)$	= 2	$\alpha_c(G \rightarrow C)$	= 0.05
$\alpha_c(B\flat \rightarrow C)$	= 0.5		$\alpha_{nl}(V^7 \rightarrow I) = 2.55$
$\alpha_c(G \rightarrow C)$	= 0.05	[2,5,7,10]	
	$\alpha_{nl}(V^7 \rightarrow I) = 4.05$	$\alpha_c(F \rightarrow E)$	= 1.5
[2,5,8,11]		$\alpha_c(D \rightarrow C)$	= 0.5
$\alpha_c(B \rightarrow C)$	= 2	$\alpha_c(B\flat \rightarrow C)$	= 0.5
$\alpha_c(F \rightarrow E)$	= 1.5	$\alpha_c(G \rightarrow C)$	= 0.05
$\alpha_c(D \rightarrow C)$	= 0.5		$\alpha_{nl}(V^7 \rightarrow I) = 2.55$
$\alpha_c(A\flat \rightarrow G)$	= 1.5	[5, 11]	
	$\alpha_{nl}(V^7 \rightarrow I) = 5.55$	$\alpha_c(F \rightarrow E)$	= 1.5
[3,7,11]		$\alpha_c(B \rightarrow C)$	= 2
$\alpha_c(D\# \rightarrow E)$	= 1.5		$\alpha_{nl}(V^7 \rightarrow I) = 3.5$
$\alpha_c(B \rightarrow C)$	= 2	[2,5,7]	
$\alpha_c(G \rightarrow C)$	= 0.05	$\alpha_c(F \rightarrow E)$	= 1.5
	$\alpha_{nl}(V^7 \rightarrow I) = 3.55$	$\alpha_c(D \rightarrow C)$	= 0.5
[5,7,11]		$\alpha_c(G \rightarrow C)$	= 0.05
$\alpha_c(F \rightarrow E)$	= 1.5		$\alpha_{nl}(V^7 \rightarrow I) = 2.05$
$\alpha_c(B \rightarrow C)$	= 2	[5,7]	
$\alpha_c(G \rightarrow C)$	= 0.05	$\alpha_c(F \rightarrow E)$	= 1.5
	$\alpha_{nl}(V^7 \rightarrow I) = 3.55$	$\alpha_c(G \rightarrow C)$	= 0.05
			$\alpha_{nl}(V^7 \rightarrow I) = 1.5$

FIGURE 2-7: VOICE-LEADING ATTRACTION VALUES OF SKRYABIN'S DOMINANT SONORITIES

And from this position the 'chordal distance' and 'voice-leading attraction' values of each chord can be amalgamated into a single 'harmonic attraction' value.

**Harmonic Attraction:**  $\alpha_{rh}(C^1 \rightarrow C^2) = K[\alpha_{rvl}(C^1 \rightarrow C^2) / \delta(C^1 \rightarrow C^2)]$  ( $K=10$ )

In this algorithm, 'harmonic attraction' (rh) is simply divided by 'chordal distance'. Because the values generated would be very small, Lerdahl multiplies the result by a constant value; value K therefore equals 10. The following table represents each of Skryabin's dominant sonorities (codified simply as  $V^7$  in the formula, connoting function rather than format, and not affecting the formula in any way). This data will be used to build my hierarchy of tense chords – figure 2-9 – that comprises the 'key to the graphs' in the Appendices.

[1,5,7,11]	$\alpha_{rh}(V^7 \rightarrow I) = K[\alpha_{rvl}(V^7 \rightarrow I) / \delta(V^7 \rightarrow I)]$	$= 10 \times 5.55 / 5$	$= 11$
[3,5,7,11]	$\alpha_{rh}(V^7 \rightarrow I) = K[\alpha_{rvl}(V^7 \rightarrow I) / \delta(V^7 \rightarrow I)]$	$= 10 \times 5.05 / 5$	$= 10.1$
[2,5,7,11]	$\alpha_{rh}(V^7 \rightarrow I) = K[\alpha_{rvl}(V^7 \rightarrow I) / \delta(V^7 \rightarrow I)]$	$= 10 \times 4.05 / 5$	$= 8.1$
[1,5,7,10]	$\alpha_{rh}(V^7 \rightarrow I) = K[\alpha_{rvl}(V^7 \rightarrow I) / \delta(V^7 \rightarrow I)]$	$= 10 \times 4.05 / 5$	$= 8.1$
[2,5,8,11]	$\alpha_{rh}(V^7 \rightarrow I) = K[\alpha_{rvl}(V^7 \rightarrow I) / \delta(V^7 \rightarrow I)]$	$= 10 \times 5.55 / 7$	$= 7.9$
[3,7,11]	$\alpha_{rh}(V^7 \rightarrow I) = K[\alpha_{rvl}(V^7 \rightarrow I) / \delta(V^7 \rightarrow I)]$	$= 10 \times 3.55 / 7$	$= 7.1$
[5,7,11]	$\alpha_{rh}(V^7 \rightarrow I) = K[\alpha_{rvl}(V^7 \rightarrow I) / \delta(V^7 \rightarrow I)]$	$= 10 \times 3.55 / 5$	$= 7.1$
[2,6,7,11]	$\alpha_{rh}(V^7 \rightarrow I) = K[\alpha_{rvl}(V^7 \rightarrow I) / \delta(V^7 \rightarrow I)]$	$= 10 \times 2.925 / 5$	$= 5.9$
[2,5,11]	$\alpha_{rh}(V^7 \rightarrow I) = K[\alpha_{rvl}(V^7 \rightarrow I) / \delta(V^7 \rightarrow I)]$	$= 10 \times 4 / 7$	$= 5.7$
[2,7,11]	$\alpha_{rh}(V^7 \rightarrow I) = K[\alpha_{rvl}(V^7 \rightarrow I) / \delta(V^7 \rightarrow I)]$	$= 10 \times 2.55 / 5$	$= 5.1$
[2,6,7,10]	$\alpha_{rh}(V^7 \rightarrow I) = K[\alpha_{rvl}(V^7 \rightarrow I) / \delta(V^7 \rightarrow I)]$	$= 10 \times 2.55 / 5$	$= 5.1$
[2,5,7,10]	$\alpha_{rh}(V^7 \rightarrow I) = K[\alpha_{rvl}(V^7 \rightarrow I) / \delta(V^7 \rightarrow I)]$	$= 10 \times 2.55 / 5$	$= 5.1$
[5,11]	$\alpha_{rh}(V^7 \rightarrow I) = K[\alpha_{rvl}(V^7 \rightarrow I) / \delta(V^7 \rightarrow I)]$	$= 10 \times 3.5 / 7$	$= 5$
[2,5,7]	$\alpha_{rh}(V^7 \rightarrow I) = K[\alpha_{rvl}(V^7 \rightarrow I) / \delta(V^7 \rightarrow I)]$	$= 10 \times 2.05 / 5$	$= 4.1$
[5,7]	$\alpha_{rh}(V^7 \rightarrow I) = K[\alpha_{rvl}(V^7 \rightarrow I) / \delta(V^7 \rightarrow I)]$	$= 10 \times 1.55 / 5$	$= 3.1$

FIGURE 2-8: HARMONIC ATTRACTION VALUES OF SKRYABIN'S DOMINANT SONORITIES

As illustrated in the following descriptions of the uses of each chord, the results agree with intuition. And crucially, from these formulae, the following table can be constructed that will serve as a key for the graphical analyses. It contains pitch class information about each drive, a description of each chord in common nomenclature and, most importantly, each drive is given an alphabetical label showing hierarchical position. In three instances, drives share equal *Harmonic Attraction* values, differentiated on the graphs by Roman numerals. In addition to this list of 'drive chords', the resulting discharges must also be included in this 'key', and are found below it:







	[pc]	C major	Description
<b>Strongest Drives</b>  <b>Weakest Drives</b>	<b>a</b>	[1,5,7,11] G B D $\flat$ F	<i>Dominant-seventh chord with a diminished fifth</i>
	<b>b</b>	[3,5,7,11] G B D $\sharp$ F	<i>Dominant-seventh chord with an augmented fifth</i>
	<b>c</b>	[2,5,7,11] G B D F	<i>Pure dominant seventh chord</i>
	<b>c'</b>	[1,5,7,10] G B $\flat$ D $\flat$ f	<i>Diminished chord with additional seventh ('half diminished')</i>
	<b>d</b>	[2,5,8,11] B D F A $\flat$	<i>Full diminished seventh chord</i>
	<b>e'</b>	[3,7,11] G B D $\sharp$	<i>A three-way drive comprised of major thirds. Only charted if orthographically or contextually specific</i>
	<b>e''</b>	[5,7,11] G B F	<i>Implicit dominant-seventh chord; omitted fifth</i>
	<b>f</b>	[2,6,7,11] G B D F $\sharp$	<i>'Major seventh' chord</i>
	<b>g</b>	[2,5,11] B D F	<i>Diminished triad. Only charted if orthographically or contextually specific</i>
	<b>h'</b>	[2,7,11] G B D	<i>Pure triad. Only charted if it acts as a clear V</i>
	<b>h''</b>	[2,6,7,10] G B $\flat$ D F $\sharp$	<i>Minor chord with an additional 'major seventh'</i>
	<b>h'''</b>	[2,5,7,10] G B $\flat$ D F	<i>Minor seventh chord</i>
	<b>i</b>	[5,11] B F	<i>Pure tritone drive. May resolve in two directions, but only charted if contextually implicit of stronger drive</i>
<b>j</b>	[2,5,7] G D F	<i>Dominant-seventh chord; third omitted</i>	
<b>k</b>	[5,7] G F	<i>A pure seventh. A very weak drive, but one that can be contextually strengthened. Not usually charted</i>	
<b>Discharges:</b>		[0,4,7] C E G	<i>Purely articulated Tonic major chord</i>
		[0,3,7] C E $\flat$ G	<i>Purely articulated Tonic minor chord</i>
		[0,3,4,7] C E $\flat$ E $\sharp$ G	<i>Tonic major / minor chord</i>
			<i>Bass tone. Often overlaps the other symbols, represented by the characteristic black border.</i>
			<i>Foreground Pitch Discharge. Often a very small-scale discharge involving one or two individual pitches.</i>

FIGURE 2-9: HIERARCHICAL TAXONOMY OF SKRYABIN'S DOMINANT SONORITIES

Taking each drive in turn I now explore their appearance in Skryabin's harmonic lexicon. This preparatory step will facilitate an investigation of Skryabin's formal schemes. This will be the principal concern of Chapters 3 and 4.

## The Drives

### $a$ -DRIVES

The  $a$ -DRIVE is one of Skryabin's favourite tools. When this drive is transposed at t6 it replicates its pitch class content precisely. The orthography of its presentation constitutes what Varvara Dernova calls the 'tritone link'.<sup>138</sup> Her theories will be detailed in due course, but here I simply classify the drive as a dominant sonority with a diminished fifth, common to *Romantic* harmony and briefly detailed in Chapter 1. The chromatic pull of its  $b\hat{5}$ , and its requirement to move towards  $\hat{4}$ , makes it the strongest available drive, and one of the most tonally malleable. One must bear in mind that this chord is also the common *French Sixth*, and is therefore laden with additional expectation. Because this drive is equivalent to its own t6 transposition it is impossible to find a single  $a$ -DRIVE; they always come in pairs. One of the drives may have stronger syntactical placement on the surface, but, in this abstract and 'hypothetical' analysis, both  $a$ -DRIVES are rendered equally on *drive analysis* graphs. This drive flourishes, and this illustration from Sonata no. 6 demonstrates its workings.

EXAMPLE 2-10(A): SONATA NO. 6, MM. 283-287

	283	285	286	287
E	a		a	
A				
D				
G		a		a
C				
F				
B $\flat$	a		a	
E $\flat$				
A $\flat$				
D $\flat$		a		a

FIGURE 2-10(B): SONATA NO. 6, MM. 283-287 – DRIVE ANALYSIS

<sup>138</sup> Guenther, *Varvara Dernova's "Garmoniiia Skriabina": A Translation and Critical Commentary*, 89.

In m. 283 the following pitches unfold: B $\flat$  (C $\flat$ ), D, E, (G) A $\flat$ .<sup>139</sup> This set could be spelled “B $\flat$ , D, F $\flat$ , A $\flat$ ”, representing a B $\flat$  drive towards an E $\flat$  triad.<sup>140</sup> However, it could also represent a drive on E when spelled “E, G $\sharp$ , B $\flat$ , D”. In leaving this ambiguity open, *drive analysis* ignores Skryabin’s idiosyncratic orthography that would lead others to search for a single tonic.<sup>141</sup> In m. 285 Skryabin alternates this pair of  $a$ -DRIVES with another pair on G and D $\flat$ .

### $b$ -DRIVE

Only slightly less attracted to its tonic than the  $a$ -DRIVE, the chromatically altered fifth is raised rather than lowered. This manipulation draws the note upwards to scale degree  $\hat{3}$  (the third of the resultant triad), rather than  $\hat{1}$  (the tonic of the resultant triad), i.e. D $\sharp \rightarrow$  E rather than D  $\rightarrow$  C in C major.  $\hat{1}$  is naturally more stable and, in Lerdahl’s terminology, it has greater ‘anchoring strength’ than  $\hat{3}$ .

The  $b$ -DRIVE is more rare than the  $a$ -DRIVE but a neat excerpt from *Caresse dansée*, Op. 56 illustrates it. From mm. 41-46,  $b$ -DRIVES alternate with  $a$ -DRIVES to form a cycle of fifths, stretching from C  $\rightarrow$  D $\flat$



FIGURE 2-11(A): CARESSE DANSÉE, OP. 57, MM. 41-46

On a *drive analysis* graph this produces a neat pattern of discharges:

<sup>139</sup> Concentrating on the drives ‘within’ chords, *drive analysis* does not attempt to explain every pitch within a given sonority, which are usually explained by broader octatonic / whole-tone / *mystic* sets. See Wai-Ling, ‘Scriabin’s “White Mass”: Dialogue between The “Mystic” And The “Octatonic”’ *Journal of the Scriabin Society of America* 5/1 (2001); Reise, ‘Late Scriabin: Some Principles Behind the Style’. In this case, a C $\flat$  and G are contained in the sonority, which will be discussed in due course.

<sup>140</sup> In this case the C $\flat$  would most naturally ‘slot into place’ as a simultaneous  $\sharp$  fifth of this E $\flat$  chord, spelled as B $\sharp$ .

<sup>141</sup> George Perle shows that Skryabin’s orthography is tightly controlled and closely bound to his use of octatony. Skryabin is said to work draw from an octatonic ‘master scale’ from which orthographically fixed heptatonic scales are derived. As Skryabin transposes passages by t $\bar{3}$ , t $\bar{6}$  and t $\bar{9}$  so does his orthography transpose. Perle, ‘Scriabin’s Self Analyses’.

	41	42	43	44	45	46
C	b					
F		a				
B $\flat$			b			
E $\flat$				a		
A $\flat$					b	
D $\flat$						a

FIGURE 2-11(B): *CARESSE DANSÉE*, OP. 57, MM. 41-46 – DRIVE ANALYSIS

As with all drives in Skryabin’s harmony, they do not always follow their dominant implications. This is precisely the reason they embody drive rather than desire. In this extract from Symphony, no.3, *The Divine Poem*, the drive behaves more like an augmented sixth chord in the key of E:

Lento  $\text{♩} = 50$   
sublime

*pp* *poco cresc.* *p*

*b-drive*

FIGURE 2-12: SYMPHONY, NO.3, *DIVINE POEM*, OP. 43, MVT. II – “VOLUPTÉS”, MM. 1-4

### $c^I$ -DRIVE

The pure ‘dominant seventh chord’ needs no justification for its highly tensile force. One could even claim that it is stronger than the  $a$ -DRIVE and  $b$ -DRIVE because it is so easily distinguishable as a *D* chord; this, despite the fact that degree  $\hat{2}$  pulls to either  $\hat{3}$  (third of the resultant chord) or  $\hat{1}$  (tonic of the resultant chord) by a whole-tone rather than a semi-tone. This drive is heteronymous however, as it can act as a *German Sixth*.

### $c^{II}$ -DRIVE

*Tristanesque* in nature, this ‘half diminished’ dominant drive is paradoxically both stronger and weaker than the plain dominant seventh chord: stronger because the fifth is diminished to tighten the attraction towards  $\hat{1}$  (tonic of the resultant triad, i.e.  $D\flat \rightarrow C$ ); weaker because the third is chromatically lowered which slackens its own attraction towards  $\hat{1}$  (i.e.  $B\flat \rightarrow C$ ). The typical presentation in C major

would look something like this example from the 1905 *Feuillet d'album*, Op. 45, no. 1. Here, in m. 10, the melodically suspended C resolves to a B $\sharp$ . The A-E $\flat$ -G-C creates a  $c^{ii}$ -DRIVE but as the pitch F is initiated with its tritone B,  $a$ -DRIVES are also signalled on F/B.



FIGURE 2-13(A): FEUILLET D'ALBUM, OP. 45, MM. 7-16

	10	11	12	13	14	15	16
B	a						
E							
A	$c^{ii}$			$c^i$			
D		a					
G	b		$c^{ii}$			$c^i$	
C				b			
F	a				$c^{ii}$		a
B $\flat$						$c^i$	j
E $\flat$							□
A $\flat$		a					

FIGURE 2-13(B): FEUILLET D'ALBUM, OP. 45, MM. 10-16 – DRIVE ANALYSIS

This constellation of drives also engenders a  $b$ -DRIVE on G: G-B-D $\sharp$  (E $\flat$ )-F.  $C^{ii}$ -DRIVES are positioned in a cycle of fifths progression, reaching from mm. 10-16, reinforced by the bass, shown by the black borders around each square.



*d*-DRIVE

Somewhat surprisingly this drive is very rarely deployed. Given the diminished seventh chord's deep symmetry, one would have expected Skryabin to draw it closely to his bosom. His phrase structures certainly avail themselves of the octatonically compatible minor third drive configuration, exemplified most obviously in the t3, t6, t9, t12 transposition schemes for which Skryabin is renowned.

Nevertheless, the diminished chord *per se* is infrequently heard. A rare example occurs in *Etrangeté*, Op. 63, no. 2 but even this interpretation clutches at straws; the chord appears fleetingly in the right-hand in m. 2, embodied in the rising Eb-Gb-A-C figure. These four notes are part of a larger motive, extending hospitality to the extra pitches Bb and Db.



FIGURE 2-14(A): *ETRANGETÉ*, OP. 63, NO. 2

In *drive analysis* the chord centres on Eb. This is something of a 'fudge', contextually facilitated by the bass' emphasis on Eb.<sup>142</sup> In isolation, the pitch-class set has four ways of discharging; to plot all possibilities would be graphically excessive. Fortunately, due to the chord's infrequency, this is not a persistent problem.

	1	2	2:4
F#	a		
B			
E			
A		a	
D			
G			
C	a		
F			
Bb			
Eb		a	d

FIGURE 2-14(B): *ETRANGETÉ*, OP. 63, NO. 2—DRIVE ANALYSIS

<sup>142</sup> The drive is also underpinned by pitches G-C# (Db)-Bb-Eb further justifying my reading.

### $e^{\flat}$ -DRIVE

Essentially an augmented chord, this common drive has the same voice-leading potential as a  $b$ -DRIVE minus the seventh. Rameau called the augmented chord “one of the most characteristic and expressive harmonies of the French Baroque”, and it enjoys equal prominence in Skryabin’s repertoire, doubtless because of its symmetrical possibilities.<sup>143</sup> This drive trisects the major scale into three equal major thirds, offering ‘resolution’ in three distinct directions. These three resolutions must be borne in mind, but for the purposes of *drive analysis* charts, usually only the most contextually specific drive is included. This said, the remaining two drives could add vitality to the libidinal flow of a phrase. Skryabin offers few isolated instances of the three-note  $e^{\flat}$ -DRIVE as it is usually subsumed by a fuller four note drive, but a rare example can be found in the opening moments of Sonata no. 10, Op. 70.



FIGURE 2-15(A): SONATA NO. 10

	1	2
B		<b>g</b>
E		
A		
D	<b><math>e^{\flat}</math></b>	

FIGURE 2-15(B): SONATA NO. 10 – DRIVE ANALYSIS

Why read this tri-symmetrical chord as an  $e^{\flat}$ -DRIVE on D rather than on  $G^{\flat}$  or  $B^{\flat}$  when the orthography and spacing ( $G^{\flat}$ ,  $B^{\flat}$ , D) would support either of the other interpretations? Indeed, a reading based on  $G^{\flat}$  would support a discharge between the opening two measures, leading to a  $g$ -DRIVE on B ( $C^{\flat}$ ) (though the root is missing for reasons that will be clarified in discussion of the  $g$ -DRIVE). The reasons for my ‘D’ interpretation are three-fold: (1) the melodic  $B^{\flat}$  ‘resolves’ to a  $B^{\flat\flat}$  (A) before moving to a  $G^{\flat}$  to outline an enharmonic D triad; (2) the reemphasis of these pitches as part of a D (and  $A^{\flat}$ )  $a$ -DRIVE in m. 3; (3) additional reasons of ‘tonal substitution’ which will emerge in Chapter 4.<sup>144</sup> Of course these

<sup>143</sup> Christensen, *Rameau and Musical Thought in the Enlightenment*, 124.

<sup>144</sup> Based on various analytical models, I will interpret D as the tonal centre of the piece, a centre which finds ‘substitutions’ in F,  $A^{\flat}$  and B.

three reasons are ultimately highly subjective and, in the final analysis, *all three* drives operate and should ideally be represented in *drive analysis*, thus:

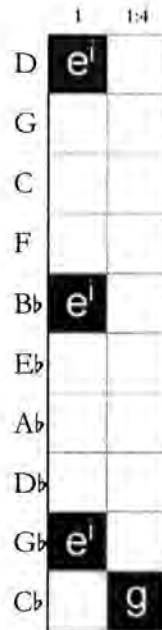

FIGURE 2-15(c): SONATA NO. 10 – MORE THOROUGH DRIVE ANALYSIS

However, this would be problematic in practice and would lead to graphical over-crowding in complex polytonal moments. This will transpire through an examination of the drive patterns in Sonata no. 10 in Chapter 4. Fortunately for *drive analysis* this problem rarely arises due to the scarcity of the  $e'$ -DRIVE

### $e''$ -DRIVE

Even with its fifth omitted, the dominant seventh chord remains fairly potent as the tritone pull continues to exert pressure. Instances of this drive abound in Skryabin's work; here is m. 13 of Sonata no. 5

The musical score for measure 13 of Sonata No. 5 is shown. It consists of two staves: a treble clef staff for the right hand and a bass clef staff for the left hand. The key signature has three sharps (F#, C#, G#). The time signature is 3/8. The tempo is marked 'Languido'. The dynamics are 'pp dolciss.' and 'con voglia'. The score includes performance instructions like 'una corda' and 'pochiss.'. The right hand plays a melodic line with a tritone pull, and the left hand plays a dominant seventh chord with its fifth omitted.

FIGURE 2-16(A): SONATA NO. 5, MM. 13-24

	13	19
A#	j	a
D#		
G#		
C#		
F#	e <sup>ii</sup>	b
B		
E		a

FIGURE 2-16(B): SONATA NO. 5, MM. 13-19—DRIVE ANALYSIS

Herein lies an  $F\#^7$  chord with the  $C\#$  ( $\hat{5}$ ) omitted. The  $G\#$  pitch remains extraneous to *drive analysis* of course, but it is soon sublimated into a superimposed  $a$ -DRIVE on E in m. 19's revealing repetition. The  $A\#$  ( $\hat{3}$ ) of the  $F\#^7$  chord becomes the  $b\hat{5}$  ( $\#4$ ) of this drive and, because  $a$ -DRIVES are always doubled, a simultaneous  $a$ -DRIVE on  $A\#$  is presented. An  $e^{ii}$ -DRIVE rarely remains intact because additional pitches can readily transform it. The pitches C-E-B $\flat$  alone form the  $e^{ii}$ -DRIVE, but adding pitches  $F\#$  ( $G\flat$ ),  $G\#$  ( $A\flat$ ) or G produces a drive of the "modified- $\hat{5}$ " type ( $a$ -DRIVE OR  $b$ -DRIVE), or the full  $e^i$ -DRIVE. Such modifications are common to the  $e^{ii}$ -DRIVE which often slips in and out of fuller drives, propelled by melodic concerns or drive interactions. The foregoing passage from Sonata no. 5 underlines processes of drive interaction, but an example of melodic interaction is found in the aforementioned *Feuillet d'album* from *3 Morceaux*, Op. 45.

FIGURE 2-17: FEUILLET D'ALBUM, MM. 16-17

The  $e^{\flat}_{\text{DRIVE}}$  on B $\flat$  is transformed into a  $e^{\flat}_{\text{DRIVE}}$  as the pitch F is activated at the end of m. 16. This F is the emphasised tone of a melodic double-neighbour-note figure. Of course, by the time this F is struck, a new  $d_{\text{DRIVE}}$  is formed from the pitches F, D, C $\flat$  and A $\flat$ . This said, the previous bass B $\flat$  makes us experience the chord as a ‘dominant minor ninth’, itself a combination of two drives: the  $d_{\text{DRIVE}}$  and the  $e^{\flat}_{\text{DRIVE}}$ .

### $f_{\text{DRIVE}}$

The ‘major seventh’ is unusual because the characteristic seventh is raised, and therefore inclines towards degree  $\hat{5}$  of the resultant triad. In C major, for example, the F $\sharp$  of the ‘G major seventh chord’ has a stronger charge to move to the G than the E. One can easily imagine situations, common to jazz music, when the ‘major seventh chord’ is used as a tonic sonority in itself. Its own leading note, sequestering an integral ‘dominant’ dissonance, embellishes it; i.e. the F $\sharp$  itself behaves as the third of a drive on D, embodied within its own tonic G.

Another property of the ‘major seventh’ is its status as the product of a major chord that is superimposed upon its relative minor. For example F-A-C-E contains both an F triad and an A minor triad. Thus the major seventh’s position as a drive is rather equivocal. Skryabin often creates tensile relationships between the triadic elements of this drive and the whole major seventh chord. *Nuances*, Op. 56 opens with a first-inversion D minor triad, the bass B $\flat$  entry creating a B $\flat$  major seventh chord – an  $f_{\text{DRIVE}}$ .



FIGURE 2-18: *NUANCES*, MM. 1-3

But this B $\flat$  creates a seventh above a new bass C, which, in addition to the E and G $\sharp$  that follow, becomes a  $b_{\text{DRIVE}}$ . This moment is particularly tense as the melodic D forms an  $a_{\text{DRIVE}}$  on E and B $\flat$  before it resolves to a C $\sharp$ . In m. 2 a vertical F major seventh chord announces itself. On the fourth quaver beat of the measure a bass C-B $\flat$ -A cell emphasises the A minor element of the chord but a pure F triad arrives on the seventh beat. In this way Scriabin breaks apart the major seventh and temporally discloses its detached elements.

Naturally there are many instances of the  $f_{\text{DRIVE}}$  in polytonal combination with other drives. Such is the case in Sonata no. 5 where a ‘fifths-cycle’ of  $f_{\text{DRIVES}}$  underpins weaker cycles of  $f_{\text{DRIVES}}$  and  $j_{\text{DRIVES}}$ .

The image shows a musical score for Sonata No. 5, measures 65-89. The score is written for piano and consists of five systems of two staves each (treble and bass clef). The key signature is G major (one sharp) and the time signature is 3/4. Measure 65 begins with a *dim.* (diminuendo) marking. Measure 70 includes a *cresc. poco a poco* (crescendo poco a poco) marking. The bass line features a prominent 'fifths-cycle' of fifths, which is a sequence of notes where each note is a fifth above the previous one. Fingerings are indicated by numbers 1-5. The piece concludes with a final cadence in measure 89.

FIGURE 2-19(A): SONATA NO. 5, MM. 65-89

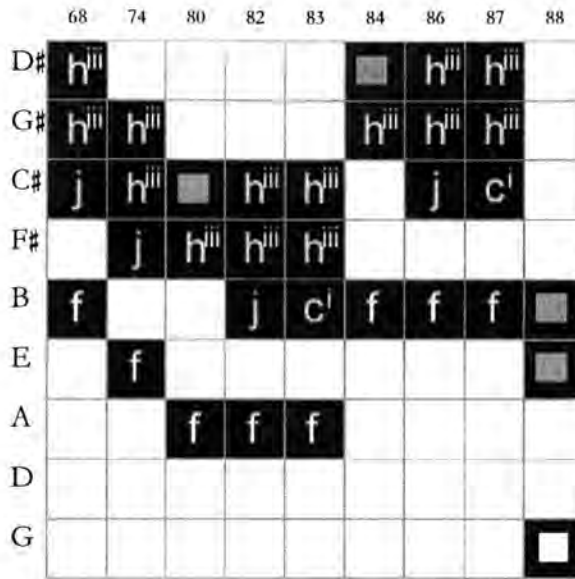

FIGURE 2-19(B): SONATA NO. 5, MM. 65-89 – DRIVE ANALYSIS

Yet because of Skryabin’s dialectical use of the  $f_{\text{DRIVE}}$ s components, it can be awkward to graphically represent. In mm. 88 for example, the characteristic motive in the right-hand of the piano alternates G major, E minor and B minor triads in quick succession. The G and B minor triads are so closely knit together that a ‘major seventh’ on G could be inferred. Nonetheless, because of the interspersed E triad, I choose to label them as separate ‘polytonal’ elements, depicted on the graph as vertical simultaneities, though alternative readings would be no less valid.

### $g_{\text{DRIVE}}$

Like the augmented triad, the diminished triad occurs at so many points of Skryabin’s music that its inclusion on graphs would be muddling. Each is therefore only charted if it behaves as a clear  $vii^{\circ}$  triad. In actual fact, despite its tensility, this three-note chord is very scarce due to its embodiment within fuller chords. A rare occurrence of its isolation is illustrated in figure 2-20, again from Sonata no. 10. After hearing the  $e^i_{\text{DRIVE}}$  in m. 1 there is a  $g_{\text{DRIVE}}$  in m. 2.

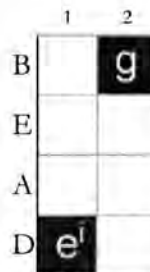

FIGURE 2-20: SONATA NO. 10 – DRIVE ANALYSIS

Notice how the  $g$ -DRIVE lacks a root – the B is missing. Nonetheless, I infer a hypothetical root in order to chart the correct position in *drive analysis*. This  $D$  functioned vii chord would naturally lead to an E chord ( $Fb$ ).

### $H$ -DRIVE

The pure triad occupies an equivocal position as  $T$ ,  $D$  or  $S$ , and is therefore often discounted as a drive. However, when determined to hold a clear  $D$  function, it appears in the appropriate graphical position. This drive is conspicuously rare in Skryabin's middle to late styles, but this codetta from Prelude, Op. 11, no. 14 outlays the approach to the tonic chord –  $Db$  – via a pure  $Ab$  triad.



FIGURE 2-21: PRELUDE, OP. 11, NO. 14 – CODETTA

The  $D$  function is embodied in a pure  $Ab$  triad because the sense of key in this Chopinesque work is well established; the seventh is not required in the  $D$  chord. Notice also that the preceding chord ii is presented likewise. In Skryabin's late style, where key is never firmly established, these triadic drives disappear and triads function as local  $T$ s rather than  $D$  drives.

### $h^{\#}$ -DRIVE

The minor triad with a major seventh features occasionally. Of course the potent tritone is chromatically altered, weakening the drive considerably. In C major for instance, a  $Bb$  and  $F\sharp$  loosens the semitone attraction (i.e. the B-F pull to C and E) to a whole-tone attraction. Instances abound in Sonata no. 10, where minor 'major seventh' ( $h^{\#}$ -DRIVES) chords exchange freely with pure major sevenths ( $f$ -DRIVES).







FIGURE 2-22(A): SONATA NO. 10, MM. 158-163

	158	159	160	161
E		<b>h<sup>ii</sup></b>	<b>h<sup>ii</sup></b>	<b>h<sup>ii</sup></b>
A				
D				
G				
C				
F				
B $\flat$				
E $\flat$				
A $\flat$	<b>f</b>	<b>c<sup>i</sup></b>		<b>c<sup>i</sup></b>

FIGURE 2-22(B): SONATA NO. 10, MM. 158-163 – DRIVE ANALYSIS

In m. 158 the descending upper line initially alternates G $\sharp$  and a G $\flat$  pitches, making the A $\flat$  chord fluctuate between a seventh and a major seventh chord: a  $c_{\text{DRIVE}}^{\flat}$  and an  $f_{\text{DRIVE}}$ . In m. 159 the drive on E begins its life as a minor ‘major seventh’ chord with a D $\sharp$  in the pianist’s right-hand, but this ‘resolves’ downwards to a D $\flat$  forming a minor seventh chord, thus morphing into an  $h_{\text{DRIVE}}^{\flat}$  (which will be introduced next). One of the vagaries of this drive is the ambiguous role of the major seventh pitch (the F $\sharp$  in C major) who, because of the augmented seventh, has a stronger propensity to move towards the upper G ( $\hat{5}$ ) rather than the E ( $\hat{3}$ ), which an F $\sharp$  ( $\hat{4}$ ) would tend towards. Now, in the pure major-seventh chord (the  $f_{\text{DRIVE}}$ ) this motion would be precluded by the resulting ‘parallel fifths’ as the B/F $\sharp$  moves to the C/G. The  $f_{\text{DRIVE}}$  was therefore adjusted so that the F $\sharp$  descended to the E, but because the leading note to tonic motion is still presented in the  $f_{\text{DRIVE}}$ , it is still stronger than this  $h_{\text{DRIVE}}^{\flat}$  with its  $\hat{b}\hat{3}$ .<sup>145</sup>

<sup>145</sup> See the formulae presented earlier in this chapter.

### $h^{iii}$ -DRIVE

This 'minor seventh' chord proliferates in Skryabin's middle to late styles. It has equal strength to the  $h^i$ -DRIVE described above because the  $F \rightarrow E$  motion of the  $h^{iii}$ -DRIVE (in C major) contains the same attraction as the  $F\# \rightarrow G$  motion of the  $h^i$ -DRIVE. Like the other  $h$ -DRIVES, this thrives in sections that freely exchange major-seventh drives. M. 3 of *Nuances*, Op. 56 is a case in point. An  $h^{iii}$ -DRIVE on  $E\flat$  occurs at the beginning of the measure, but by the time the melodic  $E\flat$  has descended to a D, the chord has chromatically slipped to an  $a$ -DRIVE on  $C\flat$ . This  $C\flat$  discharges the  $G\flat$  triad that was embedded in the  $E\flat$  minor drive.

FIGURE 2-23(A): *NUANCES*, OP. 56, MM. 1-3

	3
$E\flat$	$h^{iii}$
$A\flat$	
$D\flat$	
$G\flat$	
$C\flat$	$a$

FIGURE 2-23(B): *NUANCES*, OP. 56, M. 3 – DRIVE ANALYSIS

The following moment in *Sonata no. 5* shows similarities. In m. 41 a  $j$ -DRIVE on  $E\flat$  is inflected with an  $A\flat$ , followed by a similar hybrid of drives on G and F in m. 42. This latter produces the effect of a  $Dm^7$  in the pianist's right-hand over a left-hand  $G^7$  drive. This  $h^{iii}$ -DRIVE on D changes to an  $f$ -DRIVE on F in the right-hand whilst the  $j$ -DRIVE on G is maintained in the left. These examples illustrate not only how  $h^{iii}$ -DRIVES alternate, but also how they can be polytonally combined.

FIGURE 2-24: *SONATA NO. 5*, MM. 41-45

### *i*-DRIVE

The pure tritone is physically both the strongest and the weakest drive: strongest because it contains the two notes with the most potent attraction values, weakest because it embodies symmetrical tension values in contrary directions, requiring a particular tonal context to take root. Tritone drives are usually arranged into thicker drive structures; such is the case with the *French sixth* *a*-DRIVE in which a pair of tritones is separated by a whole-tone i.e. B/F – C#/G. And yet at other times they are arranged in pairs that bear no single functional interpretation. In such cases they are charted as individual *i*-DRIVES. Like *a*-DRIVES, *i*-DRIVES are always polysemic and pluralised; they can discharge either ‘outwards’ or ‘inwards’. In the coda of Sonata no. 6, the tritones, organised in the bass, are separated by a semitone – G/C# and Ab/D. These ‘jar’ too much to be part of a single recognisable drive and are therefore charted separately. In m. 372 the *i*-DRIVES on Bb and E are sublimated into full *i*-DRIVES which in the right-hand figuration.



FIGURE 2-25(A): SONATA NO. 6, MM. 371-372

	371	372
E	<i>i</i>	<i>c</i> <sup>l</sup>
A	<i>i</i>	<i>i</i>
D		
G		
C		
F		
Bb	<i>i</i>	<i>c</i> <sup>l</sup>
Eb	<i>i</i>	<i>i</i>

FIGURE 2-25(B): SONATA NO. 6, MM. 371-372 – DRIVE ANALYSIS

However, one must ultimately acknowledge that, whilst the tritone is vital to Skryabin’s compositional process, instances of its isolation are comparatively rare in the repertory; it is usually embodied in a more specific drive.

### $i_{\text{DRIVE}}$

Although the  $i_{\text{DRIVE}}$  comprises only two notes, these pitches bear the highest attraction values and are therefore stronger than the  $j_{\text{DRIVE}}$  which consists of the dominant chord minus the third (i.e. G-D-F in C major). It seems that the combined force of G and D is still not as durable as the single leading-tone B.<sup>146</sup> In this assertion I am at odds with classic Russian music theory, which, since Boleslav Yavorsky, finds no attraction for B to rise to C, maintaining that B ‘desires’ to descend. As Ildar Khannanov shows, “Yavorsky considered the resolution of the leading tone not the motion up, but descending to the stable tonic.”<sup>147</sup> Of course Yavorsky’s view would contravene the *Gestalt* principle of the ‘shortest path’ upon which so much of cognitivism’s implication-realisation models are based, from Meyer to Lerdahl.

The relative weakness of  $j_{\text{DRIVES}}$  would limit their inclusion in *drive analysis* in some cases. M. 87 of *Vers la Flamme*, Op. 72 initially outlays the pitches B $\flat$  and F beneath a sustained A $\flat$ , forming a  $j_{\text{DRIVE}}$ .<sup>148</sup> In this passage of *Vers la Flamme*, intricate operations are under way, which are the subject of Chapter 6, assuring their inclusion on graphs.



FIGURE 2-26(A): *VERS LA FLAMME*, OP. 72, M. 86

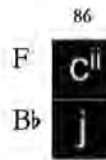

FIGURE 2-26(B): *VERS LA FLAMME*, OP. 72, M. 86 – DRIVE ANALYSIS

### $k_{\text{DRIVE}}$

The weakest drive in Skryabin’s repertory (that I have judged to be worthy of inclusion) is the pure seventh interval. This is simply an inverted whole-tone and is therefore left uncharted in all but a few instances. However, there are various occasions when the drive must be recorded; as Katherine Bergeron claims of the interval in Debussy’s *Pelléas*, the whole-tone can still carry the “tenacity of

<sup>146</sup> The value  $\alpha_c$  of  $F \rightarrow E$  is 1.5, and  $B \rightarrow C$  is an even stronger 2. Thus these two pitches in concert create a very tensile unit. Compare this with the 0.5 value of  $D \rightarrow C$  and the 0.05 of  $G \rightarrow C$ .

<sup>147</sup> Khannanov, *Russian Methodology of Musical Form and Analysis*, 99.

<sup>148</sup> The E $\flat$  and C $\flat$  tremolando affixes a composite  $i^{\flat}$ -DRIVE to F, emphasised in the bass.

desire”.<sup>149</sup> The whole-tone interval *is* regarded as dissonance and therefore *does* engender an expectation of resolution in tonal harmony, but this requirement is highly ambiguous and highly context-specific.

The opening chord of Prelude, Op. 67, no. 1 contains strong *a*-DRIVES on C and F#, but the pitches Bb and Ab in the upper voice are articulated as sevenths rather than whole-tones. If these were not so exposed one would not deem it necessary to chart them as drives, but upon their discharge into an Eb<sup>7</sup> drive in beat 4, their force is retrospectively confirmed. Naturally, after the initial discharge, the repeat of the opening sonority in m. 2 is even more loaded with signification; the drive is strengthened.



FIGURE 2-27(A): PRELUDE, OP. 67 MM. 1-2

	1	1:4	2	2:4
F#	a	c <sup>i</sup>	a	c <sup>i</sup>
B				
E				
A		c <sup>i</sup>		c <sup>i</sup>
D				
G				
C	a		a	
F		i		i
Bb	k		k	
Eb		c <sup>i</sup>		c <sup>i</sup>

FIGURE 2-27(B): PRELUDE, OP. 67 MM. 1-2 – DRIVE ANALYSIS

### Bass Drives

An important factor in *drive analysis* is the location of the bass tone. In general terms, if a drive is supported by its root then it is much stronger; if the root is missing or displaced, the drive is weakened. However, the bass *can* act as a drive in its own right in certain circumstances, often graphically divorced from the main drive network, represented via black borders around the relevant squares. A *drive analysis*

<sup>149</sup> Bergeron, Katherine, Méliandse’s *Hair*, in Smart, *Siren Songs: Representations of Gender and Sexuality in Opera*, 180.

chart of Prelude, Op. 56 shows an utterly fragmented bass configuration, which is almost always dislocated from the corpus of drives.

The image displays the first 15 measures of the Prelude, Op. 56, in G-flat major, 3/8 time. The score is written for piano and is divided into six systems, each containing two staves (treble and bass clef). The measures are numbered 1, 3, 6, 9, 12, and 15 at the beginning of their respective systems. The bass line is highly fragmented, with frequent rests and disjunctive intervals. Dynamics include *mp* (mezzo-piano) at measure 6, *cresc.* (crescendo) at measure 9, *a poco* (a little) at measure 12, and *cresc.* again at measure 15. The piece concludes with a fermata over the final chord in measure 15.



FIGURE 2-28(A): PRELUDE, OP. 56

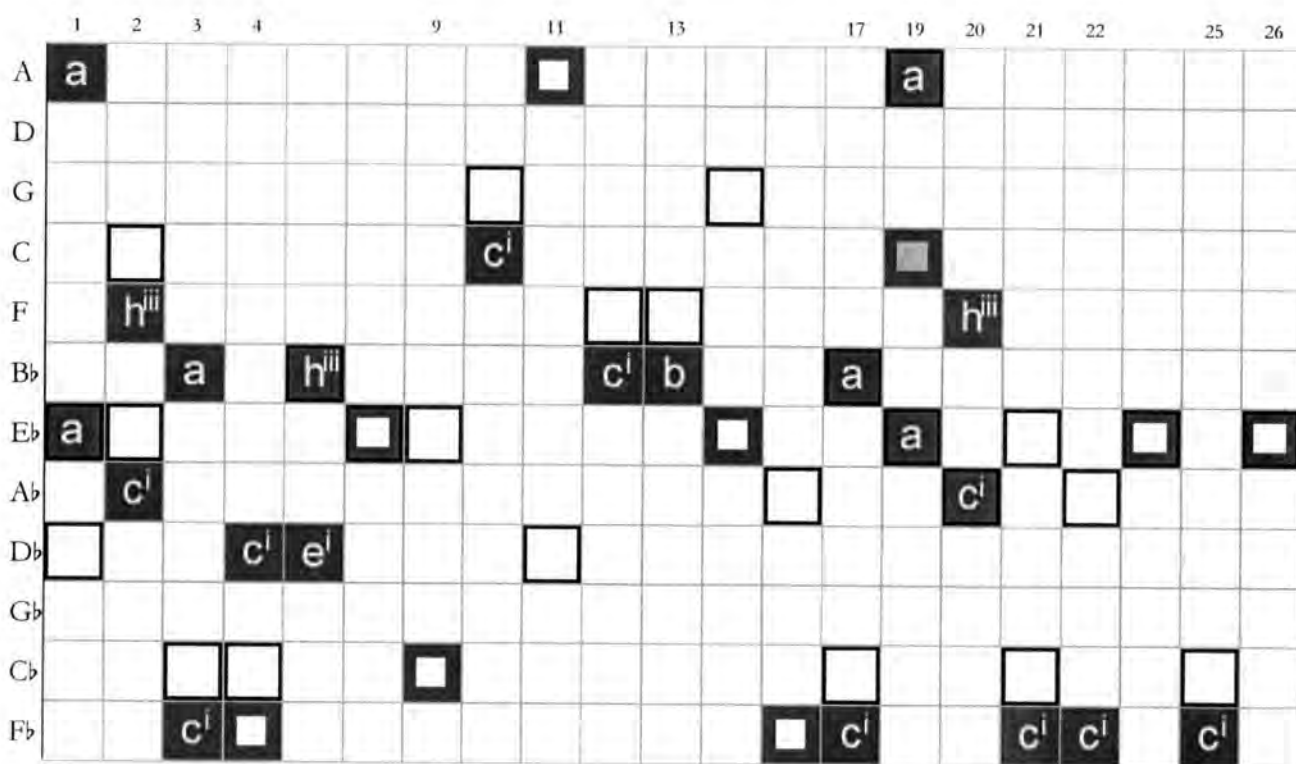

FIGURE 2-28(B): PRELUDE, OP. 56 – DRIVE ANALYSIS

The bass occasionally lies directly north of the drive's square, indicating 'second inversion' patterns; sometimes it lies four squares north, indicating 'first inversions'. A 'third inversion' (seventh relation) surfaces on occasion; indeed the piece begins in this fashion. Sixth relations also arise. In these 'dissonant' bass relations (excluded from the pitches of the triad) the bass acts as a dislocated drive, following its own bent (i.e. m. 21). Between m. 11-13 a cycle of fifths stems from, and returns to, a

pure bass-drive. This same occurs in mm. 17-20, but it is the bass in m. 17 that begins the cycle rather than the strong  $\ell$ -DRIVES on F $\flat$ . The bass then, not only drives the harmony forwards, it drives *itself*, often disengaging from harmonic progressions and initiating new ones.

### Pitch discharges

A 'pitch discharge' ( $\rho$ ) concerns those occasions when a dominant drive, whilst not fully discharging all of its tensions, moves towards a tonic resolution in one or two of its pitches. Perhaps the third of the drive chromatically rises to discharge into scale degree  $\hat{1}$  in a leading-note to tonic motion, whilst the body of the drive remains fixed or else discharges separately. By way of illustration, I use the discharge that occurs in mm. 16-17 of Prelude, Op. 67, no. 1.



FIGURE 2-29(A): PRELUDE, OP. 67, NO. 1, MM. 16-17

	16	17
D#		
G#		
C#		
F#	i	
B		
E	c <sup>i</sup>	
A		■
D		
G	c <sup>i</sup>	
C		p
F		g
B $\flat$	c <sup>i</sup>	

FIGURE 2-29(B): PRELUDE, OP. 67, NO. 1, MM. 16-17

The descending melodic pattern – G-(E)-D-B – harmonically resonates with the F to produce a  $\ell$ -DRIVE on G. Whilst this barely discharges itself onto a C major chord, the leading tone B *does* resolve to the



pitch C. I describe this as a pitch discharge; its vagueness is represented graphically by a light-grey tonic square on the graph and the symbol  $p$ .

### Evaluation of Uses and Limitations of *Drive Analysis*

This survey of each drive type naturally takes leaves of Lerdahl's analytical system; his algorithms have been appropriated only insofar as they hierarchically order this catalogue of dominant chords. To construct a totalising system akin to Lerdahl's that would calculate tension at every moment of Skryabin's music would prove problematic for a variety of reasons. Firstly, Lerdahl's system revolves around a tonal centre, but the free activity of floating tonics is the primary compositional principle in Skryabin's music; the conflict of transitory 'tonics' keeps his harmony in *perpetuum mobile*. True, the final gesture of many works celebrates a tonic chord, but this 'last minute' stabiliser does little to control our perceptions of the preceding sounds. Secondly, Lerdahl's cognitive models rely on a knowledge and appreciation of 'style' which, given Skryabin's stylistic manoeuvre from derivative Chopinesque pastiche to an intimately personal idiom, is difficult to attribute to a listener. A third issue arises from Skryabin's lack of a prevailing sense of 'melody'. Although the composer revels in Classical phrasing, he avoids conventional melodic constructions. A fourth significant problem is that drive strengths are critically affected by their vertical presentation; unusual spacing can rob pitches of their function. In connection with this, discharges are often accompanied by atypical voicing – a fifth issue. But a sixth stumbling block is perhaps the most irksome obstacle to a systematic expansion of drive-hierarchies – the concept of 'polytonality'. In the majority of Skryabin's chords a plurality of drives operate on the vertical plane simultaneously and, naturally, each diffuses the other. It would be inconceivable for this to be contained within a system such as Lerdahl's.

So why is *drive analysis* necessary? The taxonomy of drive strengths works abstractly but locates the important drive types, relating them to each other, exposing moments of contact and exchange, charting the tensile highs and lows on a general level. The other major contribution, as I will attempt to illustrate in Chapters 4 and 5, is the possibility of exploring the constellations that form in different types of space. But the primary advancement is perhaps that the system allows the music to speak for itself, ignoring the straitjackets of conventional analytical tools. *Drive analysis* is designed to work with such conventional systems; it does not find itself at loggerheads with either the Fortean-Schenkerian approach of Baker, nor the *octatonic*, *mystic* and *whole-tone* exchanges of Perle, Wai-ling, Reise, Lerdahl, Callendar and others; *drive analysis* remains detached. This said, it interrogates the validity of certain traditional *dispositifs*; myths such as the *mystic chord* become the product of smaller and, crucially much freer, components that congregate in various ways. Some of these constellations will now be explored in detail.

## Chapter Three

### Drive Analysis and its Vicissitudes

Before scrutinising the broadest level of drive motions in large-scale works, this chapter – an extension of Chapter 2 – focuses on drive patterns and configurations at their most immediate (foreground) levels, whilst critically evaluating *drive analysis* through score-based application. After showcasing various drive ‘gambits’ in Skryabin’s repertoire, I will situate this analysis within current theories of polytonality and close the chapter by tentatively examining ways that drives can be ordered into full musical structures, undertaking a complex analysis of two late pieces.

#### Libidinal Intensity

*Drive analysis* serves, in the main, to showcase the fluctuation of drive strengths. Particularly in passages where drive activity is predominantly ‘monophonic’, it demonstrates the tightening or slackening of drive tensions. In this example from Sonata no. 10, mm. 161-162, Skryabin invests energy in drives on E that grow in strength from an  $h^{\text{II}}$ -DRIVE to a  $c^{\text{I}}$ -DRIVE. For a ready guide to these drive categories, please see either the preceding chapter or the ‘key to the graphs’ at the head of the appendices.



FIGURE 3-1(A): SONATA NO. 10, MM. 161-163



FIGURE 3-1(B): SONATA NO. 10, MM. 161-162 – DRIVE ANALYSIS

This represents a common trope of Skryabin’s works; a drive is ambiguously introduced and gradually crystallised. Such processes often occur polytonally. For example, in m. 243 of Sonata no. 6,  $a^{\text{I}}$ -DRIVES and  $i^{\text{I}}$ -DRIVES on D, G# and E strengthen as the chord changes in the second half of the measure.



FIGURE 3-2(A): SONATA NO. 6, M. 243

The  $i$ -DRIVE was formed from the pitches D and G# that were articulated in the bass, but comes into its own when the octave B's and the trill on E enunciate a  $i'$ -DRIVE on the second beat. Thus the  $i$ -DRIVE is sublimated into a  $i'$ -DRIVE. Even the  $a$ -DRIVES are temporally unfolded, following a weak → strong trajectory. In m. 243 the pitches of an  $a$ -DRIVE on D unravel one at a time: C-F#-D-G#. Thus what we actually hear is an  $i$ -DRIVE on D (C-F#) moving to an  $e''$ -DRIVE on D (C-F#-D), which gives way to  $a$ -DRIVES on D and G# (C-F#-D-G#). But this would be cumbersome to demonstrate graphically, and it is generally reduced to a simple  $a$ -DRIVE. These differences are shown in the following *drive analysis*.

	243		243	
G#	a	a	i	a
C#				
F#				
B				
E	i	i'	i	i'
A				
D	a	a	i	e'' a

FIGURE 3-2(B): REPRESENTED I'J ACTUAL DRIVES

But this drive intensification process can run through larger passages. This extract from Sonata no. 10 is a case in point. Here, third-related drives on F, A and D $\flat$  move from  $f$ -DRIVES to  $i'$ -DRIVES. In fact the drive on D $\flat$  contains a triple metamorphosis from an  $b''$ -DRIVE to an  $f$ -DRIVE to a  $i'$ -DRIVE.





FIGURE 3-3(A): SONATA 10, MM. 222-232

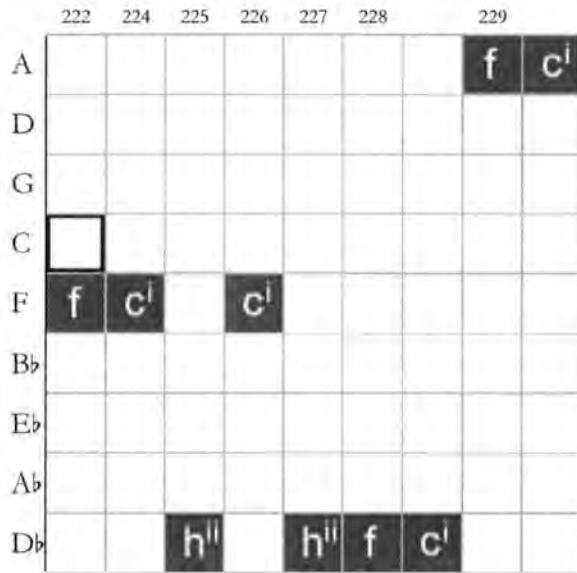

FIGURE 3-3(B): SONATA 10, MM. 222-229 – DRIVE ANALYSIS

Such processes can stretch across even more extensive passages, and in polytonal combinations too. Observe the stratification of drives in the following extract from Sonata no. 5.



4

8

*f* *p*

\* 3

7

8

*accel.*

tre corde 5

9

8

*Presto*

*cresc.*

*accel.*

\*

13

*Languido*

*pp dolceiss.*

*poco cresc.*

*con voglia*

una corda

19

*poco cresc.*

*dim.*

*pp*

*poco cresc.*

*dim.*

25

*pp*

*poco cresc.*

*dim.*

*pp molto languido*

31

*poco cresc.*

*dim. smorz.*

*p dolce*

\*



FIGURE 3-4(A): SONATA NO. 5, MM. 1-36

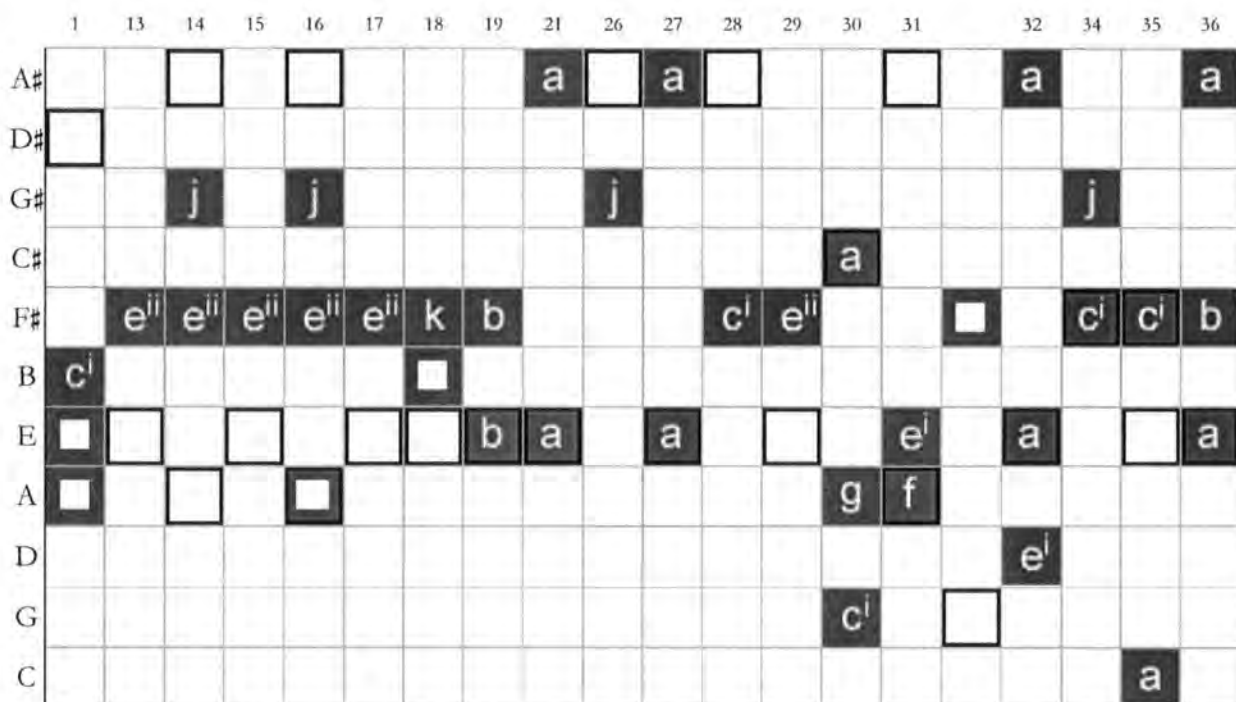

FIGURE 3-4(B): SONATA NO. 5, MM. 1-36 – DRIVE ANALYSIS

The drives on F# in particular undergo a slow metamorphic intensification process. Initially presented as  $e^{ii}$ -DRIVES, they move to an insipid  $k$ -DRIVE before immediately recalibrating into a sturdier  $b$ -DRIVE in m. 19. In m. 28 Skryabin resumes the drive as a weak  $e^i$ -DRIVE, immediately slackening to an  $e^{ii}$ -DRIVE, before tightening it into a  $c^i$ -DRIVE and ultimately a  $b$ -DRIVE in m. 36.<sup>150</sup> On the G# stratum  $j$ -DRIVES remain fixed, whilst on the E stratum  $a$ -DRIVES and  $b$ -DRIVES shuttle back and forth, interrupted only by a rogue  $e^i$ -DRIVE (an incomplete  $b$ -DRIVE).

In such polytonal combinations, *drive analysis* cannot cope with contrapuntal drive activity in line with Lerdahl's computational system; it becomes difficult to assess precise relative strengths or weaknesses. Nevertheless it can at least follow the polyphonic current and expose the fluctuating collisions of drives. M. 3 of *Etrangeté*, Op. 63, flows from a full-blooded  $e^i$ -DRIVE on F# in m. 3 towards an anaemic  $b^{iii}$ -DRIVE on F# in m. 4.

<sup>150</sup> Whilst the  $e^i$ -DRIVE is technically weaker than the  $a$ -DRIVE, it is more conventional, and therefore more distinguishable.

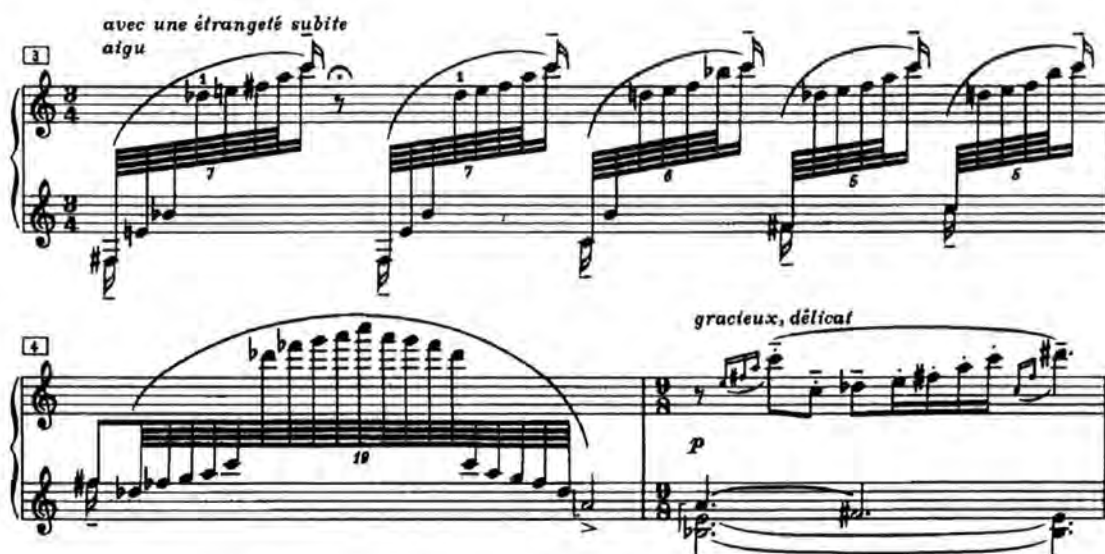

FIGURE 3-5(A): *ETRANGETÉ*, OP. 63, NO. 2, MM. 3-5

	3:1	3:3	4	5		
F#	c <sup>I</sup>	a	h <sup>III</sup>	a	h <sup>III</sup>	a
B						
E						
A				c <sup>I</sup>		
D						
G						
C		a		a		a
F						
Bb						

FIGURE 3-5(B): *ETRANGETÉ*, OP. 63, NO. 2, MM. 3-5 – DRIVE ANALYSIS

Whilst, following Lerdahl, a numerical value can be supplied for the slackening of F# drive tension in m. 3, the bitonal  $c^I$ -DRIVE on A in m. 4 resists computation. Nevertheless, it is certain that the two simultaneous drives diffuse each other in a way that *drive analysis* can demonstrate, even if it cannot calculate. Despite this limitation, the facility to probe Skryabin's polytonal drive combinations and patterns is still available. This will now be shown, though an investigation of the impact of these patterns upon the broadest level of intensity-fluctuation will be postponed until Chapter 4.

## Polytonal Drive Configurations and Patterns

Polytonality as a concept has a somewhat chequered history, which will be discussed in this chapter, but my conception of polytonality pertains more to polytonal discharge – the potential for drives to discharge in simultaneous tonal regions. In some instances, when conventional analysis would locate a single tonal function, *drive analysis* shows how multiple functions can work together. In the following moment from *Caresse dansée*, *drive analysis* locates a bitonal discharge of two *a*-DRIVES (on E and B $\flat$ ).



FIGURE 3-6(A): *CARESSE DANSÉE*, MM. 5-6

	5	6
E	a	
A		a
D		
G		
C		
F		
B $\flat$	a	
E $\flat$		a

FIGURE 3-6(B): *CARESSE DANSÉE*, MM. 5-6 – DRIVE ANALYSIS

More conventional analysis, which generally shuns polytonality, would find nothing more than two chords of identical *pc* content and of dominant character, the first discharging into the second. This interpretation is possible only because the chords share the same drive configuration. But there are hundreds of discharges in Skryabin's repertory where the separate drive elements of a sonority discharge independently. Examining such instances will not only lend credence to *drive analysis* in opposition to prevalent analytical methods, but will hopefully open up some of Skryabin's more intricate compositional techniques.

Daniel Harrison recently coined the term 'double barreled discharge' to categorise moments when two simultaneous chord functions ('dominant' (*D*) and 'subdominant' (*S*)) discharge their perfect and plagal



functions into a shared 'tonic' (*T*).<sup>151</sup> In my more liberated form of polytonal analysis, 'double-barreled discharges' occur when two chords, regarded individually as local dominants, discharge into two separate tonics; I therefore use the term 'double-barreled bitonal discharge'.



FIGURE 3-7: HARRISON'S DOUBLE-BARRELED DISCHARGE AND MY DOUBLE-BARRELED-BITONAL DISCHARGE

I provisionally examined bitonal discharge in Chapter 1 in relation to *Poem*, Op. 71, no. 2 and *Etude*, Op. 56, no. 4. In the light of my work on drive intensity, one can now observe that discharges flow between chords in different drive configurations. Discharges can be categorised according to the patterns that form on *drive analysis* charts; the principal types are 'parallel discharges', 'contrary discharges' and 'nested discharges'.

### Parallel Discharges

The two examples of double-barreled bitonal discharges in Chapter 1 are forms of 'parallel discharge'. Both *D* drives discharge into their own *T*s to create patterns of parallel, descending, diagonal lines on *drive analysis* graphs. In both cases the drives were 'whole-tone' related, but there are many instances when drives of different intervallic relationships are mutually discharged. In m. 15 of, Op. 67, no. 1 *ℓ*-DRIVES on F# and Bb are approached from a *ℓ*-DRIVE and a *ℓ*-DRIVE on their dominants of C# and F. M. 15 also contains an *a*-DRIVE on E, which discharges onto a minor triad on A, whilst a drive on Bb discharges onto a bass pitch Eb (D#). A pitch discharge into C (from a *d*-DRIVE on G which morphs into a *ℓ*-DRIVE in m.16) creates a minor third correlate to the A → E motion, presenting two modally 'relative' discharges. The same occurs with the G's own modal partner – Bb – discharging onto a bass Eb.

<sup>151</sup> Harrison, *Harmonic Function in Chromatic Music: A Renewed Dualist Theory and an Account of Its Precedents*, 105.

FIGURE 3-8(A): PRELUDE, OP. 67, NO. 1, MM. 12-23

	13	14:4	15	17	18:5	19	20	21	22	21:4	23
G#			c <sup>ii</sup>								
C#		c <sup>i</sup>									
F#	g		c <sup>i</sup>					a	a		
B											
E			a	a			k				
A				■		a		h <sup>iii</sup>	c <sup>i</sup>	a	
D					b			c <sup>i</sup>			
G			d			c <sup>ii</sup>					
C	i			p	c <sup>i</sup>			a	a	c <sup>i</sup>	c <sup>i</sup>
F		c <sup>ii</sup>		g		c <sup>i</sup>					
B <sup>b</sup>			c <sup>i</sup>		a						
E <sup>b</sup>						c <sup>i</sup>	c <sup>i</sup>			c <sup>i</sup>	a

FIGURE 3-8(B): PRELUDE, OP. 67, NO. 1, MM. 14-23 – DRIVE ANALYSIS

In mm. 1-2 of the same piece (see figure 2-27) a novel drive configuration outlines a ‘double-barreled bitonal discharge’ of whole-tone related drives, expressed as an  $a$ -DRIVE, a  $k$ -DRIVE, an  $i$ -DRIVE and a  $i$ -DRIVE. Naturally the bass supports the stronger  $a$ -DRIVE and  $i$ -DRIVE, but without the  $k$ -DRIVE and the  $i$ -DRIVE there would be no discharge connections. The weaker drives then become crucial to the discharge of the stronger.

And minor third related ‘double-barreled bitonal discharges’ like those of m. 15 of Prelude, Op. 67, no. 1 are rather common. They lurk in this passage from mm. 3-4 of Prelude, Op. 74, no. 1.



FIGURE 3-9(A): PRELUDE, OP. 74, NO. 1, MM. 3-5

	3	4.3
F#	a	
B		
E		
A	h <sup>i</sup>	
D		c <sup>i</sup>
G		
C	a	
F		c <sup>i</sup>

FIGURE 3-9(B): PRELUDE, OP. 74, NO. 1, MM. 3-4 – DRIVE ANALYSIS

Here, a major triad on A in the middle of the texture (expressed as A, E, D $\flat$ , but preceded by an  $a$ -DRIVE and therefore keeping momentum as an  $b$ -DRIVE) moves in parallel to an  $a$ -DRIVE on C, discharging into minor third related  $i$ -DRIVES on F (spelled as F, B $\flat$ , C and E $\flat$ ) and D.

Whilst minor third relationships become the mainstay, major third related discharges are also common. Figure 3-10 (from Etude, Op. 49, no. 1) highlights  $i$ -DRIVES on D/A $\flat$  and a  $b$ -DRIVE on B $\flat$  discharging simultaneously onto an  $a$ -DRIVE and a  $b$ -DRIVE. Although these two chords contain identical drive

configurations, the second is presented as a discharge of the first; the B $\flat$ /A $\flat$  sevenths of the first's bass become the octave E $\flat$ s of the second; the F $\sharp$  leading note of the first resolves to the G of the second.



FIGURE 3-10(A): ETUDE, OP. 49, NO. 1, MM. 18-21

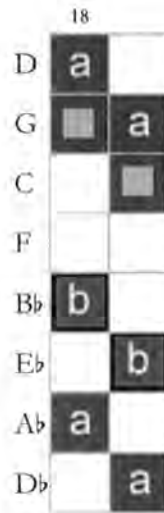

FIGURE 3-10(B): ETUDE, OP. 49, NO. 1, MM. 18

Another noteworthy pattern throughout Skryabin's repertoire is the 'delayed-double-barreled bitonal discharge'. This occurs when poly/bi-tonal elements of a chord discharge one at a time, resulting in the deferred resolution of one of the drives. In Op. 45, no. 1, for example, a pseudo-*mystic* chord in mm. 6-7 yields a C $\flat$  pitch, creating a full  $\ell$ -DRIVE on F as well as G.



FIGURE 3-11(A): FEUILLET D'ALBUM, OP. 45, NO. 1

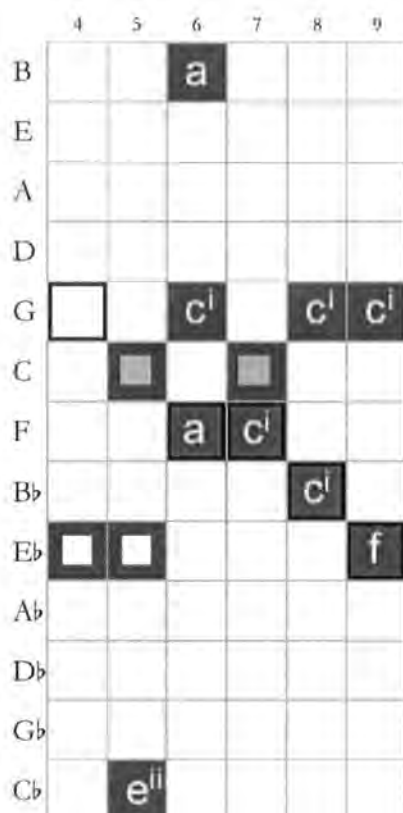

FIGURE 3-11(B): FEUILLET D'ALBUM, OP. 45, NO. 1, MM. 4-9 – DRIVE ANALYSIS

In m. 7 the  $\ell$ -DRIVE on G discharges onto a C minor triad, initially outlined through the octave Cs and now strengthened by the G (articulated half way down the melodic descent) and the E<sup>b</sup> in the upper left-hand. The  $\ell$ -DRIVE on F however, reserves its discharge until m. 8 whereupon the  $\ell$ -DRIVE on B<sup>b</sup> discharges onto E<sup>b</sup> in m. 9. This 'delayed' discharge is clearly the stronger line: G → C → F → B<sup>b</sup> → E<sup>b</sup>. We hear this more predominantly because of (a) the bass support which outlines this sequence and (b) the continuation of this line after other simultaneous drives have been stripped away.

### Contrary Discharges

As shown, whenever a *D* discharge combines with a *S* discharge, a pattern of converging or diverging drives emerges on *drive analysis* graphs. The paradigm of converging discharge is the 'double-barreled discharge' (in Harrison's nomenclature), where two chords, separated by a whole-tone, converge on a local tonic, a single point of discharge that retrospectively confirms the previous chords as *S* and *D* functioned. Continuing my illustration from m. 10 of *Feuillet d'album*, Op. 45, no. 1, a  $b$ -DRIVE on G and a  $\ell$ -DRIVE on A converge onto an  $a$ -DRIVE on D (spelled as E<sup>b</sup> and G<sup>b</sup>).



FIGURE 3-11(C): FEUILLET D'ALBUM, OP. 45, NO. 1, MM. 10-11 – DRIVE ANALYSIS

In such instances of 'double-barreled-discharge', the *S* discharge is 'unnatural' because the *S* function is embodied in a *D* chord – i.e. with the requisite seventh. Thus when drives actually 'converge', they deny their stronger inclination to discharge in parallel directions. Thus I propose that any form of converging discharge involves some degree of 'drive repression'.

But in polytonal structures, the drives rarely retain this paradigmatic *S/D* configuration, and usually lie further apart, discharging onto multiple elements. In m. 14 of Etude, Op. 49, no. 1, tritonally related *a*-DRIVES on A and E<sup>b</sup> converge towards a *k*-DRIVE on D and a stronger *e'*-DRIVE on B<sup>b</sup> – see figure 3-12(b).



FIGURE 3-12(A): ETUDE, OP. 49, NO. 1, MM. 14-15

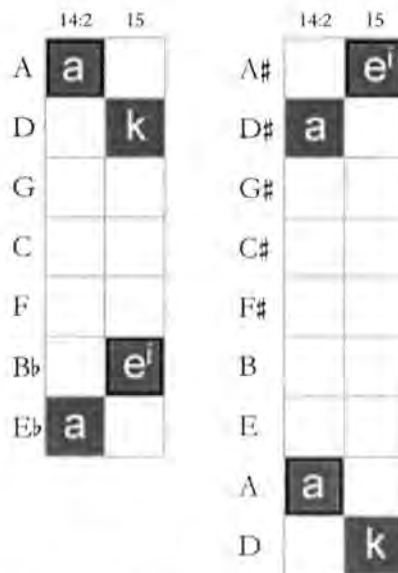

FIGURE 3-12(B & C): ETUDE, OP. 49, NO. 1, MM. 14-15 – DRIVE ANALYSIS

Of course this 'convergence' must be dismissed as an auditory experience; it is an illusion produced by the spatial configuration of *drive analysis* graphs. The tritone drives appear to resolve inwards

(converge), but an orthographic variation could see them resolving outwards (diverge) – see fig. 3-12(c). This second variant would *sound* identical, interpretation resting solely on Skryabin's orthography – a marginalised concern in *drive analysis*. Nonetheless, distinction is made between 'converging' and 'diverging' discharges as a spatial category insofar as they describe relative patterns on the visual drive field. But another factor to consider is the location of the 'bass drive' that can provide a strong sense of key. The following extract, lifted from Op. 45, no. 1, shows two minor sixth related  $i_{\text{DRIVES}}$  on F and D; the bass emphasises the pitch F, making the D sound a 'sixth' above (the pitch being the third of the expected resulting triad of B $\flat$ ). In moments like these, more firmly grounded in tonality perhaps than later works, the categories of convergence and divergence are more clearly defined.



FIGURE 3-13(A): FEUILLET D'ALBUM, OP. 45, NO. 1, MM. 17-21

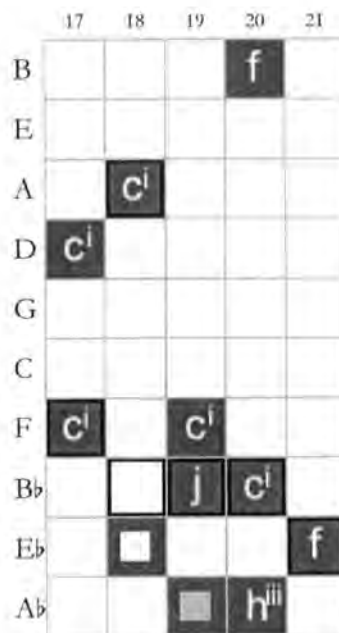

FIGURE 3-13(B): FEUILLET D'ALBUM, OP. 45, NO. 1, MM. 17-21 – DRIVE ANALYSIS

Again the weightier drive on F, emphasised in the bass, is the drive that obeys its dominant implication, continuing a staggered series of fifths. The  $S$  discharge of this contrary-motion pattern remains weakly articulated, fizzling out at the point when it would reach a drive on E in m. 19.<sup>152</sup> The  $f_{\text{DRIVE}}$  on B in m. 20 partially reconnects this chain of fourths, but this weak line surely lies beyond the limits of aural

<sup>152</sup> In a sense, this drive is presented as a simultaneous  $g_{\text{DRIVE}}$  in m. 20 with the pitches A $\flat$ , C $\flat$  and D (G $\sharp$ , B and D).

perception. Nevertheless, such patterns occur in more concrete forms in the repertory. Etude, Op. 56, no. 4, briefly analysed in Chapter 1, contains such a passage. Recasting this section in *drive analysis* now illustrates the strength of the *D* discharge line (descending), against the weaker articulation of the *S* (rising) line.



FIGURE 3-14(A): ETUDE, OP. 56, NO. 4, MM. 17-22 (The melodic 'A' in m. 18 is interpreted as Ab)

	17	18	19	20
F			a	
B $\flat$		i		
E $\flat$	b			
A $\flat$		a		
D $\flat$			a	
G $\flat$				

FIGURE 3-14(B): ETUDE, OP. 56, NO. 4, MM. 17-20 (Some lesser *i*-DRIVES have been omitted to improve clarity)

### Discharge Combinations

Moving towards a discussion of more protracted drive discharge patterns, one must locate moments where both parallel and contrary discharges interact in slightly longer passages. In Prelude, Op. 67, no. 1 – the piece that Lerdahl analyses – fascinating discharge amalgamations are in evidence.<sup>153</sup> This discussion follows figure 3-8, which the reader is now invited to reconsult. M.13 contains a contrary motion double-barreled bitonal discharge; a  $g$ -DRIVE on F $\sharp$  and an  $i$ -DRIVE on C discharge to a  $i'$ -DRIVE on C $\sharp$  and a  $C'$ -DRIVE on F. These new drives discharge in parallel motion to stronger drives on F $\sharp$  and B $\flat$  in m. 15. In this measure four drives on B $\flat$ , G, E and F $\sharp$  are articulated. The drives on E and G

<sup>153</sup> Lerdahl, *Tonal Pitch Space*, 321-333.



discharge in parallel motion to A and C, whilst the drive on B $\flat$  discharges in contrary motion to a  $g$ -DRIVE on F in a  $S$  direction. And this is one of the rare instances in which a  $S$  cycle maintains its trajectory, stretching from B $\flat$   $\rightarrow$  F  $\rightarrow$  C  $\rightarrow$  G. And in mm. 18-19 an interlocking pattern emerges, signifying a tight network of both types of discharge. Skryabin, it seems, constantly keeps drive discharges in flux. Parallel discharges are naturally the most aurally distinguishable but Skryabin finds occasion to allow  $S$ -discharges to flourish. Such patterns however, are generally intersected by  $D$  discharges, assuring the retention of a  $D$  based libidinal flow.

### Nested Discharges

A feature that will later become philosophically important to my discussion of the drive is the 'nested discharge'. Many times, when the layer of clearly articulated patterns and processes is stripped away, subtle discharges remain beneath the surface. This block of  $\alpha$ -DRIVES from Sonata no. 6, forms strata of minor thirds and tritones but also contains various  $\hat{L}$ -DRIVES, which control numerous 'nested discharges' in m. 181, m. 183 and m. 184.

3-15(A): SONATA NO. 6, MM. 180-188

	181	182	183		184	185	186	187
G#	a	a		c <sup>i</sup>		a	a	a
C#								
F#	a					a		
B	a	a				a	a	c <sup>ii</sup>
E								
A								
D	a	c <sup>i</sup>			h <sup>iii</sup>	a	a	c <sup>i</sup>
G			c <sup>i</sup>					
C	a			h <sup>iii</sup>		a		
F	a	a			c <sup>i</sup>		a	a

FIGURE 3-15(B): SONATA NO. 6, MM. 181-187 – DRIVE ANALYSIS

In m. 181  $a_{\text{DRIVES}}$  on F, D, B and G# create a minor third aggregate ‘block’, from which the  $a_{\text{DRIVES}}$  on F# and C (initiated only through the passing pitch B) are exiled. The drive on F# is quickly assimilated back into the minor third structure via a discharge to the B, whilst the C discharges back into the F. In m. 183 the previous drive on D is allowed to discharge to a  $c_{\text{DRIVE}}$  on G, which then discharges onto a weak C and stronger F in turn. This latter drive on C is another alienated drive, assimilating itself to the ‘block’ structure via its motion to F. Such minute discharges are nested within more predominant drive configurations.

### Drive Analysis and the Russian Tradition: Varvara Dernova

Readers aware of the changing face of analytical studies of Scriabin’s music throughout the last century may recognise fragments of Varvara Dernova’s theory in the preceding discourse. Guenther, Baker, Carpenter and Bowers each provide detailed commentaries on Dernova’s system, but it would be remiss to omit a very brief summary of her basic procedures.<sup>154</sup> Based on Boleslav Yavorsky’s harmonic theory of ‘dual modality’, she developed the concept of ‘dual dominants’. Interpreting the French sixth configuration of inter-locking tritones (my  $a_{\text{DRIVE}}$ ) as a dominant-seventh chord with a diminished fifth, she proposed that Scriabin enharmonically respelled the chord complex, altering the bass pitch to create a conflict between two tritonally related keys. She labels the original complex DA and the ‘derived dominant’ (i.e. the tritone equivalent) DB, suggesting that these maintain a kind of

<sup>154</sup> Dernova, *Garmonia Scriabina*; Guenther, *Varvara Dernova’s “Garmonia Scriabina”: A Translation and Critical Commentary*; Guenther, ‘Varvara Dernova’s System of Analysis of the Music of Scriabin.’; Ellon DeGrief Carpenter, *Thematic Development and Continuity in the Ten Piano Sonatas of Alexander Scriabin* (MA: Kent State University, 1972), 24-33; Bowers, *The New Scriabin: Enigma and Answers*, 146-171.

'double tonality' with the commensurate TA and TB representing the two tonics. She posits the theory that Skryabin adds additional tones to this sonority, tones which she terms 'V' and 'W'. Dernova also extrapolates characteristic linear progressions from these sonorities. Some examples of these will be examined in Chapter 7's discussion of the *Poem of Ecstasy*.

Critics of Dernova's work claim that she does not always face the musical facts. Jay Reise calls aspects of her analyses "singularly unconvincing" whilst Taruskin bemoans the inflexibility of her system: "The chief shortcoming of Dernova's approach seems to be the rigidity and abstractness of the schemes on which it is based."<sup>155</sup> Taruskin also exposes the telling fact that Dernova never analyses a single complete piece. Perhaps the main problem is that Dernova's theory is as limiting as the tonal system that Skryabin was seeking to undermine. Guenther, who is both Dernova's greatest advocate and harshest critic, shows how she chooses a tonic and labels its preceding chords retrospectively.<sup>156</sup> This is highly problematic. Daniel Harrison describes how 'position finding' is part of both our analytical and aural experience, but in condensing Skryabin's open tonality into a closed tonic, the ambiguities in which Skryabin revels are lost.<sup>157</sup> But one excellent feature of Dernova's system is her concern with *D* chords rather than *T* chords. She claims: "It would be a mistake to think that the tritone link replaced the tonic, or became the 'tonic' of dual polarity. It both was and remained the 'dominant'".<sup>158</sup> Regarding Dernova's work, Guenther further claims, "the tritone *is* [emphasis mine] the dominant".<sup>159</sup> But less appealingly, Dernova tries to build a system in which the dominant sonority is stripped of its gravitational energy using Sabaneyev's ill-conceived notion that Skryabin's harmony was "non gravitational": "Skryabin is not concerned with harmonic attraction but pure harmony".<sup>160</sup> This unfortunately now accepted view doubtless arises from the lack of *T* resolution to chords that are perceived as *D* functioned. Dernova shows how, in Skryabin's 'middle period', "subdominant harmony gradually but quickly gives place to dominant harmony as if compelled. But there is no further outlet, no transition even to relative stability, which would give an outlet and further direction to the energy".<sup>161</sup> This position seems at odds with the original aims of Boleslav Yavorsky, from whom Dernova derived her whole theory. As Guenther says: "Yavorsky was the first to formulate clearly the concept of polarity as a general system based on the attraction of unstable elements to the nearest

---

<sup>155</sup> Reise, 'Late Scriabin: Some Principles Behind the Style', 221; Taruskin, 'Review: "The Music of Alexander Scriabin"', James M. Baker & "Scriabin: Artist and Mystic", Boris de Schloezer', 149.

<sup>156</sup> Guenther, *Varvara Dernova's "Garmoniia Skriabina": A Translation and Critical Commentary*, 196. Guenther also finds 'mistakes', see 118.

<sup>157</sup> Harrison, *Harmonic Function in Chromatic Music: A Renewed Dualist Theory and an Account of Its Precedents*, 73-90.

<sup>158</sup> Guenther, *Varvara Dernova's "Garmoniia Skriabina": A Translation and Critical Commentary*, 189.

<sup>159</sup> *Ibid.*, 57.

<sup>160</sup> *Ibid.*, 45.

<sup>161</sup> *Ibid.*, 49.

stable elements.”<sup>162</sup> This is surely all about tonal ( $D \rightarrow T$ ) attraction and tension structures. Essentially, Dernova’s work is not always compatible with the objectives to which it lays claim.

## Dernova and Polytonality

Nonetheless, without being illuminating in itself, Dernova’s system sheds at least some light on the various tensions that operate upon a chord in a single vertical moment. James Baker’s critique of Dernova attempts to expose her system as a crude form of ‘polytonality’. This same polytonality has proved a thorny issue in recent times, and requires a heavy pruning before it can be useful to Skryabin studies. Considered by Baker to be an auditory impossibility, it is simply dismissed out-of-hand, for which Richard Taruskin offers reproof.<sup>163</sup> Polytonality is a particular feature of Russian analysis, despite being discredited by Anglo-American theorists, but it is increasingly coming into vogue through the work of Daniel Harrison.<sup>164</sup> It seems that the issue of polytonality (or bitonality) has remained contentious since the term was accepted into musicological parlance, popularised through Darius Milhaud’s 1923 essay ‘Polytonality and Atonality’ in *Revue Musicale* which listed numerous ways of superimposing chords and melodies. Peter Kaminsky offers an excellent introduction to problems of polytonality in a recent issue of *Music Theory Spectrum*, citing James Baker’s complaint – itself an echo of Milton Babbitt and Paul Hindemith – that it is impossible for a listener to perceive two tonics at the same time. Kaminsky takes the opposite view and, without citing specific sources, he reposts, “Several published studies argue that a listener is capable of attending to two simultaneous pitch centres.”<sup>165</sup>

But moving from a cognitive to a compositional viewpoint, Baker admits that it “does seem to reflect the way that certain composers put their music together.”<sup>166</sup> That said, polytonality is considered a rather base form of composition. According to Daniel Harrison, Pieter van den Toorn calls polytonal composition one of the “horrors of the musical imagination.”<sup>167</sup> Harrison himself declares that bitonality has lost *cache* through its use as a ‘cheap parlour trick’: “Write some ditty in one key, write the accompaniment in another, and voila – something that sounds as bad as the most studiously atonal utterance of a real, hard working composer.”<sup>168</sup> Nonetheless, the task of revitalising the concept is long under way. Kaminsky embarked on such a journey by interrogating polytonality’s detractors, dismantling each objection in turn. Arguments against Milhaud’s original proposition of polytonality, as Kaminsky sees it, focus on (1) the equal weight of the superimposed elements, with little regard for the

---

<sup>162</sup> *Ibid.*, 9.

<sup>163</sup> Taruskin, ‘Review: “The Music of Alexander Scriabin”, James M. Baker & “Scriabin: Artist and Mystic”, Boris de Schloezer’.

<sup>164</sup> Harrison, ‘Bitonality, Pentatonicism, and Diatonicism in a Work by Milhaud’.

<sup>165</sup> Peter Kaminsky, ‘Ravel’s Late Music and the Problem of ‘Polytonality’’, *Music Theory Spectrum* (2004), 238.

<sup>166</sup> *Ibid.*

<sup>167</sup> Harrison, ‘Bitonality, Pentatonicism, and Diatonicism in a Work by Milhaud’, 393.

<sup>168</sup> *Ibid.*, 393-394.

prominence of the bass of a given texture, and (2) the fact that many instances of bitonality can be analytically subsumed by other tonal systems.

Answering the first objection, Kaminsky shows how a composer creates interesting dialectical relationships between superimposed sonorities, giving varying degrees of emphasis to either the treble or the bass. He breaks apart the texture of Ravel's setting of Mallarmé's *Surgi de la croupe et du bond*, to find a bass centred around E $\flat$  and violin harmonics in the key of D that vie for prominence. Emphasis perpetually shifts but is largely bestowed upon the treble voice. This whole scene is likened to Mallarmé's text, telling of the two mouths of a chimera (a monster with incongruous parts): "To convey these highly esoteric images, Ravel creates timbral and tonal lines which retain their incongruity."<sup>169</sup> Kaminsky presents two interesting analyses of the melodic line viewed through the prisms of both keys E $\flat$  and D, interpreting many of the melodic 'D notes' as 'unresolved appoggiaturas' in the E $\flat$  key. Although the analysis is not extensive, and stops short of codifying the relationships between the accompanying chords as they are presented syntactically, his melodic analysis convincingly mediates two distant keys. However, if Kaminsky had followed his line of argument to its conclusion, he may have found the 'leading note' qualities of the pitch D in E $\flat$  to undermine his reading. The upper tessitura which, as he suggests, contains pure elements in the key of D, is made subservient to its harmonic grounding in E $\flat$ . Nevertheless he maps a new way of reconciling seemingly disparate keys. Kaminsky goes some way towards showing how our perceptions of bitonality can be orientated through another Ravel analysis, this time from the *Teacup* and the *Teapot* duet from *L'Enfant et les Sortilèges*. He shows how two keys can be unfolded dialogically, one after the other, before there is any superimposition of keys *per se*. Polymodality is displayed once again through programmatic portrayals of race, the Chinese character being given the black pentatonic notes. Similar racial depictions are offered in the song "Beware of the White People", in which Kaminsky further shows how battles for precedence can be played-out in narrative form. At one point, the bass takes total priority by subsuming the vocal line, removing it from the control of the piano's treble register. In another analysis of *Blues*, Kaminsky shows how cadencing can also affect narratives in which 'prominence of key' is an issue. The left-hand of the piano undermines the control of the right-hand, working itself forcefully into the dialogue. Ravel's polytonal practices lead Kaminsky to two findings: (1) programmatic justification underlines many instances of polytonality, and (2) polytonal keys compete in dialogic power struggles. This successfully refutes the first objection to polytonality that Kaminsky cites.

---

<sup>169</sup> Kaminsky, 'Ravel's Late Music and the Problem of 'Polytonality'', 246.

In answer to polytonality's second criticism – that it is always supplanted by other tonal systems – Daniel Harrison examines the roots of bitonality. This criticism was foregrounded by analyses of Stravinsky's *Petrushka* chord, which famously superimposed C and F# chords. Arthur Berger traces the chord to Stravinsky's octatonicism, thus over-riding bitonal analyses.<sup>170</sup> Harrison avoids this pitfall by using Forte's set theory to explore the deployment of bitonal chords and modes. In his analyses of Milhaud, he explores the frequent cyclic t5 transpositions of various sets (3-9, 4-23, 5-35, 6-32, 7-35, 8-23, 9-9), showing how elements of these sets, with varying degrees of tonal association, are heard vertically in the distantly related intervals of minor seconds, minor thirds and tritones. He analyses passages showing the reverse of those procedures found by Kaminsky in Ravel; he finds that moments of bitonal intensity become less intense as the disparate t5 cycles converge towards common tones or single sets in Milhaud's piece. Through the merger of the 5-cycle sets, Milhaud converges phrases towards common points, "the zone of separation between clusters of series fragments decreases. If the sets are sufficiently large, the zone disappears, and from a pitch class perspective alone (that is, not attending to instrumentation or melodic presentation), bitonality essentially disappears".<sup>171</sup> Unlike Berger's analysis of Stravinsky, in which bitonality is explained through an 'other' tonal system (the octatonic scale), Harrison gives a detailed exposition of how these 'other' systems (often pentatonic) work within a bitonal context. This successfully turns the second argument against polytonality on its head.

It seems that work on bitonality is mostly associated with French music, particularly with Kaminsky's focus on *Les Six*. But work on Debussy has been less fruitful. Despite the fact that many of Debussy's harmonies are constructed of ninth, eleventh and thirteenth chords, which contain elements of superimposed triads, Boyd Pomeroy recently asserted, "Debussy's later music continued for the most part to be governed not only by triadic consonance but (nearly always) by the principle of monotonicity."<sup>172</sup> However, monotonicity is not uncomplicated. Harald Krebs' article explores the phenomenon of 'directional tonality' in the 19<sup>th</sup> century, in which a piece begins and ends in a different key; in such cases the final key is shown to be at work throughout the piece – a form of 'monotonicity'.<sup>173</sup> Pomeroy casts Debussy's 'monotonicity' in this light by illustrating the interplay of twin tonics. He looks at directional tonality in Chopin, characterising it by third relations; he also looks at Nielsen's works, finding bitonal fifth relations, further showing how mono-directional tonality is generally associated with the use of a common tone. Pomeroy distances himself from issues of bitonality, citing Felix Saltzer as an opponent to bitonal theories. Thus Pomeroy discusses a bitonality of a different nature – a diachronic phenomenon rather than a synchronic one. He talks of 'tonal

<sup>170</sup> Berger, 'Problems of Pitch Organization in Stravinsky'.

<sup>171</sup> Harrison, 'Bitonality, Pentatonicism, and Diatonicism in a Work by Milhaud', 401.

<sup>172</sup> Boyd Pomeroy, 'Tale of Two Tonics: Directional Tonality in Debussy's Orchestral Music', *Music Theory Spectrum* (2004).

<sup>173</sup> Harald Krebs, 'Alternatives to Monotonicity in Early Nineteenth-Century Music', *Journal of Music Theory* 25/1 (1981).

pairing' from Harald Krebs, a situation where two keys compete along a linear axis without having any specific sense of direction. Debussy, like Nielsen, seems to use fifth relationships; Pomeroy cites *La Mer* and *Sirens* as examples. But his central analysis takes *Gignés* and the directional tonality of F minor to Ab, but exposes the emergence of a third tonic (D), categorised as an anti-goal. He does however attempt to show how these two directional tonics vertically coincide at times. For example, he explores Debussy's predilection for 'clouding' bass pedals through over-imposing the 'other' tonic; *Ondine* is his primary example. And in the third movement of *Iberia*, his analysis draws explicitly closer to bitonality, when he shows how material becomes fixed to specific keys (C and G), which then cross-over. Chromatic procedures begin to creep into the texture and eventually reach an *impasse*, where the tonic is then reasserted through "brute force".

Returning to my studies of polytonality in Skryabin's music we read that Dernova, and certainly Roy Guenther, adopt it unreservedly. Dernova regarded the contemporary model of Skryabin analysis drawn by Dickenmann as 'naïve', and this was echoed by Guenther who claimed, "He applies only a mechanical calculation to the vertical arrangement of notes, not suspecting that it is simply the superimposition of harmony above a pedal (like a polyfunctional combination)".<sup>174</sup> But neither of these two theorists champion the cause of bitonality explicitly; it is often taken as a Russian 'given'. As I will discuss later, another Russian progenitor of bitonal analysis is Viktor Belyayev who, in 1972, undertook a Riemannian functional analysis of Skryabin's *Poem of Ecstasy*, in which chord functions are vertically compounded.<sup>175</sup> One must not discount the quirkiness of the Russian analytical tradition here; the playful Yavorsky, for instance, analyses the first part of Beethoven's *Appassionata* as being in the key of Db major instead of F minor.<sup>176</sup> This open approach to 'key finding' is something that I also wish to retain in my analyses, which largely transcend the concept of 'key'.

Through *drive analysis*, two new routes emerge which lead bitonality back into the analytical arena.

Firstly, I never claim that two keys operate at the same time or are meant to be distinguished. Rather, I suggest that, through the use of dominant drives, many keys are simultaneously indicated in various combinations. But unlike Dernova, I do not imply that Skryabin consciously wrote in two keys at once; I simply claim that, through the dominant driven complexity of his vertical sonorities, certain implications arise that may or may not be realised in the musical narrative. Secondly, I claim that these drive-based implications work dialectically *within* other systems – octatonic, whole-tone, mystic or tonal – and are not displaced by them.

---

<sup>174</sup> Guenther, *Varvara Dernova's "Garmonii Skriabina": A Translation and Critical Commentary*, 9.

<sup>175</sup> Belyayev, *Musorgskii, Skryabin, Stravinskii*.

<sup>176</sup> Guenther, *Varvara Dernova's "Garmonii Skriabina": A Translation and Critical Commentary*, 19.

## Critique of the 'Tritone Link'

Dernova's framework is simply too restrictive. Skryabin certainly *does* exploit the shared tritone between tritonally opposed dominant-seventh chords, but this is only one technique of many. The project of opening up this binary opposition occupies a similar position to that of Gilles Deleuze who formulated his *anti-dialectic* in antipathy to the dialectical negations that forge oppositional relationships at the expense of infinite ones.<sup>177</sup> In Skryabin's multi-dimensional harmony, conflicts occur both spatially and temporally where Dernova finds only temporally articulated tritone axes. As I soon explore, there are many other moments in Skryabin's repertoire where freer drive relationships are present. The aim of this study is certainly not to discredit Dernova's 'tritone link' (my  $a$ -DRIVE), rather to expose the duality of the 'dual dominant' as one single relationship amongst others, and to deny the organising power that Dernova attributes to it. For example,  $i$ -DRIVES quite often relate by a tritone, proving that Skryabin does not rely exclusively on the 'compromised' (diminished) dominant form to lock drives together; they can be used in their pure state. In Poem, Op. 63, *Etrangeté*,  $i$ -DRIVES alternate in mm. 9-15. As each drive oscillates between B $\flat$  and E, and then A $\flat$ /D, so does the bass, which strengthens the alternation process. This whole passage lends credence to Dernova's extension of Yavorsky's 'Dual Modality', but weakens the specificity of her 'tritone link' – after m. 9 there is not a single  $a$ -DRIVE in this passage that is not also a  $i$ -DRIVE until m. 15:3.<sup>178</sup>

<sup>177</sup> G Lambert, 'Deleuze and The "Dialectic" (A.K.A. Marx and Hegel)', *Strategies: Journal of Theory, Culture & Politics* 15/1 (2002); Lutz Ellrich, 'Negativity and Difference: On Gilles Deleuze's Criticism of Dialectics', *MLN* 111/3 (1996).

<sup>178</sup> M. 19 does use E, D, G $\sharp$ , A $\sharp$  – an  $a$ -DRIVE – but the A $\sharp$  resolves to B as an appoggiatura.





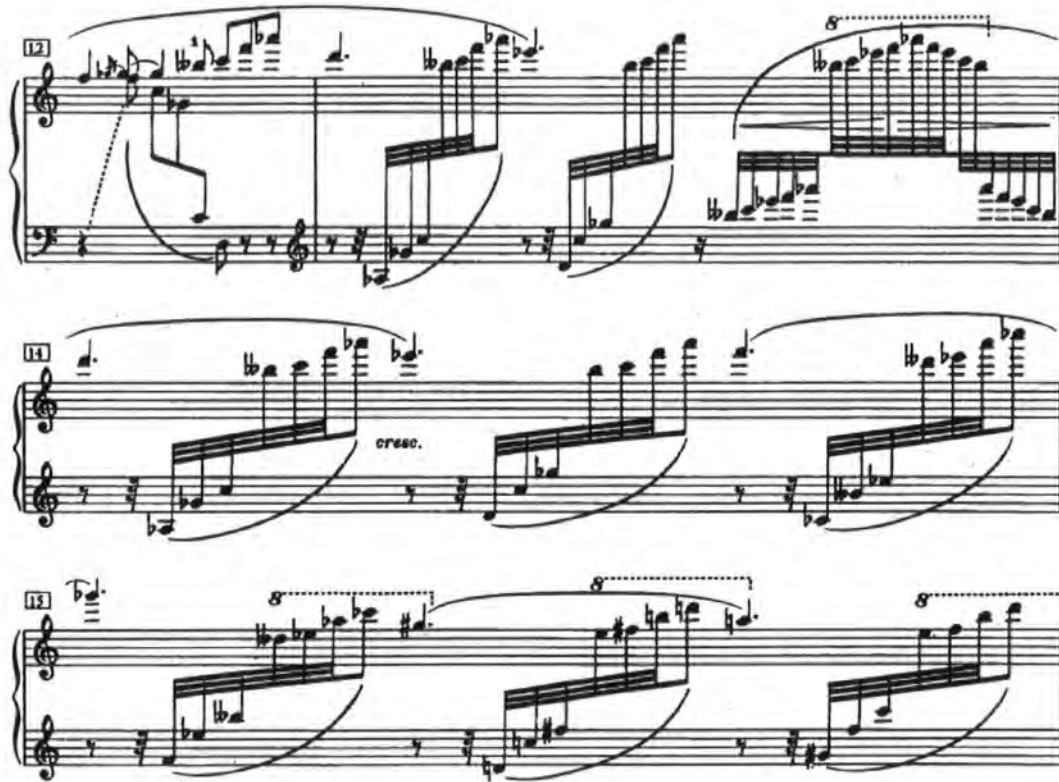

FIGURE 3-16(A): POEM, *ÉTRANGETÉ*, OP. 63, NO. 2, MM. 9-15

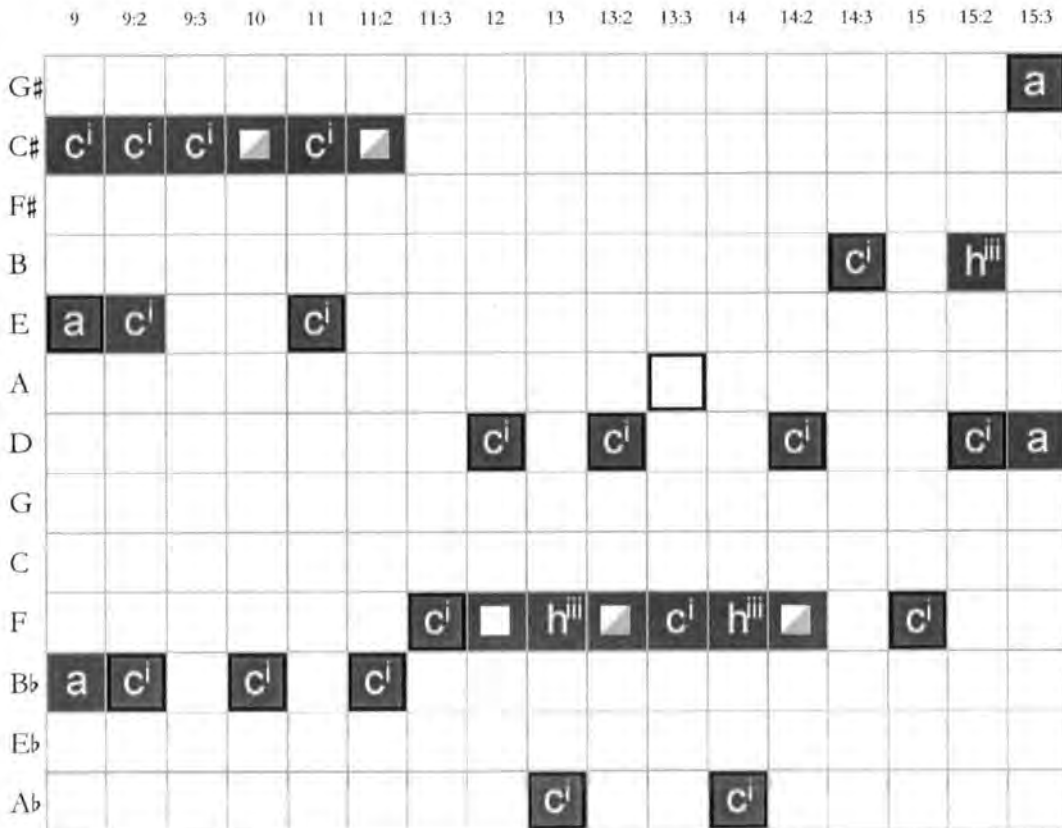

FIGURE 3-16(B): POEM, *ÉTRANGETÉ*, OP. 63, NO. 2, MM. 9-15 – DRIVE ANALYSIS

And there are further instances of variable, fluctuating tritone-related drives, ordered in a much looser way than Dernova proposes. I examine Sonata no. 6 in Chapter 4, exploring the tritone's active organising potential at the work's background. But even in this preliminary chapter the sonata shows foreground manifestations of 'dual modality'. In the following illustration from mm. 25-30, tritone drives on  $B\flat/E \rightarrow D\flat/G$  discharge onto  $G\flat$ . In m. 25 and 26 Skryabin employs  $\ell$ -DRIVES, but in m. 27 an  $a$ -DRIVE on G challenges this relationship with the initiation of the diminished fifth ( $D\flat$ ) in the bass (though this does rise to an  $E\flat$  (D)) as in the preceding measure.

The musical score consists of three systems of staves. The first system (measures 22-25) shows a piano introduction with a *cresc. poco a poco* instruction. The second system (measures 26-27) includes the instruction *un peu plus lent* and features a dynamic shift to *f*. The third system (measures 28-30) includes a *pp* dynamic and a *5 e sopra pochiss.* marking. The score is annotated with various musical notations such as slurs, accents, and fingerings.

FIGURE 3-17(A): SONATA NO. 6, MM. 22-30

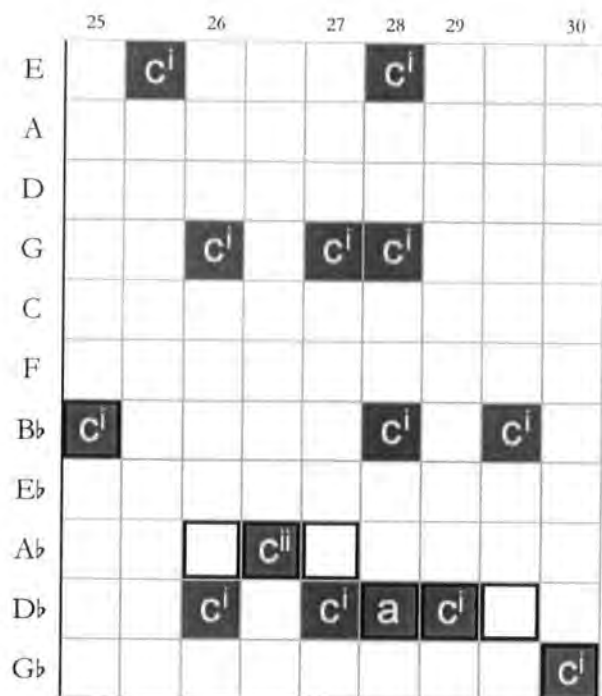

FIGURE 3-17(B): SONATA NO. 6, MM. 25-30 – DRIVE ANALYSIS

$C$ -DRIVES thus challenge ostensibly immutable bodies of  $a$ -DRIVES. Such is the case in mm. 95-96, where a  $c$ -DRIVE alternates between A and E $\flat$  drives.



FIGURE 3-18(A): SONATA NO. 6, MM. 95-96

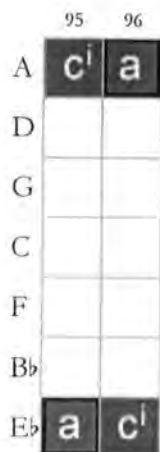

FIGURE 3-18(B): SONATA NO. 6, MM. 95-96 – DRIVE ANALYSIS

My standard practice in *drive analysis* is to indicate the strongest drive, so that if a  $\flat\hat{5}$  is struck together with a  $\sharp\hat{5}$ , the flattened version should be specified. However, there are times when the integration of  $\sharp\hat{5}$  and  $\flat\hat{5}$  becomes a feature. This is perhaps another problem with *drive analysis*, which can buckle under the weight of multiple drives that indicate the same discharge chord: one drive is selected at the expense of others, often the more recognisable and normalised seventh chord. Nonetheless, scratching beneath the surface reveals that Dernova's 'tritone link' is not such an irreducible feature of Skryabin's harmony. And this is deeply engrained in the fabric of Sonata no. 6. In the following climactic instance from m. 260, tritone related drives that articulate G and C# are discernible as an  $a$ -DRIVE and a  $c^\sharp$ -DRIVE:



FIGURE 3-19(A): SONATA NO. 6, M. 260

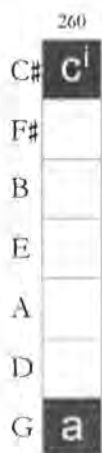

FIGURE 3-19(B): SONATA NO. 6, M. 260 – DRIVE ANALYSIS

And in mm. 320-323 the configuration that I examined in reference to the  $i$ -DRIVE in Chapter 2 is located, its drives tritonally related and separated by a fourth (or a minor second depending on which pole of the tritone is counted). Of course the  $i$ -DRIVE is essentially half an  $a$ -DRIVE: a watered-down form of the 'tritone link'.



FIGURE 3-20(A): SONATA NO. 6, MM. 315-327

	320	321	322	323
F#	i	i	C <sup>i</sup>	
B	i	i		
E				
A				
D				
G				
C	C <sup>i</sup>	i		
F	i	i		

FIGURE 3-20(B): SONATA NO. 6, MM. 320-323 – DRIVE ANALYSIS

These vertical relationships are also horizontalised into a  $\ell$ -DRIVE on F# and a triad on C in mm. 322-323: a much less symmetrical configuration than the 'tritone link'. And it is in these free tritone relationships that Dernova's rigorous analytical theory, based on the t6 self-replicating *French sixth* chord, begins to crumble.

In this way the famous *mystic* chord can be unmasked and the myth behind it deconstructed. Scriabin mentioned the chord only in relation to *Prometheus*, Op.60 – his fifth symphony – applying the sobriquet, 'the chord of the Pleroma'.<sup>179</sup> It was his associate Leonid Sabaneyev who applied it to other

<sup>179</sup> Taruskin, 'Scriabin and the Superhuman: A Millennial Essay', 341.

works such as the seventh sonata.<sup>180</sup> Literature on Scriabin quickly became awash with loquacious accounts of this most infamous chord.<sup>181</sup> But to *drive analysis*, the chord is a configuration of drives:

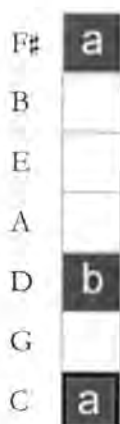

FIGURE 3-21: THE MYSTIC CHORD – DRIVE ANALYSIS

This organisation – *a*-DRIVES on C/F# with a *b*-DRIVE on D – gives priority to the strongest drive form, but weaker drives are at work within. The *b*-DRIVE on D includes the B $\flat$  pitch, acting as the enharmonic augmented fifth, but the A is also a naturalised fifth and thus forms a complete *c*-DRIVE. This drive on D relates either as a major third to the drive on F# or as a whole-tone to the drive on C, and I will henceforth label this ‘the *mystic* configuration’. This configuration of drives occurs in many places, and with different drive ‘intensities’, crying out for the *mystic* chord to be exposed as a hypostatisation, a Lyotardian *dispositif*.

A previous example from Sonata no. 6 (fig. 3-2), which should require no further explanation, serves to remind us that these intensifying drives act as variants of *mystic* intensity whilst preserving the *mystic* configuration.



FIGURE 3-22(A); SONATA NO. 6, MM. 241-243

<sup>180</sup> Leonid Sabaneyev, ‘The Seventh Piano Sonata, Op.64’, *Muzjka Weekly* 64 (1912).

<sup>181</sup> Space will not be given to a summary of such accounts in this thesis, and the reader is directed towards the excellent summary provided in Kevin Peacock’s dissertation: Kenneth John Peacock, *Alexander Scriabin’s Prometheus: Philosophy and Structure* (PhD, Michigan: University of Michigan, 1976), 129 ff.

	242	243
G#		e <sup>  </sup> a
C#	a	
F#		
B		
E		i c <sup> </sup>
A		
D		e <sup>  </sup> a
G	a	
C		p

FIGURE 3-22(B): SONATA NO. 6, MM. 242-243 – DRIVE ANALYSIS

Glancing back at an earlier citation from *Album leaf*, Op. 45, no. 1 (see fig.3-11, a, b and c) reveals the same principle. Tritonally related drives on B and F in m. 6 sequester a drive on G arranged as a  $c^{\text{I}}\text{-DRIVE}$  rather than a  $b\text{-DRIVE}$ . And it is this ‘conventional’ dominant intensity that is selected to resolve first onto its pseudo-tonic of C.

Here is the entire score and *drive analysis* graph of Prelude, Op. 74, no. 1:

**Douloureux déchirant**

FIGURE 3-23(A): PRELUDE, OP. 74, NO. 1

	1	2	3	4	5	6	7	8	9	10	11	12	13	14		
D#	c <sup>i</sup>	c <sup>i</sup>														
G#																
C#																
F#	c <sup>i</sup>		c <sup>i</sup>		c <sup>i</sup>	a		c <sup>i</sup>	a	c <sup>i</sup>	a	c <sup>i</sup>	a	c <sup>i</sup>	a	
B																
E																
A		a		a				c <sup>i</sup>		c <sup>i</sup>		c <sup>i</sup>				
D						h <sup>iii</sup>	a				b		b		b	
G																
C	c <sup>i</sup>		c <sup>i</sup>		a	a				a	c <sup>i</sup>	a	c <sup>i</sup>	a	c <sup>i</sup>	a
F						c <sup>i</sup>										
B <sup>b</sup>																
E <sup>b</sup>							e <sup>ii</sup>		c <sup>i</sup>	b	c <sup>i</sup>					
A <sup>b</sup>						c <sup>i</sup>	a									

FIGURE 3-23(B): PRELUDE, OP. 74, NO. 1 – DRIVE ANALYSIS



Notice how drives are initially arranged in minor third intervals i.e. C, A, F#, D#. But in m. 10 the *mystic* configuration materialises, nurturing *i'*-related tritone-drives rather than (or as well as) *a*-DRIVES. However, in m. 11, an *a*-DRIVE variant of these same elements appears, and not until the very final chord are they calibrated into a *mystic* chord in its 'home' configuration.<sup>182</sup>

Sometimes the intensities of the *mystic* configuration suffer only minor adjustments. In m. 5 of *Caresse dansée*, Op. 57, the *b*-DRIVE element is diluted into an anaemic *i*-DRIVE. Contextually this *i*-DRIVE on C and the *a*-DRIVE on B $\flat$  are the discharge chords of previous drives on G and F (a *k*-DRIVE and an *f*-DRIVE). And these continue to discharge through the appropriate elements of the *mystic* chord.



FIGURE 3-24(A): *CARESSE DANSEE*, OP. 57, MM. 1-8

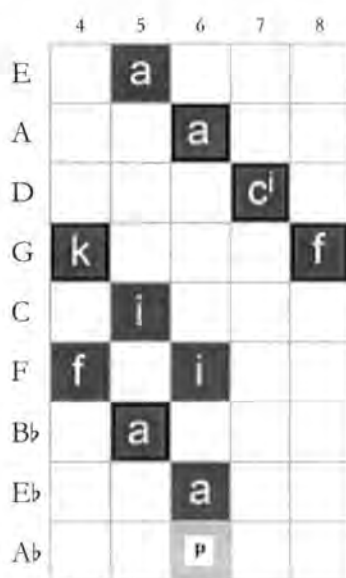

FIGURE 3-24(B): *CARESSE DANSEE*, OP. 57, MM. 4-8 – DRIVE ANALYSIS

<sup>182</sup> A full *mystic* chord however, would have an additional 'A' rather than a G here. The more usual A pitch bolsters the D' element, whilst the G reinforces the C' element.

Such adjustments, though undeniably minor, show the *mystic* chord to be a product of drive interactions and diffusions whose intensities perpetually fluctuate. Dernova's work is valuable as it reformulates *some* of Skryabin's drive processes, but her system selects the individual at the expense of the multiplicity.

## Drives and Stylistic Change

Skryabin's control of musical drives changed as his compositional style developed. Cataloguing his basic practices and dividing them to stylistic periods of composition will be my concern in the remaining part of this chapter, as I focus on Skryabin's 'middle' to 'late' repertory. It is generally recognised that Skryabin's 'middle' period encapsulates the time immediately following the termination of his teaching duties at the Moscow conservatoire in 1903. The inception of the 'late' period is somewhat more equivocal.<sup>183</sup> The fact that authors do not agree about the dates of a late style is testament to the seamless metamorphosis that occurred. The 'atonal' character of *Prometheus*, Op. 60, seems to qualify it as a watershed work, and even though the preceding opuses contain equally progressive elements, I generally situate this work at the frontier between the two stylistic worlds. However, in the following characterisation I select works that show extremes of stylistic change, wherever they appeared chronologically.

### (1) Middle Tendencies (1903-1908)

One of the prevailing drive 'vicissitudes' of the middle-period is the propensity for intense complexes to defer to one particularly strong drive. The process is reminiscent of Herbert Spencer's 'survival of the fittest', a doctrine that Skryabin must have known well; the stronger drive, after over-turning the weaker ones, runs its course along a line of fifths.<sup>184</sup> Many middle-period Skryabin pieces use this template. *Feuille d'album*, Op. 45, no. 1, which has illuminated many drive operations in the investigation thus far, can again exemplify this phenomenon.



<sup>183</sup> Faubion Bowers provides convincing periodisation (based more biographically than musically), dividing Skryabin's career into 'beginning life' (1872-1903), 'middle years' (1903-1912) and 'later years' (1912-1915).

<sup>184</sup> The bookshelf in Skryabin's Moscow flat contains copies of Spencer's works.



FIGURE 3-25(A): FEUILLET D'ALBUM, MM. 7-16

	6	7	8	9	10	11	12	13	14	15	16
B	a										e <sup>ii</sup>
E											
A					c <sup>i</sup>			c <sup>i</sup>			
D						a					
G	c <sup>i</sup>		c <sup>i</sup>	c <sup>i</sup>	b		c <sup>ii</sup>			c <sup>i</sup>	
C		□			h <sup>ii</sup>			c <sup>i</sup>			
F	a	c <sup>i</sup>							c <sup>ii</sup>		
B <sup>b</sup>			c <sup>i</sup>							e <sup>ii</sup>	j
E <sup>b</sup>				f							□

FIGURE 3-25(B): FEUILLET D'ALBUM, MM. 6-16 – DRIVE ANALYSIS

As I examined with regard to the ‘delayed-double-barreled bitonal discharge’, a strong undercurrent of *D* discharges in mm. 6-9 is crucial to the establishment of the fifth-based discharge as the musical currency. This crystallised in mm. 10-16 where a bass-articulated series of discharges stretches from a  $\ell$ -DRIVE on A through to a major triad on E<sup>b</sup>. This particular line is less mechanically sequential than other middle-period examples: a  $\ell$ -DRIVE  $\rightarrow$  a-DRIVE  $\rightarrow$   $\ell$ <sup>ii</sup>-DRIVE  $\rightarrow$   $\ell$ -DRIVE  $\rightarrow$   $\ell$ <sup>ii</sup>-DRIVE  $\rightarrow$   $\ell$ <sup>ii</sup>-DRIVE  $\rightarrow$  triad. This concatenation harbours no repetition or sequences of drive types. The difference between this and other middle-period paradigms is analogous to the difference between ‘through-composed’ and ‘strophic’ song-forms. In *Caresse Dansée* the cycle of fifths is based on ‘strophic’ sequentially repetitious drive patterns, as I will show later in the chapter. This said, a ‘through-composed’ *D* cycle also weaves its way into the Etude, Op. 56, no. 4 – analysed in Chapter 1.

## (2) Late Tendencies (1909-1915)

A prevailing characteristic of Skryabin’s latest compositions is the intense vertical coagulation of drives into viscous sonorities. Whereas previously the drive elements of a chord revealed themselves to a listener by unfolding their aspects individually, they now become dense vortexes. The drives, which could previously be reasonably processed by a listener, now become so entwined that, at times, *drive*

analysis can seem redundant. Here is the opening of Sonata no. 6, Op. 62, which temporarily unfolds a singular germinal sonority:

The musical score shows the first 12 measures of the piece. It begins with a piano introduction marked 'mystérieux, concentré' and 'mf'. The first system (measures 1-4) features a series of chords and a melodic line with an ornament. The second system (measures 5-8) continues with a 'pp' dynamic and a 'p' dynamic, showing a melodic line with ornaments and a bass line with a triplet. The third system (measures 9-12) is marked 'avec une chaleur contenue' and 'cresc. poco', featuring a melodic line with ornaments and a bass line with a triplet. The piece concludes with a final chord in measure 12.

FIGURE 3-26(A): SONATA NO. 6, MM. 1-12

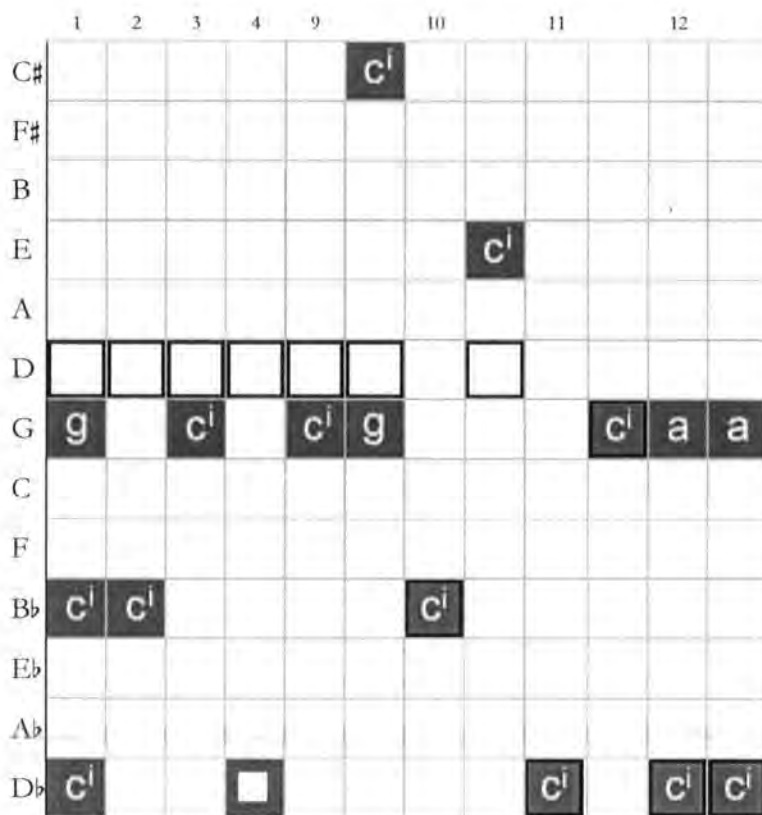

FIGURE 3-26(B): SONATA NO. 6 – DRIVE ANALYSIS

The opening chord in question is not entirely new. Disregarding the anacrusis reveals the *Romantic* ‘dominant minor ninth’, with the standard root now commuted to the melody. But this chord contains extra ‘crushed notes’ – acciaccaturas that add novelty to the already queer sonority. The first remarkable point is the combination of tritone-related G and D $\flat$  drives as full dominant seventh chords ( $\ell$ -DRIVES). The  $\natural$  fifths of both chords create a thick sonority, producing semitone ‘clashes’ (unlike Derriva’s ‘tritone link’) between the  $\natural$  and  $\flat$  fifths; the pitch D ( $\hat{5}$  of the G $^7$   $\ell$ -DRIVE) clashes with the D $\flat$  (C $\sharp$ - $\hat{5}$  of the G $^7$   $a$ -DRIVE and  $\hat{1}$  of the D $\flat$  $^7$   $a$ -DRIVE) and the pitch G ( $\flat\hat{5}$  of the D $\flat$  $^7$   $a$ -DRIVE and  $\hat{1}$  of the G $^7$   $\ell$ -DRIVE) clashes with the A $\flat$  ( $\hat{5}$  of the D $\flat$  $^7$   $\ell$ -DRIVE). The chord can be broken apart into its constituent  $\ell$ -DRIVES on G, D $\flat$  and B $\flat$ .

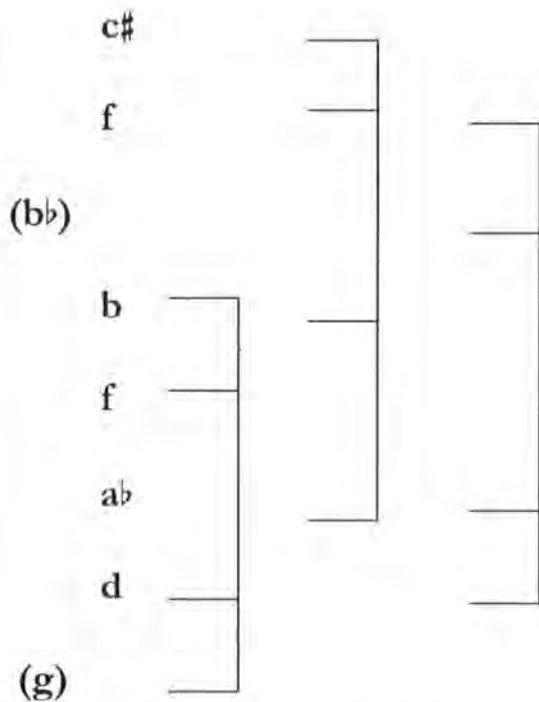

FIGURE 3-26(c): BREAKDOWN OF OPENING SONORITY OF SONATA NO. 6.  
(parentheses denote anacruses)

Of course the G and D $\flat$  drives are only two of many. The D-F-A $\flat$ -B cell betrays a ‘diminished seventh’ element. Although this naturally finds four ways of discharging itself, the simplest explanation is that it is a ‘dominant minor ninth’ on either G or D $\flat$ . The anacrusis B $\flat$  also creates a  $\ell$ -DRIVE on B $\flat$ , and we must remember that bass G was also a mere anacrusis. These anacruses are omitted in the following measures, but in the opening they produce a cluster of three distinct minor third related drives: G, D $\flat$ , B $\flat$ . Naturally, a composer could not articulate such drives in a single sonority and reasonably expect a listener to distinguish them. But the point of *drive analysis* is that whilst they are presented synchronously – *en masse* – they are subsequently singled out in the temporal flow.<sup>185</sup> Skryabin’s French

<sup>185</sup> The parallels between this musical phenomenon and the psychological manoeuvre from drive to desire should now be obvious.

performance indication *mystérieux*, *concentre* holds a supplementary function. ‘Concentrated’ suggests that the drive-economy is in a pure state, objective, unmediated and raw.<sup>186</sup> ‘Mysterious’ – a subjective valuation – pertains to *interpretation*. The mystery is solved as the piece unfolds. M. 2 unwraps a chord progression that outlays the various elements of the opening *concentre* chord individually. Initially a stripped-down variant of the opening chord acculturates an alien A♯. This pitch acts as a displaced appoggiatura to the following B♭<sup>7</sup> chord, which is another disassembled version of the *concentre* chord, each pitch of the subsequent chords retained in the original register. Thus it seems that chordal difference is created in these measures through the *omission* of certain pitches. The first sonority of m. 3 is a similarly pure G<sup>7</sup> chord though, melodically, this reaches to a C♯. This upper pitch engenders a pair of *a*-DRIVES on C♯ and G. Because it comprises both an *a*-DRIVE and a *ℓ*-DRIVE, the drive on G is more enduring, but when the G ‘resolves’ to an A♭ in the measure’s closing gesture, the drive on C♯ (D♭) wields more authority. This is far from conclusive however, and the two drives vie for attention throughout the sonata.

The following measures squeeze even more juice from the opening *concentre* chord. The process by which the middle-bass A ‘resolves’ to an A♭ in m. 2 is spread across mm. 4–8, the chord remaining in a limbo-like state, vacillating between A and A♭. The bass figures here betray a developing rhythmic character. This G<sup>7</sup> chord’s pitch D (in the bass) is delayed until it is revealed almost synchronously with the upper C♯, meaning that ♯4 and ♯5 sound together. Again this is a refraction of the *concentre* chord. Notice also how the G, which was previously an anacrusis, is now a full-bodied bass pitch. M. 10 then transposes m. 9 at t2 to outline the B♭<sup>7</sup> drive and a new E<sup>7</sup> drive, again related to the primary drives of G, D♭ and B♭ by a minor third. These minor third relations break down (or are perhaps paradoxically bolstered) in m. 14 when Skryabin introduces a *ℓ*-DRIVE on G♭. This drive prepares the return of the opening *concentre* sonority, deputising as its dominant. Thus the opening sonority’s D♭ elements become more apparent in its subsequent formation.

The upshot of this analysis is that, in Skryabin’s late style, sonorities become so dense that *drive analysis* seems pointless, until moments like this step forward. At such times Skryabin breaks sonorities into their constituent drives, temporally laying them out and nurturing them individually until the potential of each is fulfilled. Each drive is enshrined individually so that, once reassembled into a single complex, its role in the polytonal drive-body is reassured. The example also proves that, despite a strictly octatonic surface,  $T \rightarrow D$  discharges propagate with surprising frequency and can help us to recognise important drives that are otherwise buried in mysterious harmonies.

<sup>186</sup> In drive theory this corresponds to the Lacanian ‘Real’.

## Complete 'Drive Analysis': *Désir* and *Caresse dansée*, Op. 57

Mindful that I have hitherto analysed only snippets of pieces and have strayed away from the cultural-philosophical discourse which underpins this drive theory, I will consider two works bearing the inviting titles *Désir* and *Caresse dansée*. The pieces comprise the 2 *Morceaux*, Op. 57, composed in 1908, shortly after the colossal *Poem of Ecstasy*, Op. 54. Scriabin described these pieces as “new ways of making love” and they function symbiotically for a variety of reasons.<sup>187</sup> The most striking reason is that both pieces refract the same opening chord. *Tristanesque* in nature, this chord contains both a perfect fourth and an augmented fourth. It is the upper element of Scriabin’s *mystic chord*.

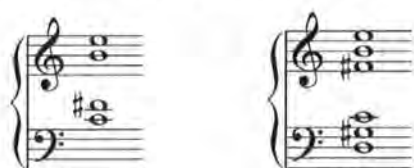

FIGURE 3-27: (A) THE OPENING CHORD OF *DÉSIR* AND *CARESSÉ DANSÉE*;  
(B) SKRYABIN'S *MYSTIC CHORD*.

An analytical snapshot of each piece's structural framework will help navigate the music, before I begin to explore the multivalent drive-energies flowing from the opening chord. *Désir* consists of a mere 14 measures and contains a dense network of internal repetitions.



<sup>187</sup> Bowers, *Scriabin: A Biography* 2, 163.

FIGURE 3-28(A): *DÉSIR*, OP. 57

The opening measure is repeated and echoed by a cadence-like figure in mm. 3-4 (m.5 repeats m. 4). It transpires that the piece is built from a regularly phrased transposition design. Such regular phrasing is a salient feature of Scriabin's middle and late styles, but whereas Scriabin's later works tend to base their transposition schemes strictly on minor thirds and tritones (t3, t6 and t9),<sup>188</sup> *Désir* employs perfect-fourth and fifth (t5 and t7) patterns. And thus we hear a version of mm. 1-5 with a modified transposition scheme in mm. 6-10. However, m. 6 (equivalent to m. 1) is transposed at t7, whereas m. 7 (equivalent to m. 2) is presented at t5. The resulting cadence is then expanded and emphasised in mm. 11-14. What emerges is a very concise scheme, which I represent in this grid-like structure:

<sup>188</sup> This observation is made by many, but is a particular concern of James Baker. Baker, *The Music of Alexander Scriabin*, 17 ff. A thorough discussion of similar repetition / phrasing techniques in relation to Russian musical style can be found in Taruskin, 'Review: "The Music of Alexander Scriabin"', James M. Baker & "Scriabin: Artist and Mystic", Boris de Schloezer'.



mm. 1-5:	$x$	$x$	$y$	$\tilde{x}$	$\tilde{y}$
mm. 6-10:	$x^{17}$	$x^{15}$	$y^{15}$	$\tilde{x}^{15}$	$\tilde{y}^{15}$
mm. 11-14:	Coda				

FIGURE 3-28(B): MOTIVIC / TRANSPOSITION SCHEME OF *DÉSIR*

A similarly conventional structure governs the longer *Caresse dansée*, where the basic unit is a two-measure phrase, chromatically repeated a semi-tone lower. These ostensible ‘blocks’ of transposed material actually connect extremely fluidly to present intricate, descending melodic lines.



FIGURE 3-29(A): OPENING MEASURES OF *CARESSE DANSÉE*

Section A	mm. 1 – 8:	$p$	$p^{11}$	$p^{12}$	$p^{13}$	[two measure units]
	mm. 9-16:	$p^{15}$	$p^{14}$	$p^{13}$	$p^{11}$	
Section B	mm. 17-32:	$q(p)$	$q^{13}$	$q^{14}$	$r$	[four measure units]
	mm. 33-41:	$q$	$q^{12}$	$q^{14}$	$q^{15}$	[two measure units]
	mm. 42-49:	$q$	$q^{12}$	$q^{14}$	$q^{15}$	
Reprise	mm. 49-54:	$p^{15}$	$p^{14}$	$p^{13}$		
	mm. 55-59:	Coda				

FIGURE 3-29(B): MOTIVIC / TRANSPOSITION SCHEME IN *CARESSE DANSÉE*

Both pieces bear a highly traditional phrase structure, whose conventionality is transcended only by Skryabin’s harmonic language. Both pieces also circumnavigate the key of C major, crystallising in the final cadence of *Caresse dansée*. But this analysis is based on Skryabin’s propensity to open pieces with strange, ‘mystical’ harmonies that evade clear analysis. Such opening sonorities are embryonic and contain the harmonic seeds that will organically grow into clearly defined branches of tonality. Such metaphors of organic growth are often applied to Skryabin’s music, particularly in the Russian literature. Belyayev discusses a passage in the *Poem of Ecstasy* where the theme develops in ‘bitter sweet waves’: “In this way, the embryo from which the entire composition develops is presented at the very outset. This idea is developed in the course of the exposition and development; it triumphs in the

return of main section and reigns supreme in the concluding passage of the coda.<sup>189</sup> Of course in the Freudian tradition, my theory of 'drives' is reinforced, and the links between the 'drive → desire' trajectory and the 'embryo → growth' trajectory will be explored in the light of Skryabin's philosophy in the Chapters 5-7.

Navigating the piece, both forwards and backwards, it becomes possible to trace its entire tonal plan back to the opening sonority. Because of the plurality of its drives, the chord resists interpretation according to a single function. But this drive conflict, established at the opening of the piece, becomes unfolded across the work, propelled by a search for tonal clarity. Now, because of shared harmonic practices, these two miniatures – *Désir* and *Caresse dansée* – could be heard as two interconnected movements of a single work.<sup>190</sup> In this respect, the search for tonal clarity runs through both pieces. As listeners start to home in on specific teleological tonal patterns (typically cycles of fifths), divergent drives approach musical desire, becoming ever more object-orientated. In the following analysis I will (a) schematise and explore, successively, the different drives which operate in the opening chord and (b) examine how Skryabin transforms this drive-based mechanism into a desire-based mechanism.

The opening chord of both pieces could be categorised in various conventional ways as either the upper segment of the *mystic chord* (as explained earlier) or as a 'dominant thirteenth' with an absent bass D. However, such rubrics inform very little about how the chord functions. My approach attempts to open paths towards multi-dimensional (and arguably mutually supporting) interpretations on the basis of Skryabin's aesthetic. Before analysing how the various drives operate across the structure of the Op. 57 *Morceaux*, I first introduce the *dramatis personae* of this musical drama: the individual drives that function in Skryabin's opening moment. After introducing each drive in turn, I examine their function in the pieces' overall structure.

*i. The most fundamental drive: the  $i_{\text{DRIVE}}$*

One would shy away from interpreting the opening chord as a dominant seventh on D merely on the basis of the left-hand's C-F#  $i_{\text{DRIVE}}$

<sup>189</sup> "Таким образом, зародыш развития всего произведения дан уже во вступлении, идея которого развивается в ходах экспозиции и разработки, побеждает в возвращении к главной партии и царит в заключении коды." Belyaev, *Musorgskii. Skryabin. Stravinskii*, 76.

<sup>190</sup> It seems that from Skryabin's earliest days he conceived miniatures within an opus set to be related, particularly by key. See Mikhail Yanovitsky, 'Scriabin Etudes, Op.8 as a Set', *Journal of the Scriabin Society of America* 7/1 (2002).



EXAMPLE 3-30: OPENING OF *DÉSIR*

Nevertheless, this interpretation is retrospectively validated when the tritone discharges onto the ensuing, much purer, dominant-seventh on G. Indeed, interpreting the upper C# in the 'melodic line' as an appoggiatura to D, yields a complete  $i\text{-DRIVE}$  on the second beat. What could be more natural than to interpret the previous tritone as the  $i\text{-DRIVE}$  embodiment of a  $D^7$  structure? We must remember that carefully prepared  $D$  functioned cadences are not the harmonic currency; rather, I explore the drives that pulsate beneath the harmonic surface, libidinal energy that oozes through cracks and fissures in the larger tonal structure. And yet these drives acquire significance as the music unfolds, shaping and organising the macro-structure, as I will show. This  $G^7$  chord obviously concretises the preceding  $D^7$  element. But it also, in an act of self-negation, removes itself as a teleological goalpost, becoming an implicit dominant-seventh chord of a new tonic, C. The chord's harmonic function can hardly be confined by the label 'V'; rather, the  $D^7$  implication becomes relegated to 'V of V'. We are pushed backwards along a cycle of fifths; the tonic resolution is slippery and elusive.

But one cannot accept that the C-F#  $i\text{-DRIVE}$  embodies a  $D^7$  chord without conceding that it could equally represent an  $A\flat^7$  chord, spelled as C-G $\flat$ . Although this implication is not immediately realised in this opening (unless I were to interpret the C/F#  $\rightarrow$  G move as a pseudo-German sixth manoeuvre in C major), the idea is explored in m. 8 as Skryabin temporarily modulates to the key of D $\flat$ . This is clarified in *Caresse dansée*, where the identical chord immediately moves to a pseudo- $A\flat^7$  chord ( $i\text{-DRIVE}$ ), the bass 'C' registrally transferred into the upper melody.



FIGURE 3-31: OPENING OF *CARESSÉ DANSÉE*

Thus, rather than discharging the harmony directly into D $\flat$ , Skryabin takes trouble to position carefully the opening drive as  $A\flat^7$ . By allowing the tritone drive to become orientated in this bar, Skryabin presents a continuous drive-motion based on thickening intensities.

ii. *a-DRIVE* & the 'French Sixth'

When *Désir* opens, one can interpret the alto B as a *Tristanesque* accented dissonance that resolves to A# (Bb). From this standpoint, a Chopinesque, 'sexed-up' V<sup>7</sup> chord on the root of C with a diminished fifth – an *a-DRIVE* – presents itself. Applying the 'tritone link' to the C<sup>7b5</sup> chord yields an F#<sup>7b5</sup>, thus presenting a drive towards an alternative tonic of B. But an idiosyncrasy of the *a-DRIVE* is its identity as a *French sixth* chord. In the present context, once again taking the A# as more important than the initial B in the alto, a *French Sixth* in the Key of E major operates. The opening chord should ideally be followed by a D harmony on B, and it should move to an E major chord. This, we must remind ourselves, is how Skryabin's beloved *Tristan and Isolde* flows in its opening bars. It goes without saying that the *Tristan chord*, which litters the pages of Skryabin's Fourth Sonata, Op. 30, is open to myriad interpretations; the point is, however, that Skryabin seems to use the chord as an appoggiatura to a *French Sixth* chord.<sup>191</sup>



FIGURE 3-32: PASSAGE FROM THE *FOURTH SONATA*, OP. 30

In *Tristan*, the progression moves from a *French Sixth* to an E<sup>7</sup> (V), implying the key of A minor. Of course Wagner's enterprise is to encapsulate desire, a mechanism that is orientated toward a single object at the expense of others, but Skryabin is concerned with presenting a preternatural *drive*-based economy, which is why he does not offer any single pathway out of the drive conflict at this early stage in the piece except through the vaguest hints. Such a hint is made in the right-hand of m. 1 of *Désir* as the chromatic cell (C#-D-D#) reaches the D#, underpinned by a B. It soon extends to an E, thus outlining the bare bones of a *French Sixth* discharge. Here a linear *i-DRIVE* emphasises the D of E. And to be sure, the E chord is embodied in the resulting open fifths: E/B. The same E/B, revealed in the opening chord, is now reconstituted as a 'pseudo tonic'.

This said, the *French Sixth* is something of a misnomer because it is identical to the *a-DRIVE* and discharges in the same way. This discussion is intended merely to highlight its function as an auxiliary dominant ('V of V') rather than simply 'V', thus deferring the object of the D functioned drives further along the cycle of fifths. This interpretation illustrates that the goal of the D drive is in fact far from fixed, apropos of Chapter 1's discussion of the aim of the drive.

<sup>191</sup> Carpenter, *Thematic Development and Continuity in the Ten Piano Sonatas of Alexander Scriabin*, 65.

Now, any of these *drive-types* could easily embody pure and unadulterated *desire* if they were spread out into a syntactical harmonic sentence. But in the context of such an ambiguous opening, where a listener is confronted with a discombobulating deluge of decontextualised drives, it becomes impossible to process the complex drive data so as to form any sense of linear desire for specific chords or pitches. The piece of music as a whole needs to select and nurture the different drives and construct a linear model of desire. To understand the emerging significance of these drives within the overall tonal drama, we need to scan through the Op. 57 pieces as a whole. As shown, the  $i$ -DRIVE in the key of G is sublimated into a specific form of  $T \rightarrow D$  motion in the very first measure of *Désir* when it approaches the  $G^7$  configuration. But this is immediately suspended in m. 3 when Skryabin presents a pseudo-perfect cadence in the key of  $A\flat$ . Yet the G returns quickly in mm. 3-4 to approach similar cadencing in G, with the  $D^7$  simultaneously presented in the resolution. This sequence of  $E\flat \rightarrow A\flat \rightarrow D \rightarrow G$  utilises the tritone link between the  $A\flat$  and the D  $a$ -DRIVES. This tritone ‘substitution’ mechanism will recur throughout the piece, but rather than being a symmetrical harmonic scheme in its own right (as Varvara Dernova suggests), it subverts the underlying flow of the cycle of fifths. Nowhere in *Désir* is this clearer than at the end of the piece, when Skryabin orientates us towards a pure tonic chord of  $G\flat$  springing from its dominant in m. 12. He immediately refracts this cadence as  $D\flat^7 \rightarrow G \rightarrow C$  in a pseudo-*Neapolitan* approach to the tonic.

*Désir* ends with a fascinating chord that contains the same drives as the opening. Skryabin certainly finishes with the illusion of a perfect cadence when the bass moves from  $G \rightarrow C$  in mm. 13-14, but he marks the presence of a  $b$ -DRIVE on G, containing the augmented fifth ( $D\sharp$ ) rather than the diminished. This  $D\sharp$  creates an additional level of tritone pliability, sounding against the A that seeps into the harmony. Given that the pitch F is also presented, the  $D\sharp$  (as an  $E\flat$ ) is pulled towards the key of  $B\flat$  via an  $a$ -DRIVE. But the pitch B (interpretable primarily as the third of the G chord) also resonates with this  $D\sharp$  and the A to produce a parallel  $a$ -DRIVE to E. Thus we hear at least three drives: B ( $a$ -DRIVE), G ( $b$ -DRIVE) and F ( $a$ -DRIVE). Whilst Skryabin presents a very different chord of resolution to the original chord, he has presented a chord that positions each drive one notch around the cycle of fifths. This is more visible under a rudimentary form of *drive analysis*.

m.1	■				■		■			■			
m.14		■			■		■				*		
Key:	F#	B	E	A	D	G	C	F	Bb	Eb	Ab	Db	Gb

FIGURE 3-33: CHART COMPARING THE DRIVES INHERENT IN *DÉSIR*'S FIRST AND LAST CHORDS

The asterisk marks the only omitted drive –  $D^b$ . One must remember that the  $A^b$  drive from the opening, which notably remains unsatisfied in this final chord, has just been sublimated in m. 12 in the sequence leading to an ineluctable perfect cadence on  $G^b$ : the only ‘trouble free’ tonic in the piece. Of all these drives, the drive on B – presented here at the final moment – is perhaps the most interesting, since it has not yet appeared in the piece (although it was implicit in the interpretation of the opening chord as a *French Sixth* drive in the key of E). Ultimately the  $a$ -DRIVE on B becomes increasingly significant in *Caresse dansée*. In the beginning of the ‘B’ section, the piece ostensibly unfolds a kind of ‘variation’ of its dance material by presenting the opening chord with a different rhythmic template. This illusion dissipates as the fragmented chord realises its *French sixth* implication and resolves to a pseudo-B chord in m. 18, a chord that is harmonically diaphanous but rendered melodically strong through the rising  $D\#-E-F\#-G$  pattern. The music proceeds to the fragments of an E chord in m. 19 that in turn continues briefly to a pure A minor triad (the C spelled as a  $B\#$ ). When the latter resolves to a  $B^7$  drive (articulated mainly in the left-hand), the A minor chord is commuted from a *T* to a *S* chord.

$E: \quad bVI \rightarrow \quad V \rightarrow \quad I \rightarrow \quad iv \rightarrow \quad V^7$   
 $\quad \quad S \rightarrow \quad D \rightarrow \quad T \rightarrow \quad S \rightarrow \quad D$

FIGURE 3-34: CARESSE DANSÉE, MM. 17-20

Such refractions of *Désir*'s harmonies impose themselves on the second part of *Caresse dansée*. *Désir*'s course through the cycle of fifths was frequently overwhelmed by interruptions and diversions; the cadence on  $G^b$  towards the end was but a fleeting glimpse of stability; nor did its tritonally related C constitute a satisfactory ending for the piece. If these progressions are intimated somewhat vaguely in *Désir*, then they achieve greater definition in *Caresse dansée*, especially with the confirmed fifth-cycles of mm. 33-41, repeated and expanded from mm. 41-47. One now hears  $C^7 (b\text{-DRIVE}) \rightarrow F^7 (c\text{-DRIVE}/a\text{-DRIVE}) \rightarrow B^b7 (b\text{-DRIVE}) \rightarrow E^b7 (c\text{-DRIVE}/a\text{-DRIVE}) \rightarrow A^b7 (b\text{-DRIVE}) \rightarrow D^b7 (c\text{-DRIVE}/a\text{-DRIVE})$ . But at this point (mm. 46-48) Skryabin chooses to divert the cycle back to C by exploiting the ‘tritone link’ between  $D^b7$  and  $G^7$ . And this breaks up into fragmentary cadences before the piece ends in C.

FIGURE 3-35(A): *CARESSÉ DANSÉE*, MM. 41-50

FIGURE 3-35(B): *CARESSÉ DANSÉE*, MM. 55-59

The final C chord is approached from a pure  $b\text{-DRIVE}$  in m. 58 (after a *French Sixth* in the key of  $G\flat$ ); the  $G^7$  chord contains the same  $D\sharp$  that ended *Désir*. That being said, the absence of the pitch A disperses the pre-established  $B^7$  ( $i\text{-DRIVE}$ ) and  $F^7$  drives ( $i\text{-DRIVE}$  now reduced to  $j\text{-DRIVE}$ ). And thus Skryabin has orientated the spatially conflicting *drives*, based upon fragmented tritones that slip in and out of *dominant-tonic* syntax, into a temporally organised form of *desire* – a process by which the cycle of fifths presents a syntactically teleological, albeit ever-deferred, object.

The above findings are charted on the *drive analysis* graphs (*Appendices A* and *B*), to which the reader is now invited to turn. A casual overview of the *Désir* graph (*Appendix a*) reveals a striking lack of  $D \rightarrow T$  discharges between the regions of  $C\sharp$  and  $B\flat$ . The music is dominated instead by diagonally rising progressions, unfolding a sequence of  $S$  discharges.  $D$  discharges are confined to the ‘flat’ ( $S$ ) regions in m. 3, 8 and 11, which together unpack a ‘cycle of fifths’,  $E\flat \rightarrow A\flat \rightarrow D\flat \rightarrow G\flat$ . Significantly, this final  $G\flat$  is the work’s only pure perfect cadence; it functions as the tritone substitute of C major. We thus find a ‘stratification’ of the  $D$  region and  $S$  region occurring between the  $E\flat \rightarrow G\flat$  areas of the grid and  $C\sharp \rightarrow B\flat$  respectively. The situation is reversed in *Caresse dansée* (*Appendix b*), which features an enormous proliferation of  $D$  discharges covering vast stretches of music, with isolated  $S$  discharges

tucked into expansive chord complexes. Moreover, the piece's second half focuses on fifth cycles: C → F → B♭ → E♭ → A♭ → D♭, switching to the tritone pole of D♭ / G which then leads back naturally to C.

### The Way Forward

What is one to make of this formal manoeuvre from an amorphous musical mass of free-forming drives towards a clearly phrased dance-movement with its cycle of fifths and perfect cadencing? In his own critical writings, Skryabin himself proposed the existence of an evolutionary flow from base drives towards sophisticated caresses: “Animal motions ... change into caresses ...”.<sup>192</sup> Conceived in terms of a development towards higher forms of human sexual activity, Skryabin's evolutionary model exactly matches Georges Bataille's suggested evolution from the *sexuality* of animals to the *eroticism* of humankind.<sup>193</sup> I argue that similar psychological and evolutionary narratives are at work within the musical structure of *Désir* and *Caresse Dansée*, as reflected in their titles. Our excursion through these, Op. 57 miniatures has outlined ways in which this particular narrative trajectory can be harmonically embodied. This analysis has absorbed the different drive types that I have explored and shown how they can coalesce in individual pieces. The remainder of this thesis will investigate, more thoroughly, the paths these drives take. I will show that, at various levels, the drives follow two distinct paths: (a) a linear, teleological, desire-based path like that of *Désir* and *Caresse Dansée* and (b) a circular, drive-based path. The dialogue between these two structures will be formulated as a synthetic project in Chapters 5 and 6, mediating Skryabin's musical works and his philosophical accounts. Chapter 4 widens focus to explore two large works – the two late sonatas, no.6 and no.10. In so doing I will elicit various models of musical space in which these drives operate.

<sup>192</sup> Bowers, *Skryabin: A Biography* 2, 245.

<sup>193</sup> Georges Bataille, *Eroticism* (London: Penguin Books Ltd., 2001), 29.



## Chapter Four

---

### 'Ordering the Drives': Navigating Drives and Desires Through Tonal Pitch Space.

*"I don't know anything I can't express at the piano, and from these different expressions I can build an entire system as an inner entirety or whole. And it seems to me that musical expression is much more pointedly logical than any abstract concepts."*<sup>194</sup>

*Alexander Scriabin*

#### Pitch Spaces: Mapping the Body

Russian music theory has been heavily influenced by the work of Hugo Riemann ever since his *Vereinfachte Harmonielehre* appeared in translation in 1896. Analysts such as Gregory Catoire, Varvara Dernova, Viktor Belyayev and Yuri Kholopov, have taken Riemann's theories closely to heart.<sup>195</sup> In previous chapters I tentatively borrowed elements of Neo-Riemannian theory pertaining to the 'functions' of various harmonic sonorities, a theory revitalised most recently by Daniel Harrison. But the other legacy of Hugo Riemann is the notion of mapping tonal space. Riemann's particular apparatus was the *Tonnetz* – the tone net – that was introduced in Chapter 1. The impact of the *Tonnetz* has been diverse; David Lewin's 'tonal transformations', Richard Cohn's 'hyperhexatonics' and Fred Lerdahl's 'tonal pitch space' are indebted to Riemann's model.<sup>196</sup> This wide field of research provides ways of aligning spatial metaphors with harmonic motion. Such metaphors work beyond the theoretical; they are deeply visceral and are intricately cathected to 'the body'. Janna Saslaw's recent work argues that the cognitive process of listening to music involves organising sounds into physical analogies based on the perception of simple spatial categories: up-down, inside-outside etc.<sup>197</sup> These are sorted into "image schema", based on the work of the philosopher Mark Johnson. Candace Brower suffuses Saslaw's rather general research with hardcore theories of harmonic space. She also appropriates research from the cognitive sciences, appealing to Howard Margolis' theories of "pattern matching".<sup>198</sup> Of particular interest to this study is the provision of various conceptualisations of the 'cycle of fifths' with which Brower allies the human body, categorising 'image schemas' as *circles*, *paths* and *containers*.

---

<sup>194</sup> Scriabin to Arnold Alshvang; Bowers, *The New Scriabin: Enigma and Answers*, 63.

<sup>195</sup> This is a particular concern of Khananov's thesis, *Russian Methodology of Musical Form and Analysis*.

<sup>196</sup> David Lewin, 'Amfortas's Prayer to Titirel and the Role of D in Parsifal: The Tonal Spaces of the Drama and the Enharmonic C/Bb', *19th-Century Music* 7 (1983-4); Richard Cohn, 'Maximally Smooth Cycles, Hexatonic Systems, and the Analysis of Late-Romantic Triadic Progressions', *Music Analysis* 15/1 (1996); Lerdahl, *Tonal Pitch Space*.

<sup>197</sup> Janna Saslaw, 'Forces, Containers, and Paths: The Role of Body-Derived Image Schemas in the Conceptualization of Music', *Journal of Music Theory* 40/2 (1996).

<sup>198</sup> Candace Brower, 'A Cognitive Theory of Musical Meaning', *Journal of Music Theory* 40/2, 44 (2000).

Skryabin's music is often likened to 'the physical', but this seems to be nothing more than a glib metaphor that underlines Skryabin's erotic fascination. In such a way Leonard Sabaneyev claims that,

Skryabin's terrifying hyper-eroticism, which pushed so many boundaries in his compositions, was also demonstrated in his playing – in the voluptuous, delicate way he was in touch with the sounds, in those spasmodic rhythms that sensually aroused him, in those strange and unutterable desires for ultimate caresses in the *Mysterium*, caresses which lacerated – 'love-war' – to use his phrase. All of this revealed him to be a sharply sexual psychological character.<sup>199</sup>

But in erotic theory the 'caress' is simply the titillation of an erogenous 'rim' structure on the physical surface. It is necessary to survey the dynamic erotic body in which Skryabin's harmonic libidinal energy flows.

Throughout the course of this chapter I will draw on the work of Ernő Lendvai, a key figure in linking the physical realms of nature and music. It was Lendvai who unearthed the 'Golden Section' and the 'Fibonacci Series' in Bartók's music.<sup>200</sup> Both of these mathematical structures are drawn from natural phenomena in the physical world, which Lendvai convincingly examines alongside music. Finding the Fibonacci series operating in Skryabin's music, Manfred Kelkel extended this research to Skryabin studies.<sup>201</sup> But ultimately such enterprises tell us little about how we actually perceive the artwork as a functioning 'body'. To construct a body is to construct the space in which the 'drive' energy flows, to define its parameters and limitations, to delimit its 'top' and its 'bottom', its 'inside' and 'outside'. Therefore I turn to analytical models of space. Unfortunately, existing models short-change us when reconstructing Skryabin's music. Michael Spitzer shows that, in order to comprehend 'transitional' music, one must shuttle between spatial patterns. Spitzer uses Chopin's *Prelude* in E major to highlight the cognitive shifts that occur within small windows of time, using the dialectic interchange of Richard Cohn's and Fred Lerdahl's models.<sup>202</sup> In another bold gesture, Anthony Pople found a passageway between structural cognitive levels of a piece; he cast Skryabin's *Fenillet d'album*, Op. 58 in the light of Fortean set theory, illustrating that a *mystic* (6-34) foreground is set against a whole-tone (6-35) background.<sup>203</sup> In this chapter I also synthesise two spatial systems in order to cope with Skryabin's late style, but in a very different manner to Pople or Spitzer, through the creation of a single synthetic model. But after this I forge a path through Skryabin's latest music to find a much freer style in which

---

<sup>199</sup> «Этот страшный, предельный эротизм Скрябина, бивший чрез край в его сочинения, проявлявшийся в его игре, в этих сладострастных, утонченно чувственных касаниях к звукам, в этих спазматических ритмах, которые возбуждали его, как осязание, в этих странных и несказуемых мечтах о последник ласках в Мистерии, ласках-страданиях, любви-борьбе, как он говорил, - все показывало, что мы имели в его лице очень резко-сексуальный психический тип.» Sabaneyev, *Vospominaniya O Skryabine*, 126.

<sup>200</sup> Ernő Lendvai, *Béla Bartók: An Analysis of His Music* (London: Kahn & Averill, 1971).

<sup>201</sup> Manfred Kelkel, *Alexandre Scriabine: Sa Vie, L'esoterisme Et Le Langage Musical Dans Son Oeuvre* (Paris: Champion, 1984).

<sup>202</sup> Spitzer, Michael, 'The Metaphor of Musical Space', *Musicae Scientiae* 7(1), 2003, 101-120.

<sup>203</sup> Anthony Pople, 'Skryabin's *Prelude*, Op. 67, No. 1: Sets and Structure', *Music Analysis* 2/2 (1983), 5.

my synthetic model collides with others. Thus I begin to subdivide Skryabin's late style and portray two different tonal regimes, where others find only one.

## A Dialectic of Spaces: Ernő Lendvai with Fred Lerdahl

From previous chapters, two distinctive features of Skryabin's drive-complexes have emerged; these must be taken into account in any spatial model:

- 1) As shown, Skryabin highly favoured long-range cycles (or lines) of fifths. See, for instance, the excerpt from *Caresse dansée* that comprised figure 3-34 and that contained this progression:  $C^7 \rightarrow F^7 \rightarrow Bb^7 \rightarrow Eb^7 \rightarrow Ab^7 \rightarrow Db^7$ .
- 2) Skryabin shows a strong preference for t3, t6 and t9 operations (tritone and minor third relations) at key junctures. This was most apparent in late pieces such as Poem, Op. 71, no. 2 where the bass hovered between D, F, G# and B – the four t3 nodes of the chromatic and octatonic scales.

One could convincingly diagnose the first of these trends as a symptom of Skryabin's early teleological desire-structures (progressions in fifths), and the second as his late emphasis on the drive-structures that perpetually orbit their object. Skryabin's earlier works followed intensely narrative tonal trajectories, more so than the late works, and I have proposed that this is a conversion from desire-mechanisms to drive-mechanisms.<sup>204</sup> But in the following discussion, this compositional difference will be dismantled to reveal two spaces that actually shared a dialogic relationship throughout Skryabin's career. Lendvai's work on the 'Golden Section' and the 'Fibonacci Series' offers valuable insights into the compositional process but, unfortunately, does little to territorialize us within Skryabin's harmonic space. More fertile is Lendvai's other great contribution – his 'axis system'. Varvara Dernova focussed on the 'double-function' of the 'tritone link', and I too have explored the *French Sixth* drive-complex (my  $a_{\text{DRIVE}}$ ) and the synonymy between dominant  $V^{7b5}$  chords and their tritone transpositions.

Lendvai calls this 'substitution'. Of course, whilst tritone 'substitutions' are common in Jazz music, one is forced to admit that the theory behind it is rather hazy. Lendvai merely suggests that 'counter-poles' are "more directly related to each other than the relative keys of classical harmony", and thus a "pole can be replaced by its counter pole without any change in its function."<sup>205</sup> Yet, through Dernova's 'tritone link', Skryabin's  $a_{\text{DRIVES}}$  share identical pc content, and thus tritone substitution becomes even more pertinent to Skryabin's music than Bartok's for which it was designed. But 'tritone substitution' is only one facet of the axis system; Lendvai offers t3 substitution based on relative minor relationships. Without explicit homage to Hugo Riemann, Lendvai's axis system is essentially the Neo-Riemannian

<sup>204</sup> This latter disinterest in narrative structures would be contested by musicologists such as Susannah Garcia who convincingly find hypothetical 'programmatic' content in Skryabin's late music. My inquiries refer more to specific forms of tonal/ psychological narratology, and therefore need not contradict. Garcia, *Alexander Skryabin and Russian Symbolism: Plot and Symbols in the Late Piano Sonatas*; Susanna Garcia, 'Scriabin's Symbolist Plot Archetype in the Late Piano Sonatas', *19th Century Music* XXIII/No. 3 (2000).

<sup>205</sup> Ernő Lendvai, *Symmetries of Music: An Introduction to the Semantics of Music* (Keckszemét: Kodály Institute, 1993), 8, 11.

tripartite concept of *Tonic*, *Dominant* and *Subdominant* (*T*, *D* and *S*). For Lendvai, the three prevailing chords that bear these functions – the so-called primary triads – can be substituted by the tritone or relative-minor ‘secondary triads’. Thus, the *T* chord of C major is equal in function to F# and A, but also to the tritone relation of A – Eb. These four refractions of the *T* function are arranged as an ‘axis’, and the *S* function and *D* function each has its own four axes. In C major, the *S* function is F, B, Ab and D, whilst the *D* function finds embodiment in G, C#, Bb and E. This is how Lendvai frames his ‘axis system’:

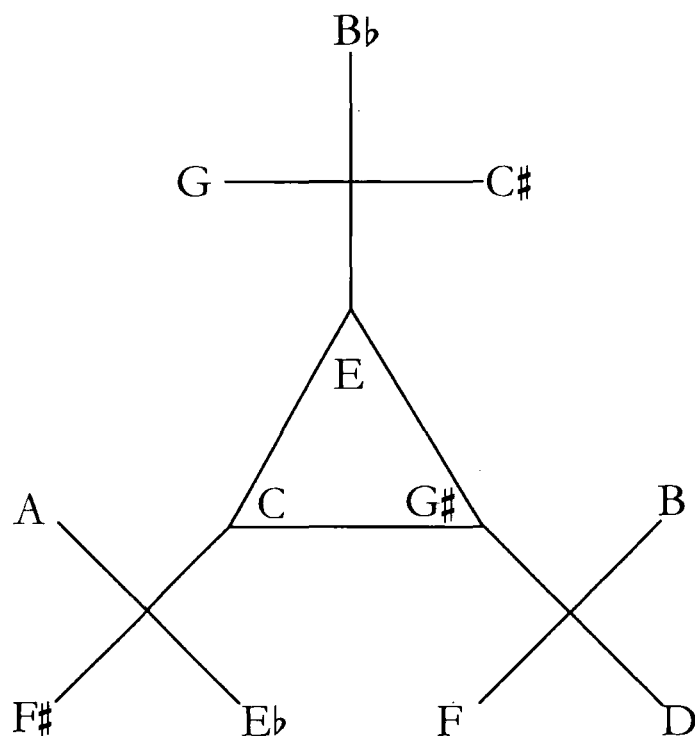

FIGURE 4-1. LENDVAI'S 'AXIS SYSTEM'

With this in mind, I revisit my prototype of Skryabin's 'late style' – Poem, Op. 71, no. 2 (see figure 1-25). The fundamental drives in the bass region exclusively outline drive structures on D, G#, F and B, suggesting a 'static' *T* region. In the final analysis one must concede that Lendvai's system is too rigid to follow Skryabin's intensely drive-based music which is propelled by the need to discharge many internal tensions. To claim that the chords of D and B are located in the *T* region tells us very little; a synthesis of Lendvai's model with a space that can incorporate the flow of Skryabin's protean drive discharges offers a richer analysis. This is necessitated by Skryabin's obsession with the long sequential *T*→*D* discharges, heard particularly in his middle-period works although, as indicated, they filter into his late 'octatonic' style in a very different form. A model must therefore chart the cycle of fifths on one of its axes and t3 relatives on the other. This is fortunately nothing new to analysis. Fred Lerdaahl's 'tonal pitch space' is actually accredited to Gottfried Weber's 1824 model, but is appropriated in a new

way to ground Lerdahl's analytical system.<sup>206</sup> A fusion of Lerdahl's and Lendvai's systems could look like this:

T	B#	D#	F#	A
S	E#	G#	B	D
D	A#	C#	E	G
T	D#	F#	A	C
S	G#	B	D	F
D	C#	E	G	Bb
T	F#	A	C	Eb
S	B	D	F	Ab
D	E	G	Bb	Db
T	A	C	Eb	Gb
S	D	F	Ab	B
D	G	Bb	Db	E

FIGURE 4-2: PITCH-SPACE GRAPH: SYNTHESIS OF LERDAHL (WEBER) AND LENDVAI

Inserting functional labels down the left-hand side shows how a composer could follow the cycle of fifths, whilst rotating tonal function:  $T \rightarrow S \rightarrow D \rightarrow T \rightarrow S \rightarrow D \rightarrow T$ . A composer could play 'snakes and ladders' down this chart. One anomaly is that tritone substitutions in conventional pitch-space require 'transformational' procedures, but the two chords are often identical in Skryabin's music due to the equal pitch-class content of the  $a_{\text{DRIVE}}$  configuration. Thus they are 'maximally smooth' and should belong in the same graphical location. Lendvai's substitution is different to Lerdahl's pitch space, which must be remembered when using the map. Nonetheless, this diagram provides the potential for a chain of discharges through a cycle of fifths whilst maintaining a perpetual  $S \rightarrow D \rightarrow T$  motion.

### Poem, Op. 32, no. 2

Rather than dive headlong into Skryabin's late style, I take a preparatory detour through some earlier works. Op. 32 flowed from Skryabin's well-documented burst of creative energy in 1903 – his 'Middle Period'. Of this piece Dernova claims, "It is difficult to see how any tonal orientation other than a motion from D to Gb could be deduced from this vital passage."<sup>207</sup> In direct reproof to this fantastic underestimation, the spatial mechanism described above will demonstrate how pitch-space substitution runs through a more conventional diatonic  $S \rightarrow D \rightarrow T$  scheme, and help to reconstruct the origins of Skryabin's late-style.

<sup>206</sup> Lerdahl, *Tonal Pitch Space*, 42.

<sup>207</sup> Guenther, *Varvara Dernova's "Garmonia Skriabina": A Translation and Critical Commentary*, 122.

1 Allegro. Con eleganza. Con fiducia ♩ = 84 - 88

*m. d.* 3 3 3 3 *marcatissimo*

3

*m. d.* 3

5

7

*mp*

9

*cresc.*

11

*ff*



FIGURE 4-3: POEM, OP. 32, NO. 2, MM. 1-14

Whilst the key signature denotes D major, the first chord comprises only the pitches D-Ab-C. Typically for Scriabin, this meagre collection of pitches barely establishes a firm key; the third is absent, the fifth is diminished and the seventh occupies the bass position. Nevertheless the piece concludes with a perfect D major chord, retrospectively validating it as a plausible tonal frame. Of course this opening contains a drive in the key of Ab when the F# (3̂ in D) masquerades as the Gb seventh of the Ab7 chord. This shuttles us between tritone poles of the same axis. I call this axis *T*, allowing that drives on F and B could shelter beneath the same umbrella. In m. 2, this  $a_{\text{DRIVE}}$  is supported (as a drive centred on D) by a fleeting ‘nested discharge’ to a G chord. Before consolidating this G as a local *T*, Scriabin whisks us a whole-tone ‘upwards’ from D and Ab to E and Bb. This Bb drive is weak, tentatively appearing in the diminished chord (D-E#-G#) and the left-hand’s dislocated Bb pitch. Nevertheless, the drives on G, E and Bb clearly belong to a different tritone pole – *S* (E, Bb, G, C#) – and the following events consolidate their function. In the latter part of m. 3 the  $a_{\text{DRIVE}}$  on E resolves to a  $i'_{\text{DRIVE}}$  on A and thus discharges itself into a directly related pole from the *D* axis (A, C, Eb, F#). A flawless  $T \rightarrow S \rightarrow D$  pattern is therefore revealed in the opening measures. An equivocal feature of the preceding analysis is the D as the tonic centre. After all, the D was invested as a *D* drive and discharged into G in m. 2. But the assertion of D as *T* is validated in mm. 4-5 as Scriabin completes the  $T \rightarrow S \rightarrow D \rightarrow T$  cycle, clarifying the key through a perfect cadence. Of course Scriabin soon adds the seventh to this *T* complex, neatly returning to his point of departure. It seems that the primary function of this opening passage is to convert the chord of D from an unstable *D* chord to a stable *T*. This activity runs throughout the piece. The following Lendvai / Lerdahl spatial graph charts drive activity thus far.<sup>208</sup>

<sup>208</sup> Squares represent the drives articulated; arrow-headed lines denote the transition between; double-lines denote synonymy between pitches as it does in Lerdahl’s models.

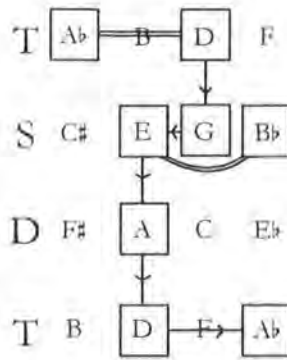

FIGURE 4-4(A): 'TONAL PITCH SPACE' GRID OF *POEM*, OP. 32, NO. 2, MM. 1-5.

One limitation of the foregoing analysis is that, whilst Lendvai's 'axis system' is shown through the cycle of fifths, the actual substitutions remain auxiliary. Essentially, a D chord is replaced by an E chord (albeit with other drives), returning to a D chord in a  $I \rightarrow II \rightarrow V \rightarrow I$  progression – the same chord progression that opens Beethoven's *Hammerklavier* Sonata, albeit in a different key. But axial substitution pertains to mm. 6-8 when the  $b_{\text{DRIVE}}$  on D (from m. 5) morphs into a  $i_{\text{DRIVE}}$  on Ab. This then progresses to a  $i_{\text{DRIVE}}$  on Db, emphasised in the bass, preceding a Gb pitch in m. 7 and a fully-fledged chord in m. 8. In this way Skryabin offers a continuous cycle of fifths, displaced through the tritone pole of D-Ab. Hence:  $E \rightarrow A \rightarrow D / Ab \rightarrow Db \rightarrow Gb$ .<sup>309</sup> This can be visualised on the extended Lendvai/Lerdahl graph as follows:

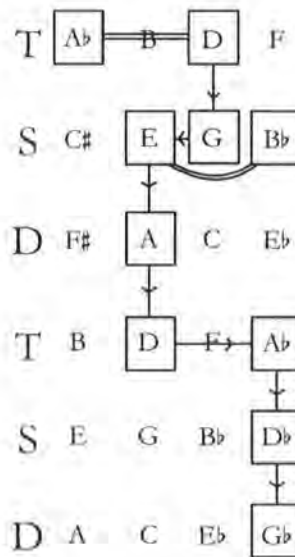

FIGURE 4-4(B): 'TONAL PITCH SPACE' GRID OF *POEM*, OP. 32, NO. 2, MM. 1-8

This shows a continuous chain, ruptured only by the tritone switch. On a *drive analysis* graph, diagonally downwards discharges are emphasised by the bass.

<sup>309</sup> Here, '/' denotes a point of substitution.



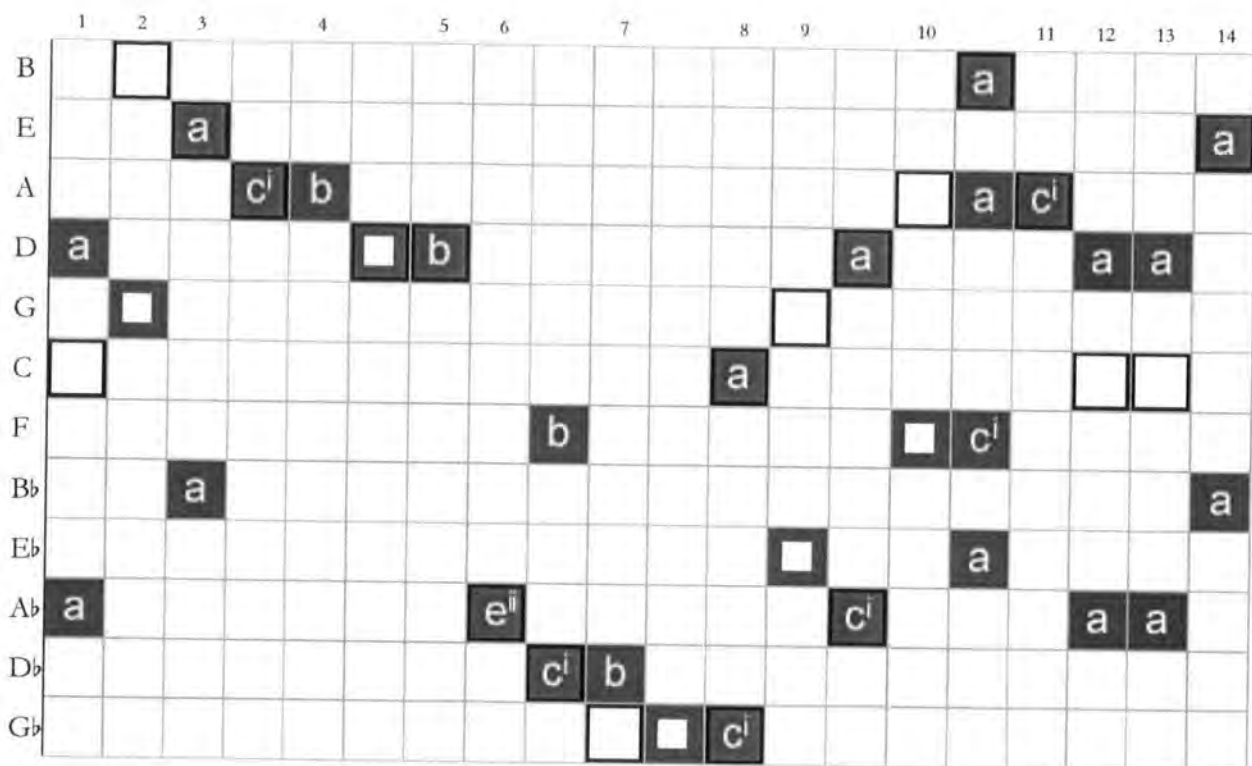

FIGURE 4-4(c): POEM, OP. 32, NO. 2 – DRIVE ANALYSIS

But again, these tritone displacements do not fully avail themselves of Lendvai's axial possibilities that, one must remember, utilise  $t_3$  operations as well as  $t_6$ . In mm. 7-8 the tritone link between  $G^b$  and C is exploited, and the C *bas*-DRIVE flows into a  $S$  discharge of C to G. But more crucially, as the bass moves to a G in m. 9, the chord it underpins is an  $E^b$  chord. This  $E^b$  discharges quickly into  $A^b$ , intersecting the new tritone pole of D. The  $E^b$  chord belongs to the same tritone axis as the primary  $G^b$  in m. 8, but it is also the relative minor and thus a  $D$  substitute in Lendvai's system. The chart can now be updated:

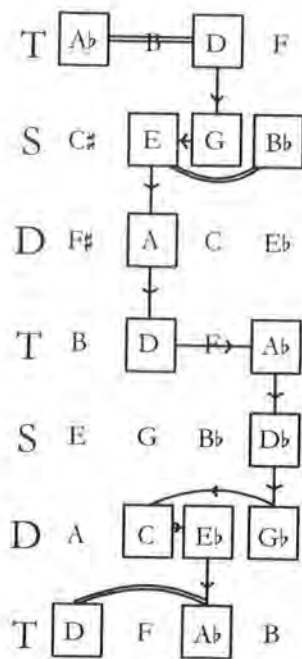

FIGURE 4-4(D): "TONAL PITCH SPACE" GRID OF POEM, OP. 32, NO. 2, MM. 1-9

So far, three poles of the *D* axis have been encountered, and the fourth – *A* – lies in close proximity. In the second half of m. 10, the *T* pole that we have just reached (the *D-Ab* of m. 9) is continued on its own *t3* axis with the inception of *B* and *F* *a*-DRIVES. These drives usher-in a drive on *A* which is entrenched throughout m. 11; as the melodic *F#* drops to the *E*, the drive becomes a fully fledged *d*-DRIVE. This is the *true D* in the key of *D*, fully discharging itself in m. 12. The graph now extends to include all four polar substitutions in both *D* and *T* regions. The *F* makes an unanticipated reach back for the *A* (smoothed by the shared bass pitch *A*), only to reinforce the *T* chord of *D* at the cadence.

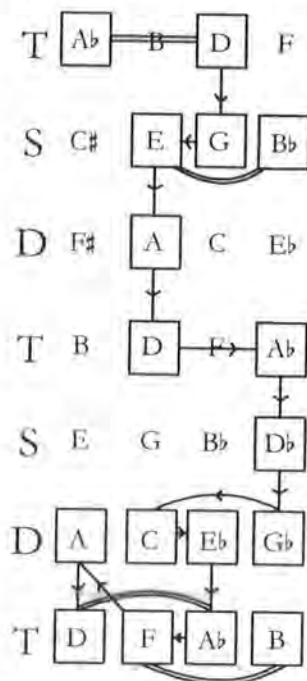

FIGURE 4-4(E): "TONAL PITCH SPACE" GRID OF POEM, OP. 32, NO. 2, MM. 1-14

The switches highlight ways in which Skryabin moves between poles as preparation for what I term *direct discharges*. Substitution typically occurs before a genuine snippet of the cycle of fifths, leading to a cadence. In the final bars of *Caresse dansée* for example, substitution is found only in the final measures of the cycle as Skryabin switches between  $D\flat$  and its tritone  $G$ , preparing for a cadence on  $C$  (See figure 3-35). Discharges such as this I classify as *direct*. In due course *indirect* discharge will be explored; this is a phenomenon of substitution analysis, when a  $T$  is preceded by a substituted  $D$  form.

## Substitution and $\flat ii$

One thorny issue of substitutional analysis pertains to the function of tritone switches. Depending on how  $\flat ii^6$  is conceptualised,  $\flat ii \rightarrow V \rightarrow I$  can be regarded as both  $D \rightarrow D \rightarrow T$  and  $S \rightarrow D \rightarrow T$  progressions. On this issue, Lerdahl reports that  $\flat ii$  functions as a  $D$  rather than  $S$ , owing to its strong attraction to  $T$ . He claims, “the relatively small value [of tension between  $\flat ii^6$  and  $V$ ] ... leaves  $\flat ii^6$  as  $S$ -function in somewhat equivocal position, for its stronger impulse is to function as  $D$  and to resolve directly to  $I$ ”.<sup>210</sup> The functional equivalence of tritone-related  $D$  chords in Lendvai’s system also supports a substitutional  $D \rightarrow T$  reading.

But many regard the chord as a chromatic reinterpretation of the  $S$  chord. Even in the Russian school, Dernova labels  $\flat ii$  as  $S$ , though she stresses that this is not always the case: “in one case it is a Neapolitan subdominant in root position and in the other it is a dominant enharmonically equal to and forming a tritone link with the dominant of the basic tonality.”<sup>211</sup> Her follower, Roy Guenther, also seems inclined to label the tritone substitution as a functional shift ( $S \rightarrow D$ ), classing the cadence  $^{\sharp}IV \rightarrow I$  as plagal.<sup>212</sup> Yet he falls prey to confusion in other instances, claiming, whilst  $\flat ii$  is  $S$  in function, Dernova’s  $DA$  and  $DB$  are “functionally uniform”.<sup>213</sup> He also claims that the tritone link itself supplants the  $S$  function.<sup>214</sup> Lerdahl too allows that  $\flat ii$  sometimes functions as  $S$ , through  $\flat ii$  being a substitution of  $ii$  (which it is not in Lendvai’s system). In so doing, he refers to Skryabin.<sup>215</sup> The Russian

<sup>210</sup> Lerdahl, *Tonal Pitch Space*, 312. This view is reflected in the Russian analytical tradition that Skryabin had access to. In a recent ‘web forum’ of the Society of Music Theory relating to similar  $\flat vi$  chords, Ildar Khannanov indicates Rimsky Korsakov’s espousal of this view, due to the raising of scale-step four in *augmented sixth* chords (Khannanov, Ildar, <http://www.societymusictheory.org/pipermail/smt-talk/2006-March.txt>, Wed Mar 1, 2006. Accessed June, 2007). This standpoint is shared by Dmitri Tymoczko: “in Schubert and Chopin, ‘augmented sixths’ come to act as dominant chords leading directly to the tonic in cadential situations. This practice is reasonably common throughout the nineteenth century, and becomes almost mandatory in contemporary jazz (tritone substitution)”. By contrast, augmented sixth chords have subdominant function much more rarely – “from a voice leading perspective, you might say that the augmented sixth is just as much an altered subdominant as an altered dominant.” (Tymoczko, Dmitri, <http://www.societymusictheory.org/pipermail/smt-talk/2006-March.txt>, Sun February 26, 2006, accessed June 2007).

<sup>211</sup> Guenther, *Varvara Dernova’s “Garmonia Skriabina”: A Translation and Critical Commentary*, 14.

<sup>212</sup> *Ibid.*, 157.

<sup>213</sup> *Ibid.*, 195.

<sup>214</sup> *Ibid.*, 171.

<sup>215</sup> Lerdahl, *Tonal Pitch Space*, 312.

analyst Belyayev similarly adopts this view: "Rameau already regarded the *accord de la sixte ajoutée* (that is, the II 6/5 chord) as a subdominant harmony equal to the subdominant triad."<sup>216</sup>

Daniel Harrison continues the *S* function argument, but other branches of his work bear riper fruit. Kevin Swinden, following Harrison, attaches a fourth function to the *S*. He uses the *DP* function label to denote 'dominant preparation'.<sup>217</sup> This accords with Skryabin's axial practice where functional equivalence facilitates 'in house' preparations to discharge, as I found at the close of *Caresse dansée*. Apropos of this *DP* function, the contemporary analytical lexicon also embraces a *DD* function ('dominant of the dominant'). But some feel uncomfortable with this: Swinden claims,

Imagine a straightforward context [i.e. a IV – V – I progression] where 4 is inflected upward. Are we to understand that [this alteration]... has transformed the function of the harmony from *S* to *DD*? Or has the inflection merely *intensified* the expression of the function that was already present in the diatonic *S* to *D* progression? One could split hairs to insist that it has done both, but even then it is clear we are talking about a distinction of degree rather than one of kind. Sadly, I believe that the inherited language, which has symbols that look so different (*S* vs. *DD*), and our Roman numeral symbology (*V7/V*), has created a false distinction-- symbols that reinforce a distinction of kind. In most cases, I am much more comfortable recasting many *DD* cases as a "Chromatic Predominant".<sup>218</sup>

This discussion of the *DD* function pertains also to the *bii* chord. Lendvai's contribution is to appeal to the concept of 'style'. In the Classical style, Lendvai would categorise *bii*<sup>6</sup> as a *S* functioned modification of chord IV: "In Romantic harmony, however, the minor second degree (*D*<sup>b</sup>) is granted an independent role and thus it receives a DOMINANT significance."<sup>219</sup> And Lendvai is correct to leave the functional ambiguity intact. Given the playful openness of *drive analysis*, which revels in ambiguity, it will come as no surprise that I wish to leave these functional labels open and provisional in these studies of Skryabin. The tensile force of Skryabin's harmony is the perpetual deferral of functional labels, which remain fluid. In any case, such labels are *always* context-dependant. As Browne claims: "Function depends on 'context' ... A naked major chord is NOT a tonic until that is proven by context (where is the tritone?). No event contains or controls its own interpretation. Even, tonics and dominants are not 'nouns and verbs' until they can be understood in context as such."<sup>220</sup> In the final measures of *Caresse dansée* the *D*<sup>b</sup> chord in mm. 56-57 is not Neapolitan; the *D*<sup>b</sup> lies firmly at home in the bass where the pitch *F* would normally prevail. Via the tritone link, the chord is equivalent in *pc* content to the *D* chord, and is therefore exiled from a *S* or even *DD* function. The unusual feature of

<sup>216</sup> «Уже Рамо наравне с трезвучием четвертой ступени субдоминантовым созвучием считал *accord de la sixte ajoutée* то есть II<sub>65</sub> субдоминантовой гармонией», Belyayev, *Musorgskii, Skryabin, Stravinskii*, 60.

<sup>217</sup> Kevin J. Swinden, 'When Functions Collide: Aspects of Plural Function in Chromatic Music', *Music Theory Spectrum* 27/2 (2005).

<sup>218</sup> Swinden, Kevin, <http://www.societymusictheory.org/pipermail/smt-talk/2006-March.txt>, March 21, 2006. Accessed June, 2007.

<sup>219</sup> Lendvai, *Symmetries of Music: An Introduction to the Semantics of Music*, 13.

<sup>220</sup> Browne, Richmond, <http://www.societymusictheory.org/pipermail/smt-talk/2006-March.txt>, Thursday March 23, 2006. Accessed June, 2007.

this example is the fact that the strong *D* tension established through the  $D\flat$  chord, and particularly the  $D\flat$  pitch, is dissipated in the penultimate measure, when the *G* chord is presented as a  $b\text{-DRIVE}$ . Skryabin's more common practice is to utilise the Dervonan tritone link between the two synonymous chords represented as  $a\text{-DRIVES}$ . Baker examines the tension of such passages: "By virtue of pitch retention, the flat-II harmony is in effect assimilated into the dominant harmony which frames it ... But the  $bII^{7-35}$  harmony does occur as a separate entity within the dominant prolongation, in order to set up additional tensions in the bass, by progressing by tritone directly to V."<sup>221</sup> To resolve the issue of the fluidity of tonal function, I will appeal to various structural paradigms, after first examining ways in which these functions can also be vertically compiled through a cursory look at one of Skryabin's mid-late works.

### Middle – Late Style Rotation: *Feuillet d'album*, Op. 58

As Skryabin's harmonic language blossomed, thicker drive complexes prospered. Three or four drives now act upon a single chord, and this impacts upon the functional analyses sketched above. The first chord of *Feuillet d'album* for instance, contains a  $i\text{-DRIVE}$  on  $G\sharp$ . The tritone-link ( $D^7$ ) is precluded by the authentic fifth ( $D\sharp$ ) in the right-hand, and this (as well as the missing pitch  $A$ , and despite the tritone pitches of  $F\sharp$  and  $C$ ) makes a drive toward *G* extremely weak. But the opening sonority sequesters  $a\text{-DRIVES}$  on  $C$  and  $F\sharp$ , which establish a pole-counter pole axis. And if  $C/F\sharp$  establishes a *T*, then drives on  $G\sharp$  and  $D$  (a meagre  $f\text{-DRIVE}$  and  $i\text{-DRIVE}$ ), add a *S* inflection to the sonority.

The image displays two systems of musical notation for the piece "Feuillet d'album" (Op. 58). The top system is for piano, marked "Con delicatezza" and "pp". It features a treble clef with a key signature of one sharp (F#) and a 3/4 time signature. The piano part includes various ornaments such as triplets, slurs, and dynamic markings like "legato" and "con voglia". The bottom system is for voice, marked "poco" and "con voglia", with a treble clef and a key signature of one flat (Bb). It includes a vocal line with slurs and dynamic markings. Both systems have a common bass line with a key signature of one flat (Bb) and a 3/4 time signature, featuring a variety of rhythmic patterns and slurs.

<sup>221</sup> James M. Baker, 'Scriabin's Implicit Tonality', *Music Theory Spectrum* 2 (1980), 17.

FIGURE 4-5: FEUILLET D'ALBUM, OP. 58

One of the most recent topics in Neo-Riemannian function analysis is the so-called collision of functions. Kevin Swinden, in his article *When Functions Collide*, takes leave of Daniel Harrison's work and questions moments when multiple functions pervade a single chord. But this work is nothing new to the Russian Analytic tradition. Belyayev's analysis of the *Poem of Ecstasy* boldly assumed that multiple functions coexist in a single harmony. Dernova too, discussed 'bi-functionality', apparently unaware that this was a highly original approach. Belyayev's own advances are humbly presented but are of staggering importance. At times, one could perhaps criticise him for not taking his analyses to their full conclusion. In this instance, Belyayev, quite reasonably locates the *D* and *S* functions, but shies away from a triple functional collision; the *D* (pitches A, C#, E and G), the *T* (bass pitch D and A) and even the *S* (G, B, D) fuse together.<sup>222</sup>

FIGURE 4-6: PART OF BELYAYEV'S ANALYSIS OF *THE POEM OF ECSTASY*, OP. 54

<sup>222</sup> Belyayev, *Musorgskii, Skryabin, Stravinskii*, 73.

And such triple-functioned chords abound in the literature. The final chord of *Désir*, for example:

FIGURE 4-7: CLOSING MEASURES OF *DÉSIR*

The final chord nestles a *T* function (C and G fifths in the bass, answering the call of the preceding *D* function), a *S* function (F, A and C) and a *D* function (G, B, D#, F). In both cases the *T* function is embodied in the bass open fifths. The lack of a triad weakens each to some degree, but the bass articulation and syntactical location – i.e. following a *D* function – allows it to retain tonal hegemony over the other functions. Through the work of Swinden and Harrison, we are used to the idea of the *S* blending with the *D*, but we are shy of adding the *T*. But this is what Skryabin does with his simultaneous fifth-based drives. When two salient pitches are presented a fifth (or a fourth) apart, one is always potentially the discharge of the other. Skryabin was certainly as partial to mixing the *D* and *T* functions as he was the *T* and the *S*, and our Russian analytical contingent is perfectly at home with this. Demova herself mentions the “bifunctional combination” of V/I in an attempt to break down the hegemony of Paul Dickenmann’s single-functioned interpretations of Skryabin’s harmony.<sup>223</sup> But rather than regard such a chord as a resolution, she refers to it as a ‘confirming chord’.<sup>224</sup> The final chord of *Désir* marks this perfectly. The Freudian message – that drives exist in excess of their objects – becomes crystal clear.

Paramount however, is the task of establishing a functional hierarchy. And thus when two functions are offered at the beginning of *Feuille d’album* – *T* and *S* – I give prominence to the *T* function because of its stronger presentation as  $a_{\text{DRIVES}}$ . I have written *T* beneath the *S* (the lowest presented symbol being the most prominent, like a ‘denominator’) below the *drive analysis*.<sup>225</sup> When the opening material is repeated at t2 in m. 5, the frail drives on G# and D become the new  $a_{\text{DRIVES}}$ , and the drive on Bb becomes the new  $j_{\text{DRIVE}}$ . This time however, it is confirmed as an inveterate  $i_{\text{DRIVE}}$  with the Ebb acting

<sup>223</sup>Guenther, *Varvara Demova’s “Garmoniia Skriabina”: A Translation and Critical Commentary*, 77.

<sup>224</sup>Ibid., 225.

<sup>225</sup>This is analogous to Swinden’s SP and D<sup>S</sup> label: Swinden, ‘When Functions Collide: Aspects of Plural Function in Chromatic Music’, 261. In the text, the label to the left of the ‘/’ is the secondary function, the label on the right is the primary function.

as D. This chord naturally bears a similar double-function – *D/S* – though, because the B $\flat$  is now stronger, the pressure between the two functions is disturbed.

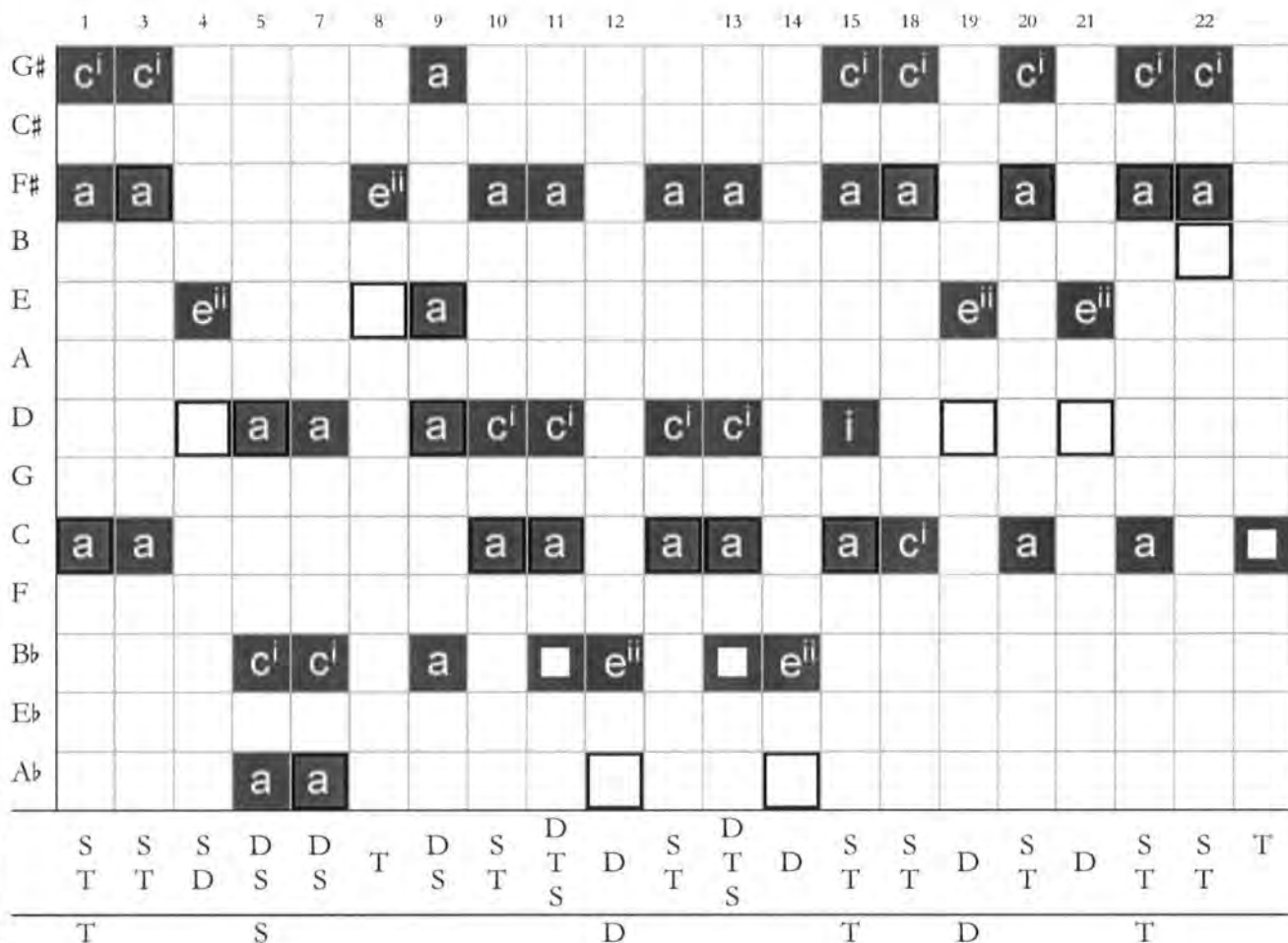

FIGURE 4-8: FEUILLET D'ALBUM, OP. 58 - DRIVE ANALYSIS

Further clarity is afforded this graph through the inclusion of a broader level of functional articulation. This is shown below the horizontal border line at the very foot of the graph. Some of these labels are more equivocal than others. Between mm. 9-12 a thematic fragmentation takes place, during which the *S* function emerges as the functional bedrock. The *S* function is discharged only in mm. 11-12 with a stabilising triad (though synchronous with other drives) on B $\flat$ .<sup>226</sup> Brief returns to the *S/T* function are made in m. 10 and m. 12, though these now highlight the D rather than the G# drives. The section settles on a *Df*<sub>DRIVE</sub> on B $\flat$  in m. 14, before the recapitulation (m.15) manoeuvres back to the *T*. Thus the piece articulates the *T* → *S* → *D* → *T* rotational paradigm, but the functions overlap in the following way: *S/T* → *D/S* → *D* → *T*. Naturally these functional overlaps burst the seams of my

<sup>226</sup> This triad (m.11) is not pure. The F# and A pitches in the anacrusis preclude the chord from being firmly established. The F in the bass, which complements the upper sixths, is also short lived.



synthetic Lendvai / Lerdahl graphs as shown in the following extension, where vertical dotted lines demarcate simultaneous functional categories:

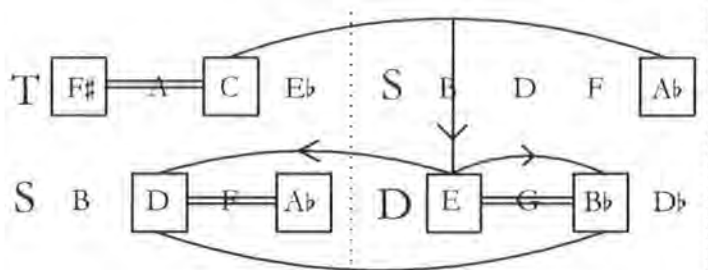

FIGURE 4-9: A SAMPLE 'TONAL PITCH SPACE' GRID OF *FEUILLET D'ALBUM*, OP. 58, MM. 1-7<sup>227</sup>

This piece is noteworthy for containing no cadential discharges. Discharges occur only through substitution; this highlights the distinction between *direct discharges* and *indirect discharges* indicated earlier.

### Prelude, Op. 67, no. 1

In some of Skryabin's late pieces the drives converge to the extent that they can, at times, become almost indistinguishable. At such points *drive analysis* is stretched nearly to breaking point. Were it not for its strong applicability to even the latest works, many short pieces would resist *drive analysis* altogether. Whereas, Op. 58 was conspicuous for its lack of *direct discharges*, Op. 67, no. 1 has many nested discharges. These discharges proliferate around a strongly articulated *T* function.

Mm. 1-6 contain noteworthy features. The strongest drives outline a *T* axis of C, F#, Eb, A, whilst nested discharges function beneath. In m. 1 the weak  $k_{\text{DRIVE}}$  on Bb adds a *D* element, which is immediately discharged into a stronger  $T_{\text{DRIVE}}$  on Eb. Whilst the opening chord is neither a *mystic chord* nor the *mystic configuration*, it does share a similar drive complex: three drives, one separated by a whole-tone, another separated by the tritone – Bb, C, F#. <sup>228</sup> The drive on Bb establishes a nested *D* function within the sonority, wanting to discharge back into the stronger, and more attractive, *T* axis. This may shed new light on the functionality of the *mystic chord* – an inwardly conflicted chord containing a strong *T* function, with a nested *D* function that strives to assimilate itself into the *T*. Beneath consistent drives on F#, a chain of fifths with four links is produced. Just as the opening drive on Bb discharges itself into a *T* Eb, so the *T* drive on C discharges onto F. And with m. 1's repeat in m. 2, a small nested cycle of fifth-discharges outlines C → F → Bb → Eb. Thus, whilst the *mystic configuration* tries to enfold the *D* function back into itself, it also simultaneously discharges its *T* elements into *S*

<sup>227</sup> Single lines with no arrowed indicators show simultaneous drives.

<sup>228</sup> The *mystic configuration* would contain drives on C, F# and D.

elements. It seems that drive tensions can be very sinuous indeed. But note how the  $T$  function remains intact despite the shifting  $D$  emphases beneath, thus assuring its control.

Andante

*pp vague, mystérieux*

4

8

12

16

20

*débilitant*



FIGURE 4-10(A): PRELUDE, OP. 67, NO. 1

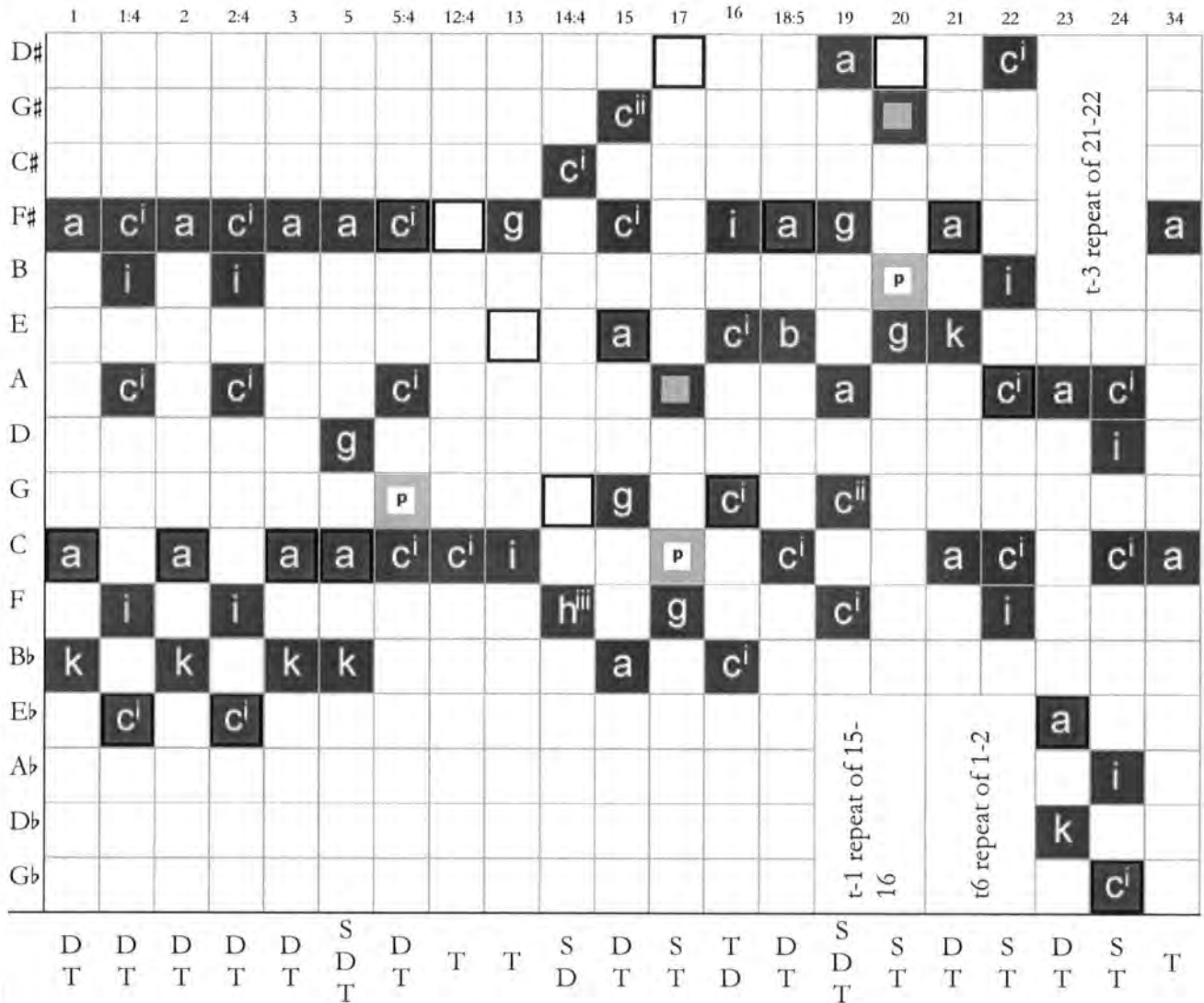

FIGURE 4-10(B): PRELUDE, OP. 67, NO. 1 – DRIVE ANALYSIS

In m. 5 a supplementary ‘alien’  $g_{\text{DRIVE}}$  emerges on D (pitches F#, A, C), which tentatively opens up the erstwhile body of  $T$  axes. This  $S$  drive expends itself through a  $p$  discharge on G (leading-tone motion from F#  $\rightarrow$  G) and further into C (latter part of m. 12), completing another small, intricate cycle. But in general terms, the  $T$  axis remains extremely firmly established throughout this opening section, and it is not until the  $S$  axis arrives in m. 14 (weakly articulated as a bass tone and  $S/D$  combination) that we

deviate from the *T*. Within the space of a single measure, this *S* function is directly discharged into the *D/T* functions, before the *T* function crystallises in the following measures. Mm. 15-19 contain no fewer than five drives of various sorts; m. 19 betrays drives on A, F#, D#, G and F drives, which involve the *T*, *S* and *D* functions: *S/D/T*. Yet a *T* undercurrent runs through this procedure, remaining until the final expression of C and F# drives.

In this piece then, rather than rotate *T*, *S* and *D* functions, Skryabin presents a single function that persists throughout – almost as a pedal point – whilst the other functions interchange and discharge above.

### Circularity and Linearity: A Dialectical Model of The Cycle of Fifths

The illustrations above have shown how Skryabin's pieces can rotate the  $T \rightarrow S \rightarrow D$  cycle. Exceptions to this procedure generally find justification from tonal tradition. In Poem, Op. 32, no. 2 the sole diversion from  $T \rightarrow S \rightarrow D$  rotation happens at the close of the piece, which alternates *T* and *D* functions in the manner of a *codetta*. The fact that this rotation is achieved through substitution calls for a reappraisal of the cycle of fifths, at least as far as it finds a home in Skryabin's musical language.

Traditionally one imagines that the 'cycle of fifths' is what it claims to be: a circle; one moves around this circle and is forced to cross a 'bridge' – either the 'enharmonic bridge' of the chromatic cycle or the 'tritone bridge' of the diatonic cycle.

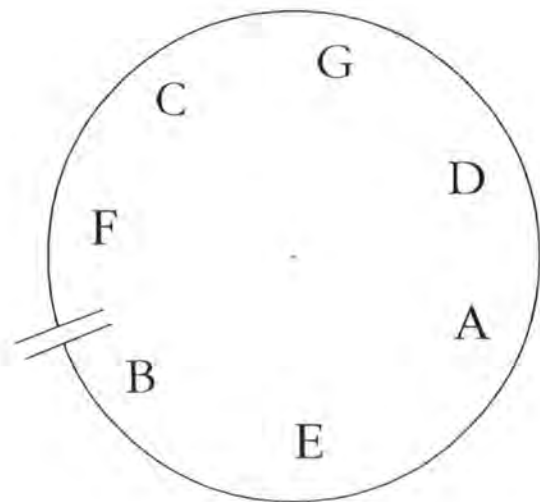
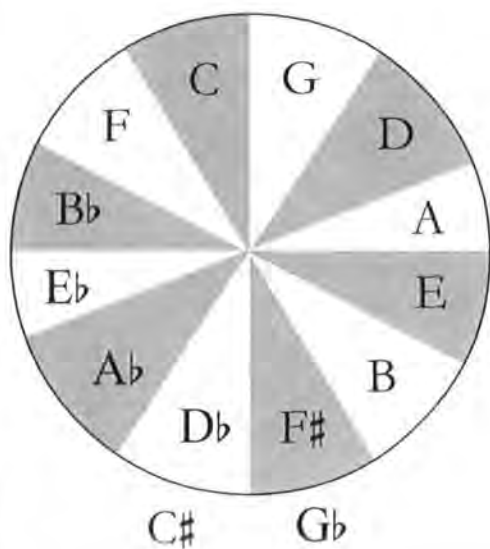

FIGURE 4-11: THE CHROMATIC CYCLE OF FIFTHS

FIGURE 4-12: THE DIATONIC CYCLE OF FIFTHS

More recently, the theorist David Temperley has straightened out this circle into a 'line of fifths'.<sup>229</sup> The difference lies beyond orthographic hair-splitting. The contrast between the line and the circle symbolises the contrast between the teleological and the aimless. Candace Brower maps diverse models of the cycle of fifths onto the physical experiences of the human body, and in a similar way, my project appeals to Lacan's theorem that bodily drives orbit a circle, temporarily making demands in the form of a 'line', which, through failure to attain its misrecognised object, returns to its circular path. Deleuze uses similar images, when he sketches his 'two regimes of madness', two 'regimes' that are also conceived as universal semiotic regimes.<sup>230</sup> Such metaphors – the circle and the line – are not unfamiliar to music theory. Ernő Lendvai claims, "In Dante's *Divine Comedy*, the symbol of the Inferno is also the circle, the ring, whereas his Paradise is symbolically the straight line, the arrow, the ray."<sup>231</sup> He shows how, throughout *The Divine Comedy*, Dante attempts to straighten out the circle. Although Lendvai's uses this symbolism to highlight Bartok's chromaticism (circular) versus diatonicism (line), his discussion can pertain to harmonic concepts like the 'cycle of fifths'. Naturally, the cycle resists such linearity: "For within the closed sphere of the fifths-circle it is as impossible to speak of fixed points of support – or 'progress' – as it is nonsensical to call the distance covered on a sphere (or circle) 'progress'".<sup>232</sup> Yet as in Dante, linear, Lacanian 'demands' ever-threaten to rupture the circle. Our conception of the 'cycle' will be entirely dialectical, synthesising two distinct models: *the linear model* and *the circular model*.

## A Linear Model

As shown, Skryabin allows lengthy 'cycles of fifths' to structure the chord progressions of his middle period works. The final passage of *Caresse dansée* is a typical gambit for a mid-late Skryabin work; its lengthy discharge chain constantly and asymptotically defers resolution. When *D* structured chords resolve into new *D* configurations, the original *D* functioned chord commutes to a *S* function. If the isolated  $D^7 \rightarrow G$  progression can be visualised as  $D \rightarrow T$ , then  $D^7 \rightarrow G^7 \rightarrow C$  becomes  $S \rightarrow D \rightarrow T$  ( $II \rightarrow V \rightarrow I$ ) if we accept that chords IV and ii are synonymous in function as they are in Lendvai's system.<sup>233</sup> As Skryabin forges a *D* path through the 'cycle of fifths', he thus sends a *S* (*DD*) ripple backwards. The three functions *S*, *D* and *T* thus acquire the status of *past*, *present* and *future*. The *D*

<sup>229</sup> Temperley, 'The Line of Fifths'. Temperley's article posits an infinite chain of fifths which are enharmonically ordered as a line rather than the more traditional circle.

<sup>230</sup> Gilles Deleuze and David Lapoujade, *Two Regimes of Madness: Texts and Interviews, 1975-1995* (New York: MIT Press, 2006), 11-16.

<sup>231</sup> Lendvai, *Symmetries of Music: An Introduction to the Semantics of Music*, 64.

<sup>232</sup> *Ibid.*, 5.

<sup>233</sup> Lerdahl discusses the way that chord functions can change. Beethoven's *Waldstein* Sonata begins with a repeated C major triad, which we no doubt hear as *T*. But as it immediately moves to a *D*<sup>7</sup> chord and is followed by *G*, we can retrospectively hear the C triad as *S*. Daniel Harrison and Kevin Swinden discuss the shared *S* function between ii and IV. Lerdahl, *Tonal Pitch Space*; Harrison, *Harmonic Function in Chromatic Music: A Renewed Dualist Theory and an Account of Its Precedents*, 202-207; Swinden, 'When Functions Collide: Aspects of Plural Function in Chromatic Music', 60 ff.

based 'desire' structures constantly chase their ever-deferred object and each failure is historically laid to rest as a *S* function. And because Skryabin resists definitive cadences, he ever-defers the *T* approach.

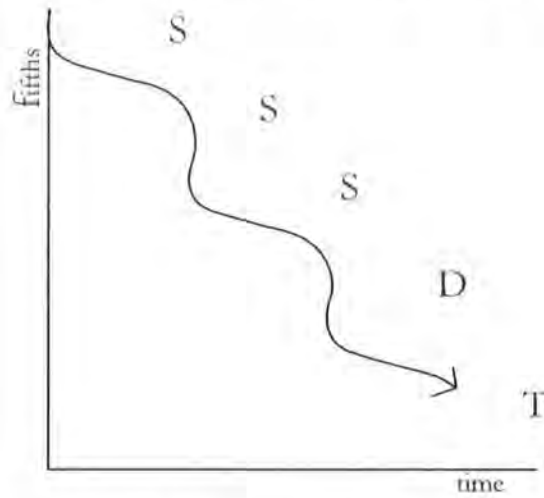

FIGURE 4-13: *S*, *D*, *T* AS PAST, PRESENT AND FUTURE

This is a linear model of 'deferred' tonal functions, but when the concept of 'substitution' enters the arena, things change dramatically. 'Substitution' offers a way of avoiding the enharmonic bridge – it redirects the line, allowing it to continue its exertion of force. The line is all about 'demand' – a demand whose failure, like Lacan's model, is ultimately absorbed by the circle.

### A Circular Model

In traditional diatonicism, the *D* chord holds an innate drive to discharge itself onto a *T* chord, but the *S* chord has no such obligation and it is almost a matter of pure convention that the *S* chord precedes the *D* in the archetypical  $IV \rightarrow V \rightarrow I$  progression.<sup>234</sup> Of course, as Rameau was quick to mention, the frequent substitution of *IV* for *ii* in the  $ii \rightarrow V \rightarrow I$  cadence maintains a cycle of fifths motion. This leads Daniel Harrison, and more so Kevin Swinden, to label the progression  $S \rightarrow D \rightarrow T$ , as I have previously hinted.<sup>235</sup> On the most basic level this progression becomes circuitous if substitution occurs in the *S* function. This works optimally if the *S* function is embodied in a 'D minor seventh' chord, because the *C* (*T*) discharges to the *F* (*S*), contained in the 'D minor seventh' complex), and the *D*<sup>7</sup> element of this *S* function resolves to *G* (*D*), which in turn resolves to *C* (*T*). This most basic form of circular substitution underpins Lendvai's 'axis system' – the substitution of a major chord for its 'relative minor'. The following rotational diagram can be drawn:

<sup>234</sup> Lendvai does produce a complex 'overtone' theory to support chord *IV*'s compulsion to move to *V*: Lendvai, *Béla Bartók: An Analysis of His Music*, 11.

<sup>235</sup> Harrison, *Harmonic Function in Chromatic Music: A Renewed Dualist Theory and an Account of Its Precedents*; Swinden, 'When Functions Collide: Aspects of Plural Function in Chromatic Music'. Harrison also discusses the shifting emphasis (termed 'balance of power' and 'functional mixture') of both functions within chord *ii*<sup>7</sup>, 65.

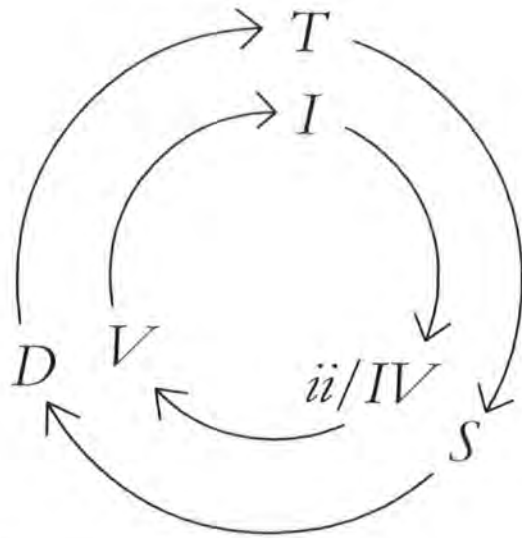

FIGURE 4-14: SUBSTITUTION AND THE LOCAL ROTATION OF  $T$ ,  $S$  AND  $D$

When Lendvai's complete system is added to this model, a broader 3-D cycle imposes itself, reducing the local  $T \rightarrow S \rightarrow D$  to epicycles, rotating within the larger circle. Hence the following model:

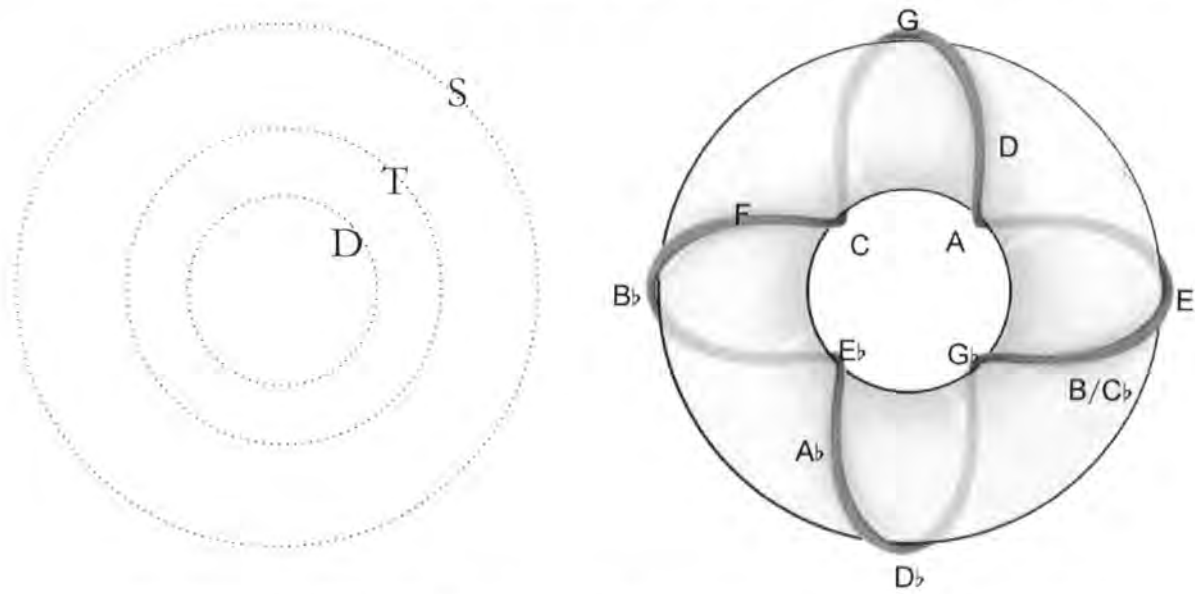

FIGURE 4-15: CIRCULAR MODEL OF THE SUBSTITUTIONAL CYCLE OF FIFTHS <sup>236</sup>

This model, content to expose the functionally rotational discharge system, is indifferent to substitution. The rotational path of the three functions runs the constant risk of intervention from 'substitutes'. Thus, through substitution, the  $T$ ,  $S$  and  $D$  functions are kept in perpetual orbit of the 'cycle of fifths'. Substitutions, as with my *linear model*, circumvent the 'enharmonic bridge', creating the potential for perpetual continuity.

<sup>236</sup> The  $S$ ,  $T$ ,  $D$  model is designed to be laid over the more complex model to show how different pitches relate as three separate strands.

## Skryabin: Synthetic Model

How do these models complement each other? The circular model, with epicycles orbiting a broader cycle, can re-inform our linear conception. Now, as time passes and the harmony orbits a cycle of fifths, each new 'object' forces a rotation of the functional epicycle rather than commute functions to an ever-dissipating  $S$  function. To highlight this, figure 4-16(a) shows a harmonic progression which accesses the cycle of fifths, by running alongside it for four notches, yielding a series of discharges, functionally labelled  $T \rightarrow S \rightarrow D \rightarrow T$ .

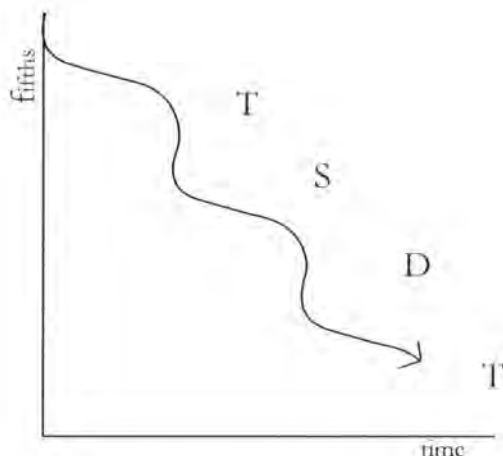

FIGURE 4-16(A): FOUR NOTCHES AROUND 'THE CYCLE OF FIFTHS'

When a new linear 'demand' is made, this progression extends to five notches, and the functions attached to individual chords shift around the cycle, thus:  $D \rightarrow T \rightarrow S \rightarrow D \rightarrow T$ .

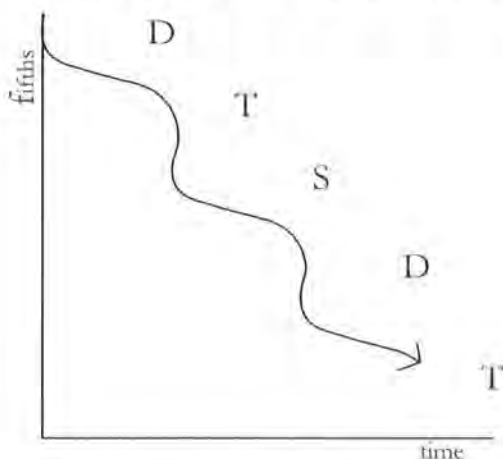

FIGURE 4-16(B): FIVE NOTCHES AROUND 'THE CYCLE OF FIFTHS'

An issue arises from this: how do we pinpoint tonal functions if they so fluidly refuse to be labelled? Ultimately, of course, we can't. One needs the cycle to approach a stable tonic centre, but, as this centre is often the one thing that Skryabin refuses to give, the task becomes difficult. This topic will be a running concern throughout the remainder of the thesis.



## Macrocosmic Fifth Rotation: Sonata no. 6, Op. 62

Of the various functions of substitution, I have so far only reviewed it as preparation to *direct discharge*. But, as illustrated in *Feuillet d'album*, Op.58, substitution can lead to *indirect discharges*. In Skryabin's later works, where there is not such a dense surface of *D* discharges, axial rotation of the cycle of fifths is used to great effect through such *indirect* discharge motions. In Sonata no. 6 Skryabin assembles an artificially static drive-structure that alternates t3 drives within a single axis. This is perfectly expected; the work is one the most consistently octatonic of Skryabin's pieces, and, as we know from analysts such as Pieter van den Toorn, octatonic collections symmetrically produce tritone and minor third 'nodes'.<sup>237</sup> But the following analysis uncovers a mobile tonal background to this static octatonic middleground. Considering Claude Herndon's analysis, that the 'harmonic ballast' of the sonata is chord V<sup>7</sup>, this is hardly surprising.<sup>238</sup> In addition, the analysis will demonstrate that, even in the most symmetrical modes, *D* → *T* discharges flourish and always threaten to erupt through surface cracks.

The octatonic scale (the '*ton-polyton*' (tone-semitone) scale) is historically the harbinger of 'mystery' in Russian opera. The same is true of the whole-tone scale, associated with a "lack" of desire, as depicted by Glinka in *Ruslan*.<sup>239</sup> The element of 'mystery' correlates to 'the subconscious', 'the drive', the 'feminine': Kristeva's *chora*.<sup>240</sup> One could convincingly argue this on Lacanian lines, alluding to a work such as Rimsky Korsakov's opera *Sadko* (1897), whose fantastical depictions of the underwater palace of the sea-queen call upon octatonicism.<sup>241</sup> Taruskin inspects the second scene of *Sadko*, and finds 'triadic octatonicism'. He highlights the way that Rimsky interjects the octatonic 'sea music' with a perfect cadence as Sadko enters, thus keeping alive the practice – thriving since Glinka – of depicting humanity through 'fifth relations' in contrast to chromatic 'fantastic' beings.<sup>242</sup> The cadential discharge here (m. 20) represents the human discharge of symbolic desire, which is alienated from Lacan's *The Real*.

<sup>237</sup> Pieter C. Van den Toorn, *Stravinsky and the Rite of Spring: The Beginnings of a Musical Language* (Oxford: Oxford University Press, 1987).

<sup>238</sup> Garcia, *Alexander Skryabin and Russian Symbolism: Plot and Symbols in the Late Piano Sonatas*, 108.

<sup>239</sup> Tarasti cites the scene depicting Tsernomor's realm as built on this mystical whole-tone 'lack': Tarasti, *Myth and Music: A Semiotic Approach to the Aesthetics of Myth in Music, Especially That of Wagner, Sibelius and Stravinsky*, 154-158.

<sup>240</sup> This view contradicts Berthold Hoeckner's assertion of Liszt's Mountain Symphony: "the symmetrical division of the octave, a product of humanity; the non-symmetrical relations, a product of nature." Berthold Hoeckner, *Programming the Absolute: Nineteenth-Century German Music and the Hermeneutics of the Moment* (Princeton, N.J.; Woodstock: Princeton University Press, 2002), 173.

<sup>241</sup> The tone poem *Sadko*, Op. 5 (1867) is the first instance recorded by Messiaen of the 'tone-semitone' scale. Richard Taruskin, 'Chernomor to Kashchei: Harmonic Sorcery; or, Stravinsky's "Angle"', *Journal of The American Musicological Society* 38/1 (1985), 93-94.

<sup>242</sup> *Ibid.*, 103.



FIGURE 4-17: TARUSKIN'S QUOTATION FROM *SADKO*, ACT I, SC II, MM. 1-22

Two worlds are depicted in *Sadko*: (1) the mercantile world of symbolic exchange and commerce in Novgorod and (2) the underwater kingdom. In the same way that Katherine Bergeron maps Debussy's *Pelléas et Mélisande* onto the Freudian triangular structure of the unconscious (the ego, the superego and the id), so do Freudian theories apply to this opera.<sup>243</sup> Simon Morrison attempts a Freudian reading of *Sadko*, situating Volkhova the sea princess as the “maternal figure”, “a manifestation of primary

<sup>243</sup> Bergeron, Katherine, *Mélisande's Hair*, in Smart, *Siren Songs: Representations of Gender and Sexuality in Opera*, 164.

narcissism”, aligning these properties with her octatonic music.<sup>244</sup> But the two worlds in *Sadko* can also map the Lacanian model of the Real and the Symbolic Order. The Real (underwater kingdom) is the ‘fluid’ libido that ignores the social rigours of financial and matrimonial commitment that exists on land. Underwater, Sadko is free to direct his libido towards the sea-queen. At the close of the opera, after he has returned to land, the sea-queen surfaces, mirroring the Lacanian ‘Return of the Real’. Why is the opera Lacanian rather than Freudian? Because the underwater ‘inner world’ is an ordered kingdom, replicating the ‘social order’ of the outer world, whilst preserving a primitive state of existence. This is the Lacanian unconscious that ‘is structured like a language’. But to prevent a digression into a mere plot analysis, let me return to my point of departure and salvage the following postulate: the mysterious, alluring, feminine, *Real* world is depicted using the octatonic collection, and this Russian trope feeds into Skryabin’s late style.

To keep apace with Skryabin’s use of octatonicism, the reader is directed to the work of George Perle, Cheong Wai-Ling, Jay Reise and Richard Taruskin.<sup>245</sup> These analysts demonstrate how Skryabin writes octatonically, but also highlight octatonicism’s dialogue with whole-tone scales and mystic chords. Reise analyses the use of conventional passing notes, appoggiaturas and neighbour-note figures to account for extraneous tones to these collections. And this conventionality at work within octatonicism has been the primary concern of my own analyses of short, late pieces, where tonal modulation schemes rotate the three *T*, *S* and *D* axes. Now I follow these relationships as they expand over larger sections of a major work. A snapshot of the Sixth Sonata would resemble a standard sonata form model such as this:

Exposition	mm. 1-124
Development	mm. 125-207
Recapitulation	mm. 208 ff.

Running through this model is the following tonal progression, uncovered by the axis system:

Exposition      →      Development      →      Recapitulation  
*T* → *S* (m.64)    →      *D* (m.128)            →      *T* (m.252)

Roland Willman maintains that there are transpositions of the ‘basic scale’, but suggests that they merely serve to “avoid monotony”. Furthermore he asserts that “rather than coinciding with the

<sup>244</sup> Simon Morrison, ‘The Semiotics of Symmetry, or Rimsky-Korsakov’s Operatic History Lesson’, *Cambridge Opera Journal* 13/3 (2001), 269.

<sup>245</sup> Perle, ‘Scriabin’s Self-Analyses’; Cheong Wai-Ling, *The Late Scriabin: Pitch Organisation and Form in the Works of 1910-14* (PhD, Cambridge University, 1991); Reise, ‘Late Scriabin: Some Principles Behind the Style’; Taruskin, ‘Chernomor to Kashchei: Harmonic Sorcery; or, Stravinsky’s “Angle”’.

piece's formal junctures, they are used to produce flowing, barely perceptible transitions.<sup>246</sup> This supposed disjunction between formal articulation and tonal operation will be the focus of my subsequent inquiry. But before examining the implications of this, I offer a brief summary. The exposition sketches a  $T \rightarrow S$  pattern, covering the first and second subject groups. The development then begins conventionally in the  $D$ . The recapitulation conflates the  $T \rightarrow S$  pattern of the exposition into a single  $T$  region. This recapitulation contains a small coda-like ( $T \rightarrow D \rightarrow T$ ) re-emphasis of the  $T$  – a familiar trope of classicism. But of course the initial  $T \rightarrow S$  transition deviates from the classical paradigm. The exposition would normally polarise the  $T$  and  $D$  regions; Skryabin, rather, maintains the 'cycle of fifths'  $T \rightarrow S \rightarrow D$  motion, fusing it flawlessly with the sonata form model. This background scheme has hitherto evaded the sonata's analysts. Rather than provide relevant *drive analyses* to accompany the appropriate excerpts from the score, I have included the entire graph as *Appendix C*. The reader is invited to consult this graph in conjunction with the musical examples. In many cases, the *drive analysis* graph, which filters the score by reproducing its patterns more visibly, is the more accessible reference point.

## Formalities

Unsurprisingly the axis system is outlaid in the exposition. Mm. 9-14 exclusively draw from drives on G, D $\flat$ , B $\flat$  and E. Mm. 10-11 enclose the first pure cycle of the four drives, unfolding B $\flat$  to E to D $\flat$  to G (see figure 3-26). Thus, until m. 14, when Skryabin drops to a G $\flat$   $a$ -DRIVE<sub>3</sub>, the pure  $T$  axis saturates the texture.

FIGURE 4-18: SONATA NO. 6, MM. 13-15

Some equivocal points of formal articulation must be considered at this point. On the broadest level I concur with the formal divisions offered by Willmann, but would argue that Skryabin's axis system impinges upon them, suggesting slightly different theme structures. Willmann cites the 'first subject' as mm. 11-38, and the 'second subject group' as mm. 39-81. His reasoning takes account of the classical four-square phrasing which dissolves into transitional material. But examining the exposition from the

<sup>246</sup> Roland Willmann, 'Alexander Scriabin's Sixth Piano Sonata, Op. 62', *Journal of the Scriabin Society of America* 8/1 (2003-2004), 23.

purview of the axis system allows a modulatory process to emerge from m. 39; this overlaps Willmann's 'second subject'. I consider this to be 'transitional'.

FIGURE 4-19: SONATA NO. 6, M. 39 FF. – SECOND SUBJECT OR TRANSITION?

The *drive analysis* graph (*Appendix C*) shows the rigid axis system beginning to break down here. In contrast to the pure *T* region (G, B $\flat$ , D $\flat$ , E), *S* chords now start to shroud sonorities. Whilst m. 39 – the point of origin of Willman's 'second subject' – begins on a pure drive on D $\flat$ , belonging to the *T* region, a prompt merger with the *S* region is presaged when the drive on B $\flat$  in mm. 43-44 discharges *indirectly* into a drive on E $\flat$  in m. 47, mediated by a *S* substitute on G $\flat$  in mm. 45-46. This new *S* drive on E $\flat$  tritonally substitutes itself as a drive on A to maintain the *S* region, but this transitional passage behaves like the Kristevan 'thetic phase': the subject is pulled back and forth between two regions. In mm. 54-60 Skryabin retreats to the *T* region with drives on B $\flat$ , E and D $\flat$ .

FIGURE 4-20: SONATA NO. 6, MM. 53-56

This D $\flat$  discharges *indirectly* into a G $\flat$  drive in m. 62 and stabilises the *S* axis after a brief restoration of the *T* as a B $\flat$  chord. By the time m. 69 arrives, the *S* region is comfortable, and this is where the 'second subject' truly begins, combined with mazurka-like rhythms.

FIGURE 4-21: SONATA NO. 6, MM. 62-69

This reading finds encouragement from Skryabin's florid performance indicators. My 'transition' – Willmann's 'second subject' – is escorted by "*le revê prend forme (clarté, douceur, pureté)*" (the dream takes shape, brightness, gentleness, purity). This crystallisation of the poetic 'dream' confirms the function of transition; the consequent *avec entrainement* (with energy) implies the newly shaped, tonally secured idea. And one must not undervalue *melodic* stability here; the five-note ascending cell is announced as a new theme, supporting the new harmonic terrain.

Of course this all reverses the position of the classical 'lyrical second subject'. Skryabin, ever concerned with evolutionary systems, manoeuvres from a lyrical, 'dreamy' beginning to a rapid, vertiginous dance theme. Even so, what could this revealing 'modulation' signify other than a *transition*, secreted at the thematic crossover point of two contrasting, octatonic, axial, drive systems?

And the recapitulation unerringly mirrors this exposition's structure, thus corroborating my formal divisions. Rather than commence in the *T* region, the *D* region of the 'development' is seamlessly prolonged. Thus, opposing the classical archetype that converts the I-V exposition into the I-I recapitulation, Skryabin transforms the I-IV exposition into V-I, fashioning a I-IV-V-I design. The formal designations I offered for the exposition remain perfectly intact in the recapitulation, the final return to the *T* region coinciding with the *avec entrainement*. This circular sonata scheme, in contrast to the traditional oppositional scheme that is based on dialectical tonal argument, permits Skryabin to safeguard a broad transposition of the exposition without further modification. This said, he does provide flashes of elaborate variation in his Byzantine recapitulation.

The 'development' section, beginning at m. 124, is equally informative. The second subject's *S* region is promptly converted to an unpolluted *D* region when the *C/F#* polarity discharges into *F/B* in m. 128. This new *D* region settles on a drive on *F*, from which vantage point the 'relative minor' substitute becomes obtainable, relocating us to a  $i_{\text{DRIVE}}$  on *D* (m.133). Mm. 137-145 contains a bitonal cycle of fifths  $D/Ab \rightarrow G/Db \rightarrow C/Gb$ . This pursues a local  $D \rightarrow T \rightarrow S$  pattern which coils back upon itself when Skryabin revisits the *D* axis in m. 168.

FIGURE 4-22(A): SONATA NO. 6, MM. 131-146

FIGURE 4-22(B): SONATA NO. 6, MM. 168-170

A fleeting glance at the *drive analysis* graph underscores Skryabin's maintenance of the *D* region throughout the remainder of the development. It seems that after the initial developmental 'cycles of fifths', Skryabin strives to make it as tonally stable as possible. This is yet another reversal of classical procedure. The development – the most unstable section of a sonata – now becomes the bedrock of the piece. This is shown clearly on the *drive analysis* graph, particularly from m. 186 where we encounter an unadulterated *D* axis.

## Summary

In summary then, clearly articulated axes merge into each other fluidly at thematic junctures of the sonata, creating a rigid background structure that rotates the  $T \rightarrow S \rightarrow D \rightarrow T$  cycle. To this end, Skryabin maintains a classical 'sonata form' in which 'functional rotation' opposes the 'Sonata Principle' that alternates  $T \rightarrow D \rightarrow T$ . In so doing the emphasis shifts from a sonata model based on tonal dialectical argument to one based on libidinal flow. Whilst each section shows significant devotion to the  $t_3$  related drives of each axis, Skryabin slips between functional axes in a modulatory fashion to reinforce the sonata's formal divisions. Thus, in Sonata no. 6, Skryabin lays careful foundations for tonally functional discharges at the macro level of tonal structure. Previous commentators have found satisfaction in this 'middleground' (an octatonic layer), ignoring the 'background' functional level. But the foreground is equally ignored; in fact the sonata is bursting at the seams with dislocated drive energies that find expression only at the foreground.



Of course, in moving into the realms of post-structural psychoanalysis, the Schenkerian 'foreground, middleground and background' model deconstructs itself, turning itself inside out, like a *möbius strip*.<sup>247</sup> Freud's unconscious is the structured background – the Oedipus Complex – which maps to Schenker's background. But as Freud's model is deconstructed by Lacan, a new background of free floating drives is presented, which can ironically only be glimpsed between cracks in the surface. The deep background and middleground models become the *dispositif* that is so carefully crafted by Skryabin into a neat, presentable parcel. These structures become Lacan's Symbolic Order – the false representations of the drive energy beneath. With *drive analysis*, in examining the Schenkerian foreground I am actually trawling the repressed underbelly of the sonata. Far from a Schenkerian 'bottom up' *Auskomponierung* (background to foreground motion), the foreground of Skryabin's music is the 'multivalent drive' from which the macro-structure is created. These drive-discharges are located at the background of the sonata, forming an octatonic (drive-excluding) middleground, from which  $D \rightarrow T$  discharges take lines of flight into the foreground.

## Discharges

Sifting through the drives that lie on the foreground of the piece reveals countless occurrences of diatonic discharges. As in the philosophy of Lyotard, libidinal energy exists in excess of the apparatus it creates; discharges flow between the rigidly octatonic language. In mm. 24-26 the axis system reveals a small cycle of fifths in the manner of Poem, Op. 32, no. 2. A preliminary *S* drive on B $\flat$  is heard with a bass pitch from the *T* axis – F – in m. 24. In the second part of the measure, the drive and the bass unite in the same  $T \ell^{\#}$ -DRIVE on F. And this F is the springboard for a cycle of fifths, interrupted by t3 leaps: F (m.24)  $\rightarrow$  B $\flat$  / E (m.25)  $\rightarrow$  / D $\flat$  / G (mm.26-29)  $\rightarrow$  G $\flat$  (m.30)  $\rightarrow$  B(C $\flat$ )/F (E $\sharp$ ) (mm.31-33)  $\rightarrow$  E (m.34).<sup>248</sup> In this way the B $\flat$ /E axis is 'prolonged' analogously to the Schenkerian paradigm. Baker illustrates that such local cycles can prolong a single function; in his discussion of *Album Leaf*, Op.45, no.1 he claims, "Such circular progressions always serve to prolong a single harmony – in this case the tonic".<sup>249</sup>



<sup>247</sup> The *möbius strip*, which knows no inside or outside, is an image commonly drawn by Lacan, Lyotard and Deleuze.

<sup>248</sup> In this nomenclature, '/' represents t3 or t6 'substitution'.

<sup>249</sup> Baker, 'Scriabin's Implicit Tonality', 5.

un peu plus lent

26

29

31

33

pp

ppp

pochias

FIGURE 4-23: SONATA NO. 6, MM. 22-35

And many other discharge patterns propagate on the octatonic bedrock, marginalised in favour of the powerfully repressive axis system. To illustrate the nested discharge in Chapter 3 I drew on a passage from this sonata (mm.181-187, figure 3-15). Although assembled from *D* axis 'blocks' (G#, F, D, B), the following progression bleeds into it: F#→B/D→G→C→F. The effect here is redoubled by the succeeding passage of the development (mm.191-204), where Skryabin exclusively draws upon the axial drives, completely eradicating (repressing) discharges (see *Appendix C*). This was one of many potential examples, and a scan through the *drive analysis* graph underscores a wide range of such intertwined discharges. Here are two more examples:

### Mm. 233-237

There are various discharges in this passage: B/F (m.233) → E (m.235) → A/D#/F#/C (mm.236-237) → B (m.237). This produces a localised *D*, *T*, *S* pattern which, again, recoils upon itself. The *S*, whose four axes are fully unfurled in mm. 236-237, leads to an *indirect discharge* from drives on C (counter pole of F#) and Eb to B.

FIGURE 4-24: SONATA NO. 6, MM. 233-237

### Mm. 328-331

In m. 328, after the initial D major chord, B/F *a*-DRIVES emerge (mm.328-329). These discharge into Bb/E *i*-DRIVES in mm. 330, whence an *i*-DRIVE (pure tritone) of A/Eb emerges in the bass. This *S*-based tritone challenges the newly established *T* region, reached through surface discharge.

FIGURE 4-25: SONATA NO. 6, MM. 328-331

## Compositional Freedom and the Tritone Link

As illustrated, whilst Skryabin sets up a rigorous octatonic middleground that is not so far removed from Dernova's model, he constantly shatters it from within, allowing errant drives to escape and

flourish above the otherwise prohibitive tonal system. The ‘nested discharge’ is only one route for libidinal energy to breach the autocratic tonal regime. Skryabin chooses to subvert the system in other ways too. Another means is to rupture the erstwhile strictly octatonic  $t_3$  based network of drive relations by harmonically compounding drives with different permutations of relationships. Such subversions serve to further critique the hegemony of Varvara Dernova’s ‘tritone link’ relationships. As examined in Chapters 2 and 3, my whole *drive theory* is based on the freedom of expression of individual drives, and my graphs are designed to signify this. Let us scan a few epigrammatic relationships found in Sonata no. 6 before integrating the findings with much richer theories of tonal space in Sonata no. 10, Op. 71.

### The whole-tone relationship

This is one of the strongest drive relationships in Skryabin’s language. As shown in Chapter 2, it occurs in the *mystic* chord and in any instances where authentic *S* and *D* chords are compounded. Examples can be found in m. 243 when the  $a$ -DRIVES on  $G\#$  and  $D$  form  $i$ -DRIVES on  $Bb/E$ , related to the  $G\#/D$  by a whole-tone. This latter  $i$ -DRIVE is immediately consolidated as a  $i'$ -DRIVE on  $E$  when the upper trill in the left-hand is initiated. This relationship is alien to Dernova’s system.

FIGURE 4-26: SONATA NO. 6, MM. 241-243

### The perfect fifth / fourth relationship

A common aspect of octatonic practice is the materialisation of tritones. These often combine and relate to each other by a fifth or fourth. In m. 321, for example,  $i$ -DRIVES on  $F\#/C$  and  $B/F$  are formed; though bound together by a tritone, they relate to *each other* by a fourth ( $F\# \rightarrow B$ ,  $C \rightarrow F$ ). Again, these relationships are precluded by Dernova.



FIGURE 4-27: SONATA NO. 6, MM. 321 FF

### The major third / sixth relationship

There are comparatively few instances of major third relationships in this particular sonata, but they do appear from time to time. The following example highlights the interconnectedness of these relationships. The  $a_{\text{DRIVE}}$  on F# in m. 181 generates such a sixth/third relationship with the  $a_{\text{DRIVE}}$  on D (spilling over from m.180) but also creates a whole-tone relation with the  $a_{\text{DRIVE}}$  on G#.

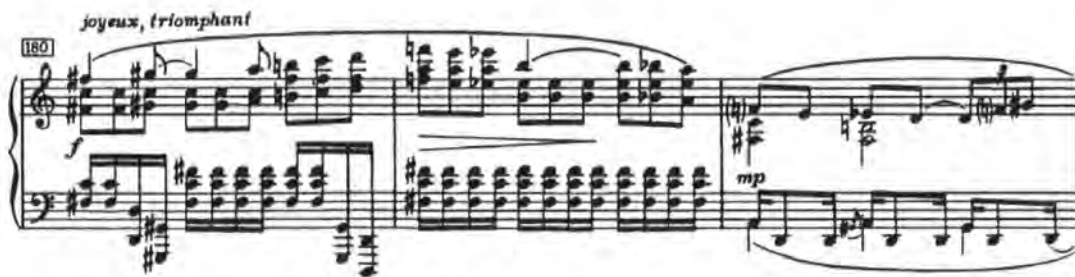

FIGURE 4-28: SONATA NO. 6, MM. 180-182

The major third relationship is certainly marginalised in this sonata but features prominently in Skryabin's latest works, a fact much overlooked in Skryabin studies. Whilst major thirds do not share the prominence they enjoyed in Beethoven's late style, they will certainly be assimilated into my forthcoming discussion of Skryabin's last sonata: Sonata no. 10.

In Chapter 2, I discussed the fact that these drives exist in a polytonal universe. I showed how Baker wrongly characterised Dernova's system as a formulation of polytonality, and thus dismissed it out of hand, for which Taruskin reproached him. But with Lendvai's axis system, polytonality is reduced to a specific kind of substitutive 'monotonicity' where four chords express a *single* function. Applicable as this is to Sonata no. 6, enough polytonal space must be recuperated to assimilate those drive relations that the axis system excludes. To this end I turn to the work of another Neo-Riemannian: Richard Cohn and his hyper-hexatonics. And to accompany this, I turn to Skryabin's final sonata.

## Sonata in Focus: Skryabin's Sonata no. 10, Op. 70

Can one construct a similar rotational tonal model of the Tenth when, because of the kaleidoscopic successions of different spaces in this work, the axis system appears to crumble? The Tenth Sonata combines two discernable types of space: (1) minor third based space (which suits axial substitution and its rotational discharges) and (2) major third based space (which I will situate within current analytical thinking in due course). This spatial alternation complicates matters, and one faces two methodologies for building a model of this sonata: (1) subsume major third relations into the minor third based 'axis system' and label *S*, *D* and *T* regardless (this is what the axis system is designed for after all), or (2) admit a new model of pitch space into the broadly axial analysis as and when major third space appears. These two approaches are not mutually exclusive, rather, they function symbiotically throughout the following discourse. But rather than move from *background* to *foreground* as I did for the Sixth Sonata, where I followed an underground tonal current until its ephemeral springs surfaced as *Anskomponierung*, I now work from the *foreground* to the *background*. In this way the tonal bedrock of this strange sonata will materialise deep below. The justification for this procedure will be found through its outcome.

Whilst sonatas 6, 7, 8 and 9 have been the focus of various analytical dissections, each one supported by a particular theoretical method, Sonata no. 10 has eluded analysts, probably on account of its suffusion of separate tonal spaces.<sup>250</sup> Sections of the piece are freely constructed from octatonic, whole tone or *mystic* collections; the piece therefore invites *drive analysis*, which indulges spatial variety. Upon completion of this analysis, remarkable patterns emerge that enlighten us about the integration of tonal spaces that organise the drives. This *drive analysis* comprises *Appendix D*.

My synthetic Lendvai / Lerdaahl substitution grid is designed to render  $t_3$ ,  $t_6$  and  $t_9$  operations but now the issue of major thirds relations is raised. The major third – 'interval-4 cycle' – is the cornerstone of Neo-Riemannian theory, espoused most rigorously by Richard Cohn. Cohn showed that *Romantic* composers utilised the smoothest possible 'voice-leading parsimony',<sup>251</sup> and for this reason he trisected the major scale into thirds to yield four groups of major chords and their minor variants. These six triads ('hexatonic' nodes) are 'maximally smooth' as each requires only  $ic_1$ ,  $ic_2$  or  $ic_3$  operations to transform into another chord from the hexatonic system. Cohn labels his poles Northern, Southern, Eastern and Western, prompted by a remark from Donald Francis Tovey regarding Schubert's tonal

<sup>250</sup> Wai-ling examines the sixth and eighth sonatas, continuing the work of Perle: Wai-Ling, *The Late Scriabin: Pitch Organisation and Form in the Works of 1910-14*. He also tackles the seventh sonata in article form: Wai-Ling, 'Scriabin's "White Mass": Dialogue between The "Mystic" And The "Octatonic".' Each late sonata is analysed in Susie Garcia's thesis, using her own thematic methodology: Garcia, *Alexander Skryabin and Russian Symbolism: Plot and Symbols in the Late Piano Sonatas*. A study of the Fifth and Tenth sonatas is undertaken by Baker in line with Skenkerian/ Fortean analytical methods: Baker, *The Music of Alexander Scriabin*, 202-214.

<sup>251</sup> Cohn, 'Maximally Smooth Cycles, Hexatonic Systems, and the Analysis of Late-Romantic Triadic Progressions'.

'star clusters', and it is understood that composers unfold chord progressions that smoothly manoeuvre around one particular pole before modulating to others.<sup>252</sup>

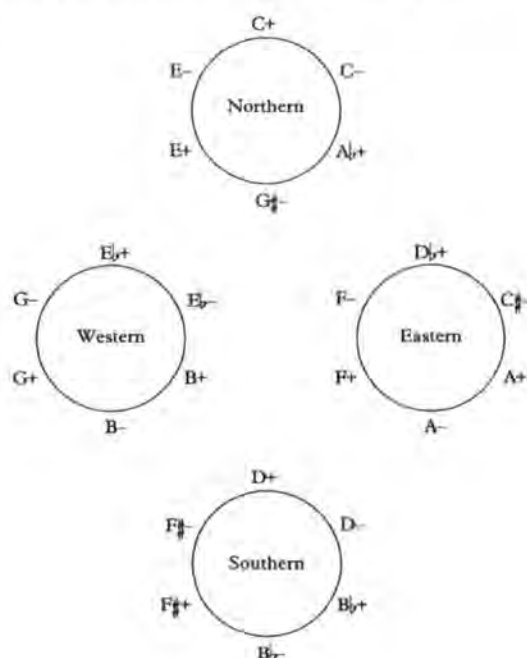

FIGURE 4-29. RICHARD COHN'S FOUR *HYPER-HEXATONIC* SYSTEMS

Cohn elliptically introduces his own form of 'substitution', though this differs from Lendvai's.<sup>253</sup> Highlighting how three of these geographical poles can represent the *T*, the *S* and the *D*, Cohn leaves a fourth pole unaccounted for.<sup>254</sup> It is unclear whether he conceives this functional equivalence as substitution or simply as a kind of inter-regional modulatory system based on the kinship of chords through maximally smooth parsimony. In either case, the premise of this equivalence is certainly not as forcefully conceived as Lendvai's. How, for example, does one account for the fourth extraneous cycle? Working in C major, the fourth cycle contains the chord of D, which could suggest an 'auxiliary *D* function'. Swinden may perhaps refer to this as a *S* function of the *DP* (dominant preparation) or *DD* (dominant of dominant) type. But however this fourth cycle is conceptualised, in combining Lendvai's and Cohn's systems, I fuse a tri-functional with a tetra-functional system. Before attempting such a synthesis, I examine Skryabin's use of major third based systems in the Tenth Sonata, allowing the music itself to indicate the correct approach.

<sup>252</sup> Richard Cohn, 'As Wonderful as Star Clusters: Instruments for Gazing at Tonality in Schubert', *19th-Century Music* 22/3 (1999).

<sup>253</sup> Whilst describing Cohn's model of tonal regions (his *fig.4*), the author claims, "The notion of "region" here generalizes Riemann's harmonic functions in the spirit of Ernő Lendvai's "axis tonality", but along different lines. Lendvai focuses on the functional equivalence of pitch-classes related by minor third, whereas the regions of *fig.4* suggest functional equivalence between harmonies whose roots are related by major third." *Ibid.*, 219.

<sup>254</sup> Cohn filters his reading of Schubert's B♭ major Sonata through his models of tonal function. *Ibid.*, 219-221.

Major third relationships are certainly marginalised in discourse on Scriabin's music. Taruskin tellingly finds structural cadences in Prelude, Op. 48, no. 4 that outline C major and its "shadows" – E and A $\flat$  – though his discovery is left theoretically open.<sup>255</sup> More pertinent to this sonata is James Baker's oblique invitation for analytical attention to be paid to the major third through his suggestions that the Tenth Sonata draws heavily from set 6-20. This set comprises two semitonally separated augmented chords – i.e. C, E, G $\sharp$ /B, D $\sharp$ , G.<sup>256</sup> In turn, it comprises full triads in three chords – C, E, G $\sharp$  – separated by major thirds. Picking up where Baker left off, I propose that passages of the sonata are constructed not only from this 'set', but also from these derivative chords. Three representative episodes of major third space ('Cohn space') are investigated below.

**Passage 1: m. 37 ff.**

Scriabin deploys basic *f* and *b<sup>iii</sup>-DRIVES* to Cohn's Eastern cycle. Originating in m. 37 with drives on F, these progress to D $\flat$  (m.40) and A (m.44) – see *Appendix D*. In m. 50 representatives from the Northern cycle are encountered – plain triads (rather than drives *per se*) on F $\flat$  (shown on *Appendix D* as E $\flat$ ), A $\flat$  and C. Scriabin rather loosely slips back to the Eastern cycle in mm. 51-52 before consolidating the Northern in m. 53-56. M. 57 however, revisits more familiar minor third territory, emphasised by C, A and E $\flat$  drives which pollute the major third cycle.

**Allegro**

The musical score is presented in two systems. The first system begins at measure 37, marked with a box containing the number 37. It includes the instruction "lumineux vibrant" and "avec émotion". The tempo is marked "Allegro". The score shows complex rhythmic patterns with many sixteenth and thirty-second notes. Fingerings and dynamics like "p" are indicated throughout. The second system begins at measure 41, marked with a box containing the number 41. It continues the complex rhythmic patterns and includes further performance markings.

<sup>255</sup> Taruskin, 'Review: "The Music of Alexander Scriabin"', James M. Baker & "Scriabin: Artist and Mystic", Boris De Schloezer', 156.

<sup>256</sup> Baker, *The Music of Alexander Scriabin*, 206.



FIGURE 4-30: SONATA NO. 10, MM. 37-56

Passage 2: mm. 158-186

A similar expedition is undertaken in the sonata's development section as Skryabin explores the Northern cycle through a modified transposition of Passage 1. Here, a succession of  $\ell^i$ -DRIVES on Ab alternate with  $\flat^{\flat}$ -DRIVES on E. This latter drive, protracted through mm. 161-162, reaches out to a complementary  $\flat^{\flat}$ -DRIVE on C. The other poles – E and Ab – begin to alternate more rapidly.

167

168

169

FIGURE 4-31: SONATA NO. 10, MM. 158-169

In m. 169 we are channelled to the Western cycle. This discharges back into the Northern in mm. 170-171, and in m. 173 Skryabin moves to drives on G, which naturally signal the return of the Western cycle.

170

*f*

*très doux*

5

173 *trm trm*

177 *p murmuré* *dim. poco a poco*

183 *en s'éteignant peu à peu*

188 *avec une douce ivresse* *ppp* *poco*

FIGURE 4-32: SONATA NO. 10, MM. 170-192

In m. 177 a further  $S$  discharge into the Southern cycle is presented initially as a  $G^b f$ -DRIVE, morphing into a  $c'$ -DRIVE. This further discharges into the Eastern cycle. Thus we pass through the Northern  $\rightarrow$  Western  $\rightarrow$  Southern  $\rightarrow$  Eastern hemispheres. In m. 184's return to the opening material, a  $S \rightarrow T$

discharge from D $\flat$  (m.183) conducts us to the A $\flat$  of the new Northern cycle. This  $e'$ <sub>DRIVE</sub> drive notably contains pitches A $\flat$ , C and E, an embodiment of the cycle as a chord.

**Passage 3: mm. 220- 247**

This passage is located after the climactic point of the piece, when a confusing deluge of minor third related and major third related drives begins to orientate itself towards pure major third relations in a recontextualised reprise of passage 1, until m. 236. Despite the similarity of this section to passage 1, the differences of m. 237 justify its analytical attention.

Musical score for measures 220-221. Measure 220 shows a complex texture with multiple voices and a large slur. Measure 221 features a dense chordal texture with a '5 2' fingering indicated in the bass line.

Musical score for measures 222-226. Measure 222 is marked 'Allegro' and includes 'trun' markings. Measure 226 shows a continuation of the rhythmic pattern.

Musical score for measures 227-236. This system shows a continuation of the complex rhythmic and harmonic texture from the previous measures.

FIGURE 4-33: SONATA NO. 10, MM. 220-248

In m. 220 simultaneous drives on B/D#/G represent the Western cycle, but simultaneous drives on C and E in m. 221 relocate us to the Northern cycle. At the moment of change, a double-barreled discharge carries the  $f_{\text{DRIVES}}$  on G and B into C and E. In m. 222 Skryabin enters the Eastern cycle with synthesised F and A minor chords to mark the point of 'recapitulation' of Passage 1. Although this

recapitulation maintains the same functional activity to begin with, from m. 236 these functions are freely recomposed. Indeed m. 236 itself, the point of deviation from the exposition, combines F and D $\flat$  triads vertically; those elements which were previously horizontally contrasted are now combined.

### Middleground: Tonal Functionality in 'Cohn Space'

As I have indicated, Cohn's regard for the four cycles as tonally functional is non-explicit. But in Skryabin's compositional practice, *direct* discharges between regional cycles enshrine functionality. For instance, in mm. 169-170 (passage 2) Skryabin unveils the E $\flat$  triad from the Western cycle and immediately discharges it into the A $\flat$  *f*-DRIVE from the Northern cycle. In another instance a double-barreled discharge, already mentioned in relation to mm. 220-221, occurs when the Northern cycle discharges to the Western (G/B $\rightarrow$ C/E). In mm. 176-178, when Skryabin modulates from the Western back into the Southern cycle, there is an E $\flat$ m $\rightarrow$ B $\flat$ m *S* discharge. Such *S* discharges are actually more common in these hyper-hexatonic shifts than one would imagine, given the *D* nature of Skryabin's drive flow. Such discharges propagate in mm. 239-240 (passage 3) when Skryabin moves from the Eastern to the Northern cycle (A $\flat$  $\rightarrow$ E). In the earliest section of 'Cohn space' (passage 1), one finds the same modulatory discharge operations when the initial move from the Eastern to the Northern cycle in mm. 49-50 is channelled through a *S* discharge (D $\flat$  $\rightarrow$ A $\flat$ ). But when Skryabin moves from the Northern back to the Eastern cycle in mm. 50-51, a *D* discharge (C $\rightarrow$ F) accompanies the manoeuvre. These modulations lend credence to my diagnosis of these cyclic switches as 'functional' changes; their strongly articulated basis in 'fifths' imbues them with *direct discharge*.

We can thus adduce hypothetical tonal patterns that form Skryabin's cycle-rotation:

Passage 1:

E  $\rightarrow$  N  $\rightarrow$  E  $\rightarrow$  N  
 T  $\rightarrow$  D  $\rightarrow$  T  $\rightarrow$  D

Passage 2:

N  $\rightarrow$  W  $\rightarrow$  N  $\rightarrow$  W  $\rightarrow$  S  $\rightarrow$  E  
 S  $\rightarrow$  T  $\rightarrow$  S  $\rightarrow$  T  $\rightarrow$  D  $\rightarrow$  DD

Passage 3:

W  $\rightarrow$  N  $\rightarrow$  E  $\rightarrow$  N  $\rightarrow$  E  $\rightarrow$  N  
 D  $\rightarrow$  T  $\rightarrow$  S  $\rightarrow$  T  $\rightarrow$  S  $\rightarrow$  T

Each passage contains a *S* discharge that temporarily reverses the cycle. In passage 3 the reversal features at the end of the progression, retracing steps from S  $\rightarrow$  T, and in passage 2 we find a S  $\rightarrow$  T in the first instance and D  $\rightarrow$  DD in the final. Passage 1 offers a much simpler form of T / D alternation which consequently calls upon both *S* and *D* discharges. Of course one could question the labels of T, *S* and *D* that are applied to each of these regional middleground progressions. My 'top-down' approach

denies me the luxury of a hegemonic *T* chord that would situate such progressions within an overarching structure. Let it provisionally suffice to note that each is drawn instinctively, though a local sense of orientation around a *T*. My primary goal is to show that Skryabin uses  $T \rightarrow S \rightarrow D \rightarrow T$  rotational procedures, however resistant the music may be to functional specificity. That is to say that, at middleground, I am as content to label a progression  $T \rightarrow S \rightarrow D$  as  $S \rightarrow D \rightarrow T$  or  $D \rightarrow T \rightarrow S$ . And so we arrive at the hypothesis that Skryabin modulates through hyper-hexatonic cycles, shifting tonal functions in the process. Yet these discharges do not rotate as in the Sixth sonata; the functional chain of connections has been weakened.

### Foreground: Functional Discharge *Within* Cycles

The functional patterns illustrated above are situated at a middleground level. Here, functional labels are applied to cycles of six tonal chords, cycles that intersect each other and thus change function. At a level closer to the foreground however, functional rotation acts within these major third cycles. Given that each cycle contains three nodes (a major third apart), the labels of *S*, *T* and *D* seem to align themselves quite neatly. At first glance, this hypothesis finds little support from harmonic theory; the progressions between cyclic nodes are ‘maximally smooth’ and therefore closely related.<sup>257</sup> These parsimonious chords do not seem to share a tensile relationship analogous to a *T* and *D*, but Lendvai’s axial substitutional procedures invest them with functionality. Lendvai’s system is, after all, the paradigm of our cognitive experience of Skryabin’s works. This integration of the two spaces will be familiar to devotees of the ‘axis system’ in any case. Lendvai views the three tonal regions – *S*, *D* and *T* – as ‘major third’ related.

As opposed to the I-IV-V-I cadence of classical harmony, the tonic, subdominant and dominant functions are *most powerfully* represented by the three degrees which divide the fifth-circle into *three equal parts* – thus constituting an augmented triad relationship. For example C-E-Ab-C, in the sense of tonic-dominant-subdominant tonic.<sup>258</sup>

Revisiting Lendvai’s model of the axis system (figure 4-1) one finds the three functions embodied in major third related chords – C, E, and Ab. But naturally, my rotational models, based on the *D* based tension of Skryabin’s cycle of fifths, proceed around an authentic  $C \rightarrow F \rightarrow G \rightarrow C$  progression.<sup>259</sup>

In “passage 1”, when hyper-hexatonic space first appears in the Tenth Sonata, Skryabin initiates the *S* function ( $b^{iii}$ -DRIVE on Db) in m. 43, succeeded by the *D* ( $b^{iii}$ -DRIVE on A) in m. 44 and the *T* ( $b^{iii}$ -DRIVE on F) in m. 45. *T* and *S* functions then alternate in the manner of a  $T \rightarrow D \rightarrow T$  codetta; the functions are

<sup>257</sup> In fact Skryabin’s rather strict use of major chords means that chords within cycles are always either ic2 related or ic3 related, and there are very few ic1 relations.

<sup>258</sup> Lendvai, *Symmetries of Music: An Introduction to the Semantics of Music*, 15.

<sup>259</sup> One must be mindful that, in passages of major third rotation in this sonata, the functions are generally embodied in either weak drives (with ambiguous ‘major sevenths’) or plain triads.

shunted around the  $S \rightarrow T \rightarrow D$  cycle, thus:  $S \rightarrow T \rightarrow S$ . A pure  $T \rightarrow D \rightarrow T$  pattern takes over as Skryabin modulates into (and out of) the Northern cycle in mm. 50-51, the latter  $T$  resulting from a *direct* discharge ( $C \rightarrow F$ ). This inter-regional cyclicity is elucidated in the Northern cycle that passes through  $T \rightarrow S \rightarrow D$  (mm. 53-56). As the hyper-hexatonic space dissolves into the minor third space, with the drives on F replaced by drives on Eb, Skryabin prolongs the  $D$  function until the  $T$   $p$  discharge in m. 62.

In “passage 2”, Skryabin advances around the  $T$  Northern cycle with a  $d_{\text{DRIVE}}$  on Ab (m. 160), and drives follow on E (m. 161) and C (m.163): a  $T \rightarrow S \rightarrow D \rightarrow T$  rotation. In mm. 174- 180 a new  $T \rightarrow S \rightarrow D$  rotation is activated, and in m. 175 the Western Cycle is traversed. M. 178 yields a  $G\flat$  – the axial functional equivalent of the  $E\flat$  drive – which slips into the Southern cycle on this occasion. Little time passes before we slip further from  $G\flat$  to D drives ( $T$ ).

Once more, hyper-hexatonic space materialises from the midst of minor third substitution space in “passage 3”. The drives delineate B,  $D\sharp$  and G chords in m. 220. Skryabin immediately discharges from B to E; this discharge is enunciated in ‘Cohn space’ with a *triple*-barreled discharge. Of course, whenever drives appear together in ‘Cohn Space’, there is necessarily a functional overlap; in this case  $B/G \rightarrow E/C$  is codified as  $T/S \rightarrow S/D$ . Thankfully, this confusion is transient; functional unfolding is less ambiguous when Skryabin moves to the Eastern pole. In m. 224 drives on F slip to the ic2 related  $D\flat$  (m.225) and again to A (m.229) before returning, via ic3, to F (m.230). This harmonic arrangement repeats, yielding the following functional progression:  $T \rightarrow S \rightarrow D \rightarrow T \rightarrow S \rightarrow D \rightarrow T$  (mm.230-235).

And so, *within* hyper hexatonic space, Skryabin allows axial substitutions to rotate foreground  $T \rightarrow S \rightarrow D$  discharges. As shown, these operate within larger, and freer, middleground motion *between* hyper-hexatonic regions.

### The Integration of Minor Third and Major Third Related Drives

In the discussion above, I indicated that these types of space are constantly exchanged; spatial regions interrupt and intersect each other. There are various novel ways in which these two different types of tonal space weave through the harmonic fabric of the Tenth Sonata, both vertically and horizontally.

- a) The opening measures (see figure 4-34) introduce this spatial dialogue. *Appendix D* shows that the drives initially oscillate between D, B and  $A\flat$  in minor third space. And yet the bass pitches of these drives are vertically disjointed, separated from the main drive by a major third. This is not such a rare phenomenon of course; this is essentially a series of ‘first inversion’ drives. But



such configurations are relatively scarce in Skryabin's repertory and, as shown, the bass can embody a drive structure of its own.

- b) Horizontally, various flashes of rapid spatial succession occur. In m. 9, drives on  $A\flat$  and  $F$  are articulated, and m. 13 supports a drive on  $C\flat$ , coeval with the established minor third space. But a drive on  $C$  (mm. 11-14) indicates major third space.  $C\flat$  and  $C$  now alternate until m. 17, each pitch representing its own spatial type.

The musical score is presented in four systems, each with a treble and bass staff. The first system (mm. 1-4) is marked 'Moderato' and 'très doux et pur', starting with a piano (*p*) dynamic. The second system (mm. 5-8) includes a 'poco rit.' marking and features a 'poco' dynamic. The third system (mm. 9-14) is marked 'cristallin' and includes a 'poco' dynamic. The fourth system (mm. 15-17) is marked 'avec une ardeur profonde et voilée' and includes a 'poco' dynamic. The bass line throughout the piece shows a drive structure with various spatial types, including drives on  $A\flat$ ,  $F$ , and  $C\flat$ .

FIGURE 4-34: SONATA NO. 10, MM. 1-17

This said, the most consistent mechanism for spatial interaction is modulation. Lerdahl would call this *hyper-modulation*. Let us extrapolate from a few of the more subtle spatial intersections.

- a) The opening passage mainly utilises minor third space, but a transition leads to major third based “passage 1”. Tritone related drives (D and A $\flat$ ) are revealed in m. 32, and Skryabin embeds a fifths-cycle: D  $\rightarrow$  G  $\rightarrow$  C  $\rightarrow$  F.<sup>260</sup> Arriving at the drive on F, an interjecting drive on A leads immediately to Cohn’s Eastern cycle.
- b) The section leading to m. 154 (“passage 2”) exploits minor third space from the *T* axis (D, F, A $\flat$ ), but a turn towards the *D* function is inaugurated by a drive on C (m. 151), relaying the A $\flat$ ’s major third cycle. This upsurge of major third space appears isolated, but *drive analysis* shows how this triad on C is replaced by a minor third related drive on F (m. 153) – a *D* discharge? which links back to A $\flat$  (m. 154) via pitch discharges on B $\flat$   $\rightarrow$  E $\flat$   $\rightarrow$  A $\flat$ .<sup>261</sup> This primes us for entrance into the Northern Cycle, where the initial C is reinstated as a true member. This whole manoeuvre was prefigured by brief, isolated expressions of the Southern cycle (mm. 137-144) within the established minor third space.

Yet on other occasions the alternation of spaces is a technique for modulating between the different functional areas of a single type of space.

- a) In m. 56, as Skryabin modulates between the Northern and Eastern cycles, the C  $\rightarrow$  E $\flat$  drive progression, creates a ‘minor third bridge’.
- b) Mm. 168-169 unfolds all three poles of the Western cycle – G, B, E $\flat$ . This latter E $\flat$  discharges itself onto an A $\flat$ , briefly traversing its Northern partner – E (m. 171). But this drive on E moves to an extended minor third related drive on G in readiness for a return to the Western cycle. Such progressions cross-examine the nature of ‘discharge’. For instance, do the drives on E and A $\flat$  discharge onto the drive on G? The drive on E shares the same function as the G and is therefore equivalent, but the A $\flat$  drive is imbued with a *D* function – an *indirect* axial discharge.
- c) In m. 178 Skryabin crosses from the Western to the Southern cycle and, again, these are bridged by minor third discharges. The drive on E $\flat$  of the Western cycle only discharges plagally onto B $\flat$  whilst a minor third related drive on G $\flat$  is enunciated. This G $\flat$  drive intersects its Southern related drive on D, but in m. 180 when Skryabin leaves this ‘Southern’ Cycle, he leads us to a drive on the minor third related F.

<sup>260</sup> A G $\flat$  / G trill bears the *p*-discharge from D to G, and the C and E pitches of m. 37 sketch-out the C chord.

<sup>261</sup> This pitch discharge is not shown on *Appendix D* due to its rapid melodic presentation.

Consequently, the minor third cycles provide mobility to major third cycles. When major third cycles dissolve, Skryabin injects minor third relations to channel the drive energy to new cycles.

### **'Background': Functional Specificity or Arbitrary Assignment?**

Having decided to approach this analysis 'top to bottom', it is time to use data from *drive analysis* to excavate the deepest level of the work. This will involve the greatest leap: finding a tonic (or at least a controlling, tonal point of focus). The assignment of tonal function in this late works is not simple; functions collide in far more subtle ways than in other pieces which I have selected for scrutiny. This leaves a number of problems for the analyst:

- 1) In Sonata no. 10, myriad foreground circular progressions are embedded in large sections, creating functional diversity, where a single tonal function presides over the others. This necessitates a 'top – down' type of analysis, where we analyse a specific passage and decide which tonal function – often among many – seems to predominate.
- 2) The sonata seems to rotate *S*-wards and *D*-wards with relatively equal frequency at its middleground. This is shown most clearly in the three 'Cohn space' "passages" which I selected.
- 3) The two spatial strands have markedly different characteristics. 'Lendvai space', uses minor thirds as machines of transmission; they are the conveyors between areas of major third repose. But more than this, they frame and control the discharges of the sonata – they are the libidinal channels. 'Cohn space', by contrast is depicted as a position of relative stability; these sections are zones in themselves – settlements rather than the carriageways; they become *Nirvanas*, depicted through triads and 'major seventh' (low drive value) chords. Thus, to pinpoint a tonic is an extremely difficult and tenuous enterprise; these four major third areas are relatively equally posited throughout.
- 4) One must face the fact that, as the functions rotate, the *T* function is governed by *différance*.<sup>262</sup> The *T* is a slippery foreground element, ever elided through the predilection of dominants to resolve onto new dominants. However much my functional rotation model grew directly from tonal paradigms and operated around a specific tonal centre, in these late works, the tonal centre is always deferred.

These problems *could* preclude the possibility of a listener attending to a single *T* function, and *could* suggest 'arbitrariness' on the part of the analyst in selecting a tonal centre. This arises only in the late works, and is essentially a dialectic of *linear* and *circular* space. In a Lacanian fashion, the drives rotate

---

<sup>262</sup> *Différance* is a Derridean term constructed from both 'differ' and 'defer'. See Jacques Derrida, 'Differance', in *Margins of Philosophy*, ed. J. Derrida (Chicago: The University of Chicago Press, 1982).

their object in circular space, making temporary *demands* on it through linear space. And yet the circular drive motion carries on *in perpetuum* and, through the lack of tonic chords, the background  $T \rightarrow S \rightarrow D$  structures continue their orbit. The  $T$  becomes a provisional  $T$ , the  $S$  a provisional  $S$  and the  $D$  a provisional  $D$ . In fact their true functions are robbed, and the tonal universe becomes entirely relative; the drives relate only to each other rather than being structured by an absolute tonic, which through Lacan, was exposed as arbitrary and false in itself. But linear *Lacanian* demands, which try to pinpoint a tonal centre – as transitory as they may be –, can help us to adduce a working fundamental tonal assignation.

Like Sonata no. 6, *linear* tonal demands reach-out in specific directions:

- 1) One could claim that the first firmly articulated drive appears on D in m. 3. Like the earlier Poem, Op. 32, no. 1, whose analysis opened this chapter (in the same key), the  $D^7$  drive, surrounded by its concomitant poles and counter poles, can signify its own tonicisation process and thus indicate the specific chord of D as a tonic.
- 2) This view of the D as  $T$  crystallises in the final moments of the sonata, when F becomes established as a pseudo- $T$  through  $D - T$  bass motions (the final bass C is heard as an open-ended  $D$  pitch). Apart from citing the opening as an  $A^b$  tonic (the tritone pole of my D), Susie Garcia agrees: “The epilogue reaffirms the triumph of the tendency of F by transposing the sonata’s opening four measures, originally in  $A^b$ , into this, new key of divine assertion.”<sup>263</sup> F belongs to the same axis as D, as does the enharmonically outlined B major triad that melodically accentuates mm. 372-373. M. 373 also affirms a drive on  $A^b$ , completing the axis.



FIGURE 4-35: ENDING OF SONATA NO. 10

- 3) Between mm. 1-32 sonorities exclusively contain drives from this same axis, apart from a very small  $T \rightarrow S \rightarrow D \rightarrow T$  configuration in mm. 7-8. This small rotation is, of course, the factor that confirms the  $T$  axis, by allowing it to run its discharge course.

<sup>263</sup> Garcia, 'Scriabin's Symbolist Plot Archetype in the Late Piano Sonatas', 299.

I choose therefore, to apply the axis system rigorously, labelling the *T*, *S* and *D* accordingly as it runs through hexatonic space. In order to deal with moments of spatial variety, I conduct a *frequency analysis*, by which I temporarily disregard the least frequent tonal functions and elicit only those that more forcefully command the tonal motion of a particular section. For instance, mm. 40-56 betray all three tonal functions, but the *S* predominates in the main, emphasised on one occasion by a clear IV – V – I bass figure (mm. 50-51). Looking at the whole sonata then, the following model presents itself. Observe how it rotates functions similarly to the Sixth Sonata, replete with a coda-like restatement of *T* → *D* → *T* functions.

T	1 - 39
S	40 - 55
D	56 - 132
T	132 - 294
D	295 - 306
T	307 - 378

FIGURE 4-36: FUNCTIONAL ROTATION MODEL OF SONATA NO. 10

How does this process accord with the piece's formal divisions? Baker's analysis of the movement marks the following structural positions.

Exposition	1 - 115
Development	116 - 223
Recapitulation	224 - 306
Coda	306 - 366

FIGURE 4-37: BAKER'S SONATA MODEL

Apart from the recapitulation, which I would claim begins two measures earlier to incorporate the *lumineux vibrant* motive from the exposition, these divisions are clear and logical.<sup>264</sup> Patently, these divisions do not coincide with my harmonic divisions, which indifferently undercut these points of formal articulation. Yet these *T*, *S*, *D* cycles are not as ambivalent as they may seem. The opening *T* function runs through the introduction, flowing into the *S* at m. 40 as the 'first subject' takes shape. The *D* function (which interjects with a similar triadic trill figure to m. 37) contains the entire 'transition' / 'second subject' combination. The reestablishment of the *T* (m. 132) occurs, unusually, in the middle of the development section, but coincides with a return to the opening phrase. Although this introductory theme is a t2 presentation (and should therefore embody a different tonal function), the *A*<sup>b</sup> nature of the sonority now fills mm. 132 more fully, emphasised (a) through the heavier bass articulation and (b) through the over-spill of the *A*<sup>b</sup>-*G*<sup>b</sup> melodic character of the previous measure. The chord is now refracted as a *T* through the fact that the malleable *e*<sup>2</sup>-DRIVE covers three tonal bases.

<sup>264</sup> Skryabin begins the recapitulation proper with m. 37 from the exposition, thus imbuing mm. 1-36 with an introductory function.

128 *f* *avec une joie subite* *dim. poco a poco*

*f* *mf* *dim.*

132 *p* *dim.* *pp*

FIGURE 4-38: SONATA NO. 10, MM. 128-137

This gesture resonates with the classical ‘false recapitulation’. In actual fact Skryabin now offers numerous ‘variational’ explorations of this opening figure, playing it ‘off’ against the ‘first theme’ (from m. 37). This whole procedure helps to consolidate the *T* function.

But although I have articulated one large section – mm. 132-336 – as  $T \rightarrow D \rightarrow T$  functioned, many ‘middleground’  $T \rightarrow S \rightarrow D$  progressions rotate within this frame. These occur at various points, notably: mm. 155-164, in an exploration of Cohn’s Northern cycle; mm. 184-192; mm. 226-230 in the Eastern Cycle; other similar cycles appear on *Appendix D*.

The weightings of these cycles is clearly variable. A large structural cycle underpins the exposition, whilst middleground cycles thrive in the latter part of the development. What does this signify? It shows that, in this more daring sonata, Skryabin loosened the bonds between formal articulation and harmonic drive to create two strands that share a tensile relationship. Tonal function, only tentatively fixed in itself, now challenges tonal boundaries, creating a fluid dialectic. This further loosens the harmonic drives; they are neither fixed to a tonic, nor a structural framework. Despite this, the final vestiges of classical tonal function cast a shadow over the whole drama.

## The Way Ahead

With the close of Chapter 4, this thesis now takes a distinctive and, it is to be hoped, appealing turn. Having sketched out my 'drive theory' and acquainted the reader with Skryabin's fascinating drive operations, I have made only vague references to Skryabin's philosophy. Chapters 2 - 4 have consequently been analytically dense. The following three chapters take sideward steps, by less obliquely synthesising Skryabin's cultural-philosophical universe with his musical world. This will reinforce *drive analysis*, but will gently move it forwards through synthesis with philosophical and cultural considerations. If Chapters 2-4 appealed more to 'hard' analysts, the remaining chapters, which take detours through four of Skryabin's most philosophically laden works, will afford a refreshing change to advocates of 'New Musicology'.

## Chapter Five

---

### Eros & Thanatos: Melodic Drives and Their Gendered Roles in Skryabin's Philosophy

*In nature, animals represent activity, the male. The growing world is the female, material, will-less and passive. Here again is polarity. Do you suppose there is some act between them possible – a polarity act? Sex. Yes, I must take walks more often. It is useful.*<sup>265</sup>

Alexander Skryabin

In an attempt to cordon-off *drive analysis* I have focussed exclusively on the flow of *harmonic* drives at the expense of those in other parameters which can exert force. In Chapter 6 these harmonic drives find a home in Skryabin's idiosyncratic psychology/philosophy as I explore the embodiment of his 'world history' in the musical framework of *Vers la Flamme* Op.72. But before this, *drive analysis* must be fortified by tackling Skryabin's *melodic* drive substance, appealing to gender studies to integrate it with his philosophy of musical representation. Skryabin's melodic structures act as interfaces between two dichotomies which were inherent in the cultural milieu that engulfed him: (1) life versus death and (2) masculine versus feminine. This study will situate these dualities in both Skryabin's ideology and his musical composition.

#### Melodic Drives

At the risk of empowering Skryabin to dictate my analytical approach from beyond the grave, it must be noted that his testimonies to his own compositional technique are excursions into the field of melody, rather than harmony, with a bent towards Schenkerian voice-leading: "Take for example my Concerto. The bedrock of its design is the descending sequence of notes. Against this background the whole theme grows and unfurls." Sabaneyev reports, "He played me the theme of the Concerto and accented these descending steps richly, and the melody took on quite a different meaning and sense." Skryabin then asserts that he exalted this practice into a definite principle, "more consciously and on a broader scale."<sup>266</sup> This said, Skryabin did famously stress, "There is no difference between melody and harmony. They are one and the same."<sup>267</sup> Given that my *drive analysis* is based on the same melodic premise as Leonard Meyer, I make no excuses for returning the ball to him. Of Meyer's innovations, the 'gap-fill' that models melodic undulation is the most relevant development to *drive analysis*. Built on the same premise as Henry Watt – that "to pass over a note immediately creates a desire for it" –

---

<sup>265</sup> Bowers, *Scriabin: A Biography* 2, 245-246.

<sup>266</sup> Bowers, *Scriabin: A Biography* 1, 240-241.

<sup>267</sup> Bowers, *Scriabin: A Biography* 2, 204.



Meyer suggests that a “structural gap in melody creates a tendency toward ‘filling in’” and constructs the following paradigm:<sup>268</sup>

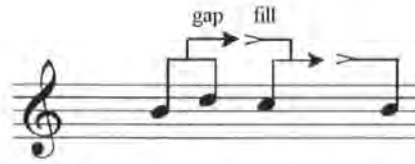

FIGURE 5-1: MEYER'S 'GAP-FILL' <sup>269</sup>

A melodic skip tends to reverse and articulate the omitted tones by moving in the opposite direction. Through this structure, rise and fall motions delimit and regulate each other. In Skryabin this ‘gap-fill’ is discernible through two antipodal melodic outgrowths: the ascending skip of a fourth (‘the gap’), and the chromatically descending line (‘the fill’). According to Meyer, and later Eugene Narmour, when any interval is heard, the immediate tendency is for that interval to repeat until it reaches a stable tone. As Meyer claims, “Once established, a patterning tends to be continued until a point of relative tonal-rhythmic stability is reached.”<sup>270</sup> Narmour claims, “all things being equal, small intervals imply both continuity of registral direction and intervallic similarity”.<sup>271</sup> Ergo, a chromatic pattern of descending tones tends to be continued, whilst a rising fourth or fifth also signifies its own perpetuation. But Meyer suggests that a reversal of any established pattern is also signified on the same basis. Skryabin, like any composer, counterbalances two drives through this procedure. What Skryabin does differently from other composers is to magnify these antipodes, availing himself of an unbroken chromatic *Ur*-motive (‘motive ♀’) and an unmitigated fourth-ascending *Ur*-motive (‘motive ♂’).<sup>272</sup> Before examining how these depict gender and erotic experience, I briefly survey their most prominent musical prototypes.

Like many other works, *The Poem of Ecstasy* contains both figures in syntactical succession. Said to be the theme of ‘self affirmation’, the rising fourth/fifth is answered by a chromatic descent: motive ♂ is subsequently counter-balanced by motive ♀.<sup>273</sup>



FIGURE 5-2: POEM OF ECSTASY

<sup>268</sup> Leonard B. Meyer, *Emotion and Meaning in Music* (Chicago; London: University of Chicago Press, 1956), 131, 134.

<sup>269</sup> Leonard B. Meyer, *The Spheres of Music: A Gathering of Essays* (Chicago: University of Chicago Press, 2000), 108.

<sup>270</sup> Meyer, *Explaining Music: Essays and Exploration*, 130.

<sup>271</sup> Eugene Narmour, *The Analysis and Cognition of Basic Melodic Structures: The Implication-Realization Model* (Chicago ; London: University of Chicago Press, 1990), 8.

<sup>272</sup> The term *Ur-motive* is applied to Skryabin's intra-opus motivic interplay by Ellon Carpenter: 'Scriabin's Octatonic Motives', *Journal of the Scriabin Society of America* 8/1 (2004).

<sup>273</sup> Bowers, *Scriabin: A Biography* 2, 135.

Sonata no. 3, Op. 23 foregrounds a similar process; Ellison Carpenter audits the many variants of the following ‘anacrusic-fourths’ figure.<sup>274</sup>



FIGURE 5-3: SONATA NO. 3

Again motive ♀ succeeds motive ♂ in this instance, but this linkage is not exclusively syntactical since the two contrasting motivic units can interlock in numerous ways. Some of these ways will be traced through melodic dissection of Sonata no. 4, Op.30 and Prelude, Op. 74, no. 2 - Skryabin’s last opus. But first my gender categories must be marked out. Before consolidating an analytical investigation with a cultural exploration of Skryabin’s own theory of gender representation, I lay the foundations by sifting through the musical repertoire with which Skryabin was acquainted. Musicology is relatively accustomed to the sense that sonata themes can be gendered to depict erotic encounter. The main thrust of Susan McClary’s work was the appropriation of the terms Masculine and Feminine by A.B. Marx (the complete works of whom stand proudly on Skryabin’s book-shelf), to characterise the first and second themes of a sonata design. The responsibility of correlating this with Skryabin’s music has been the vocation of Susanna Garcia, who compared ‘plot-archetypes’ in the late five piano sonatas.<sup>275</sup> I now submit that melodic/motivic drives can assume gender functions and convey narrative accounts of erotic experience more immediately than cumbersome thematic contrasts.

### Motive ♀ and Femininity

Gilles Deleuze understood the chromatic line as ‘a line of flight’ from tonal (arborescent) systems, contrasting its use of ‘force’ with its enemy – form. Thus he returns us to the field of ‘drives’.<sup>276</sup> In musicology, Susan McClary exposes the descending chromatic line (motive ♂) as a trope of female seduction in 19<sup>th</sup> century opera, suggesting that Bizet confines Carmen to such utterances, the famous *Habanera* being the principal illustration. Feminine control corresponds to the rate of chromatic descent; Carmen playfully lingers over certain pitches to secure power over her suitors.<sup>277</sup> The initial wave of feminist musicologists in the 1980s drew out this chromatic element of womanhood; Catherine Clément’s *Opera, or the Undoing of Women*, for instance, explored Isolde’s chromaticism in *Tristan*.<sup>278</sup> Of course her book is more polemic than analytical and citations from the score are scarce, but a metonymic chain of cultural association bridges the chasm between womanhood and chromaticism. Reproducing legends that associate rainbows with femininity, she illustrates that the

<sup>274</sup> Carpenter, *Thematic Development and Continuity in the Ten Piano Sonatas of Alexander Scriabin*, 56 ff.

<sup>275</sup> Garcia, *Alexander Scriabin and Russian Symbolism: Plot and Symbols in the Late Piano Sonatas*; Garcia, ‘Scriabin’s Symbolist Plot Archetype in the Late Piano Sonatas’.

<sup>276</sup> Gilles Deleuze and Félix Guattari, *A Thousand Plateaus: Capitalism and Schizophrenia* (London: Continuum, 1988), 106.

<sup>277</sup> McClary, *Feminine Endings: Music, Gender, and Sexuality*, 57-58.

<sup>278</sup> Catherine Clément, *Opera, or the Undoing of Women* (Minneapolis: University of Minnesota Press, 1988), 56-58.

rainbow, with its chromatic deployment of colours, represents women who occupy the space ‘in between’ the tones: “Even in death: Isolde dies as only a woman can die, by small intervals”. Furthermore, for Clément, “[chromaticism’s] rises, its descents, its imperceptible sliding are profoundly seductive.”<sup>279</sup> It is also common for the concept of descent itself to represent womanhood, as found in Robert Schumann’s five-note descending ‘Clara motive’.<sup>280</sup> But male writers too focus on Wagner; Stephen Downes casts the seduction of the sirens of *Tannhäuser* as a paradigm of musical seduction; he also follows Taruskin in locating the Russian *nega* figure in certain chromatic moments, and associates this with an “orientalized female Other”.<sup>281</sup> Wagner certainly occupied Skryabin’s young mind, although Skryabin called *Tristan* “formless” during one particular Wagner ‘study group’ at the Moscow Conservatoire.<sup>282</sup> But continuing Downes’ *sirens* illustration, the character of Venus gains chromatic intensity as Tannhäuser escapes her clinging grasp. Deploying the same tremolandi that later portray the stars in Wolfram’s Act III prayer ‘Da scheinst du, O! lieblichster der Sterne’, Venus uses chromaticism to regain some degree of control. In actual fact it is the unconscious voice of the orchestra behind her purely diatonic melodies that chromaticises the scene: “Venus, covering her face with her hands, turns passionately away from Tannhäuser, after a pause she turns to him again smiling, and with a seductive air.” The orchestra mimics her beguiling smile.



FIGURE 5-4: WAGNER'S *TANNHÄUSER*

<sup>279</sup> Ibid., 57, 127.

<sup>280</sup> Melinda Boyd, 'Gendered Voices: The Liebesfrühling Lieder of Robert and Clara Schumann', *19<sup>th</sup> Century Music* 23:2 (1999), 149.

<sup>281</sup> Downes, *Szymanowski, Eroticism and the Voices of Mythology*, 24; *The Muse as Erms: Music, Erotic Fantasy and Male Creativity in the Romantic and Modern Imagination*, Aldershot: Ashgate, 2006, 97.

<sup>282</sup> Sabaneyev, *Vospominaniya O Skryabine*, 16-17.

Notice that when Venus slips into an imperative tone (“*Lover, come!*”) she shifts to her ‘masculine’ side, outlaying motive ♂ above her chromatic motive ♀.

### Motive ♂ and Masculinity

Kurth calls this rising interval a “symbol of vaulting”; “it is a motion that reaches at the heights, that juts up into the vaulting space.”<sup>283</sup> Furthermore he claims that these “interacting consistent drives” lead to energetic processes.<sup>284</sup> This assertive, imperious line of fourths, associated with the world of military horn calls, has exhibited the manliness of many an operatic hero. The character of Siegfried is often cited as the influence to Skryabin’s failed attempt at opera in 1904, and Siegfried’s debut in *The Ring* is fairly typical:



FIGURE 5-5(A): SIEGFRIED’S ENTRY IN ‘THE RING’

This passage from *Parsifal* is also typical. Although Gurnemanz outlines a complete major triad in his initial vocal entry, he soon eliminates the extraneous third in further utterances of Act 1, Scene 1:

**GURNEMANZ**

FIGURE 5-5(B): GURNEMANZ’ ENTRY IN ‘PARSIFAL’

Isolating such tropes is a relatively unproblematic enterprise. A more challenging hermeneutic objective is to engage with these symbols and allow them to narrate erotic musical dramas. To this end, we require a composition that combines three things: (1) documented musical symbolism, (2) an extra-musical framework and (3) a cultural background that supports gender analysis. Fortunately, these coalesce in Skryabin’s Fourth Sonata.

<sup>283</sup> Kurth, *Ernst Kurth: Selected Writings*, 193.

<sup>284</sup> *Ibid.*, 22.

## A Polarity Act? Erotic Experience in Sonata no. 4

Feeling that the drudgery of teaching had stifled his creative talents, Skryabin abandoned his post at the Moscow Conservatoire in 1903, devoting himself exclusively to composition. Many ideas that had been gestating during this time flowered into some of his finest compositions, yielding a surge of music often referred to as his 'middle period'. It was during this time that Skryabin became preoccupied with the mystical and the erotic. Particularly reflective of this period is the Fourth Sonata in F# Major, Op. 30. The music is complemented by an unpublished example of Skryabin's linguistically over-charged poetry, in which a superhuman, god-like being is enticed by a distant star, which he flies towards and blissfully envelops. The two movements follow the poem's teleological form in one of Skryabin's earliest attempts to create a state of ecstasy, symbolised by 'flight'.

In a light mist, transparent vapour  
Lost afar and yet distinct  
A star gleams softly.

How beautiful! The bluish mystery  
Of her glow  
Beckons me, cradles me.

O bring me to thee, far distant star!  
Bathe me in trembling rays  
Sweet light!

Sharp desire, voluptuous and crazed yet sweet  
Endlessly with no other goal than longing  
I would desire.

But no! I vault in joyous leap  
Freely I take wing

Mad dance, godlike play!  
Intoxicating shining one!

It is toward thee, adored star  
My flight guides me

Toward thee, created freely for me  
To serve the end  
My flight of liberation!

In this play  
Sheer caprice  
In moments I forget thee  
In the maelstrom that carries me  
I veer from thy glimmering rays

In the insanity of desire  
Thou fadest  
O distant goal

But ever thou shinest  
As I forever desire thee!

Thou expandest, star!  
Now thou art a Sun  
Flamboyant Sun! Sun of Triumph!

Approaching thee by my desire for thee  
I lave myself in thy changing waves  
O joyous god

I swallow thee  
Sea of light

My self-of light

I engulf Thee!<sup>285</sup>

There was a tendency among Scriabin's circle of poets, artists and musicians to divide their philosophical and aesthetic ideas into categories of gender. Boris de Schloezer offers a taxonomy of mystics in his book, *Scriabin: Artist and Mystic*. He says, "If we draw our categories according to the relationship between the mystic and the Unique, it is possible to posit two types of mystical experience, passive and active, feminine and masculine."<sup>286</sup> He classified the 13<sup>th</sup> century mystics Meister Eckhart and St. Angela of Foligno as feminine; these people extinguished their will power in trance-like states, epitomised by Mme. Guyon in 18<sup>th</sup> century France who came close to death in such a state of passivity. We could add Scriabin's revered Helena Petrovna Blavatsky to this list of course; she believed herself to be writing her Theosophical landmark *The Secret Doctrine* under telepathic instruction from her masters in Tibet.<sup>287</sup> The masculine type of mystic was very rare; Schloezer names only Jakob Böhme, describing him as an "active", "virile" force. One of Scriabin's own pronouncements in his notebooks situates him in this dichotomy: "I want to swallow all and include (all) in my individuality. I want to give (to the world) pleasure. I want to seize the world as [one would seize] a woman."<sup>288</sup> Scriabin was to be a masculine, all-consuming life-giving force.

---

<sup>285</sup> Bowers, *Scriabin: A Biography 1*, 332-333.

<sup>286</sup> Bowers, *The New Scriabin: Enigma and Answers*, 113.

<sup>287</sup> Helena Petrovna Blavatsky, *The Secret Doctrine: The Synthesis of Science, Religion and Philosophy* (Pasadena: Theosophical University Press, 1999). Scriabin obtained a French translation of this book and integrated many of its concepts into his own philosophy.

<sup>288</sup> Bowers, *Scriabin: A Biography 2*, 54.

In the Fourth sonata, the masculine and feminine principles, which Skryabin regarded as ‘active’ and ‘passive’, become the subjects of an intimate musical drama. Taking a cue from Skryabin’s poetry we find that gender is unveiled when the object – the ‘distant star’ – is referred to as ‘her’.<sup>289</sup> It is fairly safe to assume, given Skryabin’s frequent pronouncements about the concept of ‘flight’ and his real-life flying experiments, that the poetic subject is masculine and no less a being than himself.<sup>290</sup> The opening measures embody this gender polarity. Here, two voices simultaneously unfold, both delicately moving in contrary directions, creating the warming sensation that counterpoint is being born.

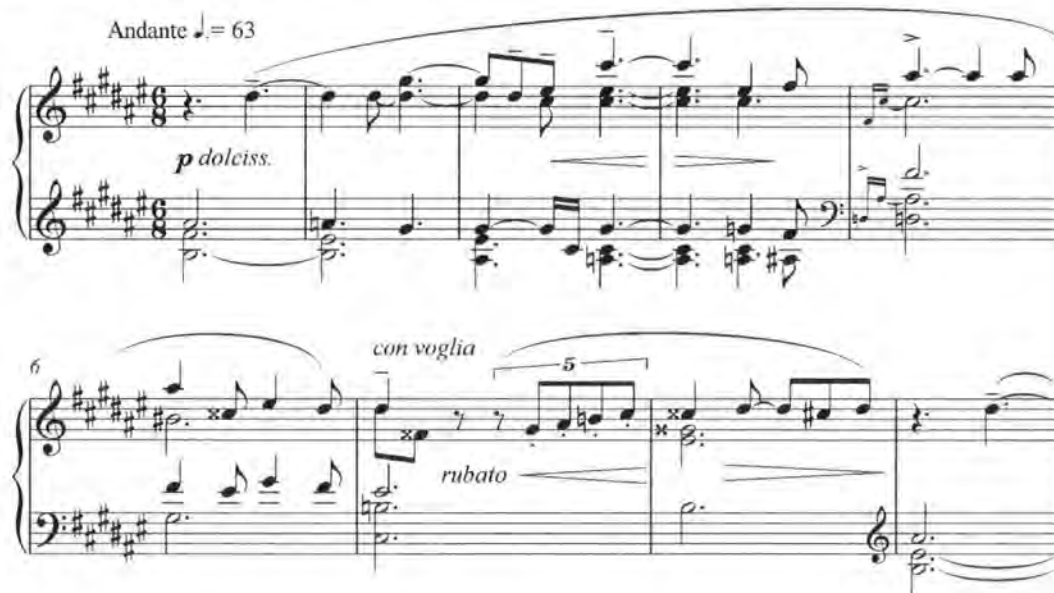

FIGURE 5-6: OPENING MEASURES OF SONATA NO. 4

And these voices correspond to motive ♀ and motive ♂, now unveiled simultaneously rather than successively. The first sonority in the left-hand is essentially an  $f_{\text{DRIVE}}$  on B: a ‘major-seventh chord’ in which the outer parts channel the interval of the seventh. A parallel chromatic descent appears and lasts throughout the first four measures: motive ♀.



FIGURE 5-7: PARALLEL DESCENDING SEVENTHS: MOTIVE ♀

<sup>289</sup> This synonymy of stars and femininity was a common trope of Skryabin’s writings. Even this early love letter to his sweetheart Natalya Sekerina in 1893, betrays this: “The star is so beautiful, and I so love my star that if I cannot gaze on it, if it cannot shine down on me in my life, and if I cannot fly to it, then thought perishes, and with it everything else. Better that I disappear in mad flight toward her. So the idea will remain, and that will triumph.” Bowers, *Scriabin: Enigma and Answers*, 34.

<sup>290</sup> It appears that Skryabin genuinely believed that he could fly. He apparently tried to convince George Plekhanov that “There are no obstacles to manifesting our wills. The law of gravity does not exist. I can throw myself from this bridge and I will not crack my head on the stones. I will float in the air. Thanks to will power.” Bowers, *Scriabin: A Biography* 2, 96. Mercifully, Skryabin chose not to demonstrate on this particular occasion.

But this smooth chromatic object is heard beneath a rising series of fourths in the upper voice, moving from D#, through G# and C#, to a displaced F#: motive ♂.



FIGURE 5-8: RISING FOURTHS: MOTIVE ♂

Rather than connect to a melodic chromatic descent, these fourths continue their trajectory, and balance is restored contrapuntally by the descending chromatic voice. The two paradigms are superimposed rather than juxtaposed.

M.6 of this sonata showcases yet another borrowed gesture from opera. Over a tender, lulling rhythm, parallel sixths discharge the tension of the sevenths of the opening chords. In opera, singing in sixths (or thirds) is a trope employed at moments when characters unite. Barricelli calls the third, “the most obvious harmony for two persons.”<sup>291</sup> At first glance, Skryabin’s favourite opera *Tristan and Isolde* appears to be an inappropriate model because, when the characters initially drink the love potion, most of the subsequent discourse of Act I calls for undiluted octaves. But this is maybe ‘just the drink talking’ for most of their Act II discourse adopts such parallel thirds and sixths at moments of affinity. This passage from *The Flying Dutchman* is telling. During Senta’s duet with Eric, the pair sing alternate lines which intersect only rarely. But Senta and her newfound love the Dutchman sing in consonance from the start.

<sup>291</sup> Barricelli, Jean-Pierre, *Liszt's Journey through Dante's Hereafter* (Bucknell Review, XXVI, No. 2), 149-166.



würd' es, du Ärmster, dir durch  
tho' me shalt find release, shalt  
würd' es durch solchen En-gel mir zu Theil, würd' es durch solchen Engel  
that I thro' such an an-gel might have peace, that I thro' such an angel

FIGURE 5-9: DUET & TERZETTO, *THE FLYING DUTCHMAN*, ACT II

This opera is highly relevant to models of gender in music; Hepokoski calls the overture one of the “most archetypal, most powerful musical constructions of gender”.<sup>292</sup> Skryabin however, seems to have preferred Wagner’s later operas.

In m. 6 of the sonata this unification of the two voices seems to be complete. The lower chromatic voice has curbed the upward thrust of the rising fourths and pulled the F# downwards to create the satisfying octave displacement. But this harmonic union spans only a single measure. The dominant seventh on G# (II<sup>7</sup>) that underpins the gesture, resolves to a C# seventh chord (V<sup>7</sup>) for a single quaver before an obtrusive ‘wrong note’ throws a spanner in the works – an F× marked ‘con voglia’. This ‘wrong note’ comes from the expectation that the upper D# (6̂) would resolve naturally as a suspension to a C# (5̂), and this minor sixth drop comes as something of an interruption. This dropping figure becomes a salient motive at the ends of phrases throughout the sonata. It always appears at moments where the voices fail to unite and where the expected tonal resolution is taken to new harmonic areas. Perhaps this is another gesture from opera, where a decisive statement – often of dismissal – is supported by a melodic drop. In *Tristan* this happens everywhere, particularly in the many instances where the lovers repeat each others’ names in a desperate bid for unification, but each repetition serves only to highlight their individuality. This instance from the end of Act I is particularly representative.

<sup>292</sup> J Hepokowski, ‘Masculine - Feminine’, *Musical Times* 150 (1994), 498.

FIGURE 5-10: TRISTAN AND ISOLDE: 'FALLING SIXTHS'

A similar motive is heard in the love scene from *Siegfried*. Just before Brünnhilde sings her beautiful "Ewig war ich, ewig bin ich", she begins to show signs of doubt and turmoil.

FIGURE 5-11: SIEGFRIED: "EWIG WAR ICH, EWIG BIN ICH": FALLING SIXTHS

The melodic drop in the sonata falls from the note  $D\#(\hat{6})$ , simultaneously prolonging the pitch from the first bar and reducing the voice of rising fourths to its starting point - square one. Indeed the voice immediately uses a simple scale to re-emphasise this  $\hat{6}$  through an appoggiatura in a Tristanesque 'longing' motive.

FIGURE 5-12: 'TRISTANESQUE LONGING'

The *Tristan* chord sits well here as Skryabin's poem refers to the subject having "no other goal than longing" – the desire to desire. Skryabin undoubtedly mused upon the concept of desire leading only to renewed desire in his youthful readings of Schopenhauer and obviously felt the resonance with Wagner.

In m. 19 of the sonata Skryabin launches into a development of this 'longing motive' in diverse keys. He generally seems to interpret the *Tristan* chord as a *French sixth*, accented through an appoggiatura. This resolves to the dominant, indicating the tonic only through implication. In this way Wagner's opening to *Tristan* presents the key of A minor through use of a French sixth moving to a dominant seventh without actually presenting a specific tonic chord. The tonic is the absent goal.

FIGURE 5-13: INTERPRETATION OF *TRISTAN* PRELUDE

And this is how tonality is implied in the Fourth Sonata; Skryabin exploits many key relationships of varying stabilities. In fact he indicates no less than ten different keys throughout the movement without ever giving definitive cadences. Moreover, these *French sixth* chords frequently approach the dominant as if it were satisfaction *in itself*, requiring no tonic; this further destabilises tonal function.

FIGURE 5-14: TRISTANESQUE ARTICULATIONS OF KEY

Here, the trill, which is usually an embellishment of a dominant chord, actually decorates the pseudo-*French sixth* creating the illusion of a chromatic move to G major rather than to C major. These modified cadences occur in many distantly related keys, always searching for a tonal object of satisfaction, finding only transitory moments of gratification. Tension is only ever partially discharged. The only cadence *per se* is offered in m. 14 in the key of Bb. Upon restatement of this local tonic at m. 16 however, the melodic material from the 'union of sixths' is now presented incompletely as a single monodic voice. This serene voice soon descends from its angelic heights, chromaticises itself and leads to the characteristic dropping sixth. This time the sixth is intensified with cross-rhythms in the lower parts – a new disjuncture.

FIGURE 5-15: FOURTH SONATA, MM. 13-18

If the gender dichotomy I drew from the opening bars fails to convince – the music being tinged with an atmosphere of “light mist” and “transparent vapour” – its clearer repetition may persuade; here polarities intensify. At m. 35 an interchange of voices sees the pianist’s left-hand articulating the rising fourths (motive ♂) whilst the right-hand plays a more objectified version of the “siren song” and the chromatic object (motive ♀) moves in octaves. This presentation supports the image of the “distant star” which “twinkles softly” and is played in a high register, replete with “glimmering rays”.

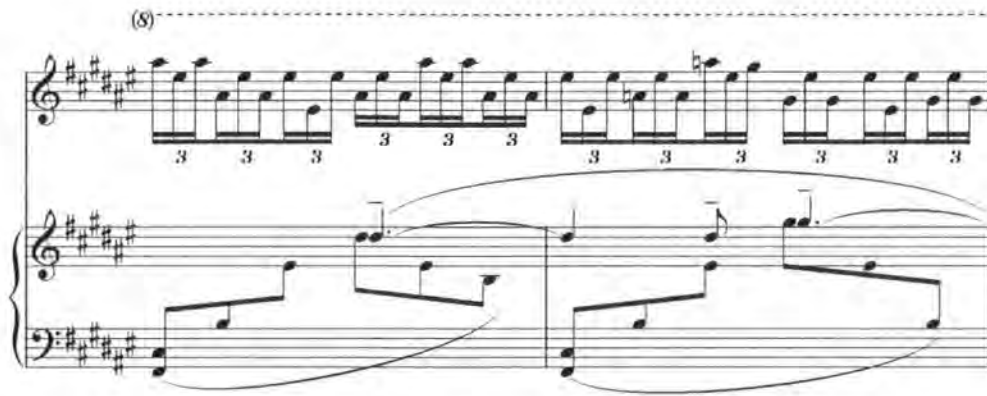

FIGURE 5-16: "GLIMMERING RAYS"

Division of voices is emphasized in two novel ways. Firstly, the piano is spatially inverted; the masculine fourths (motive ♂) are commuted to the lower "earthy" register and constantly try to penetrate the distant material (motive ♀) in the higher. The hands draw together and, when the fourths are articulated, they almost touch – a musical drama, now enacted through physical performance gesture. Secondly, the two voices become rhythmically disjointed; the lower articulates the triple metre whilst the upper presents a cross-rhythm in groups of four.

I have told the story of the man trying to fly to a distant star, but now I look at these opening measures from a different angle – a sexual drama of 'creation'. In 1903 Scriabin was about to slip into solipsism under the sway of the psychologist Wilhelm Wundt and philosopher Johann Fichte. As is well known, Scriabin came to believe that the physical world was a mere representation of his own psyche, ergo, he was the creator of the world. As early as 1894 his notebooks disclose a firm belief that creation is the key to salvation: "I can say that they [people] can expect nothing from life except THAT WHICH THEY CREATE BY THEMSELVES ALONE".<sup>293</sup> And in 1904 his notebooks read, "Thus, it is that I am the author of all experiences. I am the creator of the world."<sup>294</sup> Scriabin's initiation into philosophy came in 1894 through Schopenhauer's *World as Will and Idea*. Of course Scriabin did not feel any loyalty to the pessimistic context in which Schopenhauer wrote. Scriabin felt that by imposing *his* will, rather than *the* will, he was 'overcoming himself' in a Nietzschean sense. He synthesised these ideas, predicting a highly optimistic denouement in which he would lead the world to apocalyptic ecstasy with the eschatological *Mysterium*. In this final satisfaction of the will, suffering and desire would be laid to rest.<sup>295</sup>

Scriabin equated this act of creation with eroticism; Leonid Sabaneyev records Scriabin's testimony:

<sup>293</sup> Bowers, *Scriabin: A Biography 1*, 188.

<sup>294</sup> Bowers, *Scriabin: A Biography 2*, 58.

<sup>295</sup> The *Mysterium* was Scriabin's much discussed festival of music, dancing, colours, sounds and smells, which would bring an end to the world. The project was interrupted by the composer's untimely death in 1915.

the creative act is inextricably linked to the sexual act. I definitely know that the creative urge in myself has all the signs of a sexual stimulation within me ... And note please that the creative artist is square in the middle of this – the weaker he [the composer] is in the sexual area, the weaker his art. Maximum creativity; maximum eroticism. Look at Wagner. Tristan is his maximum, and Parsifal, already it has dropped. It's the work of a worn out old man.<sup>296</sup>

This link between creation and the sexual drive doubtless comes from Skryabin's early reading of Schopenhauer:

The sexual impulse proves itself the decided and strongest affirmation of life also that to man in a state of nature, as to the animals, it is the ultimate purpose, the highest goal of life ... Consequently the genitals are properly the focus of the will ... As such they were revered among the Greeks in the phallus, and among the Hindus in the lingam, which are thus the symbol of the affirmation of the will.<sup>297</sup>

Of course, for Schopenhauer, music was a manifestation of the will itself. So too for Skryabin although, for Skryabin, the process of creation involved a gendered polarisation.

The spirit (the creative principle) is conscious of a polarity of the masculine and feminine elements, the one active, the other passive, the will and resistance. The latter element, inactive and inert, becomes crystallised in the immobility of the material forms, in the World with its manifold phenomena.<sup>298</sup>

Skryabin then describes how these poles initially separate but reach “a culminating point” where they feel compelled to reunite. He calls this “dematerialization” and “synthesis”. When discussing the Fourth Sonata, Skryabin referred to the opening measures as “The striving upward toward creative power.”<sup>299</sup> Given that creation involved forces of will and resistance for Skryabin, this tension is played out between the upper and lower voices: motive ♂ and motive ♀. One automatically thinks of Foucault's dictum from *The History of Sexuality* – “Where there is power, there is resistance”.<sup>300</sup> Skryabin's masculine, egoistic line of fourths needs to exist in a power relationship, thus it *creates* the feminine chromatic line in resistance to itself.

Marcia Citron suggests that access to creation has always fallen under patriarchal control due to the male fear that women may actually be superior creators. She discusses the word ‘conception’, suggesting that for women it refers to physical procreation and for men it is associated with a more worthy mental phenomenon – an ‘idea’.<sup>301</sup> Skryabin seems to encapsulate both interpretations musically. Some of the most poignant moments in Skryabin's pieces are the openings which contain the birth of his ideas and their polarities. Such embryonic presentation of ideas opens many of

<sup>296</sup> Bowers, *Scriabin: A Biography* 2, 226.

<sup>297</sup> Schopenhauer, *The World as Will and Idea*, 209.

<sup>298</sup> Alfred J. Swan, *Scriabin* (London: John Lane: The Bodley Head Ltd, 1923), 76.

<sup>299</sup> Bowers, *Scriabin: A Biography* 1, 331.

<sup>300</sup> Michel Foucault, *The History of Sexuality. Vol. 1, an Introduction* (Harmondsworth: Penguin, 1981), 95.

<sup>301</sup> Marcia J. Citron, *Gender and the Musical Canon* (Cambridge: Cambridge University Press, 1993), 44 ff.

Skryabin's works; the Fifth Sonata, Op. 53 is as a case in point. Here the whole-tone E-F#-A# cell is extended to G# on the second beat.



FIGURE 5-17: SONATA NO. 5, M. 13

This sonority expands into a whole-tone passage that, in turn, gains momentum and grows into a diatonic “first subject”. Skryabin amplified this principle himself, appending the following lines to the Sonata:

I summon you to life, secret yearnings,  
 You who have been drowned in the dark depths,  
 Of the creative spirit, you timorous  
 Embryos of life, it is to you that I bring daring.<sup>302</sup>

Returning to the Fourth Sonata, this pertains also to the initial womb-like chord – the B major seventh. The third of this chord is missing in the first moments however, and the androgynous chord thus lacks a modal indicator. On the fourth beat, the pitch D# is presented in a registrally displaced form, thus giving birth to the gonochoristic separation process which is to become the main discourse of the music.<sup>303</sup> The third – D# – of the chord initiates the rising fourths.



FIGURE 5-18: OPENING MEASURE OF FOURTH SONATA

This D# – degree  $\hat{6}$  of the F# major scale – becomes vital. The sonata's second movement embodies the concept of flight inline with the motion that Kramer finds in Schubert's setting of Ganymede, from a “lower eros” to a “higher eros”.<sup>304</sup> One can hear many obvious musical analogies to flying experience when Skryabin composes sequentially ascending tremolo patterns, broken rhythms, small motives

<sup>302</sup> The quotation is from Skryabin's own *Poem of Ecstasy*.

<sup>303</sup> Gonochorism is a term used by Ernst Haeckel to denote the initial separation of the sexes from a unified source. Otto Weininger, *Sex & Character* (New York: Howard Fertig, 2003), 6.

<sup>304</sup> Lawrence Kramer claims, “the ascent thus replaces the supine receptivity with upward striving, the nightingale's call of love with Ganymede's own, and the mother's breast with the father's.” Lawrence Kramer, *Franz Schubert: Sexuality, Subjectivity, Song* (Cambridge: Cambridge University Press, 1998), 120.

fluttering around the upper register, whilst the left-hand's frequent pedal points become centres of gravity. There are more subtle means of achieving this sense of flight which are beyond the scope of this thesis, but one I mention briefly is the constant displacement of  $\hat{5}$  (C#) by  $\hat{6}$  (D#). Throughout the entire sonata, those with a Schenkerian viewpoint find it difficult to reconstruct an *Urfinie* for this reason.<sup>305</sup> This insistence on  $\hat{6}$  again probably stems from Skryabin's reading of *Tristan and Isolde*. In Isolde's *liebestod* her soul is elevated with a climactic E major chord with a suspended sixth (C#) that moves downwards to a B major chord with a similar suspension (G#). These sixths beautifully soar above Isolde's vocal line.



FIGURE 5-19: EXTRACT FROM ISOLDE'S LIEBESTOD

The  $\hat{6}$  was born in the opening of the Fourth Sonata and is only extinguished in the final measures. From creation – the birth of polarities – Skryabin leads to their ultimate destruction – “dematerialization” and “synthesis”. Approaching the end of the sonata he offers a final reminder of the irreconcilable D# ( $\hat{6}$ ) versus C# ( $\hat{5}$ ) conflict that leads to a glorified apotheosis of the opening movement, in which the two gendered voices are fused into fistfuls of repeated chords in octaves.



<sup>305</sup> For an example of attempts to apply Schenkerian analytical methods to Skryabin's 'transitional' works, see Baker, *The Music of Alexander Scriabin*. For his discussion of the Fourth Sonata, see 194-201.





FIGURE 5-20: CLIMACTIC POINT OF SONATA NO. 4

The D# (6̂) naturalises and falls chromatically to a C# (5̂) at the moment when the first pure F# triad announces itself; the final chromatic seduction has been overcome: motive ♂ has conquered motive ♀.



FIGURE 5-21: FINAL MOMENTS OF SONATA NO. 4

Thus all melodic polarities dissolve into a presentation of the *Andante* theme and ultimately into a grandiose exposition of the tonic chord. Jim Samson characterises the piece as an explicit prolongation of F#, unsatisfied until the background of the piece steps forwards.<sup>306</sup> This tonic chord has been implied many times but has remained abstract, and so skilful is Skryabin's avoidance of the chord that when it does arrive, it is scarcely adequate. Could the modern listener then be justified in siding with Adorno in viewing 'out of context' tonic chords as "impotent clichés" which "no longer fulfil their function"?<sup>307</sup> It is probably not unreasonable for Skryabin to give the public audience what he had been teasing them with for seven minutes – an ecstatic tonic chord in which all differences disappear – what

<sup>306</sup> Jim Samson, *Music in Transition: A Study of Tonal Expansion and Atonality, 1900-1920* (London: Dent, 1977), 83.

<sup>307</sup> Theodor W. Adorno, *Philosophy of Modern Music* (London: Sheed & Ward, 1948), 38.

Susan McClary referred to, drawing on the language of pornography, as “the money shot”.<sup>308</sup> But what we tend to enjoy in Skryabin’s music is the flirtation with the tonic and the generation of tension through its absence. Skryabin, in melody and harmony, spirals his drives around Lacan’s *objet petit a*, and upon its attainment, we realise that what we *actually* wanted was to approach it rather than to reach it.

## Masculine and Feminine/Life and Death: Freud, Skryabin and Russian Culture

Although Freud was revitalising the Oedipus myth whilst Skryabin was plotting the *Acte Préalable*, the composer was probably unaware of the psychoanalyst’s activities. It was not until 1920 (five years after Skryabin’s death) that Freud brought the Love/Death dichotomy into the realms of the human psyche in *Beyond the Pleasure Principle*, referring to the ‘life drive’ and the ‘death drive’. For Freud, the two drives generally antagonised each other, but sometimes – during a sexual act for example – they worked in sympathy: “In biological functions the two basic instincts operate against each other or combine with each other.”<sup>309</sup> Freud allied the life drive with creativity and the constant search for sexuality, invoking the Greek Eros, whilst in private conversations he referred to the death drive as Thanatos. The psyche’s Thanatonic energy was associated with human need for repose and longed for the peace and tranquillity of the grave. For Freud in 1923, the Id, which represented the untamed drives of the human psyche, was composed of both. In a subject’s lifespan, Eros flourished in youth, whilst Thanatos took hold during old age. Although Skryabin would not have recognised the terms Eros and Thanatos (in a Freudian sense at least), one can find a similar ‘balancing’ paradigm in Nietzsche’s *Birth of Tragedy Out of the Spirit of Music* in the figures of Dionysius and Apollo – the collective spirit of ecstasy and orgiastic festival versus the spirit of form, beauty and control. Skryabin and ‘Silver Age’ Russian artists certainly took this book closely to heart.<sup>310</sup>

For Skryabin, death and love were to unite in an apocalyptic, eschatological festival. The world, he prophesied, would be suffused with waves of ecstasy; ‘male’ and ‘female’ would disappear, and on the seventh day of his *Mysterium* he would lead the world to the threshold of death. And this holds an intense sexual charge. As Schloezer says: “In his dream of the end of universe, Skryabin saw some kind of grandiose sexual act.”<sup>311</sup> Whilst the *Mysterium* was only ideological (its composition perpetually projected into a non-existent future) we do possess sketches for the ‘watered-down’ *Acte Préalable*. This

<sup>308</sup> McClary, *Feminine Endings: Music, Gender, and Sexuality*, 113.

<sup>309</sup> Sigmund Freud, *The Complete Works of Sigmund Freud* xxiii (London: Hogarth Press, 1957), 149.

<sup>310</sup> Vyacheslav Ivanov was particularly concerned with Nietzsche’s distinction (which he cites as being appropriated from Plutarch) between Apollo and Dionysus: see James West, *Russian Symbolism: A Study of Vyacheslav Ivanov and the Russian Symbolist Aesthetic* (London: Methuen, 1970), 77–88. See also: Avri Pyman, *A History of Russian Symbolism* (Cambridge: Cambridge University Press, 1994); Rosamund Bartlett, *Wagner & Russia* (Cambridge: Cambridge University Press, 1995); Malcolm Brown, ‘Scriabin and Russian Mystic Symbolism’, *Nineteenth-Century Music* 3 (1979); Ralph E. Matlaw, ‘Scriabin and Russian Symbolism’, *Comparative Literature* 31/1 (1979); V. I. Ivanov, Robert Bird and Michael Wachtel, *Selected Essays* (Evanston, Ill.: Northwestern University Press, 2003).

<sup>311</sup> Bowers, *The New Scriabin: Enigma and Answers*, 18.

was left incomplete in 1915, but a text from Skryabin's private notebooks survived and was published as a libretto in *Russkiye Propilek: Materiali' po Istorii Russkoy Misl' I Literaturi* 9, 1916.<sup>312</sup> Musically, only fragmented jottings were preserved, but Skryabin published several piano miniatures that were to be integrated into the *Acte*. Faubion Bowers enlightens us that the second of his Op. 74 piano preludes was to accompany the moment when 'Sister Death' unveils herself to a fairly exalted operatic hero – *Man*. This prelude accentuates Skryabin's late interest in a very distinct alliance of Eros and Thanatos.

In the second act of the libretto, Death appears in the compassionate guise of 'love'. This compassionate side of death was popularised in 19<sup>th</sup> century poetry, the obvious paradigm being Claudius' *Death and the Maiden*, set by Schubert. In this poem, Death seduces a young girl who accepts it as a loving friend. While there is no evidence that Skryabin admired Schubert's songs directly, variants of this model were common currency in the Russian circle of composers. Although Skryabin began to shun musical influences in his later life, supposedly writing within his own closed sphere, he had always respected the music of Mussorgsky above other Russian musicians. This was particularly true during his earlier days at the conservatoire, when he worked closely with composers such as Arensky, Rimsky-Korsakov, Cui, Liadov, and Glazunov. Mussorgsky's *Songs and Dances of Death* – settings of Arseny Arkad'yevich Golenishchev-Kutuzov's poems – each concentrate on the spectacle of Death. In *Cradle Song* Death visits a mother who nurses a sick baby ("See, there he slumbers, my song has stilled his pain. Hush-a-bye, Hush-a-bye!"); in *Serenade* he pays court to a fever sufferer in a balcony scene ("My love song shall bring you slumber"); in *Trepak*, Death waylays "a poor peasant" ("Rest, rest, poor friend, slumber happy fellow"); in *The Field-marshal*, Death reeks havoc on the battlefield ("Sweet is the slumber that follows the fight"). Skryabin's text certainly conforms to this benevolent model of death, whose first utterance is "Don't be afraid, child. I am the one you desired." This desire for death confirms the Freudian bias, and Skryabin firmly situates Man's interactions with Death in the human mind itself; the whole scene is eventually unmasked as a vision. After the first person experience of Skryabin's text, the reader is suddenly hurled back into a narrative framework of the third person after Death's departure:

The gentle vision dissolved in the mist  
That had embraced him. The shroud again dissolves  
He lies alone in the wilderness as before.

Skryabin certainly saw value in psychology, but lived before psychoanalytic theories of love and death came into vogue. As shown in Chapter 1, he himself invites such psychological readings, teasing us that his music contains 'psychological programs': "Most of my musical poems have a specific psychological

<sup>312</sup> Simon Morrison has translated this libretto as an Appendix to *Russian Opera and the Symbolist Movement*, University of California Press, 2002. The sketches for this have been examined by Manfred Kelkel: Kelkel, *Alexandre Scriabine: Sa Vie, L'esoterisme Et Le Langage Musical Dans Son Oeuvre*.

content, but not all of them need programme notes.”<sup>313</sup> This audacious claim is unsubstantiated to be sure, but is tantalising nonetheless. Recuperating Skryabin’s text, I now filter it through the psychology which he invites.

Wilhelm Reich – a figure whose ideas are generally regarded as being as ‘cranky’ as Skryabin’s – returned to Freud’s view of Eros as the ‘creative force’, “raising living substance out of its inorganic state of repose, creating tension, and concentrating life into greater and greater unities”. He describes Thanatos as the “tendency to reduce living substance to an inanimate condition, to nothingness, to nirvana.”<sup>314</sup> Reich harboured serious objections to the ‘death drive’, reminding us that Freud’s ideas were crude and hypothetical. He recounted that, when he called upon Freud to express his unease with the way that lesser psychologists had over-zealously adopted his model, Freud agreed that he had allowed himself to speculate and hypostatise. Of course Reich’s work maintained that ‘orgastic potency’ was the principal drive of the psyche, shunning all opposition. And if the death drive were admitted into his model, the whole system would tumble. It seems that the death drive held a rather precarious place in psychology during the 1920s and 1930s. A belated mediator between Eros and Thanatos that could have placated Reich was Georges Bataille in the 1960s. Bataille invoked the French phrase ‘la petite mort’ (‘the little death’) describing the human ‘loss of self’ in sexual bliss and the return to the materiality of sensation.<sup>315</sup> Reich quoted Otto Rank’s *Trauma der Geburt*, correlating the sexual act with a “return to the womb”, but still Reich staves off the death drive. Bataille was a figure equal to Reich in advocating sexual freedom to his readers; but he also expanded Freud’s ‘death drive’. Bataille’s dichotomy was that of discontinuity / continuity. The former, he claimed, found representation in life, the latter in death.<sup>316</sup> For Bataille, this struggle between the life drive and the death drive was not necessarily part of the Romantic experience. As is well known, Bataille draws heavily on the depravity of the Marquis de Sade, as well as his own fictional writings, where love and death meet together in the presence of *horror*. His surreal pornographic novel, *The Story of the Eye*, allows the death-drive to flourish where Eros fails to satisfy: “love, pushed to its limits, is an urge towards death.”<sup>317</sup> Bataille similarly sees the ‘death-drive’ as ultimately victorious, particularly over desire. Strangely enough, he approaches Skryabin in some ways. The protagonist in Skryabin’s poem has repressed his vision of death until now when it is released through *horror*, the hero asking “Why did you come to me in the guise/ Of a blind monster with a corpse’s mouth[?]” Skryabin’s imagery reminds one of the pictures painted by Hans

<sup>313</sup> Bowers, *The New Scriabin: Enigma and Answers*, 108.

<sup>314</sup> Wilhelm Reich, *The Function of the Orgasm* (London: Souvenir Press Ltd., 1993), 126-127.

<sup>315</sup> Georges Bataille, *The Tears of Eros* (San Francisco, City Lights Books, 2002), 39.

<sup>316</sup> Bataille, *Eroticism*, 11-25.

<sup>317</sup> *Ibid.*, 42.

Baldung, oft quoted by Bataille, in which a figure of Death is seen in various forms of decomposition, seducing young females – a medieval topic.<sup>318</sup> Now of course, in Skryabin’s text, the roles are reversed.



FIGURE 5-22: PAINTINGS BY HANS BALDUNG

This horror (or repulsion) of the cadaver which Bataille explored, influenced Julia Kristeva’s work on *abjection*. She posits that the shock-force incited by corpses, sewage and filth transports us to a state of abject materiality. This sentiment was prefigured by Schelling, a philosopher who Skryabin knew well: “The unground of eternity lies this close in every person, and they are horrified by it if it is brought to their consciousness.”<sup>319</sup> This state is the Lacanian ‘Real’; we are thrust back into the semiotic *chora*, where words are meaningless and we connect with pure materiality:

The corpse ... does not *signify* death. In the presence of signified death – a flat encephalograph, for instance – I would understand, react or accept. No, as in true theatre, without makeup or masks, refuse and corpses show me what I permanently thrust aside in order to live.<sup>320</sup>

In the *chora*, Kristeva also admits Freud’s dichotomy (Eros / Thanatos), and concedes that ultimately the death drive is the stronger. She quotes Freud: “Thanatos is pure whilst Eros has, since the beginning, been permeated with Thanatos, the most deep seated drive being the death-drive.”<sup>321</sup> She, like Bataille and Reich, sees the death drive as a return to a state of continuity which existed before and after the interruption which life has afforded. As John Lechte says of Kristeva: “Death becomes equivalent to the non-life of the subject-self prior to birth. This is not the death to come, which the unconscious actively refuses.”<sup>322</sup> Thus the death drive is repressed, always present but cast aside. The

<sup>318</sup> “Three ages of woman and death’, ‘Death and the maiden’: Bataille, *The Tears of Eros*, 90-91.

<sup>319</sup> A. Bowie, *Schelling and Modern European Philosophy: An Introduction* (London: Routledge, 1993), 107.

<sup>320</sup> Julia Kristeva, *Powers of Horror: An Essay on Abjection* (New York ; Oxford: Columbia University Press, 1982), 3.

<sup>321</sup> Julia Kristeva, *The Kristeva Reader* (New York: Columbia University Press, 1986), 248.

<sup>322</sup> Maria Margaroni John Lechte, *Julia Kristeva: Live Theory* (London, New York: Continuum, 2004), 106.

abject therefore is the gateway through which the repressed material drives are released. This repressed state is discerned by Kristeva and also by Skryabin as I briefly explore before contrasting another of Skryabin's portrayals of the abject. The death drive has evidently operated within Skryabin's hero many times, but has been repressed through abject fear; fear that horror would break open the flood gates of the *chora*:

I followed you  
unexpectedly  
You feared death, fled death.

A poetic influence may have been Ivanov's Fourth Book of *Cor Ardens*, entitled "Love and Death".<sup>323</sup> Although Skryabin always cited Ivanov's *Towards the Stars* as one of his earliest influences, an inscribed copy of *Cor Ardens* is preserved on his drawing room bookshelf. In this poem, a bereaved lover remonstrates with Death. Death reveals that he has been with the loving couple 'from the beginning': a manifestation of Freudian repression.<sup>324</sup>

The *chora* (and the theoretical 'stasis' that signifies the triumph of the death drive) allies with the unconscious, exerting a constant pressure. This pressure is kept in check by the superego but, as indicated, the onset of horror forces the semiotic *chora* to temporally break through the Symbolic Order. Apart from the brief references to the horror of the cadaver in Skryabin's poem, a section before this describes a massacre in which the protagonist finds gratification through horrible acts of violence upon the earth.

More intoxicated by the stench of blood than everyone  
I am more lethal than a snake's poisons  
...  
Horror in defeat is pleasure to me  
And at the last gasp of the dying  
I am the God of greed and destruction  
I am the scourge of the peoples, I am the God of Blood!

Skryabin's work is closest to Kristeva's because she *feminises* the death drive, the abject, the *chora*, and the stasis they signify. And this state of pure materiality is associated with both birth and death – the

---

<sup>323</sup> Many poets, painters and playwrights were close friends and frequent visitors to Skryabin's Moscow home from 1911-15. Vyacheslav Ivanov was particularly close, both personally and artistically. Ivanov accepted the challenge of importing *German Romanticism* into Russia through his (rather liberal) translations of Novalis. Wachtel shows indirect reciprocal influence between Ivanov and Novalis as Ivanov's own poetic imagination penetrated his translations. A particular line from Novalis – "Down into the earth's womb/ Away from the light" – is translated by Ivanov as "I want to descend into the grave's darkness and open the earth's breast." We see that Ivanov replaces the image of the maternal 'womb' with images of death, yet suffuses the total image with that of the maternal 'breast' – thus keeping alive the tradition of death as a return to the Mother. Michael Wachtel, *Russian Symbolism and Literary Tradition: Goethe, Novalis and the Poetics of Vyacheslav Ivanov* (Wisconsin: University of Wisconsin Press, 1994), 140.

<sup>324</sup> The scene is reminiscent of Novalis, who supposedly had a similar experience of the 'other world' by the grave of his beloved. Sara Friedrichmeyer, *The Androgyne in Early German Romanticism: Friedrich Schlegel, Novalis and the Metaphysics of Love* (Bern: Peter Lang, 1983).

female womb: “The abject confronts us ... with the hold of the *maternal* entity even before existing out of her”.<sup>325</sup> Similarly to Skryabin’s poem, as I discuss later, this abject is an agent of seduction; it “draws me to the place where meaning collapses.”<sup>326</sup> This is doubtless grounded on hints from Jacques Lacan who, through a phallogocentric discourse, honoured the death drive as a return to the Pre-Oedipal and the only possible way of escaping the hegemony of the Symbolic Order: “So when we wish to attain in the subject what was before the serial articulation of speech, and what is primordial to the birth of symbols, we find it in death”.<sup>327</sup>

## Two Aspects of the Feminine: The Seductress and the Maternal

Skryabin too gave Death a specific gender – female. Fyodor Sologub, another Russian symbolist poet, marries femininity and death in his *Love and Death*, of which Avril Pyman claims, “The psychological insight of his early stories anticipate many Freudian discoveries.”<sup>328</sup> Wachtel draws attention to the conventionality of this marriage in Russia where the word ‘death’ (presumably he means “smyert”) has a feminine declension unlike the German masculine *Der Tod*.<sup>329</sup> However, this is not entirely convincing; many masculine Russian nouns – such as ‘father’ (*papa*), ‘uncle’ (*dyadya*) and some Russian male names – share feminine declensions. Further, Skryabin’s musical archetypes – Mussorgsky and Schubert – placed this benevolent death within the purview of the masculine. Of course, in Mussorgsky’s first song from *Songs and Dances of Death*, death is closely allied to the maternal figure through Death’s mimicry of the mother’s ‘rocking’ of the cradle, adding his own lullabyesque ‘hush-a-bye’. Of this particular song, Deleuze claims, “the deterritorialization of the refrain is doubled by Death in person, who replaces the mother.”<sup>330</sup> But this maternal replacement is not consistent in the cycle as a whole.

Skryabin’s Death also held a sexually alluring voice, reinforcing this feminine element of death, informing the subject that, having rejected the symbolic world, Man has found himself a new bride in Sister Death.

Your renunciation of earthly life ...  
 Your abdication of the crimson world  
 Awakened in you a bride – me.

<sup>325</sup> Kristeva, *Powers of Horror: An Essay on Abjection*, 13.

<sup>326</sup> *Ibid.* 2.

<sup>327</sup> J. Lacan, *Écrits: A Selection*, London: Tavistock Publications, 1977, 115.

<sup>328</sup> Pyman, *A History of Russian Symbolism*, 49.

<sup>329</sup> Wachtel, *Russian Symbolism and Literary Tradition: Goethe, Novalis and the Poetics of Vyacheslav Ivanov*, 106.

<sup>330</sup> Deleuze’s theory is that music ‘deteritorializes’ the refrain. In the slightly more Hegelian light of this project, we might say that music ‘negates’ the refrain. Deleuze and Guattari, *A Thousand Plateaus: Capitalism and Schizophrenia*, 331.

And she seduces: "Allow me to coalesce with you in perfect love." This was far from explicit in Mussorgsky's songs and Ivanov's poetry, and thus Skryabin injected an original element, which became dear to him: the seductress.<sup>331</sup> This compelling symbol is firmly embedded in the Russian Silver Age aesthetic; it is, in point of fact, Vladimir Solovyov's *Eternal Feminine* – a transmogrification of 'The Divine Sophia'.<sup>332</sup> Solovyov enjoyed kudos as a philosopher and poet and, as Susie Garcia puts it, he transformed Nietzsche's atheism into 'mystical christianity'.<sup>333</sup> He became a 'theosophist' in 1890, choosing to worship *Divine Wisdom* rather than God *per se*, and although he skirted around formalised Theosophical doctrines, he famously spoke at the first meeting of Rudolph Steiner's 'Russian Anthroposophical Society'.<sup>334</sup> But it is with Vyacheslav Ivanov that the concept of the Eternal Feminine bore the ripest fruit, and this is probably the tree that Skryabin ate from. Ivanov lifted the idea of the Eternal Feminine from Goethe's *Faust* as well as Solovyov, accepting that womanhood lures man towards ecstasy and knowledge. In *Pilot Stars*, his collection of early poems dedicated to Solovyov, we read of this heavenly attraction:

From the bonds of lonely separation,  
On the intoxicating wings of a dream  
Mysterious sounds draw him to her,  
A golden moon attracts him to her.<sup>335</sup>

This accords with Skryabin's Fourth Sonata, Op. 30.

Intoxicating shining one!  
It is toward thee, adored star  
My flight guides me

Skryabin met Ivanov in 1909 at St. Petersburg, establishing a warm friendship, and through the *Eternal Feminine*, Skryabin confronted the idea that the feminine functioned to lure the masculine towards inspiration, creation, absolute knowledge, and spiritual ecstasy. The Divine Sophia, for Solovyov, was the passive feminine counterpart to the active masculine Christ. Both forces pursue unity, the former unconsciously, the latter through conscious action. Unsurprisingly, the Silver Age poets chose to feed upon this unconscious desire for unification. The Eternal Feminine was further erotically charged by concupiscent poets like Alexander Blok, who venerated her as an amative replacement for Christ. Perhaps Blok could enjoy ecstatic ecclesiastical experience without the awkwardness of an assumed

---

<sup>331</sup> Although references to Eros were made in Vyacheslav Ivanov's poems, the erotic charge existed between a man and his former partner – Death was merely the executor now confronted aggressively by Man.

<sup>332</sup> Sophia was also worshipped by Novalis, whose works Skryabin encountered, particularly in his *Hymen & Die Nacht*. Friedrichsmeyer, *The Androgyne in Early German Romanticism: Friedrich Schlegel, Novalis and the Metaphysics of Love*, 91.

<sup>333</sup> Garcia, *Alexander Skryabin and Russian Symbolism: Plot and Symbols in the Late Piano Sonatas*, University of Texas, DMA Dissertation, 2000, 21.

<sup>334</sup> Maria Carlson, *No Religion Higher Than Truth: A History of the Theosophical Movement in Russia, 1875-1922* (Princeton, N.J.: Princeton University Press, 1993), 43.

<sup>335</sup> Wachtel, *Russian Symbolism and Literary Tradition: Goethe, Novalis and the Poetics of Vyacheslav Ivanov*, 49.



homosexual alliance like that of St. John of the Cross. This counterbalances the more common erotic religious encounters of women, such as the manifestation of Bernini's *The Ecstasy of St Theresa*, oft quoted by Bataille.<sup>336</sup> As Garcia tells us, any act of love directed from a man to a woman is an act of love with a representation of the Eternal Feminine. In semiotic terms, any specific object of affection is a *metonymic* representation of Sophia. The task of man was slightly abstruse; he had to realise the soul of the Divine Sophia in his own beloved and mediate between the heavenly body and her earthly representative. Blok's enthusiasm is betrayed in both his poetry and his personal writings. As Avril Pyman points out, the Eternal Feminine was a "'Salvation myth', suggested by Blok's cultural heritage: Dante, Goethe, the German Romantics, Vladimir Solovyev and reconfirmed for him by the fact that the myth was shared not only by contemporary Russian poets such as Andrey Bely, Sergey Solov'ev and Georgy Chulkov, but to a greater or lesser degree by European precursors and contemporaries from Baudelaire to Strindberg."<sup>337</sup> To this list of 'European precursors' we must add Wagner, whose writings reveal his absorption of the Eternal Feminine that leads him to claim in *Sämtliche Briefe*, "it is love that is really 'the eternal feminine' itself."<sup>338</sup>

And yet for all her seductive tendencies, the Eternal Feminine absorbed maternal qualities. Garcia says, "Sophia is the divine basis of essence of that which, as created, is distinct from God; it is the living soul of the created world."<sup>339</sup> Blok called her the 'world soul', and not only monumentalised the Eternal Feminine in his wife, Lyubov' Dmitriyevna, but also in his mother, leading Avril Pyman to suggest that Izora – the heroine of his play *The Rose and the Cross* – was "inspired by both".<sup>340</sup> Garcia claims, "Sophia is ... the living soul of the created world."<sup>341</sup> In this aspect a musicologist naturally remembers Wagner's Erda – the eternal mother – whom Wotan feels so compellingly drawn towards. Catherine Clément's Oedipal analysis suggests that Wotan is led towards erotic union with Erda in an attempt to retrace his own 'prehistory'.<sup>342</sup> The maternal side of the Eternal Feminine inevitably resonated with the works of Madam Blavatsky, who explored the basis of *Prakriti* (the maternal soul of the world) in *Samkyha* philosophy. Blavatsky, as a female, released Sophia from the phallogocentric speculations of male artists, who manipulated her to suit their own amorous predispositions. The symbolist author Andrey Bely perhaps deviates from this model. Through an acquaintance with Mikhail Solovyov (Vladimir's younger brother), Bely was introduced to the concept first-hand. Like Blok, Bely equated

<sup>336</sup> By Teresa's own account: "The pain was so great that it caused me to utter several moans; and yet so exceeding sweet it is this greatest of pains that it is impossible to desire to be rid of it, or for the soul to be content with less than God." See Peers, E. Allison. *Studies of the Spanish Mystics*, London, 1927, 197.

<sup>337</sup> Avril Pyman, *Aleksandr Blok: The Twelve* (Newcastle: University of Durham, Tyneside Free Press, 1989), 37.

<sup>338</sup> Jean-Jacques Nattiez, *Wagner Androgyne: A Study in Interpretation* (Princeton, N.J.; Chichester: Princeton University Press, 1993), 127.

<sup>339</sup> Garcia, *Alexander Skryabin and Russian Symbolism: Plot and Symbols in the Late Piano Sonatas*.

<sup>340</sup> Avril Pyman, *The Life of Alexander Blok* (Oxford: Oxford University Press, 1980), 160.

<sup>341</sup> Garcia, *Alexander Skryabin and Russian Symbolism: Plot and Symbols in the Late Piano Sonatas*, 32.

<sup>342</sup> Clément, *Opera, or the Undoing of Women*.

the Eternal Feminine with 'the world soul'. But for Bely she was also the "supra-individual ego" that identified with mankind; an ego shared by all individuals. His earlier essays build on this foundation, claiming that the idea of religion was to make 'real' the things artists communicate in art; the Eternal Feminine for him was 'truth'. Art to Bely, was a progression which was like a bomb that, when thrown, destroys itself and the object it attacks. The Eternal Feminine was the guiding truth-force behind this bomb.<sup>343</sup>

How does the *Eternal Feminine* slot into our psychoanalytic tradition? Blok's attempts to rejuvenate the Eternal Feminine in his own life, bringing her out of his fantasy space, resonates with Lacan's work. Lacan continued Freud's phallogocentric discourse in his own version of The Eternal Feminine: 'the woman who does not exist'.<sup>344</sup> Slavoj Žižek appealingly elucidates this through the movies of Alfred Hitchcock. In *Vertigo*, James Stewart pursues a mysterious woman whose death leaves him distraught; he then attempts to recreate the image of the mysterious woman through a common shop girl. This harmonises with Blok's attempts to realise the mysteriously alluring *Eternal Feminine* in his own mundane wife. But as Žižek explains "It is precisely the impossible relationship between the fantasy figure of the Other Woman [The Eternal Feminine] and the 'empirical' woman who finds herself elevated to the sublime place that is the subject of Hitchcock's *Vertigo*."<sup>345</sup> Of course what Lacan held over the discourse of men in the 19<sup>th</sup> and early 20<sup>th</sup> centuries was the realisation that this form of sublimation leads to death. In *Vertigo*, James Stewart's substitute for the mysterious woman turns out to actually *be* the original woman who feigned her own death, and the disillusioned Stewart is forced to look on the recreated Eternal Feminine as an apocalyptic failure. For Lacan, sublimation is all about death. As Žižek says, "the power of fascination exerted by a sublime image always announces a lethal dimension."<sup>346</sup> And Skryabin may certainly have reached this sentiment through Weininger who said, in respect of Dante's Beatrice, that love of woman is "destruction of the empirical personality of the woman" because the Eternal Feminine replaces her. Therefore, "love is murder".<sup>347</sup> Thus the Eternal Feminine allies closely with Death. Ivanov too, at an early stage, tried linking the Eternal Feminine to the figure of death; his poem continues:

There she, on the sad clearing,  
Waits alone for him above the grave,  
Sitting motionless in the mist,  
Cold and pale like the mist<sup>348</sup>

<sup>343</sup> John Elsworth, *Andrey Bely: A Critical Study of the Novels* (Cambridge: Cambridge University Press, 1983), 25-27.

According to Avril Pyman, Bely was obsessed with metaphors of 'blowing up': *The Life of Alexander Blok*, 205.

<sup>344</sup> Lacan, Mitchell and Rose, *Feminine Sexuality: Jacques Lacan and the Ecole Freudienne*, 137; Chapter 6: *God and the Jouissance of The Woman, A Love Letter*.

<sup>345</sup> Žižek, *Looking Awry: An Introduction to Jacques Lacan through Popular Culture*, 83.

<sup>346</sup> Ibid.

<sup>347</sup> Weininger, *Sex & Character*, 249.

<sup>348</sup> Michael Wachtel, *Russian Symbolism and Literary Tradition: Goethe, Novalis, and the Poetics of Vyacheslav Ivanov* (Madison, Wisconsin: University of Wisconsin Press, 1994), 47 ff.

But Skryabin was even more explicit than his poetic contemporaries. And here I return to the *Acte Préalable* that, as shown, allies the Eternal Feminine with ‘Sister Death’. After exposing the correspondence between death and eroticised female seduction, we are poised to make a dialectical return to our point of departure, my motive ♀. Ivanov loved *Tristan and Isolde*, and found “primordial chaos” in its chromatic lines. And in the Prelude, Op. 74, no. 2, Skryabin saturates the entire texture with chromatic lines at different levels. These lines do not exist in the beginning; rather, they grow from the first phrase, in which they appeared as an intensification device. Notice how the opening phrase introduces a minor third interval (A → B $\sharp$ ), succeeded by a major second (A → G) and a chain of chromatic notes; the intervals draw inwards and downwards. The last notes of this chain (F $\sharp$ , E $\sharp$ , E $\flat$ ) – three half steps – assume the character of an accompaniment in m. 5 and the opening phrase transforms into the melody above.

The musical score for the Prelude, Op. 74, No. 2 by Scriabin, is presented in four systems. The first system (measures 1-5) begins with a piano (*pp*) dynamic. The second system (measures 6-9) continues the chromatic texture. The third system (measures 10-12) shows further development of the chromatic lines. The fourth system (measures 13-17) concludes with a *pp* dynamic and a *dim. smorz.* (diminuendo and *smorzando*) marking. The score is written for piano with treble and bass staves.

FIGURE 5-23: PRELUDE, OP. 74, NO. 2

But apart from seduction, the chromatic line can also be a signifier for melancholic associations of death, especially when coinciding with a minor key. Despite the piece's almost exclusively octatonic bias (collection III from Pieter Van Den Toorn's classifications), the opening chord is a stolid F# minor triad. The omnipresent pedal tone of F# is another clear reference to the death's melancholic aspect, alternating the fifths of the F# triad with those of C in a typically Stravinskian fashion (see *Petrushka*). Pedal tones always appeared in Skryabin's works when death was concerned. In his First Sonata, Op. 19 a 'funeral march' is laid over a pedal tone's vacillation between the tonic and dominant, sharing the same rhythm as this Op. 74 Prelude.



FIGURE 5-24: FIRST SONATA, OP. 16 – FUNERAL MARCH

The same is true of his other funeral march – the *Alla Marcia* of Sonata no. 9 – *The Black Mass*:



FIGURE 5-25: *ALLA MARCIA* FROM SKRYABIN'S SONATA NO. 9

These pedals doubtless correspond to funeral marches which always focus on a single fetishised feature – a rhythm or a pitch. This fetishisation of a single entity sometimes denies the music's dialectical tendency to engage with 'other' materials to construct form: the material lies passively. In contrast to the wild, raging melodic lines and chord progressions of the first part of *Death and the Maiden*, Schubert represents the 'single mindedness' of Death with tonic and dominant harmony and an all-pervasive dactylic rhythm.



FIGURE 5-26: SCHUBERT'S DEATH AND THE MAIDEN

In Mussorgsky's songs, Death similarly moves to the beat of a very persistent dance rhythm, but also frequently fetishises single motives like the sighing drop of 'hush-a-bye' in *Cradle Song*. Mendelssohn's *Funeral March* from *Lieder Ohne Worte*, which Skryabin studied as a youth and which shares a similar theme to Mahler's Fifth Symphony, propels a perpetual triplet figure.



FIGURE 5-27: MENDELSSOHN'S *FUNERAL MARCH*

And of course Chopin's *Funeral March* fetishises itself as a ritornello-like subject, articulated as an almost static object, whilst other ideas flower into themes. The march, as a fixed 'inner' object, resists the dialectical 'outside' subjective world. An important influence to Skryabin was the late style of Liszt. The second movement, *Trauer-Marsch*, from *Trauer – Vorspiel und Marsch* contains an entirely chromatic line:



FIGURE 5-28: REDUCTION OF LISZT'S *TRAUER – VORSPIEL UND MARSCH*

In the funereal topic, death entwines with melancholia; mourners force themselves to become fixated. As Freud puts it: "the loved object no longer exists, and it proceeds to demand that all libido shall be withdrawn from its attachments to that object... This ... can be so intense that a turning away from reality takes place and a clinging to the object through the medium of a hallucinatory wishful psychosis."<sup>349</sup> It is against these fixations that 'love-deaths' seem to oppose themselves as they map a process of catharsis; manipulations of fixed and immobile musical features usher in the purging of melancholia. When Death takes the Maiden for instance, Schubert simply closes with a recapitulated introduction, now in a consolatory D major key. When Mussorgsky's bass singer sings the final 'hush a bye', the chromatic descending motive at the moment of death (moving from F-F<sup>b</sup>-E<sup>b</sup>-D-D<sup>b</sup>) yields a perfect fourth (A<sup>b</sup>), thus ending on a 'brighter' note.

<sup>349</sup> Freud, *The Complete Works of Sigmund Freud* xiv, 244 - *Mourning And Melancholia*.

**Lento tranquillo** *rallentando*

lone!" "See him, he sleeps and no one can wake him, Hush-a-bye, ba-bay, my own."  
 ю! "Ви-дишь, Ус-нул он под ти-хо-е пе-нье. ба-юш-ки, ба-ю, ба-ю."

*p* *pp* *ppp*

FIGURE 5-29: CRADLE SONG FROM MUSSORGSKY'S *SONGS AND DANCES OF DEATH*

But no consolation is offered in Op. 74. The 'tonic' pedal and the slow march rhythm combine with chromaticism. Consolation comes only from the slackening of chromaticism as it stops burgeoning and returns to a state of rhythmic repose.

Skryabin's testimony supports a double reading of this chromatic line and tonic pedal as agents of both death and erotic seductive tension. Playing the piece to Boris de Schloezer, Skryabin set the psychological scene: "Listen to the simplicity, and yet how complicated psychologically". He went on to examine specific features: "[The descent is an] astral descent, mind you, and here is fatigue, exhaustion – the chromatic descending line. See how this short prelude sounds as if it lasts an entire century? Actually it is all eternity, millions of years..." – an ode to eternal recurrence. When discussing the piece with Sabaneyev, he played it twice, demonstrating that, "the same crystal can reflect many different lights and colours." Sabaneyev describes how the second time, the piece lost "every trace of caressing eros which once shadowed it." When mentioning this to Skryabin the composer whispered, "Yes... it is death now. It is death like the appearance of the Eternal Feminine which leads to the Final Unity. Death and Love. I call Death 'Sister' in my *Acte Préalable*, because there must be no trace of fear about it. It is the highest reconciliation, a white radiance..."<sup>350</sup>

Thus a dense saturation of chromatic lines fuels both erotic and the melancholic aspects of Death's appearance. Pieces such as *Dido's Lament* have helped to construct this interrelation of musical symbols. Purcell calls upon the *bass lament* (this Baroque figure itself unites motive ♀ and motive ♂), which embodies death, melancholia, and in this case, womanhood.

<sup>350</sup> Bowers, *Scriabin: A Biography 2*, 265.



FIGURE 5-30: THE 'GROUND' OF DIDO'S LAMENT

Melancholy is never intimated by Skryabin, and he would probably have disapproved of it; as he claimed, the seduction must occur 'without fear', and presumably without the sense of loss and trauma which melancholia involves.<sup>351</sup> Thus melancholy must have been an unfortunate by-product for Skryabin; he attempted to play within the symbolic fields of traditional musical signifiers that have deeply entrenched significations. It is difficult to depict a happy Death in music. The two things, whilst not mutually exclusive in poetry or philosophy, can become so in musical representation. Put crudely, once it sounds 'happy' it stops sounding like 'death'. For this one has to look to forms of music where an extra-musical dimension can bridge the gap – Wagner or Schubert would provide the most obvious examples.

### Masculinity – The 'Life Drive'

My analysis of Prelude, Op. 74 reflects the various facets of the Eternal Feminine: the seductress, the mother and the body of death. Whereas earlier pieces were suffused with militaristic masculine motives – trumpet calls that majestically overturned the submissive feminine voice of the voluptuous harmonies that tended to prevail – this piece admits no such conqueror. Rather, it seemingly grants full reign to the seductive descending chromatic voice of motive ♀. Skryabin's libretto opens up new paradoxes for this interpretation when Man is returned to life; he emerges from his dream realising that spring has awakened within him and he is charged to preach 'the word' to the masses. Although this new resolve for life at the behest of death is something of a Gordian knot, our job is not to untangle it, ignorant as we are of how Skryabin intended to embed the piece into the musical framework. However, this resolve to preach to the world discloses a marginalised masculine urge beneath the erstwhile hegemony of the feminine death drive, the affirmative drive being deployed to facilitate the self-replication of the destructive drive. Going beneath Skryabin's musical surface, the same structural necessity appears in three different guises.

Firstly, in Prelude Op. 74, no. 2, motive ♂ recedes from its leitmotivic prominence, paying purely perfunctory service to the prevailing motive ♀. In Sonata no. 4, the masculine creative voice rubbed shoulders with the feminine passive voice, allowing itself to be seduced and led towards ecstasy. Here,

<sup>351</sup> But melancholy is not necessarily the feeling of 'loss' with which we broadly associate grief. Links between melancholy and death are certainly forged by Kristeva, who views the melancholic as someone who gives way too much to the 'death-drive', and who, viewing the 'Symbolic Order' as a mere façade and failing to accept it fully, lives a kind of 'living death': "Eros has become detached from words, from language, from life. Melancholia is cold, on the side of the death drive and tendency towards complete passivity, mourning and sadness." John Lechte, *Julia Kristeva: Live Theory*, 83.

things are a little different. The upward leaps of motive ♂ provide new platforms for motive ♀ to fall from. A far cry from the ‘all guns blazing’ entries that motive ♂ had previously enjoyed, it is now stripped of all character, and is denied the dignity of direct motivic deployment, appearing only as a by-product of overlapping chromatic arches. Observe how the closing B $\flat$  pitch of the initial chromatic cell makes a leap of a fifth to the F $\sharp$  (E $\sharp$ ) of the subsequent cell. The primary note of the initial cell itself was a C (B $\sharp$ ) which figures in a broader ‘fifth leap’ (m. 4). These processes are represented in figure 5-31. These ‘leaps’, followed by their corresponding descents, create the illusion of the perpetual chromatic line.



FIGURE 5-31: MODEL OF OPENING OF PRELUDE, OP. 74, NO. 2

Secondly, masculine fourths support the chromatically interweaving lines in other ways too. When it enters, the melodic voice hovers above the chromatic cascade, erecting structural pillars by articulating fourths. The A in m. 5 lies above the E $\sharp$ /E/E $\flat$  cell, and moves to B $\sharp$  above the F $\sharp$ /E $\sharp$  descent, before revisiting the A above the E/E $\flat$ . These intervals then gradually decrease through minor thirds and semitones as the chromatic tendencies of the inner voices draw the contrapuntal lines together, just as the feminine lures the masculine.

Thirdly, the left-hand fifths (oscillating between C and F $\sharp$  in a Stravinskian fashion) construct the solid ‘masculine’ foundation of the pedal point. These fifths, estranged from modal distinction, become androgynous, their funereal insinuations over-riding their claims to masculinity.

So given the new subsidiary role of motive ♂, where can one locate masculinity? The piece is permeated by teleological drive towards its mid-point as the chromatic descent burgeons; the cascades become interrupted more frequently, causing interior repetitions of small segments. In this way Skryabin deploys a force of resistance to the perpetual descent. A climactic central point is positioned at a G $\sharp$  apex in m. 12. Further, a comparison of mm. 4-7 with mm. 8-14 finds the latter segment to be elongated through internal repetitions. Of course the Erotic and Thanatonic drives here serve each other dialectically. In presenting a force of erotic resistance, the intervallic upward skips (variants of motive ♂) negate the thanatonic chromatic descent (motive ♀), but actually add fuel to the fires of the descent, which becomes the newly mediated ‘negation of the negation’.<sup>352</sup> The meta-narrative of motive ♀ is a fall from a summit of G to a nadir of B $\flat$ . This was initially a concern of mm. 4-6, but becomes

<sup>352</sup> See Chapter 7 for more thorough discussion of negation as a dialectical category of desire.



telescoped into mm. 7-14, again forming a dialectical homewards return in the final measures where the introduction becomes a codetta.

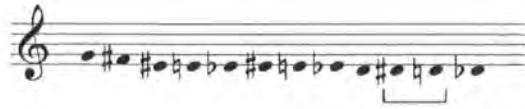

FIGURE 5-32: PRELUDE, OP. 74, NO. 2, MM. 4-7 (BRACKETS DENOTE REPETITION)



FIGURE 5-33: PRELUDE, OP. 74, NO. 2, MM. 8-14

One further point: whilst this chapter was intended to be parenthetical to our harmonic *drive analysis* – a synthetic project to be deferred until the next chapter – it would seem churlish to ignore the insights it can offer here. Despite the slippery nature of the chromatic layers which manipulate the harmonic drives as they flow through, the graph shows that, at their burgeoning point, nested discharges begin to spill over their container of minor third aggregate drives (C, F#, A). In mm. 8-11 a progression runs thus:  $G \rightarrow C \rightarrow F \rightarrow Bb$ , the latter two drives being so weak as to be scarcely more than *p*-discharges. The same progression is enshrined in mm. 12-13, though we must note that the  $Bb$  is now expressed as a single fifth interval.

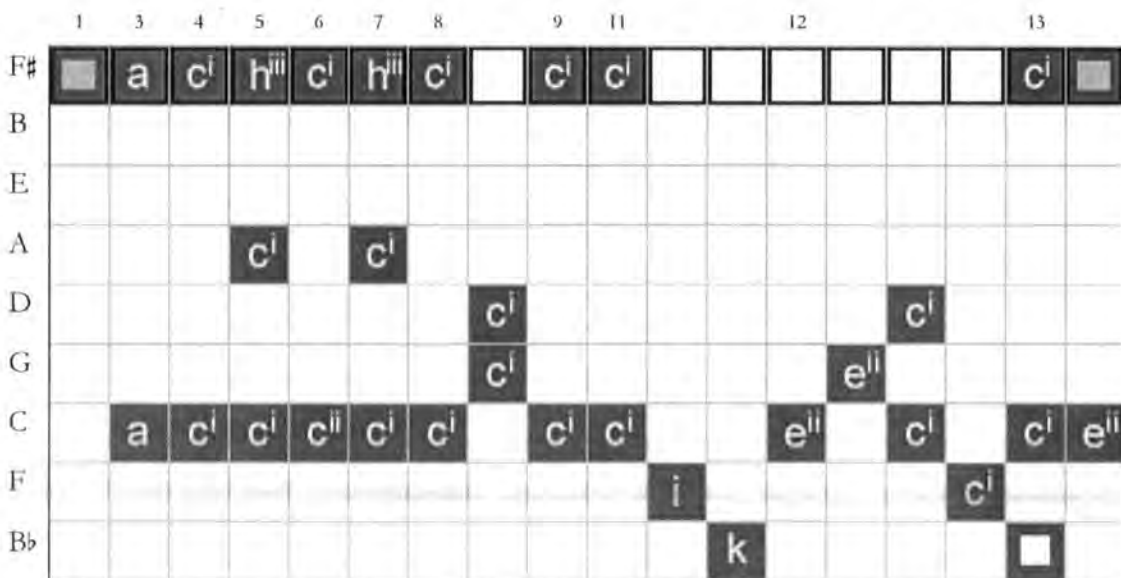

FIGURE 5-34: DRIVE ANALYSIS OF PRELUDE, OP. 74, NO. 2

And this is surely one of the greatest contradictions in Skryabin's aesthetic of the Prelude Op. 74, no. 2 – the slow march towards death and passivity would never work in an eschatological climax in any real form of the *Acte Préalable*. However beautiful the piece is, and despite Skryabin's claim it could last an eternity, it is certainly wearing upon the listener after consecutive hearings and could never sustain enough interest to act as an integral (and ultimate) feature of a big work. When Nemtin recreated Skryabin's *Acte Préalable* in his three movement work he quite reasonably allows the only vocal line in the piece – a soprano – to sing wordlessly, thus representing the maternal voice. But Alexander Nemtin used the music from this prelude to bring about a cumulative expanded climax to the work which leads towards a feeling of musical triumph and finality – a *masculine ending*.<sup>353</sup> While this certainly works musically to excellent effect, it would be incompatible with Skryabin's vision of an alluring *feminine ending*.

Why was it that Skryabin began to give way to these tendencies for pieces to fold back into themselves? His public rhetoric, clearly aligned him with the figure of the masculine, assertive, active, Promethean light-bringer; he dreamed of saving the world through his theurgic art; he wanted to “seize the world as [one would seize] a woman”; he saw himself as a Messiah and even mimicked Christ by preaching to fishermen from a boat.<sup>354</sup> Yet these works show a deeply maternal and feminine space for Skryabin. Having invoked theories from psychoanalysis, it would be a relatively simple matter to draw parallels with Skryabin's own life: his own dead mother, his archetypal absent father, his consequent upbringing from mollycoddling aunts and *babushki* (in which comparisons can be drawn with Skryabin's hero Wagner<sup>355</sup>), his effeminate appearance and flirtations with homosexuality (and the obligatory public over-protestation about his heterosexuality), his small stature and ‘Napoleon Complex’. But even ignoring these all-too-easy biographical explanations, this maternal space that Skryabin began to inhabit may have been invited by the realisations of his own failure to achieve states of ecstasy. As much as Skryabin is said to have digested Schopenhauer's ascetic philosophy and taken yogic exercises, the projected plans for the *Mysterium* loomed large, and these small miniatures were clearly intended to play a large part in the composition of this major work. But apart from a few oft-quoted twelve-tone chords that exist in sketches, Skryabin's late works remain distant from grandiose climaxes.

In this chapter I have drawn loosely on the melodic expectation-realisation analyses of Leonard Meyer, suffusing them with gender theory in the psychoanalytical tradition. In so doing I begin to draw disciplines together. The musical side of this synthesis is facilitated by a focus on melody in a relatively

<sup>353</sup> For a description of the role of the maternal voice, see Bottge, Karen, ‘Brahms' “Wiegenlied” and the Maternal voice’, *19<sup>th</sup> Century Music* 38/3 (2005), 185-213

<sup>354</sup> Bowers,  *Scriabin: A Biography* 2, 54.

<sup>355</sup> In *Mein Leben* Wagner refers to “the gentler imaginative impulses produced by my sisters”. Quoted in Nattiez, *Wagner Androgyne: A Study in Interpretation*, 185.

simplistic *leitmotiv* analysis, whilst the philosophical analysis pertains to simple, binary gender categories, familiar to New Musicology. This preliminary work is merely a stepping stone towards a synthesis of the foregoing harmonic drive theory, as adumbrated in chapters 1-4, with Skryabin's music and his complex philosophical world view. The remaining two chapters will embrace both melodic and harmonic 'drive theory' through analyses of two major works: *Vers La Flamme*, Op. 72 and *Poem of Ecstasy*, Op. 54. The former will be refracted through the prism of Skryabin's mystical thought, and comparisons will be invited between the esoteric writings of Blavatsky and the post-structuralist Kristeva. The final chapter continues this project through a Hegelian analysis of Skryabin's greatest programmatic work – his fourth symphony – *The Poem of Ecstasy*.

## Chapter Six

---

# Evolution of the Musical Subject: Panpsychism from Theosophy to Musical Form

“[Skryabin] had no interest in the mystery of cosmic beginnings”<sup>356</sup>

Boris de Schloezer

On this account, Skryabin’s philosophical mentor was quite simply wrong. Schloezer’s analysis of Skryabin’s philosophy is often as confused and self-contradictory as the source material he drew from.<sup>357</sup> He himself asserts that Skryabin conversationally espoused his “cosmogonic and anthropogenetic formulas”, which he “elaborated by analysis of his creative products” – his music.<sup>358</sup> That Skryabin was interested in the awakening of human consciousness is also certain. Schloezer details Skryabin’s formula:

Period preceding the awakening of consciousness. Period of Conscious life. Period of postconsciousness, which coalesces with the period before the awakening of consciousness<sup>359</sup>

How do these two enthusiasms – cosmogenesis and psychological awakening – correlate? Skryabin encountered *Panpsychism* at the *International Congress of Philosophy* in Geneva in 1904 at a lecture given by a Professor from Columbia University. In this doctrine the universe is equated to a conscious mind, leading Skryabin to such pronouncements as “Cosmic history is the awakening of consciousness, its gradual illumination, its continual evolution.”<sup>360</sup> Another impetus was Theosophy, which Skryabin encountered around 1905. His visit to Belgium brought him into contact with Jean Delville, a Theosophist painter who had just finished writing an essay entitled *The Mystery of Evolution*. Delville showed Skryabin Helena Petrovna Blavatsky’s *Secret Doctrine* and instructed him to “set it to music”;<sup>361</sup> Skryabin immediately joined the Belgian Theosophical Society and, although his musical conception was certainly not as directly programmatic as all that, *The Secret Doctrine* was to become Skryabin’s ‘bible’,<sup>362</sup> and the creation of music was to become a theurgic act.<sup>363</sup> As Cousins puts it, “his music rapidly gave voice to this vast expansion of consciousness.”<sup>364</sup>

---

<sup>356</sup> Schloezer, *Scriabin: Artist and Mystic*, 194.

<sup>357</sup> Boris de Schloezer offers detailed accounts of Skryabin’s philosophical universe, based on his intimate friendship. Indeed, through Skryabin’s ‘common law’ wife Tatiana de Schloezer, Skryabin regarded him as a brother-in-law.

<sup>358</sup> Schloezer, *Scriabin: Artist and Mystic*, 205.

<sup>359</sup> *Ibid.*

<sup>360</sup> *Ibid.*, 231.

<sup>361</sup> James Henry Cousins, *Two Great Theosophist-Painters, Jean Delville, Nicholas Roerich* (Madras: Theosophical Publishing House, 1925), 8.

<sup>362</sup> Leonid Sabaneeff, ‘A. N. Scriabin - a Memoir’, *Russian Review* 25/3 (1966), 263.

<sup>363</sup> Maria Carlson, *“No Religion Higher Than Truth”: A History of the Theosophical Movement in Russia, 1875-1922* (Princeton, N.J.: Princeton University Press, 1993), 159.

<sup>364</sup> Cousins, Delville and Rerikh, *Two Great Theosophist-Painters, Jean Delville, Nicholas Roerich*, 9.

Madam Blavatsky's *Secret Doctrine* fully enshrines the type of microcosm / macrocosm doctrine that Panpsychism stands for, Blavatsky's catchphrase being "so above, so below". As de Schloezer reminds us: "Skryabin sought to justify his theories by arguing that the evolution of the universe is coextensive with the evolution of consciousness ... he realized the macrocosm in the microcosm and realized that the truth could be revealed only in subjective psychological terms."<sup>365</sup>

As various quotations from Skryabin underscore, these two discourses – the cosmos and the psyche – refract the modernist concept of 'evolution': "The universal consciousness in a state of activity appears as a personality, one enormous organism which at any moment experiences a new stage of process called evolution."<sup>366</sup> Skryabin went further than evolution and accepted the less familiar theosophical doctrine of 'involution'. This may have been a crosscurrent from Delville who saw 'material' as "the lowest form of involution."<sup>367</sup> Schloezer claims that Skryabin modified this doctrine to conform to his prophesy that the world would contract and 'replay' the process of evolution in reverse, within only seconds of 'ecstatic time', during the performance of his *Mysterium*.<sup>368</sup>

Sabaneyev's accounts reveal that this idea of 'involution' permeated all of Skryabin's views and opinions. A rather startling passage, hitherto not translated into English, shows that even Skryabin's rather anti-Semitic views were passed through this involutory filter.

He had a very precise notion of the mission of the Jews. It was the materialisation of a "feminine principle" in the organism of humanity. "The Jews are all sensuality. They don't have and can't have any genuine mysticism" he said, "to them, the material is all that exists: material wealth, material, sensual, physiological ecstasy. Their role is to maintain and develop this aspect of humanity. And now, in the process of involution, their role must inevitably be very great. In this there is nothing strange or bad. But when evolution recommences, a process of dematerialisation will begin; then their function will come to an end."<sup>369</sup>

Despite the rather unfortunate racial characterisation, which reads like the writings of Otto Weininger, Skryabin's statement at least shows that such evolutionary talk, and particularly his attempt to genderise

---

<sup>365</sup> Schloezer, *Scriabin: Artist and Mystic*, 203.

<sup>366</sup> Bowers, *Scriabin: A Biography 2*, 104.

<sup>367</sup> Jean Delville and Francis Colmer, *The New Mission of Art, a Study of Idealism in Art* (London: F. Griffiths, 1910), 170.

<sup>368</sup> Skryabin's 'difficulty' in synthesising his egocentric apocalyptic ideas with Blavatsky's more established theosophic systems of 'cycles and races' is described by Schloezer, *Scriabin: Artist and Mystic*, 213-215.

<sup>369</sup> «Миссия евреев у него была строго определена – это было материализующее «женственное начало» в организме человечества. - Евреи – все в чувственности. Мистики настоящей у них нет и быть не может, - говорил он. – Для них все существенное – материальное: материальные блага, материальный чувственный, физиологический экстаз. Их роль – поддержать и развить эту сторону в человечестве. И сейчас в процессе инволюции их роль неминуемо должна быть очень велика – в этом нет ничего странного и плохого. А вот когда начнется эволюция, когда процесс будет направлен к дематериализации – тогда их роль уже окончится...» Sabaneyev, *Vospominaniya O Skryabine*, 281.

it ('feminine principle') informed his universal attitudes.<sup>370</sup> Naturally, evolution also followed a rather erotic bent for Skryabin:

And so it is with God-personality in the process of evolution. It accepts precisely the stage of evolution it experiences in a certain moment and does not feel all the points in its organism, that is, the universe. When it reaches the limits of its heights, the time draws near when it will communicate its bliss to all its organism. Like a man during the sexual act – at the moment of ecstasy he loses consciousness and his whole organism experiences bliss at each of its points. Similarly, God-Man when he experiences ecstasy, fills the universe with bliss and ignites a fire.<sup>371</sup>

And natural too was the integration of evolution into his accounts of his music:

“The modulatory scheme is also precisely planned in *Prometheus*”, added Alexander Nikolayevich – “There is a constant progression from *spiritual* keys – which symbolise the primary, spiritual, undifferentiated being and the state preceding the act of creation – towards *material* keys, which represent the impress of spirit onto matter. Thus, my score begins in F# major – which is a dark blue, the colour of intellect – full of spirituality. And all this leads to the most material colour – red, which occurs during the F-major episode in the development. And evolution then begins anew; the tonalities once again reach the spiritual realms and everything finishes in F#.”<sup>372</sup>

This chapter seeks to explore the structure of one of Skryabin's larger works, running it alongside his psychological interest in evolution. Before examining the music by these lights, my preliminary task is to investigate instances of cosmogenetic and psychological 'evolution' in the philosophical sources that Skryabin mused upon. Blavatsky's *Secret Doctrine* brings the formation of a psychological cosmos into the spotlight. One of the most firmly rooted paradoxes in Blavatsky's writing is that she characterises evolution as a *maternal* phenomenon – Skryabin's “feminine principle” – whilst, confusingly, she also declares it to be *paternal*. Symptomatic of her wholesale synthesis of religious and scientific disciplines, this problem resurfaces time and time again. Given Blavatsky's strong influence, it is easy to understand Skryabin's inheritance of such contradictions. But with one crucial tactic, Skryabin solves this Blavatskian riddle in both his philosophy and his music, in a way that only really comes to light almost a century later through the eclectic discipline of semiotics. Given that evolutionary narratives enter the three fields of anthropology, philosophy and psychology – all three topics studied by Skryabin

---

<sup>370</sup> Otto Weininger, greatly influential to Zemlinsky and Schoenberg, was noted for his anti-semitic and misogynistic views. Like Skryabin, he combined these with gender theory and music. Weininger's work was imported into Russian by Skryabin's friend, the critic Berdyayev. Weininger, *Sex & Character*; N Berdyayev, 'Regarding a Certain Remarkable Book (O. Weininger: Sex and Character)', *Voprosy filosofii i psikhologii*/98 (1909), [www.berdyayev.com/berdiaev/berd\\_lib/1909\\_157\\_4.html](http://www.berdyayev.com/berdiaev/berd_lib/1909_157_4.html).

<sup>371</sup> Bowers, *Scriabin: A Biography* 2, 105.

<sup>372</sup> У меня в «Прометее» тоже модуляционный план совершенно определенный, – добавил Александр Николаевич. – У меня там ход все время от тональностей *духовных*, которые соответствуют первичному духовному неразделенному бытию, состоянию дотворческой неразделенности, к тональностям материальным, которые соответствуют отпечатлению духа на материи. Вот у меня так начинается с *Fis* – это *синий* цвет, цвет разума, полной духовности. И все это идет к самому материальному цвету – красному, к *F dur* – это как раз эпизод разработки. А потом опять начинается эволюция ... и тональности опять приходят к духовным, и все коичается в *Fis*. *Sabaneyev, Vospominaniya O Skryabine*, 123.

– the synthetic modern discipline of semiotics offers a clearer perspective. Of course, I am also mindful that the dichotomy of drive and desire also figures in Blavatsky's cosmogony; she adopts the terms *Kāma-Rūpa* – a vehicle of desire – and *Suchi*, referring to 'animal instincts' or the 'fire of passion'.<sup>373</sup>

## Philosophy: Blavatsky's Conundrum and 20<sup>th</sup> Century Gender Politics

Blavatsky contrasted the Buddhist view on creation to the Christian. The former holds that a mundane state of womb-like femininity developed (or evolved) of its own volition; the latter believes that a masculine creator-God coerced it, fashioning it in his own image. Of course, in the more academic philosophical arena, this resonates with the popular empiricism *vs.* rationalism argument. Central to empiricism was Hume's adoption of Locke's *tabula rasa* – the blank slate on which experience becomes imprinted. Synthesising this with *rationalism*, Kant's 'Copernican turn' bridged the gap between receptive mental structures and the data they collect. Whilst Skryabin was certainly *au fait* with Kant's work, recommending it to his pupils, there is no evidence of him tackling Hume's writings. The contradiction may simply be lifted wholesale from Blavatsky. Blavatsky dogmatically declares, "The Universe is *guided from within outwards* ... We see that every external motion, act, gesture, whether voluntary or mechanical, organic or metal, is produced or proceeded by an internal feeling or emotion, will or volition and thought or mind".<sup>374</sup> Skryabin, in his own way, adopted this same stance, claiming, "the universe is an inner-creative process (related to the creative beginning) ... the creative beginning is the will to live."<sup>375</sup> His poetic notebooks also contain this telling stanza:

All creating-urge,  
from the center eternally from the center  
to freedom  
to knowledge<sup>376</sup>

In light of esoteric imagery, Blavatsky further underscores this 'feminine beginning' via an exploration of the 'Mundane Egg' in which she claims that:

the gradual development of the imperceptible germ within the closed shell; the inward working, without any apparent outward interference of force, which from a latent nothing produced an active something, needing nought save heat; and which, having gradually evolved into a concrete, living creature, broke its shell, appearing to the outward senses of all a self-generated, and self-created being – must have been a standing miracle from the beginning.<sup>377</sup>

<sup>373</sup> Geoffrey A. Barborka, *The Story of Human Evolution* (Madras, India: Theosophical Publishing House, 1980), 16.

<sup>374</sup> Blavatsky, *The Secret Doctrine: The Synthesis of Science, Religion and Philosophy*, 274.

<sup>375</sup> Bowers, *Scriabin: A Biography 2*, 102.

<sup>376</sup> *Ibid.*, 100.

<sup>377</sup> Blavatsky, *The Secret Doctrine: The Synthesis of Science, Religion and Philosophy*, 359.

This egg allies with 'the feminine' when Blavatsky equates it with the great symbol of the circle, representing the maternal womb. In much of the *Secret Doctrine*, this maternal (*from within to without*) capacity is maintained, though weakened in one critical sense:

The Mother is the fiery fish of life. She scatters her spawn and the Breath (Motion) heats and quickens it... Motion becomes whirlwind and sets them into motion.<sup>378</sup>

Symbols of womanhood are now coaxed from outside; in this case, heat or breath. This outside affect upon the inside foreshadows Freud's *Identification* and Lacan's *Mirror Stage*. A newborn child becomes aware of the paternal existence (Lacan's *Big Other*), *identifies* with it and *becomes* it. Elsewhere Blavatsky asserts, "The old Initiates knew of no 'miraculous creation', but taught the evolution of atoms (on our physical plane), and their first differentiation from *laya* into *protyle*."<sup>379</sup> This process of 'differentiation' is the contentious issue, the question being whether this acceptance of 'otherness' – call it Freud's *identification* or Lacan's *mirror stage* – is paternal or maternal.<sup>380</sup> Skryabin's own writings betray a deep concern for the processes of differentiation and identification with external images in his evolutionary schemes. This particularly poetically charged paragraph is found among his notebooks, and traces the formulation of the cosmos through to 'differentiation':

Something began to pulsate and this something was one. I do not differentiate multiplicity. It trembled and glimmered, but it was one. This one was all with nothing in opposition to it. It was everything. I am everything. It had the possibility of anything, and it was not yet chaos (the threshold of consciousness). All history and the future are eternally in it. All elements are mixed, but all that can be is there. It exudes colours, feelings and dreams. I wish [desire]. I create. I differentiate.<sup>381</sup>

Skryabin equated differentiation with knowledge: "All this I know. I *differentiate* it."<sup>382</sup> He also held to the process of *identification*:

Knowing myself means identifying with the known. I know the world as a set of states of my consciousness and outside this sphere I cannot exist. I want to know the truth. This is the central figuration within my consciousness. Of this I am convinced. I identify with this conviction.<sup>383</sup>

---

<sup>378</sup> Ibid., 97.

<sup>379</sup> *Laya*, a Sanskrit word, refers to a state of mental quietude, dissolution, rest, repose and inactivity. *Protyle* is a theoretical (imaginary) substance from which chemicals were supposedly formed.

<sup>380</sup> The Freudian category of *Identification* – when a child becomes aware of other people and realises that it is itself a similar being – is developed by Lacan to involve what he calls the *Mirror Stage* – the moment when a child begins to see itself as a subject and enters the laws of the Symbolic Order or the Big Other. These are both paternal paradigms; as Lacan says: "It is in the name of the father that we must recognize the support of the symbolic function which, from the dawn of history, has identified his person with the figure of the Law." Jacques Lacan, *Écrits: A Selection* (London: Tavistock Publications, 1977), 74.

<sup>381</sup> Bowers, *Scriabin: A Biography* 2, 60.

<sup>382</sup> Ibid., 57.

<sup>383</sup> Ibid., 104.



Aligning oneself to the knowledge of the outside world is Freud's exact paradigm, and this forms the subject in its individuality. As Skryabin says, "your relation with the outside world ... is all that marks your individuality"<sup>384</sup> And this is the central issue that Blavatsky tackles in vain, foreshadowing the gender politics of psychoanalysis. Lacan continues Freud's phallogocentric language by asserting an identification model, whereas Kristeva, revered by the Feminist movement, looks at child development from the maternal point of view.

## Mother or Father?

Perhaps Blavatsky's most lucid account of a feminine creation model is found in the opening of the *Secret Doctrine*, where she unearths archaic siglia. Standing proudly in the opening of Blavatsky's magnum opus, Skryabin would certainly have happened upon them.



FIGURE 6-1: BLAVATSKY'S ANALYSIS OF ARCHAIC SYMBOLS

The first evolutionary symbol is the plain disc, representing perfect passivity and nothingness. In the second, taken from the Kabbalah,<sup>385</sup> a 'point' marks the centre of the disc, representing the "first differentiation in the periodical manifestations of ever-eternal nature, sexless and infinite ... potential space within abstract space."<sup>386</sup> In the third, a line symbolizes a "divine immaculate Mother-Nature within the all-embracing absolute Infinitude".<sup>387</sup> This represents the first manifestation of creative nature – "still passive because feminine." She describes how "the first shadowy perception of man connected with procreation is feminine, because man knows his mother more than his father." She justifies this by claiming that female deities are more sacred than male. Thus "Nature is therefore feminine, and, to a degree, objective and tangible, and the spirit principle which fructifies it is concealed."<sup>388</sup> In the fourth symbol, the vertical line penetrates the horizontal line; this is the 'mundane cross', a symbol that human life was about to begin. The outer circle disappears in the fifth symbol, signifying the fall of 'spirit into matter', which Blavatsky describes as purely 'phallic'. Likening it to another symbol of the Tau – 'Thor's hammer' ( $\oplus$ ) – she describes space as 'Mother' before cosmic activity, and 'Father-Mother' after life has been awakened. In short: the feminine aspect guides evolution.

<sup>384</sup> Ibid., 102.

<sup>385</sup> Blavatsky, *The Secret Doctrine: The Synthesis of Science, Religion and Philosophy*, 19.

<sup>386</sup> Ibid., 4.

<sup>387</sup> Ibid.

<sup>388</sup> Ibid., 5.

Blavatsky's translations of the *Book of Dyzan* (the basis of the *Secret Doctrine*) also treat birth and evolution as feminine processes. It opens with a description of "the eternal parent wrapped in her invisible robes" who "lay asleep in the eternal bosom of duration".<sup>389</sup> Again the maternal body envelops space – "The mother swells, expanding from within without, like the bud of the lotus".<sup>390</sup> For Blavatsky, this represents a purely unconscious state before the ego has been formulated; we are told that it consists of "naught save ceaseless eternal breath, which knows itself not."<sup>391</sup> This unconscious state is certainly commensurate with Skryabin's ideas; he declares dogmatically, "The universe is an unconscious process."<sup>392</sup> But Blavatsky feels the uneasiness of this image; images of Lacanian, paternal *otherness* consistently penetrate the discourse in the guise of 'the ray'.

'The ray' finds a place in Blavatsky's writings as a distinct paternal father figure who invests the world with heat and, more significantly, light. We will see, during the following musical analysis, that this was also one of Skryabin's favourite symbols. In mystical symbolism, the roles of Prometheus and Lucifer are salient images, common to Blavatsky and Anne Besant's Theosophy as well as Rudolf Steiner's Anthroposophy. But although Blavatsky wrote many articles for her own Theosophical Journal *Lucifer*, *The Secret Doctrine* reveals deeper interest in the character of *Fohat* who represents light and heat, and who Blavatsky describes as "the dividing, differentiating, and individualising power."<sup>393</sup> When she describes light, apparently with no connection to *Fohat per se*, this 'other' masculine image is still implicit. She claims, for example, "It is the sun-fluids or emanations that impart all motion and awaken all to life, in the Solar System."<sup>394</sup> But in other ways too, Blavatsky betrays a concern with a masculine, designing 'other': "The whole order of nature evinces a progressive march towards a higher life. There is design in the action of the seemingly blindest forces. The whole process of evolution with its endless adaptations is a proof of this."<sup>395</sup> She then suggests that this is evidenced by the 'survival of the fittest', but suggests, "What is called 'unconscious nature' is in reality an aggregate of forces manipulated by semi-intelligent beings (Elementals) guided by High Planetary Spirits, (Dhyan Chohans), whose collective aggregate forms the manifested verbum of the manifested LOGOS, and constitutes at one and the same time the MIND of the Universe and its immutable law."<sup>396</sup> This mind, associated with intelligence and also light – *Fohat* – holds the function of animating matter and investing it with language. Blavatsky, quoting Aristotle's *Physica*, discusses how "world stuff", in the form of *nebulae*, remains "motionless and unorganised" until "the Mind" begins to work on it and communicates

<sup>389</sup> Ibid., 27.

<sup>390</sup> Ibid., 28.

<sup>391</sup> Ibid.

<sup>392</sup> Bowers, *Scriabin: A Biography 2*, 104.

<sup>393</sup> Blavatsky, *The Secret Doctrine: The Synthesis of Science, Religion and Philosophy*, 284.

<sup>394</sup> Ibid., 529.

<sup>395</sup> Ibid., 277.

<sup>396</sup> Ibid., 278.

motion and order.<sup>397</sup> Thus mind and intelligence act as outside (Other) factors which attract evolving subjects. Blavatsky specifically suggests that the subject needs “a spiritual model or prototype, for that material to shape itself into... an intelligent consciousness to guide its evolution and progress, neither of which is possessed by the homogenous monad, or by senseless though living matter.”<sup>398</sup> What is this, other than Freud’s process of *Identification*? Evolution for Blavatsky now seems to be a masculine enterprise, however much she asserted the opposite.

## A Dialectical Interchange

But this masculine element works dialectically with the feminine. She quotes extensively from a particular “Occult catechism”:

[The One] expands and contracts (exhalation and inhalation). When it expands the mother diffuses and scatters; when it contracts, the mother draws back and ingathers. This produces periods of Evolution and Dissolution, Manvantara and Pralaya ... Hot Breath is the Father who devours the progeny of the many-faced Element (heterogeneous); and leaves the single-faced ones (homogenous). Cool Breath is the Mother, who conceives, forms, brings forth, and receives them back to her bosom, to reform them at the Dawn (of the Day of Brahma, or Manvantara).<sup>399</sup>

Thus the subject is a dialectical product of its parents. *The Book of Dyzan* describes how the Father-Mother spins a web whose upper end (associated with light) is fastened to spirit, and whose lower end (“shadowy”) is fastened to matter. This web supposedly expands when the fiery breath of the father touches it, but contracts with the cool breath of the mother.<sup>400</sup> Julia Kristeva, more than any of her contemporaries or predecessors in the field of linguistics, concentrates on the ‘motility’ between the ‘masculine’ *symbolic* world and the ‘feminine’ *semiotic* world. Freud saw the unconscious as something that was generally repressed to make space for the conscious, and Lacan saw the ‘Symbolic Order’ as a ‘one way passage’ – the Imaginary was a replacement of the Real.<sup>401</sup> Kristeva, by contrast, believed that any act of communication occurred dialectically between the semiotic and symbolic, and even in the maternal *chora*, innate drives appeared in flux. This flux – the ebb and flow between states – was also the subject of Blavatsky’s explorations:

---

<sup>397</sup> Ibid., 595.

<sup>398</sup> Ibid., 247.

<sup>399</sup> Ibid., 12.

<sup>400</sup> Ibid., 30.

<sup>401</sup> To Lacan ‘the Real’ is literally the reality of materiality epitomised by the pure ‘need’ → ‘satisfaction’ existence of babies, an unmemorable feature of our lives, which gives way to the Imaginary, a position in which there is no definite feeling of ‘self’, merely a response to objects and identification with them – pure subjectivity. This realm is characterised by Lacan as ‘demand’ rather than ‘need’. This occurs before the Symbolic Order is fully accepted. It “precedes the Symbolic Order, which introduces the subject to language and Oedipal triangulation, but continues to coexist with it afterward. The two registers complement each other, the symbolic establishing the differences which are such and essential part of cultural existence, and the imaginary making it possible to discover correspondences and homologies.” (Kaja Silverman, *The Subject of Semiotics*, New York: Oxford University Press, 1983, 157).

The assertion of the Secret Doctrine is the absolute universality of that law of periodicity, of flux and reflux, ebb and flow, which physical science has observed and recorded in all departments of nature. An alternation such as that of Day and Night, Life and Death, Sleeping and Waking, is a fact so common, so perfectly universal and without exception, that it is easy to comprehend that in it we see one of the absolutely fundamental laws of the universe.<sup>402</sup>

This 'motility' between the two regions also enters Skryabin's world history in a rather confused passage:

An impulse disturbs celestial harmony. This creates the substance on which divine idea is printed. For an instant the balance with lower degrees is restored. Then by a new impulse again, it is disturbed, etc., until the whole reservoir of powers finds its outlet in the activity of *all manvantaras*.<sup>403</sup>

These impulses create a rupture in the homeostatic (harmonic) condition, which is subsequently balanced, pending further ruptures.

Although Blavatsky, by so rigorously applying different systems of thought, allowed herself to become confused by the maternal / paternal dichotomy, Theosophists generally took the maternal 'inner to outer' idea dogmatically to heart. As Harry Benjamin says, "Whereas to the Darwinian the emphasis in evolution lies essentially on the effect of external forces and conditions upon the evolving types, from the Eastern point of view the evolutionary emphasis is laid directly upon the inner spiritual life of the evolving entity."<sup>404</sup> "Thus, evolution begins to take on meaning and purpose when viewed from the "inside" (as we are now looking at it) instead of from the "outside" (as the Darwinist views it)."<sup>405</sup>

## Father of Individual Prehistory

How does the foregoing analysis correlate with Skryabin's views? It would seem that the work of Madame Blavatsky unveils problems that were mirrored throughout the following century in linguistic semiotics, tackled by Julia Kristeva in the 1980s. Crucially, Kristeva produced a system based around Freud's 'Father of Individual Prehistory', which situated the image of the Father (or Other) within the mind of the infant, without necessarily having an 'outside' or real image to engage with *per se*.<sup>406</sup> This is where Skryabin becomes clearer than Blavatsky, mediating in a way that pre-shadows Kristeva. He claimed, "My consciousness can exist only in relation to other consciousnesses, not only with actually existing consciousnesses, but with all potential consciousnesses that are present in each psyche *as a possibility* [my emphasis], as an unconscious process taking place beyond the horizon of consciousness.

<sup>402</sup> Blavatsky, *The Secret Doctrine: The Synthesis of Science, Religion and Philosophy*, 17.

<sup>403</sup> Bowers, *Scriabin: A Biography* 2, 62. Manvantara is a cycle evolution, followed by a state of universal repose.

<sup>404</sup> Harry Benjamin, *Everyone's Guide to Theosophy: A Simple Explanation of the Theosophical Teachings for the New Student* (London: Theosophical Publishing, 1969), 74.

<sup>405</sup> *Ibid.*, 96.

<sup>406</sup> According to Kristeva the child develops or constructs its own Other, receiving qualities from both parents before actually realising its otherness fully from them. Thus it constructs an Imaginary Father before separating fully with the mother, independently of any Real father. Julia Kristeva, *Freud and Love: treatment and its Discontents*, 1986.

In this sense, each person contains the entire universe as a process lying outside his consciousness.”<sup>407</sup> Thus, for Skryabin, consciousness is not necessarily awakened by actual identification with an Other person, but by the psyche itself, through community with imaginary Others. Skryabin espouses this same concept in familiar Fichtean, dialectical terms – “I desire to create. By this desire I produce a multiplicity, comprising a multiplicity in a multiplicity, and a singularity in a multiplicity: “non-I” and “I”. “Non-I” is necessary so that “I” can create within “I”.<sup>408</sup> He further indicates that the other abides in the self:

Every state of consciousness is a relationship to another state of consciousness. This means that its appearance is the negation of all else. In this negation I relate to the other, that is, unconsciously I struggle with the unconscious form of the other abiding in me. . .

And thus, these outside relations are formulated ‘from within’:

I am actively defining my relations with the outside so as to make my world. Generally speaking I am God.<sup>409</sup>

This idea was circulating among the Russian artists; see Bryusov’s claim:

The ‘Ego’ is self-sufficient, a creative force which derives its whole future from within itself.<sup>410</sup>

For Skryabin it became a doctrine that must be preached to the world: “You do not understand that each of you creates the other and you exist only together.”<sup>411</sup>

## Music

Regardless of our acceptance of Kristeva’s theory – that the paternal ‘other’ is embryonically located in a maternal ‘semiotic’ passage towards the masculine ‘symbolic’ realm – it is certainly a concept pertinent to one of Skryabin’s most unusual pieces – *Vers la Flamme*, Op. 72. Although the piece is certainly not a sonata, and was only briefly thought of as such by Skryabin, it is comparable in form, structure and certainly magnitude. Likewise, *The Poem of Ecstasy* and *Prometheus: Poem of Fire* are often described as Symphonies 4 and 5. Hull claims of the sonatas that, “we find a fixed evolutionary course in which Skryabin explains the cosmos.”<sup>412</sup> To this corpus of works, Hull adjoins the two “loose pieces” – *Poeme Nocturne*, Op. 61 and *Vers la Flamme*, Op. 72. In Skryabin’s other major works there is a clear sonata-like contrast of themes and, as shown in the previous chapter, one can easily discern narrative programs that posit some musical events as masculine and others as feminine. Such narratives

<sup>407</sup> Schloezer, *Scriabin: Artist and Mystic*, 294.

<sup>408</sup> *Ibid.*, 198.

<sup>409</sup> Bowers, *Scriabin: A Biography* 2, 101.

<sup>410</sup> West, *Russian Symbolism: A Study of Vyacheslav Ivanov and the Russian Symbolist Aesthetic*, 125.

<sup>411</sup> Bowers, *Scriabin: A Biography* 2, 100.

<sup>412</sup>A. Eaglefield Hull, *Scriabin: A Great Russian Tone-Poet* (Kegan Paul, Trench, Trubner & Co., Ltd., 1918), 207.

progress dialectically throughout the piece, establishing various relationships and encounters.<sup>413</sup> Often pieces evolve from miniscule beginnings before our eyes (or ears); this developing music is usually offset by thematic ‘objects’ – themes that appear as already-constructed subjects. Whether a flowing melody or a triadic ‘trumpet call’, these shape the evolving subject.

The Fifth Sonata presents a special case of this, where a seemingly ‘outer’ phrase frames the ‘inner’ evolving subject of the work, flanking the piece with the external image of identification. Curiously enough, Skryabin claimed to have composed this piece under some kind of mystical instruction, seeing the whole composition as an instantaneous mental image which he translated onto the temporal plane.<sup>414</sup> Schloezer calls the work “a sound body unveiling”.<sup>415</sup> Prefaced by an indication of this exterior ‘summons to life’, which Jason Stell dubs “a vague rumbling of the origins of life, buried in nebulous ooze”, the sonata begins abruptly:

I summon you to life, secret yearnings!  
You who have been drowned in the dark depths  
Of the creative spirit, you timorous  
Embryos of life, it is to you that I bring daring<sup>416</sup>

Its bombastic opening (see figure 3-4) is immediately succeeded by harmonically undifferentiated whole-tone drive material (briefly explored in Chapter 3). After a brief caesura between the two worlds in m. 12, the *Languido* begins with a gentle whole-tone sonority. This material develops throughout the piece, crucially evolving into a presentation of the introduction at the very mid-point of the work. The illusion is therefore created that the introduction is somehow acting as an image of identification, a mould for the organic music to shape itself into. This whole concept of Skryabin calling beings into creation was instrumental to the *Poem of Ecstasy* and the *Mysterium*, but even at this early stage, his notebooks read:

You have heard my secret call, hidden power of life, and you begin to stir. The billow of my being, light as a vision of dreams, embraces the world. To life! Burgeon! I awaken you to life with kisses and the secret pleasures of my promise. I summon you to life, hidden longings, lost in the chaos of sensations. Rise up from the secret depths of the creative soul.<sup>417</sup>

---

<sup>413</sup> Susie Garcia has attempted this in her thesis, *Alexander Skryabin and Russian Symbolism: Plot and Symbols in the Late Piano Sonatas*, University of Texas, DMA Dissertation, 2000.

<sup>414</sup> Reading his detailed descriptions of the compositional process, one cannot help but remember Stravinsky composing his *Rite of Spring* five years later, claiming that he was the vessel through which *Le Sacre* passed (Neil Wenborn, *Stravinsky* (London: Omnibus Press, 1999), 60). Skryabin himself claimed at one stage, “I am the vessel” (Bowers, *The New Scriabin: Enigma and Answers*, 100). This is commensurate with Ivanov’s theory of art: “The artist is called not to impose his will on the external form of things, but to reveal the will that resides in them.” (West, *Russian Symbolism: A Study of Vyacheslav Ivanov and the Russian Symbolist Aesthetic*, 51).

<sup>415</sup> Schloezer, *Scriabin: Artist and Mystic*, 85.

<sup>416</sup> Jason Stell finds *Fohat* here, ‘Music as Metaphysics: Structure and Meaning in Skryabin’s Fifth Piano Sonata’, 14.

<sup>417</sup> Bowers, *Scriabin: A Biography 2*, 59.

The opening twelve measures of the sonata, marked *con stravaganza*, clearly constitute an *exordium* of a particularly unusual type for Skryabin. In performance it rarely lasts for more than 5 seconds, taking listeners entirely by surprise. My classification of this *con stravaganza* section as Other to the interior organic growth of the sonata is built on firmer foundations than those of early musicologists such as Hull, whose florid analysis runs thus: “An introduction of 12 bars rolls back fold by fold, as it were, the curtain of gloom which enwraps the mystery. But we are only yet in the outer region.”<sup>418</sup> This curtain stands as ‘outer’ for harmonic reasons that are clarified by *drive analysis*. The opening twelve measures have never elicited satisfactory analytical responses; those of Cook and Baker, are perhaps the most popular, but are inadequate for my purposes.<sup>419</sup> *Drive analysis* finds two solid tonic triads on E and A with a standard  $\ell$ -DRIVE on B. This conglomerate of drives, ordered in fifths, synthesises the three primary triads (and functions) in their ‘authentic’ (i.e. compliant with the major scale from which they are derived) positions – E major (*T*) A major (*S*) and a B<sup>7</sup> chord (*D*): thus the ‘con stravaganza’, which rapidly uncoils its wound-up energy, condenses the full major scale from a couchant into a rampant form – a purely vertical “instantaneous mental image”. This contrasts the ‘body’ of the piece where drives flower and develop, orbiting their objects in a typically Skryabinesque fashion.

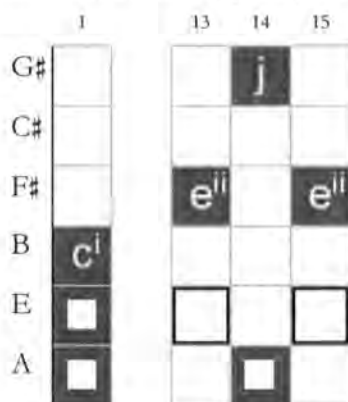

FIGURE 6-2: SONATA NO. 5, MM.1-15

<sup>418</sup> Hull, *Scriabin: A Great Russian Tone-Poet*, 138.

<sup>419</sup> Nicholas Cook, *A Guide to Musical Analysis* (London: Dent, 1987), 215-218; Baker, *The Music of Alexander Scriabin* 175. Nicholas Cook provides an analysis of this opening which remains within the confines of ‘tonal’ analysis, situating it firmly within the key of D# minor. Although this agrees with the key signature of the sonata, this interpretation is also quite deficient: three notes of Skryabin’s harmonic cell do not fit this paradigm. The D# minor scale (D# E# F# G# A# B C# D#) does not allow for either an E natural, a C# or an A#, nor can they be assimilated into the structure as ‘appoggiaturas’ or ‘chromatic passing notes’. James Baker gives a more effective tonal interpretation, situating the piece within the ‘scale’ (he cautiously avoids the word ‘key’) of E major. This indeed caters for the entire pitch content of the section, but does not fix the material within a particularly tonal context; the E for example is heard only as a trill, and only above a persistent D#. Hugh Macdonald states that “The harmony of this first bar is not a random dissonance, as might be supposed; it is the superimposition of a tritone and a fifth used constantly in the later music in the low register as an exclusive left-hand formation.” (Hugh Macdonald, *Scriabin* (London: Oxford University Press, 1978), 53). But despite Macdonald’s assertion, the sonority which Skryabin presents does not conform to any of the tonal schemes which Skryabin generally exploits. The fifth and tritone *do* appear together in Skryabin’s later works (and the earlier ones as well for that matter), but these are usually relative to either a *mystic* chord or a *Tristan* chord or an ‘augmented sixth chord’, all of which are readily classifiable. The chord here is very different. It is not whole-tone as the pitches E and F#, which appear so significantly throughout the section as well as the G# and B, prevent the section from being explained as ‘octatonic’.

In *Vers la Flamme*, Op. 72 however, the music produces no contrasting themes, and the evolution of a musical subject follows a single line of trajectory towards a final climax – what Jim Samson calls, when he speaks of this same piece, a “cumulative momentum”, a “carefully paced crescendo”.<sup>420</sup> As Faubion Bowers puts it, “[*Vers la Flamme*] is composed essentially of two notes – that familiar descending half-step – which crackle like lashing flames ... The whole piece is like a Roman candle of increasing magnifying blazes, until it becomes consumed in its own flames.”<sup>421</sup> There is no ‘other’ musical subject that serves as a ‘grown-up’ (already constructed) example, and this discourse seems to work within the confines of Blavatsky’s *feminine* model of cosmogenesis. However, subject-forming does come within the paternal region by the end of the sonata. Symbolised by ‘light’ and ‘knowledge’, which Skryabin famously tried to depict in music, these symbols are located at the crossroads of the two parental functions. But regardless of gender issues, the piece certainly embodies Skryabin’s words: “For my infinite exaltation I need infinite development, an infinite growth of the past ... I had to pass through an infinitude of centuries in order to awaken to my present state.”<sup>422</sup> Pertinent too is Wagner’s description of musical progress in *Opera and Drama*.

Starting out from the fundamental note of harmony, music grew to fill an immensely varied expanse in which the absolute musician swam aimlessly and restlessly to and fro, until he grew afraid. Ahead of this he saw but an endless billowing mass of possibilities, while being conscious in himself of no single purpose to which to put those possibilities.<sup>423</sup>

The two concepts that underpin this analysis – Freud’s Identification, Lacan’s ‘Mirror Stage’ – each chart the journey of preternatural drives into the symbolic world of desire. And this is the motion that dialectically flows through the textual and musical analyses that follow.

### Skryabin’s *Vers la Flamme*: Poem, Op. 72

*Vers la Flamme* opens with an ambiguous pair of thirds, moving immediately to a *French Sixth* chord in G# major (an  $\alpha$ -DRIVE on E and A#).



FIGURE 6-3: *VERS LA FLAMME*, MM. 1-5

<sup>420</sup> Jim Samson, *Music in Transition: A Study of Tonal Expansion and Atonality, 1900-1920* (London: Dent, 1977), 169.

<sup>421</sup> Bowers, *Scriabin: A Biography 2*, 255.

<sup>422</sup> Schloezer, *Scriabin: Artist and Mystic*, 195.

<sup>423</sup> Nattiez, *Wagner Androgynous: A Study in Interpretation*, 54.



The upper third – C# – resolves to D, whilst the lower – A# – is retained in the subsequent chord, commuted to a lower octave. Thus the C# → D resolution represents an isolated voice-leading motion. These thirds are altered in m. 3, leading into m. 4, to enunciate F#/A# rather than A#/C#. This pair of thirds intimates a refracted F# triad, and this triadic object negates the pregnant *a*-DRIVES. This stasis opens countless Skryabin pieces but is ordinarily short-lived. Generally, states of inertia are mobilised by material such as grandiloquent triadic statements or trumpet fanfares. But the sole disturbance to *Vers la Flamme*'s maternal womb-like sonority is the pitch F# in the melodic line of m. 3. Transient as this is, it emerges climactically, underpinned by 'hairpin' dynamics. We now confront the question of whether this F# is an 'other' pitch, working "from without to within", or a necessary expansion of the swelling maternal womb from "within to without". Two considerations support a 'from within' interpretation. Firstly, F# is subsumed by the same whole-tone collection as the *a*-DRIVE. This corresponds to other pieces (see Sonata no. 5, Op. 53, m. 13) whose opening sonorities form incomplete whole-tone collections, eventually extending their embrace to missing pitches.<sup>424</sup> Secondly, the F# is the root of the implied triad, formed from the fragmented thirds – A#/C# and F#/C#. It is striking that the pitch is articulated above a sustained bass tritone, creating an evanescent *i*-DRIVE on F#. The tritone is sustained from the previous measure, rather than being re-struck, allowing the new pitch to be celebrated by itself – it has room to breath and expand within its allotted time-frame like a cadenza. As quickly as this note appears, so it cautiously disappears in m. 4. Skryabin composes ever-expanding music and, to this end, new elements must be rooted in the old, to which Skryabin frequently returns; they must therefore be introduced delicately and cautiously. The F# further features over an A# in m. 5 as a pair of sixths. Because these sixths overlay a tritone (G/C#) and resolve onto yet another (F/B), they generate a new *a*-DRIVE (see *Appendix E*). They also masquerade as inversions of the anacrustic opening thirds, metrically displacing the harmonic refrain.

Another new element, introduced in m. 3, is the increased rate of chordal oscillation. Looking at the interaction of the two chords reveals that the chords begin to synthesise: the inner G# starts to trail below the C# rather than its tritone companion D, and the F#/A# sixths are struck 'on the beat'. These rhythmic diminutions are swiftly rejected, and the original non-syncopated triple metre is revisited. But this rhythmic collapse has irrevocably ruptured the tranquillity and the F#/A# sixths are heard once more 'on the beat' in m. 5. The new element has been ostensibly discarded, but actually cautiously assimilated. Skryabin's formula is apparent from the outset. *The new component – a rhythm or pitch – is presented as a natural extension of the old; after its initial appearance and suppression it is carefully integrated back into*

<sup>424</sup> In Sonata no. 5 the *Larghetto* chord at m. 13 contains E#, F#, G#, A#. This whole-tone cluster extends to include D# in m. 14. The only absent pitch – B – remains elusive on this occasion, but appears in a contracted version of this opening in m. 17-18. See figure 3-4.

the musical fabric until it is normalised and accepted. Thus an ever-evolving subject, with motility between two worlds, is conceived.

But whilst I have hitherto drawn an objectal relationship between the opening chords, the two elements may be regarded as one whole. Amalgamating these pitches (F#, C#, E, A#, G#, D) unveils a *mystic* chord. Why has this famous chord been polarised into augmented fourths (E/A#, G#/D), and perfect fourths (C#/F#)? The element which arises as an 'other' sonority appears to be the F# triad, and the maternal element is the whole-tone *a*-DRIVE – the *chora*. Otherness is now situated within this maternal body as the 'Father of Individual Prehistory'; a paternal 'vision'; a pair of fifths, nestled within the *mystic* chord. These fifths (fourths) – durable symbols of masculinity – will continue to be investigated through this chapter. One must also be sensitive to the fact that the *mystic* chord held particular associations for Skryabin. During the London *Prometheus* rehearsals in 1914 he described it as 'the chord of the pleroma'. Pleroma, as Taruskin explains, is a Christian Gnostic term for 'plenitude': "Its preternatural stillness was a Gnostic intimation of a hidden otherness, a world and its fullness wholly above and beyond rational or emotional cognition."<sup>425</sup> Skryabin also related the chord to the upper notes of the harmonic series. Analysts have always contested this view, maintaining that the harmonic series is incompatible with equal temperament; Peacock's thesis *Prometheus: Philosophy and Structure* provides translations of correspondences from 'overtone theory' advocate, Leonid Sabaneyev. Skryabin, it seems, was aware of the limitations of equal temperament and experimented with a harmonium in an attempt to transcend them.<sup>426</sup> Skryabin wholeheartedly approved of the *mystic* chord in untempered pitch; the chord therefore represented 'nature' for Skryabin.<sup>427</sup> Thus in *Vers la Flamme*, nature is divided into a masculine tonal chord and a feminine, womb-like, whole-tone sonority.

*Vers la Flamme* continues to evolve in small increments; each development is sensitively primed and assimilated. In contrast to sonatas and symphonies, where the colossal dialectic of the outside world (calling the inside world) propels the subject forwards, the subject here appears to be fatherless; every phase of development is maternally guided. *Vers la Flamme* is positioned in this maternal realm, where development is introduced naturally and seamlessly, each new element immediately folding back into itself. The following table traces the structure of *Vers la Flamme*, highlighting the ways in which the 'new elements', which drive the music forwards, arise naturally from the ever-growing material.

<sup>425</sup> As Quoted by Simon Morrison, 'Skryabin and the Impossible', *Journal of The American Musicological Society* 51 (1998), 314.

<sup>426</sup> Peacock, *Alexander Scriabin's Prometheus: Philosophy and Structure*, 137.

<sup>427</sup> This could invite comparison with Schenker's 'chord of nature' – the triad.

M.	New Element	Origin
1	Divided <i>mystic</i> chord	<i>Prometheus</i> , Op. 60. Derived (supposedly) from nature.
3	Pitch F#	Completes the implied whole-tone scale, further completes the <i>mystic</i> chord.
5	T3 transposition	From the opening measure. Axial rotation, connected by F#/A# sixths.
11	T6 transposition	See m. 5. Inversion of opening <i>a-DRIVE</i> .
14	New chord	Chromatic rise/fall from opening, Partial submission to the pull of the <i>French Sixth</i> ( <i>a-DRIVE</i> on Bb).
19	B minor chord	See new chord at m. 14, m. 19 is a natural voice-leading extension.
	Overlaid thirds	The upper notes fill the <i>mystic</i> chord.
27	Melodic layer is added.	Inverted C# → D from opening. Pattern of melodic overlay is an extension of m. 19's overlaid thirds.
31	Upper G# in melody	Propensity for F# to rise to G# in the inner voices at mm. 27-29.
41	Pentuplets outlining pitches E/B	From E-B alternation in mm. 27-29 in bass.
	D/G# pitch alternation	Stems from melody at m. 27, spanning D/G#. And also from opening <i>a-DRIVE</i> . Relationship crystallised at m. 44 when D lowers to C#.
45	Melodic A / G#	Successive transposition of voices, established in opening sequences.
46	Melodic descent from G# to C#	Prepared by accompaniment in previous measure.
48	Inner voice pitch D	Descent from Eb in preceding measure. Echoed melodically, an octave higher, at m. 50.
60	Double-voiced F-C fifths in melodic line. Major seconds in lower voice rather than fourths.	F springs from previous semitone descent; C continues upper voice. Major seconds result from the disruption of fourths, due to the F-C fifths.
61	Both upper voices 'drop-out'	This omission balances the previous bar's density, affording a brief respite, before re-entry in m. 62.
64	Octave F# in bass	Octave C's in m. 60, which were by-products of the F-C.
65	Semi-quavers in bass	See m. 41 - identical pitches presented as poly-rhythm (9s vs 5s)
70	Two moving inner voices	The voices are arrangements of the opening measures.
73	Melodic major seconds – F/G	Vertical contraction of major second motion of melodic line.
76	Seconds alternate (additional seconds: D/C)	These were horizontally alternated in previous measure.
77	Rapidly alternating seconds. Opening expansion/contraction model in lower parts.	Previous measures and opening.
81	Replacement of alternating seconds with thirds / fourths from opening. Pentuplets.	Opening. Pentuplets from 41.
84	Opening pattern is elongated.	Opening.
97	New rhythm in upper tessitura, coinciding with new climactic staccato 5 note repetition	<i>See following discussion</i>
107	Remodelled opening with staccato motive overlaid. Vigorous	Tritone / thirds, alternating from opening.

	alternations of tritone G#/D with thirds C#/A#.	
133	<i>Vers la Flamme</i> ends with staccato repeated chords.	See fourths in m. 97.

FIGURE 6-4: *VERS LA FLAMME*, STAGES OF ORGANIC GROWTH

## Drive Analysis I

*Drive analysis* can also shed light upon this evolutionary structure; a complete graph of the piece comprises *Appendix E*. The concept of discharge is very sketchily intimated in the opening when one tensile chord (the  $a_{\text{DRIVE}}$ ) ‘resolves’ to a dislocated F# triad. This resolution is *indirect* of course; a drive on E would naturally resolve to a triad on A, rather than its t3 substitute F#. And until m. 14 there are no direct discharges in this passage at all. The body of  $a_{\text{DRIVES}}$  circulates the axis – E, G, C# and Bb – whilst triads on the relative *T* axis – F# and A – freely move, never as the result of *direct discharge*. M. 14 contains the first *direct discharge* in the piece, caused by the  $a_{\text{DRIVE}}$  on Bb which resolves fully to the chord of Eb.



FIGURE 6-5: *VERS LA FLAMME*, MM. 12-18

The narrative of these bars is unmistakable; drives circle objects before attaching themselves, and thus the ‘musical subject’ becomes a desiring one. From this significant juncture, *direct discharge* (often ‘nested’) becomes the norm, and the harmonic structure eventually yields various nested cycles of fifths. The *drive analysis* graph (*Appendix E*) shows numerous instances of this.



FIGURE 6-6: *VERS LA FLAMME*, MM. 27-31

In m. 27-30, a chromatic descent is accompanied by such a cycle which locally rotates all three tonal functions, ending on the original axis: B → E → A → D. In this section, the drives are particularly weakly articulated  $b^{\flat}_{\text{DRIVES}}$ ,  $e^{\flat}_{\text{DRIVES}}$  and  $e^{\flat}_{\text{DRIVES}}$ . Through the course of the work the drives regain their strength, though this process will be discussed in due course. Furthermore, the drives on the following page of *Appendix E* become scattered and dissociated. Gone is the dense axial network of  $a_{\text{DRIVES}}$  from

the opening. It seems that the drives, having learned the secret of discharge, move away from their comfortable network and explore their own individual territory.

## Melodic Analysis

This discussion corrects the bias towards harmonic analysis by looking more closely at melodic processes, a task begun in Chapter 5. This bias is systemic of Skryabin scholarship and, despite the many analyses of Skryabin's compositional systems, there have been comparatively few efforts to study the pitch structure of his melodies. The concept of melody is not as germane to Skryabin as it is to a Mozart aria or a Tchaikovsky ballet, and often, what one regards as melodic line in a Skryabin score is merely the upper voice of a thick texture. Yet there are enough refinements in Skryabin's melodic writing to assure us that great care has been taken with the unfolding of melodic pitches. Of course, with my Meyerian premise, the introductory  $C\# \rightarrow D$  gambit indicates chromatic continuation. This tendency is generally allowed full reign. Skryabin affects a large chromatic ascending arch, each pitch carefully placed and contextualised to induce the sensation of ascension, expansion and evolution to last throughout. The chromatic ascent *unfolds* (in a Schenkerian meaning) from foreground to background. Significant pitches are often thrown onto the texture as 'strangers' to the chromatic rise, but the novelty of this striking effect is usually watered down through the immediate 'negation' afforded by the chromatic descent to fill the gap produced by the leap. The notes thus materialise in the 'wrong' order. I have marked these with double arrow-headed lines on the following graph; such is the case in mm. 5-6, 11-14, 19-23, 85-93.<sup>428</sup>

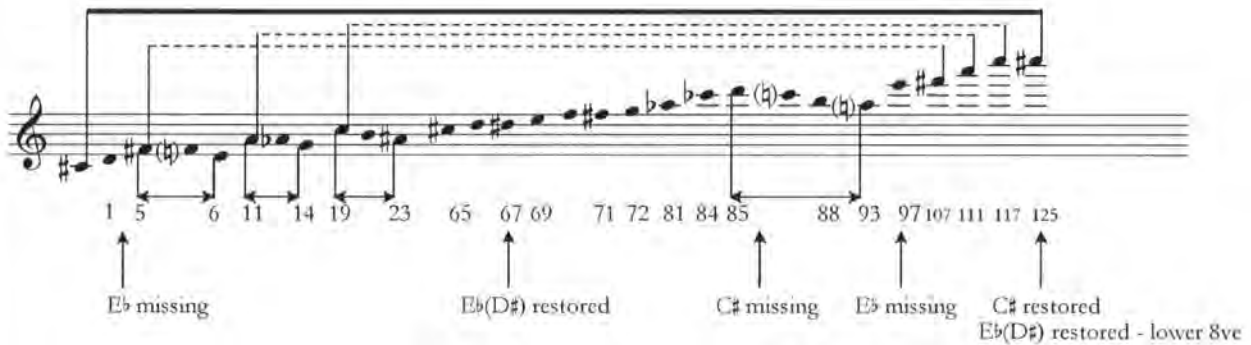

FIGURE 6-7: MELODIC STRUCTURE OF *VERS LA FLAMME* – FOUR 8VE CHROMATIC ASCENT

A reordering of salient notes produces a clear ascending line that incorporates mini-chromatic descending lines and, in the opening 23 measures, rising fourths: motive ♀ and motive ♂. Through the delicate combination of these motives, a structural chromatic ascent is carefully unfolded. Apart from the very first measures, these mini-progressions are not simply the products of mechanical

<sup>428</sup> Analysing the graph of the chromatic ascent one discerns a missing  $C\#$ . The significance of this missing note, as well as the missing  $E^b$  in mm. 1-5 will be discussed soon. Please note also, the dashed note beams indicate pitch-class connections.

transposition. The C, which is produced at m. 19 for instance, is overlaid above the  $t_6$  transposition of the opening measures that constituted mm. 11-14. The descent from mm. 85-93 is a similarly structured sequence. Following a tritone ascent from  $A\flat$  to D (via  $C\flat$ ), this consequent descent completes the intervening tones (omitting the  $A\flat$ , D and  $C\flat$ ). The tritone skip is actually broken into two minor thirds, facilitating a play of expectation: the rise from  $A\flat$  to  $C\flat$  would suggest, given the nature of the previous measures, that a chromatic descent was imminent. Instead, Skryabin stores up the tension that would be released from this *gap fill*, and allows it to be expended in a longer time frame. The unfolding of these structural pitches also embodies a careful process of integration. As with all 'new' elements in the piece, they are surreptitiously introduced in the margins before being assimilated into the structure. M. 66 confirms this when the pitch E is introduced as an anacrusis to a  $D\sharp$ , enjoying full legitimisation only in m. 69.

A comparison of mm. 1-23 with mm. 97-125 is noteworthy. Although a recapitulation suggests itself towards the end, it is heard more as an aesthetic fusion of materials gathered thus far and, in terms of melodic contour, the introduction of new pitches in the final part does not seem to accord with that of the first. In mm. 107 Skryabin plainly calls on the same ascending [0,3,6] *diminished* skeleton, but provides no chromatic support to fill these gaps. If the descending chromatic line embodies all things feminine, and leaps (usually of fourths) embody all things masculine, then the trajectory of the piece is a sweeping manoeuvre from womanhood to manhood. It is surely not coincidental that the grandiose finale introduces slowly arpeggiated fourths.

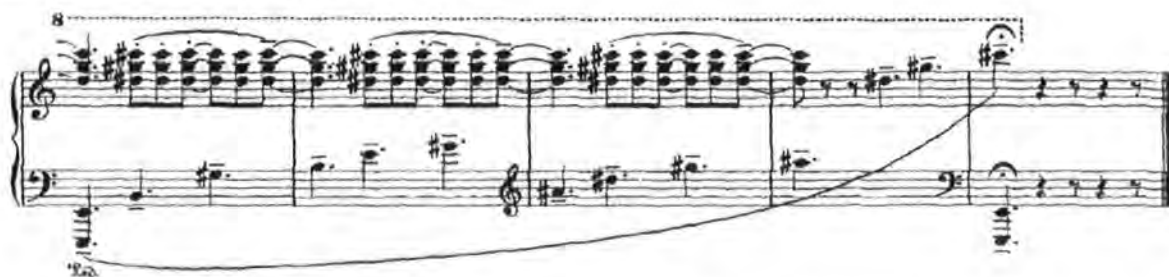

FIGURE 6-8: FINAL MEASURES OF *VERS LA FLAMME*

But how does one interpret the missing pitches –  $C\sharp$  and  $E\flat$  – in the rising chromatic line? The pitches do pertain to the piece as a whole, but are alienated from the ascent; they lurk in inner parts amid harmonic (rather than melodic) procedures, and therefore could only be assimilated into my models with great reservation. The missing  $C\sharp$  (mm. 85-88) is certainly the most conspicuous because, after m. 23, one would be expecting to hear a continuation of the rising diminished nodes and their complimentary 'gap-fills'. One would expect to hear an  $E\flat$  falling to a  $C\sharp$  but, instead, Skryabin transfers the discourse to a lower tessitura and slowly reconstructs the ascent from a low perspective, moving immediately to a  $C\sharp$  an octave below at m. 27. We are back to 'square one'. The contour then

rises, as systematically again, to an upper C# after a 40 measure reconstruction that develops the previous material into new sonorities and textures. C# (and its partner D) is thus bestowed with structural significance, dividing the piece's episodes into clear octaves. The fact that C# is heard at the eventual climax and final sonority exposes something of this note's guiding power; it has been transformed.

The other conspicuously absent pitch is Eb, which only surfaces (in the guise of D#) structurally at the epicentre of the piece (m. 67). It is omitted in mm. 1-5 and, more crucially, in mm. 93-97. Its absence from the final measures is hardly surprising as the chromatic ascent breaks down almost completely here. With the Eb missing in the final measures, intervals begin to widen: C# → D → E → F# → A. This is the exact mirror of the opening gambit of the Op. 74 prelude that I examined in the previous chapter. The crowning C# of the piece would seem to close this gap, but ascending perfect fourths from the (D# (enharmonic Eb)-G#-C#), at a more foreground level, counteract this tendency, thus completing the melodic chromatic arch, whilst reinforcing the two newly reinstated missing pitches.

## The Pinnacle of Evolution

Like Skryabin's other major works, *Vers la Flamme* advances towards a state of ecstatic climax. In orchestral pieces climaxes break through most dazzlingly in the final measures, whilst they can erupt sporadically in the late sonatas. Despite this, *Vers la Flamme's* climax follows the orchestral model, appearing at the very conclusion. This unique climax emerges and endures from m. 81 to the final chord – an extended episode for a five-minute piano work. Moreover, *Vers la Flamme* climaxes through the recapitulation, crossing formal boundaries to maintain the expansion. Contrary to the audibly identifiable recapitulation of the more conventional sonata structure, the recapitulation of *Vers la Flamme* enters obscurely in m. 107. The intricacies of this recapitulation and its preparations will be revealed through *drive analysis*.

My first focal point is the push towards the final climax – the *Éclatant, lumineux*. As m. 81 advances, the drives accumulate. In m. 77 a major triad on E underpins an  $b^{\#}_{\text{DRIVE}}$  on C# and a  $e^{\flat}_{\text{DRIVE}}$  on Bb (A#). The ancillary melodic pitch D# in the left-hand soon invests this chord with a stronger driving quality at the end of the measure – a  $e^{\flat}_{\text{DRIVE}}$  on E. The same D# additionally promotes the erstwhile  $e^{\flat}_{\text{DRIVE}}$  on Bb to an  $e^{\flat}_{\text{DRIVE}}$ .

FIGURE 6-9: *VERS LA FLAMME*, MM. 77-78

In m. 78 a further melodic  $F\sharp$  supplements the drive economy by adding its own  $e'$ -DRIVE, thickening this already viscous sonority.<sup>429</sup> It seems that gradually accumulating melodic pitches fortify drive forces.

But this consolidation process serves only to intensify the disparity of that which follows. From m. 81 the subsequent drives are surprisingly enervated, as shown on *Appendix E*.

FIGURE 6-10: *VERS LA FLAMME*, MM. 81-82

A minor triad on G and an  $e''$ -DRIVE on  $Bb$  are perhaps the most tensile forces for several measures. Specifically, chords lose definition in this passage of dissolution; thirds are removed ( $j$ -DRIVES), fifths are missing ( $e''$ -DRIVES) and even sevenths are occasionally absent (major or minor triads). In this case, the purity of the  $D$  axis (there are relatively few 'alien' drives in this section) fortifies the individually fragile drives. In the final analysis these drives recover from their dissipation, reconstituting themselves in a

<sup>429</sup> As a brief aside we must take the opportunity of noting that a basic interpretation of Scriabin's music would latch onto the use of the *mystic* chord on E in m. 78. *Drive analysis* here is able to cater for the alien pitch B that fulfils such a pivotal function in the drive processes of these moments.



doubly fortified *D* function – a concentrated axis comprising virile, robust drives. Focus sharpens in m. 90 as  $\ell$ -DRIVES on C#, Bb, G and E reach the surface.

The image shows three systems of musical notation for piano, numbered 89, (90), and 91. Each system consists of a treble clef staff and a bass clef staff. The notation includes various rhythmic values, accidentals, and dynamic markings. In system 89, there are markings for '7' and '7 3'. In system 90, there are markings for '7' and '7 3'. In system 91, there are markings for 'm. r.' and 'm. g.'.

FIGURE 6-11: *VERS LA FLAMME*, MM. 89-91

Subsequently, the most compelling drives are the  $\ell$ -DRIVES from m. 94 ff. As sturdy as these reinforcements become, the ultimate dissolution announces itself in the final measures – mm. 129 ff. The *drive analysis* graph simply reads: “*drive analysis* becomes redundant here”. Skryabin’s harmony now loses its triadic basis, becoming genuinely quartal. Critics tend to reject the view of Skryabin’s harmony as quartal, and *drive analysis* confirms Dernova’s diagnosis that Skryabin merely makes use of quartal *distribution*, rather than quartal *construction*, the triadic basis of his chords remaining intact.<sup>430</sup> However, the final moment of the piece compiles perfect fourths – A#, D#, G#, C# –, thus saturating the erstwhile drive-saturated *chora* with a point of masculine, objectified desire, leaving the apparatus of *drive analysis* behind.

One virtue of *drive analysis* is its potential for unearthing links that otherwise remain buried. In one particular instance the drives reveal a certain formal boundary, where motivic material would suggest a contrary interpretation. The recapitulation, I would claim, begins in m. 107. I deem this recapitulation to be ‘seamless’ because of its drive configuration, which allows it to flow effortlessly from the

<sup>430</sup> Guenther, *Varvara Dernova's "Garmoniia Skriabina": A Translation and Critical Commentary*, 41. Guenther provides a summary of various ‘quartal’ interpretations of Skryabin’s music. Sabbagh explores the integration of quartal and triadic structures; *The Development of Harmony in Scriabin's Works*, 40-44.

preceding material. In m. 95  $\ell$ -DRIVES appear on E and F#, with additional C# ( $\ell^{\#}$ -DRIVE) and G# ( $\ell^{\#}$ -DRIVE) forces. We then hear  $\ell$ -DRIVES on D and E in m. 97.

FIGURE 6-12: *VERS LA FLAMME*, MM. 94-99

This latter configuration is embodied in a transfigured version of the opening material, now invested with febrile tremolandi, and, were it not for harmonic differences, one would be inclined to judge this to be the conception of the ‘recapitulation’. These two drive configurations alternate until m. 107, when m. 97’s figuration – a transmogrification of the opening – is transposed upwards at t2, which now suits the exposition’s harmonic make-up.

FIGURE 6-13: *VERS LA FLAMME*, M. 97 & M. 107

The transposition in m. 107 announces the recapitulation, whose inception is seamless because its preceding measures also contain the ‘correct’ drive configuration –  $\ell$ -DRIVES on E and F# embedded though they are in fuller drive textures. These now slot into place with the recapitulatory motives.

Comparison with 'real' sonata forms is invited, whose climaxes tend towards the closure of the development. In such forms the recapitulation recuperates from the Dionysian ecstatic moment by revisiting deeply engrained themes from the exposition in a modestly faithful restatement. Sonata no. 5 is perhaps the paradigmatic opus in this respect, its climax abruptly halts, initiating the recapitulation after a fermata. Only Sonata no. 4 stands apart from this mould, but for programmatic reasons. As illustrated, it followed the trajectory of a man flying towards a star – towards ecstasy. But even this work betrayed cognisable leaps in its evolutionary flow, particularly in its recapitulation (i.e. the *attaca* between movements). *Vers la Flamme* flows more seamlessly between its various states. There are numerous alterations to the original drive structure of this recapitulation of course. Notably, the erstwhile tritones of the bass' pedal now enunciate perfect fifths; the A# (hovering above the E) is modified to a B.<sup>431</sup> Yet again, Skryabin negates the drives from the opening to create a less tensile – masculine – environment in which pure drive is rejected in favour of symbolic gesture – motive  $\hat{C}$ . The *semiotic* is rejected in favour of the *symbolic*.

But through this heightened phase of drama, a further profound gesture takes centre stage. M. 97, with its authoritative, repetitive fourths, is instantly contrasted. Despite being cast aside, this 'new' material still manages to shape the climax of the piece. But rather than synthesise themes and keys, which the recapitulations of sonata forms would generally accomplish, this is the first flash of truly polarised material, manifest in the rapid alternation of motives. The sudden shift in register, combined with wider intervals (opposing the previous major seconds) and an increased rate of tremolando produces a startling, if somewhat meretricious, effect. However, one must be wary of overstating this polarity; various bonds do fix m. 97 firmly to m. 96 (and surrounding measures). The upper 'fourths chords' are a familiar character in a new guise; they saturate the latter half of the work, and indeed, m. 96 encompasses the pitches G#-C#-D#-F# (from bottom to top). Rearranging the D# (by commuting it to the base of the texture) would generate a fully quartal sonority but, as it is, three fourths are already exhibited – G#-C#-F#. The fourths in m. 97 – F#-B-E – continue this sequence: G#-C#-F# → F#-B-E. *Drive analysis* betrays subterranean connections here, finding  $\ell_{\text{DRIVES}}$  separated by a whole-tone – on E and D (mm. 97/101) – akin to Harrison's original 'double barreled discharge'. This forges a *S/D* collision, indicating a *T* of A – a t3 substitute for the F# *T* of the opening. In m. 111 this expectation is fully realised in the  $\ell_{\text{DRIVE}}$  on A, but from a different vantage point (simultaneous drives on F# and E – F# being a substitute *T*). However, despite these connective devices, m. 97 is certainly a novelty.

But perhaps the outward appearance of polarisation is simply withdrawal from a single protracted evolutionary metamorphic trajectory – a *thetic break*; the subject becomes split, enters into the Symbolic

<sup>431</sup> This said, the A# still tremolos in the inner parts.

Order, passes through 'the mirror stage' in a moment of self-recognition in the Other. The recapitulation marks the point of no return. From here, the new material never looks backwards; the subject is free to create for itself. Does this represent the final stage of the subject's evolution – the birth of consciousness? As the piece closes, the subtle texture of polytonal drives dilutes into a negating string of masculine rising fourths. Skryabin's goal is complete; no longer the womb-like feminine state of materiality, we are now in the masculine realm. Evolution certainly progresses unfettered. Everything increases: the carefully notated tremolandi, replete with intricate tied notes, now become incessant and feverish; the register leaps to unforeseen heights. But these gestures coalesce beneath a dense symbolic regime, which I shall now examine.

## Poiesis

At the end of *Vers la Flamme* the principal symbols, as suggested by the title, are light and heat, embodied in the flame. The title invites the direction 'towards', betraying a teleological bias to the work's poetics, an orientation also admitted into the musical structure. These two elements of the flame – heat and light – share an ambiguous relationship here. Schopenhauer claims, "the will is warmth, the intellect is light", but Skryabin's intentions are clarified through symbolic musical construction.<sup>432</sup> Skryabin metamorphoses one of his classic symbols – trills. As Garcia shows, "Scriabin uses trills, tremolos and other floritur to allude to light and by extension, to divine illumination."<sup>433</sup> She quotes Bowers, "he uses trills incessantly for luminosity. Trills to Scriabin were palpitations ... trembling ... the vibrations in the atmosphere and a source of light." Garcia also claims that these trills fall under the domain of the erotic.<sup>434</sup> Kristeva herself, examining the poetry of Vladimir Mayakovsky, finds the sun (and therefore light) to be symbolic of the father. This reinforces gendered contrasts that are fully commensurate with the esoteric Tao principle, influential to German Romanticism, of Ying (female, death, darkness) and Yang (male, life, light).<sup>435</sup> But, as Bowers claims, "Trills no longer suffice for Skryabin's frenetic pianism. He now writes spasms of eight clustered, shaking and quivering notes."<sup>436</sup> Skryabin's infamous 'trills' become tremolandi. The fact that these begin by oscillating clusters of major seconds betrays the synthetic element of these two forms of 'decoration'. In a work such as Sonata no. 9 – *The Black Mass* – trills suddenly accompany drastic changes in musical style. The same is true of the Sonata no. 10, which Skryabin calls "a sonata of insects" because of its trills, linking these synecdochally to the image of the sun – "insects are born

<sup>432</sup> Schopenhauer, *The World as Will and Idea*, 89.

<sup>433</sup> Garcia, 'Scriabin's Symbolist Plot Archetype in the Late Piano Sonatas', 283.

<sup>434</sup> *Ibid.*, 283-4.

<sup>435</sup> See Julia Kristeva, *Desire in Language: A Semiotic Approach to Literature and Art* (New York: Columbia University Press, 1980), 29; Friedrichsmeyer, *The Androgyne in Early German Romanticism: Friedrich Schlegel, Novalis and the Metaphysics of Love*, 10.

<sup>436</sup> Bowers, *Scriabin: A Biography* 2, 255.

from the sun”;<sup>437</sup> they are “kisses of the sun come to life”; “the sun comes down and blisters the earth”.<sup>438</sup> In the Tenth Sonata trills become attached to triads and other types of ‘already evolved’ objects. Figure 6-14 quotes the *lumineux vibrant* chords as examples of trills that reveal an ostensible alliance with luminosity.



FIGURE 6-14: SONATA NO. 10, *LUMINEUX VIBRANT*

But tremolandi fulfil a different function – a feminine function. In *Vers la Flamme* they accelerate from the opening measures. Where deliberate, alternating harmonies represented the initial maternal stasis presiding over the beginning of the work, feverish tremolandi now rupture the final pages of the score, the intricately alternating rhythms becoming a total tremolando. To situate us within the gender polarities of the piece I appeal to a significant moment in the text of the *Acte Préalable*. Two elements give birth to cosmogonic consciousness: waves and rays of light. The union of these two aspects takes a decidedly sexual turn in Skryabin’s ‘poem’, as Boris de Schloezer describes, “A soul is born from the union of the Ray of Light and one of the waves.”<sup>439</sup> These waves are female, passive objects as described in the text, the principal wave declaring, “I was from my sisters torn away.”<sup>440</sup> The waves also participate in a chant of words, describing their erotic blossoming, among which we read of “tremors” and “throbs”. Thus these tremolandi, which originally outline drives, are Skryabin’s musical symbols of womanhood.<sup>441</sup> However, tremolandi become trill-like when major seconds are added. In these instances, the seconds (trill-like, ergo masculine) vacillate fourths and fifths (another symbol of masculinity) until polarity is born, culminating in the staccato fourths of m. 97. The masculine then, is born of the feminine – Kristeva’s *Father of Individual Prehistory*. This theoretical Freudian figure was found in Skryabin’s philosophy and now, it seems, in his music, despite the fact that, in the text, they are conceived as two separate characters. The staccato fourths, enunciated in the upper register therefore represent *Fohat*, the Promethean light bringer. These fourths – products of the feminine waves – draw the music to its inevitable conclusion when the *chora* is thoroughly repressed in favour of a total saturation of quartal, drive-negating harmonies. I thus approach a more sophisticated version of the popularising narrative accounts, common to Skryabin’s early critics in musicology: “The music

<sup>437</sup> Ibid., 245-246.

<sup>438</sup> Bowers, *The New Scriabin: Enigma and Answers*, 16.

<sup>439</sup> Schloezer, *Scriabin: Artist and Mystic*, 300.

<sup>440</sup> Ibid.

<sup>441</sup> Ibid., 299.

gradually acquires more and more life, light and rhythm until the chief subject is clearly defined; this grows more and more luminous and brilliant, finally ending in a climax of blazing radiance...”<sup>442</sup>

Chapter 5 uncovered motivic gender symbolism in the Fourth Sonata, but this chapter enshrines it in harmonic theory. In *Vers la Flamme*, symbols are born from each other, returning us to the discipline of semiotics.

## In the Beginning was the Word

As part of Skryabin’s search for the *Absolute* he flirted with the idea of studying Sanskrit – the “primordial Aryan language” – but he engaged with semiotics more rigorously by collaborating with fellow Theosophist and professor of elocution – Emile Cicogne.<sup>443</sup> The pair hoped to create a universal language for the *Mysterium*. Less questionable semiotic concerns were theorised by Skryabin’s poetic associates such as Andrey Bely, whose novels and poems search for the ‘musicality’ of text. Bely’s essays describe his use of sonata-form in his poetry; he called his poems ‘symphonies’, using principles of ‘verbal orchestration’,<sup>444</sup> leitmotifs,<sup>445</sup> and he regarded Helmholtz’ *Psychology of Tone* as a basis for his hierarchy of vowels.<sup>446</sup> Bely also applied current theories of child psychology in his novel *Kotik Letaeu*, in which he used language to develop a ‘harmonic structure’ that follows a trajectory from childhood to the self-consciousness of adulthood – another refraction of the evolutionary paradigm under consideration.<sup>447</sup> It is surely no coincidence that Kristeva chose to adumbrate her theories of the linguistic *chora* by examining the symbology of Russian poets. Similar to Bely’s Theosophical novels – *Petersburg* and *The Silver dove* – in which the sound “uu” assumes symbolic meaning in itself, similar experiments with ‘sound words’ penetrate Skryabin’s text for the *Acte Préalable*. Such concerns pertained to Theosophy. Blavatsky herself invites us to magnify her work through a semiotic lens, though this is hardly novel – one finds ruminations of the relationships between words, thoughts and meanings in Plato. But Blavatsky goes so far as to use gendered terminology. In particular, her association of The Word (or Logos) with the masculine aspect of evolution – a gift bestowed from outside the developing subject – led her into the heart of Lacanian semiotics. Although Blavatsky did not have the benefit of Ferdinand de Saussure’s studies in semiology, based on readings of Sanskrit (which she herself studied of course) – Saussure’s notes were not published until 1916, three years after his death – she thoroughly reviews the concept of the ‘symbolic’, finding that:

<sup>442</sup> Hull, *Scriabin: A Great Russian Tone-Poet*, 209-210.

<sup>443</sup> Schloezer, *Scriabin: Artist and Mystic*, 295.

<sup>444</sup> Ada Steinberg, *Word and Music in the Novels of Andrey Bely* (Cambridge; New York: Cambridge University Press, 1982), 36.

<sup>445</sup> Bartlett, *Wagner & Russia*, 139-147.

<sup>446</sup> Steinberg, *Word and Music in the Novels of Andrey Bely*, 134, 56.

<sup>447</sup> *Ibid.*, 230.

Parabrahm (the One Reality, the Absolute) is the field of Absolute Consciousness, i.e. That Essence which is out of all relation to conditioned existence, and of which conscious existence is a conditioned symbol.<sup>448</sup>

For Kristeva and Lacan, the symbolic world is the *Imaginary* realm that we inhabit in order to repress the state of absolute materiality into which we are born (Kristeva's *chora*). Artists, particularly the symbolists of Russia, convolute the issue of symbology. Influenced both by the French movement and by Wagner, the Russian Symbolists saw the symbol as an unswerving path to the absolute.<sup>449</sup> But Blavatsky doubtless conceived of the symbolic world as Schopenhauer's 'veil of *Maya*', to which she refers several times. This is more akin to Lacan's *Imaginary*, a philosopher's conception of the symbol rather than a poet's: a move *away from* the absolute rather than a connection *to it*.<sup>450</sup>

Blavatsky further parallels Ferdinand de Saussure in her consideration of the discrepancies between the word and the idea.<sup>451</sup> Intriguingly, she discusses the notion that, although the sign is distinct to the thought, once invented, it *becomes* the thought and limits it. To Blavatsky this is deeply connected to the occult; the signified and the signifier are magically bonded. She quotes Paul Christian, author of *The History of Magic*:

To utter a Name is not only to define a Being (an Entity), but to place it under and condemn it through the emission of the Word (Verbum), to the influence of one or more Occult potencies. Things are, for every one of us, that which it (the Word) makes them while naming them. The Word (Verbum) or the speech of every man is, quite unconsciously to himself, a BLESSING or a CURSE, this is why our present ignorance about the properties or attributes of the IDEA as well as about the attributes and properties of MATTER, is often fatal to us.<sup>452</sup>

The tragedy of irrevocable acceptance into language (which pollutes the unconscious) and the consequent loss (or *Lack*) of *The Real*, is particularly Lacanian. Lacan's dictum – 'the unconscious is structured like a language' – claims that, upon entry into the Symbolic Order, the subconscious also accepts the structure of language. Thus, for Lacan, the unconscious does not correspond to Kristeva's *chora* and is different to her indiscernible collection of bodily drives. Kristeva mediates this disjuncture by modelling the *chora* as an always already present force within our subconscious; repressed but never lost, there is always the possibility of return. Blavatsky too bridges this gap; quoting from the *Bhagadgita* she acknowledges two paths. One path leads to the light of the sun – the day, the Flame, the masculine Word – whilst the other leads to the lunar or astral light – feminine silence. The first path is a one way path, but the second allows the subject to be 'reborn'. The distinction here is surely the difference between Lacan's *lack* and Kristeva's omni-present *chora*. This becomes particularly apparent when

<sup>448</sup> Blavatsky, *The Secret Doctrine: The Synthesis of Science, Religion and Philosophy*, 15.

<sup>449</sup> See Ivanov's many essays on the role of the artist in bringing reality to consciousness: Ivanov, *Selected Essays*.

<sup>450</sup> *Maya* was originally a Hindu term, referring to life as an 'illusion' based on physical and mental limitations in which subjectivity becomes entangled. Skryabin would have encountered this in both *Word as Will and Idea* and Blavatsky's *Secret Doctrine*.

<sup>451</sup> Blavatsky, *The Secret Doctrine: The Synthesis of Science, Religion and Philosophy*, 92.

<sup>452</sup> *Ibid.*, 93.

Blavatsky suggests that this flame symbolises knowledge and language.<sup>453</sup> In acknowledging these diverging paths, there is confirmation of the omnipresence of the latter. In other places in Blavatsky's macrocosm and microcosm cosmology, the same pattern surfaces. She quotes the *Visishtadwaita Vedantis*, an XIth century exoteric system: "matter exists in two conditions, the *sukshma*, or latent and undifferentiated, and the *sthula* or differentiated condition".<sup>454</sup> This is a distinctly Kristevan concept – where the *chora*, although repressed, remains (unsullied by language unlike Lacan's *the Real*) throughout the subject's life and there is always the possibility to return. For Skryabin (and the foundations of the Russian Symbolist movement) there was the possibility of a return to the *Real*, via the symbol – Vyaseslav Ivanov's "*a realibus ad realiora*" ("from the real to the more real").<sup>455</sup> Unlike Kristeva's return to the *chora* – modelled on Georges Bataille – which occurs through the shock force of 'horror' (compare with Skryabin's later encounters with the cadaver in *Acte Préalable*), Skryabin viewed this return as the endpoint of cosmic endeavour. After reaching a state of physical ecstasy, the soul would reunite with God, in Death. Hence Skryabin's formulation:

0. Nothingness – Beatitude

1. I desire (before chaos)

2. I begin to discriminate vaguely

3. I discern; I begin to distribute elements (time and space) and foresee the future of the universe

4. I ascend to the summit and experience oneness

0. Beatitude – Nothingness<sup>456</sup>

In contrast to the Kristeva-Bataille method of reaching pure, abject materiality – Kant's *Ding an sich* – the Skryabin method is to achieve a state of ecstasy. This is also found in Bataille – the sexual orgasm: *la petite mort*, the return to the pure materiality of lights, colours, sensations.<sup>457</sup> This expands into Skryabin's *Mysterium* with its olfactory and tactile dimensions. Thus, in the programmatic aspect of *Vers la Flamme*, the transfiguration of the opening 'maternal' material into a decidedly masculine symbol, suggests the idea of a synthesis of maternity and paternity. The subject, moving from preternatural drive economies towards the luminescent world of the symbol, returns to its maternal roots in the final section, notwithstanding the very ultimate dissolution into the masculine symbolic world. Whilst a Freudian Oedipal relationship could stretch our reading a little too far, the aspect of the 'return to the

<sup>453</sup> One finds the symbolic myth of Prometheus implicit in this statement, a figure which modern Theosophists were extremely keen to adopt in their art works at the beginning of the 20<sup>th</sup> century. We naturally think of Skryabin and Jean Delville, the Belgian painter, who not only designed the cover to the First Edition of Skryabin's Fifth Symphony: *Prometheus: Poem of Fire*, but painted his own version of the Prometheus myth, deeply inspired by Theosophy and by Anne Besant's *Thought-Forms* in particular. Prometheus, the bringer of fire, merged with the figure of Lucifer, bringer of light, and found ample personification in Theosophical writings.

<sup>454</sup> Blavatsky, *The Secret Doctrine*, 522

<sup>455</sup> Ivanov's real vs. more real, corresponds to Lacan's reality vs the *Real*. See West, *Russian Symbolism: A Study of Vyacheslav Ivanov and the Russian Symbolist Aesthetic*, 186-187.

<sup>456</sup> Schloezer, *Scriabin: Artist and Mystic*, 205.

<sup>457</sup> Bataille, *Eroticism*, 49.



mother' is relatable to Blavatsky's *Secret Doctrine*. The writer of the *Book of Dyzan* states "the sons dissociate, scatter, to return into their mother's bosom at the end of the great day, and re-become one with her".<sup>458</sup> But the succeeding process is equally revealing – the 'sons' become 'cooled' in order to return to the mother, but in so doing they become 'radiant'. This radiance correlates to the light of 'the father', thus affecting a union of the paternal and maternal. Precluding a straight interpretation of the 'return to the mother' as acquiescence with all properties of the maternal realm, everything here is about fusion and dialectical synthesis.

## Drive Analysis ii

A complementary cross-disciplinary connection between Skryabin's piece and the evolutionary structure it enshrines can again be extrapolated from *drive analysis*. This work lends itself to *drive analysis* particularly well. The early focus on an F# triad and late structural discharge into A, suggests a fairly clear *T* axis. The following tonal model operates in the background:

<i>D</i>	mm.1-27
<i>S</i>	mm.27-33
<i>D</i>	mm.33-46
<i>T</i>	mm.46-55
<i>S</i>	mm.55-64
<i>D</i>	mm.64-95 ff.

This model notably deviates from the rotational strategy of the other opuses I have examined. Here, the *T* function is expressed in pure triads throughout the opening measures – F#, A and Eb. This is probably due to the evolutionary framework of the piece, which quickly establishes a teleological and linear (desire based) rather than cyclic (drive based) motion. Skryabin offers a stable goal in the very first measures, in syntactical contrast to unstable (non-related) drive chords. In this sense, if in no other, the work, despite its lateness, is conventionally tonal. On a formal level, the initial expositional  $D \rightarrow S \rightarrow D$  motion appears to be a concession to the sonata principle that polarises *D* and *T* regions. Now, through rotation around a  $T \rightarrow S \rightarrow D$  epicycle, this polarity is represented in *S* and *D* regions; nonetheless, the relative 'structure' remains. This continuity of tradition is surely surprising for a piece which makes such a gesture of polarising themes only very late in the structure. However, the opening measures establish a local *D* and *T* drive oscillation; a micro to macro correspondence is consolidated.

But functional  $S \rightarrow D \rightarrow T$  rotation comes very much to the fore and, like the seamless recapitulation, these functional shifts are indifferent to thematic changes, creating two incongruent lines of trajectory: the thematic *vs* the tonal. The *D* region is posited in the first full measure of the piece and is presented

<sup>458</sup> Blavatsky, *The Secret Doctrine: The Synthesis of Science, Religion and Philosophy*, 30.

authentically from the start; dominant seventh-driven chords are interpolated by pure tonic triads. The *S* region in m. 27 is likewise fully authentic to a *S* function – a lyrical area of relative repose – when the tensile chords discharge into a tranquil major seventh chord. However this is something of a thematic shift – the  $D \rightarrow C\#$  descending pattern comes into force here, adding the flavour of the ‘lyrical second subject’. As we will see, other functional shifts are far more subtle.

FIGURE 6-15: *VERS LA FLAMME*'S *S* REGION, MM. 27 FF

The return to the *D* region in m. 33 is also thematically parsimonious but tonally disjointed, the ‘dominant seventh’ flavour of the *D* region being re-established:

FIGURE 6-16: *VERS LA FLAMME*'S *S* REGION  $\rightarrow$  *D* REGIONAL SHIFT, MM. 32 FF

The central *T* region (mm. 47-54) explores various discharges around a central line of *T* drives on C (m. 47 ff). Again this change arises purely harmonically and is thematically seamless.

FIGURE 6-17: *VERS LA FLAMME*'S *T* REGION, MM. 46 FF

And future modulations occur in a likewise fashion: seamless and often resulting from purely harmonic axial shifts. The piece is notable for its ‘authenticity’ of tonal function; each function behaves in its characteristic way. The *T* and *S* regions are posited as traditional oases of relative stability; the *D* is the desire-laden region. It is striking that the piece closes on the *D*, though we must remember that this is not strictly true; *drive analysis* fails to account for the quartal harmony that the piece dissolves into. It

would seem that Skryabin's tonal message is this: *despite the D's early attraction to the T, the T can no longer act as a repository for D tensions; desire cannot be slaked, merely obfuscated.* But the dissolution of tonal argument and its replacement by 'atonal' (quartal) symbolism is teleological in itself. This work, despite its 'search and return' of the *D* function (see Skryabin's later comments in Chapter 7), is linear, rather than cyclic. It has a definite tonal goal.

## Disjunction of Philosophy and Music: A Way Out?

However far one proceeds with analysis of the work's symbolism, a marked disjunction remains between Skryabin's philosophical model of evolution and his musical dialogue. Again one is drawn back to the question of the circle and the line. Skryabin was famously forced to modify his own evolutionary doctrines due to the attraction of Blavatsky's circular models of cosmic evolution – *Manvantara* and *Pralaya*.<sup>459</sup> Yet *Vers la Flamme* ends with a total transfiguration of the *chora* into pure drive-free symbolisation. This contrasts with the sonatas which generally return to a restatement of their opening gambit in the final measures – a cyclic process. The substitution results in teleological progression. To understand this one needs to follow Skryabin's inheritance of a different model of evolution based on linear, though similarly dialectical, progression. To locate the source of this confusion, I explore another impetus to his philosophy – the Hegelian dialectic. Hegel posited an evolutionary progression that contained dialectic cycles that marched towards *the Absolute* – truth. Skryabin absorbed Hegel's dialectic somewhat elliptically through the filter of dialectical materialism. The following chapter will examine (a) Skryabin's adoption of the Hegelian dialectic and (b) its sublimation into the evolutionary structure of his works, as revealed in his big Hegelian work – *The Poem of Ecstasy*.

---

<sup>459</sup> Schloezer, *Scriabin: Artist and Mystic*, 215.

## Chapter Seven

---

### A Hegelian Model of Desire and The Poem of Ecstasy

*Peoples! Blossom forth, create, negate me and rise up against me. I resurrect all you terrors of the past, all monsters and frightful horrible visions. I give you full flower. Try swallowing me up! Lay open your dragons' pasture. Serpents! Twine round me, strangle me, and bite. Everyone and everything seeks my destruction and when you fall upon me, that is when I begin my play. I will conquer you by loving you. I will surrender and seduce you.<sup>460</sup>*

*Alexander Skryabin, on the Seventh Sonata*

#### The Poem of Ecstasy: The Text and its Dialectic

*Poème Orgiaque* began life in Beatenberg in the summer of 1907 and was completed the following year. Skryabin's 'fourth symphony' was originally planned as a standard four-movement work in his 1905 Italian notebook, but was compressed into a single movement and renamed *The Poem of Ecstasy*. Skryabin's own poetry, though predating its musical counterpart, is designed to escort it. Whilst Skryabin decided that conductors should be unaware of his poetic endeavours, approaching the work as 'pure music', he issued audiences with a pamphlet containing his text.<sup>461</sup> Weighed against other post-1904 pieces in which, most commentators agree, Skryabin emulated the development of consciousness, critical responses to this piece's narrative structure are more guarded. The third Symphony – *The Divine Poem* – which Skryabin termed a "short exposition of my doctrine", follows the fortunes of the "I" theme through *Struggles* (the first movement), *Voluptuousness* (the second) and *Divine Play* (the third), in which "The spirit is now released from its former ties of submission to a higher force."<sup>462</sup> Supposedly dictated by Skryabin, a programme was drafted by Tatiana de Schloezer:

The Divine poem represents the evolution of the human spirit which, freed from the legends and mysteries of the past which it has surmounted and overthrown, passes through pantheism and achieves a joyful and exhilarating affirmation of its liberty and its unity with the universe.<sup>463</sup>

Critics tirelessly confirmed this interpretation. Leonid Sabaneyev, one of the earliest, described the work as a "colossal biography of Scriabin's creative soul ... a picture of his cosmic plan."<sup>464</sup> The fifth symphony, *Prometheus*, is also said to chart the 'dawn of human consciousness', but commentaries on

---

<sup>460</sup> Bowers, *Scriabin: A Biography* 2, 60.

<sup>461</sup> *Ibid.*, 180.

<sup>462</sup> *Ibid.*, 341.

<sup>463</sup> Bernard Jakobson, 'Scriabin Symphonies 1,2,3, Le Poème De L'extase, Promethee (CD-7243 5 67720 2 1), (2001), 8.

<sup>464</sup> Bowers, *Scriabin: A Biography* 1, 339.

*The Poem of Ecstasy's* narrative suffer serious imprecision.<sup>465</sup> The casualty is doubtless caused by the chasm between poem and music, which is not bridged as strongly as one would expect.

I begin this inquiry with the poem, which is unquestionably about creation. The influence of Fichte is palpably clear; a solipsistic Spirit flies the earth, constructing its own world of forms and feelings.<sup>466</sup> Only in its final throes, when the Spirit unites with the horrors it created in an overtly sexual orgasm, can it come to rest and the *Poem of Ecstasy* conclude. Notwithstanding the evident impact of Fichte, as well as Nietzsche and Schopenhauer, the poem's structure calls for Hegelian inquiry. The Spirit (Hegel's *Geist*), creates "on the summit of negation", but remains discontented with its products and conceives new and novel experiences (as in Schopenhauer's philosophy).

ALAS!  
IT HAS ATTAINED ITS PURPOSE.  
It longs for past struggle.  
Instantly it feels  
Boredom, melancholy and emptiness.

No disturbing rhythm  
Overshadows Thee,  
No dreadful phantoms  
Haunt.  
Only monotony's infecting poison,  
The maggot of satiety  
Devours feeling<sup>467</sup>

The bored spirit creates 'negative' images in an attempt to annihilate itself

But Suddenly ...  
Trembling presentiments  
Of dark rhythm  
Break rudely into  
This enchanted world

With light ...  
Of divine Will  
It dispels  
Frightening phantoms.

Skryabin's profuse references to Hegelian negation become garishly over-explicit:

<sup>465</sup> See Hull, *Scriabin: A Great Russian Tone-Poet*, 193-194; Rosa Newmarch, *The Concert-Goer's Library of Descriptive Notes* Vol. 2 (Humphrey Milford: London, 1928), 61-65.

<sup>466</sup> The most solipsistic of the German Idealists, Fichte ascribed the highest level of creative subjectivity to the individual.

<sup>467</sup> Alexander Scriabin, '*Poem of Ecstasy*' and '*Prometheus: Poem of Fire*' in *Full Score* (New York: Dover Publications, Inc., 1995).

Strike against me,  
Negate your love!

Your moments each by each  
I create by negation  
Of earlier experience.  
I am forever negation.

These terrifying encounters intensify,

From mysterious wombs  
The spirit confused  
A fearless host  
Of strange terrors  
Rises Stormily...

Yawning caverns  
Of monster mouths  
Flash menacingly

In conquering such obstructions (a Nietzschean 'overcoming?')<sup>468</sup> the Spirit attains more durable satisfaction. But it is not until the final 'ecstasy' that an overtly erotic blend of pain and pleasure herald a highly effective, if somewhat sadomasochistic, synthesis.

Then I will plunge  
With a horde of fearsome monsters  
With savage torment and terror  
I will crawl upon you with verminous nests of snakes  
And I will bite and choke you!  
And you will want me  
More madly, more passionately...

That which menaced  
Is now seduction.  
That which frightened  
Is now pleasure.  
And the bites of the panther and hyena  
Are new caresses  
And the serpent's sting  
Is but a burning kiss.

And thus the universe resounds  
With joyful cry  
I AM!

Despite the colossal fusion of philosophical ideas, the poem's structure is fairly basic. However, its musical counterpart is a more bothersome parcel to unwrap. Skryabin composed the music with a

---

<sup>468</sup> Mitchell Bryan Morris examines this strain of Nietzschean philosophy in Skryabin's ideology. Morris, *Musical Eroticism and the Transcendent Strain: The Works of Alexander Skryabin, 1898-1908*.

certain detachment from the poem and was famously delighted when he retrospectively glanced through the score and discovered similarities. Schloezer notes, “Scriabin and I worked together comparing text and music. I remember the pleasure and surprise he felt when the music was fully free yet followed the development of the text . . .”<sup>469</sup> Yet despite the refrain-like moments of negation in the text when the Spirit conjures up images of horror, the symphony contains no such ‘terror’. Such disjunctions between the two mediums will be explored through this chapter. Firstly, however, I wish to investigate Skryabin’s absorption of Hegelian philosophy, recalling too that, writing in the 21<sup>st</sup> century, we benefit from modern writings on desire that are based on Hegelian logic.

One point of entry of Hegel into musicology was via the Germanic tradition of Adorno and Dahlhaus. But various less well-known Russian strands of this Hegelian thread are in abundance. Boris Asafiev is noted for his view of ‘form as process’.<sup>470</sup> In this regard, the Russian word for ‘structure’ – *stroenie* – also implies an unending process as Khannanov shows.<sup>471</sup> And thus Russian discussions of ‘form’ and ‘structure’ betray an element of mobility. This tradition was also found in the work of analyst Igor Sposobin who similarly based his work on Gregory Catoire’s 1934 adoption of Riemannian functional theory. But for Skryabin, a more holistic approach was intended; he describes the tonal progression through various states, outlining the descent from *spirit* into *matter*.

There is a constant progression from *spiritual* keys – which symbolise the primary, spiritual, undifferentiated being and the state preceding the act of creation – towards *material* keys, which represent the impress of spirit onto matter.<sup>472</sup>

Skryabin here describes *Prometheus*, but similar procedures pertain to the earlier *Poem of Ecstasy*.

## Skryabin’s New Direction: Absorption of Hegel Through a Dialectical Materialist Filter

We generally subordinate Skryabin’s philosophical universe to the cosmological ‘hocus pocus’ of Blavatskian Theosophy, inwardly refracted through a solipsistic lens. This misprision doubtless reflects our own thirst for the bizarre, and we must not neglect the ‘highbrow’ philosophers that Skryabin took to heart, nor must we discount Blavatsky’s own virtuosity in appropriating these sources into *The Secret Doctrine*. Despite Blavatsky’s public vilification,<sup>473</sup> the *Secret Doctrine* is still a work of unparalleled eclecticism, in which Hegelian philosophy is lovingly nurtured. Blavatsky’s version of Hegel would be

<sup>469</sup> Bowers, *Scriabin: A Biography* 2, 131.

<sup>470</sup> The Germanic equivalent of this view was adopted by Adorno and Dahlhaus, examined in Janet Schmalfeldt, ‘Form as the Process of Becoming: The Beethoven-Hegelian Tradition and ‘Tempest’ Sonata’, *Beethoven Forum* 4 (1995), 37-71.

<sup>471</sup> Khannanov, *Russian Methodology of Musical Form and Analysis*, 56-58.

<sup>472</sup> «У меня там ход все время от тональностей духовных, которые соответствуют первичному духовному неразделенному бытию, состоянию дотворческой неразделенности, к тональностям материальным, которые соответствуют впечатлению духа на материи.» Sabaneyev, *Vospominaniya O Skryabine*, 123.

<sup>473</sup> After various exposures of Blavatsky’s deceptions in the American press, she fled from New York to India in 1878.

another source for Skryabin. Notwithstanding the more conspicuous Schopenhauerian influence upon the late 19<sup>th</sup> century aesthetics of desire, modern psychoanalytic desire theories stem from the same source as Skryabin – Hegel’s *Phenomenology of the Spirit*.

Hegel’s *Phenomenology* registers the emergence of self-consciousness and, confusing though his terminology is, must have stirred the composer deeply. It is tricky to isolate Skryabin’s discovery of Hegel; one cannot pinpoint a particular date as with the Schopenhauer or Fichte breakthroughs.<sup>474</sup> Although Hegel fronted the *German Idealist* movement that bled into *Russian Symbolism* through Novalis, he was influential less to the artistically minded than the politically orientated ‘Young Hegelians’. The ‘Silver age’ incorporated Neo-Kantians, Nietzscheans, Schopenhauerians (popularised through Wagner), and Fichteans. Skryabin, in this sense, was an anomaly. Given his intimate friendship with Georgy Plekhanov – coiner of the phrase ‘dialectical materialism’, Lenin’s ‘right-hand man’ and “The Father of Russian Marxism” – it would have been difficult to spend the long summer evenings in Bogliasco in 1905 furiously arguing politics without receiving a Hegelian education.<sup>475</sup> Plekhanov had published a short pamphlet on *The Meaning of Hegel* (1891), containing ideas that would certainly filter into their extensive discussions. Under the pseudonym of Beltov he also presented an inscribed copy of *The Development of a Monist view of History* to Skryabin, which the composer owned until his death.<sup>476</sup> Whilst Skryabin remained profoundly mystical, he greatly respected Plekhanov’s ideas and claimed to link his creativity to the revolution.<sup>477</sup> Denounced as a ‘mystic’ who believed firmly in Fichtean ‘mind over matter’, Skryabin also held allegiance to Ludwig Feuerbach, Hegel, and Marx *et al* and found himself at the meeting point of Hegel’s two ‘off shoots’, the ‘idealists’ and the ‘materialists’.

Hegel probably suffered rejection from such highly eroticised Russian *Romantics* because he betrays, in Plekhanov’s words, “no mysticism of the ‘Unknown’ whatever.”<sup>478</sup> Whilst this was relished by Plekhanov, it was doubtless lamented by Russian Symbolism. Plekhanov further disapproved of Skryabin’s Idealism: “The most bewitching ideals can be constructed; with its [Idealism’s] help, the boldest journeys “into a better world” can be undertaken without bothering for a moment about realizing these “ideals” in reality. What could be better? “Ideally,” one can, for instance, abolish entirely the existence of classes, eliminate exploitation of one class by another, and yet in reality come forward

---

<sup>474</sup> Skryabin read *World as Will and Idea* in 1893 at the same time as he discovered Ernest Renan, probably at the home of Vladimir Tanayev, the alcoholic brother of the composer Sergey Tanayev, in whose library Skryabin seems to have made himself particularly at home.

<sup>475</sup> Professor Samuel Baron’s English-Biography of Plekhanov refers to him in these terms, as shown by Bowers in *Scriabin: A Biography* 2, 91.

<sup>476</sup> George Plekhanov, ‘The Meaning of Hegel’, *Fourth International* 10/April and May (1949).

<http://www.marxists.org/archive/plekhanov/1891/11/hegel-dun.htm>. Plekhanov wrote under the pseudonym of Beltov.

<sup>477</sup> Bowers, *Scriabin: A Biography* 2, 93.

<sup>478</sup> Plekhanov, ‘The Meaning of Hegel’.



as a defender of the class state, and the like.”<sup>479</sup> Plekhanov’s system was based on the Hegelian dialectic, now placed in a ‘material’ framework. As Marx put it, “To Hegel, the life process of the human brain, i.e., the process of thinking, which, under the name of the Idea, he even transforms into an independent subject, is the *demiurgos* of the real world, and the real world is only the external, phenomenal form of ‘the Idea.’ With me, on the contrary, the ideal is nothing else than the material world reflected by the human mind, and translated into forms of thought.”<sup>480</sup> Plekhanov claims to have appropriated dialectics for modern materialism by removing all traces of mysticism from the German Idealists. Naturally Skryabin would have disapproved.

Schloezer, a professor of philosophy, asserts that Skryabin understood dialectical argument with utmost clarity; he was an “adroit dialectician”.<sup>481</sup> But the absorption of the dialectic was inconsistent across the Russian intelligentsia. Unlike the rigorous ‘Young Hegelians’, the mystical Russian Symbolist poets seem to reduce the dialectic to an elementary structure of *thesis / antithesis / synthesis*. Skryabin’s ready guide to Western philosophy was Friedrich Überweg’s *History of Philosophy*, which unpacks Fichte’s theories via this crude model, as Morris suggests.<sup>482</sup> Ivanov’s famous speech in 1910, preaching the end of Russian symbolism, highlighted this, in which he uses these terms strictly.<sup>483</sup> Ivanov does conceive of the *synthesis* as a ‘new simplicity’, showing some Hegelian insight, but nonetheless, there was a distinct reduction of the dialectical method amongst the artistic side of Russian life. Plekhanov thoroughly disapproved, speaking of this misperceived ‘triad’: “it does not at all play in Hegel’s work the part which is attributed to it by people who have not the least idea of the philosophy of that thinker.”<sup>484</sup> The dialectic is not an oration technique; it is Hegel’s evolutionary drama, and this is the major contact point for the more eclectically influenced Skryabin.

---

<sup>479</sup> Ibid.

<sup>480</sup> Karl Marx, *Capital* (London: Lawrence & Wishart, 1956-59, 1977), 25.

<sup>481</sup> Schloezer, *Scriabin: Artist and Mystic*, 61.

<sup>482</sup> Morris, *Musical Eroticism and the Transcendent Strain: The Works of Alexander Skryabin, 1898-1908*, 232.

<sup>483</sup> The thrust of which is given by Avril Pyman. Pyman, *A History of Russian Symbolism*, 333.

<sup>484</sup> P Georgy Valentinovich Plekhanov, *Fundamental Problems of Marxism* (London: Lawrence & Wishart, 1969), 79-80.

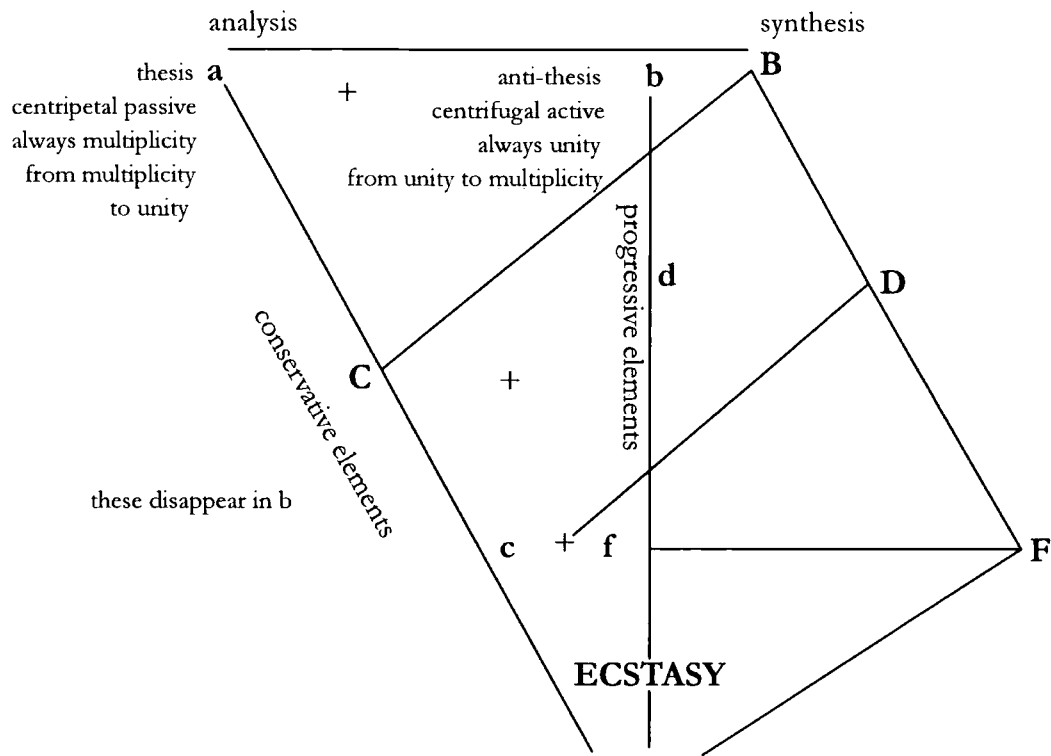

FIGURE 7-1: SKRYABIN'S DIALECTICAL MODEL OF ECSTASY

Skryabin sometimes laid out his ideas in graphical format, showing a much clearer acceptance of Hegel's philosophy than his artistic contemporaries. Some of these diagrams display decidedly dialectical models. In figure 7-1, negativity is classed as a centrifugal force, pushing away from the centre, a masculine, progressive element. Skryabin describes this difference: "I myself am that which is opposite to me, because I am only that which I engender ... The world is an impulse towards God. I am an impulse towards myself".<sup>485</sup> The synthetic stage lies beyond these, and, with the other two lines, leads towards ecstasy.<sup>486</sup> This probably derives from Schelling's *ekstasis*, which was an access point to the *Absolute*.<sup>487</sup> Although Novalis reproached Fichte for not making ecstasy the basis of his philosophical system, Fichte did see the union of the 'I' and 'Not-I' as sexual, and he too was a great influence of the impressionable Skryabin.<sup>488</sup> And ecstasy for Skryabin is also "the highest synthesis ... the highest development ... Generally, ecstasy is the summit, the last moment which comprehends the whole history of humanity."<sup>489</sup> Skryabin's model of Absolute Unity shows a similar dialectic pattern.

<sup>485</sup> Martin Cooper, 'Scriabin's Mystical Beliefs', *Music & Letters* 16/2 (1935).

<sup>486</sup> Bowers, *Scriabin: A Biography* 2, 67.

<sup>487</sup> Andrew Bowie, *Schelling and Modern European Philosophy: An Introduction* (London: Routledge, 1993), 134. Like Lacan, Schelling saw the *Absolute* as form of the *lost Real*, 140.

<sup>488</sup> Friedrichsmeyer, *The Androgyne in Early German Romanticism: Friedrich Schlegel, Novalis and the Metaphysics of Love*, 151.

<sup>489</sup> From Skryabin's 1908 notebooks; Garcia, *Alexander Skryabin and Russian Symbolism: Plot and Symbols in the Late Piano Sonatas*.

## ABSOLUTE UNITY

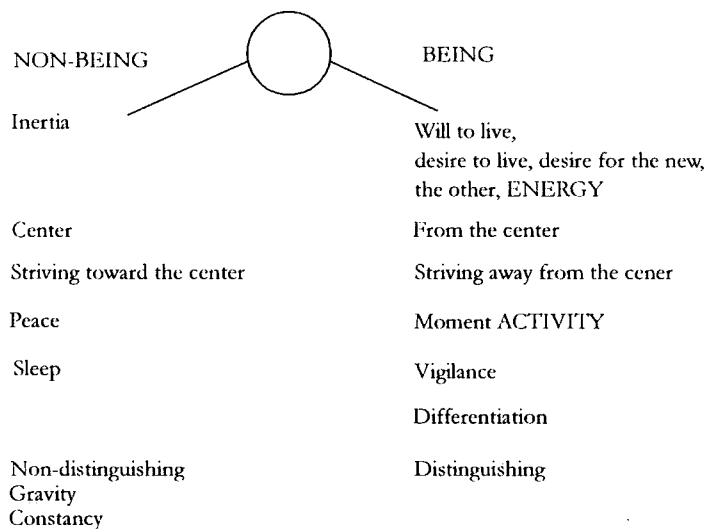

FIGURE 7-2: SKRYABIN'S MODEL OF ABSOLUTE UNITY

Plekhanov attributed tremendous importance to Hegel for establishing a discourse of processes (*Des Werdens*). Life and death are links in the great chain of 'becoming':

And in the process of becoming there are two sides: birth and dying out. These two sides can be looked upon as separated in time. But just as in nature, so especially in history, the process of becoming is, at each given period, a twofold process: the old is dying out and from its ruins simultaneously the new is being born.<sup>490</sup>

Skryabin's own diaries reveal an acceptance of this doctrine, "Direct experience does not present a dead content, but a conjunction or series of processes. It is not composed of objects but of processes."<sup>491</sup>

Plekhanov thoroughly disapproved of Darwinian evolutionary accounts: "...the vulgar theory of evolution ... is based completely on the principle that neither Nature nor history proceeds in leaps and that all changes in the world take place by degrees. Hegel had already shown that, understood in such a way, the doctrine of development was unsound and ridiculous."<sup>492</sup> Skryabin was almost certainly subjected to lectures on this model from Plekhanov, and this doubtless intensified the miasma of his masculine / feminine cosmogentic evolutionary models. The dialectical materialists believed in creation through dialectical negation, structured by 'leaps'. Oppositional forces at every level of nature contained charges of energy that built up enough tension to generate sudden bursts. Such is the birth of human consciousness; the unconscious subject gains enough dialectical energy to break out into a conscious state. This energetic flow is pertinent to the text under discussion. *The Poem of Ecstasy* itself

<sup>490</sup> Plekhanov, 'The Meaning of Hegel'.

<sup>491</sup> Bowers, *Scriabin: A Biography* 2, 56.

<sup>492</sup> Plekhanov, *Fundamental Problems of Marxism*, 45.

approaches self-consciousness through the negating tendencies of the poem's structure. As the self-generated polarisation intensifies, the Spirit becomes self-conscious; it understands its own desiring mechanism. The third person narrative has already described 'drive' structures in their aimless, libidinal flux. Although the word 'desire' is used ("Spirit Desiring"), this is redefined as "thirst for life" and its aimlessness is exposed as a drive economy in the following phrases: "unmindful of goals", "endless change", "purposeless, godlike flight", and "pure aimlessness". But the Spirit now understands its own libidinal current;

It [spirit] knows that  
Which desired struggles

It desired only,  
And events  
Assembled round  
This wish  
In harmonious order.

Reference to the 'assemblage' of desire is a particularly Deleuzian concept, showing an acknowledgement that the objects of desire are misrecognitions of the drive energy beneath them.<sup>493</sup> And the Spirit comprehends this itself; it becomes its own psychoanalyst.

Spirit lifts into flight  
To the kingdoms of grief and suffering  
And in its return  
To the world of dream and of excitement  
It comprehended miraculously  
The idea of evil's  
Mysterious abysses.

The same is shown in Skryabin's original plan for the symphony that had sections entitled, "knowledge of aimlessness, purposelessness" and "consciousness of the world as appearances."<sup>494</sup>

The dialectical model of evolution corresponds to our Blavatskian/Kristevan (feminine) paradigm, as each of these leaps is caused by accumulating internal energy. Skryabin appreciates this, the whole scene occurring within the solipsistic mind: "There, under the rays of its dream, Emerges a magical world". Also particular to the dialectical materialist model is that the accruing tension affects a transformation of quantity (multiplicity) into quality. Again this originates in Hegel and filters into Skryabin's ideology:

---

<sup>493</sup> For Deleuze, desire, as driven by the machinery of the unconscious, is not propelled by the need for an object; rather, it aims to create an assemblage (*agencement*) comprised of the processes of its own production. See *Anti-Oedipus*, Chapter one: *The Desiring-Machines*, 1-57.

<sup>494</sup> Bowers, *Scriabin: A Biography 2*, 127.

Hegel said that quantity, growing indefinitely, transcends into quality. Scriabin frequently quoted this dictum during our discussions on philosophical subjects to vindicate his theory of ‘catastrophism’. It was for him not only a theoretical postulate, but a manifestation of inner experience. He felt in his own being how this tremendous tension continued to increase until it suddenly brought forth a new state qualitatively different from the preceding. Projecting his inner experience outwardly, he speculated that the entire history of the world also obeyed this evolutionary process of gradual accumulation and growth, that upon reaching a degree of saturation, must terminate in a world catastrophe, leading in turn to a new evolution, a new increase in tension, and a new crisis. Scriabin associated this philosophy of life with the specific structure of his individual works, which to him represented a series of gradual expansions, systematically and logically evolving in the direction of a final ecstasy. Indeed all Scriabin’s works, beginning with the Third Piano Sonata and ending with the Tenth Piano Sonata are built according to a uniform succession of states – languor, longing, impetuous striving, dance, ecstasy, and transfiguration. This outline is basically simple; it is built on a series of upswings, with each successive wave rising higher and higher toward a final effort, liberation and ecstasy.<sup>495</sup>

Kristeva casts this dialectical materialist formula in the light of Hegelian negativity. By discussing the production of symbols through leaps, again linking cosmological evolution and ego formation like Blavatsky, she brings us back to semiotics.

Furthermore a materialist reading of Hegel allows us to think of this negativity as a trans-subjective, trans-ideal and trans-symbolic movement found in the separation of matter, one of the preconditions of symbolicity, which generates the symbol as if through a leap – but never merges with it or its supposed homologue.<sup>496</sup>

She also formulates desire from this movement, claiming, “Desire is the moment that leaps over the boundaries of the pleasure principle.”<sup>497</sup> Thus the dialectical materialist model of progress via negation, through Kristeva, correlates to the drive / desire trajectory. In this semiotic vein, Blavatsky also saw pure *force* and *motion* flowing into the symbolic realm: “it is motion which begets the Logos, the Word in Occultism.” Blavatsky also draws on Hegel’s ‘instinct’:

The history of the world begins with this general aim,” says Hegel; “the realization of the Idea of Spirit – only in an implicit form (an *sich*), that is as nature; a hidden, most profoundly hidden unconscious instinct, and the whole process of history ... is directed to making an unconscious impulse a conscious one.”<sup>498</sup>

And Kristeva also locates Hegel’s notion of Force at the centre of the *chora*. She suggests that when Hegel is at his most material he comes “closest to what we have called a semiotic *chora* (energy discharges and their functioning) – in other words when it appears as Force.”<sup>499</sup> Distinguishing between *negativity* and *negation*, Kristeva accepts Lenin’s categorisation of *negativity* as the ‘fourth term of

<sup>495</sup> Schloezer, *Scriabin: Artist and Mystic*, 96-97.

<sup>496</sup> Kristeva, *Revolution in Poetic Language*, 117.

<sup>497</sup> *Ibid.*, 131.

<sup>498</sup> Helena Petrovna Blavatsky, *The Secret Doctrine: The Synthesis of Science, Religion and Philosophy*, 640.

<sup>499</sup> Kristeva, *Revolution in Poetic Language*, 114.

the dialectic'.<sup>500</sup> To her, *negativity* focuses on the *becoming* of the negation, the *transition*, or as Lenin put it, the *emergence*. This is redolent of the dialectical materialist ideology that Skryabin was so steeped in. Furthermore Kristeva equates 'negativity' with Hegel's concept of 'Force',<sup>501</sup> drawing us back into Freud's theory of the drives. On the reappraisal of 'negativity', she says, "What made its material overturning possible, in our view, was the key notion of drives in Freudian theory."<sup>502</sup> She prefers to use the concepts of *scission*, *expenditure*, *separation*, *division* and *rejection* as the defining moments of ego-formation.<sup>503</sup> Particularly in the latter, where a baby begins to *reject* its waste products and thus form a distinction between *inner* and *outer*, Kristeva claims that, on the borders of the *chora*, "Freud places the drive of rejection."<sup>504</sup> The notion of Hegel's *negativity* therefore found its fullest representation in Freud's *rejection*. In addition, Kristeva helpfully discriminates between the two poles that Skryabin was caught between – the 'materialist notion of force' and the 'idealist notion of force' – the former is the semiotic functioning of matter *in itself*, and the latter is found when "the reality of force is ultimately the thought of it."<sup>505</sup>

Thus I turn for the final time to Skryabin's music where evolutionary schemes become dialectical. But unlike the materialist 'Young Hegelians', Skryabin's Idealist philosophy returned the *Geist* to Hegel. If *Vers la Flamme* showed how voracious musical drives can evolve organically and seamlessly, the *Poem of Ecstasy* demonstrates how 'dialectical leaps' more frequently structure their progress towards a focus of desire.

### Negative Thematic Evolution: Theme D and the 'Struggle for Recognition'

In the *Phenomenology*, Hegel describes the pre-conscious life of the absolute subject as a 'state of nature', a state of war and conflict. In *Lectures on Aesthetics* the Homeric heroes epitomize this condition; passive and un-self-reflective, they act involuntarily, obeying only the imperatives of their primordial drives. This pre-social, pre-legal, pre-conscious position is unsustainable and is channelled through a 'struggle for recognition' – a struggle for social determination.<sup>506</sup> What smacks of Skryabin in my reading of Hegel is the view of this preternatural stillness as a place of conflict. To Skryabin, every impulse is born from polarity; after discussing how "an impulse disturbs celestial harmony", he concludes, "How beautiful the vitality of your aspirations, and how wrong you are if you wish to destroy the opposition which gave them birth."<sup>507</sup>

<sup>500</sup> Ibid., 110.

<sup>501</sup> Ibid., 114.

<sup>502</sup> Ibid., 116.

<sup>503</sup> Ibid., 147.

<sup>504</sup> Ibid., 123.

<sup>505</sup> Ibid., 115.

<sup>506</sup> Tony Burns, *The Iliad and the 'Struggle for Recognition' in Hegel's Phenomenology of Spirit* (University of Nottingham).

<sup>507</sup> Bowers, *Scriabin: A Biography* 2, 62.

The *Poem of Ecstasy* has supplied a forum for lurid interpretation in past criticism, often taking the form of leitmotiv analysis. Corresponding to the Seventh sonata, such leitmotifs are catalogued by Bowers: descending half-steps apparently represent “human sorrow”; rising and falling whole-tone steps embody the “breathing in and out of Brahma”; the sighing minor ninth corresponds to the “descent of spirit into matter”.<sup>508</sup> More informative sobriquets were applied by Hull, including: the “Ego theme gradually realising itself”; “human striving after the ideal” (the opening melody); “soaring flight of the spirit” (*Allegro volando*); “will to rise up” (the famous trumpet theme).<sup>509</sup> These clichés congregate around each of Skryabin’s masterworks, but they at least demonstrate that commentators believe the thematic structure to be a developing ‘ego’, a *becoming subject*. Hull’s word ‘ego’, doubtless inspired by English translations of the Freudian ‘Ich’ or Skryabin’s oft-mentioned “Ya” (simply “I”), appeals to the emerging, contemporary discipline of psychoanalysis. Here we remember some of Leonid Sabaneyev’s earliest memories about Skryabin: “he [Skryabin] was writing a ‘philosophical symphony’ in which the sounds embodied the development of the world-soul, which comes into ‘self-affirmation.’”<sup>510</sup>

James Baker convincingly surveys the *Poem of Ecstasy*’s thematic structure.<sup>511</sup> Following the Lisztian transformations of what he terms “Theme D”, he leads us through each presentation in turn.

Unfortunately, despite Baker’s analytical insight he retreats to mystical cliché: “The result in the music is a sensuously undulating form which projects the erotic aspect of the soul’s striving for union with the Divine Principle.”<sup>512</sup>

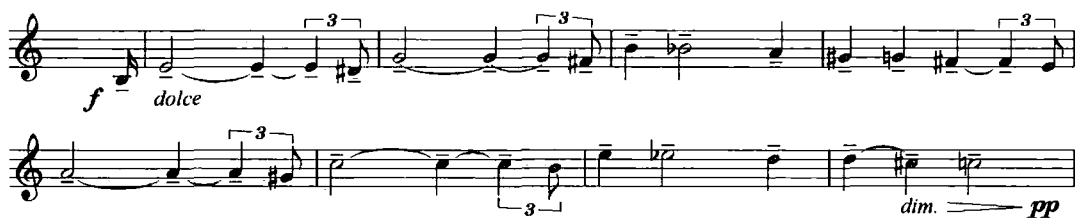

FIGURE 7-3: POEM OF ECSTASY, “THEME D”

Baker’s thematic taxonomy lists seven instances of the theme. Unlike the thematic transformational procedures of Berlioz and Liszt, this investigation underscores simple alteration through procedures of extension and addition.<sup>513</sup> Monitoring the procession of themes, he ignores their innate tensions, their consequences and implications. Despite its failings however, his analysis is at least mindful of

<sup>508</sup> Bowers, *The New Scriabin: Enigma and Answers*, 111.

<sup>509</sup> Hull, *Scriabin: A Great Russian Tone-Poet*, 189-191.

<sup>510</sup> «Он написал «философскую симфонию» ... и что в этой симфонии звуками изображается развитие мирового духа, который приходит к какому-то «самоутверждению»» Sabaneyev, *Vospominaniya O Skryabine*, 25.

<sup>511</sup> Whilst Baker’s most rigorous analysis is found in *The Music of Alexander Scriabin* (215-235), his article *Scriabin’s Music: Structure as Prism for Mystical Philosophy*, contains a more generally accessible synopsis. Baker, Beach and Bernard, *Music Theory in Concept and Practice*.

<sup>512</sup> *Ibid.*, 84.

<sup>513</sup> *Ibid.*, 84.

Skryabin's careful thematic development. This contrasts with Mitchell Bryan Morris's weak assertion that "What is not present is any possibility of a theme acquiring a sense of genuine evolutionary potential; they change less by development than by fragmentation and juxtaposition."<sup>514</sup> The framework for Baker's analysis is a dialogue of attempt *vs.* failure: a striving voice. Skryabin's heavily revised autograph shows numerous alterations to the trumpet part, highlighting its meticulous arrangement. At one juncture Skryabin penned, "Why, whither are you striving oh rebellious spirit?" above the trumpet stave.<sup>515</sup> An exploration of Theme D's arrival will answer Skryabin's question, leading to the conclusion that, like the human spirit, the answer is Hegel's 'recognition'. I now examine the music.

The axis of melodic symmetry – the pitch B – structures the opening flute melody, its outer boundaries marked as D# and G with chromatic inflection injecting a leading-note drive back to B.<sup>516</sup>



FIGURE 7-4: *POEM OF ECSTASY*, MM. 2-5

After an exact t5 transposition in m. 6, a modified t10 transposition on A $\flat$  appears in the piccolo in m. 11. Here the axis is raised when the A $\flat$  enharmonically shifts to a G#, rising to A $\sharp$ , intensifying the melodic drive towards chromatic ascent.

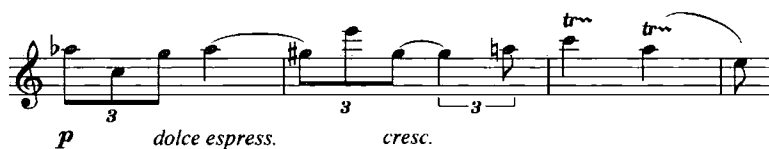

FIGURE 7-5. *POEM OF ECSTASY*, MM. 11-14

At this point the accented trumpets tender an antithetical force with dotted rhythms, and a IV  $\rightarrow$  V  $\rightarrow$  I melodic pattern (B  $\rightarrow$  C#  $\rightarrow$  F#) encircles the resulting pitch – a masculine tonal force?



FIGURE 7-6: *POEM OF ECSTASY*, MM. 13-19

<sup>514</sup>Morris, *Musical Eroticism and the Transcendent Strain: The Works of Alexander Skryabin, 1898-1908*, 287.

<sup>515</sup>Bowers, *Scriabin: A Biography 2*, 189.

<sup>516</sup>Meyer, *Explaining Music: Essays and Exploration*, 183. An axial melody is one, typically Russian, in which a single pitch acts as an axis around which all other pitches deviate from and return to.





fifth and semitone, they shape themselves through negation. Dramatised through orchestral fragmentation, these motivic elements crystallise around the trumpet as ‘theme D’ materializes. This trumpet theme is anything but novel. Taruskin describes how Skryabin casts “the solo trumpet as a Nietzschean protagonist to the point where symphony becomes a virtual concerto”<sup>518</sup>, but this ‘theme’ is merely the formalised product of malleable drive elements. Ascending and descending tendencies separate out, particularly in the *avec une noble et douce majesté* at m. 103 when sequential anacrusic fourth rise exclusively, and chromatic descents are compartmentalised into two measure sections.

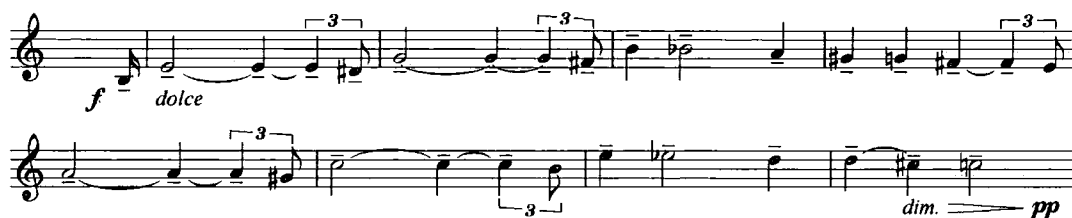

FIGURE 7-10: *POEM OF ECSTASY*, MM. 103-110

Baker’s analysis of ‘Theme D’ begins here. Because this theme pilots us to the grand finale, we accord with the prominence Baker bestows upon it. Yet it is merely a dialectically evolved façade – the *dispositif* – of the raging, conflicting tensions beneath. More than the single ‘ego’ theme that Hull found, this theme becomes representative of the psychoanalytic ego that is socially shaped and embeds the conflicts of the society that called it into being. The struggle for recognition is complete; a new struggle now emerges.

### Struggle for a Social, Stable Whole: The Unrolling of a Rugged, Diatonic Epilogue

For Hegel, the process of accepting an ethical social order is welcomed: “the leaving of the ‘state of nature’ and entering into ‘society’ may be seen as a move from a condition of conflict and war to one of peace and social order....”<sup>519</sup> Desire-gratification, for Hegel, makes one a slave; freedom is exclusive to socially balanced ethics in the guise of ‘the law’.<sup>520</sup> Society is thus the source of unity, balance and freedom. Tony Burns underscores this, “Hegel states explicitly there that the struggle for recognition can occur only in ‘the natural state’ where ‘men exist only as single, separate individuals’, and not in society, the organizational principle of which, as we have seen, is not conflict but social harmony based on an ethical consensus around shared values.”<sup>521</sup> Thus, once recognition is achieved, the struggle ceases and a new struggle for acceptance into society begins. Two internal melodic processes

<sup>518</sup> Taruskin, ‘Scriabin and the Superhuman: A Millennial Essay’, 58.

<sup>519</sup> Burns, *The Iliad and the ‘Struggle for Recognition’ in Hegel’s Phenomenology of Spirit* ([www.hlss.mmu.ac.uk/dev/wpt05/](http://www.hlss.mmu.ac.uk/dev/wpt05/) - accessed June 2005).

<sup>520</sup> *Ibid.*

<sup>521</sup> *Ibid.*

complement this socialisation: (1) the eradication of the unstable chromatic element and (2) a broader melodic search for tonal stability.

### (1) The Eradication of the Unstable Chromatic Element

Upon discovering its voice, Theme D plays out internal dialogues between the antiphonal elements that shaped it. The following manifestations of Theme D from the *Allegro* attempt to suppress its volatile chromaticisms through four successive presentations.



FIGURE 7-11: *POEM OF ECSTASY*, MM. 181-206

The interaction of chromaticism with ‘other’ elements (such as whole-tones) may help to clarify Morris’s awkward diagnosis that, “the majority of themes repeated frequently in *Le Poème de l’extase* are built out of chromatically inflected segments of the whole tone scale.”<sup>522</sup> Only the initial statement suffers chromatic descent; the second plateaus on a lofty  $A\flat$  – the most sustained tone so far. The following phrase peaks at a curt  $F\flat$  and contains no chromatics despite the small descents that creep into the orchestra. Subsequently, an abrupt quaver  $E\flat \rightarrow D$  gesture suppresses chromaticism further. A fourth and final presentation pinnacles on an  $A\flat$  – the upper octave of the initiatory pitch – before reaching a second plateau of  $C\flat$ . This strong ascent is redoubled as the brassy sound of the triplet rhythms interrupts at m. 207 (rehearsal fig.10).

But, as usual, when a drive is at its peak, an opposing tendency undercuts it. The succeeding passage challenges the security of the trumpet, responding with the descending seventh of the trombones’ *Tragico*. This is the thematic nadir of the work, a passage of utter disintegration.



FIGURE 7-12: *POEM OF ECSTASY*, MM. 213-216

<sup>522</sup> Morris, *Musical Eroticism and the Transcendent Strain: The Works of Alexander Scriabin, 1898-1908*, 274.

Approaching the development, the theme reconstitutes itself from these negated fragments: the melody extends itself through successive presentations; the chromatic descents seep into the cracks between phrases but each plateau is more sustained than the last; at mm. 277 (rehearsal fig. 17), a soaring 'A' pervades for four measures before the chromatic descent inflects it. And fast-forwarding to the final cataclysmic cadence, the trumpet is the guiding force. It is surely no coincidence that it leaps to its climax whilst most of the orchestra chromatically resolves.



FIGURE 7-13: *POEM OF ECSTASY*, MM. 595-605

But prior to this, chromaticism becomes thematically significant to the orchestral accompaniment as the trumpet effectively casts its chromatic voice into the orchestra, leaving itself purged; it projects its tensions back onto the orchestra that called it forth, thus 'othering itself' – a form of negation. In the final sweep, chromatic descents in the flutes outweigh the trumpet's fifths. At fig. 30 a typical presentation of Theme D is replete with rising fourths and chromatic descent, but the voluptuous *charme* section interrupts the flow at m. 477 (rehearsal fig. 31).



FIGURE 7-14: *POEM OF ECSTASY*, MM. 477-478

This section is poignantly labelled 'charming', but has a more profound function than to charm us.<sup>523</sup> Passionate chromatic 'third' flute descents, combined with trills, play on the feminine, seductive element. This emboldened force of negation forces the trumpet to re-evaluate itself. Again the *charme* appears at m. 507 (rehearsal fig.34) at the dawn of the *avec une volupte de plus en plus extatique*. The clarinet here counterpoints its own rising fifth, reminding us of the struggle.



FIGURE 7-15. *POEM OF ECSTASY*, MM. 507-508

<sup>523</sup> Hull, *Scriabin: A Great Russian Tone-Poet*, 191.

The intensification of motivic polarity increases towards the end of the work. Approaching the finale a highly significant point of conflict is announced. The trumpet initiates a contrapuntal version of the triplet motive, which was one of the primary origins of Theme D. The other members of the orchestra, notably the horns that constantly manage to avoid chromatically descending, carry Theme D itself. The end of the symphony is signalled; chromaticism has been flushed out. Its last remnants occur in the chromatic D# of the penultimate chord of the work.

## (2) The Melodic Search for Tonal Stability

Although Baker's thematic analysis is the most rigorous to date, Hull's 1918 brief summary is somehow more insightful as it correlates the theme with its harmonic trajectory. He described how the "trumpet subject becomes broader, and assumes great majesty, until it finally unrolls itself in a rugged and diatonic epilogue of immense power and triumphant grandeur."<sup>524</sup> In this presentation from m. 269 (rehearsal fig. 16) a sudden turn at the end of the rising fourths leaps via a sixth from B to G, descending in whole-tone steps rather than chromatics.



FIGURE 7-16: *POEM OF ECSTASY*, MM. 269-272

Harmonically this descent from G to Eb is accompanied by a plagal cadence (Eb → Ab) over an Ab pedal. The melodic *drive* activity begins to approach tonal *desire* once again. In a similar vein, when it first arose, Theme D was preceded by a triplet motive outlining IV → V → I, and this is what the trumpet theme recedes to here (A → B → E).



FIGURE 7-17: *POEM OF ECSTASY*, MM. 307-312

The triplet motive, with its strong tonal associations, often accompanies the approach of an object of desire. In the final sweep, the triplet motive becomes firmly triadic, initially demarcating a D minor triad.

<sup>524</sup> Ibid.



FIGURE 7-18: *POEM OF ECSTASY*, MM. 546 - 553

At m. 585 these triplets are commuted to the harp's F major arpeggios. Thus melodic aspects become harmonic, eventually merging into a blazing C major triad at the culmination point of the piece.<sup>525</sup>

In summary then, thematic development is concentrated into the trumpet's theme. The tensions between the motivic drives continue to exert pressure after they have created Theme D, now intensifying within the theme itself. The trumpet tries to eradicate the chromatic descent and places it back into the orchestra. The climax of the work occurs 'outside' the trumpet's Theme D, the theme itself being absent from the final climax from mm. 585 (rehearsal fig.41). The conflicting motivic drive tensions become weakened in preparation for the moment of ecstasy. The struggle for a stable social whole is complete.

### Harmonic Tension, Cycles and Dialectic Leaps

Just as cyclicity saturates Skryabin's text, so it saturates his music. This was a concern of Chapter 4, but cyclic progressions operate in a dialectical drama that we must now work through. In the *Poem of Ecstasy*, an earlier work than previously analysed, an inordinate number of medium-scale progressions are found. These are charted for perusal in the following summary, each being labelled in the relevant position of *Appendix F*.

<sup>525</sup> Although Pavchinsky's piano continues this triplet motive in full chordal form in the final measures, this is merely a device to replicate Skryabin's extremely long chord, and is not present in Skryabin's score.

**EXPOSITION**

M.	5	T
	31	S
	32	D
	39	T
	47	S
	65	D
	67	T
	87	S
	101	T
	118	S
	127	D
	135	T
	136	S
	139	D
	154	T
	162	S
	168	T

**DEVELOPMENT (181)**

	191	S
	213	D
	239	T
	253	S
	260	D
	265	T
	272	S
	281	D
	285	T
	295	S
	305	D

**RECAPITULATION**

	313	T
	327	S
	329	D
	331	T
	335	S
	374	D
	378	T
	379	S
	396	D
	421	S
	427	T
	442	D
	495	T
	538	D
	561	T
	565	S
	601	T

FIGURE 7-19: TONAL FUNCTIONAL SHIFTS IN THE *POEM OF ECSTASY*

In the *Poem of Ecstasy*, middleground rotations seemingly replace the deep structure. This is one of the ‘poetic’ elements of the *Poem of Ecstasy* which, as Baker correctly asserts, is not a symphony. Though Baker’s summation pertains to the Lisztian thematic development, its ‘freedom and fantasy’ extends to tonal concerns.<sup>526</sup> I will reconstruct its sketchy background, such as it is, through a contemplation of tonal function in due course, but for the present I remain in this revolving foreground.

Like Blavatsky’s cyclical cosmogonic models that so thrilled Skryabin, Hegel’s evolutionary accounts of the awakening of consciousness employ circular metaphors, enunciating *Dantean* levels.<sup>527</sup> Hegel intricately describes how philosophical ideas move fluidly out of themselves in a perpetual dialectical spiral, ultimately reaching a higher form in the ‘Absolute Idea’ or *Wissenschaft*. Thus an Idea achieves “unity with itself”.<sup>528</sup> These cycles are therefore part of a more generalised linear motion – a spiral. Like Blavatsky’s countless septenary programs with their evolutionary levels, Hegel posits distinct stages or *Stationen des Weges*.<sup>529</sup> The spirit passes through numerous phases of self-education, self-division, conflict, master-servant differentiation and reversal, crisis, absolute terror, death and rebirth, before the subject then finally becomes his own object. As quoted by Abrams, Hegel claims, “each of the absolute opposites recognizes itself in its other, and this recognition breaks out as the ‘Yes!’ between the two extremes”.<sup>530</sup> Resounding echoes of this ‘overcoming’ of negative oppositions punctuate Skryabin’s *Poem of Ecstasy*. Caves of monsters and dragons, which the Spirit must overcome, lead to the Universe’s resounding cry of “I am”.<sup>531</sup> Hegel’s rings eventually slip out of themselves into their own opposition in the stage of “absolute freedom and terror”. Here the Spirit arrives at the pinnacle of its separation and becomes, as Abrams quotes, “merely the fury of annihilation”.<sup>532</sup> Skryabin’s *Poem of Ecstasy* emphatically enters this stage:

You may know all your oneness  
 Annihilated within me!  
 Rise up one against another,  
 Strike against me,  
 Negate your love!  
 Turn against me, all people and elements,  
 All horrors lift up your heads,  
 Try to destroy me,

<sup>526</sup> Baker, *The Music of Alexander Scriabin*, 235.

<sup>527</sup> Blavatsky’s anthropogenic models involve seven ‘root races’ which, at end of the seventh, return to a state of *Prayala* (rest), awaiting the subsequent *Manvantara* (state of prologue) – endless cycles. Barborka, *The Story of Human Evolution*.

<sup>528</sup> The process is described in excellent detail by Murray Abrams: M. H. Abrams, *The Mirror and the Lamp: Romantic Theory and the Critical Tradition* (Oxford: OUP, 1971).

<sup>529</sup> M. H. Abrams, *Natural Supernaturalism: Tradition and Revolution in Romantic Literature* (New York: Norton, 1971), 229.

<sup>530</sup> *Ibid.*, 233.

<sup>531</sup> Although Dragons are symbols of ‘horror’ here, we must remember that to Theosophists, they were symbols of knowledge. Barborka, *The Story of Human Evolution*.

<sup>532</sup> Abrams, *Natural Supernaturalism: Tradition and Revolution in Romantic Literature*, 232.



Caverns of dragon's mouths  
Serpents twist round me  
Constrict me and bite me.

Skryabin would understand the step-like, linear, nature of Hegel's discourse via Plekhanov's accounts. Plekhanov resolutely insists that the universal Spirit moves through 'stages', in contrast to the "so called evolutionists" who supposedly regard development as a seamless process.

They would like to prove that in nature, as in history, there are no leaps. Dialectics, for its part, knows very well that in nature, as in human thought and history, leaps are inescapable. But it does not ignore the incontrovertible fact that throughout all the moments of change one and the same *uninterrupted process* operates. Dialectics simply seeks to clarify the entire series of conditions under which gradual changes must necessarily lead to a leap.<sup>533</sup>

And in Skryabin's music, as in his text, the negatively-driven leaps between circular progressions form a teleological spiral, each rotation building on lessons previously learnt. This progression is affirmed in (at least) three distinct musical parameters. Firstly, the actual mechanics of circular rotation – the discharge between functional cycles and epicycles – flow through negation. Secondly, the various cycles can be forms of negation *in themselves* – negation of a particular tonal function. Cycles can undermine the stability of a function, and, through negation, refine and vitalise it. Third, and paramount, is a special kind of procedure of tonal function engendered by rotation, in which the nature of functional relationships is called into question. The first two procedures will be succinctly expounded below; this third and more substantial investigation will occupy the remainder of the chapter, leading to a discussion of tonal function in the symphony and the dialectical mechanics of its desiring apparatus.

### (1) The Mechanisms of Functional Rotation: Negation of the Cadence

As expected, drives fluctuate in rapid succession at the most immediate level, but structural levels are often clarified through *direct discharge*. One perfect cadence in C major – the only pure example in the piece – is heard in m. 3 and establishes the opening *T* function that emerges from the *D* miasma. This is what the Soviet musicologist Asafiev calls "the first jolt".<sup>534</sup> But cadential precision is quickly negated. In m. 71, a *T* area (emphasised by *a*-DRIVES on C / F#) floats above a *S* pedal (alternations of D and Ab); it is grounded in m. 74 when the D/Ab pedal discharges plagally to a *TEb*<sup>7</sup> chord, mediated by a 'parsimonious' – major third related – C chord (m.73).

<sup>533</sup> Plekhanov, 'The Meaning of Hegel'.

<sup>534</sup> Guenther, *Varvara Dornova's "Garmonia Skriabina": A Translation and Critical Commentary*, 139.



FIGURE 7-20: POEM OF ECSTASY, MM. 71-74

The interjection of this latter major third lubricates the plagal discharge, and is widespread in the poem's cadential organisation. Exploring the very first page of *Appendix F*, instances of perfect cadences announce themselves more frequently. Noteworthy passages include: m. 25 (where a  $D \rightarrow G$  cadence is mediated by  $Bb$ ), m. 28 (where  $C \rightarrow F$  is mediated by  $Ab$ ) and m. 33 (where  $G \rightarrow C$  is mediated by  $E$ ). This process itself is a form of negation – a negation of the cadence. The examples on the first page of *Appendix F* are each presented 'monotonally' (i.e. in single drive formations), and, following the true perfect cadence in m. 3, they are heard as negated variants of the  $V \rightarrow I$  paradigm. And this negation of cadential discharge sets in motion a total re-evaluation of cadential procedures, culminating in the final moments of the work, to which I will shortly turn. Just as Skryabin's *Spirit* negates its own desiring apparatus, so Skryabin negates the musical carriers of tension and discharge.

## (2) Cycles as Negation: Dernova's 'Major Enharmonic Sequence'

One readily identifiable model in this poem is Dernova's 'major enharmonic sequence'. In such a sequence, enharmonically equivalent chords ( $a_{\text{-DRIVES}}$ ) are presented individually and sequenced in  $t_2$  transposition.<sup>535</sup> This concatenation of  $t_2$  progressions harbours functional significance, which Dernova overlooks; transposing tritone pairs a whole-tone upwards creates circular functional shifts. This is certainly an audible phenomenon, particularly in Skryabin's, often crude, mechanically ascending transpositions, doubtless designed to generate a basic form of tension. For example,  $B/F$  moving to  $C\#/G$  would manoeuvre us orbitally:  $T \rightarrow S$ ,  $D \rightarrow T$  or  $S \rightarrow D$ . Such instances abound in the *Poem of Ecstasy*. These whole-tone transpositional steps create a ladder, ostensibly with six rungs. In fact, due to the  $t_2$  transposition, there are only three rungs; a self-replicating tritone switch occurring on the fourth.

<sup>535</sup> Ibid., 97. Other sequences Dernova finds include: 'the minor linked sequence' (209,  $t_3$  sequences) and 'functional sequence' (239,  $t_{11}$  sequences).

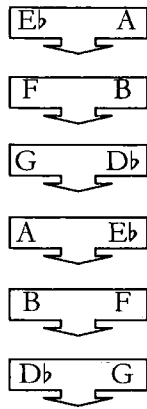

FIGURE 7-21: TRANSPOSITIONAL MODEL OF T2 PROGRESSIONS OF TRITONE PAIRS

The reader, now invited to turn to *Appendix F*, will find an illustration of this model in practice between mm. 344-355. A chain of no less than six links runs thus:  $C\flat / F$  (m.344)  $\rightarrow$   $D\flat / G$  (m.345)  $\rightarrow$   $E\flat / A$  (m.347)  $\rightarrow$   $F / B$  (m.351) (in alternation with the previous  $E\flat / A$ )  $\rightarrow$   $G / D\flat$  (m.355)  $\rightarrow$   $A / E\flat$  (356).

343

347

351



FIGURE 7-22: *POEM OF ECSTASY*, MM. 343-366

Remarkable as such sequences are, their value lies in the double rotation of tonal function they employ:  $S \rightarrow D \rightarrow T \rightarrow S \rightarrow D \rightarrow T$ . Yet Scriabin casts these in a 'dialectical' evolutionist drama where a quantity of tension (of rotational discharges) must eventually transcend into a qualitative change (slipping into negation). Tonal functions overlap in m. 356; the A/E $\flat$  polarity (*T* functioned) compounds the G/D $\flat$  rather than replaces it, leading to a qualitative change, brought forth by the coagulating tension of the rotational model. The lingering *a*-DRIVE on E $\flat$  in m. 356 heralds a local cycle of fifths, stretching down, via an *f*-DRIVE on A $\flat$  (357), to reaffirm the D $\flat$  pitch in m. 358. The whole-tone relation of the D $\flat$  and E $\flat$  elements then becomes isolated and re-emphasised in the following measures through various  $T \rightarrow S \rightarrow D$  motions to A $\flat$  (i.e. mm. 362-364). The congregation of this D $\flat$  and E $\flat$  around an A $\flat$  centre as a 'tonic' form (triadic and bass emphasised) in m. 364 defines their functions as local *D* (E $\flat$ ) and *S* chords (D $\flat$ ) that discharge into *T*. This tonal centre is also implied through triadic, pseudo-tonic (*f*-DRIVE) and bass presentation. The erstwhile 'atonal' drive model becomes tonally fixated, replicating the ascent from drive to desire, now with Hegelian support. These cycles then, like the 'creative spirit' weary of their structure, generate enough tension to overleap their boundaries and transcend into a new state.

In order to appreciate the dialectical subtlety of this passage we need to inspect its extremities. The ‘new’ tonic of  $A\flat$  distributes its energy to its axial partners B and D in m. 365. Thus the passage returns to the  $S$  axis, and connects with the point of origin of this entire passage – m. 335 – a rare instance (the only one in the *Poem of Ecstasy* in fact) of full axial drive presentation, simultaneously outlining B, F, D and  $A\flat$ .<sup>536</sup>

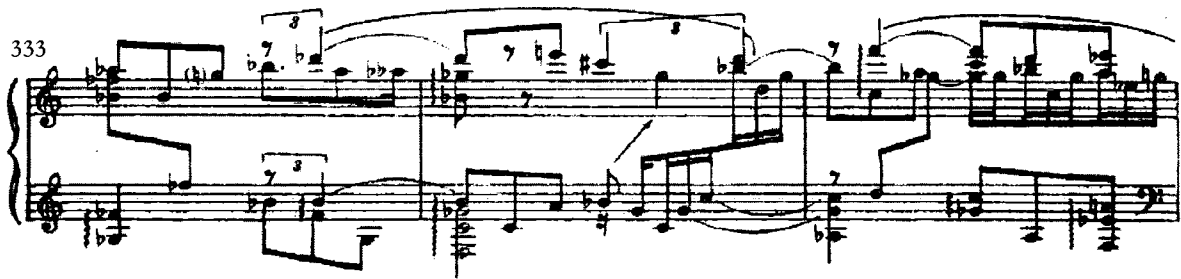

FIGURE 7-23: *POEM OF ECSTASY*, MM. 333-335

Now we can situate the entire six-stage cycle as a negation of this full-blooded  $S$  axis, which breaks into its component parts and is reaffirmed as a tonic through this negative sequence. The  $S$  function now emerges stronger, richer and ready to face new adventures. And this  $S$  function features in a new dialectic, one to which I now turn as I unpack Scriabin’s dialectical manipulation of tonal function in the *Poem of Ecstasy*.

### (3) Harmonic Negation: The $S$ as Antithesis of the $T$ : Poem, Op. 71, no. 2

Tonal function is certainly susceptible to dialectical argument. Even as early as 1853 Hauptman was using Hegel and German Idealist theory to support music analysis.<sup>537</sup> Functions negate and reaffirm each other, forming dialectical progressions. Belyayev’s account of the *Poem of Ecstasy* exercises highly charged images of tonal struggle. To describe one simple sequence for example, “The tension becomes more and more vigorous. In its forward momentum it quickly overpowers the tonalities of  $D\flat$  major (mm.162-165) and E major (mm.166-167), achieving a climax on F major (mm.169 ff)”.<sup>538</sup> In antipathy to this striving voice, Belyayev recognises passages of rest: “At the full strength of its intensity the approach towards ecstasy is still heavy: it still draws downwards (the modulations to  $A\flat$  major), but it has been accomplished! A man can rest himself.”<sup>539</sup> Crucially, this rest is reached when Scriabin brings us into the  $S$  region. My investigation of a piece that is enclosed within the parameters of diatonicism, discloses a sonata-form organisation distant from Scriabin’s late style. Replacing a formal polarisation

<sup>536</sup> The absence of the pitch B, means the drive on B is presented only as a  $g$ -DRIVE.

<sup>537</sup> As shown by Harrison, *Harmonic Function in Chromatic Music*, 218. Interestingly enough, this included gender-based depictions of harmony as feminine, melody-as masculine, 226.

<sup>538</sup> «Напряжение ее дается все более и более могучей. В своем поступательном движении вверх она быстро преодолевает тональность  $Des$ -dur (тт.162-165) и тональность  $E$ -dur (тт.166-167) и достигает вершины ( $F$ -dur, т.169 и далее)» Belyayev, *Musorgskii, Scriabin, Stravinskii*, 61.

<sup>539</sup> «При всей силе напряжения экстаз этого подхода еще тяжел, еще тянет вниз (модуляции в  $As$ -dur), но он уже обретен! Человек может успокоиться.» *Ibid*.

of  $I \rightarrow V \rightarrow I$  are miniature rotations of  $T$ ,  $S$  and  $D$  functions. So many  $T \rightarrow S \rightarrow D$  patterns are found that the work appears to be structured by this deep, rotating energy. In Sonata no. 6, 10 and *Vers La Flamme*,  $T \rightarrow S \rightarrow D$  rotations operated at a deep, structural level as well as a surface level, replacing the  $T \rightarrow D \rightarrow T$  opposition that fuelled the classical sonata principle. Now we find that  $T \rightarrow S \rightarrow D$  patterns posit a new antithetical struggle in the work: a  $T/S$  struggle.

Whilst my task is now to examine Skryabin's dialectical conception of tonal function, to achieve this I make a preparatory detour through a later work, Op. 72, no. 1. The investigation of this short piece has been a running concern of the thesis thus far, and this final instalment will hopefully prepare us to organise the much larger Op. 54. To engage with this problem I first take snapshots of Skryabin's portrayal of tonal function through his short career.

The Russian theorist Yavorsky, who was the first to analyse Skryabin's music in depth, labelled three periods in the composer's career. The first spans his earliest twenty opuses and is characterised by "a prevalence of the fourth degree of the diatonic scale and its "subdominant" chords (IV) over the stronger, more pivotal "dominant" (V) or fifth of the tonality."<sup>540</sup> The second period is characterised by nervous energy in which the "subdominant harmony gradually but quickly gives way to dominant harmony, as if compelled."<sup>541</sup> Skryabin's third ('late') style was heralded when "The dominant (V) chords based on the fifth tone of the scale overtake the subdominant (IV) and produce a "tension without relief." Skryabin "thirsts for activity," here, but "the parch cannot be slaked", Yavorsky stated. He finds no "active resolution, no release into stability." However, this tension stimulates "a further splurge of energy": further evidence of dialectical thought in the Russian *Dialectical Materialist* tradition.<sup>542</sup> And others too have declared that Skryabin's chromatic *late style* is founded upon the  $D$  function. Taruskin asserts that the *mystic chord* is a "chord that expresses the dominant function", whilst Peter Sabbagh's entire dissertation is an attempt to show how this sonority is built from a  $D$  structure although he admits, "Skryabin's chord loses its dominant function after, Op. 58".<sup>543</sup>

Yavorsky claims that Skryabin's 'subdominant period' in his early days was due to the influence of Romantic "psychological" composers such as Chopin;<sup>544</sup> such composers used the subdominant as a lyrical region of relative stability, a safe haven of Nirvana that is sheltered from the raging, desire-laden dominant. When Rameau first coined the term 'subdominant' he conceived it as being in perpetual

<sup>540</sup> Bowers, *The New Scriabin: Enigma and Answers*, 140. Yavorsky declined offers to meet Skryabin on account of his detestable 'theosophical fantasies' (140-141); Skryabin was well aware of Yavorsky's theories.

<sup>541</sup> Guenther, *Varvara Dornova's "Garmonia Scriabina": A Translation and Critical Commentary*, 49.

<sup>542</sup> Bowers, *The New Scriabin: Enigma and Answers*, 142.

<sup>543</sup> Taruskin, 'Scriabin and the Superhuman: A Millennial Essay', 57.

<sup>544</sup> Bowers, *The New Scriabin: Enigma and Answers*.

duality with the 'dominant', claiming, "these two terms serve as a 'limit' of the mode. Each radiates out from the tonic centre in opposite directions, yet each is ultimately drawn back to that centre."<sup>545</sup> But Skryabin's late music has been 'decentred' because the tonic is never actually cited; the tonic chord lies beyond reach; we rotate functions perpetually like a serpent chasing its tail (a Blavatskian image). Another statement by Rameau seems more apt to Skryabin's tonal logic; he claims that the tonic "must be seen as the centre of the mode, towards which is drawn all our desires."<sup>546</sup> Continuing this view of tonal function as conflict, Candace Brower claims, "the I-IV-V-I cycle emphasizes the opposition between dominant and subdominant, with the tonic triad appearing at the point where opposing forces came into balance."<sup>547</sup> Skryabin's idealistically inspired philosophy would not allow him to musically show the 'thing in itself' or, as Lacan would later call it, *the objet petit a* – the object-cause of desire. All one hears are musical drives which spiral around a tonal centre which is always a deep *lack*. Because of this, the *T* is often displaced by the *S*; the conflict that we attributed to Rameau's *D* and *S* actually becomes a *T/S* conflict, the *D* merely serving to invest the drives with shape and direction – to 'order the drives'.<sup>548</sup> As the *S* region challenges the *T* region, Skryabin uses *D* chords to mediate both in the Poem, Op. 71 no 2 (figure 1-25) and in the earlier *Poem of Ecstasy*.

In order to tackle the significance of tonal function I draw two strings together; the *circular* and *linear* models of pitch space from Chapter 3 work dynamically with each other. As previously illustrated, the bass structure alternates D, G#, F and B drives. *Circular* space (in this case, a minor third based form of circularity) fixes this as a static *T* region. Yet this view must now be broken open. Combining this *circular* space with *linear* space shows how Skryabin uses the *D* function to posit a different regional conflict within this axis. The opening chord is far from a simple *D* sonority; it is a manifestation of the famous *mystic chord* that contains drives that bifurcate in the *D* region and *S* region simultaneously. In contrast to the analyses of Dernova, Skryabin's chord is considered by *drive analysis* to be poised between two tonal regions, comprising two dominant seventh structures which reach towards the *S* and the *D* of a hypothetical C major key: a C<sup>7</sup> chord (which pulls to an F triad) and a D<sup>7</sup> chord (which pulls to a G triad). In the opening measure of Op. 71, no. 2 the *mystic chord* is turned 'upside down', the D occurring in the lower region rather than the upper, producing a drive towards G (*D* region) in an abstract C major, and a drive towards F (*S* region). The use of this whole-tone combination of drives shows a subtle linear *D/S* bifunctionality where the bass-progression yielded a simple homogenous *T* in *circular* space. The chord becomes bifunctional, making *linear* demands in two separate directions through presentation as simultaneous *D* seventh chords.

<sup>545</sup> Christensen, *Rameau and Musical Thought in the Enlightenment*, 185.

<sup>546</sup> *Ibid.*, 189.

<sup>547</sup> Brower, 'A Cognitive Theory of Musical Meaning', 346.

<sup>548</sup> As mentioned, the phrase 'order the drives' is a reference to Julia Kristeva's *chora*. This is the pre-lingual semiotic realm of physical drives, which despite lying apart from the *Symbolic Order*, are nonetheless regulated in a primitive form.

And this split between *linear* teleological discharges and *circular* homogeneity allows the *S* region to erupt and intensify throughout the piece. Surveying the opening sentence, *S* and *D* functions are presented with relatively equal weighting. However, in m. 4 (and certainly in m. 5) the *S* region (F) is foregrounded more so than the *D* region (G) that is reduced to a mere trill in the upper register that evaporates quickly. It is true that the opening dialogue between the *S* and the *D* is recapitulated in m. 6, but as the upper melodic line reaches its climax in m. 9, we alight upon a pair of fifths (F/C) outlining the *S* chord/region (F) rather than the bitonally simultaneous *D* region/*S* region (G/F). This arrival of an F chord is supported by an undulating drive on B. Naturally these two dominant-sevenths on B and F share the same tritone (A/D $\sharp$ ) and therefore the F *S* region also acquires the status of a *D* chord in itself with its enharmonic E $\flat$  creating the seventh. The *S* region is bolstered at this point. Furthermore, in m. 10 the G $\flat$  chord acts as a *Neapolitan-sixth* to further emphasise the F $^7$  that we hear in the bass soon afterwards, and in m. 11 a C major chord in the upper voice (a *T* chord) is underpinned by another dominant seventh on B, a *S* drive.

My *linear* model of Skryabin's tonal function therefore yields a motion through two relatively stable competing functions – the *T* and the *S*. The *D* serves as the protean element that navigates the path between, serving always to negate (and thereby mediate and affirm) the position of the other. Thus the *S* gains ascendancy over the *T* that is reduced to a mere 'abstraction' in Skryabin's late style, as Dernova claims, the *T* is featured only in the "imagination".<sup>549</sup> Through the *circular* substitution model, this region (determined to be the *S* region through *linear* space) can be posited as a stable background, exerting pressure underneath free flowing drives. Thus Skryabin's late style signifies a return to his earlier predilection for the subdominant. Ernst Kurth characterises Romantic music as a struggle between the luminescent dominant region and the shadowy subdominant region, using the *S* forest music in Act 1 of *Siegfried* against the *D* music of the hero to support his claim.<sup>550</sup> This shadowy subdominant realm is one of mystery and lyricism and the dominant realm is a region of struggle towards luminescence, the same struggle that characterises Lenin's 'fourth term of the dialectic' – *negativity*. In the same way, Rameau had characterised the subdominant as "sorrow" and the dominant as "liveliness".<sup>551</sup> This *D* negativity is where desire-based teleology is most virile; the *S*, by contrast, characterises a certain ascetism. This ascetic concern for the *S* region is fostered in Op. 71, no. 2 when, approaching the central point (and its T6 replication which constitutes the second half of the piece), the *D*  $\rightarrow$  *T* discharge pattern dismantles itself. Here the drives, which in earlier pieces moved towards a tonal object of desire, become internally diffused. By the time we reach mm. 18 Skryabin presents *b*-DRIVES in whole-tonally related keys (D $\flat$ <sup>7 $\sharp$ 5</sup>, E $\flat$ <sup>7 $\sharp$ 5</sup>, F<sup>7 $\sharp$ 5</sup>, G<sup>7 $\sharp$ 5</sup>, A<sup>7 $\sharp$ 5</sup>, B<sup>7 $\sharp$ 5</sup>) in such a dense way that they

<sup>549</sup> Guenther, *Varvara Dernova's "Garmonii Skriabina": A Translation and Critical Commentary*, 171.

<sup>550</sup> Kurth, *Ernst Kurth: Selected Writings*, 100-103.

<sup>551</sup> Christensen, *Rameau and Musical Thought in the Enlightenment*, 249.



become indistinguishable. Thus Skryabin returns to the Debussyan paradigm of forming aggregate combinations to both build climaxes and lead to a final sonority.<sup>552</sup>

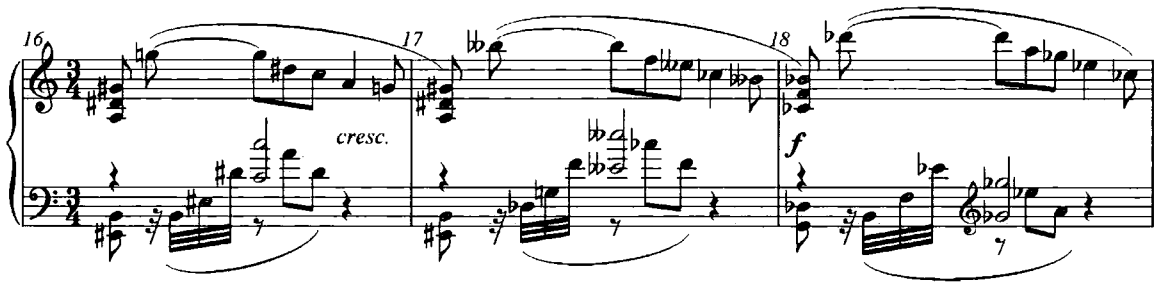

FIGURE 7-24: POEM, OP. 71, NO. 2, MM. 16-18.

In these measures the drives become so fragmented that our cognitive ability to perceive them must also break down. *Drive analysis* becomes almost worthless here because of the over-loading of drive energy. And this occurs over the bass pitch F (E#), a signifier of the *S* region relative to an absolute key of C major.

My investigation of the *Poem of Ecstasy* reveals a comparable preponderance of the *S* function. In mm. 67-101, 154-168, 561-601  $T \rightarrow S \rightarrow T$  progressions step forward. In other ways too, the *S* function supplants the *D* as erstwhile antithetical correspondent to the *T*. Figure 7-19 tabulates numerous  $T \rightarrow S \rightarrow D$  progressions, each with different durations and structural weighting. It shows various instances of strain between the *T* and *S*. For example, the *molto languido* theme at m. 87 ushers in a protracted passage of *S* predominance. The *S* drive on A $\flat$  becomes tonicised, with bass support, thus foregrounding itself against the surrounding drive complexes. This *S* drive now commutes to the tritone-related D (mm.93-99) resolving to a *D* bass drive G (m.101) in a seemingly conventional  $S \rightarrow D$  discharge. However, this bass drive actually supports an uncontaminated *T* chord on C (second inversion), thus creating  $S \rightarrow T$  motion, with a 'fudged' form of *D* discharge flowing into a 6/4 chord. The *D* functioned discharge is thus marginalised in favour of (1) *S* preponderance and (2) *S* discharge.



<sup>552</sup> Mark Macfarland, 'Transpositional Combination and Aggregate Formation in Debussy', *Music Theory Spectrum* 27/2 (2005), 210.

91

95

**Allegro non troppo**  
Cor. con sord.

99

FIGURE 7-25: *POEM OF ECSTASY*, MM. 87-102

At times, rotational *direct* discharges can reaffirm the *T* through negation of the *S* region. Incidences of  $T \rightarrow S \rightarrow D \rightarrow T$  rotation become noteworthy due to the chasm which can separate the pure *T* from the subsequent *S*. Often, despite discharge possibilities, discharge is rejected in favour of a 'negative' functional substitution. Mm. 116-124 contains a moderately stabilised *T* on *C* (with a dissonant  $A\flat$  bass tone), itself the refined product of cycle-of fifths motion in mm. 103-115 (*A* in m. 106, *D* in m. 107, *G* in m. 111, *C* in m. 116). This 'leaps' to the antithetical *S* region through  $a$ -DRIVES on *D* and  $G\sharp$  in m. 118. This region fulfils its functional imperative and reaches back to the *T* region, reaffirming the *C* through  $S \rightarrow D \rightarrow T$  discharges.<sup>553</sup> Thus, after a harsh moment of negativity, the *T* slipping into the *S*, the harmonic structure between the poles is reconstructed and reaffirmed.

<sup>553</sup> The *D* function is expressed in the *G* pedal discharging to a *C* in m.124, but fully realised in m.127-128.

103 *avec une noble et douce majesté*

Musical score for measures 103-104. The piece is in G major and 2/4 time. The right hand features a complex, flowing melody with many sixteenth and thirty-second notes, often beamed together. The left hand provides a steady accompaniment with eighth and sixteenth notes. Measure 103 ends with a fermata over the final note.

Musical score for measures 105-106. The right hand continues with intricate sixteenth-note patterns. The left hand has a more active role with eighth-note accompaniment. Measure 105 ends with a fermata.

Musical score for measures 107-108. The right hand maintains the sixteenth-note texture. The left hand accompaniment is consistent. Measure 107 ends with a fermata.

Musical score for measures 109-110. The right hand has a melodic line with some grace notes. The left hand accompaniment is active. Measure 109 ends with a fermata. The piece concludes with a final cadence in measure 110.

111 *Moderato avec delice*

Musical score for measures 111-114. The tempo is marked 'Moderato' and the mood is 'avec delice'. The right hand features a more melodic and lyrical line with slurs and ties. The left hand accompaniment is simpler, using eighth and sixteenth notes. Measure 111 ends with a fermata.

Musical score for measures 115-118. The right hand continues with a melodic line. The left hand accompaniment is active. Measure 115 ends with a fermata.

119

123

FIGURE 7-26: *POEM OF ECSTASY*, MM. 103-128

Whilst sections of the poem showcase the *T* and *S* functions, *D* passages are scarce. The only point when the *D* function accompanies a significant thematic turn is the *Tragico* (m. 213).

213 *Tragico*

216

219

FIGURE 7-27 (A): *POEM OF ECSTASY*, MM. 213-221

FIGURE 7-27 (B): *POEM OF ECSTASY*, MM. 232-240

This theme, with its dark harmonies, unsettling rhythms and low brass orchestration, offers the only musical analogue to the “dark presentiments / Of shining rhythm” – the ‘horror’ sections of the poem. The *D* function presides here, launched by interlocked drives on E and B $\flat$ . But this accentuated tonal function is quickly discarded. True enough the function is emphasised by a three-stage cycle of fifths – mm. 215 (A $^7$ ), 217 (D $^7$ ) and 218 (G $^7$ ) –, returning to its E/B origins in m. 219 and leading to a fully fledged ‘authentic’ drive on G, but at the point when the function becomes strongest (with bass support and a full *i*-DRIVE in m. 232), it is paradoxically weakened and usurped by the *S* functioned drives on F and B, and latterly, the *T* function in m. 239 ff. This drama is shown on *Appendix F*.

Here I must mention the ingenuity of Belyayev’s 1972 analysis of the *Poem of Ecstasy*. Apart from the fact that Belyayev prefigures my *drive analysis* by showing how Riemannian functions can collide into a form of bitonal discourse in a way that also foreshadows Harrison and Swinden’s recent work, he also exposes the *D* nature of the *Poem of Ecstasy* to be a myth. Showing the *S* to be a far more subtly crafted region and in greater proliferation, he says, the *D*-complex is also “less complicated than the *S* complex.”<sup>554</sup> Providing a pseudo-acoustical conception of functions, he claims, “The *S* complex is of the greatest interest as it yields the greatest quantity of partials (which enter in to its composition)

<sup>554</sup> «Он [D] ... менее сложен, чем комплекс S», Belyayev, *Musorgskii, Skryabin, Stravinskii*, 62.

compared to the T and D complexes; and as a complex, it shifts its centre of gravity from the fourth degree to the second degree.”<sup>555</sup> This takes account of the supertonic major chord – the auxiliary dominant – that is so problematic to characterise functionally.

Of course Belyayev shows the *S* complex to be at war with itself. At one point in the poem, he says, “The theme of ecstasy commences anew, now a third lower, but the opposition of the *S* [to the *T*] (mm.191-194) becomes more marked. A terrible conflict begins (mm.195-206), yet the harmony does not leave the confines of the *S* complex.”<sup>556</sup> In the first half of the work, “a struggle occurs between the two subdominant tonalities of C major to which this part of the development returns – *A<sup>b</sup>* and *D* major. At the end of this half of the development *A<sup>b</sup>* certainly prevails, but its supremacy in the development is now destroyed, and it has to yield to C major in the reprise, which from here becomes a preparation for the tonality of C major.”<sup>557</sup> Belyayev is, self-admittedly, unable to assimilate the tritone equivalence of these two *S* functioned *D* chords into his account: “In this regard, the extract under discussion is especially problematic for me on account of its harmonic ambiguity. Both *A<sup>b</sup>* and *D* share the same subdominant harmonic meaning during the preparation for C major. Moreover, the dominants of *D* major and *A flat* major are equally remote from each other, and, obviously, the logic of their relationship is not immediately evident.”<sup>558</sup> Thus the precise nature of this ‘struggle’ eludes him, whilst Dernova comprehended the ‘tritone link’ well.

Naturally this analysis runs contrary to Baker’s survey which tries to ‘squeeze in’ the traditional V - I opposition.<sup>559</sup> But Baker runs into problems. For all that his graphs show structural *D* progressions and prolongations, his prose serves to highlight ways in which the function is evanescent. At the end of the development (m.127) for example, he claims, “The bass thus moves away from the dominant,

---

<sup>555</sup> «Наибольший интерес представляет собою комплекс S, как: 1) дающий наибольшее количество частичных (входящих в его состав созвучий) сравнительно с комплексами T и D, а также: 2) и как комплекс, перемещающий центр тяжести субдоминантового созвучия с четвертой ступени на вторую», Ibid., 61.

<sup>556</sup> «Тема экстаза начинается снова, уже третьей ниже, но противодействие S (в тактах 191-194) делается более значительным. Начинается ужасная борьба (тт. 195-206). Гармония не покидает пределов S.» Ibid., 79.

<sup>557</sup> «В первой половине происходит борьба между двумя субдоминантовыми тональностями C-dur, к возвращению которого ведет эта часть разработки, а именно между As-dur и D-dur. As-dur в конце этой половины этой части разработки хотя и побеждает, но его господство в разработке уже нарушено и он должен уступить место C-dur репризы, сделавшись с этого момента лишь подготавливающей C-dur тональностью.» Ibid., 80.

<sup>558</sup> «И в этом смысле разбираемый отрывок для меня представляет особые затруднения из-за двойственности гармонии этого места. И As-dur и D-dur имеют одинаковое значение субдоминантовых тональностей при подготовке C-dur. Кроме того, доминанты D-dur и As-dur тождественны далеки друг от друга и, по-видимому, не находятся в непосредственной логической связи.» Ibid., 81.

<sup>559</sup> Areas of *D* focus on Baker’s graphs are rarely justified. M. 111-169 is characterised as being *D* based, yet I would portray mm. 101-136 as transitionally ‘rotational’ (i.e. the cycle of fifths is extremely prominent in this section), and mm. 137-169 as a *D* → *T* → *S* → *T* passageway. A similar passage from mm. 277-305 is shown to prolong the bass G, which is articulated at these outer extremities only as a dissonant bass note (i.e. not supported by *D* harmonies). Whilst my analysis could support this prolongation, finding a running *D* → *T* → *S* → *D* progression, the *S* function enjoys far greater prominence than the *D*, particularly between m. 293-302.

ultimately progressing through A# to Ab.<sup>560</sup> The axis system allows us to reconstruct this as a motion to the *S* function. Baker also hints obliquely at the significance of the tritone in supplanting the *D* function, mentioning “the replacement of the dominant note in the bass by the raised scale-degree 4”.<sup>561</sup> And of course, to us, this tritone substitution holds a surrogate *T* function rather than Baker’s *D*. Similarly, Baker’s concern that “Throughout much of the development, harmony centers on Eb, a foreign element in C major”, is embraced warmly by me: Eb is a *T* substitute.<sup>562</sup>

One further piece of evidence for the *S* supplanting the *D* function will be revealed through discussion of the final approach to the ecstatic tonic chord. But before this, we need to explore ways in which the tonic chord is posited as the object-cause of our desires.

### The Tonic as *objet petit a*

Unlike the late sonatas, where the desire-controlling *T* function is left unvoiced as a tonicised unit, *The Poem of Ecstasy* confirms it majestically. But from what point is the *T* chord inaugurated? Belyayev’s account of Riemannian function in the *Poem of Ecstasy* is somewhat different from mine. I utilise Lendvai’s axis system, which means that after finding the *T*, I label the other functions ‘absolutely’ throughout the poem. Belyayev, by contrast, labels *T*, *S* and *D* functions ‘relatively’ to regional shifts. He rather inexplicably locates a ‘modulation’ at m. 27, and thus labels the C<sup>7</sup> chord underpinning it as *D* functioned rather than a *T* functioned sonority.<sup>563</sup> Whilst his approach is suppler than mine, it is nonetheless problematic. Even in Skryabin’s ‘middle period’, tonal regions cannot be experienced this way, and can only be asserted retrospectively after the unveiling of a local tonic; this rarely occurs until the final gesture of a piece, if at all. As Adorno declared, the structural listener “hears the first measure only when hearing the last, which redeems it.”<sup>564</sup> But unlike Skryabin’s late style, where functional labels can be almost arbitrarily assigned by analysis, his *Poem of Ecstasy*, through various procedures, forces us to focus on C major as a *T* chord, region and key by unveiling the *T* function early in the piece. This facilitates Belyayev’s approach, which would be invalid to the vast majority of Skryabin’s works. For reasons outlined in Chapter 4, my approach seems more germane to Skryabin’s general tonal practice and so too, to this work. Belyayev’s approach venerates the *T* region of C major, which to my mind is an inauthentic *dispositif* – social apparatus, artificially constructed in an attempt to shape and contain volatile drive energies. Nonetheless, in this curious poem, the key of C is established as the focal point of the piece, however fragile it may be. This is Lacan’s *objet petit a*. Somewhat bizarrely, *The Poem of Ecstasy* establishes this tonal centre almost prematurely. Weak drives on Eb, G and Db are

<sup>560</sup> Baker, *The Music of Alexander Scriabin*, 226

<sup>561</sup> Ibid.

<sup>562</sup> Ibid., 228-229.

<sup>563</sup> Belyayev, *Musorgskii, Skryabin, Stravinskii*, 65.

<sup>564</sup> Hoeckner, *Programming the Absolute: Nineteenth-Century German Music and the Hermeneutics of the Moment*, 86.

functionally clarified in m. 5 as the harp and strings outlay a clear C chord, discharging from the G element, now invested with *D* functioned status.

**Andante. Languido** Fl.

3

6

9

FIGURE 7-28: POEM OF ECSTASY, MM. 1-12

This initial cadence structures all following cadences, which become mimetic. This is a particularly Lacanian and dialectical moment. Lacan discusses infants whose crying signals are dialectically formed through the satisfaction provided by parents. Regardless of what an infant *actually* biologically needs, any satisfaction it receives goes towards building up a new biological need-response code. Thus an infant is immersed in a desire-based network. And this is also how such musical symbols are built; we now know how inchoate drives can be duped into satisfaction, regardless of what the drives *actually* want.

This robust enunciation of the *T* chord now suffers extensive negation. Its successive presentation in m. 10 is immediately polluted with the pitch B, creating a 'major-seventh', imbued with the leading note of the *D* function. And despite the frequent emphasis of the C's *T* function as a triad throughout the piece (mm.19, 37-38, 73, 101, 114-126, 270, 305-316, 484-486, 495, 532, 545, 583) these triads are



never heard uncontaminated until the final moments of the piece and are always built into other simultaneous drives.

There are various alternative techniques for positing and confirming this C as the tonal nucleus of the piece. These methods all make use of dialectical tension and negation. One such passage, explored earlier, occurs in mm. 103-132 when a protracted cycle of fifths draws us from drives on E to drives on C in mm. 114-126, down to Ab in m. 132. Figure 7-30 supplements figure 7-25 that quoted mm. 103-128.

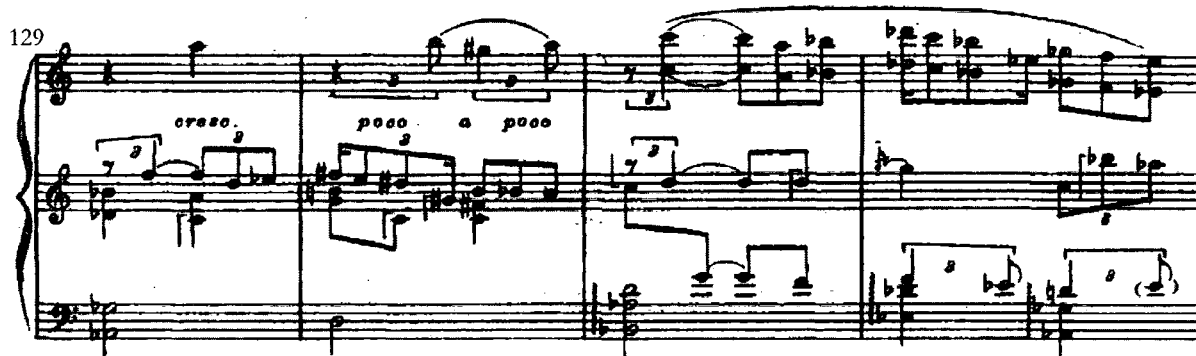

FIGURE 7-29: *POEM OF ECSTASY*, MM. 129-132

This curiously rare use of major third ‘Cohn space’ that posits the central haven of C, is fascinating. Apart from the vertical tritone link, the entire passage is singularly denuded of the tritone relationships that are so pertinent to the rest of the poem. Thus ‘Cohn space’ becomes the negation of ‘Lendvai space’ in the *avec une noble et douce majesté* section of the work. It stands apart as a special event, yielding C as a central axis of symmetry.

But exclusion of the chord of C is naturally one of the clearest ways of implicating it. Mm. 213-218 show an attractive drive configuration on *Appendix f*. Notice how the chord of C is omitted from the sequence, presented only as a bass pitch; an alternative – substituted – tonic of A is immediately posited. In a different context, but based on a similar principle, Joseph Straus’ theory of ‘pattern completion’ comes into play, “when a normative unit of  $n$  elements has been established, the appearance of any subset of that unit containing  $n-1$  elements will create an expectation for the single missing element.”<sup>565</sup> In the *Poem of Ecstasy* the omission of the chord of C, after its initial presentation, creates a desire for it. Passages in which the  $T$  chord is omitted also work dialectically with passages in which the  $T$  status of the C chord is heavily emphasised. In mm. 1-50 drive activity on C becomes the norm, alternating tonicised variants and dominant ( $\hat{c}$ -DRIVE) variants. This activity continues into a highly prominent  $\mathcal{J}$  section in m. 47 (a  $t_2$  variant of m. 39), for which the C serves as a bridge as

<sup>565</sup> Pople, ‘Skryabin’s Prelude, Op. 67, No. 1: Sets and Structure’, 168. Pople explains Straus’ theory.

illustrated on *Appendix F*. Of course, this *S* section (see mm. 51-67), characterised by the *C*'s absence, is terminated via  $S \rightarrow D \rightarrow T$  discharge into *a-DRIVES* on *C / F#* in m. 67; and heavy *C* saturation follows. The devices described above help to orientate us towards an object of tonal desire, prescribed from the very opening of the piece and soon, in one final cataclysmic gesture, to be approached directly, but with a crucial twist.

## The Return Journey

Despite Hegel's veneration of 'society', the dialectical system of the *Phenomenology* breaches the social model and returns to a 'state of nature'; now self-conscious, it "recognizes itself in its otherness".<sup>566</sup> Skryabin undoubtedly ruminated upon this recognition of otherness in true Hegelian fashion: "Every state of consciousness is a relationship to another state of consciousness. This means that its appearance is a negation of all else. In this negation I relate to the other, that is, unconsciously I struggle with the unconscious form of this other abiding in me."<sup>567</sup> Vitaly, Hegel's model is entirely optimistic. Approaching absolute knowledge in the final stage of self-recognition, intelligence is no longer compelled to go beyond itself. Skryabin seems to have adopted this Hegelian view of the Universal History and knowledge, as explored by Schloezer, who quotes Skryabin's words: "The first step of cognition is the first step on my road back. My voyage of search and return marks the beginning of the history of human consciousness, of cognition, of its creativity and of mine."<sup>568</sup> The terminology here is particularly Hegelian: the "history of human consciousness", "search and return".<sup>569</sup> Thus the final stage of the Spirit's evolution is a homecoming, a reunion of the Spirit with itself, the moment of truth. And this brings satisfaction; the human spirit is "at home with itself in its otherness."<sup>570</sup> This ecstatic satisfaction of desire opposes Schopenhauer's ascetic prescription for conquering desire's interminable pressure. Skryabin undoubtedly absorbed this contradiction – Hegel's hope versus Schopenhauer's despair – into his worldview. Yet there are passageways between the two attitudes. The master/slave dialectic's ironic role-reversal sees the slave usurp the master as he learns the suspension of desire. The slave is forced to prepare food for his master, denying himself satisfaction and, thus controlling and mastering desire. It was this ascetic state of *Nirvana* that Skryabin searched for with his yogic breathing and Indian religions, and this, of course, leads to Schopenhauer.

---

<sup>566</sup> Abrams, *Natural Supernaturalism: Tradition and Revolution in Romantic Literature*, 225-237.

<sup>567</sup> Bowers, *Scriabin: A Biography* 2, 104.

<sup>568</sup> *Ibid.*, 101.

<sup>569</sup> Abrams, *Natural Supernaturalism: Tradition and Revolution in Romantic Literature*, 232.

<sup>570</sup> *Ibid.*, 229.

But, as figure.7-1 shows, Skryabin sought Hegelian ‘absolute being’ through ecstasy: “The moment of ecstasy stops being a moment (of time). It engulfs all time. This moment is absolute being.”<sup>571</sup>

Compare this to Schelling’s words, “at that moment we annihilate time and duration of time; we are no longer in time, but time, or rather eternity itself, is in us. The external world is no longer an object for us, but is lost in us.”<sup>572</sup> And the final passage of the *Poem of Ecstasy* returns to a full-blooded, ecstatic tonic chord. This was calculated to bring an end to dialectical struggle through fusion and synthesis, breaking the harmonic limits and flooding into a qualitatively new state. Skryabin’s oblique references to the note of trumpet that brought down the walls of Jericho are rather informative, as Sabaneyev quotes:

I once asked Skryabin if he didn't feel that the end of *Ecstasy* resounded too loudly, that it simply deafens, and I asked if this was in his plan. He answered, “No I disagree. The physical energy (sinew) of sound has significance. Sometimes I want, rather, *I need* such sounds in order for the walls to tumble – literally, not metaphorically.”<sup>573</sup>

The trumpet reaches the ‘orgasmic’ final cadence, which is often misrepresented by commentators as a perfect cadence. Mitchell Bryan Morris claims, “not until the final chord does it offer a completed and fully resolved motion from the dominant to the tonic”.<sup>574</sup> But the final progression is in fact a plagal cadence – a religious ‘Amen’. Even Dernova, who notices that the third symphony, *The Divine Poem*, concludes with a IV – I cadence, fails to take account of the identical procedure in the *Poem of Ecstasy*.<sup>575</sup> Baker’s diagrams show a G in the fundamental bass-line from m. 539, moving to a C chord in 543. This modest summary ignores the subsequent occurrences above the tonic pedal. In m. 547 a novel ostinato outlines an *b<sup>iii</sup>*-DRIVE on D, with passing reminiscences of G in the bass (m.552), nestled within a C triad. G is purposefully dropped in m. 541 and for 64 measures – a significant portion of the work – the pitch remains conspicuously absent (apart from a brief appearance in mm. 577-584). Observe how, on the final page of *Appendix F*, a cycle of fifths stretches from B (m. 559) to C (m.583), but carefully unfolds each drive as a triad; the G drive therefore seems to be purposefully omitted. This coda then (Baker cites a more extensive coda), is a second attempt to conclude the work, the final synthesis of the two truly opposing functions – the *T* and the *S*. And just as the thematic elements vied for prominence in a ‘struggle for recognition’, and subsequently a ‘struggle for domination’, so these tonal functions lock heads. Whilst hearing the D# pitch in the penultimate chord (m.600) as an

<sup>571</sup> Blavatsky also discusses this Hegelian ‘Absolute Being’: Blavatsky, *The Secret Doctrine: The Synthesis of Science, Religion and Philosophy*, 16.

<sup>572</sup> Weininger, *Sex & Character*, 165.

<sup>573</sup> «Я раз спросил его, не находит ли он, что конец «Екстаза» звучит слишком реально громко, что он просто «огаушает», и входит ли это в его план? Скрябин ответил мне: - Нет, я не согласен. И физическая сила звука имеет значение. Иногда мне хочется, мне нужно таких звуков, чтобы стены рушились, по-настоящему, а не Иносказательно.» Leonid Sabaneyev, *Vospominaniya O Skryabine* (Moscow: Classica XXI, 2003), 167.

<sup>574</sup> Morris, *Musical Eroticism and the Transcendent Strain: The Works of Alexander Skryabin, 1898-1908*, 282.

<sup>575</sup> Guenther, *Varvara Dernova's "Garmoniia Skriabina": A Translation and Critical Commentary*, 139.

augmented variant of a *D* function on *G* is tempting, as in the final chord of *Désir*, the absence of the pitch *G* forces us to hear a tonic *C* chord and a subdominant *F*<sup>7</sup> chord (its *E*<sub>b</sub> enharmonically respelled).

Figure 7-30: Poem of Ecstasy, mm. 598-605

This climax is ‘other’ to the dominant currency of the piece; it has not been called forth by its immediate tensions; it is a qualitatively new ending to a symphony whose pressure was too volatile to offer a single pathway out of its drive conflicts. McClary calls this “inorganic closure”, imposed from the outside.<sup>576</sup> The ever-expanding subject of this piece arrested its progress inconclusively at m. 547, and was superseded by this new ‘outer’, thirst-quenching cadence. The ‘background’ antithetical struggle of the *S* and *T* now reaches into the ‘foreground’, manifested as a cadence. In this final Hegelian cadential manoeuvre, the musical subject now “recognises itself in its otherness”; its evolution is now complete.

The *Poem of Ecstasy* is crucial to *drive analysis* as it presents perhaps Skryabin’s greatest (and last) attempt to construct an object of tonal desire, to which the drives become slaves. Yet the fact that the drives themselves perpetually negate and challenge this tonal centre suggests that, already, the drives had taken on a life of their own; the *C* major triad was a Lacanian *misrecognition* of the drive’s true object, a Lyotardian *dispositif*. From here on, Skryabin would never again force us to be so attentive to a single tonal focal point. The blazing *F*<sup>#</sup> triad at the end of *Prometheus* that Daniel Harrison examines, strikes our ears as wholly inauthentic: a false ending: one of Adorno’s “impotent clichés”.<sup>577</sup> Harrison, examining the approach to this chord shows how it gains “tonic function by means of its structural position alone.” We wish to hear the *F* triad as the subdominant of *B*<sub>b</sub>, but the “Pavlovian association

<sup>576</sup> McClary, *Feminine Endings: Music, Gender, and Sexuality*, 100 ff. McClary’s example is taken from *Salomé*, whose death is heard in *C*<sup>#</sup> whilst Herod’s guards’ music is in *C* minor.

<sup>577</sup> Harrison, *Harmonic Function in Chromatic Music: A Renewed Dualist Theory and an Account of Its Precedents*.

of the tonic and compositional conclusion” gets the better of us.<sup>578</sup> The lesson of the *Poem of Ecstasy* is Hegelian: desire, through dialectical sublimation can lead to ecstasy. But Schopenhauer taught that such sublimation is impossible; the Will was unstoppable. Despite Skryabin’s early acceptance of ‘the Will’ as a philosophical category, and its poetically aesthetic applicability to the Fourth Sonata, he musically accepted the full impact of Schopenhauer’s doctrine only in his late style, leading Rimsky to call Skryabin’s later music, “unmitigated tension”.<sup>579</sup>

The *Poem of Ecstasy* offers a rare insight into Skryabin’s grasp of desire as a psychological concept. As mentioned, Skryabin steps forward as an author in the poetic text and psychoanalyses the Spirit. Bowers finds this elsewhere in the text, “The quotation marks around the hortatory middle-section is still the voice of the impalpable prophet (Scriabin the man-God as ecstasy) guiding the disembodied Spirit naked in its unsheathed power.”<sup>580</sup> This move from the unconscious to the conscious is made more explicit by Swan:

Scriabin’s Ecstasy is the joy of unrestrained activity. The Universe (the Spirit) is an eternal creation with no outward aim or motive – a divine play with worlds. However, the creating Spirit – the Universe at play – *does not himself realise* [my italics] the absolute value of creation; he has subjected himself to a purpose, has made his activity a means towards another end. But the quicker the pulse of life beats in him, the more rapid becomes its rhythm, the clearer *it dawns on him* [my italics] that he is through and through creation alone – an end in itself – that life is play. And when the Spirit, having reached the climax of his activity, which is gradually tearing him away from the delusion of utility and relativity, will comprehend his substance – an unrestrained activity – then Ecstasy will arise. The Poem of Ecstasy is thus a sort of cosmogony.<sup>581</sup>

Skryabin’s own philosophy of Ecstasy in his notebooks bears this trajectory from the unconscious to the conscious: “the moment of ecstasy stops being a moment (of time). It engulfs all time. It engulfs all time this moment is absolute being.”<sup>582</sup> But in approaching the *Ideal*, this ecstasy ‘loses consciousness’ thus returning itself to its previous state:

Like a man during the sexual act – at the moment of ecstasy he loses *consciousness* and his *whole organism* experiences bliss at each of its points. Similarly, god-Man, when he experiences ecstasy, fills the universe with bliss and ignites a fire. Man-God appears as the bearer of universal consciousness.<sup>583</sup>

The aim of the solipsistic Spirit is to find a creative plateau of joyous sensuality, but the underlying theme of the text is a potent mixture of Kant, Schopenhauer, Hegel and Fichte, philosophers who all

---

<sup>578</sup> Ibid., 78-79.

<sup>579</sup> Bowers, *The New Scriabin: Enigma and Answers*, 69.

<sup>580</sup> Bowers, *Scriabin: A Biography 2*, 130.

<sup>581</sup> Swan, *Scriabin*, 94.

<sup>582</sup> Bowers, *Scriabin: A Biography 2*, 101.

<sup>583</sup> Ibid., 105.

recognised the problem of struggling towards the *Ideal*. To some extent Fichte, with his focus on the subjective 'I' as a gateway to Kant's 'thing in itself', was Skryabin's greatest solipsistic influence, in perfect accord with Novalis' 'magical idealism' which posited reality in the infinitely creative mind of the poet. As Hull says of Skryabin: "He held that in the artist's incessant creative activity, his constant progression towards the ideal, the spirit alone truly lives."<sup>584</sup> Striving occurs in Schopenhauerian philosophy and Hegelian 'Dialectical Materialist' philosophy as an inner drive-based discourse but the element of 'striving' in Skryabin's philosophy, however, doubtless came directly from Nietzsche. As early as 1894, Skryabin was delving into *Also sprach Zarathustra*, and its incessant preaching that 'mankind is something which must be overcome.'<sup>585</sup> Indeed, in Skryabin's notebooks at the time we read the emotionally downcast young performer battling with his hand injury, railing against fate but determining that he must overcome this obstacle. But here a crucial difference between Skryabin's earlier First Sonata and the later symphonic-poem emerges: the sonata was written with rage against God for the injury; he is determined to defy God and heal himself; in the *Poem of Ecstasy*, Skryabin *is* God. In a Nietzschean sense, Skryabin felt the need to overcome 'outer', 'social' struggles in his early works, just as the Spirit of the *Poem of Ecstasy* thinks it is doing. But Skryabin has evolved; he has begun to realise from an 'outer' perspective that the Will (Schopenhauer) / force (Hegel) / drive (Freud) comes from 'within': the drama is staged inside the solipsistic mind. This inner/outer element of Skryabin's thought, and certainly of the poetic *Poem of Ecstasy*, is also an element of the music, where the true 'ego theme' (Theme D) is called forth as an unconscious subject, moving through the contrapuntal orchestral texture, ever-striving. We witness the subject develop and produce polarities – the whole dialogue takes place 'within' the work's developmental structure and everything which negates or challenges the developing ego has occurred from within itself. But this knowledge of the subject, and its voracious imperative to struggle rather than rest, accords with the psychoanalysts who have known since Schopenhauer that, as Lacan says, "desire always seeks to go on desiring."<sup>586</sup> This was adopted by Skryabin and implanted into his own philosophy:

I can honestly affirm that I always want something... This is the most important and inflexible sign of life.<sup>587</sup>

The man who wants nothing, definitely nothing, must die at once.<sup>588</sup>

Skryabin began to build such ideas into the sounds he created. As Ivanov says, "he musically recreated the movements of will, the first timid tremblings and ecstatic delights of celestial spirits' bathing in the

<sup>584</sup> Hull, *Scriabin: A Great Russian Tone-Poet*, 259.

<sup>585</sup> Friedrich Nietzsche, *Thus Spoke Zarathustra*, trans. R. J. Hollingdale (London: Penguin Books).

<sup>586</sup> Fink, *A Clinical Introduction to Lacanian Psychoanalysis: Theory and Technique*, 1997 51.

<sup>587</sup> Bowers, *Scriabin: A Biography* 2, 102.

<sup>588</sup> *Ibid.*

universal expanses”.<sup>589</sup> The *Will*, for Schopenhauer, was equivalent to the Kantian *thing-in-itself* and this, in a pre-Freudian environment, became heavily laden with discussions of ‘desire’; and thus the difference between ‘desire’ and ‘drive’ is the difference between the (mistaken) conscious and the unconscious. Self-awareness, although it occurs in the textual poem as interjections from an external author, musically occurs in the plagal cadence, the twists towards *Nirvana*, the negation of, and *self-recognition-in-otherness* of the unconscious drive-based economy that characterises the most immediate harmonic operations. The ‘outer’ cadence at the end of the work, which retreats from both the desire-based and drive-based economies, can only be the self-awareness at the moment of dialectic apperception – the moment when the music itself realises that the *D* drive cannot be sublimated, and that a perfect cadence would only confirm the drive’s potency.

It seems that Skryabin was extremely quick to absorb Schopenhauer’s sexually charged writings on desire whilst planning the *Mysterium* – his “grandiose sexual climax” that would resolve the world’s tension and lead to Nirvana. In his last years he started to prefer miniatures to over-blown symphonies, and with this came a musical acceptance of Schopenhauer’s ascetic philosophy. This led to a depiction of the pre-symbolic realm of ‘drives’ in music. Skryabin certainly felt that he was conveying something deeper than symbolic language:

This sensation can’t be explained with words, can it?” he asked. “But it is made fully comprehensible in sounds. Many mystical sensations cannot be put into words at all, but can be transmitted through sounds. That’s why the path of the musician is easier”<sup>590</sup>

In Skryabin’s diaries we find this sad realisation of his failure to lead the world to ecstasy, marking a point of resignation of his whole ideology:

So, I realized that I was mistaken. If I recognised that the spirit created the whole world and he lives in all I’s, then I am not alone. It is necessary to change everybody’s view of the world in order for it to be changed. I am not able.<sup>591</sup>

Whether Skryabin was conscious of a philosophical change or not, his musical style certainly embraced a realisation that a subjective desire mechanism is ultimately a false representation of the objective drive beneath it, and that what underlay the human condition was actually unshaped, ever-shifting, libidinal drive energies flowing in and out of each other, each making demands on the subject but refusing to be sublimated except through death.

<sup>589</sup> Ivanov, *Selected Essays*. See chapter 1.

<sup>590</sup> «Этого ощущения ведь нельзя рассказать словами, правда? – спрашивал он. – Но оно вполне ясно из звуков. Многие мистические ощущения нельзя рассказать в словах, но звуками они передаются... Вот почему музыканту путь легче.» Sabaneyev, *Vospominaniya O Skryabine*, 162.

<sup>591</sup> Donald Weltzel, 'Anatoly Lunarchsky on Scriabin', *Journal of the Scriabin Society of America* 8/1 (2004).

## Conclusion

---

That Skryabin's compositional style underwent a slow metamorphosis is barely an original finding, but this thesis sought to illustrate that Skryabin's musical processes followed an aesthetic change fully congruent with his philosophical, psychological and cultural outlooks. I have used Skryabin's own writings and the testimonies of his companions to construct an interchange of hermeneutically derived binary oppositions. The passages between these oppositions structure Skryabin's compositional change. Yet the changes wrought were not irreversible. Skryabin moved from compositional forms based on a trajectory of *drive to desire* (mystic harmonies gradually unfolded into a single dominant → tonic motion) to one of *desire to drive* (mystic sonorities became unfolded into their component parts). But the former pattern still finds a home in late pieces in a different guise – i.e. *Prometheus*, Op.60. This change itself was a manifestation of a deeper move from *masculine* composition to *feminine* composition, but again this manoeuvre was not a one-way journey. In late pieces, such as Sonata no.6, a functionally rotational model drives the work from a deep *masculine* background, whilst a static, *feminine*, octatonic middleground produces a *masculine* foreground of striving V<sup>7</sup> chords. In each of Skryabin's metamorphoses – drive → desire, feminine → masculine, line → circle – his old style constantly serves to dialectically balance his new turn.

Concurrent with the Russian symbolist aesthetic, whose slogan was coined by Bryusov – “the truth, once, spoken, is a lie” – Skryabin sought to depict the Lacanian *Real* through the power of symbols – masculine / feminine / light / darkness, etc.<sup>592</sup> And yet Skryabin's ego got in the way, as the passage quoted at the end of the previous chapter shows. Realising that a universal climactic ecstasy was impossible, Skryabin wallows in his self-pity. But in choosing to follow a career which evolved in style from one based on desire to one rooted in drive, Skryabin actually successfully created a musical structure which closely paralleled the Lacanian *Real*, more so than he seems to have recognised himself, fixated as he was on more grandiloquent projects. In a sense we need Lacan to show Skryabin his own success. Skryabin did not need an orgiastic *Mysterium* to bring *jouissance*; Lacan shows on the contrary that *jouissance* is found in the free activity of the drive. And Skryabin, in his highly idiosyncratic style, captured this perfectly. This is not to say that Skryabin's earlier compositions, which encapsulated desire, were in any way irrelevant; the sublimation of drive into desire is just as *real* a process to the human subject as the activity of the unconscious beneath. And thus, at all stages of Skryabin's career, he was a success by the lights of his culture.

---

<sup>592</sup> Pyman, *A History of Russian Symbolism*, 16.



I sought to authenticate my findings by appealing to Skryabin's own recorded ideas, and in so doing tried to bridge the gap between musical thought and other disciplines. In the final analysis however, one can remove this bridge and still cross the gulf. Infinite strands of thought connect Skryabin's music to Lacanian psychoanalysis; for example, Lacan's entire theory of phallic anamorphosis was drawn directly from the Lithuanian poet Jurgis Baltrusaitis' book *Anamorphoses*. Baltrusaitis (1873-1944) was one of Skryabin's closest symbolist friends.<sup>593</sup> Kristeva, in turn, drew heavily on Skryabin's dialectical materialist companions as illustrated, creating a philosophical route into Skryabin's works. But such interchanges of ideas, no matter how anachronistic, are always justified since psychoanalysis tries to bring to light universal ideas, inherent in the human psyche, which naturally find conscious or unconscious expression in art. As Julia Kristeva puts it before analysing the work of Skryabin's contemporary Russian poets:

Freud himself considered writers as his predecessors. Avant-garde movements of the twentieth century, more or less unaware of Freud's discovery, propounded a practice, and sometimes even a knowledge of language and its subject, that kept pace with, when they did not precede, Freudian breakthroughs.<sup>594</sup>

Such philosophical / psychoanalytical ideas are deeply enshrined in Skryabin's music and, only by extension, his texts.

And thus the main thrust of this project has been a new approach to the harmonic language of Skryabin. In this, its real benefit lies only partly in the analyses that I have provided. Whilst my approach is bespoke to Skryabin, it is possible that it may represent the approaches of other 20<sup>th</sup> century composers who were trying to grapple with issues of desire in music. *Drive analysis* works with sonorities that contain dominant elements; this can be found in the work of many composers. Passages from early Schoenberg, even sections of Berg's *Wozzeck* could benefit from this form of analysis. Stravinsky too, particularly in his octatonic earlier works, constructs music around similarly dominant-rooted sonorities. Debussy, however, would be a less sensible choice; his music, generally more triadic than seventh-based, would resist *drive analysis* in many cases. Of course in this wider arena, my Lerdahl-derived taxonomy of drives would need to be revised, either by extension – to cover all possible dominant functioned chords – or contraction – tailored to the specific needs of a work under consideration. But in any case, the real value of *drive analysis* is that it closely maps many possible ways of hearing a particular passage, without seizing only one particular route through a sound pattern and proclaiming it as gospel. The true gift of 20<sup>th</sup> century music is ambiguity, which analysts desperately try to suppress. In using Lerdahl's theories very selectively, I have in effect proposed an 'anti-Lerdahl'.

---

<sup>593</sup> Lacan, *The Four Fundamental Concepts of Psychoanalysis*, 85-87.

<sup>594</sup> Julia Kristeva, *Desire in Language: A Semiotic Approach to Literature and Art* (New York: Columbia University Press, 1980), 26.

Rather than turn the many faces of an analysis inwards and fasten them tightly to a single interpretation, *drive analysis* more accurately unveils the many simultaneous interpretations that coexist. And in addition to plausible analyses that are based on 'realised' musical procedures – procedures which retrospectively validate preliminary analysis – *drive analysis* charts 'implied' procedures. Often the implications found are not realised, but pulsate nonetheless, like the drives of the human subject, in 20<sup>th</sup> century music.

## Bibliography

---

- M. H. Abrams, *The Mirror and the Lamp: Romantic Theory and the Critical Tradition*, Oxford: OUP, 1971
- M. H. Abrams, *Natural Supernaturalism: Tradition and Revolution in Romantic Literature*, New York: Norton, 1973
- T. W. Adorno, *Philosophy of Modern Music*, London: Sheed & Ward, 1948
- H. Antcliffe, 'The Significance of Scriabin', *The Musical Quarterly* 10/3 (1924): 333-345
- J. M. Baker, *The Music of Alexander Scriabin*, New Haven: Yale University Press, 1986
- J. M. Baker, 'Scriabin's Implicit Tonality', *Music Theory Spectrum* 2 (1980): 1-18
- J. M. Baker, D. Beach and J. W. Bernard, *Music Theory in Concept and Practice*, Rochester, NY: University of Rochester Press, 1997
- N. Baker, 'Der Urstoff Der Musik': Implications for Harmony and Melody in the Theory of Heinrich Koch', *Music Analysis* 7/1 (1988): 3-30
- G. A. Barborka, *The Story of Human Evolution*, Madras, India ; Wheaton, Ill.: Theosophical Pub. House, 1980
- J.P. Barricelli, *Liszt's Journey through Dante's Hereafter*, *Bucknell Review*, XXVI, No. 2, 1980, 149-166.
- R. Bartlett, *Wagner & Russia* Cambridge: Cambridge University Press, 1995
- G. Bataille, *Eroticism*, London: Penguin Books Ltd., 2001
- G. Bataille, *The Tears of Eros*, San Francisco: City Lights Books, 2002
- B. M. Belyayev, *Musorgskii, Skryabin, Stravinskii*, Moskva: Izdatel'stvo "Muzyka", 1972
- H. Benjamin, *Everyone's Guide to Theosophy: A Simple Explanation of the Theosophical Teachings for the New Student*, London: Theosophical Publishing, 1969
- N. Berdyayev, 'Regarding a Certain Remarkable Book (O. Weininger: Sex and Character)', *Voprosy filosofii i psikhologii* /98 (1909): 494-500 ([www.berdyayev.com/berdiaev/berd\\_lib/1909\\_157\\_4.html](http://www.berdyayev.com/berdiaev/berd_lib/1909_157_4.html) - 04/02/06)
- A. Berger, 'Problems of Pitch Organization in Stravinsky', *Perspectives of New Music* 2/1 (1963): 11-42
- J. Bernard, 'The Principle Elements: Rameau's "Controversy with D'alembert"', *Journal of Music Theory* 24/1 (1980): 37-62
- H. P. Blavatsky, *The Secret Doctrine: The Synthesis of Science, Religion and Philosophy*, Pasadena: Theosophical University Press, 1999
- K. Bottge, 'Brahms' "Wiegenlied" and the Maternal voice', *19<sup>th</sup> Century Music* 38/3 (2005), 185-213

- F. Bowers, *The New Scriabin: Enigma and Answers*, Newton Abbot, London: David & Charles (Holdings) Ltd, 1974
- F. Bowers, *Scriabin: A Biography 1*, New York: Dover Publications, 1996
- F. Bowers, *Scriabin: A Biography 2*, New York: Dover Publications, 1996
- A. Bowie, *Schelling and Modern European Philosophy: An Introduction*, London: Routledge, 1993
- C. Brower, 'A Cognitive Theory of Musical Meaning', *Journal of Music Theory* 44/2 (2000): 323-379
- M. Brown, 'Scriabin and Russian Mystic Symbolism', *Nineteenth-Century Music* 3 (1979): 44
- R. Browne, 'Tonal Implications of the Diatonic Set', *In Theory Only* 5/6-7 (1981): 3-21
- T. Burns, *The Iliad and the 'Struggle for Recognition' in Hegel's Phenomenology of Spirit*, University of Nottingham ([www.hlss.mmu.ac.uk/dev/wpt05/](http://www.hlss.mmu.ac.uk/dev/wpt05/) - 12/06/05).
- M. Carlson, *No Religion Higher Than Truth: A History of the Theosophical Movement in Russia, 1875-1922* Princeton, N.J: Princeton University Press, 1993
- E. Carpenter, 'Scriabin's Octatonic Motives', *Journal of the Scriabin Society of America* 8/1 (2004): 45-57
- E. Carpenter, *Thematic Development and Continuity in the Ten Piano Sonatas of Alexander Scriabin* (MA: Kent State University, 1972)
- A. P. Childs, 'Moving Beyond Neo-Riemannian Triads: Exploring a Transformational Model for Seventh Chords', *Journal of Music Theory* 42/2 (1998): 181-193
- T. S. Christensen, *Rameau and Musical Thought in the Enlightenment*, Cambridge: Cambridge University Press, 1993
- M. J. Citron, *Gender and the Musical Canon*, Cambridge: Cambridge University Press, 1993
- C. Clément, *Opera, or the Undoing of Women*, Minneapolis: University of Minnesota Press, 1988
- R. Cohn, 'As Wonderful as Star Clusters: Instruments for Gazing at Tonality in Schubert', *19th-Century Music* 22/3 (1999): 213-232
- R. Cohn, 'Maximally Smooth Cycles, Hexatonic Systems, and the Analysis of Late-Romantic Triadic Progressions', *Music Analysis* 15/1 (1996): 9-40
- N. Cook, *A Guide to Musical Analysis*, London: Dent, 1987
- M. Cooper, 'Scriabin's Mystical Beliefs', *Music & Letters* 16/2 (1935): 110-115
- J. H. Cousins, J. Delville and N. K. Rerikh, *Two Great Theosophist-Painters, Jean Delville, Nicholas Roerich*, Madras: Theosophical Publishing House, 1925
- S. Cusick, 'Gendering Modern Music: Thoughts on the Monteverdi - Artusi Controversy', *Journal of The American Musicological Society* (1993): 1-25
- C. Dahlhaus, *Between Romanticism and Modernism*, Berkeley: University of California Press, 1989

- B. de Schloezer, *Scriabin: Artist and Mystic*, Oxford: Oxford University Press, 1987
- G. Deleuze and F. Guattari, *Anti-Oedipus*, London: Continuum, 1988
- G. Deleuze and F. Guattari, *A Thousand Plateaus: Capitalism and Schizophrenia*, London: Continuum, 1988
- G. Deleuze and D. Lapoujade, *Two Regimes of Madness: Texts and Interviews, 1975-1995*, New York: Semiotext(e) ; London : MIT Press [distributor], 2006
- J. Delville and F. Colmer, *The New Mission of Art, a Study of Idealism in Art*, London: F. Griffiths, 1910
- V. Dernova, *Garmoniia Skriabina*, Leningrad: Izd-vo "Muzyka", 1968
- J. Derrida, 'Differance', *Margins of Philosophy*, Chicago: The University of Chicago Press, 1982. 3-27
- S. Downes, *The Muse as Eros: Music, Erotic Fantasy and Male Creativity in the Romantic and Modern Imagination*, Aldershot: Ashgate, 2006
- S. Downes, 'Szymanowski and Narcissism', *Journal of the Royal Musical Association* 121/1 (1996): 58-81
- S. Downes, *Szymanowski, Eroticism and the Voices of Mythology*, Ashgate: RMA, 2003
- L. Ellrich, 'Negativity and Difference: On Gilles Deleuze's Criticism of Dialectics', *MLN* 111/3 (1996): 463-487
- J. Elsworth, *Andrey Bely: A Critical Study of the Novels*, Cambridge: Cambridge University Press, 1983
- B. Fink, *A Clinical Introduction to Lacanian Psychoanalysis: Theory and Technique*, Cambridge, Massachusetts: Harvard University Press, 1997
- M. Foucault, *The History of Sexuality. Vol.1, an Introduction*, Harmondsworth: Penguin, 1981
- S. Freud, *Beyond the Pleasure Principle*: London, Vienna, 1922
- S. Freud, *The Complete Works of Sigmund Freud, xiv*, London: Hogarth Press, 1957
- S. Freud, *The Complete Works of Sigmund Freud, xxiii*, London: Hogarth Press, 1957
- S. Friedrichsmeyer, *The Androgyne in Early German Romanticism: Friedrich Schlegel, Novalis and the Metaphysics of Love*, Bern: Peter Lang, 1983
- S. Garcia, 'Scriabin's Symbolist Plot Archetype in the Late Piano Sonatas', *19th Century Music* XXIII/No. 3 (2000): 273-300
- S. P. Garcia, *Alexander Skryabin and Russian Symbolism: Plot and Symbols in the Late Piano Sonatas* (D.M.A.: The University of Texas at Austin, 1993)
- R. Guenther, *Varvara Dernova's "Garmoniia Skriabina": A Translation and Critical Commentary* (PhD: The Catholic University of America, 1979)
- R. J. Guenther, 'Varvara Dernova's System of Analysis of the Music of Skriabin.' *Russian Theoretical Thought in Music*. Ann Arbor, Michigan: UMI, 1983.

- R. K. Gupta, 'Freud and Schopenhauer', *Journal of the History of Ideas* 36/4 (1975): 721-728
- D. Harrison, 'Bitonality, Pentatonicism, and Diatonicism in a Work by Milhaud', *Music Theory in Concept and Practice*, ed. J. Baker. Rochester, NY: University of Rochester Press, 1997. 393-408
- D. Harrison, *Harmonic Function in Chromatic Music: A Renewed Dualist Theory and an Account of Its Precedents*, Chicago: University of Chicago Press, 1994
- J. Hepokowski, 'Masculine - Feminine', *Musical Times* 150 (1994): 494-99
- B. Hoekner, *Programming the Absolute: Nineteenth-Century German Music and the Hermeneutics of the Moment*, Princeton, N.J. ; Woodstock: Princeton University Press, 2002
- A. E. Hull, *Scriabin: A Great Russian Tone-Poet*, London: Kegan Paul, Trench, Trubner & Co., Ltd., 1918
- D. Huron, *Sweet Anticipation: Music and the Psychology of Expectation*, Cambridge, Mass. ; London: MIT, 2006
- V. I. Ivanov, R. Bird and M. Wachtel, *Selected Essays*, Evanston, Ill.: Northwestern University Press, 2003
- B. Jakobson, 'Scriabin Symphonies 1,2,3, Le Poeme De L'extase, Promethee ', 2001 (CD-724356772021, Booklet, 8)
- M. James, *Freud, Lacan and the Psychoanalytic Drive*: <http://www.lacan.org/drives.htm> - 04/02/06
- P. Kaminsky, 'Ravel's Late Music and the Problem of 'Polytonality'', *Music Theory Spectrum* 26/2 (2004): 237-264
- M. Kelkel, *Alexandre Scriabine: Sa Vie, L'esoterisme Et Le Langage Musical Dans Son Oeuvre*, Paris: Champion, 1984
- I. Khannanov, *Russian Methodology of Musical Form and Analysis* (PhD, Santa Barbara: University of California, 2003)
- L. Kramer, *Franz Schubert: Sexuality, Subjectivity, Song*, Cambridge: Cambridge University Press, 1998
- L. Kramer, *Music as Cultural Practice, 1800-1900*, Berkeley: University of California Press, 1990
- H. Krebs, 'Alternatives to Monotony in Early Nineteenth-Century Music', *Journal of Music Theory* 25/1 (1981): 1-16
- J. Kristeva, *Desire in Language: A Semiotic Approach to Literature and Art*, New York: Columbia University Press, 1980
- J. Kristeva, *The Kristeva Reader*, New York: Columbia University Press, 1986
- J. Kristeva, *Powers of Horror: An Essay on Abjection*, New York ; Oxford: Columbia University Press, 1982
- J. Kristeva, *Revolution in Poetic Language*, New York: Columbia University Press, 1984
- J. Kristeva, & C. Clément, *The Feminine and the Sacred*, Basingstoke: Palgrave, 2001

- E. Kurth, *Ernst Kurth: Selected Writings*, Cambridge: Cambridge University Press, 1991
- J. Lacan, *Écrits: A Selection*, London: Tavistock Publications, 1977
- J. Lacan, *The Four Fundamental Concepts of Psychoanalysis*, London: Vintage, 1998
- J. Lacan, J. Mitchell and J. Rose, *Feminine Sexuality: Jacques Lacan and the Ecole Freudienne*, New York: W.W. Norton, 1985
- G. Lambert, 'Deleuze and The "Dialectic" (A.K.A. Marx and Hegel)', *Strategies: Journal of Theory, Culture & Politics* 15/1 (2002): 73-83
- S. Larson, 'A Tonal Model of an 'Atonal' Piece: Schoenberg's Opus 15, Number 2', *Perspectives of New Music* 25 (1987): 418-433
- J. Lechte and M. Margaroni, *Julia Kristeva: Live Theory*, New York: Continuum, 2004
- A. Lemaire, *Jacques Lacan*, London: Routledge & Kegan Paul, 1977
- E. Lendvai, *Béla Bartók: An Analysis of His Music*, London: Kahn & Averill, 1971
- E. Lendvai, *Symmetries of Music: An Introduction to the Semantics of Music*, Kecskemét: Kodály Institute, 1993
- F. Lerdahl, *Tonal Pitch Space*, Oxford: Oxford University Press, 2001
- F. Lerdahl and R. Jackendoff, *A Generative Theory of Tonal Music*, Cambridge: MIT Press, 1983
- D. Lewin, 'Amfortas's Prayer to Titirel and the Role of D in Parsifal: The Tonal Spaces of the Drama and the Enharmonic C/B $\flat$ ', *19th-Century Music* 7 (1983-4): 336-49
- J. F. Lyotard, *Libidinal Economy*, London: Continuum, 2004
- H. Macdonald, *Skryabin*, London: Oxford University Press, 1978
- M. Macfarland, 'Transpositional Combination and Aggregate Formation in Debussy', *Music Theory Spectrum* 27/2 (2005): 187-220
- T. Mann, *Thomas Mann Presents the Living Thought of Schopenhauer*, London: Cassel, 1939
- K. Marx, *Capital*: London: Lawrence & Wishart, 1956-59, 1977
- R. E. Matlaw, 'Scriabin and Russian Symbolism', *Comparative Literature* 31/1 (1979): 1-23
- S. McClary, *Feminine Endings: Music, Gender, and Sexuality*, Minneapolis: University of Minnesota Press, 1991
- A. McNamee, 'Bitonality: Mode and Interval in the Music of Karol Szymanowski', *Journal of Music Theory* 29 (1985): 61-84
- L. B. Meyer, *Emotion and Meaning in Music*, Chicago: University of Chicago Press, 1956

- L. B. Meyer, *Explaining Music: Essays and Exploration*, Chicago: University of Chicago Press, 1978
- L. B. Meyer, *The Spheres of Music: A Gathering of Essays*, Chicago: University of Chicago Press, 2000
- M. A. Miller, *Freud and the Bolsheviks: Psychoanalysis in Imperial Russia and the Soviet Union*, New Haven: Yale University Press, 1998
- M. B. Morris, *Musical Eroticism and the Transcendent Strain: The Works of Alexander Skryabin, 1898-1908* (PhD Berkeley: University of California, 1998)
- S. Morrison, 'The Semiotics of Symmetry, or Rimsky-Korsakov's Operatic History Lesson', *Cambridge Opera Journal* 13/3 (2001): 261-293
- S. Morrison, 'Skryabin and the Impossible', *Journal of The American Musicological Society* 51/21 (1998): 283-330
- E. Narmour, *The Analysis and Cognition of Basic Melodic Structures: The Implication-Realization Model*, Chicago: University of Chicago Press, 1990
- J. Nattiez, 'The Concepts of Plot and Seriation Process in Music Analysis', *Music Analysis* 4/1/2 (1985): 107-118
- J. Nattiez, *Wagner Androgynous: A Study in Interpretation*, Princeton, N.J. ; Chichester: Princeton University Press, 1993
- A. Newcomb, 'The Birth of Music out of the Spirit of Drama: An Essay in Wagnerian Formal Analysis', *19th-Century Music* 5/1 (1981): 38-66
- R. Newmarch, *The Concert-Goer's Library of Descriptive Notes 6*, London: Humphrey Milford, 1928
- F. W. Nietzsche, *The Birth of Tragedy Out of the Spirit of Music*, London: Penguin, 1993
- K. J. Peacock, *Alexander Scriabin's Prometheus: Philosophy and Structure* (PhD Michigan: University of Michigan, 1976)
- G. Perle, 'Scriabin's Self Analyses', *Music Analysis* 3/2 (1984): 101-122
- G. Plekhanov, 'The Meaning of Hegel', *Fourth International* 10/April and May (1949): 119, 152.  
<http://www.marxists.org/archive/plekhanov/1891/11/hegel-dun.htm> - 04/02/06
- G. Plekhanov, *Fundamental Problems of Marxism*. London: Lawrence & Wishart, 1969
- B. Pomeroy, 'Tale of Two Tonics: Directional Tonality in Debussy's Orchestral Music', *Music Theory Spectrum* 26/1 (2004): 87-118
- A. Pople, 'Skryabin's Prelude, Op. 67, No. 1: Sets and Structure', *Music Analysis* 2/2 (1983): 151-173
- A. Pyman, *Aleksandr Blok: 'The Twelve'*, Newcastle: University of Durham, Tyneside Free Press, 1989
- A. Pyman, *A History of Russian Symbolism*, Cambridge: Cambridge University Press, 1994
- A. Pyman, *The Life of Alexander Blok*, Oxford: Oxford University Press, 1980



- W. Reich, *The Function of the Orgasm*, London: Souvenir Press Ltd., 1993
- J. Reise, 'Late Scriabin: Some Principles Behind the Style', *19th Century Music* 6/3 (1983): 220-231
- L. Sabaneyev, *Vospominaniya O Skryabine*, Moscow: Classica XXI, 2003
- L. Sabaneeff, 'A. N. Scriabin - a Memoir', *Russian Review* 25/3 (1966): 257-267
- L. Sabaneyev, *Modern Russian Composers*, New York: Da Capo Press, 1975
- L. Sabaneyev, 'The Seventh Piano Sonata, Op.64', *Muzyka Weekly* 64 (1912): 196-201
- P. Sabbagh, *The Development of Harmony in Scriabin's Works*, USA: Universal Publishers, 2003
- J. Samson, *Music in Transition: A Study of Tonal Expansion and Atonality, 1900-1920*, London: Dent, 1977
- J. Samson, *The Music of Szymanowski*, London: Kahn & Averill, 1980
- J. Saslaw, 'Forces, Containers, and Paths: The Role of Body-Derived Image Schemas in the Conceptualization of Music', *Journal of Music Theory* 40/2 (1996): 217-243
- H. Schenker, *Harmony*, Chicago: UCP, 1906 (1968)
- A. Schopenhauer, *The World as Will and Idea*, London: J.M. Dent, 2004
- A. Scriabin, '*Poem of Ecstasy*' and '*Prometheus: Poem of Fire*' in *Full Score*, New York: Dover Publications, Inc., 1995
- M. A. Smart, *Siren Songs: Representations of Gender and Sexuality in Opera*, Princeton: Princeton University Press, 2000
- M. Spitzer, *Music as Philosophy: Adorno and Beethoven's Late Style*, Bloomington, Indiana: Indiana University Press, 2006
- A. Steinberg, *Word and Music in the Novels of Andrey Bely*, Cambridge: Cambridge University Press, 1982
- J. Stell, 'Music as Metaphysics: Structure and Meaning in Skryabin's Fifth Piano Sonata', *Journal of Musicological Research* 23/1 (2004): 1-37
- A. J. Swan, *Scriabin* London: John Lane: The Bodley Head Ltd., 1923
- K. J. Swinden, 'When Functions Collide: Aspects of Plural Function in Chromatic Music', *Music Theory Spectrum* 27/2 (2005): 249-282
- E. Tarasti, *Myth and Music: A Semiotic Approach to the Aesthetics of Myth in Music, Especially That of Wagner, Sibelius and Stravinsky*: Mouton, 1979
- R. Taruskin, 'Chernomor to Kashchei: Harmonic Sorcery; or, Stravinsky's "Angle"', *Journal of The American Musicological Society* 38/1 (1985): 72-142
- R. Taruskin, 'Review: "The Music of Alexander Scriabin", James M. Baker & "Scriabin: Artist and Mystic", Boris de Schloezer', *Music Theory Spectrum* 10/10th Anniversary Issue (1988): 143-169

- R. Taruskin, 'Scriabin and the Superhuman: A Millennial Essay ', *Defining Russia Musically*. Princeton University Press, 1997.
- D. Temperley, 'The Line of Fifths', *Music Analysis* 19/3 (2000): 289-319(31)
- P. Van den Toorn, *Stravinsky and the Rite of Spring: The Beginnings of a Musical Language*, Oxford: Oxford University Press, 1987
- M. Wachtel, *Russian Symbolism and Literary Tradition: Goethe, Novalis and the Poetics of Vyacheslav Ivanov*, Wisconsin: University of Wisconsin Press, 1994
- C. Wai-Ling, *The Late Scriabin: Pitch Organisation and Form in the Works of 1910-14* (PhD Cambridge: Cambridge University, 1991)
- C. Wai-Ling, 'Scriabin's "White Mass": Dialogue between The "Mystic" And The "Octatonic"', *Journal of the Scriabin Society of America* 5/1 (2001): 69-93
- O. Weininger, *Sex & Character*, New York: Howard Fertig, 2003
- D. Weltzel, 'Anatoly Lunarchsky on Scriabin', *Journal of the Scriabin Society of America* 8/1 (2004): 37-43
- J. West, *Russian Symbolism: A Study of Vyacheslav Ivanov and the Russian Symbolist Aesthetic*, London: Methuen, 1970
- R. Willmann, 'Alexander Skryabin's Sixth Piano Sonata, Op. 62', *Journal of the Scriabin Society of America* 8/1 (2003-2004): 21-33
- M. Yanovitsky, 'Scriabin Etudes, Op.8 as a Set', *Journal of the Scriabin Society of America* 7/1 (2002): 19-25
- S. Žižek, *Looking Awry: An Introduction to Jacques Lacan through Popular Culture*, Cambridge, Mass.: MIT Press, 1991























## **Appendices A-F: Graphical Analyses**

**Desire and the Drives: A New Analytical Approach to the  
Harmonic Language of Alexander Skryabin**

---

Kenneth Smith  
University of Durham  
Thesis Submitted for the Degree of PhD  
2008

	[pc]	C major	Description
	[1,5,7,11]	G B D $\flat$ F	<i>Dominant-seventh chord with a diminished fifth</i>
	[3,5,7,11]	G B D $\sharp$ F	<i>Dominant-seventh chord with an augmented fifth</i>
	[2,5,7,11]	G B D F	<i>Pure dominant seventh chord</i>
	[1,5,7,10]	G B $\flat$ D $\flat$ f	<i>Diminished chord with additional seventh ('half diminished')</i>
	[2,5,8,11]	B D F A $\flat$	<i>Full diminished seventh chord</i>
	[3,7,11]	G B D $\sharp$	<i>A three-way drive comprised of major thirds. Only charted if orthographically or contextually specific</i>
	[5,7,11]	G B F	<i>Implicit dominant-seventh chord; omitted fifth</i>
	[2,6,7,11]	G B D F $\sharp$	<i>'Major seventh' chord</i>
	[2,5,11]	B D F	<i>Diminished triad. Only charted if orthographically or contextually specific</i>
	[2,7,11]	G B D	<i>Pure triad. Only charted if it acts as a clear V</i>
	[2,6,7,10]	G B $\flat$ D F $\sharp$	<i>Minor chord with an additional 'major seventh'</i>
	[2,5,7,10]	G B $\flat$ D F	<i>Minor seventh chord</i>
	[5,11]	B F	<i>Pure tritone drive. May resolve in two directions, but only charted if contextually implicit of stronger drive</i>
	[2,5,7]	G D F	<i>Dominant-seventh chord; third omitted</i>
	[5,7]	G F	<i>A pure seventh. A very weak drive, but one that can be contextually strengthened. Not usually charted</i>
	[0,4,7]	C E G	<i>Purely articulated Tonic major chord</i>
	[0,3,7]	C E $\flat$ G	<i>Purely articulated Tonic minor chord</i>
	[0,3,4,7]	C E $\flat$ E $\sharp$ G	<i>Tonic major / minor chord</i>
			<i>Bass tone. Often overlaps the other symbols, represented by the characteristic black border.</i>
			<i>Foreground Pitch Discharge. Often a very small-scale discharge involving one or two individual pitches.</i>

## Key to Appendices A - F

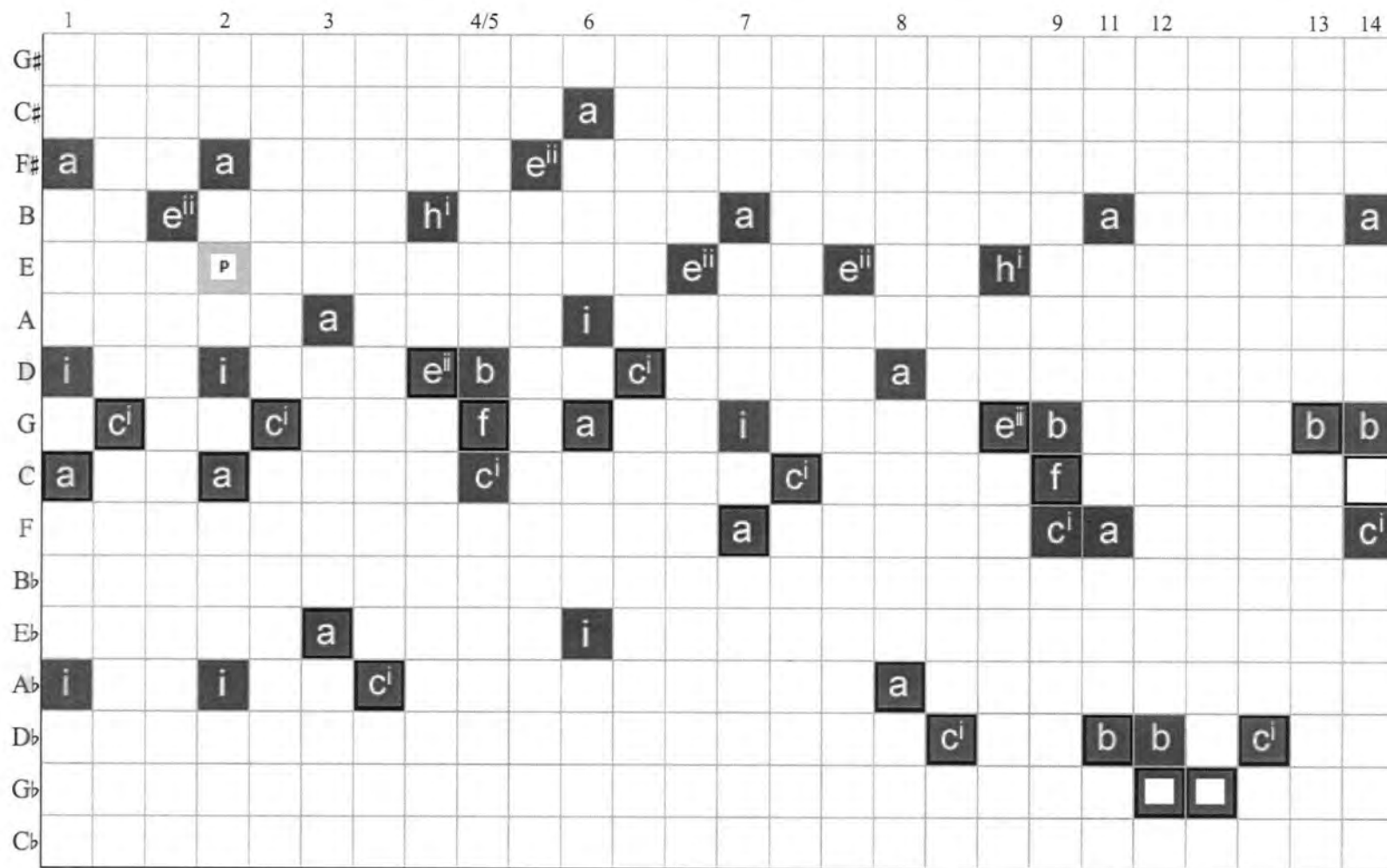

	1	2	3	4	5	6	7	8	9	10	11	12	13	14	15	16	17	18	19	20	21	22	23	24	25	26	27	28	29	30		
F#	a	a															a	a										c <sup>ii</sup>	c <sup>ii</sup>			
B									a	a							f		b													
E				a													h <sup>i</sup>	p														
A					a								a														h <sup>iii</sup>	h <sup>iii</sup>				
D	i							c <sup>i</sup>						a											a	a						
G			k					e <sup>ii</sup>	i							c <sup>i</sup>										p				k		
C	a	a			i							k																				
F		a	e <sup>ii</sup>		i				a	a				i																c <sup>ii</sup>		
B <sup>b</sup>				a							a	e <sup>ii</sup>		i																		
E <sup>b</sup>					a									a								a	a									
A <sup>b</sup>	i	c <sup>i</sup>			i	p								a																		
D <sup>b</sup>										c <sup>i</sup>					p																	
G <sup>b</sup>																																
C <sup>b</sup>		a			i									i																		
F <sup>b</sup>											a			i																		
B <sup>bb</sup>																																

Appendix B: *Caresse dansée*, Op.57

	31	32	33	34	35	36	37	38	39	40	41	42	43	44	45	46	47	48	49	50	51	52	53	54	55	56	57	58	59
F#																													
B								a											a	a									
E																													
A																							a						
D																								a		a			
G	k							a	b	b								b	i									b	
C	□	□	b							□	b												k						□
F	c <sup>ii</sup>			a				a				a					e <sup>ii</sup>		a	a			i						
B $\flat$				b									b				□				a	e <sup>ii</sup>		i		i			
E $\flat$					a									a									a						
A $\flat$						b								b										a		a			
D $\flat$							a								a					c <sup>i</sup>				p		p			
G $\flat$																													
C $\flat$				a								a																	
F $\flat$																							a						
B $\flat\flat$					a										a														

Appendix B: *Caresse dansée*, Op.57 (cont.)

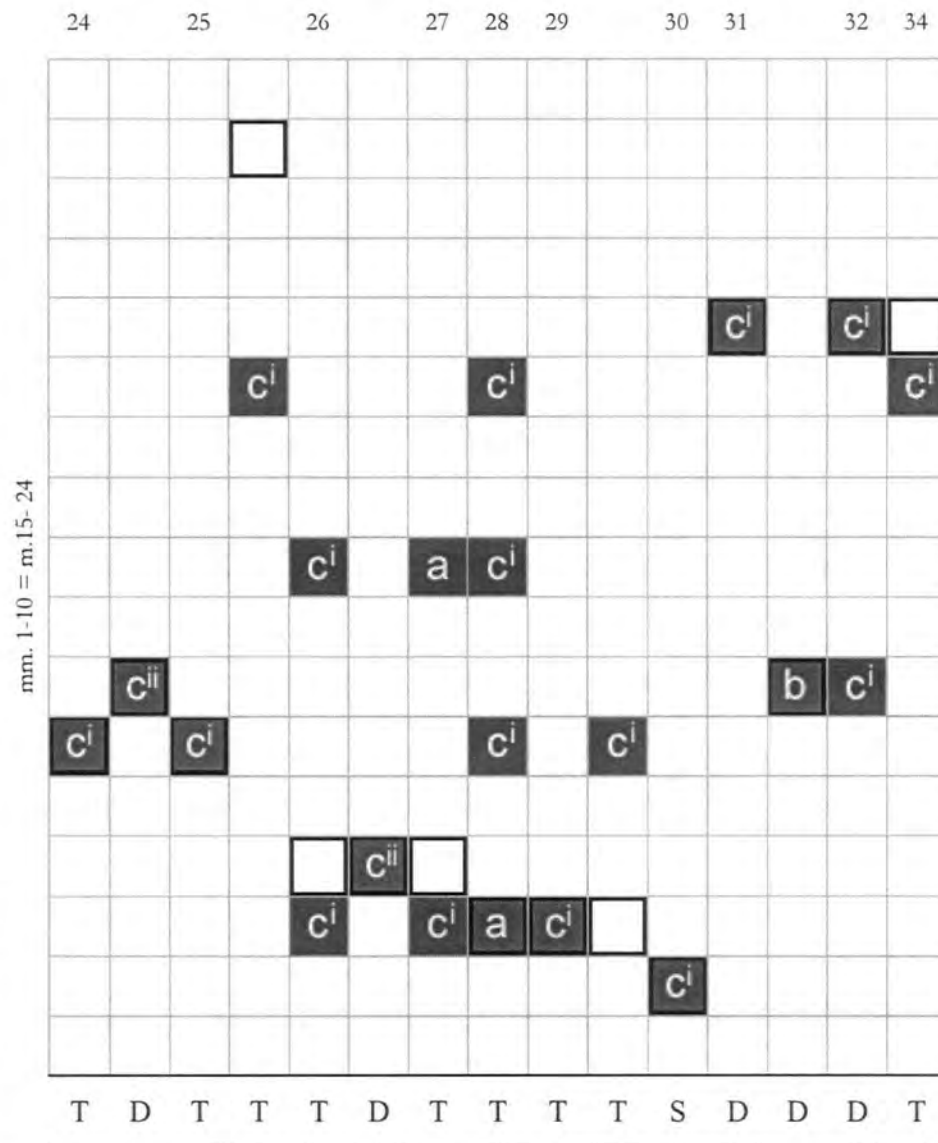
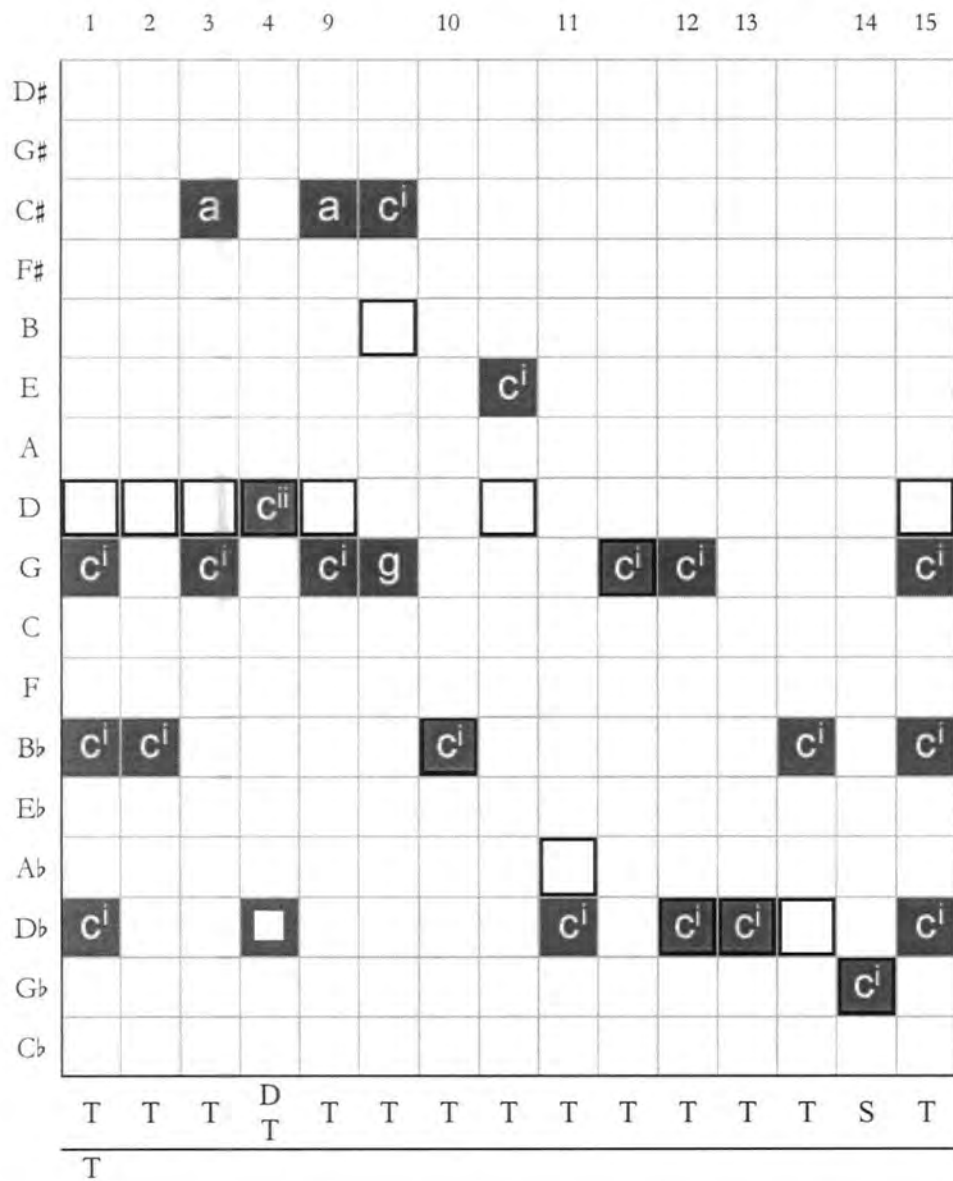

mm. 1-10 = m.15-24

Appendix C: Sonata No.6, Op.62



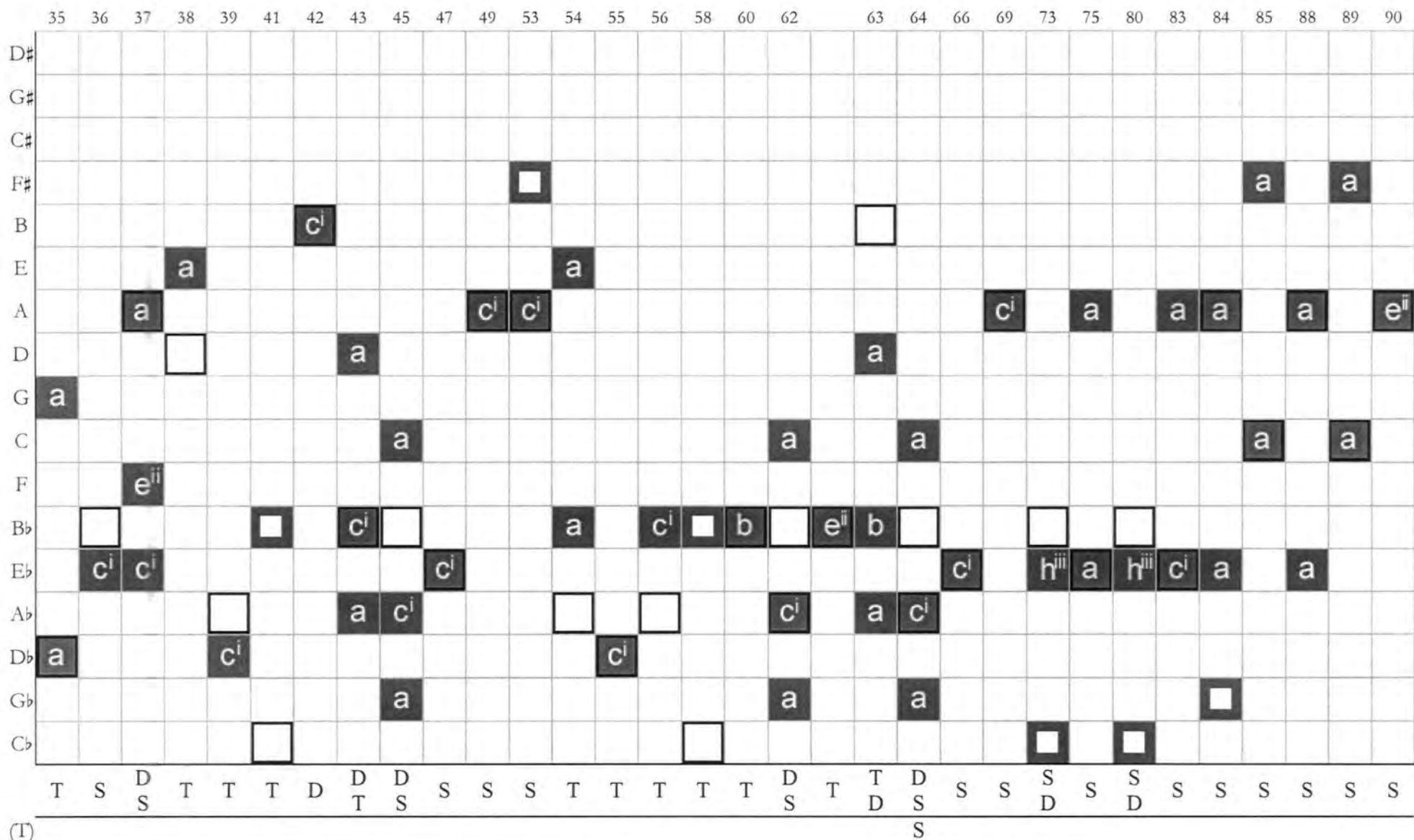

Appendix C: Sonata No.6, Op.62 (cont.)

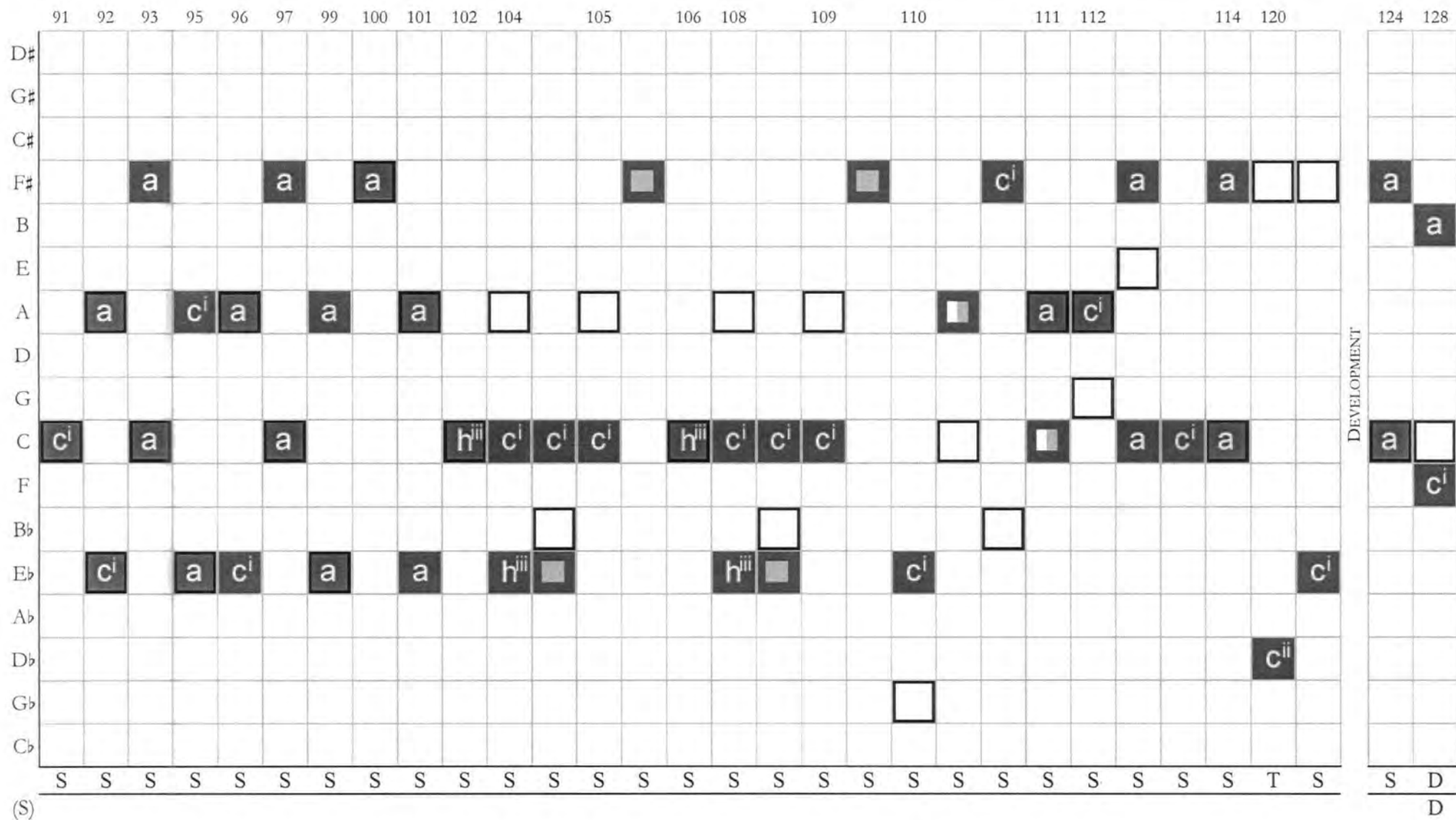

Appendix C: Sonata No.6, Op.62 (cont.)

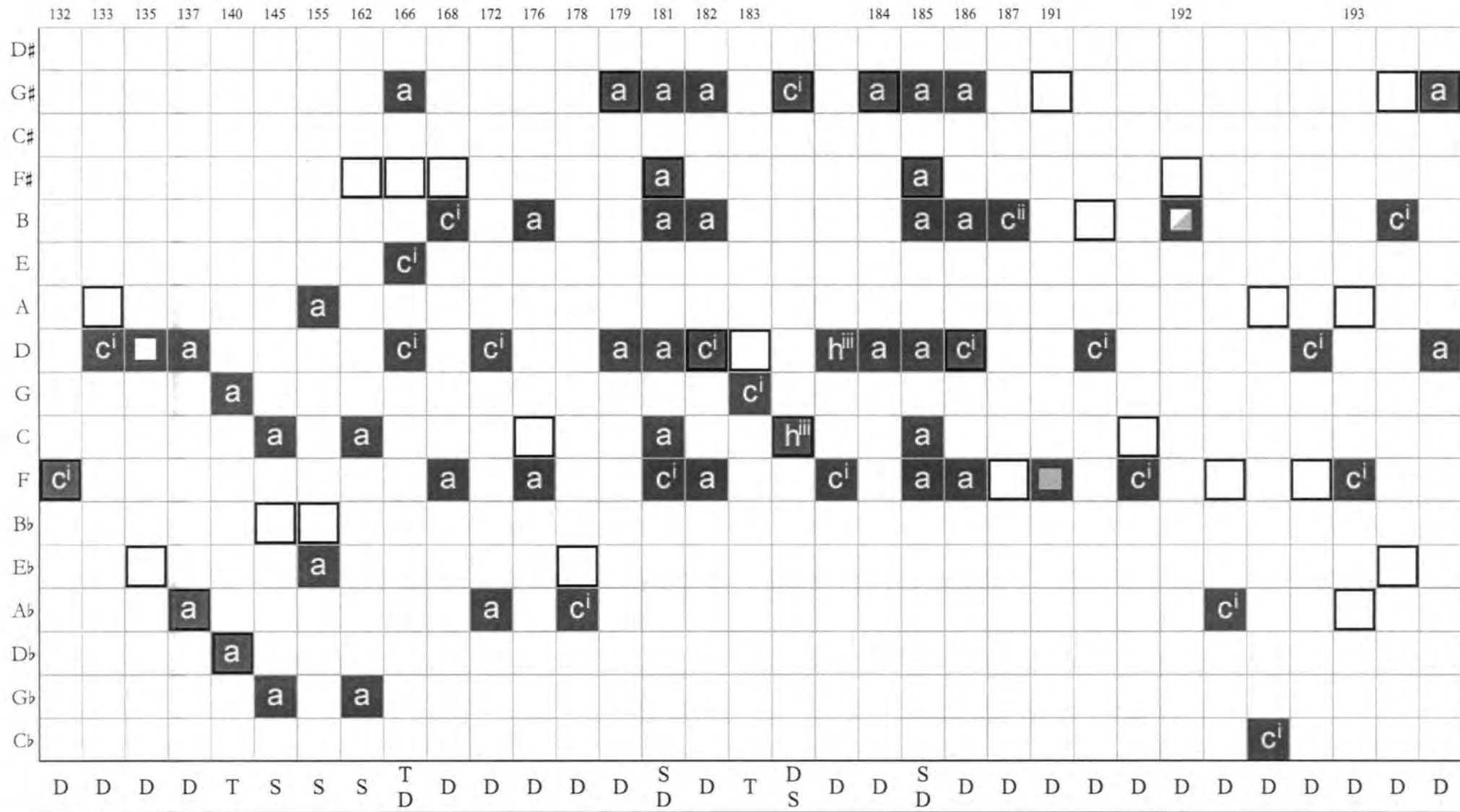

Appendix C: Sonata No.6, Op.62 (cont.)

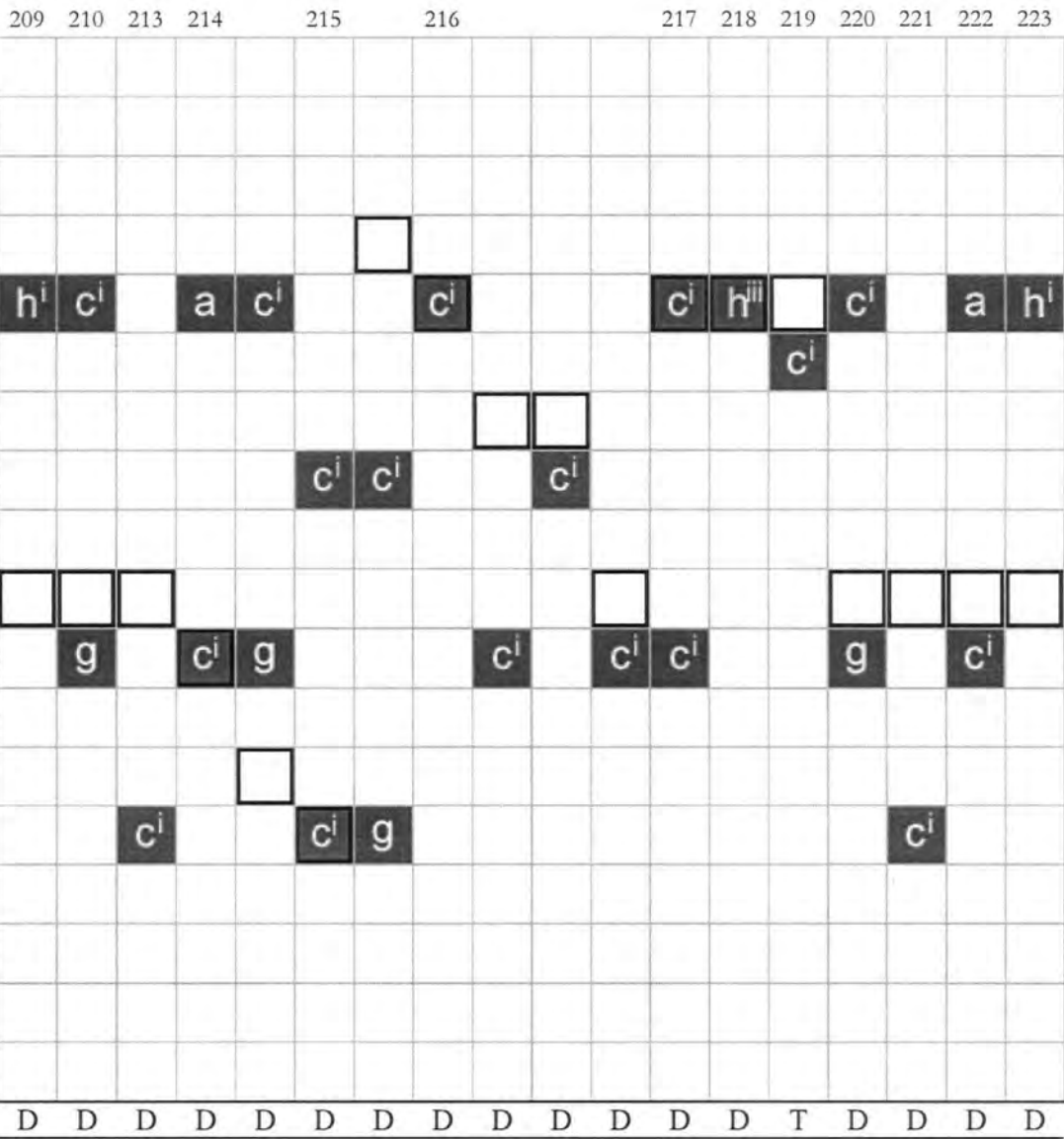
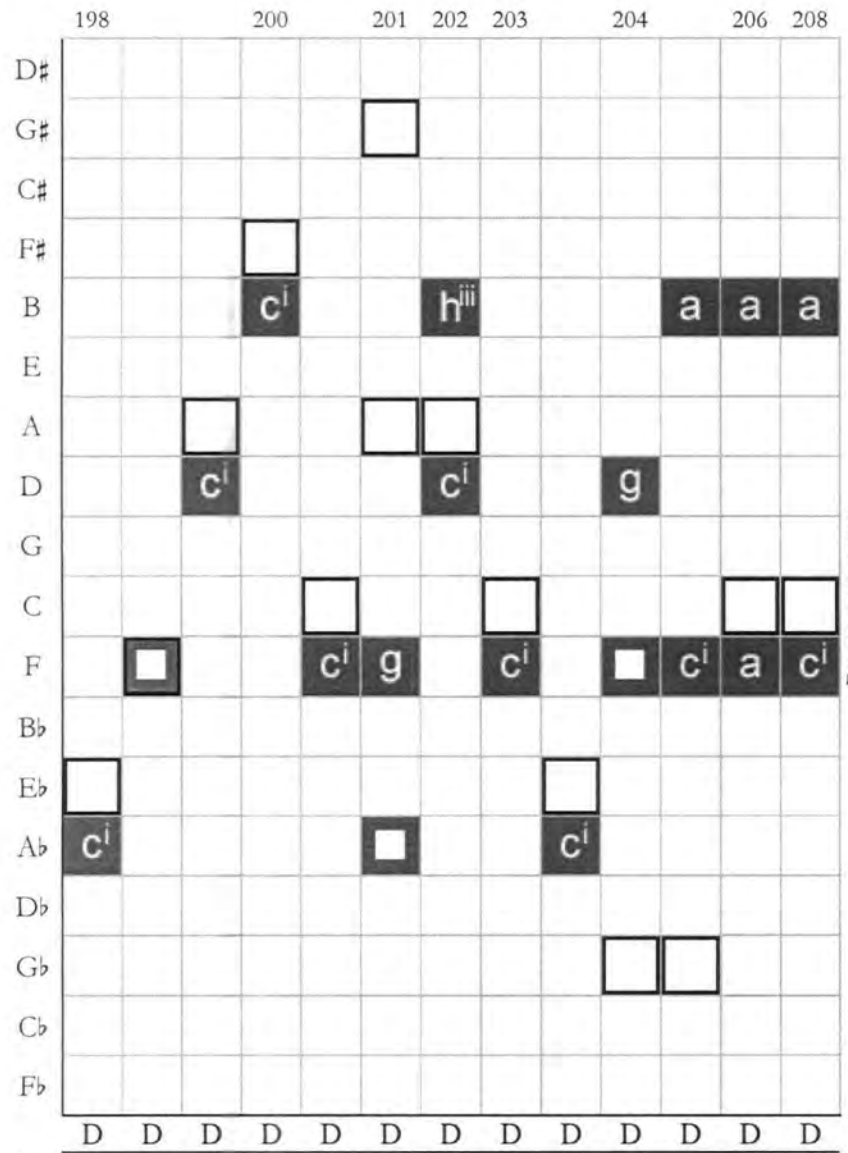

RECAPITULATION

Appendix C: Sonata No.6, Op.62 (cont.)

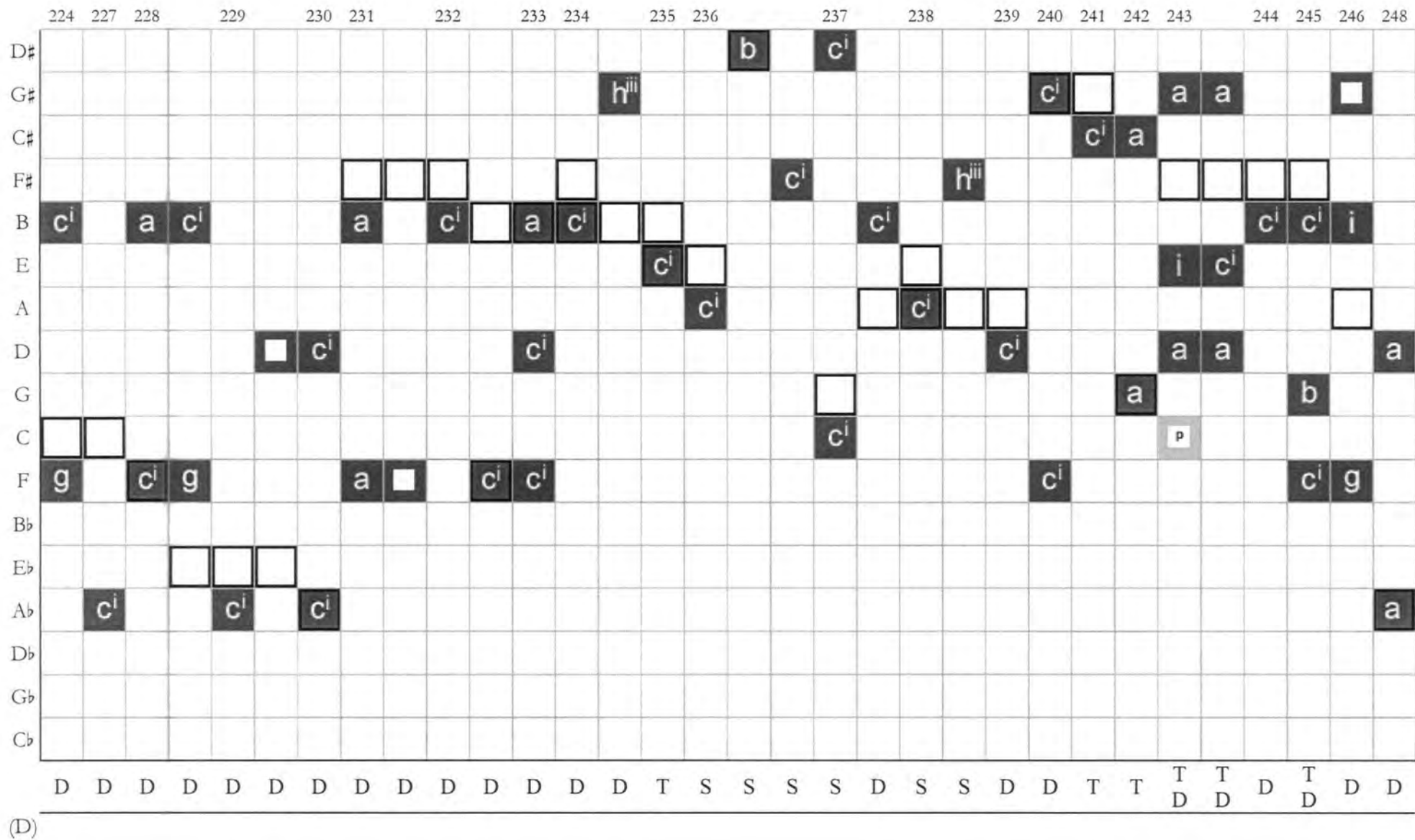

Appendix C: Sonata No.6, Op.62 (cont.)

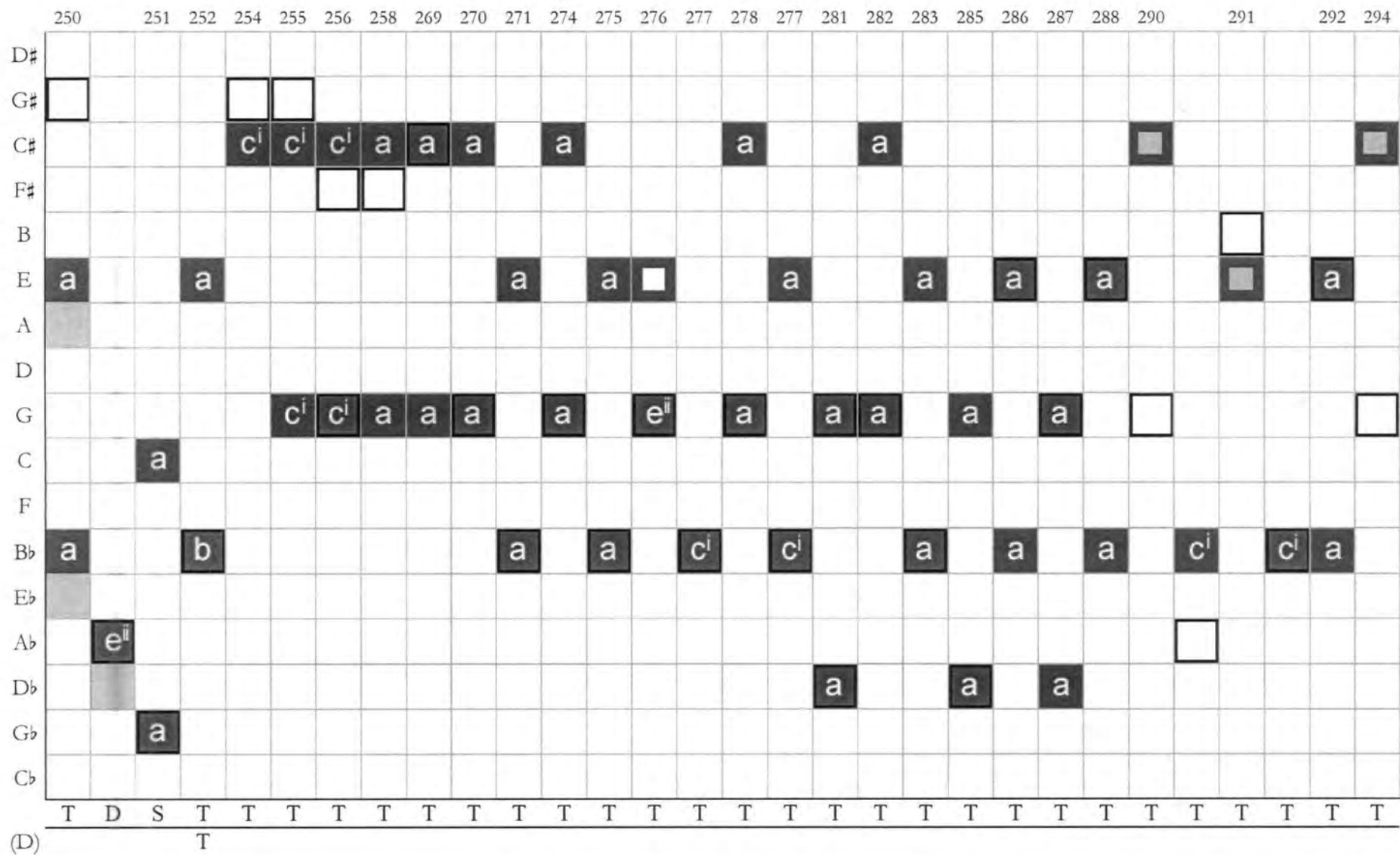

Appendix C: Sonata No.6, Op.62 (cont.)



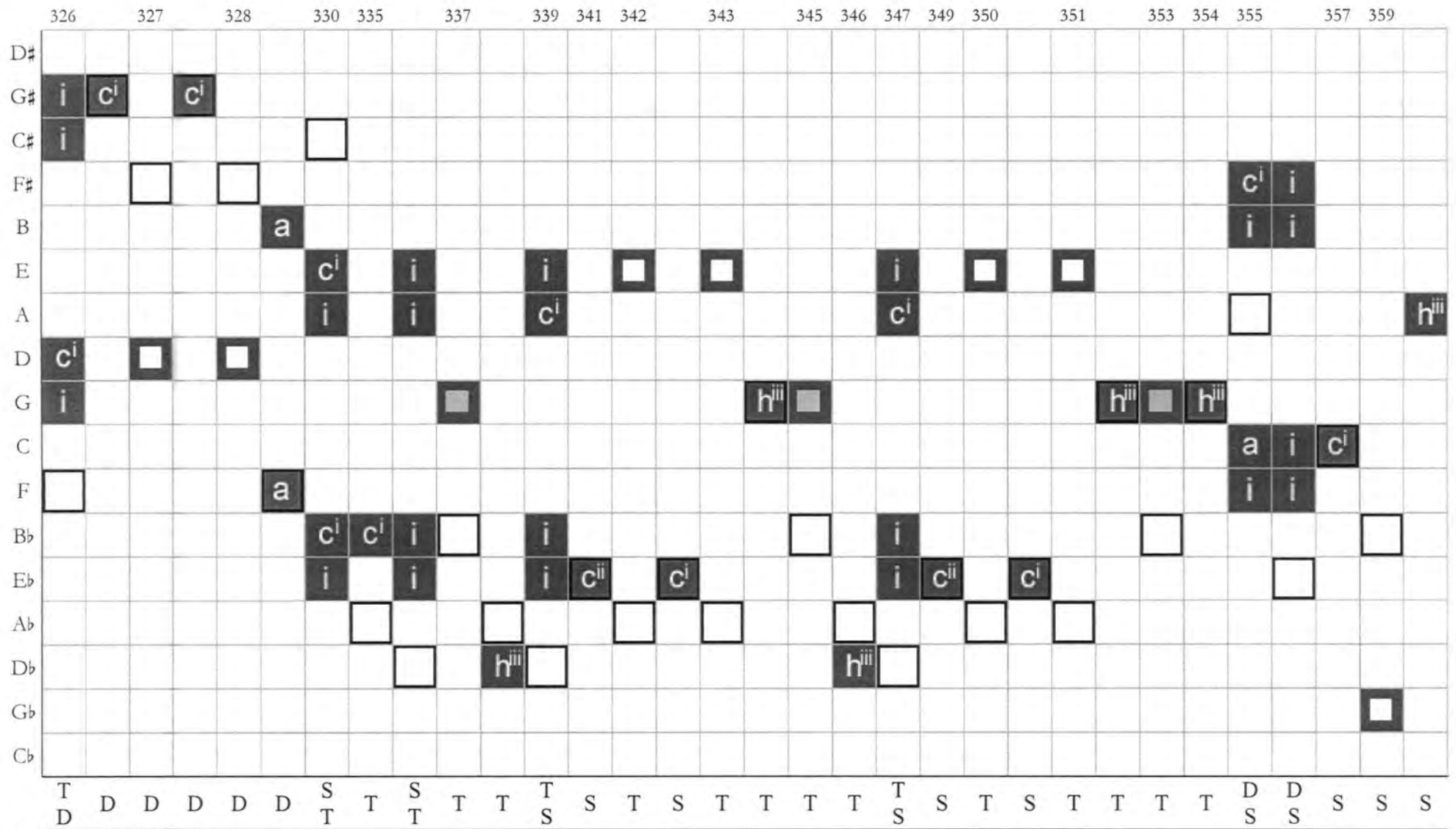

(D)

Appendix C: Sonata No.6, Op.62 (cont.)



	361	362	363	364	365	375	376	380	383
D#									
G#	c <sup>i</sup>								
C#	i							h <sup>iii</sup>	a
F#									i
B				e <sup>ii</sup>					
E					c <sup>i</sup>	c <sup>i</sup>		c <sup>i</sup>	
A					i				
D	c <sup>i</sup>		c <sup>i</sup>						
G	i								a
C									i
F				c <sup>i</sup>					
B <sup>b</sup>					c <sup>i</sup>				
E <sup>b</sup>					i				
A <sup>b</sup>									
D <sup>b</sup>									
G <sup>b</sup>									
C <sup>b</sup>									
F <sup>b</sup>									
	T	D	D	D	D	S	T	T	T
	D					T			(S)
(T)		D					T		

Appendix C: Sonata No.6, Op.62 (cont.)

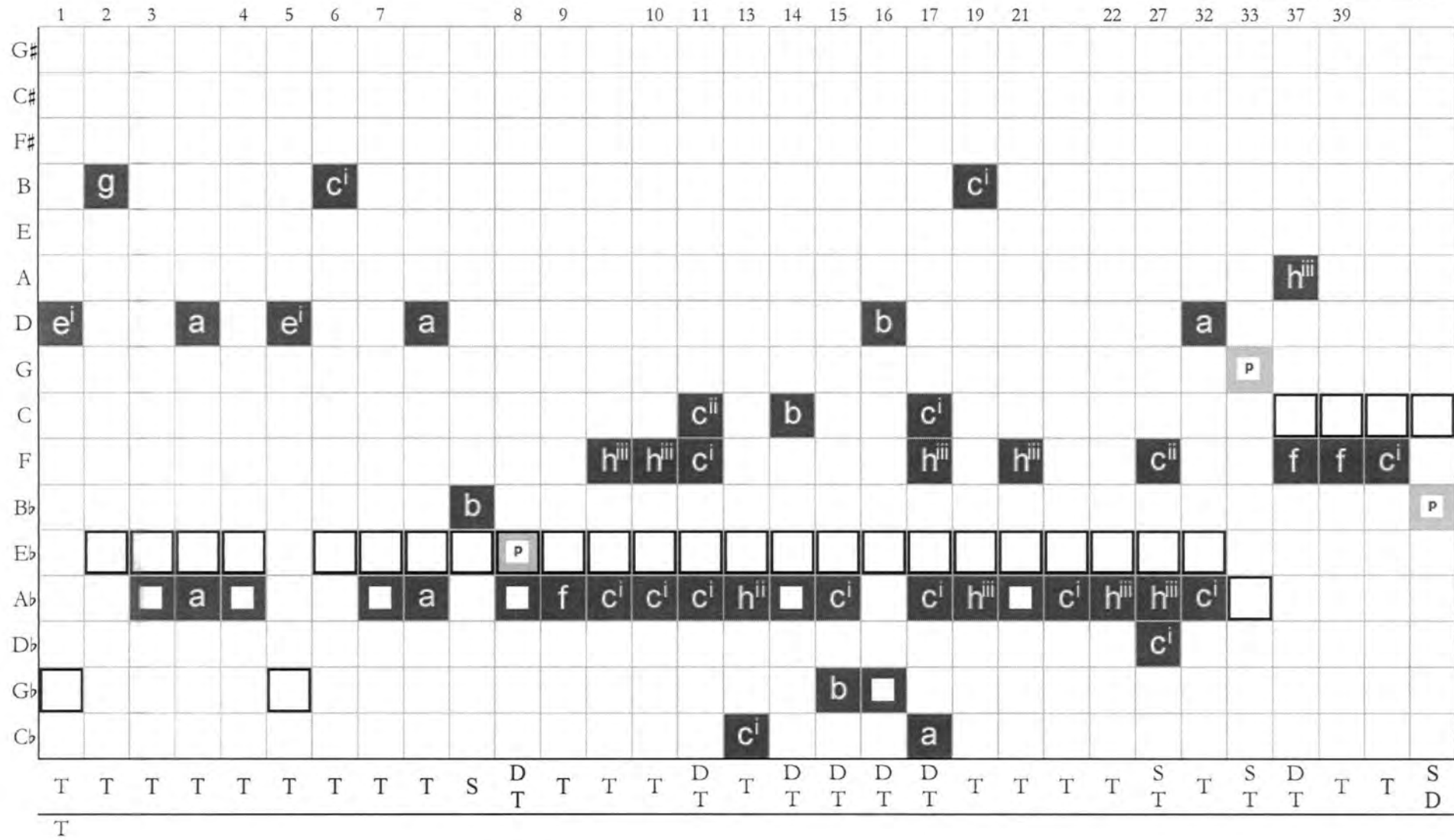

Appendix D: Sonata No.10, Op.70

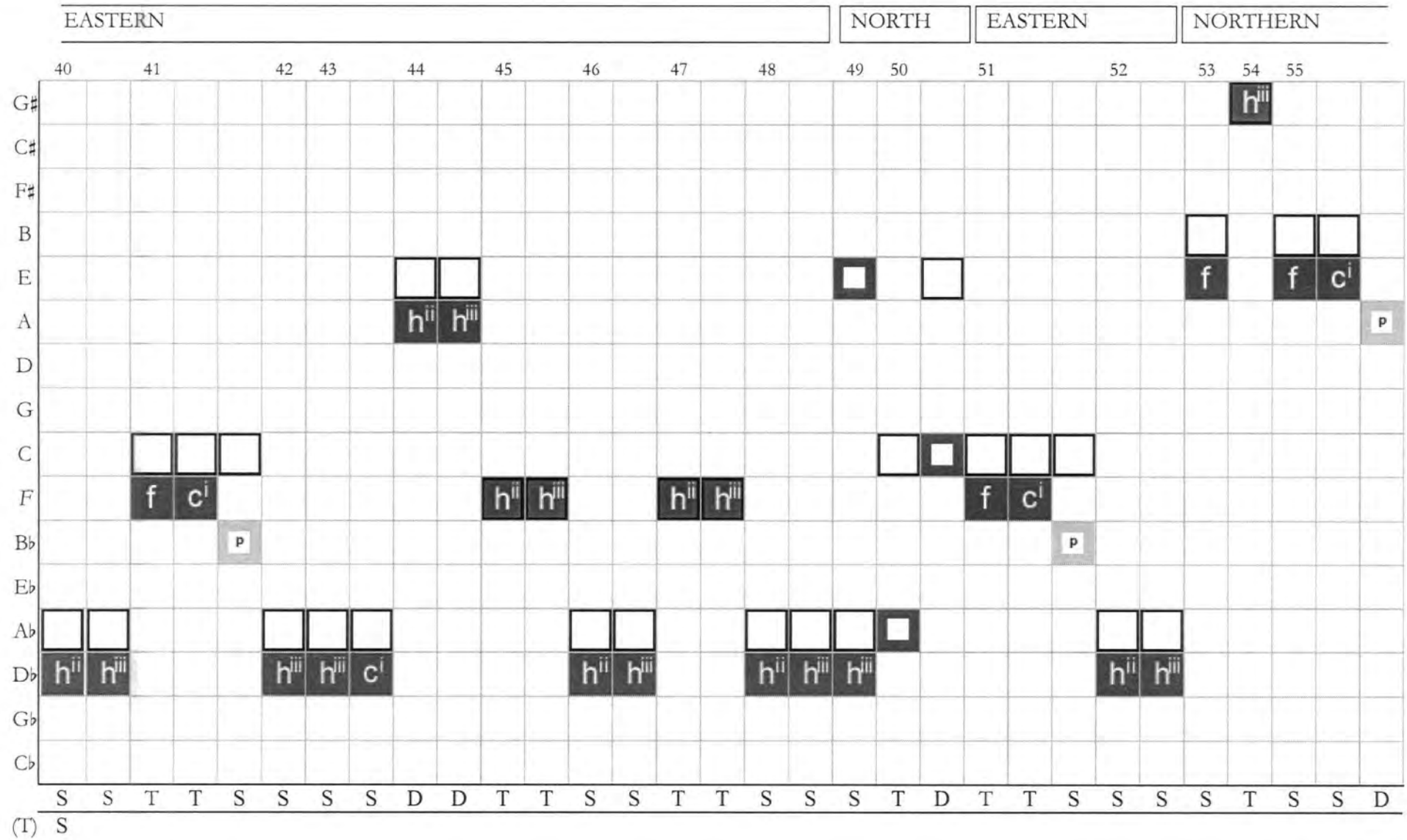

(T) S

Appendix D: Sonata No.10, Op.70 (cont.)

NORTH

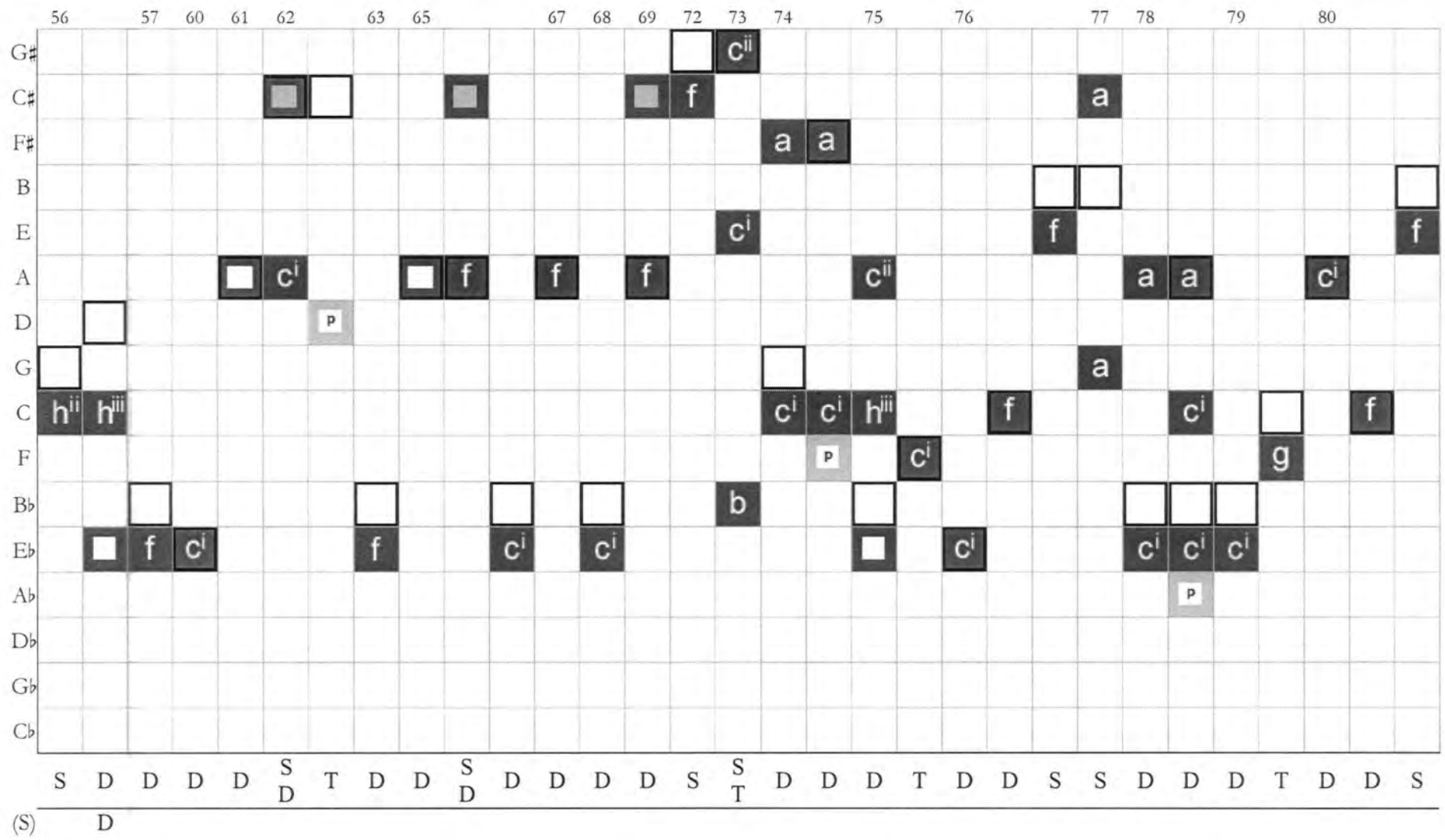

Appendix D: Sonata No.10, Op.70 (cont.)

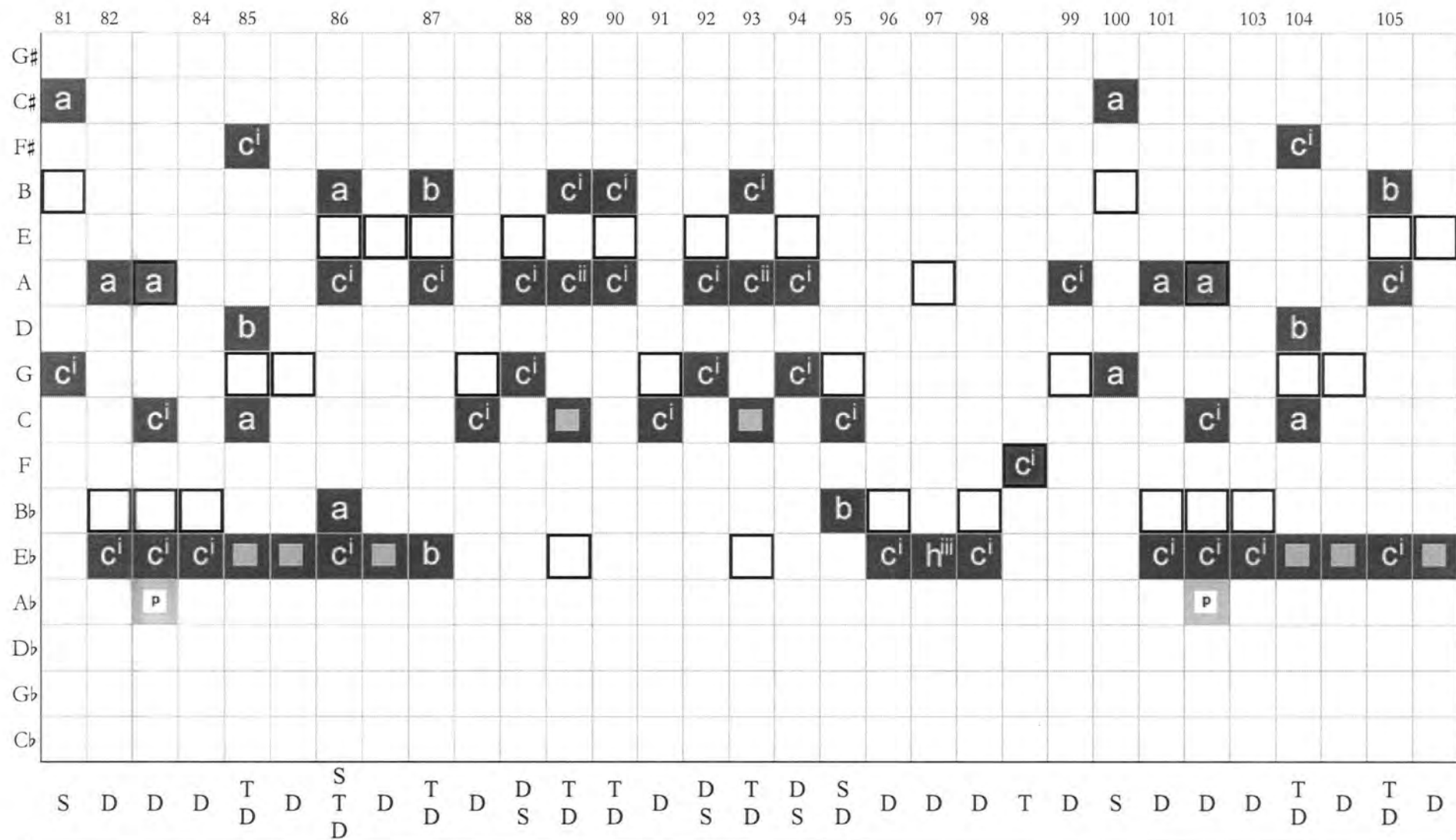

(D)

Appendix D: Sonata No.10, Op.70 (cont.)

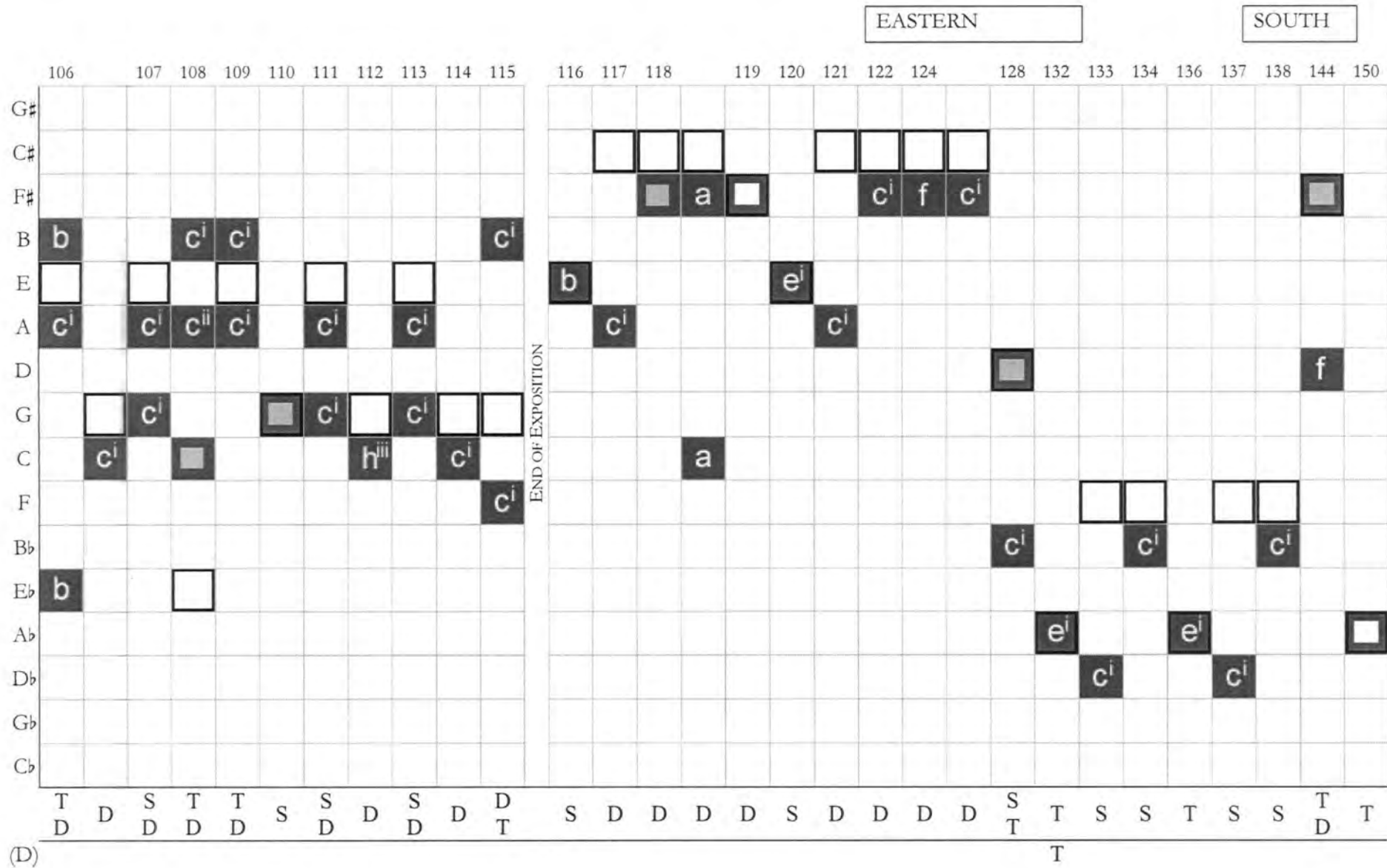

Appendix D: Sonata No.10, Op.70 (cont.)

NORTHERN

WESTERN

NORTH

WEST

SOUTH

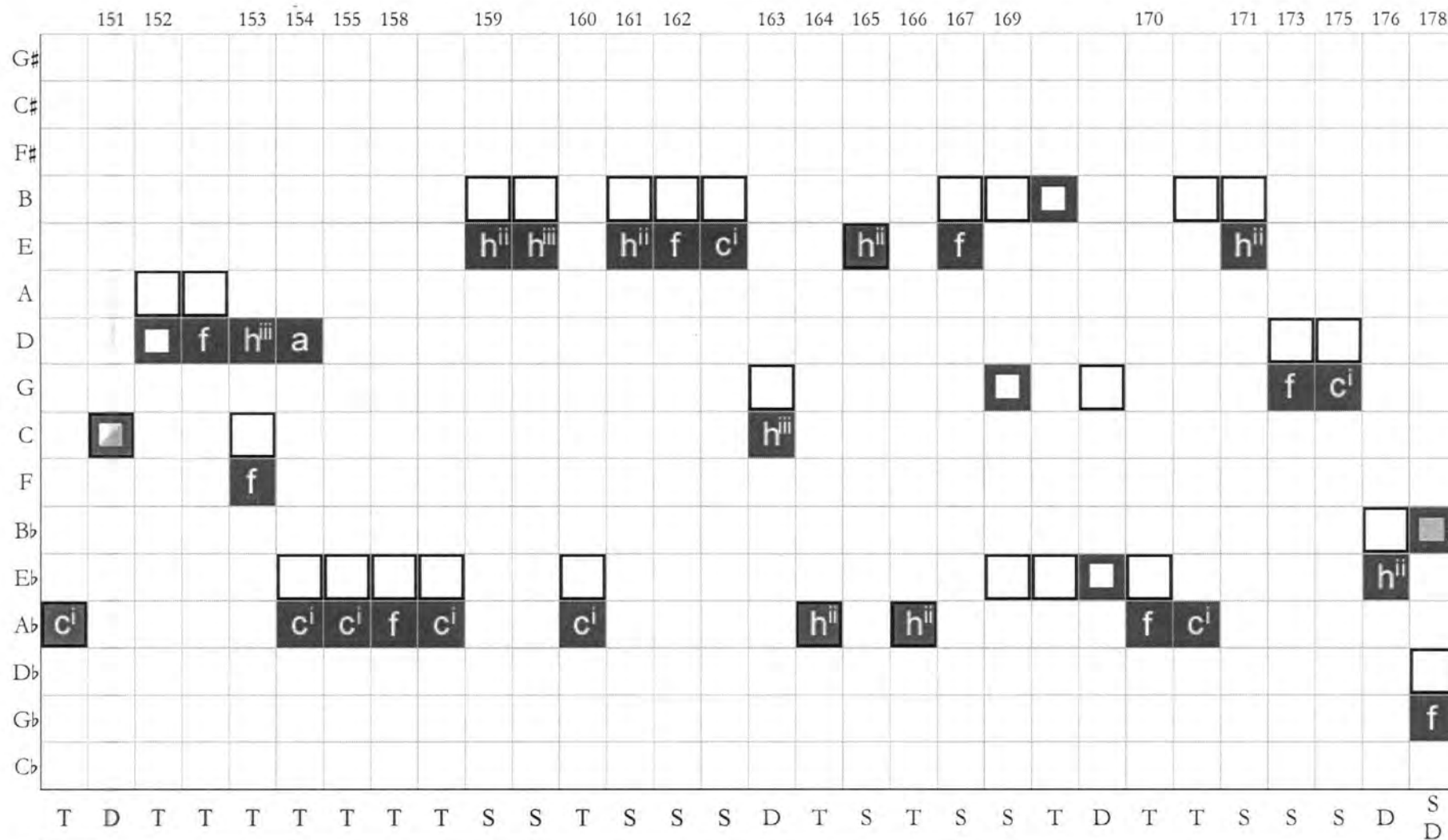

Appendix D: Sonata No.10, Op.70 (cont.)

SOUTH EAST

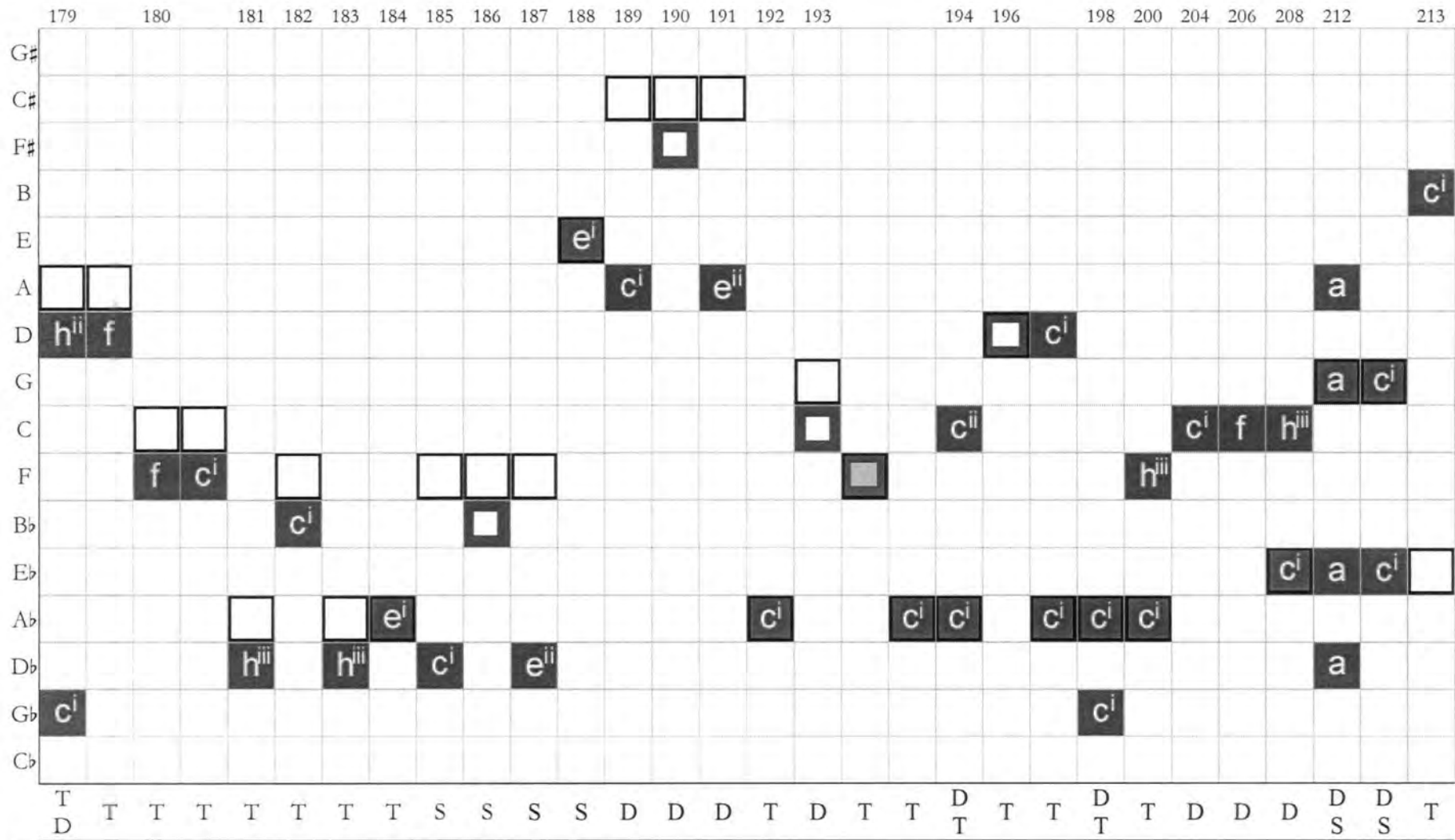

Appendix D: Sonata No.10, Op.70 (cont.)



W N

EASTERN

NORTH

EASTERN

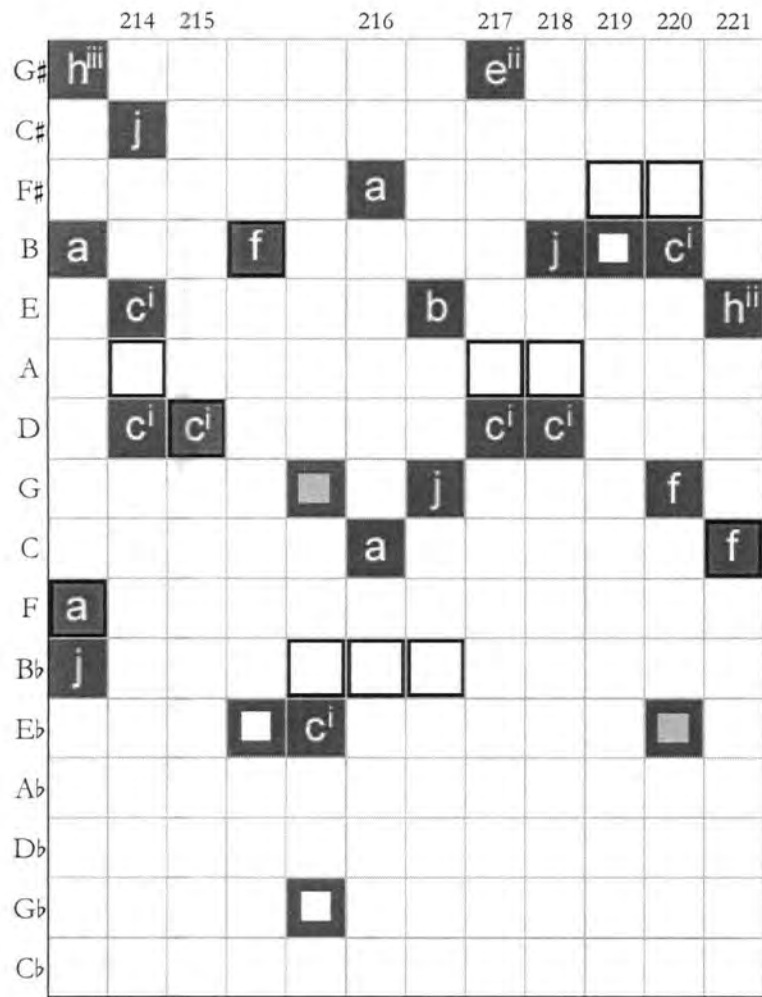

END OF DEVELOPMENT

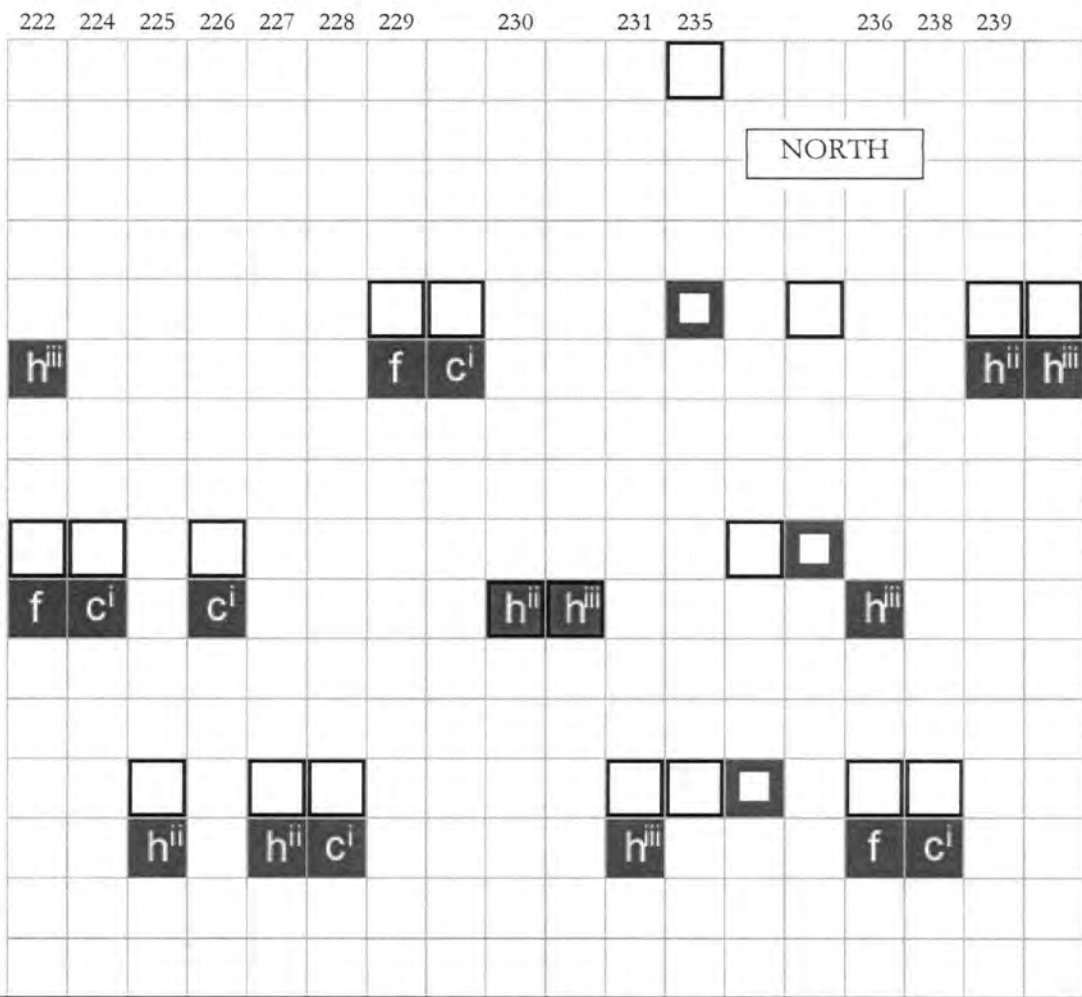

NORTH

S T T D S D S T T T T S D T T S S D D T T S S T D T S D D  
 T S T T T S D T T S S D D T T S S T D T S D D

(T)

Appendix D: Sonata No.10, Op.70 (cont.)

NORTHERN

	240	242	243	244	247	248	249	250	251	252	253	254	255	256	259	260	261	262	263	264	265	267					
G#																											
C#																											
F#																a											
B				f	c <sup>i</sup>			f	c <sup>i</sup>		c <sup>i</sup>	c <sup>i</sup>						a				a					
E	■									p																	
A										■					f								c <sup>ii</sup>				
D																b											
G																											
C	f	c <sup>i</sup>									■					a					f		■	f			
F							f	c <sup>i</sup>			f	f	f				h <sup>iii</sup>	c <sup>ii</sup>	a			a	c <sup>i</sup>				
B $\flat$																											
E $\flat$																											
A $\flat$				h <sup>ii</sup>	h <sup>iii</sup>																						
D $\flat$																											
G $\flat$																											
C $\flat$																											
	S	D	T	T	T	T	T	D	T	T	S	T	T	T	T	D	T	T	T	T	T	D	D	T	D	T	D

Appendix D: Sonata No.10, Op.70 (cont.)

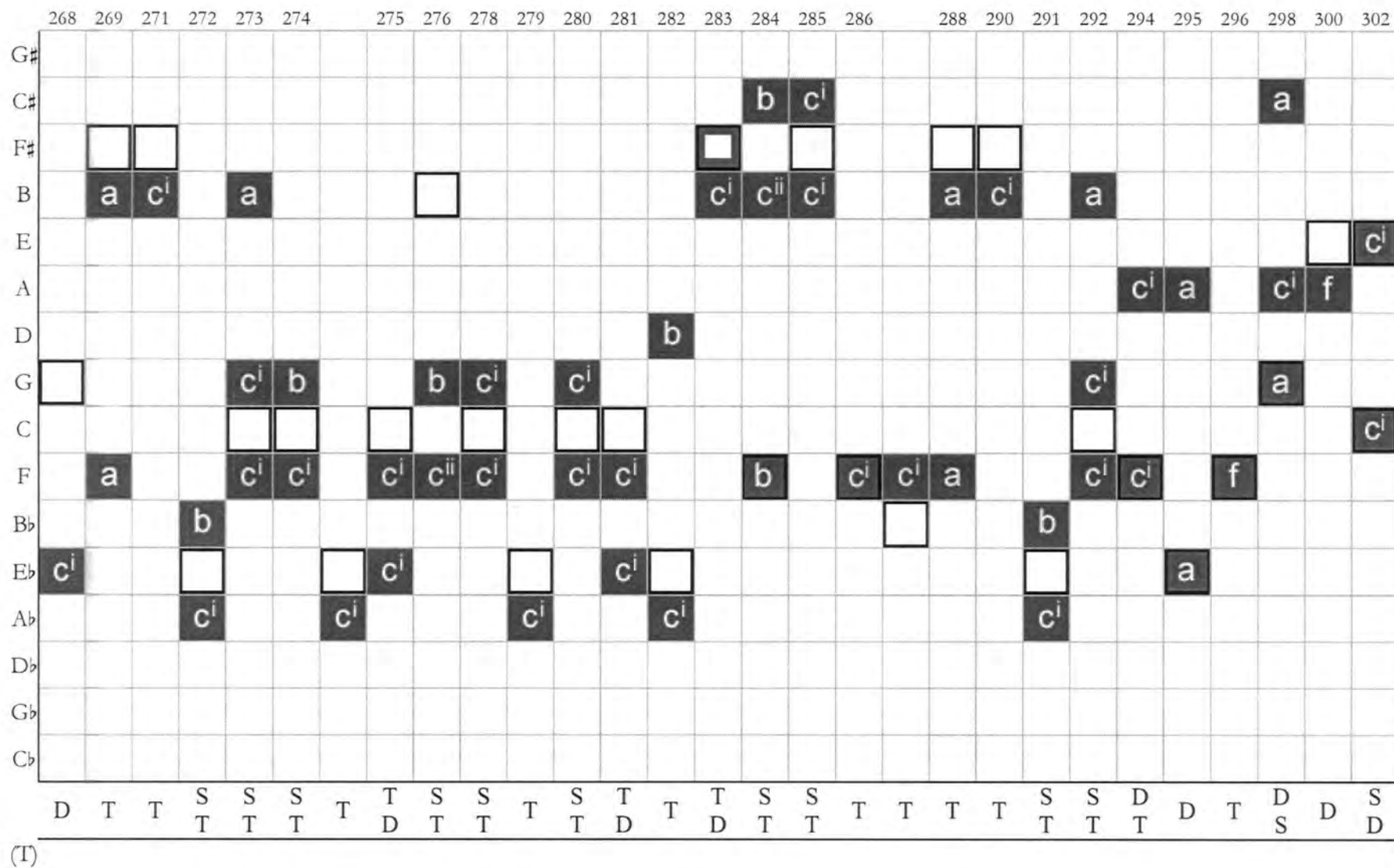

Appendix D: Sonata No.10, Op.70 (cont.)

	303	304	305	306	308	310	311	312	314	316	318	319	320	321	324	326	327	328	329	330	331	
G#																						
C#																						
F#				a																		
B																						
E	a																					
A				c <sup>i</sup>																		
D				b		a																
G																						
C	b	c <sup>i</sup>	c <sup>i</sup>	a																		
F																						
B <sup>b</sup>	a																					
E <sup>b</sup>																						
A <sup>b</sup>																						
D <sup>b</sup>																						
G <sup>b</sup>																						
C <sup>b</sup>																						
	D	D	D	T	T	T	S	T	D	T	T	S	T	D	T	T	T	T	S	T	S	D
	S	D	D	D	T	T	T	S	T	D	T	S	T	D	T	T	T	T	T	S	T	T
(T)		D			T																	

Appendix D: Sonata No.10, Op.70 (cont.)

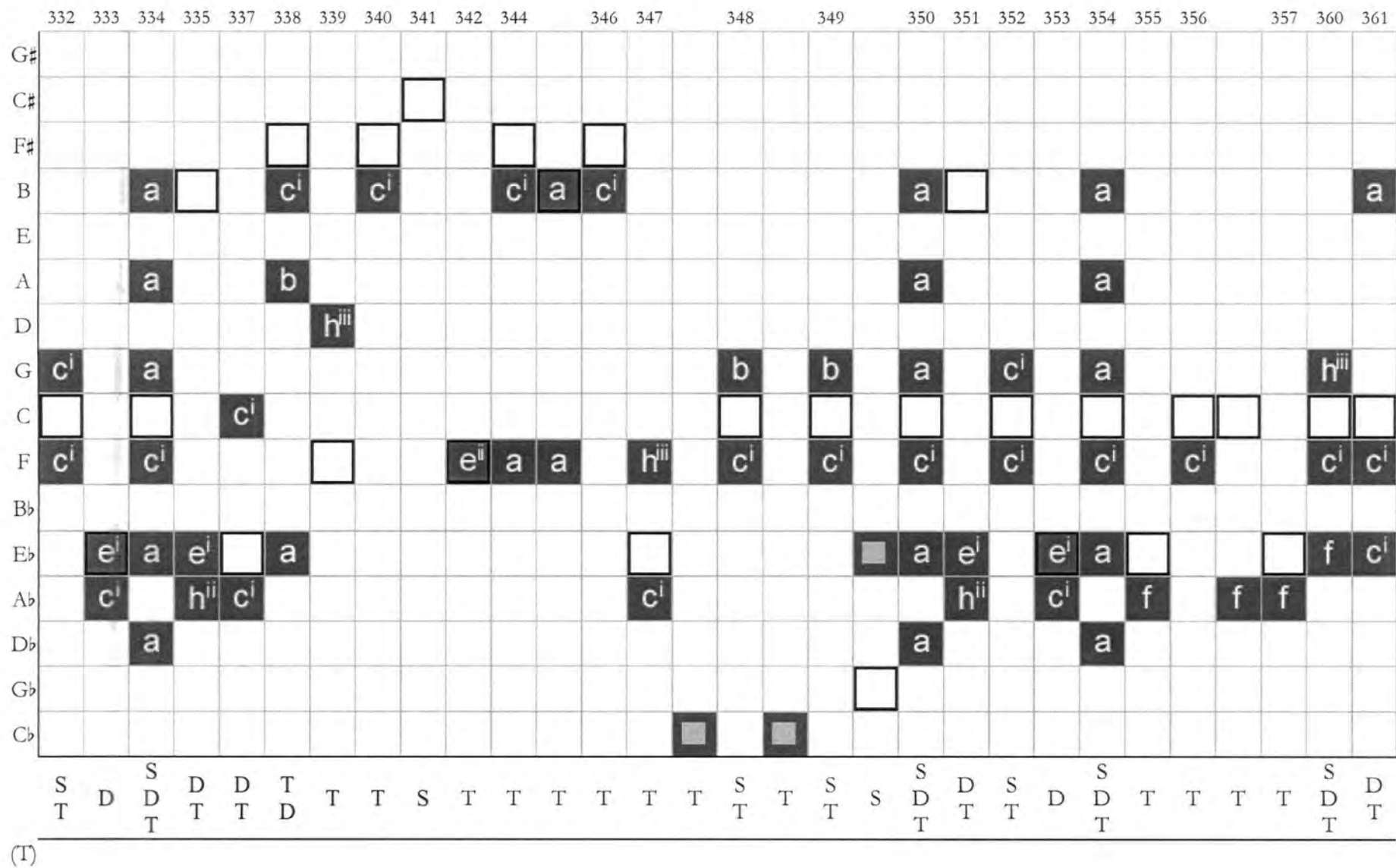

Appendix D: Sonata No.10, Op.70 (cont.)

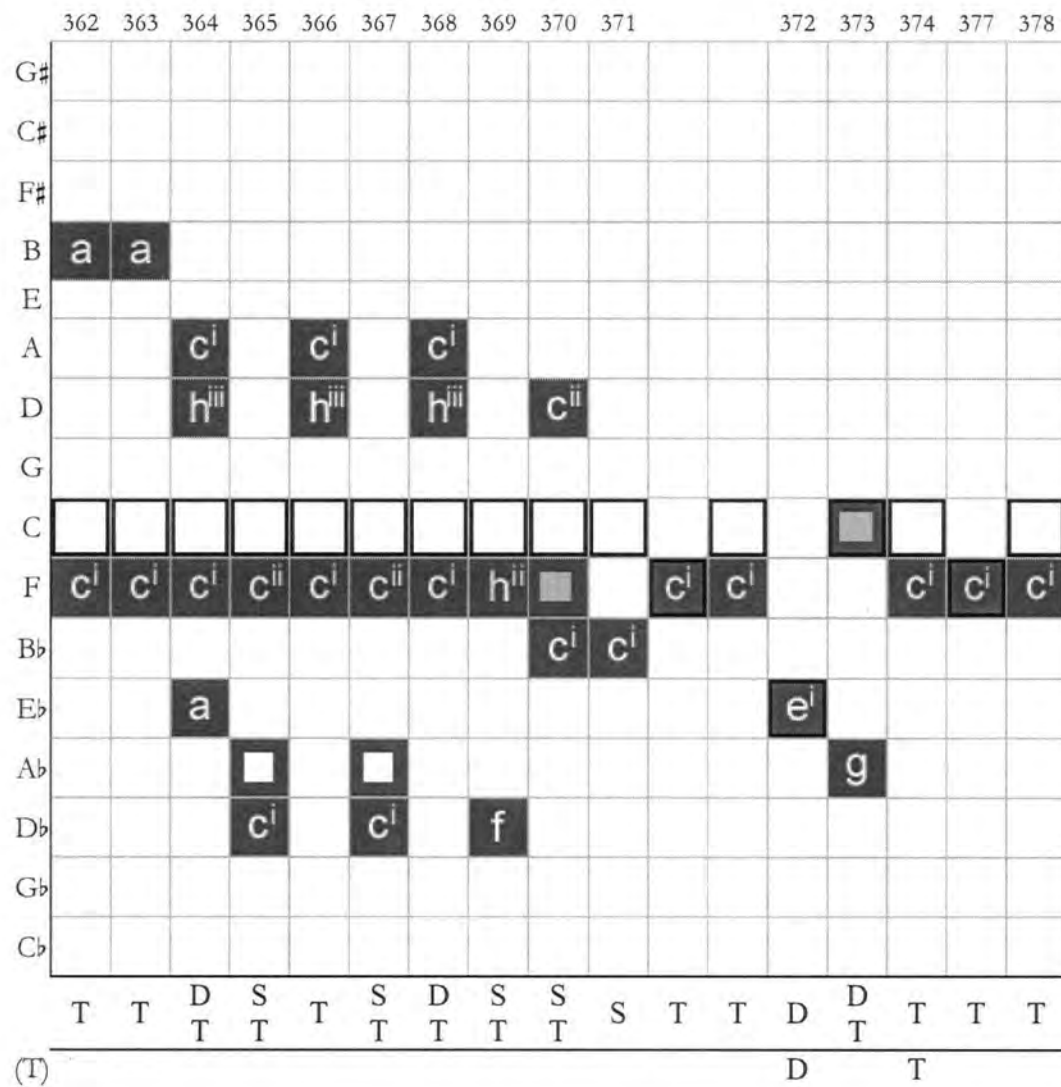

Appendix D: Sonata No.10, Op.70 (cont.)

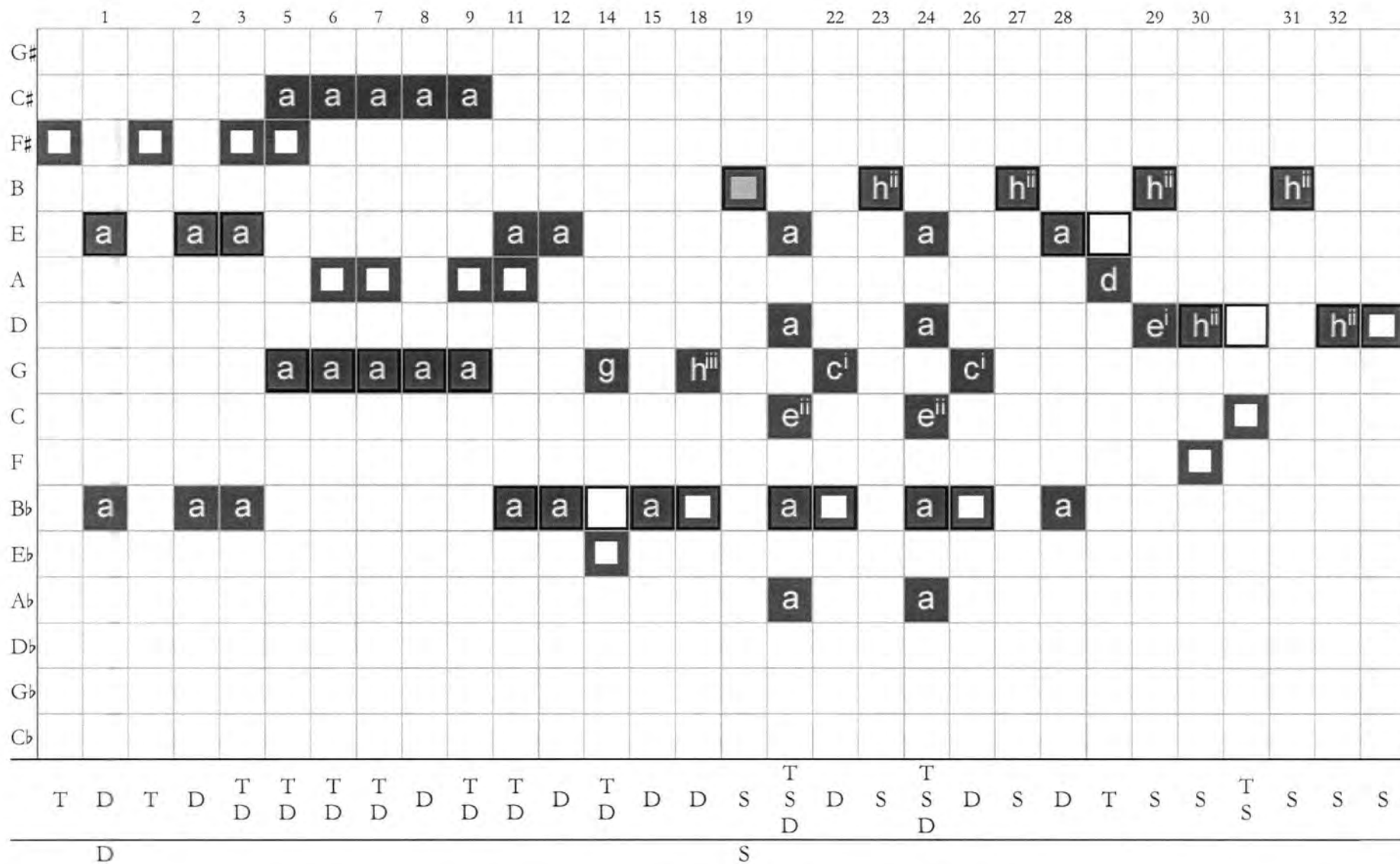

Appendix E: *Vers la Flamme*, Op.72

	33	34	35	37	38	39	41	42	43	44	45	46	47	51	52	53	54	55	56	57	58	59	60	61	62	63	64	
G#																												
C#												h <sup>iii</sup>																
F#			□			□		j		j		j																
B		h <sup>ii</sup>			h <sup>ii</sup>						h <sup>ii</sup>																	
E						c <sup>i</sup>	□	c <sup>i</sup>	□		c <sup>i</sup>	c <sup>i</sup>		c <sup>ii</sup>		h <sup>iii</sup>												
A													c <sup>ii</sup>		c <sup>ii</sup>													
D		c <sup>ii</sup>						d		d							j											
G				c <sup>i</sup>				h <sup>iii</sup>		h <sup>iii</sup>					□	d	i		i						i			
C												□	c <sup>i</sup>	□	f	c <sup>i</sup>		e <sup>ii</sup>		e <sup>ii</sup>	h <sup>iii</sup>	h <sup>iii</sup>			e <sup>ii</sup>	h <sup>iii</sup>	h <sup>iii</sup>	
F																												
B <sup>b</sup>	c <sup>i</sup>	c <sup>i</sup>		c <sup>i</sup>															j		j				j			
E <sup>b</sup>													f					□	□	□	□		□			□	c <sup>i</sup>	
A <sup>b</sup>																		□	□	□	□		c <sup>i</sup>	□	□	c <sup>i</sup>	c <sup>i</sup>	
D <sup>b</sup>	□																	i		i				i				
G <sup>b</sup>																												
C <sup>b</sup>																												
		D	S	T	D	D	T	T	S	T	D	S	S	D	T	T	D	D	S	T	D	T	T	T	T	D	T	S
		D	D	S			S	D			D				T		T		S	S	S	S			S	S	S	D
(S)	D													T				S									D	

Appendix E: *Vers la Flamme*, Op.72 (cont.)



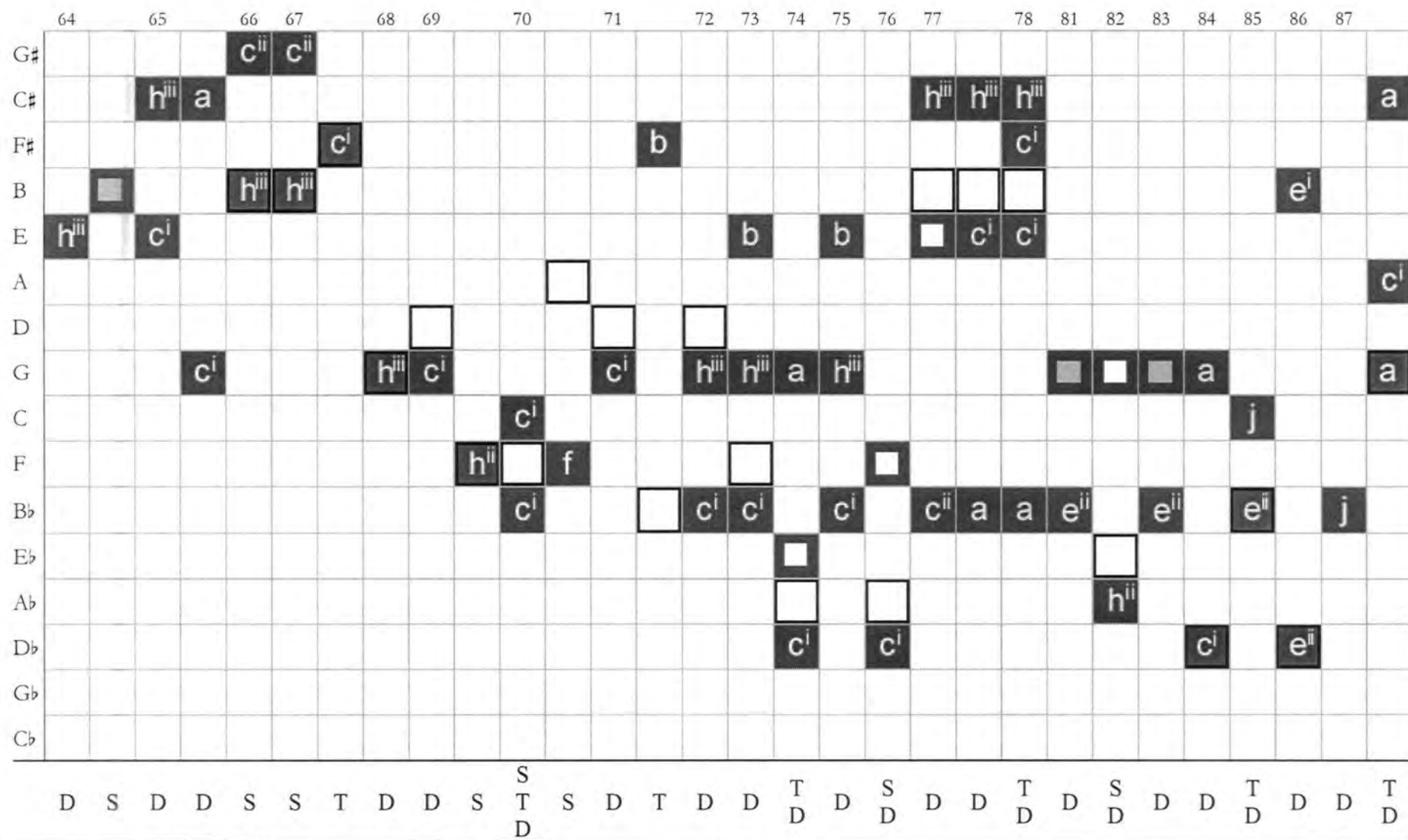

(D)

Appendix E: *Vers la Flamme*, Op.72 (cont.)

	90	91	92	93	94	95	97	99	101	103	107	111	117	125	127	124 ff
G#						c <sup>ii</sup>		c <sup>ii</sup>		c <sup>ii</sup>						
C#	c <sup>i</sup>					h <sup>iii</sup>		h <sup>ii</sup>		h <sup>iii</sup>						
F#						c <sup>i</sup>		c <sup>i</sup>		c <sup>i</sup>	c <sup>i</sup>					
B																
E		a			c <sup>ii</sup>	c <sup>i</sup>	c <sup>i</sup>	c <sup>i</sup>	c <sup>i</sup>	c <sup>i</sup>	c <sup>i</sup>				h <sup>iii</sup>	
A												c <sup>i</sup>				
D							c <sup>i</sup>		c <sup>i</sup>							
G	e <sup>i</sup>		e <sup>i</sup>	h <sup>iii</sup>								c <sup>i</sup>				
C													c <sup>i</sup>		c <sup>i</sup>	
F																
B <sup>b</sup>		c <sup>i</sup>			c <sup>i</sup>								c <sup>i</sup>		c <sup>i</sup>	
E <sup>b</sup>																
A <sup>b</sup>																
D <sup>b</sup>																
G <sup>b</sup>																
C <sup>b</sup>																
	D	D	D	D	D	T S D	S D	T S D	S D	T S D	T D	T D	T D	D	T D	

(D  
)

*Drone Analysis becomes redundant here*

Appendix E: *Vers la Flamme*, Op.72 (cont.)

	1	2	3	5	7	8	9	11	12	13	15	16	19	21	22	23	24	25	26	27	28	29	30	31	32	33	34						
G <sup>#</sup>																		c <sup>i</sup>															
C <sup>#</sup>																																	
F <sup>#</sup>						a			a	c <sup>ii</sup>						c <sup>i</sup>	c <sup>ii</sup>					a											
B																				a													
E																			f				a				c <sup>i</sup>	c <sup>i</sup>					
A															c <sup>i</sup>	b																	
D									c <sup>i</sup>	c <sup>i</sup>						b		e <sup>ii</sup>				j											
G	k	a	a								e <sup>ii</sup>	b	e <sup>ii</sup>	c <sup>i</sup>	b					c <sup>i</sup>	c <sup>i</sup>					a	c <sup>i</sup>	b					
C					a	c <sup>i</sup>		c <sup>i</sup>	a				f			c <sup>i</sup>	c <sup>i</sup>				e <sup>ii</sup>	c <sup>i</sup>	a	b				c <sup>i</sup>					
F														c <sup>i</sup>	c <sup>i</sup>						c <sup>i</sup>				c <sup>i</sup>								
B <sup>b</sup>																		c <sup>i</sup>					c <sup>i</sup>	a									
E <sup>b</sup>	e <sup>ii</sup>		c <sup>i</sup>																	b													
A <sup>b</sup>					c <sup>i</sup>	c <sup>i</sup>																	c <sup>i</sup>						c <sup>i</sup>				
D <sup>b</sup>	a	a																								a							
G <sup>b</sup>				a																													
C <sup>b</sup>																																	
	D	D	D	T	S	S	T	T	D	S	T	D	D	D	S	S	T	T	D	D	D	S	D	D	S	D	D	D	S	D	T		
				T																										S	D		

Appendix F: *Poem of Ecstasy*, Op.54

	35	36	37	38	39	40	41	42	43	44	45	46	47	48	49	50	51	52	53	54	55	56	57				
G#	c <sup>i</sup>																										
C#																											
F#	a													a	a	a											
B			a																								
E	f			c <sup>i</sup>			a	a	a																		
A				f																							
D	e <sup>ii</sup>													c <sup>i</sup>	e <sup>i</sup>	b	i		a		b	h <sup>iii</sup>	a	a	a	a	a
G			c <sup>i</sup>	c <sup>i</sup>		c <sup>i</sup>																					
C	a					c <sup>i</sup>	e <sup>i</sup>	b	i		a		b	h <sup>iii</sup>	a			a	a	a							
F				c <sup>i</sup>																		f					
B <sup>b</sup>			c <sup>i</sup>					a	a	a												c <sup>i</sup>		b		b	
E <sup>b</sup>				b									f														
A <sup>b</sup>	b												c <sup>i</sup>					b	a	c <sup>i</sup>			a	a	a	a	a
D <sup>b</sup>																											
G <sup>b</sup>										b	a	c <sup>i</sup>			a												
C <sup>b</sup>																											
	S	D	D	D	T	D	D	T	T	D	D	T	T	T	S	T	S	S	S	S	S	S	S	S	D	D	S
	T	S			S	T	T			T	D				T	T								S	T	S	S
(D)							T							S													

Appendix F: *Poem of Ecstasy*, Op.54 (cont.)

	58	59	61	62	63	64	65	66	67	70	71	72	73	74	75	76	77	78	79	80	81	82	83	84	85	86			
G#																													
C#							a									c <sup>ii</sup>													
F#								a			a	a					a		c <sup>i</sup>										
B																													
E																		f		a									
A							d	d								a	c <sup>i</sup>								c <sup>i</sup>	a			
D	a	a		a		a				b	b		c <sup>i</sup>	a				b											
G								a															c <sup>i</sup>	a					
C									a			a	a		h <sup>iii</sup>		a		a	c <sup>i</sup>									
F																							b						
B $\flat$		b		b																	a								
E $\flat$													e <sup>ii</sup>			c <sup>i</sup>	a	c <sup>i</sup>						b	c <sup>i</sup>	b	c <sup>i</sup>		
A $\flat$		a	a		a		a							b															
D $\flat$																							a	b					
G $\flat$									a																				
C $\flat$																													
	T	D S T	S	D T	S	T	T	S	T	T	D	D	S T	S	T	T	S	T	S	T	D	S T	D	D	S D	T D	S T	T	T
(S)								D	T																				

Appendix F: *Poem of Ecstasy*, Op.54 (cont.)

	87	88	90	91	93	95	97	99	101	103	105	106	107	111	113	114	115	116	117	118	119	124	126	127	128	129	130	131	132	
G#								a												a								a		
C#																									a					
F#											□						c <sup>ii</sup>							c <sup>ii</sup>			a			
B	a													□	□							□								
E					c <sup>i</sup>	b	c <sup>i</sup>	c <sup>i</sup>			c <sup>i</sup>										b					a				
A		c <sup>i</sup>								c <sup>i</sup>	c <sup>i</sup>	b	c <sup>i</sup>																	
D					c <sup>i</sup>	k	c <sup>i</sup>	a		□	f			c <sup>i</sup>	b	c <sup>i</sup>	e <sup>ii</sup>				h <sup>iii</sup>	a	b				a		a	
G		c <sup>i</sup>							□		h <sup>iii</sup>			□	□							□	□		a		f			
C									□							□	□	□	□				□	□	□		b	a	j	
F	c <sup>i</sup>		h <sup>iii</sup>																							c <sup>i</sup>				
B <sup>b</sup>		h <sup>iii</sup>		c <sup>i</sup>																					a	h <sup>iii</sup>		e <sup>ii</sup>		
E <sup>b</sup>	c <sup>i</sup>	c <sup>i</sup>																											c <sup>i</sup>	
A <sup>b</sup>	c <sup>i</sup>	□	□	c <sup>i</sup>														□								c <sup>i</sup>			a	
D <sup>b</sup>		c <sup>i</sup>	c <sup>i</sup>																											
G <sup>b</sup>																														
C <sup>b</sup>																														
	T	D	D	D	D	D	D	D	D	T	D	D	T	S	S	S	S	T	T	S	D	S	S	T	T	D	D	D	D	
	S	T	S	S	S	S	S	S	T	T	S	T	S	D	D	T	T	T	T	S	D	S	T	T	D	T	S	T	T	S
(T)	S							T			T								S					D						

Appendix F: *Poem of Ecstasy*, Op.54 (cont.)

	133	134	135	136	137	138	139	140	141	147	148	149	152	153	154	155	156	157	158	160	161	162	163	164	165	166	167	168	169	172	173	
G#				b							c <sup>ii</sup>	a	a	a			a							c <sup>i</sup>			a					
C#									□		□	□																				
F#				e <sup>ii</sup>	c <sup>i</sup>			b									c <sup>i</sup>	a		a				a				a	c <sup>i</sup>		c <sup>i</sup>	
B																			□	□				f								
E	h <sup>iii</sup>				c <sup>i</sup>		a	b			a	b	c <sup>i</sup>			b		f	c <sup>i</sup>	a	a					a	b					
A									□	□		□				f																
D	c <sup>i</sup>			a					□	□		a	a	a			a						c <sup>i</sup>	□		b		a	b			
G	f																															
C															a		b	a			a	b	c <sup>ii</sup>	c <sup>i</sup>			c <sup>i</sup>		c <sup>i</sup>		c <sup>i</sup>	
F																																
B <sup>b</sup>					a	b	a				a			b													a					
E <sup>b</sup>		e <sup>ii</sup>																														
A <sup>b</sup>			a																					a								
D <sup>b</sup>																																
G <sup>b</sup>														a																		
C <sup>b</sup>																																
	S	D	T	S	T	T	D	D	S	D	S	D	D	D	T	T	S	D	D	D	D	T	S	S	S	S	T	S	T	T	T	T
(D)			T	S			D								T								S								T	

Appendix F: *Poem of Ecstasy*, Op.54 (cont.)

	176	177	180	181	182	183	184	185	186	187	189	190	191	195	211	213	216	217	218	219	221	224	228	232	236	237	238	239	240
G#																													
C#																							a						
F#		c <sup>i</sup>																											
B							c <sup>i</sup>																		a	e <sup>ii</sup>			b
E														c <sup>i</sup>		a													
A			a			e <sup>ii</sup>	a										a									a		a	
D																		a											
G						a																							
C	c <sup>i</sup>																												
F																													
B <sub>b</sub>																													
E <sub>b</sub>			a			e <sup>ii</sup>		a	c <sup>i</sup>	c <sup>i</sup>	e <sup>ii</sup>		c <sup>i</sup>																
A <sub>b</sub>																													
D <sub>b</sub>						a																							
G <sub>b</sub>																													
C <sub>b</sub>																													
	T	T	T	S	T	T	S	T	D	S	T	D	S	S	D	D	T	S	D	D	T	T	D	D	S	S	D	T	S
				T	D	D	T		T	S	T	T	S	D	T	D	T	S	S	D	D	T	D	T	S	T	T	T	S
(T)													S		D														T

DEVELOPMENT

Appendix F: *Poem of Ecstasy*, Op.54 (cont.)



	241	242	243	245	246	247	249	251	252	253	254	255	256	260	261	264	265	266	267	270	271	272	273	274	275	276	277	281	282	283	285	
G#																																
C#									a																							
F#																											c <sup>ii</sup>					
B								a	a	a																c <sup>i</sup>					a	
E																															c <sup>ii</sup>	
A	h <sup>iii</sup>	c <sup>i</sup>		h <sup>iii</sup>	c <sup>i</sup>		a	b										a	b													
D									i	i																e <sup>ii</sup>	c <sup>i</sup>					
G		c <sup>ii</sup>		a	b	a		a		a					c <sup>ii</sup>	a	c <sup>ii</sup>	a										b	e <sup>ii</sup>	b		
C																															c <sup>ii</sup>	
F					b	a		a	a																						a	
B <sup>b</sup>														c <sup>i</sup>	c <sup>i</sup>	c <sup>i</sup>																
E <sup>b</sup>		c <sup>i</sup>		b	a					b		b				c <sup>i</sup>	a		b	c <sup>i</sup>												
A <sup>b</sup>																										e <sup>ii</sup>	c <sup>i</sup>					
D <sup>b</sup>				a					a	a								a		a												
G <sup>b</sup>																																
C <sup>b</sup>																																
(T)	T	T	D	T	T	D	T	S	D	S	D	S	D	D	D	D	T	T	D	D	D	S	T	S	S	S	S	T	D	S	S	T
			T			T	S	D	T	S	T	S	T	D	D	D	T	T	T	T	T	S	S	S	S	S	T	D	D	D	D	T
										S				D			T					S						D				T

Appendix F: *Poem of Ecstasy*, Op.54 (cont.)

	289	290	291	293	295	297	298	299	300	301	302	305	309	310
G#														
C#														
F#		h <sup>iii</sup>			a									
B														
E						c <sup>i</sup>		c <sup>i</sup>		c <sup>i</sup>				
A	b	c <sup>i</sup>											j	
D				b	a	c <sup>i</sup>		c <sup>i</sup>		c <sup>i</sup>	c <sup>i</sup>			
G	c <sup>ii</sup>		k										e <sup>ii</sup>	b
C				k	a									
F														
B $\flat$														
E $\flat$			e <sup>i</sup>											
A $\flat$				b		c <sup>i</sup>		e <sup>ii</sup>		e <sup>ii</sup>				
D $\flat$														
G $\flat$														
C $\flat$														
	D	T	D	T	S	S	D	S	D	S	D	D	T	D
	T	T	T	S	T	S	S	S	S	S	T	T	D	D
(T)					S						D			

RECAPITULATION

	313	314	316	320	321	324	325	326	327		328	329	330	331	333	334	
G#																	
C#		a															
F#												a					
B																	
E																	
A								b									
D												b				b	
G	e <sup>ii</sup>	a	c <sup>i</sup>														
C						a						a				a	
F																	
B $\flat$																	
E $\flat$									e <sup>ii</sup>								
A $\flat$				b	e <sup>ii</sup>	c <sup>i</sup>	e <sup>ii</sup>				b	h <sup>iii</sup>					
D $\flat$							c <sup>i</sup>	c <sup>i</sup>					e <sup>ii</sup>	c <sup>i</sup>	c <sup>i</sup>		
G $\flat$						a									f	c <sup>i</sup>	a
C $\flat$										b							
	S	S	S	D	S	D	S	D	T	S	S	T	D	D	S	T	S
	D	D	D	S	T	S	S	D	T	T	S	S	T	D	D	T	T
	T	T	T	T	D	T	D	T	T	S	S	S	D	D	T	T	T
(T)										S		D		T			

Appendix F: *Poem of Ecstasy*, Op.54 (cont.)

	335	336	337		338	339	342	343	344	345	347	349	351	353	354	355	356	357	358	359	360	361	362	363	364	365	366	369	370	371	
G#																															
C#													e <sup>ii</sup>																	b	
F#					a																						a				
B	g												a	c <sup>i</sup>	a												□	c <sup>i</sup>			
E																					b										
A											a	a		a			a													c <sup>i</sup>	
D	a				b																						b				
G						b			a							a	a			a				a					e <sup>ii</sup>	e <sup>ii</sup>	
C					a																							a			
F	c <sup>i</sup>					c <sup>ii</sup>	c <sup>ii</sup>	a	a				b	a		b					b				b						
B <sup>b</sup>																															
E <sup>b</sup>			e <sup>ii</sup>						h <sup>iii</sup>		b	a	a		a			a	b		c <sup>i</sup>		b		c <sup>i</sup>	e <sup>ii</sup>					
A <sup>b</sup>	a	b			b	b													f		□	□	f		□	f	b				
D <sup>b</sup>		c <sup>i</sup>				f		b		a						a	a			a	c <sup>i</sup>				a	c <sup>i</sup>					
G <sup>b</sup>																															
C <sup>b</sup>			b					a	a																						
	s	S	T	S	S	T	D	S	D	T	T	S	D	S	S	D	D	S	D	D	T	S	T	D	D	T	S	T	D	D	D

(I) S

Appendix F: *Poem of Ecstasy*, Op.54 (cont.)

	372	373	374	377	378	379	380	381	382	383	384	385	386	387	388	389	390	391	392	393	394	395	396	397	399	400	401	402	403	404		
G $\sharp$								e <sup>ii</sup>																								
C $\sharp$			a																							a						
F $\sharp$					□													a				a	a									
B		a			j					a		c <sup>i</sup>																		a		
E																																
A					□									□							b						c <sup>i</sup>					
D					h <sup>iii</sup>		□		b						b			a														
G	e <sup>ii</sup>		a	c <sup>i</sup>	i					c <sup>i</sup>			c <sup>i</sup>													a	a	c <sup>i</sup>	b		b	b
C										c <sup>i</sup>					a	a		a				a	a									
F		a			□	h <sup>iii</sup>				a	c <sup>i</sup>	b	c <sup>i</sup>													b			h <sup>iii</sup>	a		
B $\flat$															c <sup>ii</sup>																	
E $\flat$	b																							c <sup>i</sup>	h <sup>iii</sup>		a					
A $\flat$							c <sup>ii</sup>		c <sup>i</sup>								b	a	b	c <sup>i</sup>	c <sup>i</sup>											
D $\flat$	c <sup>ii</sup>											b									□	□	□	□	c <sup>i</sup>				c <sup>i</sup>		c <sup>i</sup>	
G $\flat$																a					c <sup>i</sup>											
C $\flat$																																
	D	S	D	D	D	S	S	S	T	D	S	S	D	T	S	D	S	T	S	S	S	S	T	T	D	D	S	D	D	S	D	S
(S)			D		T	S																		D								

Appendix F: *Poem of Ecstasy*, Op.54 (cont.)

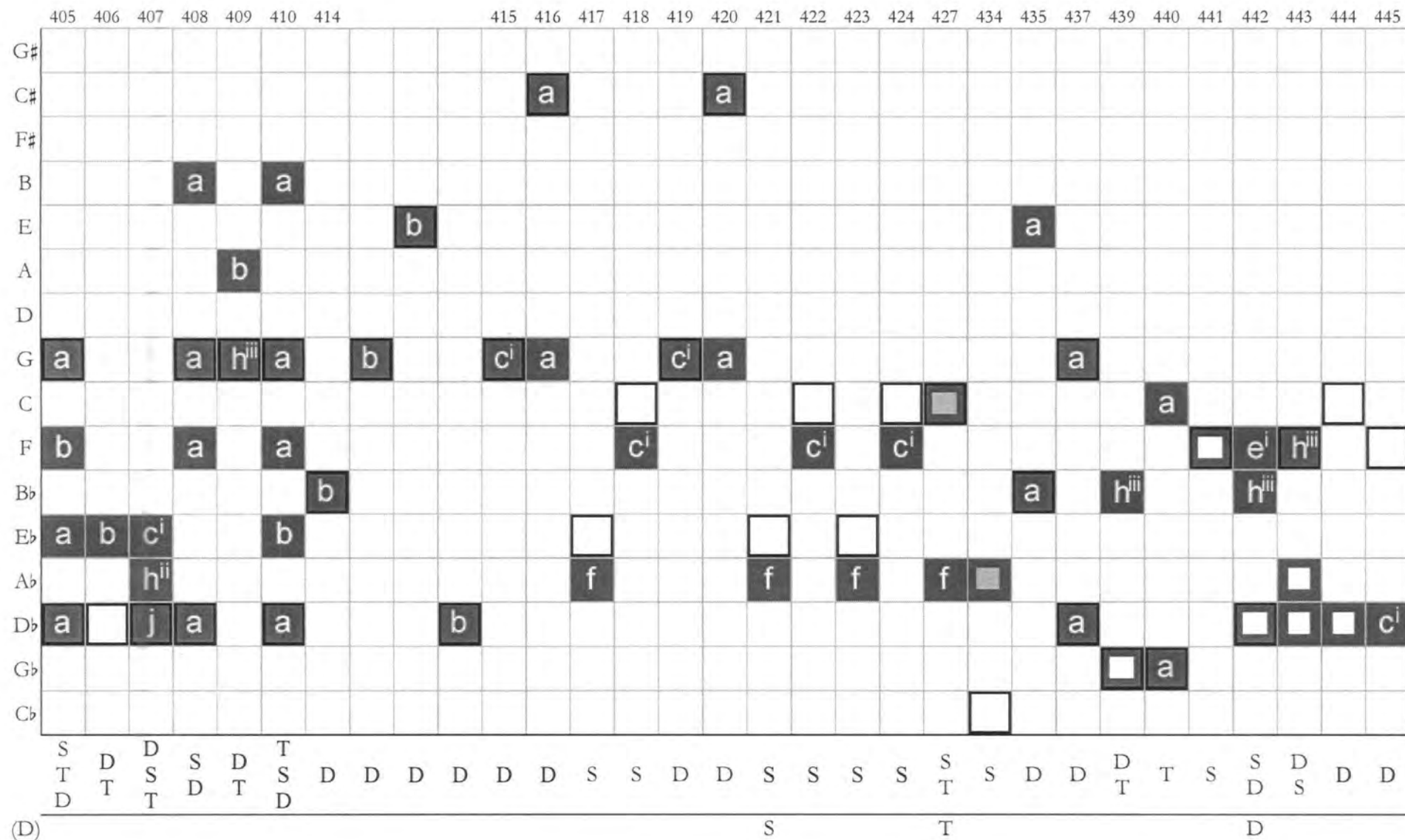

Appendix F: *Poem of Ecstasy*, Op.54 (cont.)

	447	449	450	451	452	453	454	455	457	459	460	461	462	463	464	465	467	473	477	478	479	480	481	482	483	484	485	486	489	490		
G#																																
C#				b					b																							
F#												c <sup>i</sup>		c <sup>i</sup>			c <sup>ii</sup>															
B							a	a		b										c <sup>i</sup>	c <sup>i</sup>			c <sup>i</sup>								
E																																
A		c <sup>i</sup>		b			c <sup>i</sup>			b	c <sup>i</sup>																					
D																		c <sup>i</sup>		c <sup>i</sup>	c <sup>i</sup>			c <sup>i</sup>	c <sup>i</sup>		e <sup>i</sup>		e <sup>i</sup>			
G	e <sup>i</sup>		b	c <sup>i</sup>	b			c <sup>ii</sup>	b	b		a		b		b				c <sup>i</sup>	c <sup>i</sup>	h <sup>iii</sup>	c <sup>i</sup>	b			e <sup>ii</sup>		e <sup>i</sup>		c <sup>i</sup>	e <sup>i</sup>
C																																
F							a	a			c <sup>i</sup>	a					f															
B <sup>b</sup>																																
E <sup>b</sup>	b	c <sup>i</sup>	c <sup>i</sup>					c <sup>i</sup>		b	a		c <sup>i</sup>		c <sup>i</sup>																	
A <sup>b</sup>																																
D <sup>b</sup>		j	b			b	j	b	b			b																				
G <sup>b</sup>																																
C <sup>b</sup>											a																					
	D	D	T	T	D	T	S	S	D	S	S	T	D	T	D	S	T	S	S	S	T	S	D	S	S	D	S	T	S	D		
	T	T	D	D		D	D	D	T	T	D					T	S	D	D	D	D	D	D	D	D	D	D	D	D	S	D	

(D)

Appendix F: *Poem of Ecstasy*, Op.54 (cont.)

	491	493	494	495	496	497	499	500	503	504	505	507	508	510	512	513	514	515	516	517	518	519	520	521	522	523	524			
G#																											h <sup>iii</sup>			
C#							c <sup>i</sup>											a										h <sup>iii</sup>		
F#								c <sup>ii</sup>								h <sup>iii</sup>		c <sup>i</sup>												
B			■					a									h <sup>iii</sup>				b					□				
E	□										a																	f		
A						h <sup>iii</sup>				b			e <sup>ii</sup>		□		b				a	a								
D	h <sup>iii</sup>					c <sup>i</sup>			c <sup>i</sup>							□				c <sup>i</sup>			f		a		e <sup>ii</sup>			
G	c <sup>i</sup>	c <sup>i</sup>					c <sup>i</sup>	c <sup>i</sup>		h <sup>iii</sup>					c <sup>i</sup>			a					c <sup>ii</sup>	□		a				
C	□	□		□	f	□	□		c <sup>i</sup>	g	b										c <sup>i</sup>			h <sup>iii</sup>		c <sup>i</sup>	c <sup>i</sup>			
F		□	□					a				h <sup>iii</sup>										b	j	c <sup>i</sup>						
B <sup>b</sup>									b	a		h <sup>iii</sup>											□		c <sup>i</sup>					
E <sup>b</sup>																		b				a	a		c <sup>i</sup>					
A <sup>b</sup>											■			c <sup>i</sup>											a					
D <sup>b</sup>																				e <sup>i</sup>						a				
G <sup>b</sup>													b																	
C <sup>b</sup>															c <sup>ii</sup>															
	D	T S D	T S D	S	T	T	T S D	T S D		T D D	D T	S	T D	S T	S D	T		D T	T	S	D	T	S T	S T	D S	T S D	S D	T D	S	D T
(D)				T																										

Appendix F: *Poem of Ecstasy*, Op.54 (cont.)

	525	526		527	528		529	530		531	532	533	534	535	537	538		539	541	543	545	547	552
G#								j															
C#																							
F#					j					c <sup>i</sup>													
B	b			a			a						c <sup>i</sup>						a			c <sup>ii</sup>	
E		j						c <sup>i</sup>															
A	a	a						b		a			a			a		a		c <sup>i</sup>			
D		f			c <sup>i</sup>																		h <sup>iii</sup>
G					b		a		e <sup>ii</sup>	a							c <sup>i</sup>	a	c <sup>i</sup>	c <sup>i</sup>	b	c <sup>i</sup>	c <sup>i</sup>
C																							
F		b			a	c <sup>ii</sup>		e <sup>ii</sup>	a		b		c <sup>i</sup>		c <sup>ii</sup>	c <sup>i</sup>		a			a		
B <sup>b</sup>																							
E <sup>b</sup>	c <sup>i</sup>	a			e <sup>i</sup>			b		a		c <sup>i</sup>	a				a		a				
A <sup>b</sup>																							
D <sup>b</sup>					b			a		a				c <sup>i</sup>	c <sup>i</sup>						c <sup>i</sup>		
G <sup>b</sup>																							
C <sup>b</sup>																		c <sup>i</sup>	a				
	S	S	D	T	S	S	S	T	S	D	T	D	T	S	S	S	S	T	S	T	S	D	S
	T	T			D	D		D		S		S		D	D	S		S	D	D	D	S	D

(D) D

Appendix F: *Poem of Ecstasy*, Op.54 (cont.)



	553	559	560	561	565	568	583	585	594	599	601
G#											
C#											
F#											
B		□									
E			□								
A				■		■		■			
D	■			■			■				
G	c'	b	c'								
C	□	□	□	□	□	□	■	□	□	□	□
F	□		f		f	c'	f	c'	f	c'	
B $\flat$											
E $\flat$											
A $\flat$											
D $\flat$											
G $\flat$											
C $\flat$											
	T	T	T	S	S	S	S	S	T	T	T
	S	S	D	T	S	T	T	S	S	S	T
	D	D									
(D)				T	S						T

Appendix F: *Poem of Ecstasy*, Op.54 (cont.)