



## Durham E-Theses

---

# *Pots, people, and politics: a reconsideration of the role of ceramics in reconstructions of the Iron Age Northern Levant*

Whincop, Matthew R.

### How to cite:

---

Whincop, Matthew R. (2008) *Pots, people, and politics: a reconsideration of the role of ceramics in reconstructions of the Iron Age Northern Levant*, Durham theses, Durham University. Available at Durham E-Theses Online: <http://etheses.dur.ac.uk/2539/>

### Use policy

---

The full-text may be used and/or reproduced, and given to third parties in any format or medium, without prior permission or charge, for personal research or study, educational, or not-for-profit purposes provided that:

- a full bibliographic reference is made to the original source
- a [link](#) is made to the metadata record in Durham E-Theses
- the full-text is not changed in any way

The full-text must not be sold in any format or medium without the formal permission of the copyright holders.

Please consult the [full Durham E-Theses policy](#) for further details.

---

Academic Support Office, Durham University, University Office, Old Elvet, Durham DH1 3HP  
e-mail: [e-theses.admin@dur.ac.uk](mailto:e-theses.admin@dur.ac.uk) Tel: +44 0191 334 6107  
<http://etheses.dur.ac.uk>

**Pots, People, and Politics:  
A Reconsideration of the Role of Ceramics in  
Reconstructions of the Iron Age Northern Levant**

**Matthew R. Whincop**

**Department of Archaeology, Durham University**

**Thesis Submitted for the Degree of Ph.D.**

**29 February, 2008**

The copyright of this thesis rests with the author or the university to which it was submitted. No quotation from it, or information derived from it may be published without the prior written consent of the author or university, and any information derived from it should be acknowledged.

**13 NOV 2008**

**Volume Two of Two**



# CONTENTS

---

## Volume Two

Appendix A: Gazetteer of North Levantine Iron Age Sites	1
Appendix B: Typological Data	38
Appendix C: Site Data	215
Appendix D: Iron I CLASSES and Late Bronze Age examples	291
Figures	
Maps	
Bibliography	
Contents of Appended CD	

# A P P E N D I X A

---

## Gazetteer of North Levantine Iron Age Sites

This gazetteer draws together a base level of information from North Levantine sites that have published a reasonable amount of Iron Age pottery or have contributed significantly to our understanding of this period. While sites like Zincirli, Aleppo and Arslan Tash have published little or no pottery, they have made a significant contribution to knowledge of the architecture and urban planning of the Iron Age, and for that reason are included. The site data is presented in a systematic fashion: the location and setting; historical connection; list of excavation; short list of published Iron Age ceramics.

### **A.1 Abou Danne, Tell (Syria)**

Located on the Raqqa – Aleppo road (the road runs along the southern base of the tell), Tell Abou Danne lies 25 km due east of Aleppo and 50 km west of the Euphrates River. The site is situated in the remarkably fertile basin of the *nahr Toman*, which flows into the large Djabboul (Jabbul) Lake 10 km to the south-east. The regular mound has a diameter of 300 m (c. 7 ha.) and height of 25 m (Lebeau 1983, 11).

#### **A.1.1 Ancient Iron Age Name:**

The ancient name of the site is currently not known.

#### **A.1.2 Seasons of Excavation**

R. Tefnin: 1974-1978, 1981

#### **A.1.3 Published Iron Age Ceramics**

Lebeau 1983; Tefnin 1980a

### **A.2 Abu Hawam, Tell (Israel)**

Tell Abu Hawam is composed of a small (c. 4 ha.), low (7 m above the plain) mound surrounded by an extensive settlement (c. 10 ha.), two inhumation necropolises

situated less than one kilometre from the tell, and three anchorage facilities (Balensi 1993, 7). It is today situated on the coastal plain near Mount Carmel and within the city limits of Haifa at a distance of around 2 km from the Mediterranean coast, but the site originally stood on the coast at the point where the Kishon River emptied into the bay of Haifa - the river mouth has long since silted up and moved. Its location is midway between Cyprus and the Nile Delta.

#### **A.2.1 Ancient Iron Age Name:**

The ancient name of the settlement at Tell Abu Hawam remains unknown, though Dever (1997c) suggests it may be identified with the biblical city of Shihor-Libnah mentioned in Joshua 19:26.

#### **A.2.2 Seasons of Excavation**

P. L. O. Guy and G. M. Fitzgerald: 1922

L. A. Mayer and N. Makhoul: 1929

N. Makhoul, D. Baramki and A. Vilensky: 1930

R. W. Hamilton (Department of Antiquities in Palestine): 1932-1933

E. Anati, Y. Olami and M. Prausnitz (Israel Antiquities Authority): 1952, 1963

J. Balensi (Centre National de la Recherche Scientifique): 1984-1989

#### **A.2.3 Published Iron Age Ceramics**

Hamilton 1934; 1935

### **A.3 Afis, Tell (Syria)**

Tell Afis is located to the immediate west of the modern Hama-Aleppo highway c. 3 km north of Saraqab, in the district (*Mohafazeh*) of Idlib. The region is fertile, favourable to both rainfall and irrigation agriculture, and is still renowned for olive oil production. The site itself consists of a circular lower mound (c. 28 ha), crowned with a steep acropolis toward its northern edge (Mazzoni and Cecchini eds 1998, 5).

#### **A.3.1 Ancient Iron Age Name:**

Apsuna (Ugaritic, Late Bronze Age)

Hazrak/Hazrek (Aramaic)

Hatarikka (Neo-Assyrian)

Hadrach (Hebrew, Old Testament)

Apish? (Aramaic)

In 1903, H. Pognon, the French Consul in Aleppo, passed through Saraqeb and discovered fragments of a stele bearing an Aramaic inscription. His account of the discovery does not explicitly mention Tell Afis, but the site has come to be identified with the city mentioned in the inscription, ancient Hazrek (Oggiano 1997, 186). The stele is dedicated by Zakkur, king of Hamath and Lu'ash, to god Iluwer for protecting Hazrek against a siege undertaken by a coalition led by the king of Damascus (Mazzoni 1998b, 7-9). Dornemann (2003, 4), however, has suggested an alternate identification with the ancient city of Apish, which also appears in the Zakkur stele.

### **A.3.2 Seasons of Excavation**

P. Matthiae (La Sapienza University, Rome): 1970, 1972, 1978, 1985

S. Mazzoni (University of Pisa) and S. M. Cecchini (University of Bologna): 1986-1989, 1991-1992, 1994, 1996-2006

### **A.3.3 Published Iron Age Ceramics**

Bonatz 1998; Canuti 2000; Cecchini 1988; 1993; 1998; 2000a; 2002; 2005; Chiti 2005; Ciafardoni 1988; D'Amore 1998; 2005; Degli Esposti 1998; Magazzù 2002; Matermawi 2005; Mazzoni 1988; 1990a; 1998a; 2000b; Oggiano 1997; 1999; 2002; Pedrazzi 2002; Scigliuzzo 2002; 2005; Soldi 2005; Venturi 1998a; 2000a; 2000b; 2002; 2005; del Vesco *et al.* 2005; Virgilio 2005

## **A.4 Ahmar, Tell (Syria)**

Located on the east bank of the River Euphrates, Tell Ahmar (literally the 'Red Mound') lies 20 km downstream from Jerablus (Carchemish) and the Turkish border. Now partially submerged by the waters of the Tishrin Dam, Tell Ahmar was once situated at the edge of a terrace overlooking the long alluvial plain of the Euphrates River (Bunnens 1990a, 2). The site stands 1.5 km from the point of confluence of the Euphrates and Sajur Rivers, and overlooks what was once a natural crossing point for the Euphrates. Like the nearby site of Carchemish, the site of Tell Ahmar boasts a tripartite plan: the Acropolis, Middle City and Lower City. The small Acropolis (c. 2 ha.) once stood 25 m over the surrounding plain; the French expedition removed the top seven metres of deposit from the tell and extended its southern edge with a large spoil-dump. The Middle city extends 350 m to the west and lies under much of the

modern village and cemetery. The Lower City is extensive; its semi-circular shape has a diameter of around 1200 m, suggesting an area of *c.* 59 hectares (Roobaert and Bunnens 1999, 163; Anastasio *et al.* 2004, 43).

#### **A.4.1 Ancient Iron Age Name**

Til Barsip (Aramaic)

Kar-Shalmeneser (Neo-Assyrian)

KTK (Aramaic)

Masuwari (Luwian)

The history of Tell Ahmar in the Iron Age has attracted much attention. The site is widely recognised as the capital of the small ‘Syro-Hittite’ kingdom of Masuwari (Hawkins 1983), before being transformed into the headquarters of the ‘Aramaean’ state of Bit-Adini, and then becoming the Assyrian Kar-Shalmeneser of the eighth and seventh centuries BCE (Schwartz 1989, 278). Ussishkin (1971), however, has reversed the sequence- he prefers to see the early Iron Age site as Aramaean before becoming Syro-Hittite about a century before Assyrian conquest. While the matter remains unresolved, Hawkins (1980; 1983) has suggested an alternative interpretation: that Tell Ahmar was a small kingdom of Hittite (Luwian) descent that was under regional authority of an Aramaean tribal leader. This, according to Hawkins, explains the Syro-Hittite character of the local art and the mention of Tell Ahmar as part of the Aramaean coalition against the Neo-Assyrians.

#### **A.4.2 Seasons of Excavation**

F. Thureau-Dangin (Musée du Louvre): 1928-1931.

G. Bunnens (Melbourne University until 1999, then Liege University): 1988-2006

#### **A.4.3 Published Iron Age Ceramics**

Wightman 1990b; Jamieson 1999; 2000; Green and Hausleiter 2000

### **A.5 Ain Dara (Syria)**

The site of Ain Dara lies in the Afrin valley, northern Syria, on the left bank of the Afrin River, upstream from the Amuq plain and 67 km north-west of Aleppo. The name of the site derives from the spring which lies 700 m to the east of the mound. The site consists of a steep upper mound (acropolis), which rises 30 m above the plain, and an extensive lower mound (24 ha.), which surrounds the acropolis on the northern and eastern sides (Abou Assaf 1997 and Stone and Zimansky 1999, 2). The



many visitors to the site, due to its proximity to both St Simeon and Cyrhus, approach the acropolis via a modern road which winds up through the lower city's northern gate, one of four in the Iron Age settlement (Abou Assaf 1990, Fig. 2). The lower tell was settled primarily during the Late Bronze and Iron Age (Stone and Zimansky 1999, 3-7). The acropolis, however, appears to be much older, with evidence of occupation as early as the fourth millennium BCE (Abou Assaf 1997).

### **A.5.1 Ancient Iron Age Name**

Matthiae (1981, 33) has suggested Ain Dara be identified with ancient Kinalua, the capital of the kingdom of Hattina, though Harrison *et al.* (2004, 122) prefers to associate Kinalua with Tell Tayinat. Regardless, Ain Dara and Tel Tayinat were probably part of this same kingdom.

### **A.5.2 Seasons of Excavation**

M. Dunand (French) and F. Seirafi (DGAM): 1956, 1962, 1964

A. Abou Assaf (DGAM): 16 seasons between 1976 and 1992

E. C. Stone and P. E. Zimansky (American): 1982-1984

### **A.5.3 Published Iron Age Ceramics**

Stone and Zimansky 1999

Very little has been published regarding the Iron Age ceramics of the site. Even the final report of the American excavation of the lower town presents a somewhat limited corpus of ceramic profiles despite over 129,000 sherds having been catalogued during the course of two seasons (Stone and Zimansky 1999, 59). The ceramics from the Syrian expedition to the acropolis are currently in preparation for publication.

## **A.6 Akhziv (Israel)**

Akhziv is located on the northern coast of Israel, about 15 km north of 'Akko and 25 km south of Tyre (Dayagi-Mendels 2002, 1). The site itself is unremarkable, except for the associated 'Phoenician' cemeteries. The southern cemetery (*Minet ez-Zib* – literally the port of Akhziv because of its vicinity to the silted-up harbour of the Sha'al River) is situated on the Mediterranean shore less than a kilometre south of the double tell and extends over a great area, about 5000 square metres according to Ben Dor (Dayagi-Mendels 2002, 1). The tombs are on a sandstone (*kurkar*) ridge

below the sand dunes, with nothing notable on the surface to indicate their presence. Other cemeteries are located to the east of the tell (*er-Ras*), on a hard limestone spur, and to the north (a large ashlar-built chamber tomb and cremation field).

#### **A.6.1 Ancient Iron Age Name**

Achzib (Hebrew, Old Testament)

Ez-Zib (Aramaic)

Akzibi (Neo-Assyrian)

Accipu (Neo-Assyrian)

The city is mentioned twice in biblical sources as an undefeated Canaanite city. It also appears in Assyrian records as a fortified city conquered by Sennacherib in 701 BCE, as part of the same campaign that saw Sidon, Sarepta and 'Akko subjugated (E. Mazar 1993, 32). The identification of the site with ancient Akhzib is due to the etymologically similar modern name.

#### **A.6.2 Seasons of Excavation**

I. Ben Dor (British Mandatory Department of Antiquities in Palestine): 1941-1944

Z. Goldmann (Israeli): 1954

M. Prausnitz (Israel Department of Antiquities): nine seasons between 1957-1984

E. Mazar (Hebrew University, Jerusalem): 1988-1990, 1994, 2002

#### **A.6.3 Published Iron Age Ceramics**

Culican 1970; 1982; E. Mazar 1993; 2001; 2004; Dayagi-Mendels 2002

### **A.7 Aleppo (Syria)**

The second largest city within modern Syria, Aleppo is located in the northern part of the country on the banks of the River Quweiq, equidistance from the Mediterranean Sea and Euphrates River. Due to the extensive size of the modern city, archaeological investigation has been somewhat limited, though excavations have recently returned to the ancient tell situated within the Aleppo citadel. Determining the size and extent of ancient Aleppo remains difficult, though the listing of Aleppo as a UNESCO World Heritage site will protect the region for possible future investigation.

#### **A.7.1 Ancient Iron Age Name**

HRB (Akkadian, Late Bronze Age)

Halpa (Hittite, Bronze Age)

Hallaba (Neo Assyrian)

Halman (Neo Assyrian)

Halwan (Neo Assyrian)

Aleppo is known as the administrative and cultic centre of Halab, the capital of the independent 'Syro-Hittite' kingdom of Yamhad (Pitard 1997). Following repeated conquests by the Assyrians (853 and 743 BCE) and Urartians, Aleppo was reduced to political insignificance during much of the Iron Age, but remained a major centre for the worship of Hadad, the storm god (Miller 1958, 2).

#### **A.7.2 Seasons of Excavation**

G. Ploix de Rotrou (Musée d'Alep; Service des Antiquités): 1929-1936

R. Saba: 1981, 1983

W. Khayyata (DGAM) and K. Kohlmeyer (Frei Universitat, Berlin): 1995-1997, 1999-2005

#### **A.7.3 Published Iron Age Ceramics**

None

### **A.8 Amuq Plain (Turkey)**

The Amuq Valley (alternatively known as the Hatay or Plain of Antioch), which was annexed to the Turkish Republic in 1939, constitutes the southernmost province of Turkey. The large (1,400 sq. km) fertile plain is extremely well-watered, with three large rivers flowing into the basin before conjoining and flowing west to the Mediterranean (Pamir 2005, Fig. 3.1). The Orontes River enters the Amuq from the south and bends westward. The *Kara Su* (literally black water) and Afrin River enter the Amuq from the north and east respectively, before joining the Orontes' flow toward the sea. The fertile plain is framed by mountains on all sides, except where the three rivers enter and exit the plain; the Taurus Mountains to the north rise up toward the Anatolian plateau. Of the sites surveyed by the Oriental Institute in the 1930s, three yielded significant Iron Age assemblages: Chatal Höyük, Tell Judeideh and Tell Ta'yinat. The first two sites are located near the town of Rihaniyyah, while the third lies immediately east of the modern village of *Jisr el-Hadid*. Excavation was also undertaken at Tell Atchana (ancient Alalakh) and Tell Kurdu, though neither yielded significant (if any) Iron Age material.

### **A.8.1 Ancient Iron Age Name**

#### Amuq Region

Paddan-Aram (Hebrew, Old Testament)

Patina (Luwian)

Unqi (Akkadian)

‘MQ (Aramaic)

Umqa (Syriac)

#### Tell Ta’yinat

Kullani (Neo-Assyrian)

Kunalua (Luwian)

The territory of the Amuq was occupied by the ‘Syro-Hittite’ kingdom of Patina (Harrison 2001a, 116-117), though it appears to also have been known by the name Unqi (Braidwood 1937, 1; McEwan 1937, 8). Fragments of a small Iron Age bowl were found at Tell Ta’yinat inscribed with the word KNLH, linguistically very similar to Kunulua, capital city of the kingdom of Patina/Unqi (Harrison *et al.* 2004, 122; Swift 1958, 191-192). This identification appears supported by the military annals of Ashurnasirpal II (c. 870 BCE), who locates the city at the southern edge of the Amuq (Hawkins 1982, 389). The later use of the term ‘MQ (the Aramaic equivalent of the Akkadian Unqi) has been interpreted as representing Aramaic ascendancy in the area.

The excavations at Tell Ta’yinat by the Oriental Institute of the University of Chicago produced an extensive corpus of Akkadian, Aramaic and Luwian inscriptions; Luwian hieroglyphic inscriptions account for the largest number (over 85 fragments).

### **A.8.2 Seasons of Excavation**

Oriental Insitute: C. W. McEwan and R. J. Braidwood:

Chatal Höyük: 1932-1935

Tell al-Judeideh: 1934-1936

Tell Ta’yinat: 1935-1938

In recent years a University of Toronto project has returned to Tell Ta’yinat:

T. Harrison (University of Toronto, Canada): 2004-2006, 2007?

### **A.8.3 Published Iron Age Ceramics**

Batiuk *et al.* 2005; Casana and Wilkinson 2005; Harrison *et al.* 2006

## **A.9 Arqa, Tell (Lebanon)**

Tell Arqa is a high (40 m), multi-period tell situated in northern Lebanon. It lies twenty kilometres north of Tripoli and c. 5 km inland, near where the Homs-Tripoli gap debouches into the Mediterranean. The tell looms over the surrounding Akkar Plain, the vast fertile plain watered by the *Nahr el-Kebir*, which is today the Syrian border. Found at the very southern edge of the plain, Tell Arqa is one of three large tells in the Akkar (the other two are Tell Kazel and Tell Jamous). Despite its imposing height, the modest area of the mound (c. 4 ha.) belies a settlement of intermittent occupation and sporadic prosperity (Thalman 1978, 3).

### **A.9.1 Ancient Iron Age Name**

Irqata (Akkadian, Amarna Letters)  
RQT (Akkadian, Late Bronze Age)  
Arka (Hebrew, Old Testament)  
'Arqa (Phoenician)  
'Arqu (Aramaic)

### **A.9.2 Seasons of Excavation**

J.P. Thalman (Centre National De La Recherche Scientifique): 1972-1974, 1978-1981, 1992-2005

### **A.9.3 Published Iron Age Ceramics**

Will *et al.* 1973; Thalman 1978a; 1978b; 1983; 1990; Chaaya 2000

## **A.10 Arslan Tash (Syria)**

Arslan Tash is located in northern Syria approximately 30 km northeast of Tell Ahmar and the Euphrates River and 6 km south of the modern Turkish border. The large oval mound, c. 30.5 ha. (728 m x 560 m), lies in the middle of the fertile Plain of Saruj (Anastasio *et al.* 2004, 58). The name of the site, which literally means 'lion stone' in Turkish, derives from the large basalt lion statues that were originally found lying on the site's surface.

### **A.10.1 Ancient Iron Age Name**

Hadatu (Neo-Assyrian)  
Dur-Tukulti-apil-Esarra (Neo-Assyrian)

### **A.10.2 Seasons of Excavation**

G. Paşa (Ottoman Turkish): 1886

F. Thureau-Dangin (Musée du Louvre): 1927-1929

L. Delaporte: 1938

### **A.10.3 Published Iron Age Ceramics**

None identified

## **A.11 ‘Athlit (Israel)**

‘Athlit is located on the northern coast of Palestine, approximately 12 km south of the modern city of Haifa. It is situated on a kurkar ridge adjacent to a natural bay. Evidence for Iron Age occupation initially consisted of the remains of fourteen chamber tombs exposed beneath the medieval castle (Johns 1931, 111) on a natural promontory (Johns 1931, Pl. 40; 1932, Fig. 1). The remains of an Iron Age settlement were found to the east and south-east of the promontory within a low lying (7 m above sea level), medium-sized (c. 8 ha) tell that boasts evidence of occupation from the Late Bronze Age to the Roman Period (Johns 1934, 145-146).

### **A.11.1 Ancient Iron Age Name**

Although ‘Athlit is not mentioned explicitly in ancient sources, the site has been identified with Kartah of Zebulun mentioned in Joshua 21:34 (Johns 1993, 112).

### **A.11.2 Seasons of Excavation**

C. N. Johns (Department of Antiquities in Palestine): 1930-1933, 1935

A. Raban and A. Haggi (University of Haifa): 2002-2003

### **A.11.3 Published Iron Age Ceramics**

Johns 1932; 1934; 1938; Haggi 2006

## **A.12 Beirut (Lebanon)**

While Lebanon’s capital, Beirut is today a thriving metropolis that covers a large area, the ancient settlement of Beirut was initially located on the northern side of the natural promontory that today forms the Beirut Town Centre. Occupation was originally restricted to a small tell (2.5 ha.) that lies to the south of the modern harbour of Beirut (Badre 1998, 73). Ancient Biruta (of the Amarna texts) took the form of a small arc facing the sea, before expanding during the Classical period to cover much of the promontory.

### **A.12.1 Ancient Iron Age Name**

Beruta/Biruti (Amarna letters, 14<sup>th</sup> century BCE)

Kur *bi-ru-ù-ti* / Kur *bi-ru-ut-ti* (Ugaritic texts, 14<sup>th</sup>-13<sup>th</sup> centuries BCE)

Bi'ru (Neo-Assyrian, Esarhaddon Prism inscription)

Beerot (Phoenician)

Berytos (Greek)

The oldest confirmed references to Beirut are found in the Amarna Letters of the fourteenth century BCE (Curvers and Stuart 1996, 228). During the Iron Age, however, there is only one possible mention of the site, a reference that lists Bi'ru amongst the cities within the kingdom of Sidon (Badre 1997b, 12). The conspicuous scarcity of Iron Age references has brought into question the importance of this city during the first millennium BCE, though recent excavations have begun to reverse that image.

### **A.12.2 Seasons of Excavation**

R. du Mesnil du Buisson and T. Homolle (French): 1924

L. Brossé, L. Albanèse, F. Anus and M. Chéhab (Service des Antiquités): 1924-1932

R. du Mesnil du Buisson (French): 1927-1928

H. Fleisch: 1947

H. Kalayan: 1968-1969

C. Forest and J.D. Forest: 1977

BCD Archaeology Project (UNESCO, DGA and Solidere): 1993-2003

### **A.12.3 Published Iron Age Ceramics**

Badre 1997b; 1998; 2000b; Doumet-Serhal and Sayegh 1998; Jabak *et al.* 1998; Sapin and Sayegh 1998; Shefton *et al.* 1998; Elayi and Sayegh 2000

Despite a good Iron Age ceramic sequence being obtained from the excavations under the BCD 'umbrella', no comprehensive typology or catalogue has been published (e.g. Núñez 2001-2002; Curvers and Stuart 1997, 182-183).

## **A.13 Beth Shan, Tel (Israel)**

Tel Beth Shan (*Tell el-Husn* in Arabic) is located on the western edge of the Jordan Valley, approximately 20 km south of the Sea of Galilee (*Yam Kinneret*). The site guards the ford of the Jordan 5 km to the east and lies near the junction of the Jezreel and Jordan Valleys, which were both important roads in the ancient world. The steep but small (c. 4 ha) conical tell is situated on a high hill, though still 300 m below sea

level. Excavations have revealed an almost continuous occupation of the site from the Neolithic to the Early Medieval period. The classical settlement (Scythopolis) outgrew the tell and a large urban centre developed around the foot of the mound.

Tel Rehov (*Tell es-Sarem* in Arabic) is one of the largest mounds (c. 10 ha) in Palestine. The upper tell rises 20 m above the surrounding alluvium of the Beth Shan Valley and is visible from the site of Pella, 10 km to the east (A. Mazar 1999a, Fig. 1). The lower mound is elongated and rises 8 m above the plain and is heavily eroded on its eastern edge. Tel Rehov is situated at the western edge of the Jordan Valley, 6km from the Jordan River and 5 km south of Beth Shan.

### **A.13.1 Ancient Iron Age Name**

Beth Shan (Hebrew, Old Testament)

Bit Sani (Amarna Letters)

Beit She'al (Egyptian)

Beth Shan is mentioned in the biblical text as an unconquered Canaanite city (Joshua 17:11), and where the Philistines impaled the body of Saul and his sons on the city-wall (1 Samuel 31:10).

Rehob (Hebrew)

Rehob (Egyptian, Shoshenq's Year 5 inscription at Karnak)

Rehov (literally 'street' in Hebrew) was the name of several cities mentioned in ancient texts, and is identified with *Tell es-Sarem* due to the survival of the name Rehov at the nearby Islamic holy tomb (*esh-Sheikh er-Rihab*).

### **A.13.2 Seasons of Excavation**

C.S. Fisher (University of Pennsylvania): 1921-1923

A. Rowe (University of Pennsylvania): 1925-1928

G.M. Fitzgerald (University of Pennsylvania): 1930, 1933

Y. Yadin and S. Geva (Hebrew University, Jerusalem): 1983

A. Mazar (Hebrew University, Jerusalem): 1989-1996

Tel Rehov:

F. Vitto: 1974-1980 (five seasons)

A. Mazar (Hebrew University, Jerusalem): 1997, 1998, 1999, 2000, 2001, 2002, 2003, 2004, 2005, 2006, 2007

### **A.13.3 Published Iron Age Ceramics**

Beth Shan: James 1966; Oren 1973; Yadin and Geva 1986; A. Mazar 1993b; 2001

Rehov: A. Mazar 1999a;



## **A.14 Byblos (Lebanon)**

The ancient site of Byblos is located on a short headland known locally as *Djebeil* (or *Gabayl*). It lies on the Lebanese coast roughly equidistant (c. 40 km) between Beirut and Tripoli. The short promontory provided two natural harbours for the site, a feature common amongst coastal settlements of the region. Before excavation the large mound (c. 10 ha.) stood 12 m. above the surrounding coastline.

### **A.14.1 Ancient Iron Age Name**

Gebal (Hebrew, Old Testament)

KBN (Akkadian, Late Bronze Age)

KPNJ (Akkadian, Late Bronze Age)

Gubla (Akkadian, Amarna Letters, Late Bronze Age)

Gublu (Neo-Assyrian)

Byblos (Greek, Achaemenid and Hellenistic Periods)

### **A.14.2 Seasons of Excavation**

E. Renan (French): 1860-1861

J. Rouvier: 1899

Freres Maristes: 1914

P. Montet (Service des Antiquités): 1919, 1921-1924

M. Dunand (Service des Antiquités): 1926, 1928-1933, 1935-1941, 1943-1944, 1948-1952, 1954-1962, 1964-1965, 1971-1973

J. Lauffray (French): 1940

Direction Générale des Antiquities: 1946

M. Chéhab (Lebanese Department of Antiquities): 1960

### **A.14.3 Published Iron Age Ceramics**

Dunand 1939a; 1939b; 1950; 1954; Culican 1970; Salles 1980; Homsy 2003

## **Chatal Höyük (Turkey) - see A.8 Amuq**

## **A.15 Dan, Tel (Israel)**

Tel Dan (*Tell el-Qadi* in Arabic, literally the 'mound of the judge') lies at the foot of Mount Hermon on the present-day border between Israel and Syria (Biran 1994, 21). It is situated in the heart of a rich and fertile region; the spring flowing in and around the mound is one of three sources of the Jordan River. The edge of the large (c. 20

ha) tell rises 20 m above the plain, while the central area descends 10 m in height, giving the impression of a crater.

#### **A.15.1 Ancient Iron Age Name**

Dan (Hebrew, Old Testament)

Laish/Leshem (Canaanite, Mari Documents, Egyptian Execration Texts)

The identification of Biblical Dan with *Tell el-Qadi* was first suggested in the mid-nineteenth century by Robinson, but wasn't confirmed until 1976, when excavations discovered a bilingual (Greek and Aramaic) inscription; "To the god who is in Dan" (Biran 1994, 25). The city is mentioned repeatedly in the biblical source, in particular as the northern-most point of ancient Israel. The city also appears in Egyptian Execration texts and the Mari Letters, though under the city's former name, Laish or Leshem. According to the biblical account, the name was changed to Dan when that Israelite tribe conquered Laish.

#### **A.15.2 Seasons of Excavation**

Z. Yeiven: 1963

A. Biran (Hebrew Union College, Jerusalem): 1966-1972, 1974-2005

#### **A.15.3 Published Iron Age Ceramics**

Biran 1982; 1989a; 1989b; 1994; 1996b; 1999; Pakman 1992

### **A.16 Deve Höyük (Turkey)**

Deve Höyük is a small village in the Sajur Valley, about 30 km west of Jerablus and the Euphrates River. The village consists of a cluster of houses surrounding the southern slope of a small tell. Little more is known about the site, except that an ancient cemetery was located on the north eastern edge of a shallow depression surrounding the mound.

#### **A.16.1 Ancient Iron Age Name**

Not known

#### **A.16.2 Seasons of Excavation**

No systematic excavation at Deve Höyük was undertaken, only the illicit plundering of "some fifty peasants... in full view of the Baghdad railway" (Woolley 1914-1916, 115).

### **A.16.3 Published Iron Age Ceramics**

Woolley 1914; 1914-1916; Moorey 1975; 1980; Klengel-Brandt 1990

## **A.17 Ghassil, Tell el- (Lebanon)**

The small mound (c. 3 ha.) of Tell el-Ghassil is located in the northern reaches of the Beqa' Valley of Lebanon. The small mound lies 18 km southwest of Baalbek and to the immediate east of the Litani River (*Nahr al-Litani*). The site derives its name from the nearby spring, Ayn Ghassil, which emerges from the 1,000 m contour of the Lebanese Range.

### **A.17.1 Ancient Iron Age Name**

The ancient name of the site is currently not known.

### **A.17.2 Seasons of Excavation**

D. C. Baramki (AUB): 1956-1961, 1963, 1968-1969

L. Badre (AUB): 1972-1974.

### **A.17.3 Published Iron Age Ceramics**

Baramki 1961; 1964; 1966; Joukowsky 1972 (unpublished); Marfoe 1995

## **A.18 Hama (Syria)**

Situated in west-central Syria, the ancient mound of Hama is located on the left bank of the River Orontes at the point where a major north-south road crossed the river. The modern city of the same name, however, has significantly grown to encompass both banks of the river, and the site itself is now on its north-western outskirts. The steep tell still dominates the city skyline as it towers 46 m above the river (Ingholt 1942, 469).

### **A.18.1 Ancient Iron Age Name**

Hamath (Hebrew, Old Testament)

Hamati (Akkadian, Late Bronze Age)

‘MT/HMT (Akkadian, Late Bronze Age)

Tunip (Amarna Letters, Late Bronze Age)

Amatu (Luwian)

Hamatu (Neo-Assyrian)

Neo-Assyrian records reveal that during the middle of the 9<sup>th</sup> century BCE, Urhilina, king of Hamatu, played an important role in a coalition that was able to temporarily

arrest Assyrian advances toward the west. By the late 8<sup>th</sup> century BCE, however, many of the provinces belonging to Hamatu had to be surrendered and a large number of inhabitants were deported by the rampaging Assyrians (Buhl 1992, 34).

### **A.18.2 Seasons of Excavation**

H. Ingholt (Carlsberg Foundation of Copenhagen): 1931-1938

K. Chehade: 1960

### **A.18.3 Published Iron Age Ceramics**

Riis 1948; 1970; Fugmann 1958; Buhl 1983; Francis and Vickers 1985; Riis and Buhl 1990

## **A.19 Hazor (Israel)**

Biblical Hazor has long been associated with *Tell el-Qedah* located in Upper Galilee, 14 km north of the Sea of Galilee and 8 km southwest of Lake Hula. The site comprises two distinct areas: the 40 m high acropolis mound (c. 10 ha); and the extensive (c. 80 ha) rectangular mound of the lower city (Ben Tor 1997, 107; Yadin *et al.* 1958, Pl. I). The lower city is protected by huge ramparts, a fosse and a glacis.

### **A.19.1 Ancient Iron Age Name**

Hazor (Hebrew, Old Testament and Armana Letters)

Hazor and Laish (Tel Dan) are the only two Canaanite cities mentioned in the Mari archives of the Middle Bronze Age. The frequency with which Hazor appears in these documents is indicative of its importance during the 2<sup>nd</sup> millennium BCE; indeed, the site covers its largest area during this period (Ben Tor 1993a, 603). Hazor appears in the biblical record foremost as the chief Canaanite city of the region, which is conquered and settled by the invading Israelite tribes (Joshua 11:10-13).

### **A.19.2 Seasons of Excavation**

J. Garstang (British Mandatory Department of Antiquities in Palestine): 1928

Y. Yadin (Hebrew University, Jerusalem and Israel Exploration Society): 1955-1958, 1968-1969

A. Ben Tor (Hebrew University, Jerusalem): 1990-2007

### **A.19.3 Published Iron Age Ceramics**

Yadin *et al.* 1958; 1960; 1961; Ben Tor *et al.* 1997; Ben Tor and Ben Ami 1998; Finkelstein 1999a; Ben Ami 2001; 2006

## **A.20 Jerablus (Turkey) including Kefrik and Merj Khamis**

The site of Barak, more commonly known as Jerablus (or *Jerabis* in Arabic), lies at the extreme north of the plain of Jerablus (Anastasio *et al.* 2004, 83). It is a large tell site on the right bank of the Euphrates River, situated by the modern border of the Turkish and Syrian Arab Republics, c. 100 km north east of Aleppo and 60 km south of Gaziantep. The somewhat tense, though generally cordial relations between these two nations means the site, which is actually cut by the border, is unavailable for further study. The eastern half of the tell is well protected by the deeply incised Euphrates River, while the western portion of the site is protected by long mud-brick city walls, still visible as large earth mounds at the time of the British Expedition. In ancient times the extensive city commanded the main ford across the Euphrates.

### **A.20.1 Ancient Iron Age Name**

KRKMS (Akkadian, Late Bronze Age)

Kargamiş (Hittite, Late Bronze Age)

The city of Carchemish, known from biblical, Assyrian and Egyptian sources, was first identified with Jerablus by George Smith in 1876.

([www.pef.org.uk/EarlySyriaPages/Carchemish.htm](http://www.pef.org.uk/EarlySyriaPages/Carchemish.htm)).

### **A.20.2 Seasons of Excavation**

A. E. Henderson (British Museum): 1876-1879

D.G. Hogarth, C.L. Woolley and T.E. Lawrence (British Museum): 1911-1914

C.L. Woolley (British Museum): 1920

The Yunus cemetery at Carchemish was excavated in 1913 by the British Museum Expedition.

### **A.20.3 Published Iron Age Ceramics**

Woolley 1914; 1921a; 1939b; 1952; Moorey 1980

## **A.21 Jezreel, Tel (Israel)**

The site of Tel Jezreel (or *Yizre'el*, literally 'God sows') is situated at the eastern part of the Valley of Jezreel, and lies almost equidistant between the two large mounds of Beth Shan and Megiddo. Situated on the very edge of a 100 m high ridge extending along the southern side of the valley, the view from the site is a commanding and strategic one. The relatively small (6 ha.) mound is roughly rectangular in shape,

indicative of the regular casemate wall exposed in the excavations (Ussishkin and Woodhead 1992).

#### **A.21.1 Ancient Iron Age Name**

Jezreel (Hebrew, Old Testament)

#### **A.21.2 Seasons of Excavation**

O. Yogev (Israel Department of Antiquities): 1987-1988

J. Woodhead (British School of Archaeology in Jerusalem) and D. Ussishkin (Tel Aviv University): 1990-1996.

#### **A.21.3 Published Iron Age Ceramics**

Zimhoni 1992 (reprinted as Zimhoni 1997a); Zimhoni 1997c (reprinted as Zimhoni 1997b)

### **A.22 Joya (Lebanon)**

The cemetery of Joya lies about 10 km inland (east) of Tyre in the south of Lebanon, approximately equidistant between Khirbet Silm and Tyre (Chapman 1972, 56). The nature of the site is not known.

#### **A.22.1 Ancient Iron Age Name**

Not known

#### **A.22.2 Seasons of Excavation**

Clandestine excavation only

#### **A.22.3 Published Iron Age Ceramics**

S. V. Chapman 1972

### **Judeideh, Tell (Turkey) - see A.8 Amuq**

### **A.23 Jurn Kabir, Tell (Syria)**

Located on the right bank of the Upper Syrian Euphrates, Tell Jurn Kabir is situated 2.5 km south of the Islamic fortress *Qal'at Najm* (Eidem 1999a, 149-153). Aleppo lies 80 km to the west. The small (c. 3 ha.), low mound of Tell Jurn Kabir is heavily eroded. The site is surrounded by the village of Jurn Kabir, founded sometime in the late nineteenth century (Eidem 1999a, 152; Anastasio *et al.* 2004, 188).

### **A.23.1 Ancient Iron Age Name**

The ancient name of the site is currently not known.

### **A.23.2 Seasons of Excavation**

J. Eidem (Carsten Niebuhr Institute, University of Copenhagen): 1993-1998

### **A.23.3 Published Iron Age Ceramics**

Eidem 1999b; Eidem and Ackermann 1999; Eidem and Putt 1999; 2001;

## **A.24 Kamid el-Loz (Lebanon)**

Kamid el-Loz is a steep tell site within the southern reaches of the Beqa' Valley, where the alluvial plain rises toward the Anti-Lebanon Range (Kushcke 1966, 15; Hachmann 1989, Fig. 6). A modern town of the same name is located to the immediate south of the oval mound and a modern cemetery covers the south eastern quarter of the site. The tell of Kamid el-Loz is one of the largest (c. 7 ha) and tallest (26 m) within the Beqa' Valley, though it is relatively small when compared to the size of the large Syrian and Mesopotamian tells (Hachmann 1989, 13). The Litani River lies 3 km to the west, though there is a spring to the immediate north.

### **A.24.1 Ancient Iron Age Name**

Kumidi (Akkadian, Amarna Letters, Late Bronze Age)

KMT (Egyptian texts)

Cuneiform texts found within the Late Bronze Age temple at Kamid el-Loz have confirmed the identification of the site with the Bronze Age city of Kumidi (Heinz 2004, 570), an identification that was originally postulated in the late nineteenth century (Hachmann 1989, 89).

### **A.24.2 Seasons of Excavation**

R. Mouterde (French) and A. Beaulieu: 1934

R. Hachmann (University of Saarbrücken, Germany) and A. Kuschke (University of Mainz, Germany): 1963-1964

R. Hachmann: 1966-1971, 1973-1974, 1977-1981

M. Heinz (Albert-Ludwigs University-Freiburg, Germany): 1997, 1999-2002, 2004-2005

### **A.24.3 Published Iron Age Ceramics**

Hachmann 1966; Hachmann and Kuschke 1966; Poppa 1978; Marfoe 1995; 1998; Heinz *et al.* 2004

## **A.25 Kazel, Tell (Syria)**

Tell Kazel is situated 3.5 km from the Syrian coast, within the northern limits of the Akkar Plain and 18 km south of Tartous (Badre 2006, 65). The tell is oval in shape with particularly well-defined upper edges, suggesting the presence of significant fortifications on the edge of the acropolis; three depressions along the edge are probably the three city gates. The height of the large (11 ha.) tell reaches 25 m above the level of the surrounding Akkar Plain (Badre 1990a, 13). Tell Kazel is the largest site in the Akkar (Thalman and al-Maqdissi 1989, 98) and is the only one boasting evidence of continuous occupation from the 4<sup>th</sup> to 1<sup>st</sup> millennium BCE.

### **A.25.1 Ancient Iron Age Name**

Zemar (Hebrew, Old Testament)

DMR (Akkadian, Late Bronze Age)

Sumur (Akkadian, Amarna Letters, Late Bronze Age)

Samuri/Simirra (Neo-Assyrian)

Simyra (Greek)

The site is thought to be historical Simyra/Sumur, an identification first presented by M. Dunand (Dunand and Saliby 1957, 1-10), developed by H. Klengel (1984, 6) and today widely accepted (Gubel 2000; Sader 1990a; cf. Stieglitz 1991). However, this interpretation is based on a number of assumptions; foremost being that the historical importance of Simyra is comparable with the size of Tell Kazel. The identification of Tell Kazel with Sumur has not yet been established by any inscription found on the site (Badre 2006, 67).

### **A.25.2 Seasons of Excavation**

M. Dunand and N. Saliby (DGAM): 1960-1962

A. Bounni (DGAM): 1985

L. Badre (American University in Beirut Museum): 1985-2001

### **A.25.3 Published Iron Age Ceramics**

Dunand and Saliby 1957; Dunand *et al.* 1964; Gubel 1990a; Badre 1990b; 2006; al Maqdissi 1990; Yon and Caubet 1990; Badre *et al.* 1994; 2005; Badre and Gubel 1999-2000; Capet and Gubel 2000; Capet 2003



## **A.26 Keisan, Tell (Israel)**

Situated between Haifa and Akko, the high conical mound of Tell Keisan is prominent within the landscape of the Akko Plain (Briend and Humbert 1980, Pl. 2). Although the site today lies 8 km inland, it originally stood much closer to the coast, effectively linking the hills of the Lower Galilee with the Mediterranean Sea (Briend and Humbert 1980, Pl. 1). The surviving mound rises to a height of at least 25 m above the alluvial plain and covers an area of c. 6 hectares (Briend and Humbert 1980, 3; Seton-Williams 1980, 381).

### **A.26.1 Ancient Iron Age Name**

The ancient name of the site is not known, though a number of arbitrary identifications have been suggested, all of them biblical: Kishion; Allammelech; Mishal and Akshaph (Garstang 1931, 354; Humbert 1993, 862).

### **A.26.2 Seasons of Excavation**

J. Garstang and A. Rowe (Department of Antiquities in Palestine): 1935-1936

R. de Vaux, J. Prignaud, J. Briend and J.-B. Humbert (École Biblique et Archéologique Française): 1971-1976

### **A.26.3 Published Iron Age Ceramics**

Briend and Humbert 1980; Seton-Williams 1980

## **A.27 Khalde (Lebanon)**

About 12 km south of Beirut, Khalde (*Kobbet Choueifat*) is situated beside the Beirut International Airport, and is cut by the Beirut-Sidon Highway (Saidah 1966, 51). The large Iron Age necropolis (c. 500 m in length) lies atop two promontories sloping down to the Mediterranean Sea. The site's proximity to Beirut ensured its importance in ancient times, as indicated by the large number (over 400) of intact Iron Age burials found *in situ* (Badre 1997a). The extensive cemetery points to an equally large settlement nearby, though it was not found and was probably destroyed by modern construction.

### **A.27.1 Ancient Iron Age Name**

Hi-il-du-ya (Akkadian, Neo-Assyrian)

Heldua? (Greek)

Khalde is identified with ancient Hi-il-du-ya, a city of the kingdom of Sidon annexed by Esarhaddon in the first half of the seventh century BCE.

#### **A.27.2 Seasons of Excavation**

H. Kalayan (Directeur Général des Antiquités): 1960

R. Saidah (Service des Antiquités): 1961-1966, 1974-1975

#### **A.27.3 Published Iron Age Ceramics**

Saidah 1966; 1971; Culican 1982

### **A.28 Khirbet Silm (Lebanon)**

Khirbet Silm (occasionally Khirbet Selim) lies several kilometres inland from Tyre in southern Lebanon. Nothing has been published regarding the nature of the site.

#### **A.28.1 Ancient Iron Age Name**

The ancient name of Khirbet Silm remains unknown.

#### **A.28.2 Seasons of Excavation**

Albanèse (Service des Antiquités): 1924-1926

#### **A.28.3 Published Iron Age Ceramics**

Chapman 1972; Culican 1982

### **A.29 Mastuma, Tell (Syria)**

Located in northwest Syria approximately 60 km southwest of Aleppo and 5 km directly south of Idlib, Tell Mastuma consists of a relatively small tell (diameter of around 200 m; c. 3 ha.) that rises little more than 20m above the surrounding plains. At 450 m above sea-level, the site lies a few kilometres west of the Syrian steppe.

#### **A.29.1 Ancient Iron Age Name**

Astamaku (Neo-Assyrian)

#### **A.29.2 Seasons of Excavation**

N. Egami (Ancient Orient Museum, Tokyo): 1980-1982, 1984, 1986, 1988, 1993-1995

#### **A.29.3 Published Iron Age Ceramics**

Egami & Masuda 1982; 1984; Egami 1983; 1988; Wada 1994; Wakita *et al.* 1995; Wakita *et al.* 2000.

## **A.30 Megiddo (Israel)**

The mound of *Tell al Mutesellim* has been associated with the biblical site of Megiddo since the end of the nineteenth century (Smith 1892, 385). The medium-sized (c. 15 ha) conical tell rises 40-60 m above the surrounding plain. The position of the mound at the point where the *Nahal 'Iron* enters the Jezreel Valley gave it strategic control over the narrow 'Iron Valley, which passes through the formidable coastal mountains (Aharoni *et al.* 1993, 1003).

### **A.30.1 Ancient Iron Age Name**

Megiddo (Hebrew, Old Testament)

### **A.30.2 Seasons of Excavation**

G. Schumacher (German Society for Oriental Research): 1903-1905

C. Fisher (Oriental Institute, University of Chicago): 1925-1927

P. L. O. Guy (OI): 1928-1934

G. Loud (OI): 1935-1939

Y. Yadin (Hebrew University, Jerusalem): 1960, 1966-1967, 1971/2.

I. Finkelstein and D. Ussishkin (Tel Aviv University): 1992, 1994, 1996, 1998, 2000, 2002, 2004, 2006

### **A.30.3 Published Iron Age Ceramics**

Guy 1938; Lamon and Shipton 1939; Loud 1948; Culican 1982; Finkelstein *et al.* 2000b; Harrison 2004b; Finkelstein 2006; Arie 2006

## **A.31 Mina, al (Turkey)**

The site of al Mina is located in the Turkish province of the Hatay on the northern bank of the Orontes River, at the point where the river empties into the Mediterranean Sea. It lies in the gulf of Suwaidia, which is protected on all sides by mountains; Mount Casius, Ras al Khanzir and the Amanus to the south, north and east, respectively. Access to the site is granted either from the sea or along the course of the Orontes River (S. Smith 1942, 88). Apart from a good defensive position, al Mina, and the Amuq Plain to the east, was located in an ideal position for linking the Mediterranean and Mesopotamian worlds. The size of the tell itself is difficult to determine because a large portion of the site has been lost to erosion or obscured by thick alluvial deposits.

### **A.31.1 Ancient Iron Age Name**

Al Mina was originally identified with the Poseideion of classical literature, but subsequent excavation of nearby Ras al Bassit, which was the other option for Poseideion (S. Smith 1942, 96-98), has also shown strong connections with the Greek world whilst also, significantly, retaining an echo of the classical name. As a result, al Mina has been left 'nameless' (Boardman 1990, 170).

### **A.31.2 Seasons of Excavation**

C. L. Woolley (British Museum): 1935-1936

### **A.31.3 Published Iron Age Ceramics**

Woolley 1937; 1938a; Robertson 1940; Boardman 1959; Du Plat Taylor 1959; Peltenberg 1969; Luke 2003

## **A.32 Mishrifeh, Tell (Syria)**

Situated within the *mohafazah* (district) of Homs, Tell Mishrifeh lies approximately 18 km north east of the modern city of Homs. It is located in a large fertile plain between the desert steppe and the alluvial Orontes Valley, an area crossed by a seasonal net of *wadis*. The site consists of a large, gently sloping tell, which is enclosed by massive Bronze Age ramparts. The fortifications, which still stand to heights of 15-20 m, protect and enclose a roughly square area of c. 110 ha (al-Maqdissi *et al.* 2002a, 9).

### **A.32.1 Ancient Iron Age Name:**

Qatna (Amarna Letters, Late Bronze Age)

King Akizzi of Qatna wrote a number of letters to Pharaoh Akhenaton requesting help against the aggressive Hittite king Šuppiluliuma I. In addition to the Amarna letters, Hittite sources also mention the siege and conquest of Qatna. The site then fades from the textual record (Klengel 2000b).

### **A.32.2 Seasons of Excavation**

R. du Mesnil du Buisson (Musée du Louvre): 1924, 1927-1929

M. al-Maqdissi (DGAM): 1994-1998

M. al-Maqdissi, D. Morandi-Bonacossi (Udine University, Italy) and P. Pfälzner (Universität Tübingen, Germany): 1999-2006

Excavations at Tell Mishrifeh since 1999 have been carried out by a joint Syrian-Italian-German project.

### **A.32.3 Published Iron Age Ceramics**

du Mesnil du Buisson 1926; 1927a; 1927b; 1928; al-Maqdissi 2003; al-Maqdissi and Badawi 2002; Barro 2002; Luciani 2002; Morandi Bonacossi 2002;

## **A.33 Nayrab (Syria)**

Within the suburbs of modern Aleppo, c. 5 km to the south-east of the Aleppo citadel, lies the small tell of Nayrab. The low mound, which rises less than 10 m above the surrounding plain, is today completely enclosed by modern dwellings. Most of the site is lost amongst the houses, but at the time of excavation the exposed south-east corner of the tell was available for excavation (Carrière and Barrois 1927, Pl. XXXV.2).

### **A.33.1 Ancient Iron Age Name**

nrb (Aramaic, funerary stelae)

ni-ri-ib (Neo-Babylonian, Nayrab tablets)

The identification of Nayrab comes from textual evidence recovered from the site.

### **A.33.2 Seasons of Excavation**

B. Carrière, A. Barrois and A. Parrot (École Archéologique Française de Jerusalem): 1926

F. M. Abel, A. Barrois, A. Parrot and J. Darrous (École Archéologique Française de Jerusalem): 1927

### **A.33.3 Published Iron Age Ceramics**

Carrière and Barrois 1927; Abel and Barrois 1928

## **A.34 Nebi Mend, Tell (Syria)**

Tell Nebi Mend is located in west central Syria approximately 30 km south west of Homs (ancient Emessa) and only 4-5 km directly south of the Lake of Homs (also Lake Qattineh). The modern village of the same name surrounds the large mound, which lies between the Orontes River, to the east, and its tributary, the Mukadiyeh, to the west: the confluence of the two lies to the north. The large mound (10 ha.) rises

30 m above the surrounding plain, though thick alluvial deposits along the Orontes River imply an even more imposing sequence of occupation.

#### **A.34.1 Ancient Iron Age Name**

Qadeš (Old Babylonian, Bronze Age)

QDS/Kinza (Akkadian, Late Bronze Age)

Qidša (Akkadian, Amarna Letters, Late Bronze Age)

Qi-di-si (Neo-Assyrian)

Tell Nebi Mend was first identified with ancient Kadesh-on-the-Orontes in 1848 by W. M. Thompson (1848, 691-692). Subsequent geographical, textual and archaeological investigations have since confirmed the identification (Parr 1983, 99-100; 1991, 78; Conder 1881; 1882; 1883; W. Wright 1882). While no direct evidence for the Battle of Kadesh has been located, the position of the large tell between two rivers recalls the depiction of the city upon the Egyptian monuments of Ramesses II.

#### **A.34.2 Seasons of Excavation**

M. Pézard and C. L. Brossé (Musée du Louvre): 1921-1922

Director General of Antiquities and Museums, Syria: 1950

P. J. Parr (University College London): 1975-1982, 1986, 1990, 1992, 1995

#### **A.34.3 Published Iron Age Ceramics**

Pezard 1931; Sagona and Haymes 1992-1993; Whincop 2007

### **A.35 Pella (Jordan)**

The ruins at *Tabaqat Fahl* have been associated with ancient Pella since the mid-nineteenth century. Located approximately 30 km south of the Sea of Galilee, the site is positioned amid the foothills of the eastern side of the Jordan Valley (biblical Gilead) and enjoys a commanding view of the Jordan River and surrounding plains. Despite this 'elevated' position, the site only lies at *c.* sea level (McNicoll *et al.* 1982a, 12). Nevertheless, summers are much cooler here than in the valley, and winters much milder. A perennial spring also provides sufficient water for settlement, which is supplemented by winter rains sufficient for spring crops. Parts of the site, which includes a tell (*Tell el-Husn*) and small settled tableland (*tabaqah* in Arabic), have been occupied for at least eight millennia. Pella is remembered as one of the Decapolis cities of Roman Syria (R. H. Smith 1993).

### **A.35.1 Ancient Iron Age Name**

Pihilum (Semitic?, Late Bronze Age)

Peheil (Egyptian, Late Bronze Age)

The name of the site is absent from Iron Age literary sources (McNicoll *et al.* 1982a, 55). The Hellenised name, Pella, was introduced after the conquests of Alexander the Great, who was born at Pella in Macedonia, though the similarity between Pella and the Late Bronze Age name (Pihilum) has not been adequately explained (R. H. Smith 1993, 1174).

### **A.35.2 Seasons of Excavation**

R. W. Funk (USA) and H.N. Richardson (USA): 1958

Jordanian Department of Antiquities: 1964

R.H. Smith (College of Wooster, USA): 1967

R.H. Smith, A.W. McNicoll (University of Sydney, Australia) and J.B. Hennessy (University of Sydney, Australia): 1979-1985

A. W. McNicoll and J. B. Hennessy: 1986-1991

S.J. Bourke (University of Sydney, Australia): 1994-2007

### **A.35.3 Published Iron Age Ceramics**

McNicoll *et al.* 1982a; 1982b; Potts *et al.* 1985; 1988; R. H. Smith and Potts 1992; Bourke *et al.* 2003; Bourke 1997

## **A.36 Qarqur, Tell (Syria)**

Tell Qarqur is located within the northern reaches of the Gharb Valley, a fertile strip of Western Syria enclosed by the Jebel Anasariya to the west and the Idlib plateau to the east. The heavily occupied Amuq Plain lies less than 50 km (30 miles) to the north. The site itself consists of a double mound; a high southern tell rising *c.* 30 m above the plain, and an extensive (22 ha) lower city mound stretching to the north. While today Tell Qarqur lies 2 km east of the Orontes River, the course of the river in pre-Roman times would have run close to the western edge of the mound.

### **A.36.1 Ancient Iron Age Name**

Karkara (Neo-Assyrian, Shalmeneser III's inscriptions)

Qarqar (Neo-Assyrian, Sargon II's inscriptions)

Tell Qarqur has long been identified with ancient Qarqar (Pritchard 1955; Yamada 2000, 154), site of two major battles between the Neo-Assyrians and Hama-led coalitions. The Neo-Assyrian records mention a battle at the time of Shalmeneser III

(853 BCE) and later during the reign of Sargon II (720 BCE); both battles were fought against a coalition of Syrian and Palestinian states. The focus of Assyrian attack was against the northern border of the important Kingdom of Hamath, and more specifically the royal city of Qarqar (Dornemann 2003a, 4). The site of Tell Qarqur today lies at the very northern end of the Hama district, a fact that lends support to its equation with ancient Qarqar, though no epigraphic evidence has been found at the site to confirm the identification.

#### **A.36.2 Seasons of Excavation**

J M Lundquist (American Schools of Oriental Research): 1983-1984

R. H. Dornemann (ASOR): 1993-2006

#### **A.36.3 Published Iron Age Ceramics**

Dornemann 1999; 2000; 2003a

### **A.37 Qasmieh (Lebanon)**

Little has ever been published regarding the nature of the site of Qasmieh, which lies near the southern Lebanese coast immediately north of the mouth of the Litani River, *ca.* 10 km north of Tyre.

#### **A.37.1 Ancient Iron Age Name**

Bit-Gisimeia (Neo-Assyrian)

#### **A.37.2 Seasons of Excavation**

Unknown

#### **A.37.3 Published Iron Age Ceramics**

S. V. Chapman 1972

### **A.38 Qrayé (Lebanon)**

Situated in the foothills of the Lebanons, the village of Qrayé lies approximately eight km southeast of Saïda (Guigues 1939, 53). Along the western edge of the village, a Bronze and Iron Age cemetery was exposed early in the twentieth century. Little else has been published regarding the nature of the site.

#### **A.38.1 Ancient Iron Age Name**

The ancient name of Qraye is currently not known.



### **A.38.2 Seasons of Excavation**

G. Contenau (Musée du Louvre): 1914

P.E. Guigues (Service des Antiquités): 1924

### **A.38.3 Published Iron Age Ceramics**

S. V. Chapman 1972

## **A.39 Rachidieh, Tell (Lebanon)**

The site of Tell Rachidieh (also *Tell Habish*) lies approximately 5 km south of Tyre (Dunand 1940, 123); close enough to originally be considered part of Tyre. The tell is found on the fertile Plain of Tyre within 1 km of the Ras al-Ayn spring, one of the main sources of fresh water along the coastal plain. The proximity to water, arable land and timber lends the site a favourable position, one that the prosperous island of Tyre possibly lamented (Doumet-Serhal 2004a).

### **A.39.1 Ancient Iron Age Name**

Uzu (Papyrus Anastasi, New Kingdom)

Amarna Letters, Late Bronze Age)

‘ITW (Akkadian)

Usu/Ushu (Neo-Assyrian)

Dur Bel-Harransadua (Neo-Assyrian)

Hosa (Hebrew, Old Testament)

### **A.39.2 Seasons of Excavation**

T. Macridi-Bey (Imperial Museum, Constantinople): 1901, 1903 (7 Iron Age tombs)

D. Le Lasseur (Service des Antiquités): 1921

M. Chéhab (Service des Antiquités): 1942-1943

B. Kaoukabani (Service des Antiquités) and H. Chéhab: 1974

### **A.39.3 Published Iron Age Ceramics**

Macridi-Bey 1904a; Culican 1982; Doumet 1982; Doumet and Kawkabani 1995; Bordreuil 2003; 2004; Doumet-Serhal 2003; 2004b; Griffiths 2003

## **A.40 Ras al Bassit (Syria)**

Ras al-Bassit lies on the Syrian coast between Lattakia (55 km to the south) and the mouth of the Orontes River (25 km to the north). The tell lies on a natural terrace overlooking the cove formed by a natural headland jutting out from the coast. An ancient necropolis is situated c. 75 m to the south west, between the tell and a large

classical acropolis. The shore line has changed over the centuries, and the buildings on the tell were once situated directly on the cove, though today the tell lies 100 m from the water (Courbin 1993a, Fig. 1). The tell itself is of a low height (the highest point is 6.40 m above sea-level) and modest size (< 1 ha.), though the late Iron Age settlement was apparently not restricted to the tell (Courbin 1986, 182).

#### **A.40.1 Ancient Iron Age Name**

R'S(Y) (Ugaritic, Late Bronze Age)

SNR(Y) (Ugaritic, Late Bronze Age)

Sinuru (Late Bronze Age)

Posideion (Greek, Herodotus)

Ras al-Bassit has strong connections with the Greek world and, significantly, retains an etymological echo of the classical Posideion (Boardman 1990, 170).

#### **A.40.2 Seasons of Excavation**

P. Courbin (École Pratique des hautes Études, Paris): 1971-1986, 1990, 1992

#### **A.40.3 Published Iron Age Ceramics**

Courbin 1973; 1974-1975; 1978; 1983; 1986; 1990a; 1990b; 1993a; Braemer 1986

### **A.41 Ras Ibn Hani (Syria)**

The site of Ras Ibn Hani is situated on the north Syrian coast c. 9 km north of Lattakia (Bounni *et al.* 1976, 233, 265). Sited on a 2.5 km long limestone promontory, the widely spread settlement (c. 15 ha) was protected on three sides by the sea, leaving only its eastern extent to be protected by fortifications (Bounni *et al.* 1978, Fig. 1). The natural topography provided unimpeded access to the Mediterranean, which encouraged participation in maritime trade whilst maintaining visible communication with Ugarit 4.5 km to the north-east (Bounni *et al.* 1998, 7-8). The moderate height (9 m) of the tell is indicative of limited occupation.

#### **A.41.1 Ancient Name**

B'IR/Biruti (Ugaritic, Late Bronze Age)

PU/Bi-i-ri (Akkadian, Late Bronze Age)

Since the discovery of a Late Bronze Age archive at Ras Ibn Hani, a number of proposals have been advanced regarding the identification of the ancient site; Biruti being the most popular candidate (Bounni *et al.* 1998, 92-93).

### **A.41.2 Seasons of Excavation**

K. Toueir: 1974

A. Bounni (DGAM, Syria) and J. Lagarce (Centre National De La Recherche Scientifique): 1975-1984, 1986-1995

### **A.41.3 Published Iron Age Ceramics**

Badre 1983; Lagarce 1983; Bounni *et al.* 1976; 1978; 1979; 1981; 1998

## **Rehov, Tel (Israel) - see A.13 Beth Shan**

### **A.42 Rifa'at, Tell (Syria)**

Tell Rifa'at occupies a commanding position between the Qoueiq River and the Jebel Sam'an, 35 km north of Aleppo. The rich red soil and relatively high water table of the undulating limestone country means the region is extremely fertile (Seton-Williams 1961, 69-70). The imposing tell, one of the largest in the area (c. 5 ha), rises 36 m above the surrounding plain. The mound itself, with its heavily eroded edges and steep slopes, is completely surrounded by the town of the same name, which since the 1870s occupies an area roughly equivalent to the lower settlement of the Iron Age (Seton-Williams 1967, Pl. V). Extensive quarrying of the site by local villagers, combined with heavy winter rains, has led to extensive damage of the tell.

#### **A.42.1 Ancient Iron Age Name**

Arpad (Aramaic, Old Testament)

Arpadda (Neo-Assyrian)

The identification of Tell Rifa'at with the ancient city of Arpad, capital of the Aramaean kingdom of Bit-Agusi, was proposed on etymological and geographical grounds prior to excavation (Kraeling 1918, 65). According to textual sources, the city and district of Arpad were seized by Aramaeans under their leader, Agusi, sometime in the first half of the 9<sup>th</sup> century BCE. From that point on Arpad appears to have played a significant role in the shifting politics of a region in dangerous proximity to the re-invigorated Assyrians.

#### **A.42.2 Seasons of Excavation**

B. Hrozny (University of Prague): 1924-1925

M. V. Seton-Williams (Institute of Archaeology, University of London): 1956, 1960, 1964

### **A.42.3 Published Iron Age Ceramics**

Seton-Williams 1961; 1967; Matthers 1981b; Lehmann 1996

## **A.43 Sarepta (Lebanon)**

Located on the southern coast of Lebanon, Sarepta lies 22 km north of Tyre and 13 km south of Sidon. The site conforms to the classic pattern of settlement within Iron Age Lebanon, utilising either an island or promontory that gives access to at least two natural harbours. The modern village of Sarafand, approximately 2 km to the south, still makes use of the dual harbours. The low Iron Age tell (*Ras el-Qantara*) rises abruptly from the shore and extends in a gradual incline to the south and east, reaching a modest height of 15 m (Pritchard 1978, 71).

### **A.43.1 Ancient Iron Age Name**

DRPT (Akkadian, Late Bronze Age)

Zarpat/Zarephath (Hebrew, Old Testament)

Sa-ri-ip-tu/Za-ri-ib-tu (Neo-Assyrian)

Sarepta (Greek)

The site of Sarafand has long been identified with ancient Sarepta, primarily based on etymological similarity (Pritchard 1975, 7-9). The 1969 discovery at Sarafand of a Greek inscription dedicated to “the holy god of Sarepta,” supports this identification (Pritchard 1978, Fig. 16). When in 1971 an inscribed scarab was discovered with the four letters *s r p t* (Sarepta) the identification appears confirmed (Anderson 1988, 36). While literary sources depict Sarepta as a major city of the first millennium BCE, it is always coupled with Sidon and appears to have been one of many satellite fortresses within the Sidonian kingdom. The city also held significant fame within the early Christian period; remembered for the two miracles performed there by the biblical prophet Elijah (see 1 Kings 17:7 *ff* and Luke 4:24-26).

### **A.43.2 Seasons of Excavation**

H. Ingolt, E. Fugmann (American University of Beirut): 1932

R. Saidah (Service des Antiquités): 1962, 1964, 1968

J. B. Pritchard (University of Pennsylvania): 1969-1974

### **A.43.3 Published Iron Age Ceramics**

Culican 1970; Pritchard 1975; 1978; 1988; Koehl 1985; Anderson 1988; 1990; Khalifeh 1988; Bettles 2003

## **A.44 Sheikh Hassan, Tell (Syria)**

Tell Sheikh Hassan is situated in North Syria within the elbow of the Euphrates River, about half-way between Tawi and Mumbaqaat. Originally situated on the left bank of the Euphrates River, the tell is now an island within Lake Assad as a result of the Tabqa Dam inundation (Anastasio *et al.* 2004, 300). The tell originally rose 14 m above the Euphrates River and possessed a diameter of over 250 m (c. 5 ha.), but today is a small (c. 0.5 ha.) island situated 500 m from land.

### **A.44.1 Ancient Iron Age Name**

The ancient name of the site is currently not known.

### **A.44.2 Seasons of Excavation**

A. Bounni (DGAM): 1972-1974

J. Cauvin (French): 1976

W. Orthmann (German): 1981

J. Boese (Franco-German Project): 1984-1990, 1992-1994

### **A.44.3 Published Iron Age Ceramics**

Boese 1995; Schneider 1999a; 1999b

## **A.45 Shiyukh Fawqani, Tell (Syria)**

One of a few Iron Age sites excavated as part of Euphrates dam salvage projects, Tell Shiyukh Fawqani is located on the left bank of the Euphrates equidistant between Jerablus, a few kilometres to the north, and Tell Shiyukh Tahtani, to the south (Bachelot and Fales 2005). While the lower town is not extensive (c. 4 ha.), the upper acropolis is particularly small (c. 1.3 ha.). From its position on the river terrace, the tell rises 25 m above the surrounding village, and 30 m above the alluvial plain (Luciani 2005, 719).

### **A.45.1 Ancient Iron Age Name**

Bur-mar'ina (Neo-Assyrian)

<sup>Ur</sup> Marina sa sade (Middle Assyrian)

A text excavated from the mound of Tell Shiyukh Fawqani mentions the city of Burmarina (Fales *et al.* 2005; Fales 1999), which is also mentioned in the Assyrian annals as a city conquered by Shalmeneser III. Bur-mar'ana is mentioned as belonging to Ahuni, man of Adini (Pritchard 1955, 277; Morandi Bonacossi 2000c).

### **A.45.2 Seasons of Excavation**

L. Bachelot (Centre National de la Recherche Scientifique) and M. Fales (University of Udine, Italy): 1994-1998, 2003

### **A.45.3 Published Iron Age Ceramics**

Bachelot 1999; Luciani 2000; 2005; al-Bahloul *et al.* 2005; Makinson 2005

## **A.46 Sidon (Lebanon)**

The ancient site of Sidon is identified with the modern city of Saïda located on the southern Lebanese coast 20 km south of Beirut. The ancient city occupied two distinct areas; the oldest town ('little Sidon') was built on a promontory between two bays, while 'Greater Sidon' was situated slightly inland from the coast (Doumet-Serhal 2004d, 102). It is impossible to determine the size and height of the tell, as the modern city of Saïda covers and obscures the ancient settlement.

### **A.46.1 Ancient Iron Age Name**

Sidon (Hebrew, Old Testament)

DDN/Sidna (Akkadian)

Siduna (Amarna letters)

Sidunu (Neo-Assyrian)

SDN (Phoenician)

Ancient documents (e.g. Homer, Hebrew Bible) depict Sidon as the most important and ancient of the Levantine coastal cities, a portrait yet to be fully explored through archaeological means.

### **A.46.2 Seasons of Excavation**

O. Hamdy Bey (Musée Impérial Ottoman): 1887

T. Macridi-Bey (Musée Impérial Ottoman): 1900-1904, 1909

C. C. Torrey: 1902

P. Perdrizet (French): 1903

G. Contenau (Musée du Louvre): 1914, 1920

C. L. Brossé (Service des Antiquités): 1923

M. Dunand (Service des Antiquités): 1924

B. E. Guigues (Service des Antiquités): 1925

M. Meurdrac and L. Albanèse (Service des Antiquités): 1929

A. Poidebard (Service des Antiquités): 1946-1950

H. Frost: 1963-1964

M. Dunand (Service des Antiquités): 1964-1965, 1967-1968

C. Ghadban: 1960s

R. Saidah (Service des Antiquités): 1967-1972

C. Doumet-Serhal (British Museum): 1998, 2000-2006

#### **A.46.3 Published Iron Age Ceramics**

Contenau 1920; Culican 1975; Riis and Buhl 1990; Doumet-Serhal 2000; 2004d; 2004g; 2006

### **A.47 Sukas, Tell (Syria)**

Tell Sukas is a site on the north Syrian coast bordering the Gabala plain, 26 km south of Lattakia. This highly fertile plain, c. 40 km in length, is surrounded by mountains to the north, east and south (Riis 1970, 7). The relatively small (c. 2 ha) mound rises 20 m above the natural promontory upon which it resides. The site is flanked by two small bays, to the north and south (Riis 1970, Fig. 3).

#### **A.47.1 Ancient Name**

Su-uk-su/Suksi (Ugaritic – Late Bronze Age)

No find from Tell Sukas has confirmed the name of the settlement, though Sukas corresponds well with Suksu, the name of a town at the southern frontier of the kingdom of Ugarit, a position that accords well with the location of Tell Sukas.

#### **A.47.2 Seasons of Excavation**

E. O. Forrer (Bryn Mawr College): 1934

P. J. Riis (Carlsberg Expedition to Phoenicia, Danish): 1958-1961, 1963

#### **A.47.3 Published Iron Age Ceramics**

Riis 1960; 1970; 1979; Ploug 1973; Buhl 1983; 1996; Lund 1986; Jensen 1996.

### **A.48 Tambourit (Lebanon)**

The village of Tambourit lies on the Lebanese coast c. 6 km south east of Sidon.

#### **A.48.1 Ancient Iron Age Name**

The ancient name of Tambourit has not yet been determined.

#### **A.48.2 Seasons of Excavation**

R. Saidah (Service des Antiquités): 1971

#### **A.48.3 Published Iron Age Ceramics**

Saidah 1977

## **Ta'yinat, Tell (Turkey) - see A.8 Amuq**

### **A.49 Tille Höyük (Turkey)**

Situated in the Upper Euphrates Valley of south-eastern Turkey, Tille Höyük lies 60 km east of Adiyaman and 130 km north of the Syrian-Turkish border. The site consists of a small mound (c. 0.25 ha.) surrounded by an extensive (c. 12 ha.) lower town (Anastasio *et al.* 2004, 326). While the site once stood on the right bank of the Euphrates River, since 1990 it has lain beneath the waters of the Ataturk Dam.

#### **A.49.1 Ancient Iron Age Name**

The ancient name of the site is currently not known.

#### **A.49.2 Seasons of Excavation**

D. French (British Institute of Archaeology, Ankara): 1979-1990

#### **A.49.3 Published Iron Age Ceramics**

Summers 1993; Blaylock 1999.

### **A.50 Tyre (Lebanon)**

The plain of Tyre stretches 25 km south from the Litani River. The ancient site of Tyre was situated on an island opposite the plain. When Alexander laid siege to the city, he built a causeway joining the island to the mainland, thus creating today's peninsula. Tyre lies 94 km south of Beirut, midway between Sidon and Akko. At this point the coastal plain reaches its maximum width of 2 km. The ancient city of Tyre is today covered by the modern city of Sour, leaving much of the past settlement beyond reach.

#### **A.50.1 Ancient Iron Age Name**

Surru (Akkadian)

Sor/Zor/Tsor (Hebrew, Old Testament)

Tor/Tur (Aramaic)

SR (Phoenician)

Tyros (Greek)

#### **A.50.2 Seasons of Excavation**

J. de Bertou (Swiss): 1837 (search for limits of northern harbour)

E. Renan (French): 1860 (excavations in northern harbour)



J. Nepomuk Sepp (German): 1874 (search for Emperor Barbarossa's tomb)  
D. Le Lasseur (Service des Antiquités): 1921-1923  
L. Albanese (Service des Antiquités): 1923-1928  
A. Poidebard (Service des Antiquités): 1934-1936 (excavation & underwater survey)  
M. Dunand (Service des Antiquités): 1937 (salvage of Roman tomb with frescoes)  
M. Chéhab (Lebanese Department of Antiquities): 1946, 1950-1951, 1961-1974  
M. Simson: 1947-1948  
A. Bounni (DGAM): 1957-1959  
R. Saidah (Service des Antiquités): 1960 (Roman tombs)  
H. Frost: 1963, 1966  
C. Asmar (Lebanese Department of Antiquities): 1966-1967 (Roman baths)  
P. Bikai (American University of Beirut): 1973, 1974  
M.E. Aubet (Spanish): 1997, 1999, 2002-2005 (al-Bass Iron Age cemetery)

### **A.50.3 Published Ceramics**

Patricia Bikai 1978a; 1978b; Seeden 1991; Aubet 2004a; Aubet *et al.* 1998-1999; Núñez 2004a; 2004b

## **A.51 Zincirli (Turkey)**

Zincirli is situated in the Valley of the Kara-Su of the anti-Taurus Mountains of south central Turkey. It is located immediately east of the Amanus Mountain range in Gaziantep province, approximately 10 km north of Islahiye. The site consists of a large (40 ha.) double mound, with a fortified acropolis and extensive lower town.

### **A.51.1 Ancient Iron Age Name**

Sam'al (Luwian)

Sam'al was the capital of the Neo-Hittite kingdom of Ja'dija.

### **A.51.2 Seasons of Excavation**

F. von Luschan (German Oriental Society): 1888, 1890-1891, 1894, 1902

### **A.51.3 Published Iron Age Ceramics**

Andrae 1943; Lehmann 1996

# APPENDIX B

---

## Typological Data

### B.1 LEGEND

#### Legend

- # red slip  
\* monochrome painted decoration  
\*\* bichrome painted decoration  
CWP Cypriot White Painted  
BOR Black-on-Red  
IMP Imported Vessel

### B.2 COOKING POTS

#### B.2.1 CLASS 001

##### B.2.1.1 CLASS 001a

###### Iron I

- Ras Ibn Hani Iron I Bounni *et al.* 1979, Fig. 27.1-2  
Tell Afis Area E1 level 5 Mazzoni 1998a, Fig. 20.9  
Tell Afis Area E1 level 4 Mazzoni 1998a, Fig. 20.7-8  
Tell Afis Area E1 level 3 Mazzoni 1998a, Fig. 22.7-8  
Tell Afis Area E2 level 4 Degli Esposti 1998, Fig. 9.2  
Tell Afis Area Ge level 3 Cecchini 1998, Fig. 15.10  
Tell Qarqur 9 Unpublished

###### Iron II

- Ain Dara Lower mound Iron II Stone & Zimansky 1999, Figs 70.226; 71.230  
Ain Dara Lower mound Iron II Stone & Zimansky 1999, Fig. 74.6-8  
Hazor VIII Ben Tor *et al.* 1997, Fig. III.24 (21)  
Tell Abou Danne IId/A6 Lebeau 1983, Pls 48.3-5; 49.1-7  
Tell Afis Area D level 4 Mazzoni 1988a, Fig. 19.45  
Tell Afis Area D level 3 Mazzoni 1988a, Fig. 14.16  
Tell Afis Area E1 level 2 Mazzoni 1998a, Fig. 25.10  
Tell Afis Area E2 level 2 Degli Esposti 1998, Fig. 12.18, 21-22  
Tell Afis Area E2 level 1 Degli Esposti 1998, Fig. 12.19  
Tell Afis Area Gc level 8a Cecchini 1998, Fig. 19.21  
Tell Afis Area Gn level 5 Cecchini 1998, Fig. 38.6  
Tell Arqa 10AB Thalmann 1978b, Fig. 44.3  
Tell Judeideh IV see Lehmann 1996, 450 (Form 438a)  
Tell Mastuma Central Area level I Egami & Masuda 1982, Pl. 6.6  
Tell Mastuma Central Area level I Egami 1983, Fig. 4.1  
Tell Mastuma Central Area level I Wakita *et al.* 2000, Fig. 10.8  
Tell Mastuma Central Area level I-1 Egami & Masuda 1984, Pl. 7.2  
Tell Mastuma Central Area level I-2 Egami 1988, Pl. 18.5  
Tell Mastuma South Area Wada 1994, Fig. 2.6, 8  
Tell Mishrife Iron II Unpublished

Tell Qarqur 8 Dornemann 2003a, Fig. 83.18-19  
Tell Qarqur 8 Unpublished  
Tell Rifa'at 2b-c see Lehmann 1996, 450 (Form 438a)  
Tell Sheikh Hassan 3 Schneider 1999a, Fig. 9.15(1)  
Tell Tayinat Iron II Unpublished  
Tyre II-III Bikai 1978b, Pl. 12.33

#### **Iron II-III**

Tell Afis Area A (Afis VIII/IX) Soldi 2005, Fig. 20.9-10  
Tell Shiyuk Fawqani Area F (IX) Makinson 2005, Pl. 11.66-67  
Tell Shiyuk Fawqani Area F (IX) Makinson 2005, Pl. 12.70-71  
Tell Shiyuk Fawqani Area F (IX) Makinson 2005, Pl. 13.76-79

#### **Iron III**

Tell Abou Danne IIC/A5 Lebeau 1983, Pl. 119.1-2  
Tell Afis Area D level 2 Mazzoni 1988a, Fig. 12.1-4, 6  
Tell Afis Area D level 1 Mazzoni 1988a, Fig. 8.15-16  
Tell Afis Area Gc level 6 Cecchini 1998, Fig. 28.23-24, 27  
Tell Afis Area Gc level 5 Cecchini 1998, Fig. 30.16  
Tell Afis Area Gc level 5 Cecchini 1998, Fig. 30.17  
Tell Afis Area Gc level 4 Cecchini 1998, Fig. 32.18-20  
Tell Afis Area Gc level 3 Cecchini 1998, Fig. 34.5-6  
Tell Afis Area Gc level 2 Cecchini 1998, Fig. 36.15-18  
Tell Afis Area Gn level 2 Cecchini 1998, Fig. 39.22-23  
Tell Ahmar Area C level 2 Jamieson 1999, Fig. 5.1, 3  
Tell Ahmar Area C level 2 Jamieson 1999, Fig. 10  
Tell Ahmar Area D Iron III Jamieson 2005, Fig. 42.1-3  
Tell Jurn Kabir Findgroup C Eidem and Ackermann 1999, Fig. 9a.19  
Tell Rifa'at 2a see Lehmann 1996, 450 (Form 438a)  
Tell Shiyuk Fawqani Area G level 2 Luciani 2005, Pl. 4.37  
Tell Shiyuk Fawqani Area G level 2 Luciani 2005, Pl. 20.238-243

#### **Persian**

Tell Abou Danne IIB/A4 see Lehmann 1996, 450 (Form 438a-b)  
Tell Shiyuk Fawqani Area F (X) Makinson 2005, Pl. 34.225  
Tell Shiyuk Fawqani Area G level 1 Luciani 2005, Pl. 51.598  
Tell Sukas G2 Buhl 1983, Fig. IX.97

#### **Unclear Context**

Al Mina Unstrat. Lehmann 1996, Pl. 83 (438a/3)  
Chatal Höyük Unstrat. see Lehmann 1996, 450 (Form 438b)  
Tell Judeideh Unstrat. see Lehmann 1996, 450 (Form 438a); 453 (Form 449)  
Tell Rifa'at Iron Age see Lehmann 1996, 450 (Form 438b)  
Tell Rifa'at Unstrat. see Lehmann 1996, 450 (Form 438a)  
Tell Rifa'at Unstrat. Lehmann 1996, Pl. 83 (438a/1)

### **B.2.1.2 CLASS 001b**

#### **Iron I**

Tell Qarqur 9 Unpublished

#### **Iron II**

Tell Abou Danne IID/A6 Lebeau 1983, Pl. 50.1-4  
Tell Afis Area B (Afis VIII) Scigliuzzo 2002, Fig. 12.9  
Tell Afis Area B (Afis VIII) Scigliuzzo 2005, Fig. 37.1  
Tell Afis Area D level 6 Mazzoni 1988a, Fig. 22.17  
Tell Afis Area D level 4 Mazzoni 1988a, Fig. 19.3, 6  
Tell Afis Area D level 3 Mazzoni 1988a, Fig. 14.13, 15  
Tell Afis Area E1 level 2 Mazzoni 1998a, Fig. 25.91  
Tell Afis Area E1 level 2 Mazzoni 2000b, Fig. 6.12-15  
Tell Judeideh IV see Lehmann 1996, 451 (Form 440)  
Tell Jurn Kabir Findgroup B Eidem and Ackermann 1999, Fig. 7.17  
Tell Mastuma Central Area level I Wakita *et al.* 2000, Fig. 10.5, 7  
Tell Mastuma Central Area level I-2 Egami & Masuda 1984, Pl. 7.1, 3-4  
Tell Qarqur 8 Unpublished

**Iron II-III**

Tell Afis Area A (Afis VIII/IX) Soldi 2005, Fig. 20.11  
Tell Shiyuk Fawqani Area F (IX) Makinson 2005, Pl. 12.69, 72  
Tell Shiyuk Fawqani Area F (IX) Makinson 2005, Pl. 13.74-75

**Iron III**

Tell Afis Area B (Afis IX) Mazzoni 2000b, Fig. 3.14, 16  
Tell Afis Area D level 1 Mazzoni 1988a, Fig. 8.11-12, 14  
Tell Afis Area D level 2 Mazzoni 1988a, Fig. 12.5, 8  
Tell Afis Area Gc level 4 Cecchini 1998, Fig. 32.21  
Tell Afis Area Gc level 6 Cecchini 1998, Fig. 28.26  
Tell Afis Area Gc level 7b Cecchini 1998, Fig. 25.15-22  
Tell Afis Area Gn level 2 Cecchini 1998, Fig. 39.21  
Tell Afis Area Gn level 3 Cecchini 1998, Fig. 39.11-12  
Tell Afis Area Gn level 4 Cecchini 1998, Fig. 38.14  
Tell Afis Area J (Afis IX) Oggiano 2002, Fig. 26.5  
Tell Ahmar Area C level 2 Jamieson 2000, Fig. 11.3, 9  
Tell Ahmar Area D Iron III Jamieson 2005, Fig. 42.4-6  
Tell Arqa 9 Unpublished  
Tell Jurn Kabir Findgroup C Eidem and Ackermann 1999, Fig. 9a.20  
Tell Shiyuk Fawqani Area G level 2 Luciani 2005, Pl. 21.244

**Persian**

Tell Shiyuk Fawqani Area F (X) Makinson 2005, Pl. 34.224  
Tell Shiyuk Fawqani Area G level 1 Luciani 2005, Pl. 51.599-600

**Unclear Context**

Tell Rifa'at Unstrat. Lehmann 1996, Pl. 83 (438a/2)

**B.2.1.3 CLASS 001c****Iron II**

Tell Afis Area B (Afis VIII) Scigliuzzo 2002, Fig. 13.9  
Tell Afis Area B (Afis VIII) Virgilio 2005, Fig. 34.10  
Tell Afis Area D level 3 Mazzoni 1988a, Fig. 14.12  
Tell Afis Area D level 4 Mazzoni 1988a, Fig. 19.1-2, 7-8  
Tell Afis Area D level 5 Mazzoni 1988a, Fig. 20.17  
Tell Afis Area D level 6 Mazzoni 1988a, Fig. 22.15-16, 18  
Tell Afis Area L level 3 D'Amore 1998a, Fig. 6.14  
Tell Afis Area L level 6a D'Amore 1998a, Fig. 6.25  
Tell Mishrife Iron II Unpublished  
Tell Qarqur 8 Dornemann 2003a, Fig. 83.22, 24  
Tell Shiyuk Fawqani Area F (IX) Makinson 2005, Pl. 13.81

**Iron III**

Tell Afis Area B (Afis IX) Scigliuzzo 2002, Fig. 13.9  
Tell Afis Area D level 2 Mazzoni 1988a, Fig. 12.9, 12-13  
Tell Afis Area Gc level 2 Cecchini 1998, Fig. 36.21  
Tell Afis Area Gc level 4 Cecchini 1998, Fig. 32.22  
Tell Afis Area Gn level 2 Cecchini 1998, Fig. 39.24  
Tell Afis Area Gn level 3 Cecchini 1998, Fig. 39.13  
Tell Afis Area Gn level 4 Cecchini 1998, Fig. 38.15  
Tell Ahmar Area C level 2 Jamieson 1999, Fig. 5.2, 4  
Tell Arqa 9 Unpublished  
Tell Shiyuk Fawqani Area G level 2 Luciani 2005, Pl. 26.296

**Persian**

Tell Afis Area Gc level 1 Cecchini 1998, Fig. 37.4-5  
Tell Keisan 3 Briend & Humbert 1980, Pl. 21.6-7  
Tell Shiyuk Fawqani Area G level 1 Luciani 2005, Pl. 52.601  
Tell Sukas F Buhl 1983, Fig. IX.90  
Tell Sukas G Buhl 1983, Fig. IX.90

**Unclear Context**

Jerablus Yunus cem. Woolley 1939b, Pl. 15.a.4  
Tell Judeideh Unstrat. see Lehmann 1996, 450 (Form 439a)

#### **B.2.1.4 CLASS 001d**

##### **Iron II**

- Tell Afis Area D level 4 Mazzoni 1988a, Fig. 17.11, 13  
Tell Afis Area D level 6 Mazzoni 1988a, Fig. 22.19-20  
Tell Mastuma Central Area level I Wakita *et al.* 2000, Fig. 10.10  
Tell Mastuma Central Area level I-2 Egami 1988, Pl. 18.2

##### **Iron III**

- Tell Afis Area D level 1 Mazzoni 1988a, Fig. 8.13  
Tell Afis Area D level 2 Mazzoni 1988a, Fig. 12.7, 10  
Tell Afis Area Gc level 3 Cecchini 1998, Fig. 34.3

#### **B.2.2 CLASS 002**

##### **Iron I**

- Tyre XIII Bikai 1978b, Pl. 35.3

##### **Iron II**

- Hazor IV Yadin *et al.* 1958, Pl. 58.10  
Tel Beth Shan IV James 1966, Fig. 34.10  
Tel Beth Shan IV James 1966, Fig. 69.14  
Tel Dan IV Biran 1989b, Fig. 26.11  
Tell Abou Danne IId/A6 Lebeau 1983, Pl. 51.1  
Tell Mastuma Central Area level I Wakita *et al.* 2000, Fig. 10.6  
Tell Mastuma South Area Wada 1994, Fig. 2.7  
Tell Sheikh Hassan 3 Schneider 1999a, Fig. 9.15(2-3)  
Tille Höyük VIII Blaylock 1999, Fig. 7.4

##### **Iron III**

- Tell Ahmar Area C level 2 Jamieson 2000, Fig. 5.10  
Tell Keisan 4 Briend & Humbert 1980, Pl. 34.3  
Tell Keisan 5 Briend & Humbert 1980, Pl. 46.6

##### **Persian**

- Al Mina IV Woolley 1938b, Fig. 27.21

##### **Unclear Context**

- Nayrab Unstrat.(infant burial) Carriere & Barrois 1927, Fig. 1.A

#### **B.2.3 CLASS 003**

##### **Iron I**

- Tell Afis Area E1 level 8 Venturi 1998a, Fig. 8.2  
Tell Afis Area G (Iron IC) Canuti 2000, Fig. 17.16  
Tell Jurn Kabir Findgroup A Eidem and Ackermann 1999, Fig. 5.22

##### **Iron II**

- Tel Beth Shan IV James 1966, Fig. 69.12  
Tell Afis Area Gc level 8a Cecchini 1998, Fig. 19.20  
Tell el Ghassil Area III level 3 Joukowsky 1972, Pl. 24.12  
Tyre V Bikai 1978b, Pl. 18.13

##### **Iron III**

- Megiddo II/III Lamon & Shipton 1939, Fig. 39.9  
Tell Keisan 4 Briend & Humbert 1980, Pl. 34.5, 7-9

##### **Persian**

- Megiddo I Lamon & Shipton 1939, Fig. 39.9

## **B.2.4 CLASS 004**

### **B.2.4.1 CLASS 004a**

#### **Iron II**

Hazor VIII Yadin *et al.* 1960, Pl. 59.1-2  
Joya S.V. Chapman 1972, Fig. 22.217  
Tel Beth Shan IV James 1966, Fig. 69.4  
Tell Arqa 10 Unpublished  
Tell Arqa 10AB Chaaya 2000, Fig. 2.8  
Tell Arqa Tomb 1 Thalmann 1978b, Fig. 45.16  
Tell el Ghassil Area III level 4 Joukowsky 1972, Pl. 26.12  
Tell Kazel Area I level 9 Gubel 1990a, Fig. 30.d  
Tyre IV Bikai 1978b, Pl. 17.3-4

#### **Iron II-III**

Tel Dan I Pakman 1992, Fig. 4.4

#### **Iron III**

Tell Arqa 9 Thalmann 1978b, Fig. 44.6

#### **Persian**

Tell Sukas G2 Buhl 1983, Fig. VIII.83

#### **Unclear**

Byblos Unstrat. Homsy 2003, Pl. 12

### **B.2.4.2 CLASS 004b**

#### **Iron I**

Hazor IX/X Unpublished  
Kamid el-Lawz Iron I Marfoe 1995, Fig. 104.7  
Megiddo VB Lamon & Shipton 1939, Fig. 40.17, 21  
Sarepta Area X level V Khalifeh 1988, Type CP14  
Tel Dan VI Biran 1989a, Fig. 4.16.4  
Tell Abu Hawam V/IV Hamilton 1934, Pl. 22.17  
Tell Afis Area E1 level 8 Venturi 1998a, Figs 8.5; 9.5, 13.8, 10  
Tell Afis Area E1 level 9a Venturi 1998a, Fig. 8.4  
Tell Afis Area E1 level 9a Venturi 2000a, Fig. 10.1, 4, 8  
Tell Afis Area E2 level 4 Degli Esposti 1998, Fig. 9.4  
Tell el Ghassil Area III level 5 Baramki 1966, Fig. 7.4  
Tell el Ghassil Area III level 5 Joukowsky 1972, Pl. 28.6  
Tell Mishrife Iron I Unpublished  
Tell Qarqur 9 Unpublished

#### **Iron I-II**

Megiddo Tombs Guy 1938, Pl. 75.11  
Tell el Ghassil Area I level 4 Baramki 1961, Fig. 6.2; Pl. 8.4  
Tell el Ghassil Area I level 4 Joukowsky 1972, Pl. 8.31-32  
Tell el Ghassil Area III level 4 Baramki 1966, Fig. 4.2  
Tell el Ghassil Area III level 4 Joukowsky 1972, Pl. 26.6, 9  
Tyre X Bikai 1978b, Pl. 23.13-15  
Tyre X Bikai 1978b, Pl. 27.7

#### **Iron II**

Hazor IV Yadin *et al.* 1958, Pl. 70.8  
Hazor IV Yadin *et al.* 1960, Pl. 99.16  
Hazor V Yadin *et al.* 1958, Pl. 55.1  
Hazor V Yadin *et al.* 1960, Pl. 85.13  
Hazor V Yadin *et al.* 1961, Pl. 189.9  
Hazor V Yadin *et al.* 1961, Pl. 227.13  
Hazor V Yadin *et al.* 1961, Pl. 252.10  
Hazor VI Yadin *et al.* 1960, Pl. 69.5  
Hazor VI Yadin *et al.* 1961, Pl. 184.5  
Hazor VI Ben Tor *et al.* 1997, Fig. II.58 (27)

Hazor VIII Yadin *et al.* 1960, Pl. 57.24  
 Hazor VIII Ben Tor *et al.* 1997, Fig. III.27 (15)  
 Megiddo Area H level 3 (IVA) Finkelstein *et al.* 2000b, Fig. 11.53(12)  
 Tel Beth Shan IV James 1966, Fig. 38.9  
 Tel Dan III Biran 1999, Fig. 4.6  
 Tell Arqa 10 Unpublished  
 Tell el Ghassil Area I level 1 Baramki 1964, Fig. 18.3  
 Tell el Ghassil Area I level 1 Baramki 1964, Fig. 20.1  
 Tell el Ghassil Area I level 2 Baramki 1964, Fig. 5.2  
 Tell el Ghassil Area I level 2 Baramki 1964, Fig. 33.1  
 Tell el Ghassil Area I level 2 Baramki 1964, Fig. 35.2  
 Tell el Ghassil Area I level 2 Baramki 1964, Fig. 36.1  
 Tell el Ghassil Area I level 2 Baramki 1964, Fig. 41.2  
 Tell el Ghassil Area I level 2 Joukowsky 1972, Pl. 2.16, 18  
 Tell el Ghassil Area III level 2 Joukowsky 1972, Pl. 17.70-72  
 Tell Kazel Area I level 9 Gubel 1990a, Fig. 30.b  
 Tell Kazel Area II level 4 Badre *et al.* 1994, Fig. 28.h  
 Tell Nebi Mend Trench V Level B Unpublished  
 Tell Nebi Mend Trench V Level C Unpublished  
 Tyre II Bikai 1978b, Pl. 12.26-28  
 Tyre III Bikai 1978b, Pl. 12.31

#### **Iron II-III**

Akhziv South Cem XXI Dayagi-Mendels 2002, 36 (11)  
 Akhziv East Cem XXIX Culican 1975-1976, Fig. A.y  
 Sarepta Area Y level C Anderson 1988, Pl. 36.8  
 Tyre I Bikai 1978b, Pl. 1.17  
 Tyre Al-Bass cem. V Núñez 2004a, Fig. 105.1

#### **Iron III**

Megiddo II/III Lamon & Shipton 1939, Fig. 10.38  
 Tell Keisan 4 Briend & Humbert 1980, Pl. 28.4  
 Tell Keisan 4 Briend & Humbert 1980, Pl. 34.2, 6  
 Tell Keisan 5 Briend & Humbert 1980, Pl. 46.7

#### **Persian**

Athlit Tomb 24 Johns 1932, Fig. 79

#### **Unclear Context**

Athlit Cremation cem. Johns 1934, Fig. 5.13  
 Jerablus Yunus cem. Woolley 1939b, Pl. 25.M1  
 Sidon Unstrat. Saidah 1983, Pl. 53.1  
 Sarepta Area X Unstrat.. Pritchard 1988, Fig. 53.1

### **B.2.4.3 CLASS 004c**

#### **Iron I**

Kamid el-Lawz Iron I Marfoe 1995, Fig. 105.8  
 Megiddo VIA Loud 1948, Fig. 75.18  
 Megiddo VIA Loud 1948, Fig. 77.5-6  
 Megiddo VIA Harrison 2004b, Pl. 9.2, 6, 9, 14  
 Megiddo Area F level 5 (VIA) Finkelstein *et al.* 2000b, Fig. 11.2(11)  
 Pella Iron I Unpublished  
 Sarepta Area X level V Khalifeh 1988, Type CP6  
 Sarepta Area Y level G Anderson 1988, Pl. 28.9  
 Tel Beth Shan VI lower Yadin & Geva 1986, Fig. 27.9  
 Tel Dan V/VI Biran 1994, Fig. 103.6  
 Tell Afis Area E2 level 4 Degli Esposti 1998, Fig. 9.1  
 Tell Kazel Area II level 5 Badre *et al.* 1994, Fig. 33.a  
 Tell Kazel Area II level 5 Capet 2003, Figs 37.a; 40.a  
 Tell Kazel Area II level 6 Capet 2003, Fig. 21.h-j  
 Tell Kazel Area II level 6 Capet 2003, Fig. 26.b-c  
 Tell Keisan 9c Briend & Humbert 1980, Pl. 77.5

Tell Mishrife Iron I Unpublished  
 Tell Tayinat Iron I Unpublished  
 Tille Höyük Sondage level 10 Summers 1993, Fig. 45.9  
 Tille Höyük Sondage level 10 Summers 1993, Fig. 54.1  
 Tyre XIII Bikai 1978b, Pl. 37.18, 20

**Iron I-II**  
 Byblos Necropolis K Salles 1980, Pl. 26.4  
 Megiddo VA-IVB Lamon & Shipton 1939, Fig. 7.169  
 Tel Beth Shan V James 1966, Fig. 20.17  
 Tell el Ghassil Area III level 4 Baramki 1966, Fig. 3.2  
 Tell el Ghassil Area III level 4 Joukowsky 1972, Pl. 26.5, 7-8, 10-11

**Iron II**  
 Hama E Fugmann 1958, Figs 269 (5B58); 305 (5B31)  
 Hazor IV Yadin *et al.* 1961, Pl. 255.10  
 Hazor V Yadin *et al.* 1958, Pl. 55.5  
 Hazor VI Yadin *et al.* 1961, Pl. 184.11  
 Pella Iron II Unpublished  
 Sarepta Area Y level D Anderson 1988, Pl. 33.16  
 Tell el Ghassil Area I level 1 Baramki 1964, Fig. 14.1  
 Tell el Ghassil Area I level 1 Baramki 1964, Fig. 19.1  
 Tell el Ghassil Area I level 3 Joukowsky 1972, Pl. 5.14  
 Tell el Ghassil Iron II Baramki 1966, Fig. 6  
 Tell el Ghassil Area III level 2 Joukowsky 1972, Pl. 17.79  
 Tell Keisan 8 Briend & Humbert 1980, Pl. 55.6  
 Tell Nebi Mend Trench V Level B Unpublished  
 Tell Nebi Mend Trench V Level C Unpublished  
 Tille Höyük VIII Blaylock 1999, Fig. 7.1-3

**Iron II-III**  
 Akhziv East Cem XXIX Dayagi-Mendels 2002, Fig. 4.21(6)  
 Tel Dan I Pakman 1992, Fig. 4.6  
 Tell Shiyuk Fawqani Area F (IX) Makinson 2005, Pl. 13.80

**Iron III**  
 Tell Ahmar Area C level 2 Jamieson 2000, Fig. 11.7  
 Tell Shiyuk Fawqani Area G level 2 Luciani 2005, Pl. 26.302

**Persian**  
 Al Mina III Lehmann 1996, Pl. 86 (457/1+3)  
 Hazor II Yadin *et al.* 1960, Pl. 75.26

**Unclear**  
 Sarepta Area X Unstrat. Pritchard 1988, Fig. 53.4  
 Tell Nebi Mend Unstrat. Pezard 1931, Pl. 25.3.2

#### **B.2.4.4 CLASS 004d**

##### **Iron I**

Pella Area III level I McNicoll *et al.* 1992, Pl. 68.5  
 Pella Iron I Unpublished  
 Tell Afis Area E1 level 7 Venturi 2000c, Fig. 9.15  
 Tell Afis Area E1 level 9b Venturi 2000a, Fig. 6.12  
 Tell Afis Area E2 level 4 Degli Esposti 1998, Fig. 9.3  
 Tell el Ghassil Area I level 5 Joukowsky 1972, Pl. 12.30  
 Tell el Ghassil Area III level 6 Joukowsky 1972, Pl. 29.7-8, 10  
 Tell Kazel Area II level 5 Capet 2003, Fig. 38.b  
 Tyre XII Bikai 1978b, Pl. 32.14

##### **Iron I-II**

Tell el Ghassil Area III level 4 Joukowsky 1972, Pl. 26.13  
 Tell Mishrife Operation H levels 5-6 Barro 2002, Fig. 107.9  
 Tell Mishrife Iron I/II Unpublished

##### **Iron II**

Hazor VII Ben Tor *et al.* 1997, Fig. III.30 (26)



Hazor VIII Yadin *et al.* 1960, Pls 57.25; 58.1-2  
Tell el Ghassil Area III level 3 Joukowsky 1972, Pl. 24.15  
Tell Keisan 7 Briend & Humbert 1980, Pl. 52.14  
Tell Nebi Mend Trench V Level B Unpublished  
Tyre IX Bikai 1978b, Pl. 20.10

#### **Iron III**

Tell Ahmar Area D Iron III Jamieson 2005, Fig. 15.6-9

#### **Persian**

Tell Sukas G Buhl 1983, Fig. IX.94

#### **Unclear Context**

Tell Nebi Mend Unstrat. Pezard 1931, Pl. 25.2.4  
Tell Rifa'at Iron Age Seton Williams 1961, Pl. 39.13

## **B.2.5 CLASS 005**

#### **Iron I**

Hazor IX/X Yadin *et al.* 1958, Pl. 45.21  
Hazor IX/X Yadin *et al.* 1961, Pl. 210.12, 14, 16, 18  
Kamid el-Lawz Iron I Heinz *et al.* 2004, Pl. 1a-d  
Pella Area III level I McNicoll *et al.* 1992, Pl. 68.7  
Pella Iron I Unpublished  
Tell Afis Area E1 level 3 Mazzoni 1998a, Fig. 22.10  
Tell Afis Area E1 level 4 Mazzoni 1998a, Fig. 20.11  
Tell Afis Area E1 level 5 Mazzoni 1998a, Fig. 20.10  
Tell Afis Area E1 level 6 Mazzoni 1998a, Fig. 18.16-18  
Tell Afis Area E1 level 7 Venturi 2000b, Fig. 12.15  
Tell Afis Area E1 level 7 Venturi 2000c, Fig. 9.14, 16  
Tell Afis Area E1 level 8 Venturi 1998a, Fig. 8.3  
Tell Afis Area E1 level 9a Venturi 1998a, Figs 8.1; 9.1  
Tell Afis Area E1 level 9a Venturi 2000a, Fig. 8.10-11  
Tell Afis Area E1 level 9a Venturi 2000a, Fig. 10.2  
Tell Afis Area E1 level 9c Pedrazzi 2002, Fig. 23.13  
Tell Afis Area E2 level 4 Degli Esposti 1998, Fig. 9.5  
Tell Afis Area E4 (Afis VII) Chiti 2005, Fig. 49.9, 11  
Tell Afis Area Ge level 3 Cecchini 1998, Fig. 15.8  
Tell Afis Area Ge level 4 Cecchini 1998, Fig. 14.12  
Tell Jurn Kabir Findgroup A Eidem and Ackermann 1999, Fig. 5.26  
Tell Qarqur 9 Unpublished

#### **Iron I-II**

Tell el Ghassil Area I level 4 Joukowsky 1972, Pl. 8.38-39, 41  
Tell Mishrife Iron I/II Unpublished  
Tell Qarqur 8-9 Dornemann 2003a, Fig. 88.21-22  
Tyre X Bikai 1978b, Pl. 23.18

#### **Iron II**

Hazor IV Yadin *et al.* 1960, Pl. 99.17-19  
Hazor V Yadin *et al.* 1958, Pl. 73.38  
Hazor V Yadin *et al.* 1960, Pl. 94.19  
Hazor V Yadin *et al.* 1961, Pl. 189.10  
Hazor V Yadin *et al.* 1961, Pl. 252.11  
Hazor VI Yadin *et al.* 1960, Pl. 69.12, 14  
Hazor VI Ben Tor *et al.* 1997, Fig. III.35 (17)  
Hazor VII Yadin *et al.* 1960, Pl. 64.8, 11  
Hazor VII Ben Tor *et al.* 1997, Fig. III.32 (23)  
Pella Iron II Unpublished  
Tell Afis Area D level 4 Cecchini 1988, Fig. 7.8  
Tell Afis Area D level 4 Mazzoni 1988a, Fig. 19.10  
Tell Afis Area Ge level 1 Cecchini 1998, Fig. 16.17  
Tell el Ghassil Area I level 2 Baramki 1964, Fig. 33.2  
Tell el Ghassil Area I level 2 Joukowsky 1972, Pl. 2.17

Tell Keisan 7 Briend & Humbert 1980, Pl. 52.15  
 Tell Mastuma Central Area level I Wakita *et al.* 2000, Fig. 10.9  
 Tell Qarqur 8 Dornemann 2003a, Fig. 83.12  
 Tell Qarqur 8 Unpublished  
 Tell Rifa'at 2b-c see Lehmann 1996, 452 (Form 444)  
 Tyre II Bikai 1978b, Pl. 12.30  
 Tyre VIII Bikai 1978b, Pl. 20.12  
**Iron III**  
 Tell Afis Area B (Afis IX) Mazzoni 2000b, Fig. 3.13  
 Tell Afis Area Gc level 3 Cecchini 1998, Fig. 34.7-8  
 Tell Afis Area Gc level 5 Cecchini 1998, Fig. 30.18  
 Tell Afis Area Gc level 6 Cecchini 1998, Fig. 28.25  
 Tell Keisan 4 Briend & Humbert 1980, Pl. 28.6  
 Tell Keisan 4 Briend & Humbert 1980, Pl. 35.2  
 Tell Keisan 5 Briend & Humbert 1980, Pl. 46.4  
**Iron III-Persian**  
 Tell Keisan II/III Seton-Williams 1980, Pl. 109.5  
**Persian**  
 Tell Keisan I Seton-Williams 1980, Pl. 108.7  
 Tell Shiyuk Fawqani Area G level 1 Luciani 2005, Pl. 56.637-638  
**Unclear Context**  
 Athlit Cremation cem. Johns 1934, Fig. 5.12  
 Byblos Unstrat. Homsy 2003, Pl. 8e  
 Tell Afis Area N unstrat. Cecchini 2005, Fig. 63.12-13  
 Tell Nebi Mend Unstrat. Pezard 1931, Pl. 25.3.1

## B.2.6 CLASS 006

### Iron I

Hazor Iron I Ben Tor *et al.* 1997, Fig. II.36 (11)  
 Hazor IX/X Unpublished  
 Kamid el-Lawz Iron I Marfoe 1995, Fig. 103.2, 4, 6  
 Megiddo VB Lamon & Shipton 1939, Figs 5.119; 7.167  
 Megiddo VB Lamon & Shipton 1939, Fig. 20.115  
 Megiddo VIA Loud 1948, Fig. 75.17  
 Sarepta Area X level V Khalifeh 1988, Type CP10, CP11  
 Sarepta Area X level VI Khalifeh 1988, Type CP11  
 Sarepta Area Y level F Anderson 1988, Pl. 30.1  
 Sarepta Area Y level G Anderson 1988, Pl. 28.7-8  
 Tel Beth Shan V lower James 1966, Fig. 60.2  
 Tell Abu Hawam IV Hamilton 1935, 29, No. 160  
 Tyre XI Bikai 1978b, Pl. 29.9  
 Tyre XII Bikai 1978b, Pl. 32.12  
 Tyre XIII Bikai 1978b, Pls 35.2, 4-8

### Iron I-II

Megiddo VA-IVB Lamon & Shipton 1939, Figs 5.112, 119; 7.167, 170  
 Megiddo VA-IVB Loud 1948, Fig. 89.3  
 Tel Beth Shan V James 1966, Figs 2.7, 16.1; 18.11  
 Tel Beth Shan V James 1966, Figs 20.16; 21.1; 22.7  
 Tell el Ghassil Area I level 4 Baramki 1966, Fig. 4.1  
 Tyre X Bikai 1978b, Pls 23.16; 27.6, 8, 10, 12

### Iron II

Pella Area VIII level 6 McNicoll *et al.* 1992, Pl. 66.7  
 Sidon Iron II Doumet-Serhal 2006, Fig. 33.12-13  
 Sarepta Area Y level D Anderson 1988, Pl. 33.10, 15  
 Tel Beth Shan V upper James 1966, Fig. 63.19  
 Tel Jezreel Findgroup B Zimhoni 1997b, Fig. 2.9 (2)  
 Tel Rehov Area C/E level 1 A. Mazar 1999a, Fig. 24.10  
 Tell Arqa 10 Thalmann 1983, Fig. 1.5; Unpublished

Tell Arqa 10AB Thalmann 1978a, Fig. 6.5; Chaaya 2000, Fig. 2.6  
Tell Arqa Tomb 1 Thalmann 1978b, Fig. 45.1  
Tell el Ghassil Area I level 3 Joukowsky 1972, Pl. 5.9  
Tell el Ghassil Area I level 2 Baramki 1964, Fig. 25.4  
Tell Kazel Area I level 9 Gubel 1990a, Fig. 30.c  
Tell Kazel Area II level 4 Badre *et al.* 1994, Fig. 28.g  
Tell Mishrife Iron II Unpublished  
Tell Nebi Mend Trench V Level B Unpublished  
Tell Nebi Mend Trench V Level C Unpublished  
Tyre II Bikai 1978b, Pl. 12.29  
Tyre III Bikai 1978b, Pl. 12.24-25, 32  
Tyre V Bikai 1978b, Pl. 18.15

#### **Iron II-Persian**

Akhziv East Cem XII Dayagi-Mendels 2002, Fig. 4.10(12)

#### **Iron III**

Megiddo II/III Lamon & Shipton 1939, Fig. 5.112, 118-119  
Tell Arqa 9 Thalmann 1978b, Fig. 44.4  
Tell Keisan 4 Briend & Humbert 1980, Pl. 33.8

#### **Persian**

Athlit Tomb 12 Johns 1932, 65, Fig. 4g  
Athlit Tomb 21b Johns 1932, 78, Fig. 4g  
Athlit Tomb 23 Johns 1932, Fig. 71  
Beirut Bey 010 Persian Sapin & Sayegh 1998, 106(48-55)  
Tell Sukas F Buhl 1983, Fig. IX.92

#### **Unclear Context**

Athlit Cremation cem. Johns 1934, Fig. 5.11  
Nayrab Unstrat. Abel & Barrois 1928, Pl. 54f  
Sidon Unstrat. Contenau 1920, Fig. 27c  
Sarepta Area X unstrat. Pritchard 1988, Fig. 53.2  
Tell Abu Hawam III Hamilton 1935, 22, No. 80  
Tell Abu Hawam III Hamilton 1935, Pl. 13.76  
Tell Nebi Mend Unstrat. Pezard 1931, Pl. 23.4.3

## **B.2.7 CLASS 007**

### **B.2.7.1 CLASS 007a**

#### **Iron I**

Beirut Bey 003 glacis I Badre 1997b, Fig. 33.10-12  
Hama Cem. I Riis 1948, Fig. 60  
Sarepta Area Y level F Anderson 1988, Pl. 30.6  
Tell Keisan 9c Briend & Humbert 1980, Pl. 77.2  
Tell Qarqur 9 Unpublished  
Tyre XIII Bikai 1978b, Pl. 35.9

#### **Iron I-II**

Megiddo Area K level 2 (VA-IVB) Finkelstein *et al.* 2000b, Fig. 11.21(4)  
Tel Beth Shan V James 1966, Fig. 10.4, 7-8  
Tel Dan IV Biran 1982, Fig. 25.2, 7  
Tell el Ghassil Area I level 4 Joukowsky 1972, Pl. 8.40, 42  
Tyre X Bikai 1978b, Pl. 27.9, 11

#### **Iron II**

Hama E1 Riis & Buhl 1990, 129 (Form XIX)  
Hazor IV Yadin *et al.* 1958, Pl. 58.8  
Hazor IV Yadin *et al.* 1958, Pl. 70.6-7  
Hazor IV Yadin *et al.* 1958, Pl. 72.5-6  
Hazor IV Yadin *et al.* 1960, Pl. 99.15, 21-22  
Hazor IV Yadin *et al.* 1961, Pl. 255.8  
Hazor IV Ben Tor *et al.* 1997, Fig. III.50 (9-10)  
Hazor IV/V Yadin *et al.* 1958, Pl. 72.1-4

Hazor V Yadin *et al.* 1958, Pl. 55.3-4, 6-10  
 Hazor V Yadin *et al.* 1958, Pl. 67.36  
 Hazor V Yadin *et al.* 1958, Pl. 73.39  
 Hazor V Yadin *et al.* 1958, Pl. 74.22-23  
 Hazor V Yadin *et al.* 1960, Pl. 75.4  
 Hazor V Yadin *et al.* 1960, Pl. 79.20  
 Hazor V Yadin *et al.* 1960, Pl. 85.1-7, 9-11  
 Hazor V Yadin *et al.* 1961, Pl. 189.11  
 Hazor V Yadin *et al.* 1961, Pl. 190.2-3  
 Hazor V Yadin *et al.* 1961, Pl. 221.3  
 Hazor V Yadin *et al.* 1961, Pl. 224.1-4  
 Hazor V Yadin *et al.* 1961, Pl. 227.11-12, 14-19  
 Hazor V Yadin *et al.* 1961, Pl. 230.16  
 Hazor V Yadin *et al.* 1961, Pl. 231.6  
 Hazor V Yadin *et al.* 1961, Pl. 252.12  
 Hazor V Ben Tor *et al.* 1997, Fig. III.42 (15)  
 Hazor V Ben Tor *et al.* 1997, Fig. III.44 (6)  
 Hazor V Ben Tor *et al.* 1997, Fig. III.47 (10-11)  
 Hazor VI Yadin *et al.* 1958, Pl. 52.8-11  
 Hazor VI Yadin *et al.* 1960, Pl. 69.4, 6-11, 13, 15-20  
 Hazor VI Yadin *et al.* 1961, Pl. 185.6-10, 12-14  
 Hazor VI Yadin *et al.* 1961, Pl. 215.9  
 Hazor VI Yadin *et al.* 1961, Pl. 219.17-18  
 Hazor VI Yadin *et al.* 1961, Pl. 220.22-23  
 Hazor VI Ben Tor *et al.* 1997, Fig. II.54 (25-26)  
 Hazor VI Ben Tor *et al.* 1997, Fig. III.36 (12-13)  
 Hazor VI Ben Tor *et al.* 1997, Fig. III.38 (11-13)  
 Hazor VI Ben Tor *et al.* 1997, Fig. III.39 (15-17)  
 Hazor VII Yadin *et al.* 1958, Pl. 50.6-7, 9  
 Hazor VII Yadin *et al.* 1960, Pl. 64.10, 12  
 Hazor VII Yadin *et al.* 1961, Pl. 180.11-12  
 Hazor VII Yadin *et al.* 1961, Pl. 215.7  
 Hazor VII Yadin *et al.* 1961, Pl. 218.8  
 Hazor VII Yadin *et al.* 1961, Pl. 248.5-9, 11  
 Hazor VII Ben Tor *et al.* 1997, Fig. III.31 (10)  
 Hazor VII Ben Tor *et al.* 1997, Fig. III.33 (8)  
 Hazor VII Ben Tor *et al.* 1997, Fig. III.34 (18-19)  
 Hazor VIII Yadin *et al.* 1961, Pl. 248.10  
 Hazor VIII Ben Tor *et al.* 1997, Fig. III.27 (7-9)  
 Megiddo Area H level 3 (IVA) Finkelstein *et al.* 2000b, Figs 11.44(5, 7-8); 45 (1-4)  
 Megiddo Area H level 3 (IVA) Finkelstein *et al.* 2000b, Fig. 11.53(4, 10)  
 Pella Iron II Unpublished  
 Sidon Iron II Doumet-Serhal 2006, Fig. 33.10-11  
 Tel Beth Shan IV James 1966, Figs 35.2; 36.6  
 Tel Beth Shan IV James 1966, Fig. 69.16, 20  
 Tel Beth Shan Area P level 7 A. Mazar 2001, Fig. 12.4  
 Tel Dan II Pakman 1992, Fig. 1.8-10  
 Tel Dan II Biran 1999, Fig. 7.13  
 Tel Jezreel Findgroup A Zimhoni 1997a, Fig. 1.7 (11)  
 Tel Jezreel Iron II Zimhoni 1997a, Fig. 1.10 (1-2)  
 Tell el Ghassil Area I level 2 Baramki 1964, Fig. 36.3, 5  
 Tell Keisan 8 Briend & Humbert 1980, Pl. 55.8  
 Tell Nebi Mend Trench V Level B Unpublished  
**Iron II-III**  
 Akhziv South Cem I Dayagi-Mendels 2002, Figs 3.1(83); 3.2(42)  
 Akhziv East Cem XXIX Dayagi-Mendels 2002, Fig. 4.21(30)  
 Hazor III/IV Yadin *et al.* 1958, Pl. 78.16  
**Iron III**  
 Hazor III Yadin *et al.* 1958, Pl. 76.9, 19  
 Megiddo II/III Lamon & Shipton 1939, Fig. 39

Tel Dan I Pakman 1992, Fig. 4.5  
Tell Keisan 5 Briend & Humbert 1980, Pl. 46.4a

**Persian**

Megiddo I Lamon & Shipton 1939, Fig. 39

**Unclear**

Athlit Cremation cem. Johns 1938, Fig. 4.6  
Tell Afis Area N unstrat. Magazzu 2002, Fig. 32.5  
Tell Mishrife Unstrat. du Mesnil du Buisson 1930, Pl. 32.12

**B.2.7.2 CLASS 007b**

**Iron I**

Ain Dara Lower Mound Iron I Stone & Zimansky 1999, Fig. 71.315  
Hazor IX/X Unpublished  
Pella Area III level I McNicoll *et al.* 1992, Pl. 50.11  
Pella Iron I Unpublished  
Tel Dan VI Biran 1989a, Fig. 4.16.1  
Tell Afis Area E1 level 3 Mazzoni 1998a, Fig. 22.9  
Tell Afis Area E1 level 4 see Lehman 1996, 452 (Form 446)  
Tell Afis Area E1 level 6 Mazzoni 1998a, Fig. 18.15  
Tell Afis Area E1 level 9a Venturi 2000a, Fig. 10.9  
Tell Afis Area Ge level 3 Cecchini 1998, Fig. 15.9  
Tell Jurn Kabir Findgroup A Eidem and Ackermann 1999, Fig. 5.23  
Tell Kazel Area II level 6 Badre *et al.* 1994, Fig. 42.g-h  
Tell Tayinat Iron I Unpublished

**Iron I-II**

Tel Dan IV Biran 1989b, Fig. 5.8

**Iron II**

Hazor V Yadin *et al.* 1958, Pl. 55.2  
Hazor VII Ben Tor *et al.* 1997, Fig. III.31 (11)  
Hazor VIII Ben Tor *et al.* 1997, Fig. III.27 (5)  
Pella Iron II Unpublished  
Tel Beth Shan IV James 1966, Fig. 69.7-8, 10  
Tell Afis Area B (Afis VIII) Virgilio 2005, Fig. 34.9  
Tell Afis Area E1 level 2 see Lehmann 1996, 452 (Form 446)  
Tell el Ghassil Area I level 1 Baramki 1964, Fig. 21.2  
Tell el Ghassil Area III level 2 Joukowsky 1972, Pl. 17.80-81  
Tell el Ghassil Area III level 3 Joukowsky 1972, Pl. 24.16, 20  
Tell Nebi Mend Trench V Level B Unpublished  
Tell Qarqur 8 Unpublished  
Tell Sheikh Hassan 3 Schneider 1999a, Fig. 10.17  
Tille Höyük VIII Blaylock 1999, Fig. 11.10-13, 17-18  
Tyre VI Bikai 1978b, Pl. 18.19  
Tyre VIII Bikai 1978b, Pl. 20.13

**Iron III**

Tell Afis Area D level 2 Mazzoni 1988a, Fig. 12.11  
Tell Afis Area Gc level 3 Cecchini 1998, Fig. 34.4  
Tell Afis Area Gc level 5 Cecchini 1998, Fig. 30.19  
Tell Keisan 4 Briend & Humbert 1980, Pl. 34.1  
Tell Keisan 4 Briend & Humbert 1980, Pl. 35.6  
Tell Keisan 5 Briend & Humbert 1980, Pl. 46.5

**Iron II-Persian**

Akhziv East Cem XIV Dayagi-Mendels 2002, Fig. 4.12(12)  
Akhziv South Cem 72 E. Mazar 2001, Fig. 64.24

**Iron III-Persian**

Akhziv East Cem XXVIII Dayagi-Mendels 2002, 75 (5)

**Persian**

Tell Shiyuk Fawqani Area G level 1 Luciani 2005, Pl. 56.639-642

**Unclear Context**

Tel Dan Unstrat. Biran 1994, Fig. 165.2

## **B.2.8 CLASS 008**

### **B.2.8.1 CLASS 008a**

#### **Iron I**

- Hazor IX Yadin *et al.* 1960, Pl. 52.13  
Hazor X Yadin *et al.* 1961, Pl. 171.23-24, 26-27  
Hazor X Ben Tor *et al.* 1997, Fig. III.22 (7)  
Kamid el-Lawz Iron I Heinz *et al.* 2004, Fig. 54.2  
Sarepta Area X level V Khalifeh 1988, Type CP16  
Sarepta Area Y level G Anderson 1988, Pl. 28.11  
Tell el Ghassil Area III level 6 Baramki 1966, Fig. 8.4  
Tell Kazel Area II level 5 Badre 1990b, Fig. 41.f-g

#### **Iron I-II**

- Tel Dan IV Biran 1982, Fig. 25.3

#### **Iron II**

- Hazor IV Ben Tor *et al.* 1997, Fig. III.50 (8, 11)  
Hazor V Yadin *et al.* 1958, Pl. 73.5  
Hazor V Yadin *et al.* 1958, Pl. 74.21  
Hazor VI Yadin *et al.* 1961, Pl. 249.26-28  
Hazor VII Yadin *et al.* 1960, Pl. 64.7, 9, 14  
Hazor VII Ben Tor *et al.* 1997, Fig. III.30 (24)  
Hazor VII Ben Tor *et al.* 1997, Fig. III.32 (24-26)  
Hazor VIII Yadin *et al.* 1960, Pl. 57.14, 17-21  
Hazor VIII Ben Tor *et al.* 1997, Fig. III.26 (5)  
Tell Afis Area E1 level 1 Mazzoni 1992b, Fig. 13.1  
Tell Afis Area E1 level 2 Mazzoni 1998a, Fig. 25.11  
Tell el Ghassil Area I level 3 Joukowsky 1972, Pl. 5.10  
Tyre IV Bikai 1978b, Pl. 17.2

#### **Iron III**

- Hazor III Yadin *et al.* 1958, Pl. 76.8  
Tell Keisan 4 Briend & Humbert 1980, Pl. 34.10e

### **B.2.8.2 CLASS 008b**

#### **Iron I**

- Hazor IX Yadin *et al.* 1960, Pl. 52.14-15  
Hazor IX Yadin *et al.* 1961, Pl. 179.3-6  
Hazor IX Yadin *et al.* 1961, Pl. 209.1-2, 4, 9-12  
Hazor IX/X Yadin *et al.* 1961, Pl. 164.7  
Hazor IX/X Unpublished  
Hazor X Yadin *et al.* 1960, Pl. 51.11-13  
Hazor X Yadin *et al.* 1961, Pl. 207.9-17  
Hazor X Ben Tor *et al.* 1997, Fig. III.21 (3-17)  
Hazor X Ben Tor *et al.* 1997, Fig. III.23 (7-10)  
Hazor XI Yadin *et al.* 1961, Pl. 203.8-9  
Hazor XII Yadin *et al.* 1961, Pl. 165.14, 17  
Hazor XII Yadin *et al.* 1961, Pl. 201.11-17  
Kamid el-Lawz Iron I Marfoe 1995, Fig. 105.5  
Megiddo VB Lamon & Shipton 1939, Fig. 40.20  
Megiddo Area K level 3 (VB) Finkelstein *et al.* 2000b, Fig. 11.19(1, 5)  
Pella Area III level I McNicoll *et al.* 1992, Pl. 50.5  
Pella Iron I Unpublished  
Tel Beth Shan V lower James 1966, Fig. 61.14-15  
Tel Beth Shan VI James 1966, Fig. 53.1, 3-4, 6  
Tel Beth Shan Area S level 2 A. Mazar 1993b, Fig. 14.4-5  
Tel Dan V Biran 1989a, Fig. 4.6.8, 13

Tel Dan VI Biran 1989a, Fig. 4.16.3, 6  
Tell Keisan 9a/b Briend & Humbert 1980, Pl. 63.7-9  
**Iron I-II**  
Megiddo Area K level 2 (VA-IVB) Finkelstein *et al.* 2000b, Fig. 11.21(5)  
Tel Beth Shan V James 1966, Figs 3.1-2; 18.6  
Tel Dan IV Biran 1982, Fig. 25.5  
Tel Dan IV Biran 1989b, Figs 5.1-3; 27.1-4

#### **Iron II**

Hazor V Yadin *et al.* 1958, Pl. 67.34, 37  
Hazor V Yadin *et al.* 1958, Pl. 73.14, 37  
Hazor VI Ben Tor *et al.* 1997, Fig. II.54 (23)  
Hazor VII Yadin *et al.* 1961, Pl. 215.11  
Hazor VIII Yadin *et al.* 1960, Pl. 57.4, 7, 11  
Megiddo Area H level 3 (IVA) Finkelstein *et al.* 2000b, Figs 11.44(6); 53(7)  
Pella Area VIII level 6 McNicoll *et al.* 1992, Pl. 66.4, 6  
Pella Iron II Unpublished  
Tel Dan III Biran 1999, Fig. 4.7  
Tel Dan III Biran 1999, Fig. 11.6-9  
Tel Jezreel Findgroup A Zimhoni 1997a, Fig. 1.6 (3)  
Tel Jezreel Findgroup A Zimhoni 1997a, Fig. 1.7 (9)  
Tel Jezreel Findgroup A Zimhoni 1997b, Fig. 2.6 (1)  
Tel Jezreel Findgroup D Zimhoni 1997a, Fig. 1.5 (1-2)  
Tel Jezreel Findgroup F Zimhoni 1997b, Fig. 2.12 (3)  
Tel Jezreel Iron II Zimhoni 1997b, Fig. 2.4 (1-2)  
Tel Rehov Area C/E level 1 A. Mazar 1999a, Fig. 24.8  
Tell el Ghassil Area I level 3 Joukowsky 1972, Pl. 5.11, 13  
Tell Keisan 8 Briend & Humbert 1980, Pl. 55.2

#### **Unclear Context**

Tell Abu Hawam III Hamilton 1935, Fig. 10b

### **B.2.8.3 CLASS 008c**

#### **Iron I**

Hazor IX Yadin *et al.* 1961, Pl. 212.28-32  
Hazor IX/X Unpublished  
Hazor X Ben Tor *et al.* 1997, Fig. III.21 (3-7, 14-18)  
Hazor XI Yadin *et al.* 1961, Pl. 203.7, 10  
Hazor XI Ben Tor *et al.* 1997, Fig. III.19 (2-3)  
Hazor XII Yadin *et al.* 1961, Pl. 165.2, 5, 8, 10, 13  
Hazor XII Yadin *et al.* 1961, Pl. 170.13  
Hazor XII Ben Tor *et al.* 1997, Fig. III.18 (3)  
Hazor Iron I Ben Ami 2001, Fig. 6.2-4, 10-13  
Kamid el-Lawz Iron I Marfoe 1995, Figs 104.4; 105.4  
Megiddo VB Lamon & Shipton 1939, Fig. 40.19  
Megiddo Area K level 3 (VB) Finkelstein *et al.* 2000b, Fig. 11.19(3-4)  
Megiddo VIA Harrison 2004b, Pl. 9.1, 7  
Megiddo Area F level 5 (VIA) Finkelstein *et al.* 2000b, Fig. 11.2(9)  
Pella Area III level I McNicoll *et al.* 1992, Pl. 51.4  
Pella Area VIII level 7 McNicoll *et al.* 1992, Pl. 65.12  
Pella Iron I Unpublished  
Tel Beth Shan VI upper Yadin & Geva 1986, Fig. 11.8  
Tel Beth Shan VI lower Yadin & Geva 1986, Fig. 25.2-3  
Tel Dan V Biran 1989a, Fig. 4.7.4-5  
Tell Keisan 9a/b Briend & Humbert 1980, Pl. 63.2, 5, 6  
Tell Keisan 9c Briend & Humbert 1980, Pl. 77.1a-f, 2a-e

#### **Iron I-II**

Megiddo Area K level 2 (VA-IVB) Finkelstein *et al.* 2000b, Fig. 11.21(2-3)  
Pella Area III level O McNicoll *et al.* 1992, Pl. 67.4  
Tel Beth Shan V James 1966, Figs 25.15; 29.8

Tel Dan IV Biran 1982, Fig. 25.1  
Tell el Ghassil Area I level 4 Joukowsky 1972, Pl. 8.33

#### **Iron II**

Hazor VII Yadin *et al.* 1961, Pl. 180.10  
Pella Iron II Unpublished  
Tel Beth Shan V upper James 1966, Fig. 66.7-8  
Tel Jezreel Findgroup A Zimhoni 1997a, Fig. 1.7 (8, 11, 12, 14)  
Tel Jezreel Findgroup A Zimhoni 1997b, Fig. 2.6 (2)  
Tel Jezreel Findgroup B Zimhoni 1997b, Fig. 2.9 (1)  
Tel Jezreel Findgroup D Zimhoni 1997a, Fig. 1.4 (2-5)  
Tel Rehov Area C/E level 1 A. Mazar 1999a, Fig. 24.9  
Tell el Ghassil Area III level 2 Joukowsky 1972, Pl. 17.82  
Tell Keisan 6 Briend & Humbert 1980, Pl. 49.9  
Tell Keisan 7 Briend & Humbert 1980, Pl. 52.13b-d  
Tell Keisan 8 Briend & Humbert 1980, Pl. 55.7

#### **Iron I-III**

Akhziv South Cem VI Dayagi-Mendels 2002, Fig. 3.7(8)

#### **Iron III**

Tell Keisan 4 Briend & Humbert 1980, Pl. 34.10  
Tell Keisan 5 Briend & Humbert 1980, Pl. 46.1

#### **Iron III-Persian**

Tell Keisan II/III Seton-Williams 1980, Pl. 109.14

#### **Unclear Context**

Tell Abu Hawam III Hamilton 1935, Fig. 10a

### **B.2.8.4 CLASS 008d**

#### **Iron I**

Hazor IX Yadin *et al.* 1961, Pl. 212.25-27  
Hazor XII Yadin *et al.* 1961, Pl. 166.4, 6, 8  
Hazor Iron I Ben Tor *et al.* 1997, Fig. II.34 (23-24)  
Hazor Iron I Ben Ami 2001, Fig. 6.1, 5-9  
Kamid el-Lawz Iron I Marfoe 1995, Figs 104.2, 5; 105.2-3  
Megiddo Area K level 3 (VB) Finkelstein *et al.* 2000b, Fig. 11.19(2)  
Megiddo VIA Loud 1948, Fig. 79.6  
Megiddo VIA Harrison 2004b, Pl. 9.3  
Megiddo Area F level 5 (VIA) Finkelstein *et al.* 2000b, Fig. 11.2(12)  
Pella Area III level I McNicoll *et al.* 1992, Pl. 51.5-8  
Pella Area VIII level 7 McNicoll *et al.* 1992, Pl. 65.10  
Pella Area VIII level 8 McNicoll *et al.* 1992, Pl. 64.2  
Pella Iron I Unpublished  
Sarepta Area Y level E Anderson 1988, Pl. 31.24  
Sarepta Area Y level F Anderson 1988, Pl. 30.3  
Tel Beth Shan VI James 1966, Fig. 50.12-13  
Tel Beth Shan VI upper Yadin & Geva 1986, Fig. 11.7  
Tel Beth Shan VI lower Yadin & Geva 1986, Fig. 25.1  
Tel Dan V Biran 1989a, Fig. 4.6.1-7  
Tel Dan V Biran 1989b, Figs 17.1-2; 18.2-3; 24.2-3  
Tel Dan V/VI Biran 1994, Fig. 103.3-4  
Tel Dan VI Biran 1989a, Fig. 4.16.2, 4-5; 4.18.11, 13; 4.19.4-6  
Tell Keisan 9a/b Briend & Humbert 1980, Pl. 63.4  
Tell Keisan 9c Briend & Humbert 1980, Pl. 77.3  
Tell Keisan 11/10 Briend & Humbert 1980, Pl. 81.8  
Tell Keisan IV/V Seton-Williams 1980, Pl. 110.1-5  
Tyre XIV Bikai 1978b, Pl. 39.16, 19, 22, 24

#### **Iron I-II**

Megiddo VA-IVB Loud 1948, Fig. 90.5-6  
Megiddo Area K level 2 (VA-IVB) Finkelstein *et al.* 2000b, Fig. 11.21(1)  
Megiddo Tombs Guy 1938, Pl. 75.10



Pella Area III level O McNicoll *et al.* 1992, Pl. 67.5  
Tel Beth Shan V James 1966, Fig. 2.2  
Tel Beth Shan V James 1966, Fig. 19.20  
Tell el Ghassil Area I level 4 Joukowsky 1972, Pl. 8.25

#### **Iron II**

Hazor V Yadin *et al.* 1958, Pl. 73.4  
Hazor VIII Ben Tor *et al.* 1997, Fig. III.24 (25)  
Tel Beth Shan V upper James 1966, Fig. 66.6, 9  
Tel Jezreel Findgroup A Zimhoni 1997a, Figs 1.6 (4-5); 1.7 (13)  
Tel Jezreel Findgroup A Zimhoni 1997b, Fig. 2.6 (3)  
Tel Jezreel Findgroup D Zimhoni 1997a, Fig. 1.5 (3-5)  
Tel Jezreel Findgroup F Zimhoni 1997b, Fig. 2.12 (4)  
Tell el Ghassil Area I level 3 Baramki 1961, Fig. 3.3; Pl. 7.3  
Tell el Ghassil Area III level 3 Joukowsky 1972, Pl. 24.19  
Tell Kazel Iron II Dunand *et al.* 1964, Pl. 10.4  
Tell Keisan 6 Briend & Humbert 1980, Pl. 49.9a  
Tell Keisan 7 Briend & Humbert 1980, Pl. 52.13  
Tell Keisan 8 Briend & Humbert 1980, Pl. 55.1, 3

#### **Iron III**

Tell Keisan 4 Briend & Humbert 1980, Pl. 35.1, 3, 5  
Tell Keisan 5 Briend & Humbert 1980, Pl. 46.2

### **B.2.8.5 CLASS 008e**

#### **Iron I**

Hazor IX Yadin *et al.* 1961, Pl. 175.25-28  
Hazor IX Yadin *et al.* 1961, Pl. 209.3, 5-8  
Hazor IX/X Yadin *et al.* 1958, Pl. 45.18-20, 22  
Hazor IX/X Yadin *et al.* 1961, Pl. 210.11, 13, 15, 17, 19-22  
Hazor X Yadin *et al.* 1961, Pl. 171.20-22  
Hazor X Yadin *et al.* 1961, Pl. 174.10-11  
Hazor XI Yadin *et al.* 1961, Pl. 203.12  
Hazor XII Yadin *et al.* 1961, Pl. 166.2-3,  
Hazor XII Yadin *et al.* 1961, Pl. 170.7-10  
Kamid el-Lawz Iron I Hachmann 1966, Fig. 24.4  
Kamid el-Lawz Iron I Heinz *et al.* 2004, Fig. 54.1  
Kamid el-Lawz Iron I Heinz *et al.* 2004, Pl. 1e  
Megiddo VIA Harrison 2004b, Pl. 9.4  
Megiddo Area F level 5 (VIA) Finkelstein *et al.* 2000b, Fig. 11.2(10)  
Pella Iron I Unpublished  
Tel Dan V Biran 1989a, Fig. 4.6.14-16  
Tel Dan VI Biran 1989b, Fig. 12.1-5; 4.19.7-11  
Tell Kazel Area II level 5 Badre *et al.* 1994, Fig. 33.a  
Tell Keisan 9a/b Briend & Humbert 1980, Pl. 63.1-1b

#### **Iron I-II**

Pella Area III level O McNicoll *et al.* 1992, Pl. 67.14  
Tel Dan IV Biran 1982, Fig. 25.4, 6;  
Tel Dan IV Biran 1989b, Fig. 5.1-3

#### **Iron II**

Hazor V Yadin *et al.* 1960, Pl. 85.17  
Hazor V Ben Tor *et al.* 1997, Fig. III.42 (12-13)  
Hazor VI Ben Tor *et al.* 1997, Fig. III.35 (5-6)  
Hazor VII Ben Tor *et al.* 1997, Fig. III.30 (22-23)  
Hazor VIII Yadin *et al.* 1958, Pl. 48.1-3  
Hazor VIII Yadin *et al.* 1960, Pl. 57.6, 9-10, 12-13, 23  
Khirbet Silm S. V. Chapman 1972, Fig. 22.83  
Tel Jezreel Findgroup D Zimhoni 1997a, Fig. 1.4 (6)  
Tel Jezreel Iron II Zimhoni 1997b, Fig. 2.4 (3-4)  
Tell el Ghassil Area III level 2 Joukowsky 1972, Pl. 17.83

**Iron III**

Tell Keisan 4 Briend & Humbert 1980, Pl. 34.10a-d

**Unclear Context**

Tell Abu Hawam III Hamilton 1935, 23, No. 90

**B.2.9 CLASS 009****B.2.9.1 CLASS 009a****Iron II**

Tell Abou Danne IId/A6 Lebeau 1983, Pl. 52.4-6

**Iron III**

Tell Abou Danne IIc/A5 Lebeau 1983, Pl. 119.3

Tell Afis Area A Matermawi 2005, Fig. 26.7

Tel Dan I Pakman 1992, Fig. 4.7

**Persian**

Beirut Bey 010 Persian Doumet-Serhal & Sayegh 1998, Figs 19(6-10); 20

Beirut Bey 010 Persian Doumet-Serhal & Sayegh 1998, Figs 21(1-6, 8-10); 22

Beirut Bey 010 Persian Sapin & Sayegh 1998, 105, 110(82-83)

Hazor II Yadin *et al.* 1958, Pl. 80.23-27

Hazor II Yadin *et al.* 1961, Pl. 191.15

Hazor II Yadin *et al.* 1961, Pl. 257.12-14

Megiddo I Lamou & Shipton 1939, Fig. 9.33

Sidon Persian Doumet-Serhal 2006, Fig. 18.37-38

Tell Abou Danne IIb/A4 see Lehmann 1996, 453 (Form 458)

Tell Abu Hawam II Hamilton 1935, Fig. 6

Tell Kazel Area I level 4 Gubel 1990a, Fig. 23.e

Tell Kazel Area I level 4 Gubel 1990b, Fig. 2g

Tell Keisan 2 Briend & Humbert 1980, Pl. 11.1-1n, 2a-f, 3a-c

Tell Keisan 3 Briend & Humbert 1980, Pl. 21.9-9a

Tell Keisan I Seton-Williams 1980, Pl. 108.8, 10

Tell Sukas E Buhl 1983, Fig. IX.93

Tell Sukas South Harbour Sanctuary Riis 1979, Figs 114, 146

Tell Sukas G2 Buhl 1983, Fig. IX.95

**Unclear Context**

Al Mina Unstrat. Lehmann 1996, Pl. 86 (Form 458/2)

Sarepta Area X unstrat. Pritchard 1988, Fig. 53.5-6

**B.2.9.2 CLASS 009b****Iron II**

Tel Beth Shan V James 1966, Fig. 26.14-15

Tell Abou Danne IId/A6 Lebeau 1983, Pl. 51.2

**Iron III**

Tell Judeideh III see Lehmann 1996, 451 (Form 443)

Tell Rifa'at 2a Lehmann 1996, Pl. 84 (443/1)

**Persian**

Beirut Bey 010 Persian Doumet-Serhal & Sayegh 1998, 21(7)

**Unclear Context**

Tell Rifa'at Unstrat. Lehmann 1996, Pl. 84 (442/1)

**B.2.10 CLASS 010****Iron I**

Hazor IX Yadin *et al.* 1960, Pl. 52.26-27

Hazor IX Yadin *et al.* 1961, Pl. 179.20-22

Hazor IX/X Yadin *et al.* 1958, Pl. 46.15-16

Hazor IX/X Yadin *et al.* 1961, Pl. 211.16  
Hazor X Yadin *et al.* 1961, Pl. 207.27  
Megiddo VB Lamon & Shipton 1939, Fig. 30.136  
Megiddo VB Lamon & Shipton 1939, Fig. 31.152  
Megiddo VIA Harrison 2004b, Pl. 4.10, 12  
Tel Beth Shan VI James 1966, Fig. 53.2  
Tel Dan V Biran 1994, Fig. 98.6  
Tell Keisan 9a/b Briend & Humbert 1980, Pl. 63.3  
Tell Keisan 9c Briend & Humbert 1980, Pl. 77.6  
Tyre XI Bikai 1978b, Pl. 29.10

#### **Iron I-II**

Tyre X Bikai 1978b, Pl. 23.17

#### **Iron II**

Hazor IV Yadin *et al.* 1961, Pl. 256.1  
Hazor V Yadin *et al.* 1958, Pl. 56.25  
Hazor V Yadin *et al.* 1961, Pl. 253.5-6  
Hazor VI Yadin *et al.* 1958, Pl. 51.27  
Hazor VI Yadin *et al.* 1961, Pl. 250.17  
Hazor VII Ben Tor *et al.* 1997, Fig. III.30 (27-28)  
Hazor VIII Yadin *et al.* 1958, Pl. 48.17-18  
Hazor VIII Yadin *et al.* 1960, Pl. 62.1-2  
Tell Keisan 7 Briend & Humbert 1980, Pl. 52.16  
Tell Keisan 8 Briend & Humbert 1980, Pl. 55.4-5  
Tell Nebi Mend Trench V Level C Unpublished  
Tell Sukas H1 Buhl 1983, Fig. XVI.240  
Tyre IX Bikai 1978b, Pl. 20.16, 18

#### **Iron II-III**

Sarepta Area Y level C Anderson 1988, Pl. 35.21-22

#### **Iron III**

Megiddo II/III Lamon & Shipton 1939, Fig. 24.26-27  
Tell Keisan 5 Briend & Humbert 1980, Pl. 46.8  
Tell Keisan II/III Seton-Williams 1980, Pl. 109.3  
Zincirli Iron III Andrae 1943, Pl. 28n, p

## **B.3 MISCELLANEOUS UTILITARIAN**

### **B.3.1 CLASS 011**

#### **B.3.1.1 CLASS 011a**

##### **Iron I-II**

Megiddo Tombs Guy 1938, Pl. 75.15

##### **Iron II**

Tyre III Bikai 1978b, Pl. 10.3, 5-6

#### **B.3.1.2 CLASS 011b**

##### **Iron I-II**

Megiddo Tombs Guy 1938, Pl. 75.14

##### **Iron II**

Hazor V Yadin *et al.* 1958, Pl. 69.10  
Hazor V Yadin *et al.* 1958, Pl. 73.9  
Hazor V Yadin *et al.* 1958, Pl. 74.31  
Hazor VII Yadin *et al.* 1958, Pl. 50.40  
Hazor VIII Yadin *et al.* 1960, Pl. 62.9-10  
Tyre III Bikai 1978b, Pl. 10.1-2

##### **Iron III**

## **B.3.2 CLASS 012**

### **B.3.2.1 CLASS 012a**

#### **Iron I**

- Beirut Bey 003 LB/Iron Badre 2001-2002, Fig. 14.3-5
- Hazor IX Yadin *et al.* 1961, Pl. 213.14
- Hazor XI Yadin *et al.* 1961, Pl. 203.20-21
- Hazor XII Yadin *et al.* 1961, Pl. 170.21
- Megiddo VB Lamon & Shipton 1939, Fig. 37.17
- Megiddo VIA Loud 1948, Fig. 79.7, 9
- Megiddo VIA Harrison 2004b, Pl. 20.1, 4
- Megiddo Tombs Guy 1938, Pls 68.11; 70.6; 71.18; 73.14
- Tel Beth Shan VI James 1966, Figs 50.14; 51.12
- Tell Abu Hawam V/IV Hamilton 1935, 49, No. 300
- Tell el Ghassil Area I level 5 Joukowsky 1972, Pl. 13.24
- Tell Kazel Area II level 5 Badre 1990b, Fig. 39.d-e
- Tell Kazel Area II level 6 Badre *et al.* 1994, Fig. 47.h

#### **Iron I-II**

- Tel Beth Shan Northern cem. Oren 1973, Figs 41.1-2; 42a.13
- Tel Dan IV Biran 1989b, Fig. 5.13
- Tell Sukas H Buhl 1983, Fig. XVIII.334, 336
- Tyre X Bikai 1978b, Pl. 26.9

#### **Iron II**

- Hazor VIII Ben Tor *et al.* 1997, Fig. III.24 (20)
- Tell Mastuma Central Area level I-1 Wakita *et al.* 1995, Fig. 7.8

#### **Iron III**

- Tell Afis Area Gc level 4 Cecchini 1998, Fig. 37.11
- Tell Ahmar Area C level 2 Jamieson 2005, Fig. 4.15.2-3

#### **Persian**

- Tell Sukas G Buhl 1983, Fig. XVIII.333
- Tell Sukas G2 Buhl 1983, Fig. XVIII.337

#### **Unclear Context**

- Sarepta Area X unstrat. Pritchard 1988, Fig. 56.1
- Tell Abu Hawam III Hamilton 1935, 23, No. 93
- Tell Mishrife Unstrat. du Mesnil du Buisson 1927, Fig. 5.23

### **B.3.2.2 CLASS 012b**

#### **Iron I**

- Hazor IX Yadin *et al.* 1961, Pl. 176.14-15
- Hazor IX Yadin *et al.* 1961, Pl. 178.19
- Hazor IX Yadin *et al.* 1961, Pl. 179.17
- Hazor IX/X Yadin *et al.* 1958, Pl. 46.11-13
- Hazor IX/X Yadin *et al.* 1961, Pl. 211.15
- Megiddo VB Lamon & Shipton 1939, Fig. 38.18-19
- Megiddo VB Lamon & Shipton 1939, Fig. 38.19
- Megiddo Area K level 3 (VB) Finkelstein *et al.* 2000b, Fig. 11.18(16)
- Megiddo VIA Loud 1948, Fig. 79.8
- Megiddo VIA Harrison 2004b, Pl. 20.7
- Megiddo Area F level 5 (VIA) Finkelstein *et al.* 2000b, Fig. 11.3(10)
- Megiddo VIB Loud 1948, Fig. 74.13
- Megiddo Tombs Guy 1938, Pl. 74.23-24
- Pella Area III level I McNicoll *et al.* 1992, Pl. 49.10
- Pella Iron I Unpublished
- Sarepta Area X level V Khalifeh 1988, Type L5, L7

Sarepta Area Y level F Anderson 1988, Pl. 30.14  
Tel Beth Shan V lower James 1966, Fig. 62.1  
Tel Dan V Biran 1994, Fig. 98.10  
Tell Abu Hawam V/IV Hamilton 1934, Pl. 22.26  
Tell Afis Area E1 level 4 Mazzoni 1992b, Fig. 10.4  
Tell Afis Area E1 level 4 Mazzoni 1998a, Fig. 19.12  
Tell Kazel Area II level 5 Capet 2003, Fig. 34.g  
Tell Kazel Area II level 6 Capet 2003, Fig. 21.d  
Tell Kazel Area IV level 3 Badre & Gubel 1999-2000, Fig. 46.c  
Tell Kazel Area IV level 5 Badre & Gubel 1999-2000, Fig. 36.l-m  
Tell Keisan 9a/b Briend & Humbert 1980, Pl. 66.14-17  
Tell Keisan 9c Briend & Humbert 1980, Pl. 77.7-8  
Tell Sukas South Harbour Buhl 1996, Fig. 31.XVIIA (6097 SH 59)  
Tell Sukas South Harbour Buhl 1996, Fig. 32.XVIIIB (3591/1)  
Tell Sukas South Harbour Buhl 1996, Fig. 32.XVIID

#### **Iron I-II**

Megiddo VA-IVB Lamon & Shipton 1939, Fig. 38.19  
Tel Beth Shan V James 1966, Fig. 31.10  
Tel Beth Shan Northern cem. Oren 1973, Figs 42a.11-12, 14-15; 43.2-5  
Tel Beth Shan Northern cem. Oren 1973, Figs 42b.16; 43.18; 46.8  
Tyre X Bikai 1978b, Pl. 26.10

#### **Iron II**

Hama E Fugmann 1958, Fig. 310 (7A872)  
Hazor IV Yadin *et al.* 1960, Pl. 100.25-27  
Hazor V Yadin *et al.* 1958, Pl. 57.18-21  
Hazor V Yadin *et al.* 1960, Pl. 75.17-18  
Hazor V Yadin *et al.* 1960, Pl. 88.12-14  
Hazor V Yadin *et al.* 1960, Pl. 97.13  
Hazor V Yadin *et al.* 1961, Pl. 221.17  
Hazor V Yadin *et al.* 1961, Pl. 224.14-15  
Hazor V Yadin *et al.* 1961, Pl. 232.1-7, 11-12  
Hazor VI Yadin *et al.* 1958, Pl. 52.30-33  
Hazor VI Yadin *et al.* 1960, Pl. 74.5-9  
Hazor VI Yadin *et al.* 1961, Pl. 250.16  
Hazor VI Ben Tor *et al.* 1997, Figs III.35 (4); III.37 (6)  
Hazor VII Yadin *et al.* 1958, Pl. 50.37-39  
Hazor VII Yadin *et al.* 1960, Pl. 65.11-12, 14  
Hazor VII Ben Tor *et al.* 1997, Fig. III.32 (17)  
Hazor VIII Yadin *et al.* 1960, Pl. 61.18, 21  
Hazor VIII Yadin *et al.* 1960, Pl. 61.19-20  
Joya S. V. Chapman 1972, Fig. 23.227  
Megiddo IVA Lamon & Shipton 1939, Fig. 37.10  
# Megiddo Area H level 3 (IVA) Finkelstein *et al.* 2000b, Fig. 11.47(13)  
Megiddo Area H level 3 (IVA) Finkelstein *et al.* 2000b, Fig. 11.47(14)  
Sarepta Area Y level D Anderson 1988, Pl. 32.18  
Sarepta Area Y level D Anderson 1988, Pl. 34.16  
Tel Dan III Biran 1996b, Fig. 7.10-11  
Tell Afis Area D level 4 Cecchini 1988, Fig. 11.16  
Tell el Ghassil Area I level 1 Joukowsky 1972, Pl. 1.23  
Tell el Ghassil Area III level 3 Joukowsky 1972, Pl. 25.3, 5  
Tell Keisan 7 Briend & Humbert 1980, Pl. 51.10-12  
Tyre III Bikai 1978b, Pl. 7.6  
Tyre IV Bikai 1978b, Pl. 14.9

#### **Iron I-III**

Akhziv Tomb N2 E. Mazar 2004, Fig. 15.1

#### **Iron III**

Megiddo II/III Lamon & Shipton 1939, Fig. 37.13-14  
# Megiddo II/III Lamon & Shipton 1939, Fig. 37.15  
Tell Afis Area Gc level 7b Cecchini 1998, Fig. 37.8-9  
Tell Ahmar Area C level 2 Jamieson 2000, Fig. 8.1-4

### **Unclear Context**

Athlit Cremation cem. Johns 1938, Fig. 4.5  
Athlit Cremation cem. Johns 1938, Fig. 8.3  
Athlit Cremation cem. Johns 1938, Fig. 9.2  
Sarepta Area X unstrat. Pritchard 1988, Fig. 56.2-4  
Tell Abu Hawam III Hamilton 1935, 23, No. 92  
Tell Nebi Mend Unstrat. Pezard 1931, Pl. 27.4

### **B.3.2.3 CLASS 012c**

#### **Iron I**

Hazor IX Yadin *et al.* 1960, Pl. 52.25  
Hazor IX Yadin *et al.* 1961, Pl. 179.18-19  
Hazor IX Yadin *et al.* 1961, Pl. 208.46-47  
Hazor IX/X Yadin *et al.* 1961, Pl. 177.17-18  
Hazor X Yadin *et al.* 1961, Pl. 174.18  
# Hazor XII Yadin *et al.* 1961, Pl. 169.7  
Megiddo VIA Harrison 2004b, Pl. 20.6  
Megiddo Tombs Guy 1938, Pl. 74.9  
Tell Abu Hawam IV Hamilton 1935, 30, No. 163  
Tell Abu Hawam V/IV Hamilton 1934, Pl. 22.24-25  
Tell el Ghassil Area I level 5 Joukowsky 1972, Pl. 13.23  
Tyre XII Bikai 1978b, Pl. 31.9

#### **Iron I-II**

Akhziv East Cem XXXIX Dayagi-Mendels 2002, Fig. 4.28(8)  
Byblos Necropolis K Salles 1980, Pl. 28.1  
Sarepta Area X level VII Khalifeh 1988, Type L9  
Tel Beth Shan V James 1966, Figs 3.8; 5.28; 29.3  
Tel Beth Shan Northern cem. Oren 1973, Fig. 44a.14  
Tel Beth Shan Northern cem. Oren 1973, Fig. 47a.11

#### **Iron II**

Hazor V Yadin *et al.* 1960, Pl. 88.15-17  
Hazor V Ben Tor *et al.* 1997, Fig. III.42 (9)  
Hazor VI Yadin *et al.* 1960, Pl. 74.10  
Hazor VI Yadin *et al.* 1961, Pl. 186.2-4, 7  
Hazor VII Yadin *et al.* 1960, Pl. 65.10, 13  
Hazor VII Yadin *et al.* 1961, Pl. 216.10-11  
Hazor VIII Yadin *et al.* 1958, Pl. 48.16  
Hazor VIII Yadin *et al.* 1960, Pl. 61.16-17, 24-25  
Joya S. V. Chapman 1972, Fig. 23.230, 235  
Megiddo Area H level 3 (IVA) Finkelstein *et al.* 2000b, Fig. 11.53(11)  
Tel Beth Shan IV James 1966, Fig. 32.1  
Tel Rehov Area C/E level 1 A. Mazar 1999a, Fig. 24.19  
Tell Afis Area D level 4 Mazzone 1988a, Fig. 7.5  
Tell el Ghassil Area I level 1 Baramki 1964, Fig. 14.4  
Tell el Ghassil Area I level 2 Joukowsky 1972, Pl. 4.12-13  
Tell el Ghassil Area I level 3 Baramki 1964, Fig. 4.3  
Tell el Ghassil Area III level 1 Joukowsky 1972, Pl. 16.21  
Tell Kazel Iron II Dunand *et al.* 1964, Pl. 11.5  
Tell Qarqur 8 Unpublished  
Tille Höyük VIII Blaylock 1999, Fig. 10.16  
Tyre III Bikai 1978b, Pl. 7.5

#### **Iron II-III**

Akhziv South Cem XVIII Dayagi-Mendels 2002, 29 (15)  
Qraye S. V. Chapman 1972, Fig. 23.285  
Sarepta Area X level VIII Khalifeh 1988, Type L9

#### **Iron II-Persian**

Akhziv East Cem XII Dayagi-Mendels 2002, Fig. 4.10(13)

#### **Iron III**

Megiddo II/III Lamon & Shipton 1939, Fig. 37.6-8, 10, 12  
Sarepta Tomb 26 Culican 1970, Fig. 3.4  
Sarepta Tomb 42 Culican 1975, Fig. 2c  
Tell Keisan 4 Briend & Humbert 1980, Pl. 32.8-9  
Tell Keisan 5 Briend & Humbert 1980, Pl. 43.12  
Tell Keisan 5 Briend & Humbert 1980, Pl. 44.6-8  
Tell Sukas G3 Buhl 1983, Fig. XVIII.346

#### **Iron III-Persian**

Akhziv Tomb N4 E. Mazar 2004, Fig. 15.2-4

#### **Persian**

Al Mina III Woolley 1938b, Fig. 15.1  
Athlit Tomb 23 Johns 1932, Fig. 72  
Hazor II Yadin *et al.* 1961, Pl. 191.16  
Hazor II Yadin *et al.* 1961, Pl. 258.2-3  
Megiddo I Lamon & Shipton 1939, Fig. 37. 8, 10, 12  
Sarepta Area Y level B Anderson 1988, Pl. 38.18  
Tell Abu Hawam II Hamilton 1934, Pl. 23.5  
Tell Abu Hawam II Hamilton 1935, Fig. 5  
Tell Kazel Area I level 4 Gubel 1990a, Fig. 24.d-e; Badre & Gubel 1999-2000, Fig. 4.a  
Tell Keisan 3 Briend & Humbert 1980, Pl. 21.1-5  
Tell Sukas G2 Buhl 1983, Fig. XVIII.335

#### **Unclear Context**

Athlit Cremation cem. Johns 1938, Fig. 6.7  
Byblos Unstrat. Dunand 1950, Nos 10.195, 11.362, 12.257, 14.653, 14.778  
Sidon Unstrat. Contenau 1920, Fig. 27d  
Sidon Unstrat. Saidah 1983, Pl. 53.1  
Sarepta Area X unstrat. Pritchard 1988, Fig. 56.5-9  
Sarepta Area X unstrat. Pritchard 1988, Fig. 57.10-15  
Tell Abu Hawam III Hamilton 1935, 23, No. 94  
Tell Mishrife Unstrat. du Mesnil du Buisson 1935, Fig. 49.191b  
Tell Rachidiah Tomb V Doumet 1982, Pl. XXII.4

### **B.3.2.4 CLASS 012d**

#### **Iron I-II**

Tel Beth Shan Northern cem. Oren 1973, Fig. 42b.18-20  
Tel Beth Shan Northern cem. Oren 1973, Fig. 47b.31

#### **Iron II**

Hama E Fugmann 1958, Fig. 269 (6B365)  
Hazor IV/V Yadin *et al.* 1958, Pl. 71.25  
# Hazor V Yadin *et al.* 1961, Pl. 232.8  
Hazor VII Yadin *et al.* 1961, Pl. 248.22  
Tel Dan III Biran 1996b, Fig. 7.7, 9

#### **Iron III**

Al Mina VIII/VII Lehmann 1996, Pl. 81 (422/1)  
# Megiddo II/III Lamon & Shipton 1939, Fig. 37.16

#### **Persian**

Tell Sukas F Buhl 1983, Fig. XVIII.355

### **B.3.3 CLASS 013**

#### **Iron I**

Hazor IX Yadin *et al.* 1961, Pl. 176.16-17  
Hazor IX/X Yadin *et al.* 1961, Pl. 177.19-21  
Hazor Iron I Ben Tor *et al.* 1997, Fig. II.34 (5)  
Megiddo VB Lamon & Shipton 1939, Fig. 38.4-5  
# Megiddo VB Lamon & Shipton 1939, Fig. 38.6  
Megiddo VIA Loud 1948, Fig. 79.12  
Megiddo VIA Harrison 2004b, Pl. 20.9-10

#### Pella Iron I Unpublished

- Sarepta Area Y level E Anderson 1988, Pl. 31.20  
Sarepta Area Y level G Anderson 1988, Pl. 28.18  
Tel Beth Shan V lower James 1966, Fig. 62.2  
Tel Beth Shan VI James 1966, Figs 50.6-7; 51.9  
Tel Beth Shan VI lower Yadin & Geva 1986, Fig. 34.2

#### Iron I-II

- # Megiddo VA-IVB Lamon & Shipton 1939, Fig. 38.6  
Tel Beth Shan V James 1966, Figs 13.2; 18.16; 22.2

#### Iron II

- Hazor V Yadin *et al.* 1960, Pl. 107.18  
Hazor V Yadin *et al.* 1961, Pl. 232.13  
Tel Beth Shan V upper James 1966, Fig. 66.12  
Tel Dan II Biran 1994, Fig. 212  
Tell Keisan 6 Briend & Humbert 1980, Pl. 49.8

#### Iron III

- Hazor III Yadin *et al.* 1958, Pl. 77.16  
# Megiddo II/III Lamon & Shipton 1939, Fig. 38.3

### B.3.4 CLASS 014

#### Iron I

- Hazor IX Yadin *et al.* 1961, Pl. 208.34  
Hazor IX/X Yadin *et al.* 1961, Pl. 210.9  
Hazor X Yadin *et al.* 1961, Pl. 171.16-17  
Kamid el-Lawz Iron I Marfoe 1995, Fig. 105.9-10  
\* Kamid el-Lawz Iron I Marfoe 1995, Fig. 105.11  
Megiddo VB Lamon & Shipton 1939, Fig. 31.146-147  
Tell el Ghassil Area III level 5 Baramki 1966, 37

#### Iron I-II

- Megiddo VA-IVB Lamon & Shipton 1939, Fig. 23.20  
Tel Beth Shan V James 1966, Fig. 1.5  
Tel Beth Shan V James 1966, Fig. 3.3  
Tel Beth Shan V James 1966, Fig. 25.16  
Tel Dan IV Biran 1989b, Fig. 27.11  
Tell el Ghassil Area I level 4 Baramki 1961, Fig. 6.4  
\* Tell el Ghassil Area I level 4 Joukowsky 1972, Pl. 8.27  
\* Tell el Ghassil Area III level 4 Joukowsky 1972, Pl. 26.2

#### Iron II

- Hazor V Yadin *et al.* 1958, Pl. 54.18  
Hazor VI Yadin *et al.* 1961, Pl. 249.19-20  
Hazor VII Yadin *et al.* 1958, Pl. 49.31  
Hazor VII Yadin *et al.* 1961, Pl. 180.13  
Hazor VII Ben Tor *et al.* 1997, Fig. III.32 (14)  
Hazor VIII Yadin *et al.* 1960, Pl. 55.43-44  
Hazor VIII Ben Tor *et al.* 1997, Fig. III.25 (5)  
Joya S. V. Chapman 1972, Fig. 22.218  
# Megiddo Area H level 3 (IVA) Finkelstein *et al.* 2000b, Fig. 11.43(13)  
Tel Beth Shan IV James 1966, Fig. 72.6  
Tel Dan III Biran 1996b, Fig. 7.13  
Tel Jezreel Findgroup A Zimhoni 1997a, Fig. 1.7 (15)  
Tell Abou Danne IId/A6 Lebeau 1983, Pl. 98.3  
Tell el Ghassil Area I level 1 Baramki 1964, Fig. 9.1  
Tell el Ghassil Area I level 2 Baramki 1961, Fig. 7.1  
Tell el Ghassil Area I level 2 Baramki 1964, Fig. 34.4-5  
Tell el Ghassil Area I level 2 Baramki 1964, Fig. 40.1  
Tell el Ghassil Area I level 2 Joukowsky 1972, Pl. 2.10-11, 13  
\* Tell el Ghassil Area I level 2 Joukowsky 1972, Pl. 2.12  
Tell el Ghassil Area III level 1 Joukowsky 1972, Pl. 15.20



Tell el Ghassil Area III level 2 Joukowsky 1972, Pl. 18.1  
Tell el Ghassil Area III level 3 Joukowsky 1972, Pl. 25.8  
Tell Nebi Mend Trench V Level B Unpublished

#### **Iron III**

Megiddo II/III Lamon & Shipton 1939, Fig. 23.20, 22-23  
# Megiddo II/III Lamon & Shipton 1939, Fig. 23.21

#### **Unclear Context**

Tell Nebi Mend Unstrat. Pezard 1931, Pl. 23.1.10

### **B.3.5 CLASS 015**

#### **Iron I**

Megiddo VIA Loud 1948, Fig. 80.9  
Tel Beth Shan VI James 1966, Fig. 53.14  
\* Tell Afis Area E1 level 8 Venturi 1998a, Fig. 4.7  
\* Tell Afis Area E1 level 9a Venturi 1998a, Fig. 4.6  
Tell Afis Area E1 level 9c Venturi 2000c, Fig. 6.1  
Tell Kazel Area IV level 3 Badre & Gubel 1999-2000, Fig. 46.a  
Tell Keisan IV/V Seton-Williams 1980, Pl. 110.13

#### **Iron I-II**

\*\* Megiddo VA-IVB Loud 1948, Fig. 90.9  
Tel Beth Shan V James 1966, Fig. 26.16

#### **Iron II**

\*\* Hazor V Yadin *et al.* 1958, Pl. 57.22  
\* Hazor V Yadin *et al.* 1958, Pl. 57.23  
Hazor V Yadin *et al.* 1961, Pl. 189.26  
Hazor V Yadin *et al.* 1961, Pl. 232.14-18  
Hazor V Yadin *et al.* 1961, Pl. 253.9  
\*\* Hazor V Ben Tor *et al.* 1997, Fig. III.47 (28)  
Hazor VI Yadin *et al.* 1961, Pl. 250.18-19  
Hazor VII Yadin *et al.* 1961, Pl. 218.9  
Hazor VII Yadin *et al.* 1961, Pl. 248.24  
Hazor VIII Yadin *et al.* 1960, Pl. 62.5-8  
\*\* Khirbet Silm S. V. Chapman 1972, Fig. 17.79  
Megiddo IVA Lamon & Shipton 1939, Fig. 34.13-15  
Megiddo Area H level 3 (IVA) Finkelstein *et al.* 2000b, Fig. 11.53(9)  
Pella Iron II Unpublished  
Tel Jezreel Findgroup B Zimhoni 1997b, Fig. 2.9 (8)  
\* Tell Afis Area D level 4 Cecchini 1988, Fig. 11.17  
Tell Afis Area D level 6 Mazzoni 1988a, Fig. 22.10  
Tell Arqa Tomb 1 Thalmann 1978b, Fig. 45.2  
\* Tell Kazel Area I levels 9-10 Badre *et al.* 1994, Fig. 20.b-c  
Tell Nebi Mend Trench V Level B Unpublished  
Tell Sheikh Hassan 3 Schneider 1999a, Fig. 11.20(3)  
Tell Sheikh Hassan 3 Schneider 1999a, Fig. 12.20  
Tille Höyük VIII Blaylock 1999, Fig. 7.7

#### **Iron II-III**

\*\* Qraye S. V. Chapman 1972, Fig. 17.282  
Tell Shiyuk Fawqani Area F (IX) Makinson 2005, Pl. 26.176-178

#### **Iron III**

Megiddo II/III Lamon & Shipton 1939, Fig. 34.2-3, 5-6, 9-10  
\* Megiddo II/III Lamon & Shipton 1939, Fig. 34.7, 12  
Tell Afis Area Gc level 2 Cecchini 1998, Fig. 37.6-7  
Tell Afis Area J (Afis IX) Oggiano 2002, Fig. 26.4  
Tell Ahmar Area C level 2 Jamieson 1999, Fig. 4.15  
Tell Ahmar Area C level 2 Jamieson 2000, Fig. 8.5-9  
Tell Keisan 4 Briend & Humbert 1980, Pl. 32.7  
Tell Keisan 5 Briend & Humbert 1980, Pl. 45.7-12

#### **Persian**

Beirut Bey 010 Persian Sapin & Sayegh 1998, 109(80-81)  
Hazor II Yadin *et al.* 1958, Pl. 82.15-17  
Megiddo I Lamon & Shipton 1939, Fig. 34.1-4  
\* Megiddo I Lamon & Shipton 1939, Fig. 34.7  
Tell Keisan 2 Briend & Humbert 1980, Pl. 10.11  
Tell Shiyuk Fawqani Area F (X) Makinson 2005, Pl. 36.241  
Tell Sukas E Buhl 1983, Fig. XIV.217  
Tell Sukas F Buhl 1983, Fig. XIV.218-219  
Tell Sukas South Harbour Sanctuary Riis 1979, Figs 116-117  
Tille Höyük X Blaylock 1999, Fig. 12.1  
**Unclear Context**  
Al Mina Unstrat. Woolley 1938b, Fig. 28.23

## **B.4 TRANSPORT AMPHORAE**

### **B.4.1 CLASS 016**

#### **B.4.1.1 CLASS 016a**

##### **Iron I**

Hazor XII Yadin *et al.* 1961, Pl. 202.7-9  
\* Kamid el-Lawz Iron I Marfoe 1995, Fig. 106.5  
Megiddo VB Lamon & Shipton 1939, Fig. 21.122-123  
Megiddo VI Loud 1948, Fig. 83.8  
# Megiddo VIA Loud 1948, Fig. 76.2  
Megiddo VIA Loud 1948, Figs 76.3-4; 77.2  
Megiddo VIA Harrison 2004b, Pl. 10.3  
Megiddo Area F level 5 (VIA) Finkelstein *et al.* 2000b, Fig. 11.4(4-8, 10)  
Megiddo VIB Loud 1948, Fig. 73.6-8  
\* Megiddo VIB Loud 1948, Fig. 73.10  
Megiddo Tombs Guy 1938, Pls 69.4; 70.1, 4; 72.2; 73.10  
\* Pella Iron I Unpublished  
Pella Iron I Unpublished  
Sarepta Area Y level G Anderson 1988, Pl. 26.1  
\* Tel Beth Shan VI James 1966, Fig. 51.15  
Tel Beth Shan VI James 1966, Fig. 54.8  
Tel Beth Shan VI upper Yadin & Geva 1986, Fig. 12  
Tel Beth Shan VI lower Yadin & Geva 1986, Figs 28; 29; 30.1; 31.2  
\* Tel Beth Shan VI lower Yadin & Geva 1986, Fig. 32.4  
Tel Beth Shan Area S level 2 A. Mazar 1993b, Fig. 14.9  
Tel Dan V Biran 1994, Fig. 99.5  
Tel Dan VI Biran 1994, Fig. 87.6  
Tell Kazel Area II level 5 Capet & Gubel 2000, Fig. 10  
Tell Kazel Area II level 5 Capet 2003, Fig. 36.a  
Tell Keisan 9a/b Briend & Humbert 1980, Pl. 58.1-8  
Tell Keisan 9c Briend & Humbert 1980, Pl. 69.2-3  
Tell Sukas H2 Buhl 1983, Fig. I.11;  
**Iron I-II**  
Byblos Necropolis K Salles 1980, Pl. 26.8  
Megiddo VA-IVB Lamon & Shipton 1939, Fig. 20.122, 124  
Tell Sukas H Buhl 1983, Fig. III.24  
**Iron II**  
Hazor VI Yadin *et al.* 1961, Pl. 186.2, 5  
Hazor VIII Ben Tor *et al.* 1997, Fig. III.25 (10, 12-13)  
Megiddo Area H level 3 (IVA) Finkelstein *et al.* 2000b, Fig. 11.47(3)  
\* Pella Iron II Unpublished  
Tel Jezreel Findgroup B Zimhoni 1997b, Fig. 2.9 (2-4)  
Tell Keisan 6 Briend & Humbert 1980, Pl. 48.3

Tell Keisan 7 Briend & Humbert 1980, Pl. 50.1-2

Tell Keisan 8 Briend & Humbert 1980, Pl. 54

#### **Iron II-III**

# Tyre Al-Bass cem. Unstrat. Seeden 1991, Figs 45-46

#### **Persian**

Tell Sukas F Buhl 1983, Fig. II.22

Tell Sukas G Buhl 1983, Fig. I.3

Tell Sukas G Buhl 1983, Fig. II.22

### **B.4.1.2 CLASS 016b**

#### **Iron I**

Hazor IX/X Unpublished

Hazor Iron I Ben Ami 2001, Fig. 8.16

Megiddo VI Loud 1948, Fig. 83.9

Megiddo VIA Harrison 2004b, Pl. 10.2

Megiddo VIA Harrison 2004b, Pl. 11.2

Megiddo Area F level 5 (VIA) Finkelstein *et al.* 2000b, Fig. 11.4(3, 11)

Megiddo Tombs Guy 1938, Pl. 69.1

\* Megiddo Tombs Guy 1938, Pl. 72.1, 13

Ras Ibn Hani Iron I Bounni *et al.* 1979, Fig. 26.4-7

Tel Beth Shan VI James 1966, Fig. 49.3

Tel Beth Shan VI lower Yadin & Geva 1986, Figs 30.2; 31.1, 3; 33.1

Tell Kazel Area II level 5 Badre *et al.* 1994, Fig. 31.a,c, f

Tell Kazel Area II level 5 Capet 2003, Figs 34.a; 36.b-e; 43.a-g

Tell Kazel Area II level 6 Capet 2003, Fig. 6.a-b

Tell Kazel Area IV level 5 Badre & Gubel 1999-2000, Fig. 32

\* Tell Keisan 9a/b Briend & Humbert 1980, Pl. 57.9

Tell Keisan 9a/b Briend & Humbert 1980, Pl. 59.1

\* Tell Keisan 9c Briend & Humbert 1980, Pl. 67.1-2, 5

Tell Keisan 9c Briend & Humbert 1980, Pl. 67.2a, 4

\* Tyre XIII Bikai 1978b, Pl. 34.10

Tyre XIII Bikai 1978b, Pl. 35.11

#### **Iron I-II**

Byblos Necropolis K Salles 1980, Pl. 27.6-7

Tyre X Bikai 1978b, Pl. 26.13, 15, 17-18, 21

#### **Iron II**

Hazor IV Yadin *et al.* 1960, Pl. 101.6

Hazor V Yadin *et al.* 1960, Pl. 75.16

Hazor V Yadin *et al.* 1960, Pl. 89.1, 4-5, 8-10

Hazor V Yadin *et al.* 1961, Pl. 229.2, 6-7

Hazor V Ben Tor *et al.* 1997, Fig. III.43 (6)

Hazor V Ben Tor *et al.* 1997, Fig. III.46 (2)

Hazor VI Yadin *et al.* 1960, Pl. 71.11, 17

Hazor VI Yadin *et al.* 1961, Pl. 186.3-4, 6-7

Hazor VI Ben Tor *et al.* 1997, Fig. II.55 (4)

Hazor VII Yadin *et al.* 1960, Pl. 65.4

Hazor VII Yadin *et al.* 1961, Pl. 218.3, 6

Hazor VIII Ben Tor *et al.* 1997, Figs III.25 (11); 27 (24)

Pella Iron II Unpublished

Tel Dan II Pakman 1992, Fig. 3.5-6

Tel Dan II Biran 1994, Fig. 168.3-4

Tel Jezreel Findgroup B Zimhoni 1997b, Fig. 2.9 (1, 5-6)

Tell Kazel Area II level 4 Badre 1990b, Fig. 37.i-k

Tell Keisan 7 Briend & Humbert 1980, Pl. 50.3-5

#### **Iron III**

Tell Keisan 5 Briend & Humbert 1980, Pl. 47.7-8

#### **Persian**

Tell Sukas F Buhl 1983, Fig. II.20-21

Tell Sukas G2 Buhl 1983, Pl. I.12  
Tell Sukas G Buhl 1983, Fig. II.14, 20-21  
**Unclear Context**  
Byblos Unstrat. Dunand 1950, No. 13.571

### **B.4.1.3 CLASS 016c**

#### **Iron I**

Hazor IX Yadin *et al.* 1961, Pl. 209.13-14  
Hazor IX/X Yadin *et al.* 1961, Pl. 211.1-4  
Megiddo Area F level 5 (VIA) Finkelstein *et al.* 2000b, Fig. 11.4(9)  
Tel Beth Shan VI lower Yadin & Geva 1986, Fig. 33.2  
Tell Kazel Area II level 5 Badre *et al.* 1994, Fig. 31.b, e  
\* Tell Kazel Area II level 5 Badre *et al.* 1994, Fig. 31.d  
Tyre XI Bikai 1978b, Pl. 29.14

#### **Iron I-II**

Megiddo VA-IVB Lamon & Shipton 1939, Fig. 21.123  
Megiddo Area K level 2 (VA-IVB) Finkelstein *et al.* 2000b, Fig. 11.21(7)

#### **Iron II**

\* Hazor VIII Yadin *et al.* 1960, Pl. 59.7  
Tel Beth Shan IV James 1966, Fig. 39.7  
Tel Rehov Area C/E level 1 A. Mazar 1999a, Fig. 24.13  
Tell Keisan 6 Briend & Humbert 1980, Pl. 48.4-5  
Tyre IX Bikai 1978b, Pl. 21.12  
Tyre Al-Bass cem. II Núñez 2004a, Fig. 68.1

### **B.4.2 CLASS 017**

#### **Iron I**

Hazor IX Yadin *et al.* 1961, Pl. 179.16

#### **Iron I-II**

Tel Dan IV Biran 1982, Fig. 26.3-4

#### **Iron II**

Hazor V Yadin *et al.* 1958, Pl. 68.3-4  
Hazor V Yadin *et al.* 1958, Pl. 84.17  
Hazor V Yadin *et al.* 1960, Pl. 89.3  
Hazor VI Yadin *et al.* 1960, Pl. 71.14  
Hazor VIII Yadin *et al.* 1960, Pl. 60.1, 3-8  
Megiddo IVA Lamon & Shipton 1939, Fig. 15.76  
Megiddo Area H level 3 (IVA) Finkelstein *et al.* 2000b, Fig. 11.47(7-12)  
Tel Dan II Pakman 1992, Fig. 3.7  
Tel Dan II Biran 1994, Fig. 168.5-6  
Tel Dan II Biran 1999, Fig. 7.14-15  
Tel Dan III Biran 1994, Fig. 124.1  
Tel Rehov Area C/E level 1 A. Mazar 1999a, Fig. 24.12

#### **Iron III**

Megiddo II/III Lamon & Shipton 1939, Fig. 15.76-77

#### **Persian**

Tell Sukas F Buhl 1983, Pl. II.30

#### **Unclear Context**

Tel Dan Unstrat. Biran 1994, Fig. 165.1

### **B.4.3 CLASS 018**

#### **Iron I**

Hazor X Yadin *et al.* 1961, Pl. 172.10-14  
Megiddo VB Lamon & Shipton 1939, Fig. 20.119  
Tell Sukas South Harbour Buhl 1996, Fig. 21.IIB

Tyre XII Bikai 1978b, Pl. 31.19

**Iron I-II**

Megiddo VA-IVB Lamon & Shipton 1939, Fig. 20.119

Tel Dan IV Biran 1982, Fig. 26.1, 4-5

Tell el Ghassil Area I level 4 Baramki 1964, Fig. 3.3

Tell Sukas H Buhl 1983, Fig. III.36

**Iron II**

Hazor VII Yadin *et al.* 1961, Pl. 216.6-7

Joya S. V. Chapman 1972, Fig. 21.215

Ras al-Bassit Cem. Courbin 1993a, Fig. 5.3(C516)

Tel Dan II Pakman 1992, Fig. 3.4

Tel Jezreel Findgroup A Zimhoni 1997a, Fig. 1.7 (24)

Tell Arqa 10 Unpublished

\* Tell Arqa 10 Unpublished

Tell Arqa 10AB Thalmann 1983, Fig. 2e-f

\* Tell Arqa 10AB Chaaya 2000, Fig. 2.9

Tell Arqa 10AB Unpublished

Tell Arqa 10CD Unpublished

\* Tell Arqa Tomb 1 Thalmann 1978b, Fig. 23.1-2

Tell el Ghassil Area I level 1 Baramki 1964, Fig. 16.1

Tell el Ghassil Area I level 2 Joukowsky 1972, Pl. 3.14

Tell el Ghassil Area I level 3 Baramki 1961, Fig. 9.2

Tell el Ghassil Area I level 3 Baramki 1964, Fig. 2.3

Tell Kazel Area I levels 9-10 Badre *et al.* 1994, Fig. 19

Tell Keisan 7 Briend & Humbert 1980, Pl. 50.7-8

Tyre II Bikai 1978b, Pl. 4.1

Tyre IV Bikai 1978b, Pl. 14.13, 16

Tyre V Bikai 1978b, Pl. 18.14

Tyre VIII Bikai 1978b, Pl. 21.5

Tyre IX Bikai 1978b, Pl. 21.13

**Iron II-III**

Al Mina VIII Woolley 1938b, Fig. 26.2

Al Mina IX/VIII see Lehmann 1996, 431 (Form 380)

Tel Dan I Pakman 1992, Fig. 6.2

Tyre I Bikai 1978b, Pl. 1.14

**Iron III**

Al Mina V Woolley 1938b, Fig. 26.2

Al Mina VII Woolley 1938b, Fig. 26.2

Tell Keisan 4 Briend & Humbert 1980, Pl. 25.6

\*\* Tell Keisan 5 Briend & Humbert 1980, Pl. 47.9

**Persian**

Al Mina IV Woolley 1938b, Fig. 26.2

Beirut Bey 010 Persian Elayi & Sayegh 2000, Fig. 42

Beirut Bey 010 Persian Elayi & Sayegh 2000, Pls 42-46

Beirut Bey 010 Persian Bettles 2003a, 88

Hazor II Yadin *et al.* 1958, Pl. 83.1

Hazor II Yadin *et al.* 1961, Pl. 257.27

Sarepta Area Y level B Anderson 1988, Pl. 38.24

Tell Keisan 2 Briend & Humbert 1980, Pls 7.7; 8.1-4, 6-7

Tell Keisan 3 Briend & Humbert 1980, Pl. 18.1

Tell Sukas E Buhl 1983, Fig. III.34-35

Tell Sukas E Buhl 1983, Fig. IV.38

Tell Sukas F Buhl 1983, Pl. III.37

**Unclear Context**

Byblos Unstrat. Dunand 1950, No. 7.910

Byblos Unstrat. Homsy 2003, Pl. 9b

Sarepta Area X unstrat. Pritchard 1988, Fig. 43.1, 9-10

Tell Rachidiah Tomb II Doumet-Serhal 2004b, Fig. 2

Tell Rachidiah Tomb V Doumet 1982, Pl. XXII.1

## B.4.4 CLASS 019

### Iron I

- \* Hazor IX/X Yadin *et al.* 1960, Pl. 52.21
- Megiddo VB Lamon & Shipton 1939, Fig. 20.120
- # Megiddo Area K level 3 (VB) Finkelstein *et al.* 2000b, Fig. 11.19(15)

### Iron I-II

- Megiddo VA-IVB Lamon & Shipton 1939, Fig. 20.120-121
- Megiddo Tombs Guy 1938, Pl. 75.12

### Iron II

- Hazor VI Yadin *et al.* 1961, Pl. 186.14
- \*\* Hazor VIII Yadin *et al.* 1960, Pl. 59.4
- \* Megiddo IVA Lamon & Shipton 1939, Fig. 11.48-49
- Ras al-Bassit Cem. Courbin 1993a, Fig. 5.5(C542)
- \*\* Ras al-Bassit Cem. Courbin 1993a, Fig. 11.1(C519)
- \* Ras al-Bassit Cem. Courbin 1993a, Fig. 11.3-4(C128)
- \* Tell Arqa 10 Unpublished
- Tell Arqa 10 Unpublished
- \*\* Tell Arqa 10AB Chaaya 2000, Fig. 2.7
- Tell el Ghassil Area I level 2 Baramki 1964, Fig. 35.1
- Tell el Ghassil Area I level 2 Joukowsky 1972, Pl. 4.1
- Tell el Ghassil Area III level 2 Joukowsky 1972, Pl. 20.1
- \*\* Tell Kazel Area I levels 6-13 Badre & Gubel 1999-2000, Fig. 5.a
- \*\* Tell Rachidiah Tomb I Doumet-Serhal 2004b, Fig. 3
- Tyre II Bikai 1978b, Pl. 7.1
- # Tyre II Bikai 1978b, Pl. 7.2
- \*\* Tyre III Bikai 1978b, Pl. 7.3

### Iron II-III

- Al Mina \*\* VIII Woolley 1937, Pl. 13.1
- Ras al-Bassit Cem. Courbin 1993a, Fig. 5.6(C524)

### Persian

- Tell Keisan 2 Briend & Humbert 1980, Pl. 7.6
- \* Tell Sukas E Buhl 1983, Fig. III.33

### Unclear Context

- \*\* Al Mina Unstrat. du Plat Taylor 1959, Fig. 3.11
- Athlit Cremation cem.. Johns 1938, Fig. 7.2
- Byblos Unstrat. Homsey 2003, Pl. 10d
- \* Sarepta Area X unstrat. Pritchard 1988, Fig. 43.4
- \*\* Tell Abu Hawam III Hamilton 1935, 24, No. 97
- Tell Mishrife Unstrat. du Mesnil du Buisson 1927, Pl. 75.40

## B.4.5 CLASS 020

### Iron I

- Hazor IX/X Unpublished
- Sarepta Area Y level G Anderson 1988, Pl. 27.7
- \* Tell Keisan 9a/b Briend & Humbert 1980, Pl. 57.8

### Iron II

- Tel Jezreel Findgroup B Zimhoni 1997b, Fig. 2.9 (3)
- Tell el Ghassil Area III level 1 Joukowsky 1972, Pl. 16.12
- Tyre III Bikai 1978b, Pl. 7.7

### Iron III

- Al Mina V Woolley 1938b, Fig. 26.6
- Sarepta Tomb 26 Culican 1970, Fig. 3.6

### Persian

- Al Mina III Woolley 1938b, Fig. 26.6
- Al Mina III see Woolley 1938b, 137
- Tell Keisan 3 Briend & Humbert 1980, Pl. 18.11

### Unclear Context

- Byblos Unstrat. Dunand 1950, No. 9.037

## B.4.6 CLASS 021

### Iron I

- Megiddo VIA Loud 1948, Fig. 77.4
- Megiddo VIA Harrison 2004b, Pl. 13.2, 7
- Tel Beth Shan V lower James 1966, Fig. 62.3-5
- Tell Abu Hawam V/IV Hamilton 1935, 48, No. 296
- Tell Kazel Area II level 6 Badre *et al.* 1994, Fig. 45.b
- \* Tell Keisan 9c Briand & Humbert 1980, Pl. 69.6
- Tell Sukas South Harbour Buhl 1996, Fig. 22

### Iron I-II

- \* Byblos Necropolis K Salles 1980, Pl. 26.7
- Tel Beth Shan V James 1966, Figs 5.11, 6.16-17, 19

### Iron I-III

- \* Akhziv East Cem XXXVI Dayagi-Mendels 2002, Fig. 4.27(78)

### Iron II

- Joya S. V. Chapman 1972, Fig. 22.219
- Khalde Tomb 2 Saidah 1966, No. 5
- Tell el Ghassil Area I level 3 Baramki 1961, Fig. 3.1
- Tell el Ghassil Area I level 3 Joukowsky 1972, Pl. 6.2
- Tell Kazel Iron II Dunand *et al.* 1964, Pl. 10.2

### Iron II-III

- Akhziv East Cem XXIX Culican 1975-1976, Fig. A.x

### Unclear Context

- Byblos Unstrat. Homsy 2003, Pl. 11e
- Khalde Unstrat. Chehab 1983, Pl. XX.1

## B.4.7 CLASS 022

### Iron I

- \*\* Beirut Bey 003 LB/Iron Badre 2001-2002, Fig. 14.6
- \* Hazor XI Yadin *et al.* 1961, Pl. 203.16
- Hazor XII Yadin *et al.* 1961, Pl. 169.1-2
- Megiddo VB Lamon & Shipton 1939, Fig. 20.121
- Megiddo VIA Loud 1948, Fig. 77.3
- \* Megiddo VIA Harrison 2004b, Pl. 13.5
- Tel Beth Shan V lower James 1966, Fig. 62.6-7
- Tel Beth Shan VI James 1966, Figs 49.1; 54.16
- \* Tel Beth Shan VI James 1966, Fig. 50.9, 20
- \* Tel Beth Shan VI James 1966, Fig. 51.4, 13
- \* Tel Beth Shan VI lower Yadin & Geva 1986, Fig. 27.11
- Tel Beth Shan VI lower Yadin & Geva 1986, Fig. 32.2-3
- \* Tel Beth Shan VI lower Yadin & Geva 1986, Fig. 32.5
- Tel Beth Shan Area S level 2 A. Mazar 1993b, Fig. 14.8
- \*\* Tel Dan VI Biran 1989a, Fig. 4.10
- \*\* Tel Dan VI Biran 1994, Fig. 87.7
- Tell Kazel Area II level 5 Capet 2003, Fig. 43.h
- \* Tell Kazel Area II level 6 Badre *et al.* 1994, Fig. 42.a
- \*\* Tell Kazel Area II level 6 Badre *et al.* 1994, Fig. 44.a

### Iron I-II

- \* Byblos Necropolis K Salles 1980, Pl. 25.6
- \* Megiddo VA-IVB Lamon & Shipton 1939, Fig. 22.130
- Tel Beth Shan V James 1966, Figs 5.6; 6.18
- Tell el Ghassil Area I level 4 Joukowsky 1972, Pl. 10.1
- Tell el Ghassil Area III level 4 Joukowsky 1972, Pl. 27.3
- Tell Sukas H Buhl 1983, Pl. II.15

## **Iron II**

- \* Hazor IV Yadin *et al.* 1960, Pl. 101.2
- Hazor IV Yadin *et al.* 1960, Pl. 101.8
- Hazor V Yadin *et al.* 1960, Pl. 90.8, 10
- \*\* Hazor V Yadin *et al.* 1961, Pl. 221.9
- Hazor VI Yadin *et al.* 1960, Pl. 71.5-6
- Hazor VI Yadin *et al.* 1961, Pl. 216.15
- Hazor VI Yadin *et al.* 1961, Pl. 250.8
- Megiddo Area H level 3 (IVA) Finkelstein *et al.* 2000b, Figs 11.46(10, 12); 47(3, 6)
- \* Tel Beth Shan IV James 1966, Fig. 70.2
- \* Tel Jezreel Findgroup A Zimhoni 1997a, Fig. 1.7 (18)
- Tell el Ghassil Area I level 1 Baramki 1964, Fig. 15.1

## **Persian**

- Tell Sukas South Harbour cem. Buhl 1983, 9

## **B.4.8 CLASS 023**

### **Iron II**

- Hazor V Yadin *et al.* 1960, Pl. 79.26
- Hazor VII Yadin *et al.* 1961, Pl. 218.1

### **Iron II-III**

- Beirut Bey 003 storage room Badre 1997b, Fig. 44.2

### **Iron III**

- Al Mina V Woolley 1938b, Fig. 26.5
- Tell Arqa 9 Chaaya 2000, Fig. 3a

### **Persian**

- Al Mina III see Woolley 1938b, 140, 143
- Al Mina III Woolley 1938b, Fig. 26.5
- Al Mina IV Woolley 1938b, Fig. 26.5
- Hazor II Yadin *et al.* 1958, Pl. 81.2
- Megiddo I Lamon & Shipton 1939, Fig. 14.73
- Tell Keisan 2 Briend & Humbert 1980, Pl. 7.1, 8
- Tell Keisan 3 Briend & Humbert 1980, Pl. 18.2-4, 8-9

### **Unclear Context**

- Byblos Unstrat. Homsy 2003, Pl. 9a, c-d
- Nayrab Unstrat. Carriere & Barrois 1927, Fig. 1.J21

## **B.4.9 CLASS 024**

### **B.4.9.1 CLASS 024a**

#### **Iron II**

- Hazor IV Yadin *et al.* 1960, Pl. 101.9
- Hazor VI Yadin *et al.* 1960, Pl. 73.4
- Hazor VI Yadin *et al.* 1961, Pl. 186.15, 18
- Hazor VII Yadin *et al.* 1961, Pl. 180.19
- Tel Beth Shan IV James 1966, Fig. 70.7
- Tel Beth Shan IV James 1966, Fig. 72.10
- Tyre II Bikai 1978b, Pls 2.6, 8; 3.7-8

#### **Iron I-III**

- Akhziv South Cem I Dayagi-Mendels 2002, 6 (17-18)
- Akhziv South Cem I Dayagi-Mendels 2002, 10 (9)
- Akhziv South Cem I Dayagi-Mendels 2002, Fig. 3.1(16, 19)

#### **Iron II-III**

- Akhziv South Cem XXI Dayagi-Mendels 2002, 36 (2)
- Akhziv TC2 E. Mazar 2001, Fig. 20b.9
- Beirut Bey 003 storage room Badre 1997b, Fig. 44.4-5
- Tel Dan I Pakman 1992, Fig. 6.3



Sarepta Area Y level C Anderson 1988, Pl. 37.11, 13

#### **Iron III**

Megiddo II/III Lamon & Shipton 1939, Fig. 16.79-80

Tell Keisan 4 Briend & Humbert 1980, Pl. 25.1, 4-5, 7-8

Tell Keisan 4 Briend & Humbert 1980, Pl. 27.1-7

Tell Keisan 5 Briend & Humbert 1980, Pl. 47.1-3

#### **Iron II-Persian**

Akhziv South Cem III Dayagi-Mendels 2002, Fig. 3.4(5)

Akhziv South Cem 69 E. Mazar 2001, Fig. 60.4-5

#### **Persian**

Athlit Tomb 12 Johns 1932, 65, Fig. 3b

Athlit Tomb 16 Johns 1932, Fig. 16l, n

Athlit Tomb 20 Johns 1932, 70, Fig. 3b

Athlit Tomb 21 Johns 1932, 73, Fig. 3b

Athlit Tomb 21b Johns 1932, 78, Fig. 3b

Athlit Tomb 22 Johns 1932, 83, Fig. 3b

Athlit Tomb 23 Johns 1932, 84, 88, Fig. 3b

Athlit Tomb 24 Johns 1932, 95-96, Fig. 3b

Athlit Tomb 34 Johns 1932, 100, Fig. 3b

Athlit Tomb 35 Johns 1932, 101, Fig. 3b

Megiddo I Lamon & Shipton 1939, Fig. 16.79-80

#### **Unclear Context**

Byblos Unstrat. Dunand 1950, No. 11.120

Byblos Unstrat. Dunand 1950, No. 12.540

Tell Rachidiah Unstrat. Macridi-Bey 1904a, Pl. 6.19

### **B.4.9.2 CLASS 024b**

#### **Iron I-II**

Akhziv TC4 E. Mazar 2001, Fig. 8.1

#### **Iron II**

Hazor IV Yadin *et al.* 1960, Pl. 101.10, 12-15

Hazor IV Yadin *et al.* 1961, Pl. 255.23

Hazor V Yadin *et al.* 1958, Pl. 57.11

Hazor V Yadin *et al.* 1960, Pl. 79.24-25

Hazor V Yadin *et al.* 1960, Pls 90.1-7; 91.1-13

Hazor V Yadin *et al.* 1961, Pl. 229.9-13

Hazor V Yadin *et al.* 1961, Pl. 253.1

Hazor V Ben Tor *et al.* 1997, Figs III.43 (7); 46 (1)

Hazor VI Yadin *et al.* 1960, Pl. 72.1-9; 73.1-3, 5-16

Hazor VI Yadin *et al.* 1961, Pl. 186.11-12

Hazor VI Ben Tor *et al.* 1997, Fig. II.55 (5)

Hazor VI Ben Tor *et al.* 1997, Fig. III.37 (11)

Hazor VI Ben Tor *et al.* 1997, Fig. III.40 (5)

Hazor VII Yadin *et al.* 1961, Pl. 180.20

Hazor VII Yadin *et al.* 1961, Pl. 216.9

Megiddo IVA Lamon & Shipton 1939, Figs 14.72; 16.81

Megiddo Area H level 3 (IVA) Finkelstein *et al.* 2000b, Figs 11.47(4); 53(13)

Sarepta Area Y level D Anderson 1988, Pl. 32.7

Tel Beth Shan IV James 1966, Fig. 37.7

Tel Beth Shan IV James 1966, Fig. 70.1, 3

Tel Dan II Pakman 1992, Fig. 3.1-2

Tel Dan II Biran 1994, Fig. 168.2

Tell el Ghassil Area I level 3 Joukowsky 1972, Pl. 6.9-10

Tyre II Bikai 1978b, Pls 2.1-7; 3.4-6; 4.3-5

#### **Iron II-III**

Akhziv TC2 E. Mazar 2001, Fig. 20b.6, 18

Beirut Bey 003 abandonment Badre 1997b, Fig. 37.1-2

Beirut Bey 003 storage room Badre 1997b, Fig. 44.3, 6

Sarepta Area Y level C Anderson 1988, Pl. 37.12

Tyre I Bikai 1978b, Pl. 1.16

#### **Iron III**

Megiddo II/III Lamon & Shipton 1939, Fig. 14.72

Ras al-Bassit Cem. Courbin 1993a, Fig. 5.4(C1882)

Ras al-Bassit Cem. Courbin 1993a, Fig. 10.2(C1878), 3(C1880)

Ras al-Bassit Cem. Courbin 1993a, Fig. 10.4(C6964)

Tell Ahmar Area C level 2 Jamieson 1999, Fig. 8.6

Tell Arqa 9 Thalmann 1983, Fig. 2i, l

Tell Arqa 9 Chaaya 2000, Fig. 3b

Tell Arqa 9 Unpublished

#### **Iron II-Persian**

Akhziv South Cem 70 E. Mazar 2001, Fig. 62.3-4

#### **Persian**

Athlit Tomb 12 Johns 1932, 65, Fig. 3d

Athlit Tomb 16 Johns 1932, Fig. 16k

Athlit Tomb 20 Johns 1932, 70, Fig. 3d

Athlit Tomb 21 Johns 1932, 73, Fig. 3d

Athlit Tomb 21b Johns 1932, 78, Fig. 3d

Athlit Tomb 22 Johns 1932, 83, Fig. 3d

Athlit Tomb 23 Johns 1932, 84, 88-89, Fig. 3d

Athlit Tomb 24 Johns 1932, 95-96, Fig. 3d

Athlit Tomb 34 Johns 1932, 100, Fig. 3d

Athlit Tomb 35 Johns 1932, 101, Fig. 3d

Megiddo I Lamon & Shipton 1939, Fig. 17.83

Ras al-Bassit Cem. Courbin 1993a, Fig. 10.1(C1818)

Tell Shiyuk Fawqani Area F (X) Makinson 2005, Pl. 35.230

#### **Unclear Context**

Byblos Unstrat. Dunand 1950, No. 9.384

Byblos Unstrat. Homsy 2003, Pl. 10b

Khalde Unstrat. see Lehmann 1996, 434 (Form 385)

Sarepta Area X unstrat. Pritchard 1988, Fig. 43.2

## **B.4.10 CLASS 025**

#### **Iron II-III**

Akhziv East Cem XI Dayagi-Mendels 2002, 56 (1)

Akhziv East Cem XVII Dayagi-Mendels 2002, 66 (8)

Akhziv East Cem XXXVI Dayagi-Mendels 2002, 91 (11)

Akhziv East Cem XLV Dayagi-Mendels 2002, 106 (XLV.1)

#### **Iron III**

Akhziv East Cem XXIV Dayagi-Mendels 2002, 72 (1)

Tell Keisan 4 Briend & Humbert 1980, Pl. 27.8

#### **Iron II-Persian**

Akhziv East Cem VI Dayagi-Mendels 2002, Fig. 4.5(4)

Akhziv East Cem VIII Dayagi-Mendels 2002, 46 (4)

Akhziv East Cem VIII Dayagi-Mendels 2002, Fig. 4.6(3)

Akhziv East Cem XII Dayagi-Mendels 2002, 57 (2)

Akhziv South Cem 72 E. Mazar 2001, Fig. 64.20

#### **Iron III-Persian**

Akhziv East Cem X Dayagi-Mendels 2002, 54 (3)

Akhziv East Cem X Dayagi-Mendels 2002, Fig. 4.8(1-2)

Akhziv East Cem XIII Dayagi-Mendels 2002, 58 (1)

Akhziv East Cem XLI Dayagi-Mendels 2002, Fig. 4.29(1)

Akhziv East Cem XLII Dayagi-Mendels 2002, 106 (1-2)

Akhziv East Cem XLVI Dayagi-Mendels 2002, 107 (3)

Akhziv East Cem LIII Dayagi-Mendels 2002, 109 (LIII.1)

Akhziv Tomb N4 E. Mazar 2004, Fig. 3.2

#### **Persian**

Athlit Tomb 12 Johns 1932, 65, Fig. 3c  
 Athlit Tomb 16 Johns 1932, Fig. 16m  
 Athlit Tomb 20 Johns 1932, 70, Fig. 3c  
 Athlit Tomb 21 Johns 1932, 73, Fig. 3c  
 Athlit Tomb 21b Johns 1932, 78, Fig. 3c  
 Athlit Tomb 22 Johns 1932, 83, Fig. 3c  
 Athlit Tomb 23 Johns 1932, 84, 88, Fig. 3c  
 Athlit Tomb 24 Johns 1932, 95-96, Fig. 3c  
 Athlit Tomb 34 Johns 1932, 100, Fig. 3c  
 Athlit Tomb 35 Johns 1932, 101, Fig. 3c  
 Beirut Bey 010 Persian Jabak *et al.* 1998, 36; 37  
 Beirut Bey 010 Persian Bettles 2003a  
 Tell Abu Hawam II Hamilton 1934, Pl. 23.14  
 Tell Abu Hawam II Hamilton 1935, Fig. 3  
 Tell Keisan 2 Briend & Humbert 1980, Pl. 7.3-5  
 Tell Keisan I Seton-Williams 1980, Pl. 108.11-12  
 Tell Sukas G Buhl 1983, Fig. IV.44  
**Unclear Context**  
 Al Mina Unstrat. Woolley 1938b, Fig. 26.7  
 Byblos Unstrat. Dunand 1950, No. 18.743  
 Byblos Unstrat. Homsy 2003, Pl. 10c

## **B.4.11 CLASS 026**

### **Iron I**

Megiddo Area K level 3 (VB) Finkelstein *et al.* 2000b, Fig. 11.19(18)  
 Megiddo VIA Harrison 2004b, Pl. 11.3  
 Megiddo Tombs Guy 1938, Pl. 73.7  
 Tel Beth Shan V lower James 1966, Fig. 60.6  
 Tell Keisan 9a/b Briend & Humbert 1980, Pls 59.2-6; 601-4  
 Tyre XIII Bikai 1978b, Pl. 35.12-13

### **Iron I-II**

Byblos Necropolis K Salles 1980, Pl. 27.9  
 Tel Beth Shan V James 1966, Fig. 19.17

### **Iron II**

Hazor IV Yadin *et al.* 1960, Pl. 101.11  
 Tel Beth Shan IV James 1966, Fig. 72.11  
 Tel Beth Shan V upper James 1966, Fig. 65.1  
 Tel Jezreel Findgroup B Zimhoni 1997b, Fig. 2.9 (5)  
 Tell Kazel Area I levels 6-13 Badre & Gubel 1999-2000, Fig. 5.b  
 Tell Keisan 6 Briend & Humbert 1980, Pl. 48.1  
 Tyre II Bikai 1978b, Pls 3.1-3; 4.2  
 Tyre IX Bikai 1978b, Pl. 21.1, 11

### **Iron II-III**

Akhziv TC2 E. Mazar 2001, Fig. 20a.1-2  
 Beirut Bey 003 storage room Badre 1997b, Fig. 41.1-7  
 Beirut Bey 003 storage room Badre 1997b, Fig. 42.1-5  
 Tel Dan I Pakman 1992, Fig. 6.5

### **Iron III**

Ras al-Bassit Cem. Courbin 1993a, Fig. 10.7(CC5753)  
 Tell Keisan 4 Briend & Humbert 1980, Pls 25.2-3; 26.1-9; 27.9  
 Tell Keisan 5 Briend & Humbert 1980, Pl. 47.4  
 Tell Sukas G3 Buhl 1983, Fig. II.16  
 Tell Tayinat Building phase 4 see Lehmann 1996, 436 (Form 390, 392)

### **Iron II-Persian**

Akhziv East Cem VI Dayagi-Mendels 2002, 45 (3)  
 Akhziv East Cem VI Dayagi-Mendels 2002, Fig. 4.5(2)

### **Iron III-Persian**

Akhziv South Cem III Dayagi-Mendels 2002, Fig. 3.4(4)

Akhziv Tomb N4 E. Mazar 2004, Fig. 3.1

**Persian**

Tell Sukas F Buhl 1983, Fig. I.4

Tell Sukas G Buhl 1983, Fig. I.5

Tell Sukas G Buhl 1983, Fig. I.10

Tell Sukas G Buhl 1983, Fig. II.19

**Unclear Context**

Byblos Unstrat. Dunand 1950, No. 9.014

Byblos Unstrat. Dunand 1950, No. 11.119

Byblos Unstrat. Homsy 2003, Pl. 10a

Khalde Unstrat. see Lehmann 1996, 436 (Form 390)

Sarepta Area X unstrat. Pritchard 1988, Fig. 43.3, 5, 8, 11

Tell Tayinat Unstrat. Unpublished

## **B.4.12 CLASS 027**

**Iron II-III**

Beirut Bey 003 storage room Badre 1997b, Fig. 42.6

Beirut Bey 003 storage room Badre 1998, Fig. 9.2

**Iron III**

Tel Dan I Pakman 1992, Fig. 6.7

Tell Arqa 9 Thalmann 1990, 54 n. 9

Tell Judeideh III see Lehmann 1996, 444 (Form 421)

Tell Kazel Area II level 3 Badre *et al.* 1994, Fig. 23.a

Tell Keisan 4 Briend & Humbert 1980, Pls 23.1-6; 24.1-7

**Iron III-Persian**

Tell Sukas G Buhl 1983, Fig. V.56

**Persian**

Al Mina III Woolley 1938b, Fig. 26.1

Al Mina III see Woolley 1938b, 143

Athlit Tomb 16 Johns 1932, 60, Fig. 4f

Athlit Tomb 21b Johns 1932, 78-79, Fig. 4f

Athlit Tomb 24 Johns 1932, 95-96, Fig. 4f

Athlit Tomb 35 Johns 1932, 101, Fig. 4f

Megiddo I Lamon & Shipton 1939, Fig. 12.63-64

Sidon Persian Doumet-Serhal 2006, Fig. 18.27-29

Tell Abu Hawam II Hamilton 1934, Pl. 23.12-13

Tell Kazel Area I level 4 Dunand & Saliby 1957, 11.

Tell Kazel Area I level 4 Badre *et al.* 1994, Fig. 8.e

Tell Kazel Area I level 4 Badre & Gubel 1999-2000, Fig. 3.e-f

Tell Sukas E Buhl 1983, Figs V.62; VI.63

Tell Sukas F Buhl 1983, Figs V.56-59, 61; VI.64-68; VII.69-71, 75, 78-79

Tell Sukas South Harbour cem. Riis 1979, Figs 26, 28-31, 48, 52

Tell Sukas South Harbour Sanctuary Riis 1979, Figs 118-119, 145, 148, 155, 159-162, 171, 189-191

**Unclear Context**

Byblos Unstrat. Dunand 1939b, Nos 56.3, 56.5

Byblos Unstrat. Dunand 1950, Nos 12.681-682

Byblos Unstrat. Homsy 2003, Pls 1a-b, 2a-b

Sidon Unstrat. Contenau 1920, Fig. 16a

## **B.4.13 CLASS 028**

**Iron II**

Hazor IV Yadin *et al.* 1960, Pl. 100.32

Hazor V Yadin *et al.* 1961, Pl. 189.24

Tel Beth Shan IV James 1966, Fig. 72.12

Tell Abou Danne IId/A6 Lebeau 1983, Pl. 97.1

Tell Qarqur 8 Dornemann 2003a, Fig. 30

Tell Qarqur 8 Unpublished

Tell Tayinat Iron II Unpublished

**Iron II-III**

Tell Shiyuk Fawqani Area F (IX) Makinson 2005, Pl. 23.146-148

**Iron III**

Al Mina VI see Lehmann 1996, 437 (Form 388-92)

Megiddo II/III Lamon & Shipton 1939, Fig. 16.82

Tell Abou Danne IIc/A5 Lebeau 1983, Pl. 132.1

Tell Ahmar Area C level 2 Jamieson 2000, Fig. 15.1, 3, 5-8

Tell Ahmar Area C level 2 Jamieson 2005, Fig. 4.28.8-10

Tell Arqa 9 Thalmann 1983, Fig. 2g

Tell Judeideh III see Lehmann 1996, 443 (Form 418)

Tell Judeideh III see Lehmann 1996, 443 (Form 420)

**Persian**

Al Mina II see Woolley 1938b, 134

Al Mina III see Woolley 1938b, 137

Al Mina III Woolley 1938b, Fig. 26.3

Al Mina III Lehmann 1996, Pl. 78 (420/3)

Athlit Tomb 23 Johns 1932, 84, 88, Fig. 3e

Athlit Tomb 24 Johns 1932, 98, Fig. 3e

Hazor II Yadin *et al.* 1958, Pl. 81.1, 3-4

Hazor II Yadin *et al.* 1958, Pl. 83.3

Tell Kazel Area I level 4 Gubel 1990a, Fig. 23.1, a

Tell Kazel Area I level 4 Gubel 1990b, Fig. 2a-b

Tell Sukas F Buhl 1983, Fig. IV.47-48

Tell Sukas F Buhl 1983, Pl. III.46

Tell Sukas G Buhl 1983, Fig. IV.47-48

Tell Sukas G Buhl 1983, Pl. III.46

**Unclear Context**

Byblos Unstrat. Dunand 1950, No. 11.291

Byblos Unstrat. Dunand 1950, Nos 12.679-680

Byblos Unstrat. Dunand 1950, No. 13.186

Byblos Unstrat. Homsy 2003, Pl. 8a-d

Nayrab Unstrat. Carriere & Barrois 1927, Fig. 1.B-C

Nayrab Unstrat. Carriere & Barrois 1927, Fig. 1.J17-J18, J23

Nayrab Unstrat. Abel & Barrois 1928, Pl. 54c-d

Tell Judeideh Unstrat. see Lehmann 1996, 443 (Form 420)

Tell Mishrife Unstrat. du Mesnil du Buisson 1927, Pl. 75.32

Tell Nebi Mend Unstrat. Pezard 1931, Pl. 23.3.2

Tell Rifa'at Unstrat. Lehmann 1996, Pl. 78 (420/4)

## **B.4.14 CLASS 029**

**Iron I**

\* Tell Kazel Area I levels 14-16 Badre & Gubel 1999-2000, Fig. 6.a

Tell Keisan 9a/b Briend & Humbert 1980, Pl. 57.3

**Iron I-II**

\* Megiddo VA-IVB Lamon & Shipton 1939, Fig. 19.114

# Megiddo VA-IVB Lamon & Shipton 1939, Fig. 22.131

**Iron II**

\*\* Hazor V Yadin *et al.* 1961, Pl. 228.13

\*\* Hazor VI Yadin *et al.* 1960, Pl. 71.7

\* Hazor VI Ben Tor *et al.* 1997, Fig. III.39 (28)

**Iron III**

\* Megiddo II/III Lamon & Shipton 1939, Fig. 9.24

Megiddo II/III Lamon & Shipton 1939, Fig. 14.71

\*\* Tel Dan I Pakman 1992, Fig. 5.5

Tel Dan I Pakman 1992, Fig. 5.7

**Persian**

Megiddo I Lamon & Shipton 1939, Fig. 9.23  
Megiddo I Lamon & Shipton 1939, Fig. 14.71  
**Unclear Context**  
\*\* Sidon Unstrat. Culican 1975, Fig. 4b

## **B.4.15 CLASS 030**

### **Iron II**

Hazor VI Yadin *et al.* 1961, Pl. 219.22

### **Iron II-Persian**

Akhziv East Cem XII Dayagi-Mendels 2002, Fig. 4.10(11)

### **Iron III**

Akhziv East Cem XXIV Dayagi-Mendels 2002, Fig. 4.18(2)

### **Iron III-Persian**

Akhziv Tomb N4 E. Mazar 2004, Fig. 5.3

### **Unclear Context**

Byblos Unstrat. Culican 1970, Fig. 1D.2

Byblos Unstrat. Homsy 2003, Pl. 3b

\* Byblos Unstrat. Homsy 2003, Pl. 11b

Byblos Unstrat. Homsy 2003, Pl. 11c-d

## **B.5 PITHOI**

### **B.5.1 CLASS 031**

#### **Iron I**

Hazor XII Yadin *et al.* 1961, Pl. 167.8, 10

Tel Dan V Biran 1989a, Fig. 4.7.8

Tel Dan VI Biran 1989a, Fig. 4.12.6

Tel Dan VI Biran 1989a, Fig. 4.16.9

Tell el Ghassil Area I level 5 Joukowsky 1972, Pl. 13.1-2

Tell el Ghassil Area I level 5 Joukowsky 1972, Pl. 14

Tell Keisan 9a/b Briend & Humbert 1980, Pl. 57.1

#### **Iron I-II**

Tell el Ghassil Area III level 4 Joukowsky 1972, Pl. 27.23-25

#### **Iron II**

Tell el Ghassil Area I level 1 Joukowsky 1972, Pl. 1.16

Tell el Ghassil Area III level 1 Joukowsky 1972, Pl. 16.8

### **B.5.2 CLASS 032**

#### **Iron I**

Tel Dan V Biran 1989a, Fig. 4.7.9

Tyre XIV Bikai 1978b, Pl. 40

### **B.5.3 CLASS 033**

#### **Iron II**

Tell Abou Danne IId/A6 Lebeau 1983, Pls 78.1-3; 79.1-3

Tell Rifa'at 2b-c see Lehmann 1996, 429 (Form 364)

#### **Iron III**

Tell Ahmar Area C level 2 Jamieson 1999, Fig. 9

Tell Ahmar Area D Iron III Jamieson 2005, Fig. 31.1

Tell Judeideh III see Lehmann 1996, 429 (Form 364)

#### **Unclear Context**

Nayrab Unstrat. Carriere & Barrois 1927, Fig. 1.J29

Nayrab Unstrat. Abel & Barrois 1928, Pl. 54a  
Jerablus Unstrat. Woolley 1921a, Fig. 53 right

### **B.5.4 CLASS 034**

#### **Iron I**

Hazor Iron I Ben Ami 2001, Fig. 7.12-13  
Megiddo VB Lamon & Shipton 1939, Fig. 21.126  
Megiddo VIA Harrison 2004b, Pl. 12.1-2  
Tel Dan V Biran 1989a, Fig. 4.1  
Tel Dan VI Biran 1989a, Fig. 4.23.1-4  
Tell Keisan 9c Briend & Humbert 1980, Pl. 68.1-3

#### **Iron II**

Tel Beth Shan V upper James 1966, Fig. 64.12

#### **Iron III**

Megiddo II/III Lamon & Shipton 1939, Fig. 17.86

### **B.5.5 CLASS 035**

#### **Iron I**

Tell Afis Area E1 level 9c Venturi 1998a, Fig. 11.1-4  
Tell el Ghassil Area I level 5 Joukowsky 1972, Pl. 13.13  
Tell Kazel Area II level 6 Badre 1990b, Fig. 44.a  
Tell Kazel Area IV level 5 Badre & Gubel 1999-2000, Fig. 41.e  
Tille Höyük Sondage level 10 Summers 1993, Fig. 50.1  
Tille Höyük Sondage level 10 Summers 1993, Fig. 53.3  
Tille Höyük Sondage level 10 Summers 1993, Fig. 55.1-3

#### **Iron I-II**

Tel Dan IV Biran 1994, Fig. 128.1-2

#### **Iron II**

Tell Kazel Area I level 9 Gubel 1990a, Fig. 30.e

#### **Unclear Context**

Tel Dan Unstrat. Biran 1994, Fig. 138

### **B.5.6 CLASS 036**

#### **Iron I**

Hama F2 Riis & Buhl 1990, 129 (Form IC1)  
Hama Cem. I Riis 1948, Fig. 33  
Tell Afis Area E1 level 9c Venturi 2000c, Fig. 6.2-3  
Tell Kazel Area II level 5 Capet 2003, Figs 43.i; 49.b  
Tell Kazel Area II level 5 Capet 2003, Fig. 48.a  
Tell Kazel Area II level 6 Capet 2003, Fig. 25.c  
Tell Kazel Area IV level 5 Badre & Gubel 1999-2000, Fig. 37.j-k, m

#### **Iron II**

Tell Kazel Area II level 4 Capet 2003, Fig. 51.a

#### **Iron III**

Zincirli Iron III Andrae 1943, Pl. 28d-e  
Zincirli Iron III Andrae 1943, Pl. 30c; Fig. 66

### **B.5.7 CLASS 037**

#### **B.5.7.1 CLASS 037a**

##### **Iron I**

Ain Dara Lower Mound Iron I Stone & Zimansky 1999, Fig. 81.1

Tell Afis Area E1 level 4 Mazzoni 1998a, Fig. 23.1, 6  
 Tell Afis Area E1 level 5 Mazzoni 1998a, Fig. 21.1-2  
 Tell Afis Area E1 level 6 Mazzoni 1998a, Fig. 21.5-6, 8  
 Tell Afis Area E1 level 6 Venturi 2000a, Fig. 12.16, 19  
 Tell Afis Area E1 level 7 Mazzoni 1998a, Fig. 17.7-9  
 Tell Afis Area E1 level 9a Venturi 1998a, Fig. 10.4-6  
 Tell Afis Area E1 level 9b Venturi 2000a, Fig. 6.17-18  
 Tell Afis Area E1 level 9c Pedrazzi 2002, Fig. 24.3  
 Tell Afis Area E2 level 4 Degli Esposti 1998, Fig. 13.7, 10  
 Tell Afis Area Ge level 4 Cecchini 1998, Fig. 14.14-15  
 Tell Afis Area Ge level 5 Cecchini 1998, Fig. 17.1  
 Tell Mastuma Central Area level I-3 Egami & Masuda 1984, Pl. 8.3, 9  
 Tell Qarqur 9 Unpublished  
 Tille Höyük Sondage level 10 Summers 1993, Fig. 50.2  
**Iron II**  
 Tell Afis Area E1 level 2 Mazzoni 1998a, Fig. 26.5  
 Tell Afis Area Ge level 2 Cecchini 1998, Fig. 17.2-3  
 Tell Mastuma South Area Wada 1994, Fig. 4.6, 17-19  
 Tell Mishrife Iron II Unpublished  
 Tell Sheikh Hassan 3 Schneider 1999a, Fig. 12.21(1)  
**Iron III**  
 Tell Ahmar Area C level 2 Jamieson 2005, Fig. 4.12.5  
 Tell Shiyuk Fawqani Area G level 2 Luciani 2005, Pl. 25.291-292  
**Unclear Context**  
 Tell Afis Area N unstrat. Cecchini 2005, Fig. 63.11

### **B.5.7.2 CLASS 037b**

#### **Iron I**

Hama F1 Riis & Buhl 1990, 129 (Pithoi)  
 Tell Afis Area E1 level 3 Mazzoni 1990a, Fig. 6  
 Tell Afis Area E1 level 3 Mazzoni 1998a, Fig. 23.2, 5  
 Tell Afis Area E1 level 4 Mazzoni 1990a, Fig. 6  
 Tell Afis Area E1 level 4 Mazzoni 1998a, Fig. 23.3-4  
 Tell Afis Area E1 level 5 Mazzoni 1990a, Fig. 6  
 Tell Afis Area E1 level 5 Mazzoni 1998a, Fig. 21.3  
 Tell Afis Area E1 level 6 Mazzoni 1990a, Fig. 6  
 Tell Afis Area E1 level 6 Mazzoni 1998a, Fig. 21.3, 7  
 Tell Afis Area E1 level 7 Mazzoni 1998a, Fig. 17.6  
 Tell Afis Area E1 level 8 Venturi 1998a, Fig. 10.1-3  
 Tell Afis Area E1 level 8 Venturi 1998a, Fig. 12.18  
 Tell Afis Area E1 level 9a Venturi 2000a, Fig. 8.14-15  
 Tell Afis Area E1 level 9b Venturi 2000a, Fig. 6.15  
 Tell Afis Area E2 level 4 Degli Esposti 1998, Fig. 13.4, 6, 8-9  
 Tell Afis Area E4 (Afis VII) Chiti 2005, Fig. 50.7  
 Tell Afis Area Ge level 3 Cecchini 1998, Fig. 15.11, 13  
 Tell Mastuma Central Area level I-3 Egami & Masuda 1984, Pl. 8.2, 4, 13-14  
 Tell Mastuma Central Area level I-3 Wakita *et al.* 1995, Fig. 7.9  
 Tell Qarqur 9 Unpublished

#### **Iron I-II**

Ain Dara Lower Mound Stone & Zimansky 1999, Fig. 75  
 Tel Dan IV Biran 1982, Fig. 27.7  
 Tell Mishrife Iron I/II Unpublished

#### **Iron II**

Ain Dara Lower Mound Iron II Stone & Zimansky 1999, Fig. 10.4  
 Ain Dara Lower Mound Iron II Stone & Zimansky 1999, Fig. 79.2, 4  
 Chatal Höyük III Haines 1971, Pl. 4d  
 Hama E Fugmann 1958, Fig. 245 (Salle N15)  
 Hama E Fugmann 1958, Fig. 269 (6B580, 6B612, 7A606)  
 Hama E Riis & Buhl 1990, Fig. 62 (418)



Hama E1 Riis & Buhl 1990, 137 (415-416), Fig. 61 (415)  
 Hama E1 Riis & Buhl 1990, 129 (Pithoi)  
 Hama E2 Riis & Buhl 1990, 129 (Pithoi)  
 Hazor VIII Yadin *et al.* 1958, Pl. 47.25, 27  
 Tell Abou Danne IId/A6 Lebeau 1983, Pls 81.1-4; 82  
 Tell Afis Area B (Afis VIII) Scigliuzzo 2002, Figs 12.11; 13.10-11  
 Tell Afis Area B (Afis VIII) Virgilio 2005, Fig. 35.9  
 Tell Afis Area D level 3 Mazzoni 1988a, Fig. 14.17-19  
 Tell Afis Area D level 3 Cecchini 1988, Fig. 9.5-6  
 Tell Afis Area D level 3 Cecchini 1988, Fig. 10.1-2  
 Tell Afis Area D level 4 Mazzoni 1988a, Fig. 19.11, 14, 16, 18  
 Tell Afis Area D level 4 Cecchini 1988, Figs 10.3-6; 11.1-6  
 Tell Afis Area D level 5 Mazzoni 1988a, Fig. 20.18-20  
 Tell Afis Area D level 6 Mazzoni 1988a, Fig. 23.1-6  
 Tell Afis Area E1 level 1 Mazzoni 1992b, Fig. 15.1  
 Tell Afis Area E1 level 2 Mazzoni 1990a, Fig. 6  
 Tell Afis Area E1 level 2 Mazzoni 1998a, Fig. 26.1-4  
 Tell Afis Area E2 level 1 Degli Esposti 1998, Fig. 13.5  
 Tell Afis Area E2 level 2 Degli Esposti 1998, Fig. 13.1, 3  
 Tell Afis Area Gc level 8a Cecchini 1998, Fig. 19.22  
 Tell Afis Area Ge level 1 Cecchini 1998, Fig. 16.18  
 Tell Afis Area Ge level 2 Cecchini 1998, Fig. 16.7  
 Tell el Ghassil Area I level 1 Baramki 1964, Fig. 23.1  
 Tell el Ghassil Area III level 1 Joukowsky 1972, Pl. 16.7  
 Tell Mastuma Central Area level I-1 Egami & Masuda 1984, Pl. 8.10-11, 16-18  
 Tell Mastuma Central Area level I-1 Egami 1988, Pl. 18.J1-J2  
 Tell Mastuma Central Area level I-1 Wakita *et al.* 1995, Fig. 14.1  
 Tell Mastuma Central Area level I-1 Wakita *et al.* 1995, Pls 2.1; 2.2  
 Tell Mastuma Central Area level I-2 Egami & Masuda 1984, Pl. 7.10  
 Tell Mastuma Central Area level I-2 Egami & Masuda 1984, Pl. 8.1, 5-8, 12, 19  
 Tell Mastuma Central Area level I-2 Egami 1988, Pl. 19.J3-J10  
 Tell Mastuma Central Area level I-2 Wakita *et al.* 1995, Fig. 7.10  
 Tell Mastuma South Area Wada 1994, Fig. 4.8-13  
 Tell Mastuma South Area Wada 1994, Fig. 5.1-10, 21-22  
 Tell Mishrife Operation C level II al Maqdissi 2003, Fig. 13  
 Tell Mishrife Operation C level II al Maqdissi & Badawi 2002, Fig. 17.2-4  
 Tell Nebi Mend Trench V Level B Unpublished  
 Tell Nebi Mend Trench V Level C Unpublished  
 Tell Qarqur 8 Unpublished  
 Tell Rifa'at 2b-c Matthers 1981b, Fig. 233.10-11  
 Tell Rifa'at 2b-c see Lehmann 1996, 428 (Form 363)

**Iron II-III**

Tell Judeideh IV/III Lehmann 1996, Pl. 67 (371/1)  
 Tell Shiyuk Fawqani Area F (IX) Makinson 2005, Pl. 14.82

**Iron III**

Tel Dan I Pakman 1992, Fig. 7.1; Biran 1994, Fig. 223.2  
 Tell Abou Danne IIc/A5 Lebeau 1983, Pl. 135.3-4  
 Tell Afis Area D level 1 Cecchini 1988, Fig. 9.1-2  
 Tell Afis Area D level 1 Mazzoni 1988a, Fig. 8.17-18  
 Tell Afis Area D level 2 Mazzoni 1988a, Fig. 13.1-9  
 Tell Afis Area D level 2 Cecchini 1988, Fig. 9.3-4  
 Tell Afis Area Gc level 2 Cecchini 1998, Fig. 36.24  
 Tell Afis Area Gc level 4 Cecchini 1998, Fig. 32.23  
 Tell Ahmar Area C level 2 Jamieson 1999, Fig. 9  
 Tell Judeideh III see Lehmann 1996, 428 (Form 363)  
 Tell Shiyuk Fawqani Area G level 2 Luciani 2005, Pl. 25.293

**Unclear Context**

Jerablus Yunus cem. Woolley 1939b, Pl. 25.Bath D  
 Nayrab Unstrat. Carriere & Barrois 1927, Fig. 1.J2, J25-J26  
 Nayrab Unstrat. Abel & Barrois 1928, Fig. 7

Nayrab Unstrat. Abel & Barrois 1928, Pl. 54b  
Tell Judeideh Unstrat. see Lehmann 1996, 428 (Form 363)  
Tell Mishrife Operation J Morandi Bonacossi 2002, Fig. 113.11-13  
Tell Mishrife Unstrat. du Mesnil du Buisson 1926, Figs 19.1-5; 20  
Tell Mishrife Unstrat. du Mesnil du Buisson 1935, Fig. 47.165, 175  
Tell Nebi Mend Unstrat. Pezard 1931, Pl. 22.4  
Tell Nebi Mend Unstrat. Pezard 1931, Pl. 23.3.1  
Tell Nebi Mend Unstrat. Pezard 1931, Pl. 40.1.3

## **B.6 KRATERS**

### **B.6.1 CLASS 038**

#### **B.6.1.1 CLASS 038a**

##### **Iron I**

# Megiddo VB Lamon & Shipton 1939, Fig. 29.110  
Megiddo VB Lamon & Shipton 1939, Fig. 31.153-154  
Megiddo VB Lamon & Shipton 1939, Fig. 32.161-163  
Megiddo VIA Loud 1948, Fig. 78.14  
# Megiddo VIA Loud 1948, Fig. 78.15  
Megiddo VIA Harrison 2004b, Pl. 5.11, 13, 15  
Megiddo Area F level 5 (VIA) Finkelstein *et al.* 2000b, Fig. 11.2(6-7)  
Megiddo Tombs Guy 1938, Pls 68.12; 71.6-16; 73.1-2, 12-13; 74.16  
Pella Area III level I McNicoll *et al.* 1992, Pl. 52.9  
Pella Area VIII level 8 McNicoll *et al.* 1992, Pl. 64.8  
Pella Iron I Unpublished  
# Sarepta Area Y level F Anderson 1988, Pl. 30.7  
Tel Beth Shan VI James 1966, Fig. 53.22  
Tel Beth Shan VI James 1966, Fig. 54.2  
Tel Beth Shan VI upper Yadin & Geva 1986, Fig. 11.4  
Tel Beth Shan VI lower Yadin & Geva 1986, Fig. 23.2-3  
Tel Beth Shan Area S level 2 A. Mazar 1993b, Fig. 14.1  
Tel Dan V Biran 1989a, Fig. 4.7.3  
Tel Dan V Biran 1994, Fig. 98.9  
Tel Dan VI Biran 1989a, Fig. 4.12.2  
Tell Keisan 9a/b Briend & Humbert 1980, Pl. 64.1  
Tell Keisan 9c Briend & Humbert 1980, Pl. 78.2-2b, 2j-n  
Tell Keisan 9c Briend & Humbert 1980, Pl. 79.2  
Tell Keisan 11/10 Briend & Humbert 1980, Pl. 81.11  
Tyre XIII Bikai 1978b, Pl. 35.7

##### **Iron I-II**

Megiddo VA-IVB Lamon & Shipton 1939, Fig. 31.154  
Pella Area III level O McNicoll *et al.* 1992, Pl. 67.3  
Tel Beth Shan V James 1966, Figs 19.8; 23.3  
Tel Beth Shan V James 1966, Fig. 22.19  
Tel Beth Shan V James 1966, Fig. 7.7-8

##### **Iron II**

Megiddo IVA Lamon & Shipton 1939, Fig. 28.89  
Pella Area VIII level 6 McNicoll *et al.* 1992, Pl. 66.2  
# Tel Jezreel Findgroup B Zimhoni 1997b, Fig. 2.8 (7)  
# Tel Jezreel Findgroup D Zimhoni 1997a, Fig. 1.2 (17)  
# Tel Jezreel Findgroup D Zimhoni 1997a, Fig. 1.3 (12)

#### **B.6.1.2 CLASS 038b**

##### **Iron I**

Megiddo Area K level 3 (VB) Finkelstein *et al.* 2000b, Fig. 11.18(13-15)  
Pella Area III level I McNicoll *et al.* 1992, Pl. 51.1  
Pella Iron I Unpublished  
Tel Beth Shan VI James 1966, Figs 52.17; 55.9  
Tel Beth Shan VI lower Yadin & Geva 1986, Fig. 23.4  
Tell Keisan 9a/b Briend & Humbert 1980, Pl. 64.3  
\*\* Tell Keisan 9c Briend & Humbert 1980, Pl. 78.10  
Tell Keisan 11/10 Briend & Humbert 1980, Pl. 81.12  
**Iron I-II**  
# Megiddo VA-IVB Loud 1948, Fig. 89.14  
Megiddo Area K level 2 (VA-IVB) Finkelstein *et al.* 2000b, Fig. 11.20(9)  
**Iron II**  
Tel Beth Shan IV James 1966, Fig. 39.9  
Tell Keisan 6 Briend & Humbert 1980, Pl. 49.7

## **B.6.2 CLASS 039**

### **Iron I**

Hazor IX/X Unpublished  
Tel Beth Shan VI James 1966, Fig. 57.7  
Tel Beth Shan VI lower Yadin & Geva 1986, Fig. 33.4  
Tel Dan V Biran 1994, Fig. 98.8  
Tel Dan VI Biran 1989a, Fig. 4.18.4, 10

### **Iron II**

\*\* Tell Keisan 7 Briend & Humbert 1980, Pl. 53.8  
#\* Hazor VI Yadin *et al.* 1961, Pl. 184.3

## **B.6.3 CLASS 040**

### **B.6.3.1 CLASS 040a**

#### **Iron I**

Hama Cem. I Riis 1948, Fig. 56  
\* Hama Cem. I Riis 1948, Fig. 58  
Hama Cem. I Riis 1948, Fig. 61  
Hama Cem. II Riis 1948, Fig. 56  
\* Hama Cem. II Riis 1948, Fig. 58  
Hama Cem. II Riis 1948, Fig. 61  
Hama F Fugmann 1958, Fig. 165 (4B931)  
\* Hama F2 Riis & Buhl 1990, 129 (Form XIC1)  
Hazor X Yadin *et al.* 1961, Pl. 207.6  
Hazor Iron I Ben Ami 2001, Fig. 5.18  
Megiddo VIA Loud 1948, Fig. 78.17  
\* Megiddo VIA Loud 1948, Fig. 78.18-19  
\*\* Megiddo VIA Loud 1948, Fig. 79.2  
\*\* Megiddo VIB Harrison 2004b, Pl. 3.1  
\* Megiddo Tombs Guy 1938, Pls 69.9; 70.12; 73.3  
Megiddo Tombs Guy 1938, Pl. 70.13-15  
Megiddo Tombs Guy 1938, Pl. 71.1  
Tel Beth Shan VI James 1966, Fig. 52.13  
\* Tel Beth Shan VI James 1966, Fig. 55.4, 6  
Tel Beth Shan VI upper Yadin & Geva 1986, Fig. 11.2  
Tel Dan V Biran 1989b, Fig. 22.3  
\* Tell Afis Area E1 level 7 Venturi 2000a, Fig. 11.11  
Tell Afis Area E1 level 9a Venturi 1998a, Fig. 6.2  
Tell Afis Area E1 level 9a Venturi 2000a, Fig. 9.8-9  
\*\* Tell Kazel Area II level 5 Capet & Gubel 2000, Fig. 12  
\* Tell Kazel Area II level 5 Capet & Gubel 2000, Fig. 13

\*\* Tell Kazel Area II level 5 Capet 2003, Fig. 37.c  
Tell Kazel Area II level 6 Badre 1990b, Fig. 43.c  
Tell Kazel Area II level 6 Badre *et al.* 1994, Fig. 48.f  
Tell Kazel Area II level 6 Badre *et al.* 1994, Fig. 49.b  
Tell Kazel Area IV level 5 Badre & Gubel 1999-2000, Fig. 37.b  
\* Tille Höyük I-III Blaylock 1999, Fig. 1.16-17

#### **Iron I-II**

# Megiddo VA-IVB Lamon & Shipton 1939, Fig. 29.112  
\* Tell el Ghassil Area I level 4 Baramki 1961, Fig. 5.3  
Tell el Ghassil Area I level 4 Baramki 1961, Fig. 6.3

#### **Iron II**

\*\* Chatal Höyük III Swift 1958, Fig. 38  
\* Hama Cem. IV Riis 1948, Fig. 58  
# Hama E Fugmann 1958, Fig. 216 (6B581)  
\* Hama E Fugmann 1958, Fig. 310 (7B17)  
\*\* Hama E Riis & Buhl 1990, Fig. 64 (432)  
Hama E Riis & Buhl 1990, Fig. 64 (433)  
\* Hama E1 Riis & Buhl 1990, 129 (Form XIC1)  
Hama E1 Riis & Buhl 1990, 129 (Form XIE1)  
\* Hazor VII Yadin *et al.* 1958, Pl. 50.3  
Hazor VIII Yadin *et al.* 1960, Pl. 56.3  
Tell el Ghassil Area I level 3 Baramki 1961, Fig. 10.1  
Tell Judeideh IV see Lehmann 1996, 396 (Form 194)  
Tell Keisan 7 Briend & Humbert 1980, Pl. 52.9, 12  
Tell Mastuma Central Area level I-2 Egami 1988, Pl. 18.1  
Tell Mastuma South Area Wada 1994, Fig. 2.2  
Tell Sheikh Hassan 3 Schneider 1999a, Fig. 3.3  
Tell Sheikh Hassan 3 Schneider 1999a, Fig. 8.13(1-2)  
Tell Shiyuk Fawqani Area H Bachelot 1999, Fig. 14

### **B.6.3.2 CLASS 040b**

#### **Iron I**

Megiddo VIA Loud 1948, Fig. 79.3  
Megiddo Tombs Guy 1938, Pls 8.10; 68.3; 70.17  
\* Megiddo Tombs Guy 1938, Pl. 68.16  
Tell Afis Area E2 level 3 Degli Esposti 1998, Fig. 7.12

#### **Iron I-II**

Megiddo Area K level 2 (VA-IVB) Finkelstein *et al.* 2000b, Fig. 11.20(12)

#### **Iron II**

\*\* Hazor VI Yadin *et al.* 1960, Pl. 68.8  
\* Tell el Ghassil Area I level 3 Joukowsky 1972, Pl. 5.15  
Tell Shiyuk Fawqani Area H Al-Bahloul *et al.* 2005, Pl. 5a

#### **Persian**

Tell Shiyuk Fawqani Area G level 1 Luciani 2005, Pl. 55.636

#### **Unclear Context**

Jerablus Yunus cem. Woolley 1939b, Pl. 22.K15

### **B.6.3.3 CLASS 040c**

#### **Iron I**

Hama Cem. I Riis 1948, Fig. 57  
Tell Kazel Area II level 5 Badre *et al.* 1994, Fig. 35.d

#### **Iron II**

Hama E1 Riis & Buhl 1990, 129 (Form XIB)  
\* Tell Mastuma South Area Wada 1994, Fig. 2.3  
Tyre Al-Bass cem. II Núñez 2004a, Fig. 102.1

#### **Iron II-III**

Tyre Al-Bass cem. Unstrat. Núñez 2004a, Fig. 118.P2.2

## **B.6.4 CLASS 041**

### **B.6.4.1 CLASS 041a**

#### **Iron I**

- Tell Kazel Area II level 5 Capet 2003, Fig. 45.a-b
- Tell Kazel Area IV level 5 Badre & Gubel 1999-2000, Fig. 41.b
- Tille Höyük Sondage level 10 Summers 1993, Fig. 48.2
- Tille Höyük Sondage level 10 Summers 1993, Fig. 51.6

#### **Unclear Context**

- Tell Mishrife Unstrat. du Mesnil du Buisson 1927, Pl. 69.19

### **B.6.4.2 CLASS 041b**

#### **Iron I**

- Tell Kazel Area IV level 5 Badre & Gubel 1999-2000, Fig. 37.1
- Tille Höyük I-III Blaylock 1999, Fig. 2.8
- Tille Höyük Sondage level 10 Summers 1993, Fig. 51.4-5

#### **Iron II**

- Tille Höyük VIII Blaylock 1999, Fig. 6.1-3, 6

## **B.6.5 CLASS 042**

#### **Iron I**

- \* Hama Cem. I Riis 1948, Fig. 59
- \* Hama Cem. II Riis 1948, Fig. 59
- \* Hama F1 Riis & Buhl 1990, 129 (Form XIC2)
- \* Hama F2 Riis & Buhl 1990, 129 (Form XIC2)
- \* Khalde Cem. IV Saidah 1966, No. 47
- Megiddo Area F level 5 (VIA) Finkelstein *et al.* 2000b, Fig. 11.2(8)
- Megiddo Tombs Guy 1938, Pl. 69.5
- \*\* Ras Ibn Hani Iron I Badre 1983, Fig. 1f
- \* Ras Ibn Hani Iron I Badre 1983, Fig. 2c
- \*\* Ras Ibn Hani Iron I Badre 1983, Fig. 2d
- \* Tel Beth Shan VI lower Yadin & Geva 1986, Fig. 24
- \*\* Tell Afis Area E1 level 7 Mazzone 1998a, Fig. 16.8
- Tell Afis Area Ge level 3 Cecchini 1998, Fig. 14.22
- \*\* Tell Kazel Area II level 5 Capet 2003, Fig. 44.a
- Tell Kazel Area II level 5 Capet 2003, Fig. 44.c
- Tell Kazel Area II level 6 Capet 2003, Fig. 17.a
- \*\* Tell Kazel Area IV level 4 Badre & Gubel 1999-2000, Fig. 44.b
- \* Tell Kazel Area IV level 5 Badre & Gubel 1999-2000, Fig. 31.j
- Tell Kazel Area IV level 5 Badre & Gubel 1999-2000, Fig. 31.k
- Tell Kazel Area IV level 5 Badre & Gubel 1999-2000, Fig. 39.g
- Tell Kazel Iron I Dunand *et al.* 1964, Pl. 12.4

#### **Iron I-II**

- \* Byblos Necropolis K Salles 1980, Pl. 26.1
- \* Megiddo VA-IVB Lamon & Shipton 1939, Fig. 22.127
- \*\* Megiddo VA-IVB Loud 1948, Fig. 89.7
- \* Tel Beth Shan V James 1966, Fig. 22.26
- # Tell Sukas H Buhl 1983, Fig. VIII.80
- Tell Sukas H Lund 1986, Fig. 28

#### **Iron II**

- \* Hama Cem. III Riis 1948, Fig. 59
- \* Hama E1 Riis & Buhl 1990, 129 (Form XIC2)
- \* Hama E2 Riis & Buhl 1990, 129 (Form XIC2)

- # Hazor VII Ben Tor *et al.* 1997, Fig. III.33 (22)  
 Joya S. V. Chapman 1972, Fig. 18.209-211  
 \* Joya S. V. Chapman 1972, Fig. 19.212-213  
 \*\* Joya S. V. Chapman 1972, Fig. 20.214  
 \*\* Khalde Tomb 3 Saidah 1966, No. 7  
 \*\* Khalde Tomb 121 Saidah 1966, Nos 17, 20  
 Khirbet Silm S. V. Chapman 1972, Figs 18.80; 19.81  
 \*\* Ras al-Bassit Cem. Courbin 1993a, Fig. 13.4(C545)  
 \*\* Tambourit Saidah 1977, No. 10  
 \* Tel Beth Shan V upper James 1966, Fig. 64.11  
 Tell el Ghassil Area I level 3 Baramki 1964, Fig. 7.3  
 Tell Kazel Area II level 4 Badre *et al.* 1994, Fig. 28.e  
 Tell Keisan 6 Briend & Humbert 1980, Pl. 49.1  
 \* Tell Rachidiah Tomb I Chehab 1983, Pl. XXII.1  
 \*\* Tell Rachidiah Tomb I Doumet-Serhal 2004b, Figs 5-6  
 \*\* Tell Rachidiah Tomb I Doumet-Serhal 2004b, Fig. 11  
 \*\* Tell Rachidiah Tomb I Doumet-Serhal 2004b, Fig. 15  
 \*\* Tell Rachidiah Tomb IV Doumet 1982, Pl. I.3  
 \* Tell Rachidiah Tomb IV Doumet 1982, Pl. I.4  
 \* Tell Rachidiah Tomb IV Doumet 1982, Pl. II.16  
 \*\* Tell Rachidiah Tomb IV Doumet 1982, Pl. II.38, 41  
 \*\* Tell Rachidiah Tomb IV Doumet 1982, Pl. III.53-54  
 \* Tell Rachidiah Tomb IV Doumet 1982, Pl. IV.62  
 \*\* Tell Rachidiah Tomb IV Doumet 1982, Pl. IV.124  
 \* Tell Rachidiah Tomb IV Doumet 1982, Pl. V.2  
 \* Tell Rachidiah Tomb IV Doumet 1982, Pl. VI.12  
 \*\* Tell Rachidiah Tomb IV Doumet 1982, Pl. VI.17  
 \* Tell Rachidiah Tomb IV Doumet 1982, Pl. VII.18  
 \*\* Tell Rachidiah Tomb IV Doumet 1982, Pl. VII.22  
 \* Tell Rachidiah Tomb IV Doumet 1982, Pl. VIII.37/45  
 \*\* Tell Rachidiah Tomb IV Doumet 1982, Pl. VIII.48  
 \* Tell Rachidiah Tomb IV Doumet 1982, Pl. IX.49  
 \* Tell Rachidiah Tomb IV Griffiths 2003, 58 (Jar 16)  
 \*\* Tell Rachidiah Tomb IV Griffiths 2003, 59 (Jar 17)  
 \*\* Tell Rachidiah Tomb IV Bordreuil 2004, Fig. 2  
 \* Tell Rachidiah Tomb IV Bordreuil 2004, Fig. 3  
 Tyre III Bikai 1978b, Pl. 7.8  
 \* Tyre Al-Bass cem. II Núñez 2004a, Fig. 81.1  
 \* Tyre Al-Bass cem. II Núñez 2004a, Fig. 93.1  
 \* Tyre Al-Bass cem. II Núñez 2004a, Fig. 94.1  
 \* Tyre Al-Bass cem. II Núñez 2004a, Fig. 100.1  
 \* Tyre Al-Bass cem. II Núñez 2004a, Fig. 101.1  
 \* Tyre Al-Bass cem. III Núñez 2004a, Fig. 56.1  
 \*\* Tyre Al-Bass cem. III Núñez 2004a, Fig. 89.1  
 \*\* Tyre Al-Bass cem. III Núñez 2004a, Fig. 95.1  
 \* Tyre Al-Bass cem. III Núñez 2004a, Fig. 96.1  
 \* Tyre Al-Bass cem. III Núñez 2004a, Fig. 106.1  
 \* Tyre Al-Bass cem. III Núñez 2004a, Fig. 107.1
- Iron I-III**  
 Akhziv East Cem XVII Dayagi-Mendels 2002, 66 (7)
- Iron II-III**  
 \* Beirut Bey 003 abandonment Badre 1997b, Fig. 37.9  
 \* Ras al-Bassit Cem. Courbin 1993a, Fig. 14.2(C507)  
 \*\* Ras al-Bassit Cem. Courbin 1993a, Fig. 14.3(C528)  
 Tell Shiyuk Fawqani Area F (IX) Makinson 2005, Pl. 15.92  
 \* Tyre Al-Bass cem. IV Núñez 2004a, Fig. 50.1  
 \*\* Tyre Al-Bass cem. IV Núñez 2004a, Fig. 60.1  
 Tyre Al-Bass cem. IV Núñez 2004a, Fig. 62.1  
 \*\* Tyre Al-Bass cem. IV Núñez 2004a, Fig. 63.1  
 \* Tyre Al-Bass cem. IV Núñez 2004a, Fig. 64.1

\* Tyre Al-Bass cem. IV Núñez 2004a, Fig. 67.1  
 \* Tyre Al-Bass cem. IV Núñez 2004a, Fig. 69.1  
 \*\* Tyre Al-Bass cem. IV Núñez 2004a, Fig. 72.1  
 Tyre Al-Bass cem. IV Núñez 2004a, Fig. 75.1  
 \* Tyre Al-Bass cem. IV Núñez 2004a, Fig. 77.1  
 Tyre Al-Bass cem. IV Núñez 2004a, Fig. 78.1  
 Tyre Al-Bass cem. IV Núñez 2004a, Fig. 82.1  
 \* Tyre Al-Bass cem. IV Núñez 2004a, Fig. 83.1  
 \*\* Tyre Al-Bass cem. IV Núñez 2004a, Fig. 83.5  
 \*\* Tyre Al-Bass cem. IV Núñez 2004a, Fig. 84.1  
 \*\* Tyre Al-Bass cem. IV Núñez 2004a, Fig. 86.1  
 \*\* Tyre Al-Bass cem. IV Núñez 2004a, Fig. 87.1  
 \* Tyre Al-Bass cem. IV Núñez 2004a, Fig. 92.1  
 \* Tyre Al-Bass cem. IV Núñez 2004a, Fig. 103.1  
 \* Tyre Al-Bass cem. IV Núñez 2004a, Fig. 104.1  
 Tyre Al-Bass cem. IV Núñez 2004a, Fig. 109.1  
 \*\* Tyre Al-Bass cem. IV Núñez 2004a, Fig. 109.2, 5  
 \* Tyre Al-Bass cem. IV Núñez 2004a, Fig. 109.4  
 \*\* Tyre Al-Bass cem. IV/V Núñez 2004a, Fig. 61.1  
 \*\* Tyre Al-Bass cem. Unstrat. Seeden 1991, Figs 1-2, 7-8  
 \*\* Tyre Al-Bass cem. Unstrat. Seeden 1991, Figs 3-6  
 \*\* Tyre Al-Bass cem. Unstrat. Seeden 1991, Figs 9-10  
 \*\* Tyre Al-Bass cem. Unstrat. Seeden 1991, Figs 11-12  
 \* Tyre Al-Bass cem. Unstrat. Seeden 1991, Figs 15-16  
 \*\* Tyre Al-Bass cem. Unstrat. Seeden 1991, Figs 17-18  
 \* Tyre Al-Bass cem. Unstrat. Aubet 2004a, Fig. 8a  
 Tyre Al-Bass cem. Unstrat. Núñez 2004a, Fig. 91.1  
 \* Tyre Al-Bass cem. Unstrat. Núñez 2004a, Fig. 111.P9  
 Tyre Al-Bass cem. Unstrat. Núñez 2004a, Fig. 111.P27  
 \* Tyre Al-Bass cem. Unstrat. Núñez 2004a, Fig. 113.P5.2  
 \* Tyre Al-Bass cem. Unstrat. Núñez 2004a, Fig. 113.P20  
 \* Tyre Al-Bass cem. Unstrat. Núñez 2004a, Fig. 116.P10.2

### **Iron III**

\* Al Mina VII du Plat Taylor 1959, Fig. 3.13  
 \* Al Mina VIII-V du Plat Taylor 1959, Fig. 3.13  
 \*\* Ras al-Bassit Cem. Courbin 1993a, Fig. 14.1(C1081)  
 \*\* Ras al-Bassit Cem. Courbin 1993a, Fig. 14.4(C1070)  
 \*\* Ras al-Bassit Cem. Courbin 1993a, Fig. 14.5(C5752)  
 \*\* Ras al-Bassit Cem. Courbin 1993a, Fig. 15.1(C523)  
 \* Tell Keisan 4 Briend & Humbert 1980, Pl. 28.9  
 Tell Keisan 5 Briend & Humbert 1980, Pl. 44.1  
 \* Tyre Al-Bass cem. V Núñez 2004a, Fig. 57.1  
 \*\* Tyre Al-Bass cem. V Núñez 2004a, Fig. 58.1  
 \*\* Tyre Al-Bass cem. V Núñez 2004a, Fig. 90.1

### **Iron II-Persian**

# Akhziv South Cem III Dayagi-Mendels 2002, Fig. 3.4(3)

### **Iron III-Persian**

Akhziv East Cem XLVI Dayagi-Mendels 2002, Fig. 4.31(1)  
 \* Akhziv East Cem XLVI Dayagi-Mendels 2002, Fig. 4.31(2)  
 Akhziv Tomb N4 E. Mazar 2004, Fig. 4.2

### **Persian**

Beirut Bey 010 Persian Sapin & Sayegh 1998, 110(84-85)  
 # Tell Sukas E Buhl 1983, Fig. VIII.82  
 \* Tell Sukas E Buhl 1983, Fig. XVI.280  
 \*\* Tell Sukas E Buhl 1983, Fig. XVI.281  
 # Tell Sukas F Buhl 1983, Fig. VIII.82

### **Unclear Context**

\*\* Akhziv Unstrat. Culican 1982, Pl. 7a  
 Jerablus Yunus cem. Woolley 1939b, Pl. 22.K4  
 Khalde Unstrat. Chehab 1983, Pl. XX.1

- \*\* Qasmieh Iron Age S. V. Chapman 1972, Fig. 32.314
- \*\* Ras al-Bassit Unstrat. Courbin 1986, Fig. 11
- Sarepta Area X unstrat. Pritchard 1988, Fig. 43.12
- Tell Abu Hawam III Hamilton 1934, Pl. 23.23
- \* Tell Rachidiah Tomb II Doumet-Serhal 2003a, Fig. 22
- \*\* Tell Rachidiah Tomb II Doumet-Serhal 2004b, Figs 4, 7, 10, 12
- \* Tell Rachidiah Tomb II Doumet-Serhal 2004b, Figs 13-14
- Tell Rachidiah Unstrat. Macridi-Bey 1904a, Pl. 6.1, 3, 13-15
- \*\* Tell Rachidiah Unstrat. Culican 1982, Pl. 11a-b
- \* Tell Rachidiah Unstrat. Doumet-Serhal 2003a, Fig. 11
- \*\* Tell Rachidiah Unstrat. Bordreuil 2004, Fig. 4
- \*\* Tell Rachidiah Unstrat. Bordreuil 2004, Fig. 7

## **B.6.6 CLASS 043**

### **Iron II-III**

Tell Judeideh IV/III see Lehmann 1996, 397 (Form 208)

### **Persian**

- Tell Sukas E Ploug 1973, No. 409
- Tell Sukas E Buhl 1983, Fig. VIII.81
- Tell Sukas F Ploug 1973, No. 409
- Tell Sukas G1 Lund 1986, Fig. 81

### **Unclear Context**

- \* Al Mina Unstrat. Woolley 1938a, Fig. 10; Lehmann 1996, Pl. 37 (208/2)
- \* Al Mina Unstrat. Lehmann 1996, Pl. 37 (208/1)
- Tell Judeideh Unstrat. see Lehmann 1996, 398 (Form 208)

## **B.6.7 CLASS 044**

### **Iron I-II**

- Byblos Necropolis K Salles 1980, Pl. 26.5
- # Tel Beth Shan V James 1966, Fig. 47.11

### **Iron II**

- \* Hazor V Ben Tor *et al.* 1997, Fig. III.46 (3)
- \* Hazor VI Ben Tor *et al.* 1997, Fig. II.54 (33)
- #\* Hazor VI Ben Tor *et al.* 1997, Fig. III.39 (27)
- Ras al-Bassit Cem. Courbin 1993a, Fig. 17.1(C539)
- Tel Beth Shan IV James 1966, Fig. 72.1
- # Tell el Ghassil Area III level 2 Joukowsky 1972, Pl. 18.43
- Tell Kazel Area II level 4 Badre *et al.* 1994, Fig. 28.f

### **Iron III**

- Megiddo II/III Lamon & Shipton 1939, Fig. 9.29
- \* Megiddo II/III Lamon & Shipton 1939, Fig. 9.30
- \* Tell Ahmar Area C level 2 Jamieson 1999, Fig. 8.7

### **Unclear Context**

- Byblos Unstrat. Lehmann 1996, Pl. 62 (361b/1)
- Byblos Unstrat. Homsy 2003, Pl. 11f
- Nayrab Unstrat. Abel & Barrois 1928, Pl. 54e
- \* Sidon Unstrat. Riis & Buhl 1990, Fig. 87

## **B.6.8 CLASS 045**

### **Iron II**

- \* Tell Rachidiah Tomb IV Doumet 1982, Pl. V.7

### **Iron II-III**

- \*\* Beirut Bey 003 storage room Badre 1997b, Fig. 45.14
- \* Tyre Al-Bass cem. IV Núñez 2004a, Fig. 51.1



- \*\* Tyre Al-Bass cem. IV Núñez 2004a, Fig. 71.1
- \* Tyre Al-Bass cem. IV Núñez 2004a, Fig. 73.1(158)
- \* Tyre Al-Bass cem. IV Núñez 2004a, Fig. 79.1
- \*\* Tyre Al-Bass cem. IV Núñez 2004a, Fig. 85.1
- \*\* Tyre Al-Bass cem. Unstrat. Núñez 2004a, Fig. 88.1
- Tyre Al-Bass cem. Unstrat. Núñez 2004a, Fig. 116.P12

#### **Iron III**

- \*\* Tell Keisan 5 Briend & Humbert 1980, Pl. 43.1
- \*\* Tyre Al-Bass cem. V Núñez 2004a, Fig. 66.1

#### **Unclear Context**

- Tell Rachidiah Tomb II Doumet-Serhal 2003a, Fig. 26

## **B.6.9 CLASS 046**

### **Iron II**

- \*\* Tell Rachidiah Tomb I Doumet-Serhal 2004b, Figs 16-18
- #\* Tyre Al-Bass cem. III Núñez 2004a, Fig. 52.1
- #\* Tyre Al-Bass cem. III Núñez 2004a, Fig. 54.1
- \*\* Tyre Al-Bass cem. III Núñez 2004a, Fig. 70.1

### **Iron II-III**

- Beirut Bey 003 storage room Badre 1998, Fig. 9.1
- \*\* Tyre Al-Bass cem. IV Núñez 2004a, Fig. 80.1
- #\* Tyre Al-Bass cem. IV Núñez 2004a, Fig. 98.1
- #\* Tyre Al-Bass cem. IV Núñez 2004a, Fig. 99.1
- \*\* Tyre Al-Bass cem. IV Núñez 2004a, Fig. 110.P12.1

### **Iron III**

- \*\* Al Mina VIII-V du Plat Taylor 1959, Fig. 3.14-15
- \*\* Tyre Al-Bass cem. V Núñez 2004a, Fig. 65.1

### **Persian**

- \* Al Mina IV Woolley 1938b, Fig. 28.24

### **Unclear Context**

- \* Tell Rachidiah Unstrat. Culican 1982, Pl. 11c

## **B.6.10 CLASS 047**

### **Iron I**

- \*\* Beirut Bey 003 glacis I Badre 1997b, Fig. 34b.13-14, 16-17
- \* Beirut Bey 003 glacis I Badre 1997b, Fig. 34b.15, 19

### **Iron II**

- Hazor V Yadin *et al.* 1960, Pl. 96.2
- \* Khalde Tomb 121 Saidah 1966, No. 18
- \*\* Tambourit Saidah 1977, Nos 4-5
- \* Tambourit Siadah 1977, No. 11

### **Iron II-III**

- \*\* Tyre Al-Bass cem. Unstrat. Seeden 1991, Figs 13-14

### **Iron II-Persian**

- #\* Akhziv South Cem III Dayagi-Mendels 2002, Fig. 3.4(6)

### **Unclear Context**

- \*\* Sarepta Area X unstrat. Pritchard 1988, Fig. 40.30
- \*\* Tell Rachidiah Unstrat. Doumet-Serhal 2003a, Fig. 4

## **B.6.11 CLASS 048**

### **B.6.11.1 CLASS 048a**

#### **Iron I**

- \* Hama Cem. I Riis 1948, Fig. 52

**Iron I-II**

# Tel Beth Shan V James 1966, Fig. 7.9

**Iron II**

# Hama E Fugmann 1958, Fig. 325 (8A51)

Megiddo IVA Lamon & Shipton 1939, Fig. 17.84

Megiddo Area H level 3 (IVA) Finkelstein *et al.* 2000b, Fig. 11.46(11)

Tell Rachidiah Tomb I Doumet-Serhal 2004b, Fig. 19

**Iron III**

Megiddo II/III Lamon & Shipton 1939, Fig. 17.84

Tell Ahmar Area C level 2 Jamieson 1999, Fig. 3.2

Tell Ahmar Area C level 2 Jamieson 2000, Fig. 5.6-9

Tell Ahmar Area C level 2 Jamieson 2000, Fig. 7.7, 9, 11

**Unclear Context**

Athlit Cremation cem. Johns 1938, Fig. 19.2

**B.6.11.2 CLASS 048b****Iron I**

\* Hazor IX/X Unpublished

# Hazor IX/X Unpublished

\*\* Ras Ibn Hani Iron I Badre 1983, Fig. 2e

Tel Dan V Biran 1989a, Fig. 4.6.9

\* Tell Afis Area E1 level 9a Venturi 2000a, Fig. 7.10

**Iron II**

\* Hama E Fugmann 1958, Fig. 269 (6B389)

# Hama E Fugmann 1958, Fig. 310 (7B19)

\*\* Hama E Fugmann 1958, Fig. 344 (4B580)

Hama E1 Riis & Buhl 1990, 129 (Form XIE2)

# Hama E1 Riis & Buhl 1990, Fig. 66 (448)

# Hazor V Yadin *et al.* 1960, Pl. 83.10-11

Hazor V Yadin *et al.* 1960, Pl. 84.1

Hazor V Yadin *et al.* 1960, Pl. 94.7

# Hazor V Yadin *et al.* 1960, Pl. 107.10

Hazor V Yadin *et al.* 1961, Pl. 227.1

Hazor V Yadin *et al.* 1961, Pl. 230.11

Hazor V Ben Tor *et al.* 1997, Fig. III.43 (1)

Hazor V Ben Tor *et al.* 1997, Fig. III.48 (7)

\* Hazor VI Yadin *et al.* 1958, Pl. 52.5

Hazor VI Yadin *et al.* 1960, Pl. 68.5-6

# Hazor VI Yadin *et al.* 1961, Pl. 183.9

Hazor VI Yadin *et al.* 1961, Pl. 186.1

Hazor VI Yadin *et al.* 1961, Pl. 219.15

Hazor VII Yadin *et al.* 1961, Pl. 215.6

# Hazor VII Yadin *et al.* 1961, Pl. 247.23

Hazor VII Yadin *et al.* 1961, Pl. 247.26

Megiddo IVA Lamon & Shipton 1939, Fig. 18.89

Tel Dan II Pakman 1992, Fig. 2.3

Tel Dan II Biran 1994, Fig. 168.1

Tell el Ghassil Area I level 1 Joukowsky 1972, Pl. 1.17

**Iron III**

Megiddo II/III Lamon & Shipton 1939, Fig. 18.90

Megiddo II/III Lamon & Shipton 1939, Fig. 28.88

Tell Ahmar Area C level 2 Jamieson 2000, Fig. 7.8, 10

Tell Ahmar Area C level 2 Jamieson 2005, Fig. 4.11.1-2

**Unclear Context**

\* Al Mina Unstrat. Lehmann 1996, Pl. 34 (194/3)

Hama Cem. Unstrat. Riis 1948, Fig. 62

\* Ras Ibn Hani Unstrat. Bounni *et al.* 1976a, Fig. 28.17

\* Tell Afis Area N unstrat. Cecchini 2005, Fig. 63.10

Tell Sheikh Hassan Unstrat. Boese 1995, 72, Fig. 9b

## **B.6.12 CLASS 049**

### **Iron I**

Megiddo VIA Loud 1948, Fig. 79.5; Harrison 2004b, Pl. 7.6

### **Iron I-II**

# Akhziv Tomb N1 E. Mazar 2004, Fig. 2.1

Byblos Necropolis K Salles 1980, Pl. 13.1

# Megiddo VA-IVB Lamon & Shipton 1939, Fig. 29.112

Tel Beth Shan V James 1966, Fig. 23.8

Tell Mishrife Iron I/II Unpublished

### **Iron II**

Hama E Fugmann 1958, Fig. 310 (7A870)

# Hama E Fugmann 1958, Fig. 310 (7B16)

Hama E Fugmann 1958, Fig. 325 (8A53)

Hama E Riis & Buhl 1990, Fig. Fig. 64 (435)

# Hazor V Yadin *et al.* 1960, Pl. 83.13

# Hazor V Yadin *et al.* 1961, Pl. 227.3-4

Hazor VI Yadin *et al.* 1960, Pl. 68.4

# Hazor VI Yadin *et al.* 1961, Pl. 183.13

Tel Beth Shan IV James 1966, Fig. 68.12-20

# Tel Beth Shan Area P level 7 A. Mazar 2001, Fig. 12.4

### **Iron II-III**

Akhziv Tomb N3 E. Mazar 2004, Fig. 16.1

### **Iron III**

Megiddo II/III Lamon & Shipton 1939, Fig. 26.73

Megiddo II/III Lamon & Shipton 1939, Fig. 27.83-84, 86

Tel Dan I Pakman 1992, Fig. 4.3

Tell Ahmar Area C level 2 Jamieson 2000, Fig. 5.1-5

### **Iron III-Persian**

Kefrik Unstrat. Moorey 1980, Fig. 23.557

### **Persian**

Megiddo I Lamon & Shipton 1939, Fig. 27.83

# Megiddo I Lamon & Shipton 1939, Fig. 27.84

## **B.6.13 CLASS 050**

### **Iron II-III**

Deve Höyük Cem. I Moorey 1980, Fig. 2.3-4

Tell Shiyuk Fawqani Area F (IX) Makinson 2005, Pl. 14.85-88

Tell Shiyuk Fawqani Area F (IX) Makinson 2005, Pl. 15.90

### **Iron III**

Tell Ahmar Area C level 2 Jamieson 1999, Fig. 7.6

### **Unclear Context**

Jerablus Yunus cem. Woolley 1939b, Pls 9.1, 4-6; 10.1-2; 13.1-8

Jerablus Yunus cem. Woolley 1939b, Pls 22.K3, K17

## **B.6.14 CLASS 051**

### **Iron II**

Hama E Fugmann 1958, Fig. 344 (H737)

### **Unclear Context**

Tell Mishrife Unstrat. du Mesnil du Buisson 1935, Fig. 46.170

## **B.6.15 CLASS 052**

### **Iron II**

Tell Sheikh Hassan 3 Schneider 1999a, Fig. 12.21(3-4)  
Tell Shiyuk Fawqani Area H Al-Bahloul *et al.* 2005, Pl. 6b  
Tell Shiyuk Fawqani Area H Al-Bahloul *et al.* 2005, Pl. 12c

### **Unclear Context**

\* Jerablus Yunus cem. Woolley 1939b, Pls 9.2-3; 10.3-4  
Jerablus Yunus cem. Woolley 1939b, Pl. 22.K2

## **B.6.16 CLASS 053**

### **B.6.16.1 CLASS 053a**

#### **Iron II-III**

Deve Höyük Cem. I Moorey 1980, Fig. 3.19

### **B.6.16.2 CLASS 053b**

#### **Iron I**

Hama Cem. I Riis 1948, Fig. 78  
Hama Cem. I Riis 1948, Fig. 79  
\* Hama F Fugmann 1958, Fig. 165 (5A503)  
Hama F1 Riis & Buhl 1990, 130 (Form XIX)  
\* Hama F1 Riis & Buhl 1990, Fig. 68 (461)  
Hama F2 Riis & Buhl 1990, 130 (Form XIX)  
\* Hama F2 Riis & Buhl 1990, Figs 67 (459); 68 (460)  
\* Tell Afis Area E1 level 3 Mazzoni 1992b, Fig. 9.5  
\*\* Tell Afis Area E1 level 7 Venturi 2000c, Fig. 9.8  
\* Tell Afis Area E1 level 8 Venturi 2002, Fig. 21.3, 5  
\* Tell Afis Area E1 level 9c Pedrazzi 2002, Fig. 23.7  
\*\* Tell Afis Area E4 (Afis VII) Chiti 2005, Fig. 49.1  
\*\* Tell Afis Area G (Iron IA) Canuti 2000, Fig. 17.3  
\* Tell Afis Area G (Iron IC) Canuti 2000, Fig. 17.6  
Tell Kazel Area II level 5 Capet 2003, Fig. 45.c  
Tell Kazel Area II level 6 Badre *et al.* 1994, Fig. 48.e  
Tell Kazel Area II level 6 Badre *et al.* 1994, Fig. 49.d  
Tell Kazel Iron I Dunand *et al.* 1964, Pl. 13.3-4  
Tille Höyük Sondage level 10 Summers 1993, Fig. 51.1  
Tille Höyük Sondage level 10 Summers 1993, Fig. 53.1-2

#### **Iron II**

Hama Cem. IV Riis 1948, Fig. 36  
\* Hama E Fugmann 1958, Fig. 188 (5B874)  
\*\* Hama E Fugmann 1958, Fig. 344 (4B768)  
Hama E1 Riis & Buhl 1990, 130 (Form XIX)  
Hama E2 Riis & Buhl 1990, 130 (Form XIX)  
Hama E2 Riis & Buhl 1990, 146 (458)  
\*\* Hama E2 Riis & Buhl 1990, Fig. 67 (457)  
Tell Afis Area B (Afis VIII) Scigliuzzo 2005, Fig. 37.8  
Tell Afis Area E1 level 2 see Lehmann 1996, 395 (Form 191)  
Tell Nebi Mend Trench V Level B Unpublished  
Tell Rifa'at 2b-c see Lehmann 1996, 395 (Form 191)  
Tell Rifa'at 2b-c Seton Williams 1967, Fig. 2.b-c

#### **Iron III**

Tell Ahmar Area C level 2 Jamieson 1999, Fig. 4.1-2, 4-5  
Tell Ahmar Area C level 2 Jamieson 2000, Fig. 3.22  
Tell Ahmar Area D Iron III Jamieson 2005, Figs 15.3-4; 50.6  
\* Zincirli Iron III Andrae 1943, Fig. 34

#### **Iron III-Persian**

\* Kefrik Moorey 1980, Figs 23.565; 25.583

**Unclear Context**

\* Jerablus Yunus cem. Woolley 1939b, Pl. 12.a

Jerablus Yunus cem. Woolley 1939b, Pl. 25.M6

\* Tell Afis Area N unstrat. Magazzu 2002, Fig. 32.1

\* Tell Afis Area N unstrat. Cecchini 2005, Fig. 64.3

Tell Mishrife Unstrat. du Mesnil du Buisson 1927, Pl. 69.3, 10

Tell Mishrife Unstrat. du Mesnil du Buisson 1935, Fig. 48.169

Tell Rifa'at Unstrat. see Lehmann 1996, 427 (Form 362)

Zincirli Unstrat. Andrae 1943, Pl. 23k, n, o

Zincirli Unstrat. Andrae 1943, Pl. 29e

### **B.6.16.3 CLASS 053c**

**Iron II**

Tell Sheikh Hassan 3 Schneider 1999a, Fig. 3.1

**Unclear Context**

Jerablus Yunus cem. Woolley 1939b, Pl. 22.K6

Tell Sheikh Hassan Unstrat. Boese 1995, 72, Fig. 9a

### **B.6.17 CLASS 054**

**Iron I**

\*\* Beirut Bey 003 glacis I Badre 1997b, Fig. 34b.18

Hazor IX/X Unpublished

Megiddo VIA Loud 1948, Fig. 79.1

\* Megiddo VIA Harrison 2004b, Pl. 6.1

Megiddo VIB Loud 1948, Fig. 74.12

\* Megiddo Tombs Guy 1938, Pl. 68.7, 15

Megiddo Tombs Guy 1938, Pl. 69.6

Pella Area VIII level 7 McNicoll *et al.* 1992, Pl. 65.6

Pella Area VIII level 8 McNicoll *et al.* 1992, Pl. 64.1, 4

Pella Iron I Unpublished

\* Ras Ibn Hani Iron I Badre 1983, Fig. 1b

Sarepta Area X level V Khalifeh 1988, Type K7

Sarepta Area X level VI Khalifeh 1988, Type K7

Sarepta Area Y level E Anderson 1988, Pl. 31.3-4

Sarepta Area Y level G Anderson 1988, Pl. 26.8-9

Tel Beth Shan VI lower Yadin & Geva 1986, Fig. 23.1, 6

\* Tel Dan V Biran 1989a, Fig. 4.6.10

\* Tel Dan VI Biran 1989a, Fig. 4.18.3

\*\* Tel Dan VI Biran 1994, Fig. 87.3

Tell Keisan 9a/b Briend & Humbert 1980, Pl. 65.1-3, 5

Tell Keisan 9c Briend & Humbert 1980, Pl. 78.4

Tell Keisan 9c Briend & Humbert 1980, Pl. 79.1

Tell Keisan 9c Briend & Humbert 1980, Pl. 80.6

Tell Keisan 11/10 Briend & Humbert 1980, Pl. 81.9-10, 11c

Tell Qarqur 9 Unpublished

Tyre XII Bikai 1978b, Pl. 32.13

**Iron I-II**

\* Byblos Necropolis K Salles 1980, Pl. 16.1-2

Byblos Necropolis K Salles 1980, Pls 25.1, 26.2

# Megiddo Area K level 2 (VA-IVB) Finkelstein *et al.* 2000b, Fig. 11.20(10, 13)

Sarepta Area X level VII Khalifeh 1988, Type K7

# Tel Beth Shan V James 1966, Fig. 25.1

Tell el Ghassil Area I level 4 Joukowsky 1972, Pl. 8.26

Tell Mishrife Operation K levels 8-4 Luciani 2002, Fig. 134.6-7

Tell Qarqur 8-9 Dornemann 2003a, Fig. 88.18, 20

Tell Sukas H Buhl 1983, Fig. VIII.84

## Iron II

- # Hazor IV Yadin *et al.* 1958, Pl. 70.1, 4
- \* Hazor IV Yadin *et al.* 1958, Pl. 70.3
- # Hazor IV Yadin *et al.* 1958, Pl. 71.21-22
- Hazor IV Yadin *et al.* 1960, Pl. 99.1, 6
- # Hazor IV Yadin *et al.* 1960, Pl. 99.3, 5, 7, 9
- Hazor IV Yadin *et al.* 1960, Pl. 107.19
- Hazor V Yadin *et al.* 1958, Pl. 54.19, 24
- #\* Hazor V Yadin *et al.* 1958, Pl. 54.21
- Hazor V Yadin *et al.* 1960, Pl. 79.19
- Hazor V Yadin *et al.* 1960, Pls 83.1-4; 84.3
- # Hazor V Yadin *et al.* 1960, Pl. 83.7, 9
- Hazor V Yadin *et al.* 1960, Pl. 107.11
- # Hazor V Yadin *et al.* 1961, Pl. 222.28
- Hazor V Yadin *et al.* 1961, Pl. 222.29-30
- Hazor V Yadin *et al.* 1961, Pl. 223.20
- Hazor V Yadin *et al.* 1961, Pl. 226.14
- # Hazor V Yadin *et al.* 1961, Pl. 226.15
- Hazor V Yadin *et al.* 1961, Pl. 252.1
- # Hazor V Yadin *et al.* 1961, Pl. 252.9
- Hazor V Ben Tor *et al.* 1997, Fig. III.42 (23)
- Hazor VI Yadin *et al.* 1958, Pl. 51.31-32
- Hazor VI Yadin *et al.* 1958, Pl. 52.2
- Hazor VI Yadin *et al.* 1960, Pl. 67.10-11
- # Hazor VI Yadin *et al.* 1960, Pl. 67.12
- Hazor VI Yadin *et al.* 1960, Pl. 67.13
- # Hazor VI Yadin *et al.* 1960, Pl. 68.1-2
- Hazor VI Yadin *et al.* 1961, Pl. 183.1-7
- # Hazor VI Yadin *et al.* 1961, Pl. 183.14
- # Hazor VI Yadin *et al.* 1961, Pl. 183.15-16
- Hazor VI Yadin *et al.* 1961, Pl. 219.16
- Hazor VI Yadin *et al.* 1961, Pl. 249.21
- Hazor VII Yadin *et al.* 1958, Pl. 49.32-33
- Hazor VII Yadin *et al.* 1960, Pl. 64.1, 3
- Hazor VII Yadin *et al.* 1961, Pl. 247.24-25
- Hazor VIII Yadin *et al.* 1960, Pl. 56.7-14
- \*\* Kamid el-Lawz Area S unstrat. Heinz *et al.* 2004, Pl. 1f
- # Megiddo Area H level 3 (IVA) Finkelstein *et al.* 2000b, Fig. 11.44(1-3)
- Megiddo Area H level 3 (IVA) Finkelstein *et al.* 2000b, Fig. 11.44(4)
- # Megiddo Area H level 3 (IVA) Finkelstein *et al.* 2000b, Fig. 11.52(8-12)
- Pella Iron II Unpublished
- Sidon Iron II Doumet-Serhal 2006, Fig. 30.1
- Tel Dan II Pakman 1992, Fig. 2.2
- Tel Jezreel Findgroup A Zimhoni 1997a, Fig. 1.7 (6)
- # Tel Jezreel Findgroup A Zimhoni 1997a, Fig. 1.7 (7)
- # Tel Jezreel Findgroup A Zimhoni 1997b, Fig. 2.5 (5-7)
- # Tel Jezreel Findgroup B Zimhoni 1997b, Fig. 2.8 (8-9)
- Tel Jezreel Findgroup D Zimhoni 1997a, Fig. 1.2 (16)
- # Tel Jezreel Findgroup F Zimhoni 1997b, Fig. 2.12 (1)
- # Tel Jezreel Iron II Zimhoni 1997b, Fig. 2.3 (17)
- # Tel Rehov Area C/E level 1 A. Mazar 1999a, Fig. 24.7
- Tell Afis Area B (Afis VIII) Scigliuzzo 2002, Fig. 13.7
- Tell Afis Area B (Afis VIII) Scigliuzzo 2005, Fig. 37.5
- Tell Afis Area B (Afis VIII) Virgilio 2005, Fig. 35.5
- Tell Afis Area D level 3 Mazzoni 1988a, Fig. 14.5
- Tell Afis Area D level 3 Cecchini 1988, Fig. 6.23
- Tell Afis Area D level 4 Mazzoni 1988a, Fig. 17.1-10
- Tell Afis Area D level 4 Cecchini 1988, Fig. 7.1
- Tell Afis Area D level 6 Mazzoni 1988a, Fig. 22.1-4
- Tell Afis Area E1 level 2 Mazzoni 1998a, Fig. 25.1-3, 5

Tell Afis Area Gc level 8a Cecchini 1998, Fig. 19.9  
Tell el Ghassil Area I level 2 Baramki 1964, Fig. 41.1  
Tell Keisan 6 Briend & Humbert 1980, Pl. 49.5  
Tell Nebi Mend Trench V Level B Unpublished  
Tell Qarqur 8 Unpublished

### **Iron III**

Tell Afis Area B (Afis IX) Scigliuzzo 2002, Fig. 13.7  
Tell Afis Area D level 1 Mazzoni 1988a, Fig. 8.7  
Tell Afis Area D level 2 Cecchini 1988, Fig. 6.15-16  
Tell Afis Area D level 2 Mazzoni 1988a, Fig. 10.6, 12, 14, 17-18  
# Tell Afis Area Gc level 5 Cecchini 1998, Fig. 29.16  
Tell Afis Area Gc level 6 Cecchini 1998, Fig. 27.21  
Tell Afis Area Gc level 6 Cecchini 1998, Fig. 28.2  
# Tell Afis Area Gc level 7b Cecchini 1998, Fig. 21.20  
Tell Afis Area J (Afis IX) Oggiano 2002, Fig. 26.3  
Tell Ahmar Area C level 2 Jamieson 1999, Fig. 3.1  
#\* Tell Keisan 5 Briend & Humbert 1980, Pl. 42.2-2a  
#\*\* Tell Keisan 5 Briend & Humbert 1980, Pl. 43.4  
Tell Rifa'at 2a see Lehmann 1996, 370 (Form 61a)

### **Persian**

Kamid el-Lawz Persian Cem. Poppa 1978, Gr. 16.5  
Tell Keisan 3 Briend & Humbert 1980, Pl. 20.22-22a  
Tell Sukas G1 Buhl 1983, Pl. XVII.285

### **Unclear Context**

Jerablus Yunus cem. Woolley 1939b, Pls 14.d; 22.K11  
Jerablus Yunus cem. Woolley 1939b, Pl. 22.K12-K13, K16  
Tell Judeideh Unstrat. see Lehmann 1996, 370 (Form 61a)  
Tell Mishrife Unstrat. du Mesnil du Buisson 1935, Fig. 49.191a  
Tell Rifa'at 2-3 see Lehmann 1996, 371 (Form 61a)

## **B.6.18 CLASS 055**

### **Iron I**

Pella Iron I Unpublished  
Tell Keisan 9a/b Briend & Humbert 1980, Pl. 64.2-2f  
Tell Keisan 9c Briend & Humbert 1980, Pl. 78.2f-g  
Tyre XIV Bikai 1978b, Pl. 39.27

### **Iron I-II**

Megiddo VA-IVB Lamon & Shipton 1939, Fig. 29.110

### **Iron II**

# Tel Jezreel Findgroup A Zimhoni 1997b, Fig. 2.5 (4)  
# Tel Jezreel Findgroup C Zimhoni 1997a, Fig. 1.9 (2)  
# Tel Jezreel Findgroup D Zimhoni 1997a, Fig. 1.3 (13)  
Tel Rehov Area C/E level 1 A. Mazar 1999a, Fig. 24.6

## **B.6.19 CLASS 056**

### **Iron I**

Beirut Bey 003 glacis I Badre 1997b, Fig. 34a.1-3  
Hazor IX/X Unpublished  
Hazor XII Yadin *et al.* 1961, Pl. 201.9  
Hazor Iron I Ben Tor *et al.* 1997, Fig. II.34 (14)  
Pella Area III level I McNicoll *et al.* 1992, Pl. 49.13  
Pella Area VIII level 7 McNicoll *et al.* 1992, Pl. 65.4  
Ras Ibn Hani Iron I Bounni *et al.* 1979, Fig. 25.8  
Ras Ibn Hani Iron I Badre 1983, Fig. 1a, e  
Sarepta Area X level V Khalifeh 1988, Type K5, K6, K8, K9  
Sarepta Area X level VI Khalifeh 1988, Type K5, K6, K8, K9

Sarepta Area Y level F Anderson 1988, Pl. 30.8-9  
 Sarepta Area Y level G Anderson 1988, Pl. 26.4, 6  
 Sarepta Area Y level G Anderson 1988, Pl. 28.1-5  
 Tell Afis Area E1 level 5 Mazzoni 1992b, Fig. 11.3  
 Tell Afis Area E1 level 5 Mazzoni 1998a, Fig. 19.4  
 Tell Afis Area E1 level 7 Mazzoni 1998a, Fig. 16.5  
 Tell Afis Area E1 level 9a Venturi 1998a, Figs 6.3; 7.15  
 Tell Afis Area E1 level 9b Venturi 1998a, Fig. 4.1  
 Tell Afis Area E1 level 9b Venturi 2000a, Fig. 6.13-14, 16  
 Tell Afis Area E1 level 9b Venturi 2002, Fig. 21.4  
 Tell Afis Area E1 level 9c Venturi 1998a, Fig. 6.4-6  
 Tell Afis Area E2 level 3 Degli Esposti 1998, Fig. 7.19  
 Tell Afis Area G (Iron IC) Canuti 2000, Fig. 17.7, 15  
 Tell Jurn Kabir Findgroup A Eidem and Ackermann 1999, Fig. 5.24  
 Tell Kazel Area II level 5 Badre *et al.* 1994, Figs 35.c; 39.a  
 Tell Keisan 9c Briend & Humbert 1980, Pl. 80.12  
 Tell Qarqur 9 Unpublished  
 Tell Sukas South Harbour Buhl 1996, Fig. 23.IVA (9069/1)  
 Tell Sukas South Harbour Buhl 1996, Fig. 23.IVC  
 Tell Tayinat Iron I Unpublished  
 Tille Höyük I-III Blaylock 1999, Fig. 1.4-6  
**Iron I-II**  
 Ain Dara Lower Mound Stone & Zimansky 1999, Fig. 27.10  
 Sarepta Area X level VII Khalifeh 1988, Type K5, K6; K8, K9  
 Tell Mishrife Iron I/II Unpublished  
 Tell Qarqur 8-9 Dornemann 2003a, Fig. 88.17, 19  
**Iron II**  
 Hazor V Yadin *et al.* 1958, Pl. 54.29  
 Hazor VI Yadin *et al.* 1960, Pl. 68.7  
 Hazor VII Yadin *et al.* 1960, Pl. 64.2, 4, 6  
 Hazor VII Yadin *et al.* 1961, Pl. 215.5  
 Sarepta Area Y level D Anderson 1988, Pl. 34.10  
 Tel Jezreel Unstrat. Zimhoni 1997b, Fig. 2.2 (6)  
 Tell Abou Danne IId/A6 Lebeau 1983, Pl. 34.2-6  
 Tell Afis Area B (Afis VIII) Scigliuzzo 2002, Fig. 12.8  
 Tell Afis Area D level 4 Cecchini 1988, Fig. 7.2  
 Tell Afis Area D level 5 Mazzoni 1988a, Fig. 20.16  
 Tell Afis Area E2 level 2 Degli Esposti 1998, Fig. 11.2, 5  
 Tell Afis Area Gc level 8a Cecchini 1998, Fig. 19.10  
 Tell Afis Area Ge level 2 Cecchini 1998, Fig. 15.19  
 Tell Afis Area L level 3 D'Amore 1998a, Fig. 6.13  
 Tell Nebi Mend Trench V Level B Unpublished  
 Tell Qarqur 8 Dornemann 2003a, Fig. 83.13-14  
 Tell Rifa'at 2b-c Seton Williams 1961, Pl. 39.15  
 Tell Sheikh Hassan 3 Schneider 1999a, Fig. 8.13(3); 14(1)  
 Tille Höyük VIII Blaylock 1999, Fig. 11.19  
 Tyre IV Bikai 1978b, Pl. 14.15  
**Iron II-III**  
 Hazor III/IV Yadin *et al.* 1958, Pl. 78.15  
**Iron III**  
 Tell Abou Danne IIc/A5 Lebeau 1983, Pls 111; 112.5-9  
 Tell Afis Area Gc level 3 Cecchini 1998, Fig. 33.17  
 Tell Afis Area Gc level 5 Cecchini 1998, Fig. 30.1-2  
 Tell Afis Area Gc level 7b Cecchini 1998, Fig. 21.23  
 Tell Afis Area Gn level 3 Cecchini 1998, Fig. 39.1  
 Tell Jurn Kabir Findgroup C Eidem and Ackermann 1999, Fig. 9a.17  
**Iron II-Persian**  
 Akhziv South Cem 69 E. Mazar 2001, Fig. 60.3  
**Persian**  
 Tell Keisan 2 Briend & Humbert 1980, Pl. 12.10



## Unclear Context

Tell Nebi Mend Unstrat. Pezard 1931, Pl. 25.2.5

# B.7 STORAGE AMPHORAE AND URNS

## B.7.1 CLASS 057

### B.7.1.1 CLASS 057a

#### Iron I

\* Hama Cem. I Riis 1948, Figs 23-29

Hama Cem. I Riis 1948, Fig. 31

\* Hama Cem. II Riis 1948, Figs 23-29

\* Hama F1 Riis & Buhl 1990, 129 (Form IA1)

\* Hama F1 Riis & Buhl 1990, 129 (Form IA4)

\* Hama F2 Riis & Buhl 1990, 129 (Form IA5)

Tell el Ghassil Area III level 5 Joukowsky 1972, Pl. 28.11

Tell Kazel Area II level 5 Badre 1990b, Fig. 41.a

Tell Kazel Area II level 6 Badre *et al.* 1994, Fig. 41.d-e

Tell Kazel Area II level 6 Capet 2003, Fig. 21.g

Tell Kazel Area IV level 4 Badre & Gubel 1999-2000, Fig. 43.a

#### Iron I-II

Tel Beth Shan V James 1966, Fig. 31.35

#### Iron II

\* Hama Cem. III Riis 1948, Figs 26-29

\* Hama Cem. IV Riis 1948, Figs 28-29

Hama Cem. IV Riis 1948, Figs 30, 32

Hama E Fugmann 1958, Fig. 344 (L905)

\* Hama E1 Riis & Buhl 1990, 129 (Forms IA1 & IA5)

\* Hama E1 Riis & Buhl 1990, 129 (Form IA2)

Hama E1 Riis & Buhl 1990, 129 (Form IA8)

\* Hama E2 Riis & Buhl 1990, 129 (Form IA1)

\* Hama E2 Riis & Buhl 1990, 129 (Form IA4)

Tell Qarqur 8 Taylor 1984, Nos 1-7

Tell Shiyuk Fawqani Area H Luciani 2000, Fig. 2.4

Tell Shiyuk Fawqani Area H Al-Bahloul *et al.* 2005, Pls 2a, 4, 7a-9a

#### Iron II-III

Tell Shiyuk Fawqani Area F (IX) Makinson 2005, Pl. 20.128

#### Unclear Context

Jerablus Yunus cem. Woolley 1939b, Pls 14.f; 22.U1-U2

Tell Mishrife Unstrat. du Mesnil du Buisson 1927, Pl. 69.11

### B.7.1.2 CLASS 057b

#### Iron I

Pella Area III level I McNicoll *et al.* 1992, Pl. 68.6

Tel Dan V Biran 1994, Fig. 99.4

Tel Dan VI Biran 1989a, Fig. 4.24.6

\* Tell Afis Area E1 level 3 Mazzoni 1998a, Fig. 22.2

\* Tell Afis Area E1 level 4 Mazzoni 1998a, Fig. 19.1-2

\* Tell Afis Area E1 level 7 Mazzoni 1998a, Fig. 16.7, 9-10; Venturi 2000a, Fig. 11.1

\* Tell Afis Area E1 level 9a Venturi 2000a, Fig. 7.13

Tell el Ghassil Area I level 5 Joukowsky 1972, Pl. 12.44

Tell el Ghassil Area III level 6 Joukowsky 1972, Pl. 29.11

\* Tell Tayinat Iron I Harrison *et al.* 2006, Fig. 11

\* Tell Tayinat Iron I Unpublished

#### Iron I-II

# Megiddo VA-IVB Lamon & Shipton 1939, Fig. 19.105  
# Megiddo VA-IVB Lamon & Shipton 1939, Fig. 22.128  
Megiddo VA-IVB Loud 1948, Fig. 89.1  
\*\* Megiddo VA-IVB Loud 1948, Fig. 89.2  
# Tel Beth Shan V James 1966, Fig. 7.6  
Tell el Ghassil Area I level 4 Baramki 1961, Fig. 4.1  
Tell el Ghassil Area I level 4 Joukowsky 1972, Pl. 10.5  
Tell el Ghassil Area III level 4 Joukowsky 1972, Pl. 26.27, 30  
Tell Mastuma Central Area level I Wakita *et al.* 2000, Fig. 10.1  
\* Tell Mastuma Central Area level I Wakita *et al.* 2000, Fig. 10.3

#### **Iron II**

Chatal Höyük III Haines 1971, Pl. 4c  
Chatal Höyük III Haines 1971, Pl. 11b  
\* Hazor VI Yadin *et al.* 1960, Pl. 74.1  
Hazor VII Ben Tor *et al.* 1997, Fig. III.30 (30)  
Tel Rehov Area C/E level 1 A. Mazar 1999a, Fig. 24.14  
Tell el Ghassil Area III level 3 Joukowsky 1972, Pl. 25.9  
\*\* Tell Judeideh IV Swift 1958, Fig. 39  
\* Tell Mastuma Central Area level I-2 Egami & Masuda 1984, Pl. 7.6  
Tell Mastuma Central Area level I-2 Egami 1988, Pl. 17.9  
Tell Mastuma South Area Wada 1994, Fig. 3.13

#### **Iron II-III**

Al Mina VIII Woolley 1938b, Fig. 27.11

#### **Iron III**

# Megiddo II/III Lamon & Shipton 1939, Fig. 10.37  
\* Ras al-Bassit Cem. Courbin 1993a, Fig. 7.4(C511)  
\* Tell Arqa 9 Thalmann 1990, Fig. 1.5  
Tell Keisan 5 Briend & Humbert 1980, Pl. 44.2

#### **Unclear Context**

Chatal Höyük Unstrat. Lehmann 1996, Pl. 53 (321/3)  
Nayrab Unstrat. Abel & Barrois 1928, Pl. 54h  
\*\* Tell Abu Hawam III Hamilton 1935, Pl. 13.79  
\* Tell Afis Area N unstrat. Cecchini 2005, Fig. 64.2  
\* Tell Mishrife Unstrat. du Mesnil du Buisson 1927, Pl. 81.66

### **B.7.1.3 CLASS 057c**

#### **Iron I**

\* Hama Cem. II Riis 1948, Fig. 45  
Kamid el-Lawz Iron I Marfoe 1995, Fig. 106.6  
Tell Abu Hawam IV Hamilton 1935, Fig. 13

#### **Iron I-II**

Tell Sukas H Buhl 1983, Fig. I.1

#### **Iron II**

Hama Cem. III Riis 1948, Fig. 44  
\* Hama Cem. III Riis 1948, Fig. 45  
\* Hama Cem. IV Riis 1948, Fig. 45  
\* Hama E Fugmann 1958, Fig. 188 (5A842)  
\* Hama E1 Riis & Buhl 1990, 129 (Form VIB2)  
\*\* Ras al-Bassit Cem. Courbin 1993a, Fig. 7.3(C537)  
\* Tambourit Saidah 1977, No. 6  
Tell Afis Area D level 4 Mazzoni 1988a, Fig. 18.18  
Tell el Ghassil Area I level 2 Baramki 1964, Fig. 27.6

#### **Iron II-III**

\* Deve Höyük Cem. I Moorey 1980, Fig. 2.5-6

#### **Iron III**

Al Mina VI Woolley 1938b, Fig. 27.12

#### **Unclear Context**

\* Athlit Cremation cem. Johns 1938, Fig. 8.1

- \* Athlit Cremation cem. Johns 1938, Fig. 12.3
- \* Jerablus Yunus cem. Woolley 1939b, Pls 10.5-6; 11.1-6; 13.9-11
- Jerablus Yunus cem. Woolley 1939b, Pl. 22.U3-U4

#### **B.7.1.4 CLASS 057d**

##### **Iron I**

- \* Hama Cem. I Riis 1948, Figs 51, 55
- \*\* Tel Beth Shan VI James 1966, Fig. 57.12
- \*\* Tell Kazel Area II level 5 Badre *et al.* 1994, Fig. 35.a
- \* Tell Kazel Area II level 5 Capet & Gubel 2000, Fig. 14
- Tell Kazel Area II level 5 Capet 2003, Fig. 43.j
- \* Tell Kazel Area II level 5 Capet 2003, Fig. 43.k

#### **B.7.1.5 CLASS 057e**

##### **Iron I**

- \*\* Hama Cem. I Riis 1948, Fig. 41
- \* Hama Cem. I Riis 1948, Figs 42-43
- \* Hama Cem. II Riis 1948, Figs 42-43
- \* Hama F2 Riis & Buhl 1990, 129 (Form VIA2)

##### **Iron II**

- \* Hama Cem. IV Riis 1948, Fig. 43

#### **B.7.2 CLASS 058**

##### **Iron II-III**

Tell Judeideh IV/III see Lehmann 1996, 426 (Form 359a)

##### **Iron III**

- Al Mina V Lehmann 1996, Pl. 61 (359c/3)
- Al Mina VI/V Lehmann 1996, Pl. 60 (359a/4)
- Al Mina VI Lehmann 1996, Pl. 61 (359c/4)
- Tell Judeideh III see Lehmann 1996, 426 (Form 359a)

##### **Persian**

- Al Mina III Lehmann 1996, Pl. 60 (359a/2)
- Al Mina III Lehmann 1996, Pl. 60 (359b/2)
- Al Mina III Lehmann 1996, Pl. 61 (359b/4-7)
- Al Mina III see Lehmann 1996, 426 (Form 359a)
- Al Mina III see Lehmann 1996, 427 (Form 359c)
- Al Mina IV/III Lehmann 1996, Pl. 60 (359a/5)
- Al Mina IV/III Lehmann 1996, Pl. 60 (359b/1)
- Al Mina IV/III Lehmann 1996, Pl. 61 (359d/1)
- Al Mina IV Lehmann 1996, Pl. 60 (359a/3+4; 359a/6)
- Al Mina IV Lehmann 1996, Pl. 61 (359c/5)
- Ras al-Bassit Cem. Courbin 1993a, Fig. 17.3(C567)
- Tell Sukas E Riis 1970, Fig. 42c
- Tell Sukas F Riis 1970, Fig. 42
- Tell Sukas F Ploug 1973, No. 372
- Tell Sukas G1 Ploug 1973, No. 373

##### **Unclear Context**

Tell Sukas Unstrat. Ploug 1973, No. 375-376

#### **B.7.3 CLASS 059**

##### **Iron I**

Hama Cem. I Riis 1948, Fig. 48

##### **Iron II**

\* Hama Cem. IV Riis 1948, Fig. 50  
\* Ras al-Bassit Cem. Courbin 1993a, Fig. 7.2(C910)  
Tell el Ghassil Area I level 2 Baramki 1964, Fig. 31.3  
Tell el Ghassil Area I level 2 Baramki 1964, Fig. 38.4  
Tell el Ghassil Area I level 2 Baramki 1964, Fig. 40.3  
Tell el Ghassil Area III level 2 Joukowsky 1972, Pl. 19.10, 13, 15  
Tell Kazel Iron II Dunand *et al.* 1964, Pl. 10.3  
Tell Mastuma Central Area level I-2 Egami & Masuda 1984, Pl. 7.5, 8

#### **Iron III**

\* Ras al-Bassit Cem. Courbin 1993a, Fig. 7.1(C518)  
Ras al-Bassit Cem. Courbin 1993a, Fig. 6.1(C520)

### **B.7.4 CLASS 060**

#### **Iron I**

\* Hazor XI Yadin *et al.* 1961, Pl. 203.15  
\* Megiddo VIB Harrison 2004b, Pl. 3.12  
\* Tel Beth Shan VI James 1966, Fig. 52.5  
\* Tell Sukas H2 Buhl 1983, Pl. XVII.278  
Tille Höyük I-III Blaylock 1999, Fig. 2.7

#### **Iron II**

Hama Cem. IV Riis 1948, Fig. 47  
Hama Cem. IV Riis 1948, Fig. 54  
# Hama E Fugmann 1958, Fig. 310 (7B18)

### **B.7.5 CLASS 061**

#### **Iron I-II**

Tel Beth Shan Northern cem. Oren 1973, Fig. 48c.28  
\* Tel Dan IV Biran 1982, Fig. 27.6

#### **Iron II**

Hama Cem. IV Riis 1948, Fig. 46  
# Hama E Fugmann 1958, Fig. 269 (6B470)  
Hama E1 Riis & Buhl 1990, 129 (Form VIB3)  
# Hazor V Yadin *et al.* 1961, Pl. 190.5  
Tell el Ghassil Area I level 3 Joukowsky 1972, Pl. 6.3, 7

#### **Unclear Context**

Tell Mishrife Unstrat. du Mesnil du Buisson 1935, Fig. 6.140  
Tell Rachidiah Unstrat. Macridi-Bey 1904a, Pl. 6.22

### **B.7.6 CLASS 062**

#### **Iron I**

\*\* Tell Kazel Area II level 5 Badre *et al.* 1994, Fig. 35.b

#### **Iron I-II**

\* Tyre X Bikai 1978b, Pl. 28.9

#### **Iron II**

\*\* Beirut Bey 003 glacis II Badre 1997b, Fig. 35.13-14  
CWP Beirut Bey 003 glacis II Badre 1998, Fig. 6.8  
\*\* Ras al-Bassit Cem. Courbin 1993a, Fig. 11.2(C514)  
\* Ras al-Bassit Cem. Courbin 1993a, Fig. 12.3(C530)  
\*\* Ras al-Bassit Cem. Courbin 1993a, Fig. 13.1(C1)  
\*\* Tell Rachidiah Tomb I Doumet-Serhal 2004b, Fig. 9  
\* Tyre Al-Bass cem. II Núñez 2004a, Fig. 76.1

#### **Iron II-III**

\* Al Mina VIII du Plat Taylor 1959, Fig. 3.1  
Beirut Bey 003 abandonment Badre 1998, Fig. 7.6-7

\*\* Tyre Al-Bass cem. IV Núñez 2004a, Fig. 74.1

#### **Iron III**

\* Al Mina VI/V du Plat Taylor 1959, Fig. 3.5-6, 9

\*\* Al Mina VIII-V du Plat Taylor 1959, Fig. 3.7

\* Ras al-Bassit Cem. Courbin 1993a, Fig. 7.5(C529)

\* Ras al-Bassit Cem. Courbin 1993a, Fig. 12.5(C546)

\*\* Ras al-Bassit Cem. Courbin 1993a, Fig. 13.3(C522)

#### **Unclear Context**

\*\* Al Mina Unstrat. du Plat Taylor 1959, Fig. 4.3

\* Tell Judeideh Unstrat. see Lehmann 1996, 420 (Form 315)

\* Tell Rachidiah Tomb II Doumet-Serhal 2004b, Fig. 8

\* Tell Rachidiah Unstrat. Culican 1982, Pl. 11d

### **B.7.7 CLASS 063**

#### **Iron II**

Tell Shiyuk Fawqani Area H Al-Bahloul et al. 2005, Pl. 1a

#### **Persian**

Tell Shiyuk Fawqani Area G level 1 Luciani 2000, Fig. 3.5

### **B.7.8 CLASS 064**

#### **Iron I**

Hazor IX/X Unpublished

Hazor X Yadin *et al.* 1961, Pl. 207.26

Megiddo VB Lamon & Shipton 1939, Fig. 20.116

Tel Beth Shan V lower James 1966, Fig. 60.3

#### **Iron I-II**

Megiddo VA-IVB Lamon & Shipton 1939, Fig. 20.116

Megiddo Area K level 2 (VA-IVB) Finkelstein *et al.* 2000b, Fig. 11.21(8)

Tel Beth Shan V James 1966, Figs 4.5; 29.4

#### **Iron II**

Hazor V Yadin *et al.* 1958, Pl. 57.12-13

Hazor VII Yadin *et al.* 1960, Pl. 65.8-9

Hazor VII Yadin *et al.* 1961, Pl. 218.10, 13-14

Hazor VIII Yadin *et al.* 1960, Pl. 61.1-11

Megiddo IVA Lamon & Shipton 1939, Fig. 11.54, 57

Tel Beth Shan V upper James 1966, Figs 40.1-11, 12-14; 64.4, 6-7; 65.2

Tel Jezreel Findgroup A Zimhoni 1997a, Fig. 1.6 (6-12)

Tel Jezreel Findgroup A Zimhoni 1997b, Fig. 2.7 (1-4, 7-8)

Tel Jezreel Findgroup D Zimhoni 1997a, Fig. 1.4 (11)

Tel Jezreel Findgroup F Zimhoni 1997b, Fig. 2.12 (6-7)

Tel Rehov Area C/E level I A. Mazar 1999a, Fig. 24.15

#### **Iron III**

Megiddo II/III Lamon & Shipton 1939, Fig. 11.54, 57

### **B.7.9 CLASS 65**

#### **Iron II**

# Khirbet Silm S. V. Chapman 1972, Fig. 28.156

## **B.8 SPOUTED AMPHORAE**

### **B.8.1 CLASS 066**

#### **Iron I**

# Hazor XII Yadin *et al.* 1961, Pl. 201.24

- \* Megiddo VB Lamon & Shipton 1939, Fig. 19.111
- Megiddo VIA Loud 1948, Fig. 77.12 (Harrison 2004b, Pl. 14.5)
- \* Megiddo VIA Loud 1948, Fig. 77.13 (Harrison 2004b, Pl. 14.6)
- \* Megiddo VIA Harrison 2004b, Pl. 14.7-8, 10
- \* Megiddo Area F level 5 (VIA) Finkelstein *et al.* 2000b, Fig. 11.3(8)
- \* Megiddo VIB Loud 1948, Fig. 73.11
- \* Tell Keisan 9a/b Briend & Humbert 1980, Pl. 61.11, 14
- \* Tell Keisan 9c Briend & Humbert 1980, Pl. 71.7, 8c
- \*\* Tell Keisan 9c Briend & Humbert 1980, Pl. 71.8

#### **Iron I-II**

- Megiddo VA-IVB Lamon & Shipton 1939, Fig. 11.52
- # Megiddo VA-IVB Lamon & Shipton 1939, Fig. 19.106

## **B.8.2 CLASS 067**

#### **Iron I-II**

- Tel Beth Shan V James 1966, Fig. 31.14

#### **Iron II**

- Hazor V Yadin *et al.* 1960, Pl. 89.11
- Hazor V Yadin *et al.* 1960, Pl. 96.3
- # Hazor V Yadin *et al.* 1961, Pl. 228.24
- \* Hazor V Yadin *et al.* 1961, Pl. 228.25
- \* Hazor VI Yadin *et al.* 1960, Pl. 74.3
- Hazor VI Yadin *et al.* 1960, Pl. 74.4
- Hazor VI Yadin *et al.* 1961, Pl. 185.11
- Hazor VII Yadin *et al.* 1961, Pl. 215.23
- Megiddo Area H level 3 (IVA) Finkelstein *et al.* 2000b, Fig. 11.46(13-14)
- Tel Beth Shan IV James 1966, Fig. 72.3

#### **Iron III**

- Megiddo II/III Lamon & Shipton 1939, Fig. 12.62

#### **Persian**

- Megiddo I Lamon & Shipton 1939, Fig. 12.62

## **B.9 JUGS**

### **B.9.1 CLASS 068**

#### **Iron I**

- Hama Cem. I Riis 1948, Fig. 66
- Hama Cem. II Riis 1948, Figs 66-67
- Tel Dan V Biran 1989b, Fig. 22.7

#### **Iron I-II**

- Tel Dan IV Biran 1982, Fig. 27.5

#### **Iron II**

- Hama Cem. III Riis 1948, Fig. 66
- \* Hama Cem. IV Riis 1948, Fig. 37
- Hama Cem. IV Riis 1948, Figs 67-70
- Hama E Fugmann 1958, Fig. 310 (7B198)
- Hama E1 Riis & Buhl 1990, 129 (Form XIID4); Fig. 67 (450)
- Tel Beth Shan IV James 1966, Fig. 72.13
- Tell Afis Area D level 4 Mazzoni 1988a, Fig. 18.16, 19
- Tell el Ghassil Area I level 1 Baramki 1964, Fig. 24.1
- Tell el Ghassil Area I level 2 Baramki 1964, Fig. 4.1
- Tell el Ghassil Area III level 2 Joukowsky 1972, Pl. 18.34
- Tell Mastuma Central Area level I-2 Wakita *et al.* 1995, Fig. 7.2
- Tell Mastuma South Area Wada 1994, Fig. 3.11-12
- Tille Höyük VIII Blaylock 1999, Fig. 8.3, 5-6

### **Iron III**

Megiddo II/III Lamon & Shipton 1939, Fig. 2.68

### **Persian**

Megiddo I Lamon & Shipton 1939, Fig. 2.68

Tell Keisan 2 Briend & Humbert 1980, Pl. 9.3-11

### **Unclear Context**

Jerablus Yunus cem. Woolley 1939b, Pl. 24.J9

Nayrab Unstrat. Abel & Barrois 1928, Pl. 54k

## **B.9.2 CLASS 069**

### **Iron I**

Tell Kazel Iron I Dunand *et al.* 1964, Pl. 13.1

\* Tell Kazel Area II level 5 Capet 2003, Fig. 36.h

Tell Kazel Area II level 5 Capet 2003, Fig. 44.e-f

Tell Kazel Area II level 6 Capet 2003, Fig. 6.d

## **B.9.3 CLASS 070**

### **Iron II**

\*\* Hazor V Yadin *et al.* 1961, Pl. 228.3

Hazor VI Yadin *et al.* 1961, Pl. 185.1-2

Sarepta Area Y level D Anderson 1988, Pl. 33.4

Tyre II Bikai 1978b, Pl. 6.12

\*\* Tyre III Bikai 1978b, Pl. 6.10

Tyre III Bikai 1978b, Pl. 6.11

### **Iron III**

\*\* Megiddo II/III Lamon & Shipton 1939, Fig. 2.69

## **B.9.4 CLASS 071**

### **B.9.4.1 CLASS 071a**

#### **Iron I**

\* Hama Cem. I Riis 1948, Fig. 63

Hama Cem. I Riis 1948, Fig. 65

\* Hama F2 Riis & Buhl 1990, 129 (Form XHIA1)

\*\*\* Megiddo VB Lamon & Shipton 1939, Fig. 6.154

Megiddo VB Lamon & Shipton 1939, Fig. 6.159-160

Megiddo VIA Loud 1948, Fig. 75.1-5

\* Megiddo VIA Loud 1948, Fig. 75.11

Megiddo VIA Harrison 2004b, Pl. 15.13-14

Megiddo Area F level 5 (VIA) Finkelstein *et al.* 2000b, Fig. 11.3(1)

Megiddo VIB Loud 1948, Fig. 73.1

Megiddo Tombs Guy 1938, Pl. 72.12

Tel Beth Shan VI lower Yadin & Geva 1986, Fig. 26.5, 7

\* Tel Beth Shan VI lower Yadin & Geva 1986, Fig. 26.6

Tel Dan V Biran 1989b, Fig. 24.5

\*\* Tell Kazel Area II level 5 Capet 2003, Fig. 36.i

Tell Kazel Area II level 5 Capet 2003, Fig. 48.b

Tell Keisan 9a/b Briend & Humbert 1980, Pl. 57.7

Tell Keisan 9a/b Briend & Humbert 1980, Pl. 61.4

Tell Keisan 9c Briend & Humbert 1980, Pl. 71.5

\*\* Tell Keisan 9c Briend & Humbert 1980, Pl. 72.1

#### **Iron I-II**

\*\*\* Megiddo VA-IVB Lamon & Shipton 1939, Fig. 6.154

Megiddo VA-IVB Lamon & Shipton 1939, Fig. 6.159

Megiddo VA-IVB Lamon & Shipton 1939, Fig. 8.178

# Megiddo VA-IVB Loud 1948, Fig. 88.3-4

Tyre X Bikai 1978b, Pl. 25.8

#### **Iron II**

\* Hama E Riis & Buhl 1990, Fig. 66 (449)

Hazor VI Yadin *et al.* 1961, Pl. 250.1

#### **Iron II-III**

Tell Shiyuk Fawqani Area F (IX) Makinson 2005, Pl. 23.150-153

#### **Iron III**

Tell Ahmar Area C level 2 Jamieson 2000, Fig. 6.18-21

Tell Kazel Area II level 3 Badre 1990b, Fig. 34.c

#### **Persian**

Tell Kazel Area I level 4 Gubel 1990a, Fig. 23.f

#### **Unclear Context**

Jerablus Yunus cem. Woolley 1939b, Pl. 24.J6

\* Sarepta Area X unstrat. Pritchard 1988, Fig. 47.13

### **B.9.4.2 CLASS 071b**

#### **Iron I**

Hama Cem. I Riis 1948, Fig. 64

Hazor XI Yadin *et al.* 1961, Pl. 205.1

\* Megiddo VIA Harrison 2004b, Pl. 16.14

\* Megiddo VIB Loud 1948, Fig. 73.2

\* Tel Beth Shan VI James 1966, Fig. 56.2

\* Tel Beth Shan VI lower Yadin & Geva 1986, Fig. 26.4

Tel Beth Shan VI lower Yadin & Geva 1986, Fig. 27.1

# Tel Beth Shan VI lower Yadin & Geva 1986, Fig. 27.5

Tell Keisan 9a/b Briend & Humbert 1980, Pl. 61.6

#### **Iron I-II**

Megiddo Area K level 2 (VA-IVB) Finkelstein *et al.* 2000b, Fig. 11.21(9)

Tel Beth Shan V James 1966, Fig. 8.4

#### **Iron II**

\* Hazor VI Yadin *et al.* 1960, Pl. 70.16

Hazor VI Yadin *et al.* 1961, Pl. 250.4

Tel Beth Shan IV James 1966, Fig. 37.6

# Tel Jezreel Findgroup B Zimhoni 1997b, Fig. 2.9 (3)

Tel Rehov Area C/E level 1 A. Mazar 1999a, Fig. 24.17

# Tell Arqa 10 Unpublished

Tell el Ghassil Area I level 2 Baramki 1964, Fig. 28.3

Tell el Ghassil Area III level 2 Joukowsky 1972, Pl. 18.47

#### **Persian**

Tell Sukas South Harbour cem. Riis 1979, Figs 20-21

\* Tell Sukas South Harbour cem. Riis 1979, Figs 43-44

#### **Unclear Context**

\* Byblos Unstrat. Lehmann 1996, Pl. 46 (282/1-2)

### **B.9.5 CLASS 072**

#### **Iron II-III**

Deve Höyük Cem. I Moorey 1980, Fig. 3.27

Deve Höyük Cem. I Moorey 1980, Fig. 4.28

#### **Persian**

Tell Kazel Area I level 4 Gubel 1990a, Fig. 24.a

### **B.9.6 CLASS 073**

#### **Iron I**



- Hama Cem. I Riis 1948, Fig. 73  
Hama F Fugmann 1958, Fig. 165 (4B10)  
Hama F1 Riis & Buhl 1990, 130 (Form XVIA)  
Hama F2 Riis & Buhl 1990, 130 (Form XVIA)  
Hazor IX Yadin *et al.* 1961, Pl. 176.2  
\*\* Hazor IX Yadin *et al.* 1961, Pl. 176.3  
Hazor IX Yadin *et al.* 1961, Pl. 208.41  
Hazor X Yadin *et al.* 1961, Pl. 172.2  
Hazor X Yadin *et al.* 1961, Pl. 207.18  
Hazor XI Yadin *et al.* 1961, Pl. 203.18  
Hazor XII Yadin *et al.* 1961, Pl. 166.10-12  
Hazor XII Yadin *et al.* 1961, Pl. 201.20-21  
\* Khalde Cem. IV Saidah 1966, No. 41  
Tel Dan V Biran 1989a, Fig. 4.7.7  
Tel Dan V Biran 1989b, Fig. 24.4, 6  
Tel Dan V/VI Biran 1994, Fig. 103.5  
\*\* Tell Kazel Area II level 5 Badre *et al.* 1994, Fig. 33.e  
\* Tell Kazel Area II level 5 Badre *et al.* 1994, Fig. 33.f  
Tille Höyük I-III Blaylock 1999, Fig. 2.10
- Iron I-II**  
Akhziv East Cem XXXIX Dayagi-Mendels 2002, Fig. 4.28(4)  
\*\* Akhziv TC4 E. Mazar 2001, Fig. 7.7  
Akhziv TC4 E. Mazar 2001, Fig. 9.6  
Tel Dan IV Biran 1982, Fig. 27.3
- Iron II**  
\*\* Chatal Höyük III Swift 1958, Fig. 42  
Hama E Riis & Buhl 1990, Fig. 67 (451)  
Hazor V Yadin *et al.* 1961, Pl. 228.2  
\* Hazor VI Yadin *et al.* 1960, Pl. 70.15  
Hazor VII Yadin *et al.* 1958, Pl. 50.20  
Hazor VIII Yadin *et al.* 1960, Pl. 58.13-14  
\*\* Joya S. V. Chapman 1972, Fig. 11.173  
Khirbet Silm S. V. Chapman 1972, Fig. 9.13-14  
\* Khirbet Silm S. V. Chapman 1972, Fig. 10.18  
Megiddo Area H level 3 (IVA) Finkelstein *et al.* 2000b, Figs 11.45(6); 46(9)  
Tel Beth Shan IV James 1966, Fig. 71.3  
Tel Dan II Pakman 1992, Fig. 2.9  
Tell el Ghassil Area I level 2 Joukowsky 1972, Pl. 2.27, 31  
Tell el Ghassil Area III level 2 Joukowsky 1972, Pl. 18.35  
Tell Kazel Area II level 4 Badre *et al.* 1994, Fig. 28.a  
Tell Nebi Mend Trench V Level B Unpublished  
\*\* Tyre VIII Bikai 1978b, Pl. 20.7  
\* Tyre IX Bikai 1978b, Pl. 20.8
- Iron II-III**  
Akhziv Tomb N3 E. Mazar 2004, Fig. 10.13  
Akhziv Tomb N4 E. Mazar 2004, Fig. 10.7, 10  
Tyre Al-Bass cem. Unstrat. Seeden 1991, Figs 39-40
- Iron I-III**  
\*\* Akhziv East Cem XXXVI Dayagi-Mendels 2002, 91 (20)  
Akhziv East Cem XXXVI Dayagi-Mendels 2002, 91 (21)
- Iron III**  
Tel Dan I Pakman 1992, Fig. 5.3  
\* Tell Keisan 5 Briend & Humbert 1980, Pl. 44.4
- Iron II-Persian**  
\* Akhziv East Cem XII Dayagi-Mendels 2002, Fig. 4.10(10)  
Akhziv East Cem XIV Dayagi-Mendels 2002, Fig. 4.12(4)  
Akhziv South Cem 72 E. Mazar 2001, Fig. 65.17
- Persian**  
Deve Höyük Cem. II Moorey 1980, Fig. 4.46  
Kamid el-Lawz Persian Cem. Poppa 1978, Gr. 37.1



Tell Abu Hawam II Hamilton 1934, Pl. 23.10  
Tell Keisan 3 Briend & Humbert 1980, Pl. 19.10  
**Unclear Context**  
Jerablus Yunus cem. Woolley 1939b, Pl. 24.J7-J8  
\*\* Sarepta Area X unstrat. Pritchard 1988, Fig. 47.14  
\*\* Tell Abu Hawam III Hamilton 1935, Pl. 13.82  
Tell Mishrife Unstrat. du Mesnil du Buisson 1927, Pl. 69.4-5

## **B.9.7 CLASS 074**

### **Iron I-II**

\* Byblos Necropolis K Salles 1980, Pl. 20.18

### **Iron II**

\* Hazor IV Yadin *et al.* 1960, Pl. 100.22  
\*\* Joya S. V. Chapman 1972, Fig. 11.172  
Khirbet Silm S. V. Chapman 1972, Fig. 9.12  
\*\* Khirbet Silm S. V. Chapman 1972, Fig. 11.19  
Tell el Ghassil Area I level 2 Baramki 1964, Fig. 34.2  
Tell el Ghassil Area III level 2 Joukowsky 1972, Pl. 18.44  
Tyre III Bikai 1978b, Pl. 6.7

### **Iron II-III**

Akhziv East Cem XXIX Culican 1975-1976, Fig. A.t

### **Persian**

Tell Keisan 2 Briend & Humbert 1980, Pl. 9.2  
Tell Shiyuk Fawqani Area G level 1 Luciani 2005, Pl. 80.94

### **Unclear Context**

Akhziv Unstrat. Culican 1982, Pl. 4e

## **B.9.8 CLASS 075**

### **Iron I**

# Megiddo VB Lamon & Shipton 1939, Fig. 6.155  
# Tel Beth Shan V lower James 1966, Figs 60.8; 61.11  
Tel Beth Shan V lower James 1966, Fig. 61.10  
\* Tell Keisan 9c Briend & Humbert 1980, Pl. 71.5b

### **Iron I-II**

## Megiddo VA-IVB Lamon & Shipton 1939, Fig. 6.144  
# Megiddo VA-IVB Lamon & Shipton 1939, Fig. 6.145  
Tel Beth Shan V James 1966, Fig. 1.9  
Tel Beth Shan V James 1966, Figs 5.7; 18.27; 20.9; 23.7; 29.10; 30.9

### **Unclear Context**

Byblos Unstrat. Homsy 2003, Pl. 4c  
\* Byblos Unstrat. Homsy 2003, Pl. 5a-b

## **B.9.9 CLASS 076**

### **Iron I**

# Megiddo VIA Loud 1948, Fig. 75.6  
\* Megiddo VIA Loud 1948, Fig. 75.7-8  
Megiddo VIA Loud 1948, Fig. 75.9  
\* Megiddo VIA Loud 1948, Fig. 75.10, 12  
## Megiddo VIA Loud 1948, Fig. 75.13  
Megiddo VIA Harrison 2004b, Pl. 15.12, 15, 17  
\* Megiddo VIA Harrison 2004b, Pl. 16.7, 12  
\*\* Megiddo VIA Harrison 2004b, Pl. 16.10  
\* Megiddo VIB Loud 1948, Fig. 73.3  
\* Tel Beth Shan VI lower Yadin & Geva 1986, Fig. 27.2

\* Tell Keisan 9c Briend & Humbert 1980, Pl. 70.4

#### **Iron I-II**

Akhziv TC4 E. Mazar 2001, Fig. 10.5

# Megiddo VA-IVB Lamon & Shipton 1939, Fig. 7.171

\*\*\* Megiddo VA-IVB Lamon & Shipton 1939, Fig. 7.173

Tel Beth Shan Northern cem. Oren 1973, Fig. 44b.20

## Tel Dan IV Biran 1982, Fig. 27.4

Tyre X Bikai 1978b, Pl. 25.7

#### **Iron II**

Tell el Ghassil Area III level 3 Joukowsky 1972, Pl. 24.32

\*\* Tell el Ghassil Area III level 3 Joukowsky 1972, Pl. 24.34

#### **Unclear Context**

Sarepta Area X unstrat. Pritchard 1988, Fig. 46.6

## **B.9.10 CLASS 077**

#### **Iron I**

\*\* Hazor IX/X Unpublished

\*\* Megiddo VB Lamon & Shipton 1939, Fig. 36.13

\*\* Tell Abu Hawam IV Hamilton 1935, 28, No. 152

\*\* Tell Abu Hawam IV Hamilton 1935, Pl. 14.158

\*\* Tyre XII Bikai 1978b, Pl. 31.15

#### **Iron I-II**

\*\* Akhziv TC4 E. Mazar 2001, Fig. 8.3-4

\*\* Megiddo VA-IVB Loud 1948, Fig. 88.15

\* Tel Beth Shan Northern cem. Oren 1973, Fig. 43.20

\*\* Tyre X Bikai 1978b, Pl. 25.14

#### **Iron II**

\*\* Hazor V Yadin *et al.* 1961, Pl. 224.10

\*\* Hazor VI Yadin *et al.* 1961, Pl. 186.1

\*\* Hazor VIII Ben Tor *et al.* 1997, Fig. III.25 (2)

\*\* Joya S. V. Chapman 1972, Fig. 5.193

# Joya S. V. Chapman 1972, Fig. 30.264

\*\* Khirbet Silm S. V. Chapman 1972, Fig. 4.51-52

\*\* Khirbet Silm S. V. Chapman 1972, Fig. 5.57, 59

\*\* Khirbet Silm S. V. Chapman 1972, Fig. 31.163

\*\* Pella Iron II Unpublished

\*\* Tell Rachidiah Tomb IV Doumet 1982, Pl. XI.11

\* Tell Rachidiah Tomb IV Doumet 1982, Pl. XII.25

\*\* Tell Rachidiah Tomb IV Doumet 1982, Pl. XII.30, 33, 42

\* Tell Rachidiah Tomb IV Doumet 1982, Pl. XIII.95

\*\* Tell Judeideh IV see Lehmann 1996, 409 (Form 260)

\*\* Tyre IX Bikai 1978b, Pl. 21.9

\*\* Tyre IX Bikai 1978b, Pl. 22.8

\* Tyre Al-Bass cem. II Núñez 2004a, Fig. 81.2

\*\* Tyre Al-Bass cem. II Núñez 2004a, Fig. 93.4

\*\* Tyre Al-Bass cem. II Núñez 2004a, Fig. 100.4-6

#### **Iron I-III**

\*\* Akhziv South Cem I Dayagi-Mendels 2002, Fig. 3.2(23)

#\* Akhziv South Cem XX Dayagi-Mendels 2002, 32 (47)

#\* Akhziv South Cem XX Dayagi-Mendels 2002, Fig. 3.16(48)

#### **Iron II-III**

\* Qraye S. V. Chapman 1972, Fig. 5.270

\*\* Tell Judeideh IV/III see Lehmann 1996, 409 (Form 260)

\*\* Tyre Al-Bass cem. IV Núñez 2004a, Fig. 99.3

\*\* Tyre Al-Bass cem. IV Núñez 2004a, Fig. 111.P13.1

\*\* Tyre Al-Bass cem. Unstrat. Núñez 2004a, Fig. 111.P13.1

\*\* Tyre Al-Bass cem. Unstrat. Núñez 2004a, Fig. 116.P17

\*\* Tyre Al-Bass cem. Unstrat. Núñez 2004a, Fig. 118.P1.1

### **Iron III**

\* Al Mina V Lehmann 1996, Pl. 43 (263/1)

#### **Unclear Context**

\* Akhziv Unstrat. Culican 1982, Pl. 4k

\*\* Beqa' Valley Woolley 1921b, Figs 20, 22, 31-32

## Khalde Unstrat. Culican 1982, Pl. 5a-b

\*\* Qasmieh S. V. Chapman 1972, Fig. 32.312

\*\* Sarepta Area X unstrat. Pritchard 1988, Fig. 45.2

\* Sarepta Area X unstrat. Pritchard 1988, Fig. 46.3-5

\*\* Tell Abu Hawam III Hamilton 1935, 19, No. 52

\*\* Tell Abu Hawam III Hamilton 1934, Pl. 23.22

\*\* Tell Judeideh Unstrat. see Lehmann 1996, 409 (Form 260)

\* Tell Rachidiah Unstrat. Macridi-Bey 1904a, Pl. 6.11

## **B.9.11 CLASS 078**

### **Iron I**

\* Hama F1 Riis & Buhl 1990, 130 (Form XXIIb)

\*\* Hazor IX Yadin *et al.* 1961, Pl. 176.6

\*\* Khalde Tomb 166 Saidah 1966, No. 52

\*\* Khalde Tomb 167 Saidah 1966, Nos 55-56

\* Megiddo VIA Loud 1948, Fig. 80.1

\*\* Megiddo VIA Loud 1948, Fig. 80.2-4

Megiddo VIA Harrison 2004b, Pl. 15.9

\*\* Megiddo VIA Harrison 2004b, Pl. 18.3

\* Megiddo VIA Harrison 2004b, Pl. 18.5-6

\*\* Megiddo Area F level 5 (VIA) Finkelstein *et al.* 2000b, Fig. 11.3(7)

\* Tel Beth Shan VI James 1966, Fig. 51.11

\*\* Tell Abu Hawam IV Hamilton 1935, Fig. 14

\*\* Tell Abu Hawam V/IV Hamilton 1934, Pl. 22.8

\*\* Tell Abu Hawam V/IV Hamilton 1935, 41, No. 251

\*\* Tyre XIII Bikai 1978b, Pl. 33.22, 25

### **Iron I-II**

\*\* Akhziv TC3 E. Mazar 2001, Fig. 5.1

\* Megiddo VA-IVB Lamon & Shipton 1939, Fig. 36.12

\*\* Tel Beth Shan Northern cem. Oren 1973, Fig. 44b.18

Tel Beth Shan Northern cem. Oren 1973, Fig. 44b.19

\* Tel Dan IV Biran 1989b, Fig. 5.12

\*\* Tyre X Bikai 1978b, Pl. 25.12, 15

### **Iron II**

\* Hama Cem. III Riis 1948, Fig. 82

\* Hama Cem. IV Riis 1948, Fig. 82

\* Hama E Fugmann 1958, Fig. 344 (4B828)

\* Hama E2 Riis & Buhl 1990, 130 (Form XXIIb)

\*\* Joya S. V. Chapman 1972, Fig. 3.191-192

\*\* Khalde Tomb 4 Saidah 1966, No. 13

\*\* Khirbet Silm S. V. Chapman 1972, Fig. 3.46

\* Tell el Ghassil Area I level 2 Baramki 1964, Fig. 5.1

\*\* Tell Kazel Area I levels 9-10 Badre *et al.* 1994, Fig. 18.a

Tell Keisan 7 Briend & Humbert 1980, Pl. 51.9

Tell Tayinat Building phase 1 see Lehmann 1996, 410 (Form 261)

Tell Tayinat Building phase 2 see Lehmann 1996, 410 (Form 261)

### **Iron II-III**

Tell Tayinat Building phase 3 see Lehmann 1996, 410 (Form 261)

#### **Unclear Context**

\*\* Beqa' Valley Woolley 1921b, Figs 16, 18-19, 21

## Byblos Unstrat. Homsy 2003, Pl. 5e

\*\* Sarepta Area X unstrat. Pritchard 1988, Fig. 45.1

## **B.9.12 CLASS 079**

### **Iron I-II**

\* Akhziv TC4 E. Mazar 2001, Fig. 10.12

### **Iron II**

# Joya S. V. Chapman 1972, Fig. 30.263

\*\* Khirbet Silm S. V. Chapman 1972, Fig. 17.75, 77

Khirbet Silm S. V. Chapman 1972, Fig. 30.159

### **Unclear Context**

Athlit Cremation cem. Johns 1938, Fig. 4.4

\* Sarepta Area X unstrat. Pritchard 1988, Fig. 47.16

## **B.9.13 CLASS 080**

### **Iron I**

\*\* Ain Dara Lower Mound Iron I Stone & Zimansky 1999, Fig. 80

\*\* Hazor IX/X Unpublished

\* Hazor XII Yadin *et al.* 1961, Pl. 202.1-2

\* Tel Beth Shan VI James 1966, Fig. 50.5

\*\* Tell Keisan 9a/b Briend & Humbert 1980, Pl. 62.3, 8

Tell Keisan 9a/b Briend & Humbert 1980, Pl. 62.4

#\* Tell Keisan 9a/b Briend & Humbert 1980, Pl. 62.6

\* Tyre XII Bikai 1978b, Pl. 32.7

### **Iron I-II**

CWP Akhziv TC4 E. Mazar 2001, Fig. 11.1-8

CWP Akhziv TC4 E. Mazar 2001, Fig. 12.1-4

#\* Akhziv TC4 E. Mazar 2001, Fig. 12.5

CWP Akhziv Tomb N1 E. Mazar 2004, Fig. 16.8

\* Megiddo VA-IVB Loud 1948, Fig. 90.7

#\* Tel Beth Shan V James 1966, Fig. 22.9

\*\* Tell Kazel Area I levels 14-16 Badre & Gubel 1999-2000, Fig. 6.b

\* Tyre X Bikai 1978b, Pl. 28.1-2

### **Iron II**

\* Chatal Höyük III Swift 1958, Fig. 45

\*\* Khirbet Silm S. V. Chapman 1972, Fig. 31.164-165, 167

Ras al-Bassit Tell level 3 Courbin 1982a, Fig. 1-2

\*\* Sarepta Area Y level D Anderson 1988, Pl. 32.20

Sarepta Area Y level D Anderson 1988, Pl. 34.17

\* Tel Jezreel Findgroup A Zimhoni 1997b, Fig. 2.15 (1)

\*\* Tell Afis Area B (Afis VIII) Virgilio 2005, Fig. 35.1

#\* Tell el Ghassil Area I level 2 Joukowsky 1972, Pl. 2.35

\* Tell Kazel Area I levels 9-10 Badre *et al.* 1994, Fig. 18.b

\* Tell Rachidiah Tomb IV Doumet 1982, Pl. XIII.106

Tyre Al-Bass cem. II Núñez 2004a, Fig. 102.4

### **Iron I-III**

\* Akhziv South Cem I Dayagi-Mendels 2002, 10-11 (43-44)

Akhziv South Cem I Dayagi-Mendels 2002, Fig. 3.1(85-86)

\*\* Akhziv South Cem X Dayagi-Mendels 2002, Fig. 3.9(29)

\* Akhziv South Cem XI Dayagi-Mendels 2002, 24 (23-24)

\*\* Akhziv South Cem XI Dayagi-Mendels 2002, 24 (25-27)

#\* Akhziv South Cem XI Dayagi-Mendels 2002, Fig. 3.10(28)

Akhziv South Cem XI Dayagi-Mendels 2002, Fig. 3.10(29)

\*\* Akhziv East Cem XVII Culican 1982, Fig. 10f

\*\* Akhziv East Cem XVII Dayagi-Mendels 2002, 66 (20)

CWP Akhziv Tomb N2 E. Mazar 2004, Fig. 16.6-7

### **Iron II-III**

\*\* Akhziv TC2 E. Mazar 2001, Fig. 21.7

\* Akhziv TC2 E. Mazar 2001, Fig. 26.1-7

# Akhziv Tomb N3 E. Mazar 2004, Fig. 12.6

CWP Beirut Bey 003 abandonment Badre 1997b, Fig. 38.8

### **Iron III**

- \*\* Al Mina VIII-V du Plat Taylor 1959, Fig. 2.1, 5-6
- \* Ras al-Bassit Cem. Courbin 1993a, Fig. 16.1(C1068)
- Ras al-Bassit Cem. Courbin 1993a, Fig. 15.2(C515), 3(C1881), 4(C1066), 5(C1070)

### **Unclear Context**

- CWP Beqa' Valley Woolley 1921b, Fig. 17
- \*\* Beqa' Valley Woolley 1921b, Figs 35-36
- Byblos Unstrat. Montet 1929, No. 996
- Chatal Höyük Unstrat. see Lehmann 1996, 409 (Form 261)
- \* Ras Ibn Hani Unstrat. Bounni *et al.* 1978, Figs 31.8; 32
- \*\* Sarepta Area X unstrat. Koehl 1985, Fig. 21.217

## **B.9.14 CLASS 081**

### **Iron I**

- BOR Tel Beth Shan V lower James 1966, Fig. 61.12

### **Iron I-II**

- \* Megiddo VA-IVB Lamon & Shipton 1939, Fig. 8.176
- \* Megiddo VA-IVB Loud 1948, Fig. 88.6-9
- \* Tel Beth Shan V James 1966, Fig. 22.1
- Tell el Ghassil Area I level 4 Baramki 1964, Fig. 7.2

### **Iron II**

- \*\* Al Mina IX du Plat Taylor 1959, Fig. 1.15
- BOR Hama Cem. IV Riis 1948, Fig. 133b
- \* Joya S. V. Chapman 1972, Fig. 31.266
- \*\* Khirbet Silm S. V. Chapman 1972, Fig. 10.15
- BOR Tel Jezreel Findgroup F Zimhoni 1997b, Fig. 2.12 (5)
- Tell el Ghassil Area I level 1 Baramki 1964, Fig. 8.7
- \* Tell el Ghassil Area I level 1 Baramki 1964, Fig. 17.1
- BOR Tell Rachidiah Tomb I Doumet-Serhal 2004h, Figs 5-6
- \* Tell Rachidiah Tomb IV Doumet 1982, Pl. XI.35, 43

### **Iron I-III**

- \* Akhziv South Cem XX Dayagi-Mendels 2002, 32 (51)
- \* Akhziv South Cem XX Dayagi-Mendels 2002, Fig. 3.16(49-50)
- \* Akhziv East Cem XXXVI Dayagi-Mendels 2002, Fig. 4.27(84)

### **Iron II-III**

- \* Akhziv East Cem XXIX Dayagi-Mendels 2002, Fig. 4.21(33)
- \*\* Akhziv East Cem XXIX Dayagi-Mendels 2002, Fig. 4.21(34)
- \* Akhziv Tomb N3 E. Mazar 2004, Fig. 16.5
- \*\* Al Mina VIII du Plat Taylor 1959, Fig. 1.15

### **Iron III**

- \*\* Al Mina V du Plat Taylor 1959, Fig. 1.15

### **Iron II-Persian**

- \*\* Akhziv South Cem 72 E. Mazar 2001, Fig. 65.12

### **Persian**

- \*\* Tell Keisan 3 Briend & Humbert 1980, Pl. 19.4-5

## **B.9.15 CLASS 082**

### **B.9.15.1 CLASS 082a**

#### **Iron I**

- # Hazor IX Yadin *et al.* 1961, Pl. 176.5
- # Hazor IX/X Unpublished
- # Megiddo VB Lamon & Shipton 1939, Fig. 6.148

#### **Iron I-II**

- # Akhziv South Cem III Dayagi-Mendels 2002, 13 (7-9)
- # Akhziv South Cem 500 E. Mazar 2001, Fig. 69.3-4

# Akhziv TC4 E. Mazar 2001, Fig. 9.3-4  
Akhziv TC4 E. Mazar 2001, Fig. 9.5  
Akhziv Tomb N1 E. Mazar 2004, Fig. 10.4

#### **Iron II**

Akhziv South Cem 73 E. Mazar 2001, Fig. 43.5-6  
# Chatal Höyük III see Lehmann 1996, 417 (Form 302)  
Hazor V Yadin *et al.* 1958, Pl. 69.8  
# Hazor VII Yadin *et al.* 1958, Pl. 50.16  
# Hazor VIII Yadin *et al.* 1960, Pl. 58.27  
# Joya S. V. Chapman 1972, Fig. 26.259  
# Khalde Tomb 3 Saidah 1966, No. 9  
# Khirbet Silm S. V. Chapman 1972, Fig. 26.139, 143-144  
# Megiddo IVA Lamon & Shipton 1939, Fig. 3.83-85  
Sidon Iron II Doumet-Serhal 2000, Pl. 21.3-4  
# Sarepta Area Y level D Anderson 1988, Pl. 34.5  
# Tel Beth Shan V upper James 1966, Fig. 66.2  
# Tell Arqa 10 Unpublished  
Tell el Ghassil Area I level 2 Joukowsky 1972, Pl. 2.33  
# Tell Rachidiah Tomb I Chehab 1983, Pl. XXII.2  
# Tell Rachidiah Tomb IV Doumet 1982, Pl. X.50, 54, 59  
# Tyre Al-Bass cem. II Núñez 2004a, Fig. 68.2-3  
# Tyre Al-Bass cem. II Núñez 2004a, Fig. 76.2  
# Tyre Al-Bass cem. III Núñez 2004a, Fig. 52.3  
# Tyre Al-Bass cem. III Núñez 2004a, Fig. 56.3  
# Tyre Al-Bass cem. III Núñez 2004a, Fig. 96.3

#### **Iron I-III**

# Akhziv South Cem I Dayagi-Mendels 2002, 6 (20-32, 34-36)  
# Akhziv South Cem I Dayagi-Mendels 2002, 10 (11-18)  
# Akhziv South Cem I Dayagi-Mendels 2002, Fig. 3.1(33)  
# Akhziv South Cem X Dayagi-Mendels 2002, 21 (6, 8)  
# Akhziv South Cem X Dayagi-Mendels 2002, Fig. 3.9(7)  
Akhziv South Cem X Dayagi-Mendels 2002, Fig. 3.9(9)  
# Akhziv South Cem XX Dayagi-Mendels 2002, Fig. 3.16(10)  
Akhziv South Cem XX Dayagi-Mendels 2002, Fig. 3.16(14)  
# Akhziv East Cem IV Dayagi-Mendels 2002, 43 (1-2)  
# Akhziv East Cem XVII Culican 1982, Fig. 10a  
# Akhziv East Cem XVII Dayagi-Mendels 2002, 66 (9-10)  
# Akhziv East Cem XXXVI Culican 1982, Fig. 9a-b  
# Akhziv East Cem XXXVI Dayagi-Mendels 2002, 91 (12-13)  
# Akhziv East Cem XXXVI Dayagi-Mendels 2002, Fig. 4.27(14, 16)

#### **Iron II-III**

# Akhziv South Cem V Dayagi-Mendels 2002, 17 (1)  
# Akhziv South Cem XVIII Dayagi-Mendels 2002, 28 (6)  
# Akhziv South Cem XVIII Dayagi-Mendels 2002, Fig. 3.14(5)  
# Akhziv South Cem XXI Dayagi-Mendels 2002, 36 (3-6)  
Akhziv East Cem V Dayagi-Mendels 2002, Fig. 4.4(1)  
# Akhziv East Cem XI Dayagi-Mendels 2002, Fig. 4.9(2)  
Akhziv East Cem XI Dayagi-Mendels 2002, Fig. 4.9(4)  
# Akhziv East Cem XXIX Culican 1975-1976, Fig. A.c-d  
# Akhziv East Cem XXIX Dayagi-Mendels 2002, Fig. 4.21(12)  
# Akhziv TC2 E. Mazar 2001, Fig. 20b.17  
# Akhziv Tomb N3 E. Mazar 2004, Fig. 6.2-9, 11-13, 15-19  
Akhziv Tomb N3 E. Mazar 2004, Fig. 10.4, 16  
# Beirut Bey 003 abandonment Badre 1997b, Fig. 36.13-14  
# Beirut Bey 003 abandonment Badre 2000b, Fig. 5.10  
# Tyre Al-Bass cem. IV Núñez 2004a, Fig. 50.3  
# Tyre Al-Bass cem. IV Núñez 2004a, Fig. 51.3  
# Tyre Al-Bass cem. IV Núñez 2004a, Fig. 60.2-3  
# Tyre Al-Bass cem. IV Núñez 2004a, Fig. 67.3  
# Tyre Al-Bass cem. IV Núñez 2004a, Fig. 71.3

- # Tyre Al-Bass cem. IV Núñez 2004a, Fig. 75.3-4
- # Tyre Al-Bass cem. IV Núñez 2004a, Fig. 77.3
- # Tyre Al-Bass cem. IV Núñez 2004a, Fig. 80.2
- # Tyre Al-Bass cem. IV Núñez 2004a, Fig. 98.2
- # Tyre Al-Bass cem. IV Núñez 2004a, Fig. 104.3
- # Tyre Al-Bass cem. Unstrat. Seeden 1991, Figs 23-30
- # Tyre Al-Bass cem. Unstrat. Aubet 2004a, Fig. 8a
- # Tyre Al-Bass cem. Unstrat. Núñez 2004a, Fig. 81.2
- # Tyre Al-Bass cem. Unstrat. Núñez 2004a, Fig. 113.P15

**Iron III**

- # Al Mina VII/VI du Plat Taylor 1959, Fig. 7.7
- Megiddo II/III Lamon & Shipton 1939, Fig. 3.83-85
- # Tyre Al-Bass cem. V Núñez 2004a, Fig. 65.3
- # Tyre Al-Bass cem. V Núñez 2004a, Fig. 90.2

**Iron I-Persian**

- # Akhziv East Cem IX Dayagi-Mendels 2002, 47 (3)
- # Akhziv East Cem IX Dayagi-Mendels 2002, Fig. 4.7(2)

**Iron II-Persian**

- # Akhziv South Cem 68 E. Mazar 2001, Fig. 52.22-25
- # Akhziv South Cem 70 E. Mazar 2001, Fig. 62.5-6
- # Akhziv South Cem 72 E. Mazar 2001, Fig. 65.1-3
- # Akhziv East Cem XII Dayagi-Mendels 2002, 57 (3)
- # Akhziv East Cem XII Dayagi-Mendels 2002, Fig. 4.10(4)
- # Akhziv East Cem XIV Dayagi-Mendels 2002, 62 (1-3)

**Iron III-Persian**

- # Akhziv Tomb N4 E. Mazar 2004, Fig. 6.10
- Akhziv Tomb N4 E. Mazar 2004, Fig. 10.1-2, 9, 14
- Akhziv Tomb N4 E. Mazar 2004, Fig. 12.5

**Unclear Context**

- # Byblos Unstrat. Homsy 2003, Pl. 4a
- # Khalde Unstrat. Culican 1982, Pl. 5c
- # Qasmieh S. V. Chapman 1972, Fig. 32.316
- # Ras Ibn Hani Unstrat. Bounni *et al.* 1978, Fig. 31.13
- Tell Rachidiah Unstrat. Macridi-Bey 1904a, Pl. 6.2

**B.9.15.2 CLASS 082b**

**Iron I**

- # Hazor IX/X Yadin *et al.* 1961, Pl. 177.15-16

**Iron I-II**

- # Akhziv TC4 E. Mazar 2001, Fig. 9.1-2

**Iron II**

- # Hazor V Yadin *et al.* 1961, Pl. 189.17
- # Joya S. V. Chapman 1972, Fig. 27.261
- \* Khirbet Silm S. V. Chapman 1972, Fig. 10.16-17
- \*\* Khirbet Silm S. V. Chapman 1972, Fig. 11.21, 23-24
- # Khirbet Silm S. V. Chapman 1972, Fig. 27.149
- # Tel Beth Shan IV James 1966, Fig. 71.4
- # Tel Beth Shan V upper James 1966, Fig. 66.3
- # Tel Beth Shan Area P level 7 A. Mazar 2001, Fig. 12.4
- # Tell el Ghassil Area I level 1 Baramki 1964, Fig. 17.4
- # Tell Judeideh IV see Lehmann 1996, 416 (Form 300)
- # Tell Rachidiah Tomb IV Doumet 1982, Pl. X.34
- # Tyre IX Bikai 1978b, Pl. 20.1
- # Tyre Al-Bass cem. II Núñez 2004a, Fig. 102.3
- Tyre Al-Bass cem. III Núñez 2004a, Fig. 52.4

**Iron I-III**

- Akhziv East Cem XXXVI Dayagi-Mendels 2002, Fig. 4.27(18)

**Iron II-III**



# Tyre Al-Bass cem. IV Núñez 2004a, Fig. 63.3  
# Tyre Al-Bass cem. Unstrat. Seeden 1991, Figs 19-20

**Iron III**

Tell Sukas G3 Buhl 1983, Fig. XVI.274

**Unclear Context**

# Athlit Cremation cem. Johns 1938, Fig. 6.1  
# Khalde Unstrat. Culican 1982, Pl. 5d

**B.9.15.3 CLASS 082c**

**Iron I**

# Hazor IX Yadin *et al.* 1961, Pl. 208.37  
# Hazor IX/X Unpublished  
\* Tell Keisan 9c Briend & Humbert 1980, Pl. 70.3a-t

**Iron I-II**

# Akhziv East Cem XXXIX Dayagi-Mendels 2002, Fig. 4.28(3)  
# Akhziv Tomb N1 E. Mazar 2004, Fig. 6.1  
# Megiddo VA-IVB Loud 1948, Fig. 88.2

**Iron II**

# Hazor V Yadin *et al.* 1960, Pl. 87.3  
# Hazor V Yadin *et al.* 1961, Pl. 228.12  
# Khirbet Silm S. V. Chapman 1972, Fig. 26.146  
# Khirbet Silm S. V. Chapman 1972, Fig. 27.147-148  
# Tell el Ghassil Area III level 2 Joukowsky 1972, Pl. 18.36

**Iron I-III**

# Akhziv South Cem I Dayagi-Mendels 2002, Fig. 3.2(10)

**Iron II-III**

\* Akhziv East Cem XI Dayagi-Mendels 2002, Fig. 4.9(3)

**B.9.15.4 CLASS 082d**

**Iron I-II**

# Megiddo VA-IVB Loud 1948, Fig. 88.1

**Iron II**

Hama Cem. IV Riis 1948, Fig. 74  
# Hazor VII Yadin *et al.* 1960, Pl. 64.19  
Tel Dan II Pakman 1992, Fig. 2.7-8  
\*\* Tyre VI Bikai 1978b, Pl. 18.18

**Iron I-III**

# Akhziv South Cem I Dayagi-Mendels 2002, 6 (37)  
# Akhziv South Cem XX Dayagi-Mendels 2002, Fig. 3.16(13)

**Iron II-III**

# Akhziv East Cem XXIX Culican 1975-1976, Fig. A.b  
Akhziv East Cem XXIX Culican 1975-1976, Fig. A.u  
# Akhziv East Cem XXIX Dayagi-Mendels 2002, 78 (14)  
# Akhziv East Cem XXIX Dayagi-Mendels 2002, Fig. 4.21(13)  
\* Akhziv East Cem XXIX Dayagi-Mendels 2002, Fig. 4.21(28)  
\* Akhziv TC2 E. Mazar 2001, Fig. 21.8  
\* Beirut Bey 003 abandonment Badre 1997b, Fig. 37.15

**Iron III**

# Tyre Al-Bass cem. V Núñez 2004a, Fig. 57.2

**Iron I-Persian**

# Akhziv East Cem IX Dayagi-Mendels 2002, Fig. 4.7(6)

**Iron III-Persian**

\* Akhziv Tomb N4 E. Mazar 2004, Fig. 10.15

## **B.9.15.5 CLASS 082e**

### **Iron I**

- # Megiddo VB Lamon & Shipton 1939, Fig. 6.156
- # Tel Beth Shan V lower James 1966, Fig. 61.9
- \* Tell Kazel Area II level 5 Badre 1990b, Fig. 39.g
- \*\* Tell Kazel Area IV level 3 Badre & Gubel 1999-2000, Fig. 46.d
- \*\* Tell Kazel Area IV level 4 Badre & Gubel 1999-2000, Fig. 43.e-g
- \* Tell Keisan 9c Briand & Humbert 1980, Pl. 70.2

### **Iron I-II**

- # Megiddo VA-IVB Lamon & Shipton 1939, Fig. 6.156
- # Tel Beth Shan V James 1966, Figs 4.4; 19.13

### **Iron II**

- Hama Cem. IV Riis 1948, Fig. 75
- Hama E1 Riis & Buhl 1990, 130 (Form XVIB)
- # Hazor VI Yadin *et al.* 1958, Pl. 52.13
- # Hazor VI Yadin *et al.* 1961, Pl. 185.5
- # Hazor VIII Yadin *et al.* 1960, Pl. 58.25
- \* Jorya S. V. Chapman 1972, Fig. 10.171
- \* Khalde Tomb 121 Saidah 1966, No. 25
- # Khirbet Silm S. V. Chapman 1972, Fig. 26.145
- # Megiddo IVA Lamon & Shipton 1939, Fig. 3.86, 89
- # Megiddo Area H level 3 (IVA) Finkelstein *et al.* 2000b, Figs 11.45(5, 7); 46(5)
- Tell el Ghassil Area I level 2 Baramki 1964, Fig. 1.1
- Tell el Ghassil Area I level 1 Baramki 1964, Fig. 9.4
- # Tell el Ghassil Area I level 1 Baramki 1964, Fig. 11.3
- # Tell Rachidiah Tomb IV Doumet 1982, Pl. X.40

### **Iron I-III**

- # Akhziv South Cem XX Dayagi-Mendels 2002, Fig. 3.16(12)
- # Akhziv East Cem XXXVI Dayagi-Mendels 2002, Fig. 4.27(15)
- Akhziv East Cem XXXVI Dayagi-Mendels 2002, Fig. 4.27(17, 19)

### **Iron II-III**

- # Sarepta Area Y level C Anderson 1988, Pl. 37.1
- # Tyre Al-Bass cem. IV Núñez 2004a, Fig. 83.2

### **Iron III**

- \* Megiddo II/III Lamon & Shipton 1939, Fig. 3.86, 89

### **Iron I-Persian**

- Akhziv East Cem IX Dayagi-Mendels 2002, Fig. 4.7(5)

### **Iron II-Persian**

- # Akhziv South Cem III Dayagi-Mendels 2002, Fig. 3.4(10)
- # Akhziv East Cem IX Dayagi-Mendels 2002, 47 (7)

### **Persian**

- # Athlit Tomb 23 Johns 1932, Pl. 29b
- Tell Sukas South Harbour cem. Riis 1979, Figs 14-15

### **Unclear Context**

- Akhziv Unstrat. Culican 1982, Pl. 4i
- # Al Mina Unstrat. see Lehmann 1996, 418 (Form 306)
- Athlit Cremation cem. Johns 1938, Fig. 16.4
- # Chatal Höyük Unstrat. Swift 1958, Fig. 41
- # Tell Rachidiah Unstrat. Macridi-Bey 1904a, Pl. 6.20

## **B.9.16 CLASS 083**

### **Iron I-II**

- Akhziv TC4 E. Mazar 2001, Fig. 10.9

### **Iron II**

- # Megiddo Area H level 3 (IVA) Finkelstein *et al.* 2000b, Fig. 11.53(6)

### **Iron I-III**

- \* Akhziv East Cem XXXVI Culican 1982, Fig. 9g

## B.9.17 CLASS 084

### Iron I

- BOR Hazor IX Yadin *et al.* 1960, Pl. 52.17  
\* Hazor IX/X Yadin *et al.* 1958, Pl. 46.1  
\* Hazor IX/X Yadin *et al.* 1961, Pl. 177.14  
## Hazor IX/X Unpublished  
BOR Hazor X Yadin *et al.* 1961, Pl. 172.1  
BOR Megiddo VB Lamon & Shipton 1939, Fig. 5.123  
BOR Megiddo VB Lamon & Shipton 1939, Fig. 17.87  
BOR Tel Beth Shan V lower James 1966, Fig. 61.6

### Iron I-II

- ## Akhziv East Cem XXXIX Dayagi-Mendels 2002, 103 (9)  
\* Akhziv TC4 E. Mazar 2001, Fig. 10.6-7  
Akhziv TC4 E. Mazar 2001, Fig. 10.8  
Akhziv Tomb N1 E. Mazar 2004, Fig. 14.17-21, 23-24, 26-35  
BOR Akhziv Tomb N1 E. Mazar 2004, Fig. 16.2-3  
## Byblos Necropolis K Salles 1980, Pl. 9.1  
BOR Megiddo VA-IVB Lamon & Shipton 1939, Fig. 5.123  
BOR Megiddo VA-IVB Lamon & Shipton 1939, Fig. 17.87  
\* Megiddo VA-IVB Loud 1948, Fig. 89.6  
BOR Tel Beth Shan V James 1966, Fig. 1.4  
BOR Tel Beth Shan V James 1966, Fig. 8.3  
BOR Tel Beth Shan V James 1966, Figs 13.8; 18.21  
\* Tel Dan IV Biran 1982, Fig. 27.1  
Tell el Ghassil Area I level 4 Joukowsky 1972, Pl. 9.15

### Iron II

- BOR Hama Cem. IV Riis 1948, Fig. 133c  
## Hama E Fugmann 1958, Fig. 325 (8A162)  
BOR Hazor V Yadin *et al.* 1961, Pl. 228.22  
BOR Hazor V Ben Tor *et al.* 1997, Fig. III.42 (16)  
\* Hazor VI Ben Tor *et al.* 1997, Fig. II.54 (31)  
## Hazor VI Ben Tor *et al.* 1997, Fig. III.39 (26)  
\* Hazor VII Yadin *et al.* 1958, Pl. 50.14  
\* Khirbet Silm S. V. Chapman 1972, Fig. 31.161-162  
Ras al-Bassit Cem. Courbin 1993a, Fig. 16.2(C1079), 3(C1080)  
\* Tell Abou Danne IId/A6 Lebeau 1983, Pl. 144.2-3  
BOR Tell el Ghassil Area I level 2 Baramki 1964, Fig. 37.1  
Tell Kazel Iron II Dunand *et al.* 1964, Pl. 11.1  
CWP Tell Mastuma Central Area level I-1 Wakita *et al.* 2000, Fig. 9.1  
\* Tell Rifa'at 2b-c Matthers 1981b, Fig. 233.9  
BOR Tyre VIII Bikai 1978b, Pl. 22.9-10

### Iron I-III

- ## Akhziv South Cem I Dayagi-Mendels 2002, 8 (84)  
\* Akhziv South Cem I Dayagi-Mendels 2002, Fig. 3.2(26)  
\* Akhziv South Cem X Dayagi-Mendels 2002, Fig. 3.9(28)  
## Akhziv South Cem XI Dayagi-Mendels 2002, 24 (22)  
\* Akhziv South Cem XX Dayagi-Mendels 2002, Fig. 3.16(52)  
## Akhziv South Cem XX Dayagi-Mendels 2002, Fig. 3.16(53-56)  
BOR Akhziv East Cem XXXVI Culican 1982, Fig. 9j-k  
## Akhziv East Cem XXXVI Dayagi-Mendels 2002, Fig. 4.27(81)  
BOR Akhziv Tomb N2 E. Mazar 2004, Fig. 16.4

### Iron II-III

- ##\* Akhziv East Cem XXIX Dayagi-Mendels 2002, 80 (36)  
## Akhziv East Cem XXIX Dayagi-Mendels 2002, Fig. 4.21(35)  
## Akhziv TC2 E. Mazar 2001, Fig. 21.1-2, 4-5  
\* Akhziv TC2 E. Mazar 2001, Fig. 21.5-6  
\*\* Al Mina VIII du Plat Taylor 1959, Fig. 2.12  
\*\* Al Mina VIII du Plat Taylor 1959, Fig. 2.13  
BOR Beirut Bey 003 abandonment Badre 1997b, Fig. 38.11  
BOR Beirut Bey 003 abandonment Badre 1998, Fig. 8.11

- \*\* Deve Höyük Cem. I Moorey 1980, Fig. 3.13
- \* Deve Höyük Cem. I Moorey 1980, Fig. 3.14
- Iron III**
- \*\* Al Mina V du Plat Taylor 1959, Fig. 2.13
- BOR Al Mina VIII-V du Plat Taylor 1959, Fig. 5.8
- \*\* Al Mina VIII/VII du Plat Taylor 1959, Fig. 1.14
- BOR Megiddo II/III Lamon & Shipton 1939, Fig. 5.123
- BOR Megiddo II/III Lamon & Shipton 1939, Fig. 17.87
- Iron II-Persian**
- \*\* Akhziv South Cem III Dayagi-Mendels 2002, Fig. 3.4(22)
- Iron III-Persian**
- \*\* Kefrik Unstrat. Moorey 1980, Fig. 23.559-562
- Persian**
- ## Athlit Tomb 21b Johns 1932, Fig. 47
- Unclear Context**
- # Athlit Cremation cem. Johns 1938, Fig. 4.1-2
- \* Athlit Cremation cem. Johns 1938, Fig. 6.3
- ## Athlit Cremation cem. Johns 1938, Fig. 6.4
- \* Athlit Cremation cem. Johns 1938, Fig. 11.4
- \*\* Beqa' Valley Woolley 1921b, Fig. 33
- \* Jerablus Yunus cem. Woolley 1939b, Pl. 16.a.1
- \* Jerablus Yunus cem. Woolley 1939b, Pl. 16.b.1-3
- \* Tell Abu Hawam III Hamilton 1935, Pl. 13.86
- BOR Tell Kazel Unstrat. Yon & Caubet 1990, Fig. 3.182
- Tell Rachidiah Unstrat. Macridi-Bey 1904a, Pl. 6.7

## B.9.18 CLASS 085

### B.9.18.1 CLASS 085a

- Iron I-II**
- Akhziv South Cem 500 E. Mazar 2001, Fig. 69.6
- Iron II**
- Akhziv East Cem XXVI Dayagi-Mendels 2002, Fig. 4.19(3)
- \*\* Akhziv South Cem 73 E. Mazar 2001, Fig. 43.7
- \*\* Hazor VI Yadin *et al.* 1958, Pl. 52.22
- Hazor VI Yadin *et al.* 1960, Pl. 70.25
- Hazor VII Yadin *et al.* 1961, Pl. 248.16
- Khalde Tomb 3 Saidah 1966, No. 11
- Tell el Ghassil Area I level 3 Baramki 1964, Fig. 1.2
- Tell Keisan 7 Briend & Humbert 1980, Pl. 51.3
- \*\* Tyre III Bikai 1978b, Pl. 5.14
- Iron I-III**
- \*\* Akhziv South Cem I Dayagi-Mendels 2002, Fig. 3.2(22)
- # Akhziv South Cem X Dayagi-Mendels 2002, Fig. 3.9(13, 18)
- Akhziv East Cem XXXVI Dayagi-Mendels 2002, Fig. 4.27(29)
- \*\* Akhziv East Cem XXXVI Dayagi-Mendels 2002, Fig. 4.27(51)
- \*\* Akhziv Tomb N2 E. Mazar 2004, Fig. 7.13-14
- Iron II-III**
- # Akhziv East Cem XXIX Culican 1975-1976, Fig. A.g
- \*\* Akhziv East Cem XXIX Culican 1975-1976, Fig. A.n
- Akhziv East Cem XLIII Dayagi-Mendels 2002, 106 (XLIII.1)
- ## Akhziv Tomb N3 E. Mazar 2004, Fig. 9.1
- \* Akhziv Tomb N3 E. Mazar 2004, Figs 7.15, 17; 8.3-4
- \*\* Akhziv Tomb N3 E. Mazar 2004, Figs 7.1, 3, 12, 16; 8.1, 5, 6, 8-9
- \*\* Beirut Bey 003 storage Badre 1997b, Fig. 45.12
- Tyre I Bikai 1978b, Pl. 1.3
- Iron III**
- Akhziv East Cem XXIV Culican 1970, Fig. 2B.4

- \*\* Al Mina VII du Plat Taylor 1959, Fig. 2.8
- Sarepta Tomb 26 Culican 1970, Fig. 3.8
- Tell Keisan 4 Briend & Humbert 1980, Pl. 28.8
- Tell Keisan 5 Briend & Humbert 1980, Pl. 44.3
- Tyre Al-Bass cem. V Núñez 2004a, Fig. 58.2
- \*\* Tyre Al-Bass cem. V Núñez 2004a, Fig. 66.3
- Tyre Al-Bass cem. V Núñez 2004a, Fig. 90.3
- Iron I-Persian**
- Akhziv East Cem IX Dayagi-Mendels 2002, Fig. 4.7(9)
- Iron II-Persian**
- Akhziv East Cem XII Dayagi-Mendels 2002, Fig. 4.10(5)
- Akhziv East Cem XIV Dayagi-Mendels 2002, 62 (5-7)
- \*\* Akhziv East Cem XIV Dayagi-Mendels 2002, 62 (8)
- Akhziv East Cem XIV Dayagi-Mendels 2002, Fig. 4.12(9)
- \* Akhziv South Cem 70 E. Mazar 2001, Fig. 62.11
- \*\* Akhziv South Cem 72 E. Mazar 2001, Fig. 65.4
- Iron III-Persian**
- Akhziv Tomb N4 E. Mazar 2004, Fig. 8.2, 7
- Unclear Context**
- \*\* Athlit Cremation cem. Johns 1938, Fig. 7.1
- Athlit Cremation cem. Johns 1938, Fig. 16.6
- \*\* Sarepta Area X unstrat. Pritchard 1988, Fig. 47.18
- \* Sarepta Area X unstrat. Pritchard 1988, Fig. 47.19
- Tell Rachidiah Unstrat. Macridi-Bey 1904a, Pl. 6.6

## **B.9.18.2 CLASS 085b**

### **Iron I**

- \* Hazor IX/X Unpublished
- Megiddo Area K level 3 (VB) Finkelstein *et al.* 2000b, Fig. 11.19(16)
- \*\* Sarepta Area Y level E Anderson 1988, Pl. 31.15
- Iron I-II
- \*\* Akhziv East Cem II Dayagi-Mendels 2002, 37 (1)
- \*\* Akhziv TC4 E. Mazar 2001, Fig. 8.5-7

### **Iron II**

- \*\* Akhziv East Cem XXVI Dayagi-Mendels 2002, 73 (4)
- \*\* Akhziv South Cem 73 E. Mazar 2001, Fig. 43.8
- # Chatal Höyük III see Lehmann 1996, 403 (Form 235)
- # Hazor VI Ben Tor *et al.* 1997, Fig. III.37 (4)
- Hazor VII Yadin *et al.* 1958, Pl. 50.15
- Hazor VIII Yadin *et al.* 1960, Pl. 58.20, 23-24
- \*\* Joya S. V. Chapman 1972, Fig. 6.178
- \*\* Khirbet Silm S. V. Chapman 1972, Fig. 6.33, 40
- \* Khirbet Silm S. V. Chapman 1972, Fig. 6.41
- Tell el Ghassil Area I level 2 Baramki 1964, Fig. 2.4
- Tell Kazel Area I levels 6-13 Badre & Gubel 1999-2000, Fig. 5.d
- \*\* Tell Rachidiah Tomb IV Doumet 1982, Pl. XIII.70
- \*\* Tyre III Bikai 1978b, Pl. 5.15-17
- \*\* Tyre Al-Bass cem. III Núñez 2004a, Fig. 53.2, 5
- \*\* Tyre Al-Bass cem. III Núñez 2004a, Fig. 89.2
- \*\* Tyre Al-Bass cem. III Núñez 2004a, Fig. 106.3

### **Iron I-III**

- \*\* Akhziv South Cem I Dayagi-Mendels 2002, 10 (21)
- \*\* Akhziv South Cem I Dayagi-Mendels 2002, 12 (3)
- \*\* Akhziv South Cem I Dayagi-Mendels 2002, Fig. 3.1(50)
- \*\* Akhziv South Cem X Dayagi-Mendels 2002, Fig. 3.9(20)
- \*\* Akhziv South Cem XX Dayagi-Mendels 2002, 31 (16-21)
- \*\* Akhziv East Cem XVII Dayagi-Mendels 2002, 66 (15-16)
- Akhziv East Cem XXXVI Culican 1982, Fig. 91

- Akhziv East Cem XXXVI Dayagi-Mendels 2002, 91 (38-39); 94 (45-47)  
 Akhziv East Cem XXXVI Dayagi-Mendels 2002, 94 (42, 48-50)  
 \*\* Akhziv East Cem XXXVI Dayagi-Mendels 2002, 94 (52-53)  
 \*\* Akhziv East Cem XXXVI Dayagi-Mendels 2002, Fig. 4.27(40, 43-44)

### **Iron II-III**

- \*\* Akhziv South Cem IV Dayagi-Mendels 2002, 16 (1, 3)  
 \*\* Akhziv South Cem IV Dayagi-Mendels 2002, Fig. 3.5(2)  
 \*\* Akhziv South Cem XVIII Dayagi-Mendels 2002, 29 (8)  
 Akhziv South Cem XVIII Dayagi-Mendels 2002, Fig. 3.14(9)  
 \*\* Akhziv East Cem XXIX Culican 1975-1976, Fig. A.m  
 \*\* Akhziv East Cem XXIX Dayagi-Mendels 2002, 78 (19)  
 # Akhziv East Cem XXIX Dayagi-Mendels 2002, Fig. 4.21(18)  
 \*\* Akhziv East Cem XXIX Dayagi-Mendels 2002, Fig. 4.21(20)  
 \*\* Akhziv Tomb N3 E. Mazar 2004, Fig. 7.2, 4-5, 9-10  
 \* Akhziv Tomb N3 E. Mazar 2004, Fig. 6-8, 11  
 \*\* Al Mina VIII du Plat Taylor 1959, Fig. 2.9  
 \*\* Sarepta Area Y level C Anderson 1988, Pl. 36.9  
 \*\* Tyre Al-Bass cem. IV Núñez 2004a, Fig. 50.4  
 \* Tyre Al-Bass cem. IV Núñez 2004a, Fig. 60.5  
 \*\* Tyre Al-Bass cem. IV Núñez 2004a, Fig. 64.2  
 \* Tyre Al-Bass cem. IV Núñez 2004a, Fig. 71.4  
 \*\* Tyre Al-Bass cem. IV Núñez 2004a, Fig. 73.3  
 \*\* Tyre Al-Bass cem. IV Núñez 2004a, Fig. 74.2  
 \*\* Tyre Al-Bass cem. IV Núñez 2004a, Fig. 78.3  
 \* Tyre Al-Bass cem. IV Núñez 2004a, Fig. 80.3  
 \*\* Tyre Al-Bass cem. IV Núñez 2004a, Fig. 92.3  
 \*\* Tyre Al-Bass cem. IV Núñez 2004a, Fig. 99.2  
 \*\* Tyre Al-Bass cem. IV Núñez 2004a, Fig. 99.4  
 \*\* Tyre Al-Bass cem. IV Núñez 2004a, Fig. 103.3  
 ## Tyre Al-Bass cem. Unstrat. Seeden 1991, Figs 33-34  
 \*\* Tyre Al-Bass cem. Unstrat. Seeden 1991, Figs 35-38  
 \*\* Tyre Al-Bass cem. Unstrat. Aubet 2004a, Fig. 8a  
 \*\* Tyre Al-Bass cem. Unstrat. Núñez 2004a, Fig. 115.P20  
 \*\* Tyre Al-Bass cem. Unstrat. Núñez 2004a, Fig. 116.P14.1

### **Iron III**

- \*\* Megiddo II/III Lamon & Shipton 1939, Fig. 3.79  
 Tell Sukas G3 Buhl 1983, Fig. X.106

### **Iron I-Persian**

- \*\* Akhziv East Cem IX Dayagi-Mendels 2002, 47 (11)  
 \* Akhziv East Cem IX Dayagi-Mendels 2002, Fig. 4.7(10)

### **Iron II-Persian**

- \*\* Akhziv South Cem III Dayagi-Mendels 2002, 15 (16)  
 \* Akhziv South Cem III Dayagi-Mendels 2002, Fig. 3.4(15)  
 \* Akhziv South Cem 68 E. Mazar 2001, Fig. 52.17  
 \*\* Akhziv South Cem 68 E. Mazar 2001, Fig. 52.18  
 \*\* Akhziv South Cem 70 E. Mazar 2001, Fig. 62.9

### **Iron III-Persian**

- \* Kefrik Unstrat. Moorey 1980, Fig. 23.564

### **Unclear Context**

- \*\* Akhziv East Cem XXX Dayagi-Mendels 2002, 85 (1)  
 \*\* Al Mina Unstrat. du Plat Taylor 1959, Fig. 2.10-11  
 \*\* Beqa' Valley Woolley 1921b, Fig. 43  
 # Byblos Unstrat. Homsy 2003, Pl. 6b  
 Byblos Unstrat. Homsy 2003, Pl. 6c, e  
 \* Byblos Unstrat. Homsy 2003, Pl. 6d  
 \* Jerablus Yunus cem. Woolley 1939b, Pl. 16.a.2  
 \* Khalde Unstrat. Saidah 1971, 197 1d-e  
 Sarepta Unstrat. see Lehmann 1996, 404 (Form 239)  
 \*\* Tell Abu Hawam III Hamilton 1935, Pl. 13.78

## B.9.19 CLASS 086

### Iron I-II

Tel Beth Shan V James 1966, Fig. 22.8

Tell Sukas H Buhl 1983, Fig. XI.136

### Iron II

Hazor V Yadin *et al.* 1961, Pl. 224.9

Hazor V Yadin *et al.* 1961, Pl. 228.7-9

Hazor VII Yadin *et al.* 1958, Pl. 50.23

Khalde Tomb 1 Saidah 1966, No. 2

Megiddo Area H level 3 (IVA) Finkelstein *et al.* 2000b, Fig. 11.53(3)

Sidon Irhal II Doumet-Serhal 2000, Pl. 21.1-2

Tel Beth Shan Area P level 7 A. Mazar 2001, Fig. 12.4

### Iron I-III

Akhziv East Cem XVII Culican 1982, Fig. 10b

\* Akhziv East Cem XVII Dayagi-Mendels 2002, 66 (14)

\*\* Akhziv East Cem XXXVI Dayagi-Mendels 2002, 91 (30)

Akhziv East Cem XXXVI Dayagi-Mendels 2002, 91 (32-34, 37)

Akhziv East Cem XXXVI Dayagi-Mendels 2002, Fig. 4.27(31, 35)

### Iron II-III

\* Akhziv East Cem XI Dayagi-Mendels 2002, 56 (6)

### Iron III

Al Mina VII/VI du Plat Taylor 1959, Fig. 7.5-6

## B.9.20 CLASS 087

### Iron II

# Hazor V Yadin *et al.* 1960, Pl. 87.13-14, 19

# Hazor VI Yadin *et al.* 1961, Pl. 219.20

# Hazor VII Yadin *et al.* 1960, Pl. 64.22

# Hazor VII Yadin *et al.* 1961, Pl. 215.14

# Hazor VIII Yadin *et al.* 1960, Pl. 58.16

# Tell Mastuma Central Area level I-1 Wakita *et al.* 2000, Fig. 9.2

# Tyre II Bikai 1978b, Pl. 6.4-5

# Tyre III Bikai 1978b, Pl. 5.19-23

### Iron I-III

# Akhziv South Cem I Dayagi-Mendels 2002, 6 (39-46)

# Akhziv South Cem I Dayagi-Mendels 2002, 10 (19)

# Akhziv South Cem I Dayagi-Mendels 2002, Fig. 3.1(38)

# Akhziv South Cem X Dayagi-Mendels 2002, 21 (10-12, 14-15, 19)

# Akhziv South Cem X Dayagi-Mendels 2002, Fig. 3.9(17)

# Akhziv East Cem XVII Dayagi-Mendels 2002, 66 (12)

# Akhziv East Cem XVII Dayagi-Mendels 2002, Fig. 4.14(13)

# Akhziv East Cem XXXVI Culican 1982, Fig. 9d-e

# Akhziv East Cem XXXVI Dayagi-Mendels 2002, 91 (22-24, 26-27)

# Akhziv East Cem XXXVI Dayagi-Mendels 2002, Fig. 4.27(25, 28)

### Iron II-III

# Akhziv South Cem XVIII Dayagi-Mendels 2002, 28 (7)

# Akhziv South Cem XXI Dayagi-Mendels 2002, 36 (7-8)

# Akhziv East Cem XI Dayagi-Mendels 2002, 56 (5)

# Akhziv East Cem XXIX Culican 1975-1976, Fig. A.e-f

# Akhziv East Cem XXIX Dayagi-Mendels 2002, 78 (15, 17)

# Akhziv East Cem XXIX Dayagi-Mendels 2002, Fig. 4.21(16)

# Akhziv Tomb N3 E. Mazar 2004, Fig. 9.2, 6-8, 10-12

# Beirut Bey 003 abandonment Badre 1997b, Fig. 36.12

# Beirut Bey 003 abandonment Badre 2000b, Fig. 5.9

# Beirut Bey 003 storage room Badre 1997b, Fig. 45.13

# Qraye S. V. Chapman 1972, Fig. 27.300

# Tyre Al-Bass cem. IV Núñez 2004a, Fig. 86.3

# Tyre Al-Bass cem. IV/V Núñez 2004a, Fig. 61.2

\*\* Tyre Al-Bass cem. Unstrat. Seeden 1991, Figs 31-32

### **Iron III**

# Al Mina VII du Plat Taylor 1959, Fig. 7.1, 3-4

# Megiddo II/III Lamon & Shipton 1939, Fig. 3.78

# Ras al-Bassit Findgroup D Braemer 1986, Fig. 4.21

# Sarepta Tomb 16 Culican 1970, Fig. 3.10

# Sarepta Tomb 42 Saidah 1983, Pl. 55.1

# Tyre Al-Bass cem. V Núñez 2004a, Fig. 57.3

### **Iron I-Persian**

\*\* Akhziv East Cem IX Dayagi-Mendels 2002, Fig. 4.7(8)

### **Iron II-Persian**

# Akhziv South Cem III Dayagi-Mendels 2002, 15 (11, 14)

# Akhziv South Cem III Dayagi-Mendels 2002, Fig. 3.4(12-13)

# Akhziv South Cem 70 E. Mazar 2001, Fig. 62.7-8

### **Iron III-Persian**

# Akhziv Tomb N4 E. Mazar 2004, Fig. 9.3-5, 9

## **B.9.21 CLASS 088**

### **Iron I**

# Megiddo VB Lamon & Shipton 1939, Fig. 6.146

BOR Megiddo VB Lamon & Shipton 1939, Fig. 6.147

\*\* Tell Kazel Iron I Dunand & Saliby 1957, Pl. 7.4

\* Tell Kazel Iron I Dunand *et al.* 1964, Pl. 13.2

Tyre XIII Bikai 1978b, Pl. 37.13

### **Iron I-II**

Akhziv TC4 E. Mazar 2001, Fig. 9.8-11

# Megiddo VA-IVB Lamon & Shipton 1939, Fig. 6.146

BOR Megiddo VA-IVB Lamon & Shipton 1939, Fig. 6.147

# Megiddo VA-IVB Lamon & Shipton 1939, Fig. 7.174

\*\* Megiddo VA-IVB Lamon & Shipton 1939, Fig. 8.177

\* Megiddo Tombs Guy 1938, Pl. 72.9

Tel Dan IV Biran 1982, Fig. 27.2

Tell el Ghassil Area I level 4 Baramki 1961, Fig. 4.3

Tell el Ghassil Area III level 4 Baramki 1966, Fig. 5

### **Iron II**

Hazor IV Yadin *et al.* 1960, Pl. 100.15-18

Hazor V Yadin *et al.* 1958, Pl. 56.18

Hazor V Yadin *et al.* 1960, Pl. 87.6

Hazor VII Yadin *et al.* 1960, Pl. 64.20-21, 23

Hazor VIII Yadin *et al.* 1960, Pl. 58.18, 21

\*\* Joya S. V. Chapman 1972, Fig. 6.185

\*\* Joya S. V. Chapman 1972, Fig. 8.190

\* Khalde Tomb 3 Saidah 1966, No. 12

BOR Khirbet Silm Culican 1982, Fig. 4d

\*\* Khirbet Silm S. V. Chapman 1972, Fig. 6.42

Khirbet Silm S. V. Chapman 1972, Fig. 7.25

\*\* Khirbet Silm S. V. Chapman 1972, Fig. 8.43-45

# Khirbet Silm S. V. Chapman 1972, Fig. 27.151

# Pella Iron II Unpublished

Tel Beth Shan IV James 1966, Fig. 37.8

Tel Beth Shan IV James 1966, Fig. 71.14-15

Tel Dan II Pakman 1992, Fig. 2.5

\* Tell Arqa 10 Unpublished

Tell el Ghassil Area I level 1 Baramki 1964, Fig. 10.1

Tell el Ghassil Area I level 1 Baramki 1964, Fig. 12.3

\*\* Tell el Ghassil Area I level 2 Baramki 1964, Fig. 37.2

Tell el Ghassil Area I level 3 Baramki 1961, Figs 9.1; 10.3

# Tell el Ghassil Area I level 3 Baramki 1964, Fig. 1.4



- # Tell Rachidiah Tomb IV Doumet 1982, Pl. XI.64  
 \*\* Tell Rachidiah Tomb IV Doumet 1982, Pl. XIII.55, 58  
**Iron I-III**  
 \*\* Akhziv South Cem I Dayagi-Mendels 2002, Fig. 3.1(55)  
 \*\* Akhziv South Cem XX Dayagi-Mendels 2002, Fig. 3.16(15)  
 Akhziv East Cem XXXVI Dayagi-Mendels 2002, Fig. 4.27(56)  
**Iron II-III**  
 Akhziv East Cem XXIX Culican 1975-1976, Fig. A.r  
 \* Qraye S. V. Chapman 1972, Fig. 7.268  
**Iron III**  
 Megiddo II/III Lamon & Shipton 1939, Fig. 4.93  
**Iron III-Persian**  
 Tell Keisan II/III Seton-Williams 1980, Pl. 109.16  
**Unclear Context**  
 \* Akhziv Unstrat. Culican 1982, Pl. 4b  
 # Akhziv Unstrat. Culican 1982, Pl. 4g  
 Athlit Cremation cem. Johns 1938, Fig. 11.1  
 Athlit Cremation cem. Johns 1938, Fig. 11.2  
 Athlit Cremation cem. Johns 1938, Fig. 13.1  
 \*\* Beqa' Valley Woolley 1921b, Fig. 23  
 Byblos Unstrat. Dunand 1950, No. 7.673  
 \*\* Byblos Unstrat. Homsy 2003, Pl. 4b  
 \*\* Byblos Unstrat. Homsy 2003, Pl. 6a  
 Khalde Unstrat. Chehab 1983, Pl. XX.1  
 \*\* Sidon Tomb 21 Culican 1975, Fig. 1e  
 \*\* Sarepta Area X unstrat. Pritchard 1988, Fig. 46.7  
 \*\* Sarepta Area X unstrat. Pritchard 1988, Fig. 47.10-11  
 Tell Abu Hawam III Hamilton 1935, Pl. 13.67  
 Tell Rachidiah Unstrat. Macridi-Bey 1904a, Pl. 6.12  
 # Zincirli Unstrat. Andrae 1943, Pl. 28g

## **B.9.22 CLASS 089**

- Iron I**  
 Sarepta Area X level VI Khalifeh 1988, Type DJ3  
**Iron I-II**  
 Akhziv TC4 E. Mazar 2001, Fig. 9.7  
**Iron II-III**  
 Sarepta Area X level VIII Khalifeh 1988, Type DJ3  
**Iron III**  
 \* Sarepta Tomb 26 Culican 1970, Fig. 3.7  
 \* Sarepta Tomb 42 Culican 1975, Fig. 2b  
**Unclear Context**  
 Byblos Unstrat. Dunand 1950, Nos 6.872, 9.179  
 Byblos Unstrat. Dunand 1950, No. 14.278  
 Sidon Unstrat. Saidah 1983, Pl. 53.1  
 \*\* Sarepta Area X unstrat. Pritchard 1988, Fig. 46.8

## **B.9.23 CLASS 090**

### **B.9.23.1 CLASS 090a**

- Iron I-II**  
 #\* Megiddo VA-IVB Lamon & Shipton 1939, Fig. 7.172  
**Iron II**  
 \* Akhziv East Cem XXVI Dayagi-Mendels 2002, Fig. 4.19(5)  
 \*\* Hazor V Yadin *et al.* 1960, Pl. 88.4  
 Hazor V Yadin *et al.* 1961, Pl. 230.20

- \* Hazor VI Yadin *et al.* 1958, Pl. 52.23
- \*\* Joya S. V. Chapman 1972, Fig. 6.186
- Joya S. V. Chapman 1972, Fig. 7.175-176
- \*\* Khalde Tomb 121 Saidah 1966, Nos 23-24
- #\* Khirbet Silm S. V. Chapman 1972, Fig. 29.157
- \*\* Tambourit Saidah 1977, Nos 7-9
- Tell el Ghassil Area I level 1 Baramki 1961, Fig. 1.2
- \* Tell Rachidiah Tomb IV Doumet 1982, Pl. XIII.46
- \* Tyre II Bikai 1978b, Pl. 6.9
- \*\* Tyre III Bikai 1978b, Pl. 5.4, 18
- \*\* Tyre III Bikai 1978b, Pl. 6.6, 8
- \*\*\* Tyre IV Bikai 1978b, Pl. 14.8
- \*\* Tyre Al-Bass cem. III Núñez 2004a, Fig. 70.2

#### **Iron I-III**

- Akhziv South Cem I Dayagi-Mendels 2002, 10 (25)
- \*\* Akhziv South Cem I Dayagi-Mendels 2002, Fig. 3.2(24)
- \*\* Akhziv East Cem XVII Culican 1982, Fig. 10d
- Akhziv East Cem XXXVI Dayagi-Mendels 2002, Fig. 4.27(58)

#### **Iron II-III**

- \*\* Akhziv South Cem XVII Dayagi-Mendels 2002, Fig. 3.13(1)
- Akhziv East Cem XXIX Culican 1975-1976, Fig. A.s
- Akhziv East Cem XXIX Dayagi-Mendels 2002, Fig. 4.21(21)
- Akhziv East Cem XXXVII Dayagi-Mendels 2002, 102 (1)
- \* Tyre Al-Bass cem. IV Núñez 2004a, Fig. 60.4
- # Tyre Al-Bass cem. Unstrat. Seeden 1991, Figs 21-22

#### **Iron III**

- # Akhziv East Cem XXIV Culican 1970, Fig. 2B.3

#### **Iron I-Persian**

- Akhziv East Cem IX Dayagi-Mendels 2002, 47 (13)
- Akhziv East Cem IX Dayagi-Mendels 2002, Fig. 4.7(12)

#### **Unclear Context**

- \* Al Mina Unstrat. du Plat Taylor 1959, Fig. 2.7
- \*\* Sarepta Area X unstrat. Pritchard 1988, Fig. 46.9
- \*\*\* Sarepta Unstrat. Seeden 1991, Figs 46-47

### **B.9.23.2 CLASS 090b**

#### **Iron II**

- Hazor V Yadin *et al.* 1960, Pl. 88.1-2
- # Khirbet Silm S. V. Chapman 1972, Fig. 29.158
- Tyre III Bikai 1978b, Pl. 5.1-3, 5-8

#### **Iron I-III**

- Akhziv East Cem IV Dayagi-Mendels 2002, Fig. 4.3(3)
- Akhziv East Cem XXXVI Dayagi-Mendels 2002, Fig. 4.27(59)

#### **Iron II-III**

- Akhziv Tomb N3 E. Mazar 2004, Fig. 12.3-4

#### **Iron III**

- Tyre Al-Bass cem. V Núñez 2004a, Fig. 105.3

#### **Iron I-Persian**

- Akhziv East Cem IX Dayagi-Mendels 2002, Fig. 4.7(21)

#### **Iron II-Persian**

- Akhziv East Cem VI Dayagi-Mendels 2002, 45 (5)
- Akhziv East Cem VI Dayagi-Mendels 2002, Fig. 4.5(7)

#### **Iron III-Persian**

- Akhziv Tomb N4 E. Mazar 2004, Fig. 12.2

#### **Unclear Context**

- Sarepta Area X unstrat. Pritchard 1988, Fig. 47.17

## **B.9.24 CLASS 091**

### **Iron II**

- Hazor IV Yadin *et al.* 1958, Pl. 72.7  
\* Hazor V Yadin *et al.* 1958, Pl. 56.22  
Hazor V Yadin *et al.* 1960, Pl. 75.10  
Hazor V Yadin *et al.* 1960, Pl. 79.18  
Hazor V Yadin *et al.* 1960, Pl. 87.4-5  
Hazor V Yadin *et al.* 1960, Pl. 218.9-10  
Hazor VI Yadin *et al.* 1960, Pls 70.19-21; 219.20  
Hazor VI Yadin *et al.* 1961, Pl. 185.4  
Tel Beth Shan IV James 1966, Fig. 71.7-9  
Tel Beth Shan V upper James 1966, Fig. 66.5  
# Tell el Ghassil Area I level 2 Joukowsky 1972, Pl. 2.30

### **Iron III**

- Megiddo II/III Lamon & Shipton 1939, Fig. 2.67  
# Ras al-Bassit Findgroup E Braemer 1986, Fig. 5.29  
Sarepta Tomb 42 Culican 1975, Fig. 2a  
Tel Dan I Pakman 1992, Fig. 5.1-2  
Tell Keisan 5 Briend & Humbert 1980, Pl. 37.1-1a

### **Unclear Context**

- Al Mina Unstrat. Woolley 1938b, Fig. 27.18  
Byblos Unstrat. Dunand 1950, No. 9.858  
Byblos Unstrat. Homsy 2003, Pl. 3c  
Sidon Tomb 21 Culican 1975, Fig. 1a  
\*\* Sidon Unstrat. Culican 1975, Fig. 4a

## **B.9.25 CLASS 092**

### **Iron II**

- Tell Mastuma South Area Wada 1994, Fig. 3.4  
Tyre III Bikai 1978b, Pl. 5.9-11

### **Iron I-III**

- \* Akhziv East Cem XXXVI Dayagi-Mendels 2002, Fig. 4.27(77)

### **Iron II-III**

- Beirut Bey 003 abandonment Badre 1997b, Fig. 37.14

### **Iron III**

- Akhziv East Cem XXIV Culican 1970, Fig. 2B.2  
Sarepta Tomb 26 Culican 1970, Fig. 3.5

### **Persian**

- Tell Sukas South Harbour cem. Riis 1979, Figs 73-74

### **Unclear Context**

- Byblos Unstrat. Culican 1970, Fig. 1D.1  
\*\* Sidon Tomb 21 Culican 1975, Fig. 1d

## **B.9.26 CLASS 093**

### **B.9.26.1 CLASS 093a**

### **Iron III**

- \* Tell Abou Danne IIc/A5 Lebeau 1983, Pl. 136.3  
\* Tell Rifa'at 2a Lehmann 1996, Pl. 44 (267a/1)

### **Persian**

- Al Mina III Woolley 1938b, Fig. 28.L5  
Al Mina III see Woolley 1938b, 139-140  
Al Mina IV Lehmann 1996, Pl. 44 (267b/3)  
Deve Höyük Cem. II Moorey 1980, Fig. 4.29, 33-36  
Megiddo I Lamon & Shipton 1939, Fig. 1.8

\* Tell Abou Danne Iib/A4 Tefnin 1980a, Fig. 7a-b  
Tell Abu Hawam II Hamilton 1935, Fig. 7  
Tell Rifa'at 1c see Lehmann 1996, 411 (Form 267b)  
Tell Sukas E Buhl 1983, Fig. X.122-123  
Tell Sukas G2 Buhl 1983, Fig. X.119  
**Unclear Context**  
\* Al Mina Unstrat. Lehmann 1996, Pl. 44 (267d/1; 268/1)

### **B.9.26.2 CLASS 093b**

#### **Persian**

Deve Höyük Cem. II Moorey 1980, Fig. 4.42-45

### **B.9.27 CLASS 094**

#### **Iron II-III**

Deve Höyük Cem. I Moorey 1980, Fig. 3.20-21

#### **Persian**

Al Mina III Woolley 1938b, Fig. 28.L4  
Tell Kazel Area I level 4 Gubel 1990b, Fig. 2i

#### **Unclear Context**

# Al Mina Unstrat. Lehmann 1996, Pl. 39 (229/1-3)  
# Al Mina Unstrat. Lehmann 1996, Pl. 39 (229/4+5)  
Byblos Unstrat. Dunand 1950, No. 13.818

### **B.9.28 CLASS 095**

#### **Iron II-III**

Tell Judeideh IV/III see Lehmann 1996, 412 (Form 274)

#### **Iron III**

Tell Judeideh III see Lehmann 1996, 412 (Form 274)

#### **Persian**

\* Al Mina III Woolley 1938a, Fig. 11  
Al Mina III Woolley 1938b, Fig. 28.L1  
Al Mina III see Woolley 1938b, 140-142  
\* Al Mina III Lehmann 1996, Pl. 45 (274/1-3)  
\* Al Mina III Lehmann 1996, Pl. 44 (269/3+4)  
\* Al Mina IV/III see Lehmann 1996, 411 (Form 269)  
Al Mina IV Woolley 1938b, Fig. 28.L1  
\* Deve Höyük Cem. II Moorey 1980, Fig. 4.30, 39-41  
Tell Sukas F Ploug 1973, No. 93  
Tell Sukas F Buhl 1983, Fig. X.121  
\* Tell Sukas F Lund 1986, Fig. 123

#### **Unclear Context**

Al Mina Unstrat. see Lehmann 1996, 411 (Form 269)  
Beqa' Valley Woolley 1921b, Fig. 37  
Byblos Unstrat. Dunand 1950, No. 9.349  
\* Byblos Unstrat. Homsy 2003, Pl. 5c  
\* Nayrab Unstrat. Carriere & Barrois 1927, Pl. 55.C  
Nayrab Unstrat. Abel & Barrois 1928, Pl. 54g  
Tell Judeideh Unstrat. see Lehmann 1996, 412 (Form 274)  
Tell Nebi Mend Unstrat. Pezard 1931, Pl. 23.1.2

### **B.9.29 CLASS 096**

#### **Iron II-III**

Deve Höyük Cem. I Moorey 1980, Fig. 3.15

## **B.9.30 CLASS 097**

### **Iron II**

- Hazor IV/V Yadin *et al.* 1958, Pl. 72.7  
Hazor V Yadin *et al.* 1958, Pl. 56.17  
Hazor V Yadin *et al.* 1960, Pl. 97.1  
Hazor V Yadin *et al.* 1961, Pl. 224.8  
Hazor V Yadin *et al.* 1961, Pl. 230.22  
Hazor VI Yadin *et al.* 1960, Pl. 70.17  
# Hazor VI Yadin *et al.* 1961, Pl. 185.7  
\*\* Joya S. V. Chapman 1972, Fig. 8.189  
Khirbet Silm S. V. Chapman 1972, Fig. 7.32  
# Pella Iron II Unpublished  
# Tel Beth Shan IV James 1966, Fig. 71.16  
Tel Dan II Pakman 1992, Fig. 2.6

### **Iron I-III**

- Akhziv South Cem I Dayagi-Mendels 2002, Fig. 3.1(49, 61)  
\* Akhziv South Cem I Dayagi-Mendels 2002, Fig. 3.2(20)  
\*\* Akhziv South Cem VI Dayagi-Mendels 2002, Fig. 3.7(6)  
# Akhziv South Cem X Dayagi-Mendels 2002, Fig. 3.9(16)  
Akhziv South Cem XI Dayagi-Mendels 2002, 24 (11-12)  
Akhziv South Cem XX Dayagi-Mendels 2002, Fig. 3.16(22)  
Akhziv East Cem XXXVI Dayagi-Mendels 2002, 94 (54)  
Akhziv East Cem XXXVI Dayagi-Mendels 2002, Fig. 4.27(36, 55)

### **Iron II-III**

- Akhziv Tomb N3 E. Mazar 2004, Fig. 11.3

### **Iron III-Persian**

- Akhziv Tomb N4 E. Mazar 2004, Fig. 11.1-2  
\* Akhziv Tomb N4 E. Mazar 2004, Fig. 11.4

## **B.9.31 CLASS 098**

### **Persian**

- Athlit Tomb 23 Johns 1932, 91, Fig. 4h  
\* Hazor II Yadin *et al.* 1958, Pl. 80.1, 4, 6-7, 10  
Hazor II Yadin *et al.* 1958, Pl. 80.2-3, 5, 8-9  
Hazor II Yadin *et al.* 1961, Pl. 191.1-5, 8-12  
\* Hazor II Yadin *et al.* 1961, Pl. 191.6  
Megiddo I Lamon & Shipton 1939, Fig. 1.3-5  
Tell Abu Hawam II Hamilton 1934, Pl. 23.1, 8-9

## **B.9.32 CLASS 099**

### **Persian**

- Deve Höyük Cem. II Moorey 1980, Fig. 4.56

## **B.10 JUGLETS**

### **B.10.1 CLASS 100**

#### **B.10.1.1 CLASS 100a**

##### **Iron I**

- # Megiddo Area K level 3 (VB) Finkelstein *et al.* 2000b, Fig. 11.19(17)

Megiddo VIA Harrison 2004b, Pl. 15.18-19  
# Tel Beth Shan V lower James 1966, Fig. 61.2

#### **Iron I-II**

Megiddo VA-IVB Loud 1948, Fig. 88.13  
# Tel Beth Shan V James 1966, Figs 1.8; 7.3; 19.12  
Tel Beth Shan V James 1966, Figs 7.4; 19.18

#### **Iron II**

Tel Beth Shan IV James 1966, Fig. 71.10  
Tel Beth Shan Area P level 7 A. Mazar 2001, Fig. 12.4  
# Tel Jezreel Findgroup B Zimhoni 1997b, Fig. 2.9 (6)

#### **Iron III**

Tell Keisan 4 Briend & Humbert 1980, Pl. 28.7  
Megiddo II/III Lamon & Shipton 1939, Fig. 2.71

#### **Persian**

Al Mina III Woolley 1938b, 141-142  
Al Mina III Woolley 1938b, Fig. 28.L3  
Tell Sukas E Buhl 1983, Fig. XII.156, 158; Sukas VI Figs 63-64, 91-92  
Tell Sukas South Harbour cem. Riis 1979, Figs 63-64  
Tell Sukas South Harbour cem. Riis 1979, Figs 91-92

#### **Unclear Context**

Al Mina Unstrat. Lehmann 1996, Pl. 38 (219/3+4)  
Byblos Unstrat. Dunand 1939b, No. 6.090  
Byblos Unstrat. Homsy 2003, Pl. 14g  
Sidon Unstrat. Saidah 1983, Pl. 53.1

### **B.10.1.2 CLASS 100b**

#### **Iron I**

Hazor IX Yadin *et al.* 1961, Pl. 179.7-8  
Hazor IX Yadin *et al.* 1961, Pl. 208.36  
Hazor IX/X Yadin *et al.* 1961, Pl. 210.23  
# Hazor IX/X Yadin *et al.* 1961, Pl. 210.24  
Hazor IX/X Unpublished  
Hazor IX/X Unpublished  
Kamid el-Lawz T Iron I Marfoe 1995, Fig. 103.3  
# Megiddo VB Lamon & Shipton 1939, Fig. 5.120-121  
# Megiddo VB Lamon & Shipton 1939, Fig. 5.140-142  
Megiddo VB Loud 1948, Pl. 87.14  
# Megiddo VB Loud 1948, Pl. 87.19  
# Megiddo Area K level 3 (VB) Finkelstein *et al.* 2000b, Fig. 11.19(14)  
Megiddo VIA Loud 1948, Fig. 75.14-16  
Megiddo VIA Harrison 2004b, Pl. 15.2, 4-6, 8  
Megiddo Area F level 5 (VIA) Finkelstein *et al.* 2000b, Fig. 11.3(2)  
Megiddo VIB Loud 1948, Fig. 73.4-5  
Megiddo Tombs Guy 1938, Pl. 74.2, 5, 18  
Pella Iron I Unpublished  
Sarepta Area Y level E Anderson 1988, Pl. 31.22  
Sarepta Area Y level F Anderson 1988, Pl. 30.5  
Tel Beth Shan V lower James 1966, Figs 60.10; 61.1, 7  
Tel Beth Shan V lower James 1966, Fig. 61.3-4  
Tel Beth Shan VI James 1966, Fig. 52.11, 23  
Tel Beth Shan VI James 1966, Fig. 57.6, 8  
Tel Beth Shan VI upper Yadin & Geva 1986, Fig. 11.9  
Tel Beth Shan VI lower Yadin & Geva 1986, Fig. 27.6-8  
Tell Abu Hawam IV Hamilton 1935, 30, No. 167  
Tell el Ghassil Area III level 5 Baramki 1966, Fig. 7.2  
Tell el Ghassil Area III level 6 Baramki 1966, Fig. 8.2  
Tell Kazel Iron I Dunand & Saliby 1957, Pl. 7.1  
Tell Keisan 9a/b Briend & Humbert 1980, Pl. 62.7

Tell Keisan IV/V Seton-Williams 1980, Pl. 110.7  
 Tell Sukas H2 Buhl 1983, Fig. XI.138  
 Tyre XIII Bikai 1978b, Pl. 33.17-18  
 Tyre XIII Bikai 1978b, Pl. 37.1  
 Tyre XIV Bikai 1978b, Pl. 39.1-3  
**Iron I-II**  
 Akhziv East Cem XXXIX Dayagi-Mendels 2002, 103 (6)  
 Akhziv TC4 E. Mazar 2001, Fig. 10.1-3  
 Akhziv Tomb N1 E. Mazar 2004, Fig. 13.2, 4, 9, 11, 17  
 # Megiddo VA-IVB Lamon & Shipton 1939, Figs 2.46-47; 5.141-142  
 # Megiddo VA-IVB Lamon & Shipton 1939, Fig. 5.120-121  
 Megiddo VA-IVB Loud 1948, Fig. 88.12  
 Sarepta Area X level VII Khalifeh 1988, Type J1, J3  
 Tel Beth Shan V James 1966, Figs 1.6; 3.7; 6.13; 10.12; 11.2; 14.1; 15.3; 17.2; 22.23  
 Tel Beth Shan V James 1966, Fig. 6.11  
 Tel Beth Shan Northern cem. Oren 1973, Fig. 41.12  
 Tel Beth Shan Northern cem. Oren 1973, Figs 42b.28; 43.8  
 Tell el Ghassil Area I level 4 Baramki 1961, Fig. 4.2  
 Tell el Ghassil Area I level 4 Baramki 1966, Fig. 3.5  
 Tell el Ghassil Area I level 4 Joukowsky 1972, Pl. 9.13  
 # Tell el Ghassil Area III level 4 Joukowsky 1972, Pl. 26.22  
 Tyre X Bikai 1978b, Pl. 25.2-5  
**Iron II**  
 Hazor V Yadin *et al.* 1958, Pl. 56.1-3  
 Hazor V Yadin *et al.* 1958, Pl. 73.6  
 Hazor V Yadin *et al.* 1960, Pl. 86.7-8, 10-15  
 Hazor V Yadin *et al.* 1960, Pl. 107.14  
 Hazor V Yadin *et al.* 1961, Pl. 224.7  
 Hazor V Yadin *et al.* 1961, Pl. 228.14-16  
 Hazor V Ben Tor *et al.* 1997, Fig. III.42 (17-18)  
 Hazor V Ben Tor *et al.* 1997, Fig. III.44 (7)  
 # Hazor V Ben Tor *et al.* 1997, Fig. III.47 (14)  
 Hazor VI Yadin *et al.* 1958, Pl. 52.14-15  
 Hazor VI Yadin *et al.* 1960, Pl. 70.1-3  
 Hazor VI Yadin *et al.* 1960, Pl. 70.8  
 Hazor VI Yadin *et al.* 1960, Pl. 70.10  
 Hazor VI Yadin *et al.* 1961, Pl. 184.17-22  
 Hazor VI Yadin *et al.* 1961, Pl. 215.13  
 Hazor VI Yadin *et al.* 1961, Pl. 220.24-27  
 Hazor VI Ben Tor *et al.* 1997, Fig. III.41 (18)  
 # Hazor VII Yadin *et al.* 1958, Pl. 50.10  
 Hazor VII Yadin *et al.* 1958, Pl. 50.11-12  
 Hazor VII Yadin *et al.* 1960, Pl. 64.17  
 Hazor VII Yadin *et al.* 1961, Pl. 180.15-17  
 Hazor VII Yadin *et al.* 1961, Pl. 248.12  
 Hazor VII Ben Tor *et al.* 1997, Fig. III.30 (4)  
 Hazor VII Ben Tor *et al.* 1997, Fig. III.33 (13)  
 Hazor VIII Yadin *et al.* 1960, Pl. 58.5-9  
 Hazor VIII Yadin *et al.* 1961, Pl. 248.13  
 Hazor VIII Ben Tor *et al.* 1997, Fig. III.25 (1)  
 Khalde Tomb 121 Saidah 1966, No. 31-34  
 Khirbet Silm S. V. Chapman 1972, Fig. 23.86, 89  
 Khirbet Silm S. V. Chapman 1972, Fig. 23.92  
 # Khirbet Silm S. V. Chapman 1972, Fig. 28.155  
 Megiddo IVA Lamon & Shipton 1939, Figs 1.16; 2.47  
 Megiddo Area H level 3 (IVA) Finkelstein *et al.* 2000b, Fig. 11.46(1, 3)  
 # Megiddo Area H level 3 (IVA) Finkelstein *et al.* 2000b, Fig. 11.53(2)  
 Pella Iron II Unpublished  
 Sarepta Area Y level D Anderson 1988, Pl. 33.23-24  
 Tel Beth Shan IV James 1966, Fig. 70.9-11, 13

Tel Beth Shan IV James 1966, Fig. 70.12  
 Tel Beth Shan IV James 1966, Figs 33.3; 37.2, 4  
 Tel Beth Shan IV James 1966, Fig. 72.9  
 Tel Beth Shan V upper James 1966, Fig. 65.3-5  
 Tel Beth Shan Area P level 7 A. Mazar 2001, Fig. 12.4  
 Tel Dan II Pakman 1992, Fig. 2.4  
 Tel Dan II Biran 1994, Fig. 214  
 Tel Dan III Biran 1999, Fig. 11.13  
 Tell Arqa 10 Unpublished  
 Tell Arqa 10 Unpublished  
 Tell el Ghassil Area I level 1 Baramki 1964, Fig. 11.2  
 Tell el Ghassil Area I level 1 Baramki 1964, Fig. 17.5  
 Tell el Ghassil Area I level 1 Baramki 1964, Fig. 18.1  
 # Tell el Ghassil Area I level 2 Baramki 1964, Fig. 2.2  
 Tell el Ghassil Area I level 2 Joukowsky 1972, Pl. 2.23-26  
 Tell el Ghassil Area III level 2 Joukowsky 1972, Pl. 18.40  
 Tell Keisan 6 Briend & Humbert 1980, Pl. 49.3  
 Tell Keisan 8 Briend & Humbert 1980, Pl. 56.5-7  
 Tell Rachidiah Tomb I Doumet-Serhal 2004a, 58  
 Tyre III Bikai 1978b, Pl. 12.1-23  
 Tyre IV Bikai 1978b, Pl. 14.7  
 Tyre V Bikai 1978b, Pl. 18.8-9  
 Tyre VIII Bikai 1978b, Pl. 20.5  
 Tyre Al-Bass cem. II Núñez 2004a, Fig. 93.3  
 Tyre Al-Bass cem. II Núñez 2004a, Fig. 100.3

#### **Iron I-III**

Akhziv South Cem I Dayagi-Mendels 2002, 8 (71-82)  
 Akhziv South Cem I Dayagi-Mendels 2002, 10 (34-36, 38-41)  
 Akhziv South Cem I Dayagi-Mendels 2002, Fig. 3.2(37)  
 Akhziv South Cem X Dayagi-Mendels 2002, 21 (24-27)  
 Akhziv South Cem XI Dayagi-Mendels 2002, Fig. 3.10(21)  
 Akhziv South Cem XX Dayagi-Mendels 2002, 32 (43-46)  
 Akhziv South Cem XX Dayagi-Mendels 2002, Fig. 3.16(42)  
 Akhziv East Cem XVII Dayagi-Mendels 2002, 66 (17-18)  
 Akhziv East Cem XXXVI Culican 1982, Fig. 9m  
 Akhziv East Cem XXXVI Dayagi-Mendels 2002, 94 (63-65, 67-71); 95 (72-74)  
 Akhziv East Cem XXXVI Dayagi-Mendels 2002, 95 (76)  
 Akhziv East Cem XXXVI Dayagi-Mendels 2002, Fig. 4.27(66, 75)  
 Akhziv Tomb N2 E. Mazar 2004, Fig. 12.1  
 Akhziv Tomb N2 E. Mazar 2004, Fig. 13.3, 7, 14, 24, 27

#### **Iron II-III**

Akhziv South Cem IV Dayagi-Mendels 2002, 16 (4-5)  
 Akhziv South Cem XVIII Dayagi-Mendels 2002, 29 (10, 12-14)  
 Akhziv South Cem XVIII Dayagi-Mendels 2002, Fig. 3.14(11)  
 Akhziv South Cem XXI Dayagi-Mendels 2002, 36 (9-10)  
 Akhziv East Cem V Dayagi-Mendels 2002, 44 (2-4)  
 Akhziv East Cem XI Dayagi-Mendels 2002, 56 (8-12)  
 Akhziv East Cem XI Dayagi-Mendels 2002, Fig. 4.7(7)  
 Akhziv East Cem XXIX Culican 1975-1976, Fig. A.v  
 Akhziv East Cem XXIX Dayagi-Mendels 2002, 78 (23-24, 27)  
 Akhziv East Cem XXIX Dayagi-Mendels 2002, Fig. 4.21(22, 25-26)  
 Akhziv East Cem XLIII Dayagi-Mendels 2002, 106 (XLIII.2)  
 Akhziv Tomb N3 E. Mazar 2004, Fig. 13.1, 6, 8, 10, 12-13, 15-16  
 Al Mina VIII see Lehmann 1996, 398 (Form 210)  
 Beirut Bey 003 abandonment Badre 1997b, Fig. 37.10-13  
 Beirut Bey 003 abandonment Badre 2000b, Fig. 6.5-6  
 Beirut Bey 003 storage Badre 1997b, Fig. 45.7-11  
 Sarepta Area X level VIII Khalifeh 1988, Type J1, J3  
 Sarepta Area Y level C Anderson 1988, Pl. 37.2  
 Sarepta Area Y level C Anderson 1988, Pl. 38.8



Tyre Al-Bass cem. IV Núñez 2004a, Fig. 110.12

### **Iron III**

Akhziv East Cem XXIV Culican 1970, Fig. 2B.5

Megiddo II/III Lamon & Shipton 1939, Fig. 1.10-11, 13

Ras al-Bassit Cem. Courbin 1993a, Fig. 9.5(C1861)

Sarepta Tomb 42 Saidah 1983, Pl. 55.1

Tell Arqa 9 Chaaya 2000, Fig. 3.4-5

Tell Arqa 9 Unpublished

Tell Keisan 4 Briend & Humbert 1980, Pl. 28.11

Tell Keisan 4 Briend & Humbert 1980, Pl. 33.3-4

Tell Keisan 5 Briend & Humbert 1980, Pl. 43.8-8a

Tell Sukas G3 Lund 1986, Fig. Fig. 44

### **Iron I-Persian**

Akhziv East Cem IX Dayagi-Mendels 2002, 47 (16-17)

Akhziv East Cem IX Dayagi-Mendels 2002, Fig. 4.7(15, 18)

Akhziv East Cem IX Dayagi-Mendels 2002, Fig. 4.7(19)

### **Iron II-Persian**

Akhziv South Cem III Dayagi-Mendels 2002, 15 (18-19, 21)

Akhziv South Cem III Dayagi-Mendels 2002, Fig. 3.4(20)

Akhziv South Cem 68 E. Mazar 2001, Fig. 52.26

Akhziv South Cem 70 E. Mazar 2001, Fig. 62.12-13

Akhziv South Cem 72 E. Mazar 2001, Fig. 65.13-15

\*\* Akhziv East Cem VI Dayagi-Mendels 2002, 45 (6)

Akhziv East Cem XII Dayagi-Mendels 2002, 57 (6-9)

Akhziv East Cem XIV Dayagi-Mendels 2002, 63 (10-11)

### **Iron III-Persian**

Akhziv East Cem XXVIII Dayagi-Mendels 2002, 75 (1-3)

Akhziv Tomb N4 E. Mazar 2004, Fig. 13.20, 22

Tell Sukas G Buhl 1983, Fig. XII.159

### **Persian**

Athlit Tomb 20 Johns 1932, Fig. 34

Megiddo I Lamon & Shipton 1939, Fig. 1.11, 13

Sarepta Area Y level B Anderson 1988, Pl. 38.17

Tell Abu Hawam II Hamilton 1934, Pl. 23.2

Tell Keisan 3 Briend & Humbert 1980, Pl. 19.7-7a, 9

Tell Keisan I Seton-Williams 1980, Pl. 108.4, 6

Tell Sukas G2 Buhl 1983, Fig. XII.155

\* Tell Sukas F Buhl 1983, Fig. XI.133

### **Unclear Context**

Athlit Cremation cem. Johns 1938, Fig. 4.3

Athlit Cremation cem. Johns 1938, Fig. 16.8

Byblos Unstrat. Montet 1929, No. 1.001

Byblos Unstrat. Dunand 1950, Nos 6.871, 9.864, 9.928, 12.311

Byblos Unstrat. Homsy 2003, Pl. 13a, c-d

# Byblos Unstrat. Homsy 2003, Pl. 13b

Byblos Unstrat. Homsy 2003, Pl. 13e-j

Byblos Unstrat. Homsy 2003, Pl. 14a-d

Sarepta Area X unstrat. Pritchard 1988, Fig. 49.1-15

Tell Abu Hawam III Hamilton 1934, Pl. 23.30

Tell Abu Hawam III Hamilton 1935, 20, Nos 57-58

Tell Abu Hawam III Hamilton 1935, Fig. 12

Tell Rachidiah Unstrat. Macridi-Bey 1904a, Pl. 6.5

## **B.10.1.3 CLASS 100c**

### **Iron I**

# Hazor IX/X Yadin *et al.* 1960, Pl. 51.14

# Hazor IX/X Unpublished

Kamid el-Lawz Iron I Marfoe 1995, Fig. 103.1

Megiddo Area K level 3 (VB) Finkelstein *et al.* 2000b, Fig. 11.19(10, 13)  
Tell Keisan 9a/b Briend & Humbert 1980, Pl. 61.7

#### **Iron I-II**

Megiddo VA-IVB Lamon & Shipton 1939, Fig. 2.52  
Megiddo VA-IVB Loud 1948, Fig. 88.11  
Tel Beth Shan V James 1966, Figs 10.11; 15.1, 4; 16.3; 17.1; 25.10, 14  
Tyre X Bikai 1978b, Pl. 25.1

#### **Iron II**

Hazor IV Yadin *et al.* 1960, Pl. 100.14  
Hazor V Yadin *et al.* 1958, Pl. 56.5  
Hazor V Yadin *et al.* 1960, Pl. 79.21-23  
Hazor V Yadin *et al.* 1960, Pl. 86.2-4, 9, 18  
# Hazor V Yadin *et al.* 1960, Pl. 86.16-17  
Hazor V Yadin *et al.* 1961, Pl. 224.5-6  
# Hazor V Yadin *et al.* 1961, Pl. 252.13  
# Hazor V Ben Tor *et al.* 1997, Fig. III.42 (3)  
Hazor VI Yadin *et al.* 1960, Pl. 70.4, 9  
# Hazor VI Yadin *et al.* 1960, Pl. 70.7  
# Hazor VII Yadin *et al.* 1961, Pl. 248.14  
Hazor VII Ben Tor *et al.* 1997, Fig. III.33 (12)  
Hazor VIII Yadin *et al.* 1960, Pl. 58.3  
Megiddo IVA Lamon & Shipton 1939, Fig. 2.50  
Megiddo IVA Lamon & Shipton 1939, Fig. 11.53  
Tel Beth Shan IV James 1966, Fig. 34.5  
Tel Beth Shan IV James 1966, Fig. 70.14, 17-18  
Tel Beth Shan V upper James 1966, Fig. 65.7-8  
Tel Beth Shan Area P level 7 A. Mazar 2001, Fig. 12.4  
# Tell el Ghassil Area I level 1 Joukowsky 1972, Pl. 1.9  
# Tell el Ghassil Area I level 3 Baramki 1964, Fig. 2.1  
Tell el Ghassil Area I level 2 Baramki 1964, Fig. 27.5  
Tell el Ghassil Area III level 2 Joukowsky 1972, Pl. 18.30

#### **Iron II-III**

Akhziv East Cem XXIX Dayagi-Mendels 2002, Fig. 4.21(29)  
Hazor III/IV Yadin *et al.* 1958, Pl. 78.17

#### **Iron III**

Megiddo II/III Lamon & Shipton 1939, Fig. 1.41-42  
Megiddo II/III Lamon & Shipton 1939, Fig. 2.49-51

#### **Iron I-Persian**

Akhziv East Cem IX Dayagi-Mendels 2002, Fig. 4.7(20)

#### **Persian**

Megiddo I Lamon & Shipton 1939, Fig. 2.49-51

#### **Unclear Context**

Zincirli Unstrat. Andrae 1943, Pl. 27d

### **B.10.1.4 CLASS 100d**

#### **Iron I**

# Hazor IX/X Yadin *et al.* 1961, Pl. 164.8  
Hazor IX/X Yadin *et al.* 1961, Pl. 164.10  
Hazor IX/X Unpublished  
# Megiddo VB Lamon & Shipton 1939, Fig. 5.130, 132, 137  
Megiddo VB Loud 1948, Pl. 87.16  
# Megiddo VB Loud 1948, Pl. 87.17-18  
Megiddo Area K level 3 (VB) Finkelstein *et al.* 2000b, Fig. 11.19(7)  
Megiddo Tombs Guy 1938, Pl. 74.3, 19-20  
# Pella-Iron<sup>I</sup> Unpublished  
# Tel Beth Shan V lower James 1966, Fig. 61.5

#### **Iron I-II**

Megiddo VA-IVB Lamon & Shipton 1939, Fig. 5.124-126, 128  
Megiddo VA-IVB Loud 1948, Fig. 88.10

# Tel Beth Shan V James 1966, Fig. 10.10  
# Tel Beth Shan V James 1966, Figs 18.22; 22.14  
Tel Beth Shan Northern cem. Oren 1973, Figs 41.11; 43.9

#### **Iron II**

Hazor V Ben Tor *et al.* 1997, Fig. III.47 (15)  
Hazor VII Yadin *et al.* 1958, Pl. 50.13  
Tel Jezreel Findgroup B Zimhoni 1997b, Fig. 2.9 (7)

#### **Iron II-III**

Akhziv East Cem XXIX Culican 1975-1976, Fig. A.z3

#### **Unclear Context**

Tell Nebi Mend Unstrat. Pezard 1931, Pl. 27.2.7  
# Tell Abu Hawam III Hamilton 1935, Pl. 13.91

### **B.10.1.5 CLASS 100e**

#### **Iron I**

Megiddo VB Loud 1948, Pl. 87.15  
Megiddo Tombs Guy 1938, Pl. 68.6  
Megiddo Tombs Guy 1938, Pl. 74.4, 6

#### **Iron I-II**

# Megiddo VA-IVB Lamon & Shipton 1939, Fig. 5.134-135  
# Megiddo VA-IVB Loud 1948, Fig. 88.16

#### **Iron II**

Tel Beth Shan IV James 1966, Fig. 70.19  
Tell el Ghassil Area I level 2 Baramki 1964, Fig. 25.2  
Tell el Ghassil Area I level 2 Baramki 1964, Fig. 33.4  
Tell el Ghassil Area III level 2 Joukowsky 1972, Pl. 18.31

#### **Iron III**

Megiddo II/III Lamon & Shipton 1939, Fig. 1.23, 40

## **B.11 FLASKS**

### **B.11.1 CLASS 101**

#### **Iron I**

Hama Cem. I Riis 1948, Fig. 49  
Hama Cem. I Riis 1948, Fig. 53  
Tille Höyük Sondage level 10 Summers 1993, Figs 34.1-3; 47.3

#### **Iron II**

Deve Höyük Cem. I Moorey 1980, Fig. 3.23-25  
Tell Mastuma Central Area level I-1 Wakita *et al.* 1995, Fig. 7.3  
Tille Höyük VIII Blaylock 1999, Fig. 6.5

#### **Iron III**

Ras al-Bassit Cem. Courbin 1993a, Fig. 9.4(C1071)  
Zincirli Iron III Andrae 1943, Pl. 22b

#### **Persian**

Kamid el-Lawz Persian Cem. Poppa 1978, Gr. 82.1

#### **Unclear Context**

Jerablus Yunus cem. Woolley 1939b, Pl. 14.a

### **B.11.2 CLASS 102**

#### **B.11.2.1 CLASS 102a**

##### **Iron I**

\* Hazor IX/X Yadin *et al.* 1961, Pl. 177.13

- \* Hazor XII Yadin *et al.* 1961, Pl. 166.13
- \* Khalde Tomb 166 Saidah 1966, Nos 50-51
- \* Khalde Tomb 167 Saidah 1966, No. 54
- \* Megiddo VIA Loud 1948, Fig. 80.5
- \* Megiddo VIA Harrison 2004b, Pl. 18.8
- \*\* Megiddo VIA Harrison 2004b, Pl. 18.10, 12
- \*\* Megiddo VIA Harrison 2004b, Pl. 19.1
- \* Megiddo VIB Harrison 2004b, Pl. 3.17
- \*\* Megiddo Area F level 6 burial Finkelstein *et al.* 2000b, Fig. 11.1(3)
- \* Megiddo Tombs Guy 1938, Pls 68.2, 9; 70.2-3, 5; 72.3-7; 73.8; 74.14-15
- \*\* Megiddo Tombs Guy 1938, Pl. 73.9
- \* Sarepta Area Y level F Anderson 1988, Pl. 29.29
- \* Sarepta Area Y level G Anderson 1988, Pl. 27.1
- \* Tel Beth Shan VI James 1966, Figs 50.9; 52.3; 56.14
- \* Tel Beth Shan VI James 1966, Fig. 57.13
- \* Tel Beth Shan VI lower Yadin & Geva 1986, Fig. 27.12-13
- \*\* Tel Dan V/VI Biran 1994, Fig. 103.7
- \* Tel Dan VI Biran 1989a, Fig. 4.18.9
- \*\* Tel Dan VI Biran 1994, Fig. 87.5
- \*\* Tel Dan VI Biran 1994, Fig. 93.4
- \* Tell Abu Hawam IV Hamilton 1935, 30, No. 166
- \*\* Tell Abu Hawam IV Hamilton 1935, Pl. 14.161
- \* Tell Abu Hawam IV Hamilton 1935, Pl. 14.162
- \* Tell Abu Hawam V/IV Hamilton 1934, Pl. 22.3
- \* Tell Afis Area E1 level 9a Venturi 2000a, Fig. 7.16
- \* Tell el Ghassil Area III level 7 Joukowsky 1972, Pl. 30.3
- \*\* Tell Kazel Area II level 5 Badre *et al.* 1994, Fig. 32.a-b
- \* Tell Kazel Area II level 5 Capet 2003, Fig. 40.f
- \* Tell Kazel Area II level 6 Badre *et al.* 1994, Fig. 52.f
- \*\* Tell Kazel Area IV level 4 Badre & Gubel 1999-2000, Fig. 44.a
- \* Tell Keisan 9a/b Briend & Humbert 1980, Pl. 62.9
- \* Tell Keisan 9c Briend & Humbert 1980, Pl. 74.1-5
- \* Tell Keisan 9c Briend & Humbert 1980, Pls 75.1-6; 76.2-4

#### **Iron I-II**

- \* Akhziv East Cem XVI Dayagi-Mendels 2002, 64 (1)
- \* Akhziv TC3 E. Mazar 2001, Fig. 5.2-3
- \* Akhziv TC4 E. Mazar 2001, Figs 14.7-9; 15.1-8, 16.1-3
- \*\* Akhziv TC4 E. Mazar 2001, Fig. 16.4-5
- \* Akhziv Tomb N1 E. Mazar 2004, Fig. 14.37, 39-44
- \*\* Akhziv Tomb N1 E. Mazar 2004, Fig. 14.38
- \* Byblos Necropolis K Salles 1980, Pl. 14.1-4
- \*\* Byblos Necropolis K Salles 1980, Pl. 14.6
- \* Tel Beth Shan V James 1966, Fig. 22.17, 21
- \* Tel Beth Shan Northern cem. Oren 1973, Figs 41.4-5, 7; 44b.28, 30; 46.11, 13-14
- \* Tel Beth Shan Northern cem. Oren 1973, Fig. 43.19, 21
- \*\* Tel Beth Shan Northern cem. Oren 1973, Fig. 44b.27, 31
- \* Tel Beth Shan Northern cem. Oren 1973, Fig. 48b.12-13
- \* Tell el Ghassil Area I level 4 Baramki 1964, Fig. 2.5
- \* Tell el Ghassil Area I level 4 Joukowsky 1972, Pl. 9.18

#### **Iron II**

- \* Chatal Höyük III Swift 1958, Fig. 46
- \* Hazor V Yadin *et al.* 1958, Pl. 56.23
- \* Hazor V Yadin *et al.* 1960, Pl. 88.8
- \* Hazor VII Yadin *et al.* 1960, Pl. 65.3
- \* Joya S. V. Chapman 1972, Fig. 12.197-198
- \*\* Joya S. V. Chapman 1972, Fig. 14.200, 203, 205, 207
- \* Khalde Tomb 4 Saidah 1966, No. 15
- \* Khirbet Silm S. V. Chapman 1972, Figs 12.62; 13.63
- \*\* Khirbet Silm S. V. Chapman 1972, Fig. 13.73
- \* Tel Beth Shan IV James 1966, Fig. 72.2; 4-5

- \* Tel Beth Shan Area P level 7 A. Mazar 2001, Fig. 12.4
- \* Tell Afis Area B (Afis VIII) Virgilio 2005, Fig. 35.2
- \* Tell Rachidiah Tomb IV Doumet 1982, Pl. XVIII.6
- \*\* Tell Rachidiah Tomb IV Doumet 1982, Pl. XVIII.94

#### **Iron I-III**

- \* Akhziv South Cem I Dayagi-Mendels 2002, 10 (27-33)
- \* Akhziv South Cem I Dayagi-Mendels 2002, Fig. 3.1(65)
- \* Akhziv South Cem VI Dayagi-Mendels 2002, 18 (7)
- \* Akhziv South Cem X Dayagi-Mendels 2002, 21 (21-23)
- \* Akhziv South Cem XI Dayagi-Mendels 2002, 24 (13-20)
- \* Akhziv South Cem XX Dayagi-Mendels 2002, 31 (33-34)
- \* Akhziv East Cem XXXVI Culican 1982, Fig. 9i
- \* Akhziv East Cem XXXVI Dayagi-Mendels 2002, 94 (60-62)
- \* Akhziv Tomb N2 E. Mazar 2004, Fig. 14.36, 45

#### **Iron II-III**

- \* Akhziv TC2 E. Mazar 2001, Figs 22.8; 23.1-3, 5-6
- \*\* Akhziv TC2 E. Mazar 2001, Figs 22.9; 23.4
- \* Akhziv TC2 E. Mazar 2001, Fig. 23.7
- \* Akhziv TC2 E. Mazar 2001, Fig. 25.22, 24-25
- \* Qraye Guigues 1938, Pl. 9b
- \*\* Qraye S. V. Chapman 1972, Fig. 13.272
- \* Qraye S. V. Chapman 1972, Fig. 15.275-277
- \*\*\* Qraye S. V. Chapman 1972, Fig. 16.278

#### **Iron III**

- \*\* Hazor III Yadin *et al.* 1958, Pl. 77.28
- \* Hazor III Yadin *et al.* 1958, Pl. 77.29
- \* Tell Keisan 5 Briend & Humbert 1980, Pl. 42.7-8
- \* Zincirli Iron III Andrae 1943, Pl. 19c, e

#### **Iron III-Persian**

- \* Tell Keisan II/III Seton-Williams 1980, Pl. 109.17

#### **Unclear Context**

- \* Beirut Unstrat. Chehab 1983, Pl. XIX.4
- \* Beqa' Valley Woolley 1921b, Fig. 30
- Nayrab Unstrat. Abel & Barrois 1928, Pl. 54i
- \* Qasmieh S. V. Chapman 1972, Fig. 32.313
- \* Sarepta Area X unstrat. Pritchard 1988, Fig. 52.2, 4-6
- \*\* Sarepta Area X unstrat. Pritchard 1988, Fig. 52.3
- \*\* Tell Abu Hawam III Hamilton 1934, Pl. 23.28
- \*\* Tell Abu Hawam III Hamilton 1935, 19, No. 53
- \* Tell Abu Hawam III Hamilton 1935, 19, No. 54
- \* Tell Abu Hawam III Hamilton 1935, Pl. 13.89

### **B.11.2.2 CLASS 102b**

#### **Iron I**

- Hazor IX Yadin *et al.* 1961, Pl. 208.39
- Hazor XI Yadin *et al.* 1961, Pl. 203.19
- Hazor XI Ben Tor *et al.* 1997, Fig. III.19 (4)
- Hazor XII Yadin *et al.* 1961, Pl. 202.3
- Hazor Iron I Yadin *et al.* 1961, Pl. 196.25
- Kamid el-Lawz Iron I Marfoe 1995, Fig. 103.5
- Kamid el-Lawz Iron I Heinz *et al.* 2004, Fig. 46
- Megiddo VB Loud 1948, Pl. 87.23
- Megiddo VIB Loud 1948, Fig. 74.14
- Sarepta Area X level VI Khalifeh 1988, Type PF2
- Sarepta Area Y level E Anderson 1988, Pl. 31.17
- Sarepta Area Y level G Anderson 1988, Pl. 26.17
- Sarepta Area Y level G Anderson 1988, Pl. 28.12, 16-17
- Tel Beth Shan VI James 1966, Fig. 53.21

Tel Beth Shan VI James 1966, Fig. 56.15  
 Tel Dan V Biran 1994, Fig. 99.1-2  
 Tell Abu Hawam IV Hamilton 1935, Pl. 14.157  
 Tell Abu Hawam V/IV Hamilton 1934, Pl. 22.11  
 Tell Abu Hawam V/IV Hamilton 1935, 41, No. 246  
 Tell el Ghassil Area III level 7 Joukowsky 1972, Pl. 30.2  
 Tell Kazel Area II level 5 Capet 2003, Fig. 34.d  
 Tell Kazel Area II level 6 Badre *et al.* 1994, Fig. 52.e  
 Tell Kazel Area IV level 5 Badre & Gubel 1999-2000, Fig. 34.f  
 Tell Keisan 9a/b Briend & Humbert 1980, Pl. 62.1, 10-11  
 Tyre XII Bikai 1978b, Pl. 31.10  
 Tyre XIII Bikai 1978b, Pl. 37.3  
 Tyre XIV Bikai 1978b, Pl. 39.4-5

**Iron I-II**

Akhziv East Cem XXXIX Dayagi-Mendels 2002, 103 (5)  
 Akhziv TC3 E. Mazar 2001, Fig. 5.4  
 # Akhziv TC4 E. Mazar 2001, Fig. 12.6-7  
 Akhziv TC4 E. Mazar 2001, Figs 13.1-7; 14.1  
 Akhziv TC4 E. Mazar 2001, Fig. 14.2-6  
 Akhziv Tomb N1 E. Mazar 2004, Fig. 14.1-4, 6-7, 9-10, 12, 14-15  
 Byblos Necropolis K Salles 1980, Pls 10.10; 21.12  
 # Tel Beth Shan V James 1966, Fig. 18.17  
 Tel Beth Shan Northern cem. Oren 1973, Fig. 41.3, 6, 8  
 # Tel Beth Shan Northern cem. Oren 1973, Fig. 42b.25  
 Tel Beth Shan Northern cem. Oren 1973, Figs 42b.26-27; 43.10; 44b.26, 29  
 Tell el Ghassil Area I level 4 Baramki 1964, Fig. 5.3  
 Tell el Ghassil Area I level 4 Joukowsky 1972, Pl. 9.19  
 Tyre X Bikai 1978b, Pl. 25.6

**Iron II**

Hama E Fugmann 1958, Fig. 344 (4C854)  
 Hazor V Yadin *et al.* 1960, Pl. 88.7  
 Hazor V Yadin *et al.* 1961, Pl. 228.23, 26  
 Hazor VI Yadin *et al.* 1958, Pl. 52.25  
 Hazor VI Yadin *et al.* 1960, Pl. 70.26-27  
 Hazor VI Yadin *et al.* 1961, Pl. 219.29  
 Hazor VI Yadin *et al.* 1961, Pl. 220.32  
 Hazor VIII Yadin *et al.* 1960, Pl. 58.12  
 Joya S. V. Chapman 1972, Fig. 12.196  
 Khalde Tomb 2 Saidah 1966, No. 4  
 Ras al-Bassit Cem. Courbin 1993a, Fig. 9.3(C1064)  
 Tel Beth Shan IV James 1966, Fig. 35.3  
 Tel Beth Shan V upper James 1966, Fig. 66.14  
 Tel Jezreel Findgroup B Zimhoni 1997b, Fig. 2.9 (5)  
 Tell Kazel Area II level 4 Badre 1990b, Fig. 37.h

**Iron I-III**

Akhziv South Cem I Dayagi-Mendels 2002, 8 (66-70)  
 Akhziv South Cem XX Dayagi-Mendels 2002, 31-32 (24-31, 35-36, 38-40)  
 Akhziv South Cem XX Dayagi-Mendels 2002, Fig. 3.16(23, 32, 37)  
 Akhziv East Cem IV Dayagi-Mendels 2002, 43 (4)  
 Akhziv Tomb N2 E. Mazar 2004, Fig. 14.5, 8, 11, 13, 16, 22, 25

**Iron II-III**

Akhziv TC2 E. Mazar 2001, Fig. 22.1-7  
 Qraye S. V. Chapman 1972, Figs 13.271; 15.274  
 # Qraye S. V. Chapman 1972, Fig. 16.279-281  
 Sarepta Area X level VIII Khalifeh 1988, Type PF2

**Iron III**

Sarepta Tomb 26 Culican 1970, Fig. 3.9  
 # Sarepta Tomb 42 Saidah 1983, Pl. 55.1  
 Tell Afis Area Gc level 5 Cecchini 1998, Fig. 29.2  
 Tell Keisan 4 Briend & Humbert 1980, Pl. 33.9

Tell Keisan 5 Briend & Humbert 1980, Pl. 43.9

#### **Iron II-Persian**

Akhziv South Cem 68 E. Mazar 2001, Fig. 52.27

Akhziv South Cem 72 E. Mazar 2001, Fig. 65.16

#### **Persian**

Hazor II Yadin *et al.* 1961, Pl. 258.1

Tell Keisan 2 Briend & Humbert 1980, Pl. 10.17-21

#### **Unclear Context**

Beqa' Valley Woolley 1921b, Fig. 9

Khalde Unstrat. Chehab 1983, Pl. XX.1

Sarepta Area X unstrat. Pritchard 1988, Fig. 52.1

Tell Abu Hawam III Hamilton 1934, Pl. 23.26-27

Tell Abu Hawam III Hamilton 1935, 19, Nos 55-56

Tell Nebi Mend Unstrat. Pezard 1931, Pl. 40.2.5-6

Tell Rachidiah Unstrat. Macridi-Bey 1904a, Pl. 6.8-9

### **B.11.2.3 CLASS 102c**

#### **Iron I**

Hama Cem. I Riis 1948, Fig. 81

Hama F2 Riis & Buhl 1990, Fig. 68 (466)

\* Hama F2 Riis & Buhl 1990, Fig. 68 (467)

Hama F Fugmann 1958, Fig. 165 (4A923)

\* Hama F Fugmann 1958, Fig. 165 (4A924)

\* Tell Abu Hawam IV Hamilton 1935, 31, No. 171

\* Tell Abu Hawam V/IV Hamilton 1934, Pl. 22.2

\* Tell Kazel Area II level 5 Badre *et al.* 1994, Fig. 39.e

\*\* Tell Kazel Area II level 5 Capet 2003, Fig. 36.k

Tell Kazel Area II level 6 Badre *et al.* 1994, Fig. 41.a

Tille Höyük Sondage level 10 Summers 1993, Fig. 34.5-6

#### **Iron I-II**

\* Tel Beth Shan Northern cem. Oren 1973, Fig. 47b.19

\* Tel Beth Shan Northern cem. Oren 1973, Fig. 48b.14-15

\* Tell Sukas H Buhl 1983, Fig. XI.137

#### **Iron II**

Hama E Fugmann 1958, Fig. 344 (O101)

\*\* Khirbet Silm S. V. Chapman 1972, Fig. 4.50

#### **Unclear Context**

Tell Mishrife Unstrat. du Mesnil du Buisson 1926, Fig 8; 1927 Pl. 69.7

\* Tell Afis Area N unstrat. Cecchini 2005, Fig. 64.1

### **B.11.2.4 CLASS 102d**

#### **Iron I**

\* Megiddo VIA Loud 1948, Fig. 80.6

\* Megiddo VIA Harrison 2004b, Pl. 19.2

# Megiddo VIB Loud 1948, Fig. 74.15

Sarepta Area X level V Khalifeh 1988, Type PF4, PF5, PF6

#### **Iron I-II**

# Megiddo VA-IVB Lamon & Shipton 1939, Fig. 22.129

### **B.11.2.5 CLASS 102e**

#### **Iron I**

\*\* Megiddo VIA Loud 1948, Fig. 80.7

\*\* Megiddo VIA Harrison 2004b, Pl. 19.6

\*\* Megiddo VIB Loud 1948, Fig. 74.16

\* Megiddo Tombs Guy 1938, Pl. 68.10

- \* Tell Keisan 9a/b Briend & Humbert 1980, Pl. 62.2
- Iron I-II**
- \* Tel Beth Shan V James 1966, Fig. 22.18
- Iron II**
- \*\* Joya S. V. Chapman 1972, Fig. 17.195
- Iron I-III**
- Akhziv South Cem XX Dayagi-Mendels 2002, Fig. 3.16(41)

## **B.12 UNGUENT CONTAINERS**

### **B.12.1 CLASS 103**

#### **B.12.1.1 CLASS 103a**

##### **Iron I**

- Hazor X Ben Tor *et al.* 1997, Fig. III.21 (21)
- Hazor XII Yadin *et al.* 1961, Pl. 201.28
- Hazor XII Ben Tor *et al.* 1997, Fig. III.20 (8)
- Hazor Iron I Ben Tor *et al.* 1997, Fig. III.20 (8)
- \* Kamid el-Lawz Iron I Hachmann 1966, Fig. 23.3, 5
- Kamid el-Lawz Iron I Marfoe 1995, Fig. 106.2-3
- \*\* Khalde Tomb 165 Saidah 1966, No. 48
- Megiddo VB Lamon & Shipton 1939, Fig. 19.96-97, 99
- Megiddo VB Loud 1948, Pl. 87.20
- \* Megiddo VIA Loud 1948, Fig. 77.9-10
- Megiddo VIA Harrison 2004b, Pl. 7.13
- \* Megiddo VIB Loud 1948, Fig. 73.12
- Megiddo Tombs Guy 1938, Pl. 71.19
- \* Tel Beth Shan VI upper Yadin & Geva 1986, Fig. 11.10
- \*\* Tel Dan V Biran 1994, Fig. 99.3
- \*\* Tel Dan VI Biran 1994, Fig. 87.4
- Tell el Ghassil Area I level 5 Joukowsky 1972, Pl. 12.22
- \* Tell Keisan 9a/b Briend & Humbert 1980, Pl. 61.10, 13
- Tell Sukas South Harbour Buhl 1996, Fig. 37.IIA1 3455/1

##### **Iron I-II**

- \* Byblos Necropolis K Salles 1980, Pl. 14.7
- # Megiddo VA-IVB Lamon & Shipton 1939, Fig. 19.95
- Tel Beth Shan V James 1966, Fig. 8.5
- Tel Beth Shan V James 1966, Fig. 13.1
- Tel Beth Shan Northern cem. Oren 1973, Fig. 42b.22
- \*\* Tel Dan IV Biran 1989b, Fig. 4.2; Biran 1994, Fig. 104.6
- Tell el Ghassil Area III level 4 Joukowsky 1972, Pl. 26.4
- \* Tell el Ghassil Area I level 4 Baramki 1961, Fig. 5.4
- Tell el Ghassil Area I level 4 Baramki 1966, Fig. 3.4
- Tell el Ghassil Area I level 4 Joukowsky 1972, Pl. 8.29

##### **Iron II**

- \* Khirbet Silm S. V. Chapman 1972, Fig. 22.84
- Tell el Ghassil Area I level 3 Joukowsky 1972, Pl. 5.3-4
- Tell el Ghassil Area I level 2 Baramki 1964, Fig. 3.1-2
- Tell el Ghassil Area I level 2 Joukowsky 1972, Pl. 2.6-7

##### **Iron III**

- Megiddo II/III Lamon & Shipton 1939, Fig. 9.35

##### **Iron I-Persian**

- Akhziv East Cem IX Dayagi-Mendels 2002, Fig. 4.7(23)

##### **Unclear Context**

- Tell Abu Hawam III Hamilton 1934, Pl. 23.19-20
- \* Tell Abu Hawam III Hamilton 1934, Pl. 23.21
- Tell Abu Hawam III Hamilton 1935, 20, No. 60



- \* Tell Abu Hawam III Hamilton 1935, 20, No. 61
- Tell Abu Hawam III Hamilton 1935, Fig. 11
- \* Tell Abu Hawam III Hamilton 1935, Pl. 13.63

### **B.12.1.2 CLASS 103b**

#### **Iron I**

- Hazor XII Yadin *et al.* 1961, Pl. 201.26
- \* Hazor XII Yadin *et al.* 1961, Pl. 201.27
- \* Kamid el-Lawz Iron I Hachmann 1966, Fig. 23.1, 6
- \* Kamid el-Lawz Iron I Marfoe 1995, Fig. 106.1
- Kamid el-Lawz Iron I Marfoe 1995, Fig. 106.4
- \* Megiddo VIA Loud 1948, Fig. 77.7
- Megiddo VIA Harrison 2004b, Pl. 7.7-8
- \* Megiddo VIA Harrison 2004b, Pl. 7.11
- \* Megiddo Tombs Guy 1938, Pl. 69.2
- \*\* Sarepta Area Y level G Anderson 1988, Pl. 28.6
- Tel Dan V/VI Biran 1994, Fig. 103.2
- \* Tell Kazel Area II level 6 Badre *et al.* 1994, Fig. 45.g
- Tell Kazel Area II level 6 Badre *et al.* 1994, Fig. 59.c
- Tell Kazel Area II level 6 Capet 2003, Fig. 7.d
- \* Tell Keisan 9c Briend & Humbert 1980, Pl. 70.1-1f
- Tell Sukas South Harbour Buhl 1996, Fig. 37.IIA2-3

#### **Iron I-II**

- # Megiddo VA-IVB Loud 1948, Fig. 89.5
- \*\* Tel Beth Shan Northern cem. Oren 1973, Fig. 48c.25

#### **Iron II**

- \* Hazor VI Yadin *et al.* 1958, Pl. 52.24
- Khalde Tomb 4 Saidah 1966, No. 14

#### **Iron II-III**

- \* Qraye Guigues 1938, Pl. 9c

### **B.12.2 CLASS 104**

#### **Iron I**

- \* Kamid el-Lawz Iron I Hachmann 1966, Figs 22.3; 23.2-4, 10-11
- \*\* Megiddo VIA Harrison 2004b, Pl. 19.4
- \* Sarepta Area Y level G Anderson 1988, Pls 26.24; 27.4-6; 28.21-22
- \*\* Tel Beth Shan VI James 1966, Fig. 49.4
- \* Tel Beth Shan VI James 1966, Fig. 54.3
- \* Tell Abu Hawam V/IV Hamilton 1935, 40, No. 241
- \* Tell Kazel Area II level 6 Capet 2003, Fig. 7.e
- \* Tell Kazel Area II level 6 Capet 2003, Fig. 27.a
- \*\* Tell Keisan 9c Briend & Humbert 1980, Pl. 72.6
- \* Tell Keisan 11/10 Briend & Humbert 1980, Pl. 81.6-7
- Tell Sukas South Harbour Buhl 1996, Fig. 37.IIB1
- Tell Sukas South Harbour Buhl 1996, Fig. 37.IIB2
- \* Tell Sukas South Harbour Buhl 1996, Fig. 37.IIB3

#### **Iron I-II**

- \* Byblos Necropolis K Salles 1980, Pl. 12.1-7, 9
- Tel Beth Shan Northern cem. Oren 1973, Figs 41.9; 42b.24
- \* Tel Beth Shan Northern cem. Oren 1973, Figs 41.10; 42b.23
- \* Tel Beth Shan Northern cem. Oren 1973, Fig. 43.6
- \* Tel Beth Shan Northern cem. Oren 1973, Fig. 44b.22-25
- \* Tel Beth Shan Northern cem. Oren 1973, Fig. 46.10
- Tel Beth Shan Northern cem. Oren 1973, Fig. 47a.13
- \*\* Tel Beth Shan Northern cem. Oren 1973, Fig. 48b.21
- \*\* Tel Beth Shan Northern cem. Oren 1973, Fig. 50.10

#### **Iron II-III**

- \* Qraye Guigues 1938, Pl. 9e
- Unclear Context**
- \* Sarepta Area X unstrat. Koehl 1985, Fig. 18.154-155
- \* Tell Nebi Mend Unstrat. Pezard 1931, Pl. 38
- \* Tell Tayinat Unstrat. Unpublished

## B.13 SPOUTED JUGS

### B.13.1 CLASS 105

#### Iron I

- Hama Cem. I Riis 1948, Fig. 40
- Hama Cem. I Riis 1948, Figs 71-72
- \* Hama F Fugmann 1958, Fig. 165 (5B118)
- Hama F1 Riis & Buhl 1990, 129 (Form III)
- \* Hama F1 Riis & Buhl 1990, 130 (Form XXIII)
- \* Hama F2 Riis & Buhl 1990, 130 (Form XXIII)
- \*\* Hama F2 Riis & Buhl 1990, Fig. 69 (477)
- Hazor IX Yadin *et al.* 1961, Pl. 179.9
- Megiddo VIA Loud 1948, Fig. 75.19
- Tell el Ghassil Area I level 5 Joukowsky 1972, Pl. 12.40
- \*\* Tell Kazel Area II level 5 Badre *et al.* 1994, Fig. 33.c
- \*\* Tell Kazel Area II level 5 Capet & Gubel 2000, Fig. 11
- \*\* Tell Kazel Area II level 5 Capet 2003, Fig. 36.g
- \* Tell Kazel Area II level 5 Capet 2003, Fig. 40.j
- Tille Höyük I-III Blaylock 1999, Fig. 2.5-6

#### Iron I-II

- Tel Beth Shan V James 1966, Fig. 10.13
- Tell el Ghassil Area I level 4 Baramki 1961, Fig. 4.4
- Tell el Ghassil Area I level 4 Joukowsky 1972, Pl. 9.16-17

#### Iron II

- Hama Cem. IV Riis 1948, Fig. 40
- \* Hama Cem. IV Riis 1948, Fig. 83
- Hama E Fugmann 1958, Fig. 216 (6C162)
- Hama E1 Riis & Buhl 1990, 129 (Form III)
- \* Hama E1 Riis & Buhl 1990, 130 (Form XXIII)
- Hama E2 Riis & Buhl 1990, 129 (Form III)
- \* Hama E2 Riis & Buhl 1990, 130 (Form XXIII)
- # Hazor VI Yadin *et al.* 1961, Pl. 184.16
- \* Hazor VI Yadin *et al.* 1961, Pl. 220.30
- Tel Beth Shan IV James 1966, Fig. 70.15
- Tel Dan III Biran 1999, Fig. 11.12
- Tell el Ghassil Area I level 3 Joukowsky 1972, Pl. 5.22
- Tell el Ghassil Area I level 2 Baramki 1964, Fig. 28.4
- # Tell el Ghassil Area III level 2 Joukowsky 1972, Pl. 18.27
- Tell el Ghassil Area III level 2 Joukowsky 1972, Pl. 18.28-29
- Tell Judeideh IV Lehmann 1996, Pl. 47 (284/1)
- \* Tell Mastuma Central Area level I-2 Egami 1988, Pl. 17.12-13
- \*\* Tell Mastuma Central Area level I-2 Wakita *et al.* 1995, Fig. 7.7
- \* Tell Mastuma South Area Wada 1994, Fig. 3.5
- \* Tell Rifa'at 2b-c Lehmann 1996, Pl. 47 (285/3)

#### Iron III

- \*\* Megiddo II/III Lamon & Shipton 1939, Fig. 1.34
- Megiddo II/III Lamon & Shipton 1939, Fig. 1.35
- Tell Afis Area D level 2 Mazzoni 1988a, Fig. 11.1-2
- Zincirli Iron III Andrae 1943, Pl. 19b

#### Persian

- Deve Höyük Cem. II Mooney 1980, Fig. 4.37

### **Unclear Context**

- Jerablus Yunus cem. Woolley 1939b, Pl. 24.J3-J4  
Nayrab Unstrat. Carriere & Barrois 1927, Fig. 1.inside J2  
Tell Judeideh Unstrat. see Lehmann 1996, 414 (Form 285)  
\* Tell Mishrife Unstrat. du Mesnil du Buisson 1926, Figs 21-22  
\* Tell Nebi Mend Unstrat. Pezard 1931, Pl. 23.4.7  
Tell Nebi Mend Unstrat. Pezard 1931, Pl. 24.2b

## **B.13.2 CLASS 106**

### **Iron I**

- \* Kamid el-Lawz Iron I Marfoe 1995, Fig. 104.1, 6  
\*\* Kamid el-Lawz Iron I Marfoe 1995, Fig. 104.3  
# Megiddo VB Lamon & Shipton 1939, Fig. 6.153  
\*\* Megiddo VIA Loud 1948, Fig. 76.1  
\*\* Megiddo VIA Harrison 2004b, Pl. 17.4

### **Iron I-II**

- # Tel Beth Shan Northern cem. Oren 1973, Fig. 42b.21  
# Tel Beth Shan V James 1966, Fig. 23.10  
# Tell el Ghassil Area I level 4 Baramki 1961, Fig. 5.1  
\* Tell el Ghassil Area I level 4 Joukowsky 1972, Pl. 9.24

### **Iron II**

- # Chatal Höyük III Swift 1958, Fig. 43  
# Hazor V Yadin *et al.* 1961, Pl. 228.1  
Hazor VI Yadin *et al.* 1958, Pl. 52.20  
\*\* Joya S. V. Chapman 1972, Fig. 1.168-169  
\*\* Khirbet Silm S. V. Chapman 1972, Fig. 1.1  
\* Khirbet Silm S. V. Chapman 1972, Fig. 1.3  
Khirbet Silm S. V. Chapman 1972, Fig. 2.9  
Tel Beth Shan V upper James 1966, Fig. 66.1  
# Tell el Ghassil Area III level 1 Joukowsky 1972, Pl. 15.30

### **Iron II-III**

- # Al Mina IX/VIII Woolley 1937, Pl. 11.2

### **Unclear Context**

- Jerablus Yunus cem. Woolley 1939b, Pl. 24.J1  
# Tell Mishrife Unstrat. du Mesnil du Buisson 1927, Pl. 82.83  
# Tell Nebi Mend Unstrat. Pezard 1931, Pl. 24.2.6  
# Zincirli Unstrat. Andrae 1943, Fig. 63

## **B.13.3 CLASS 107**

### **B.13.3.1 CLASS 107a**

#### **Iron I**

- \*\* Hazor IX/X Unpublished

#### **Iron II**

- # Joya S. V. Chapman 1972, Fig. 28.262  
# Tell Rachidiah Tomb IV Doumet 1982, Pl. XIV.28

#### **Iron II-III**

- # Qraye S. V. Chapman 1972, Fig. 28.301

#### **Unclear Context**

- Jerablus Yunus cem. Woolley 1939b, Pl. 24.J2  
\* Sarepta Area X unstrat. Pritchard 1988, Fig. 46.6  
Tell Rachidiah Unstrat. Macridi-Bey 1904a, Pl. 6.17

### **B.13.3.2 CLASS 107b**

#### **Iron I**

- \*\* Beirut Bey 003 glacis I Badre 1997b, Fig. 33.13
- \*\* Khalde Tomb 166 Saidah 1966, No. 49
- \*\* Khalde Tomb 167 Saidah 1966, No. 57
- \* Megiddo VIA Loud 1948, Fig. 75.20-21
- \*\* Megiddo VIA Loud 1948, Fig. 75.22-23
- \* Megiddo Tombs Guy 1938, Pl. 8.12
- \* Megiddo Tombs Guy 1938, Pl. 68.8
- Tel Beth Shan VI James 1966, Fig. 56.7
- \* Tyre XI Bikai 1978b, Pl. 29.3

#### **Iron I-II**

- Tel Beth Shan Northern cem. Oren 1973, Fig. 47b.24
- \*\* Tel Dan IV Biran 1989b, Fig. 5.11
- Tell el Ghassil Area I level 4 Joukowsky 1972, Pl. 9.23

#### **Iron II**

- \*\* Khirbet Silm S. V. Chapman 1972, Fig. 2.4, 6-7
- # Khirbet Silm Culican 1982, Pl. 8e
- \*\* Tell Keisan 7 Briend & Humbert 1980, Pl. 51.1
- ## Tell Rachidiah Tomb IV Doumet 1982, Pl. XIV.8
- \*\* Tyre Al-Bass cem. II Núñez 2004a, Fig. 76.3

#### **Iron II-III**

- \*\* Tyre Al-Bass cem. Unstrat. Seeden 1991, Figs 41-42

#### **Unclear Context**

- \*\* Beqa' Valley Woolley 1921b, Figs 24-25, 27-28
- \*\* Beqa' Valley Culican 1982, Pl. 1a-d
- \*\* Khalde Unstrat. Culican 1982, Pl. 1e
- \* Khalde Unstrat. Culican 1982, Pl. 1f
- \* Tell Tayinat Unstrat. Unpublished

### **B.13.4 CLASS 108**

#### **Iron I**

- Hama F2 Riis & Buhl 1990, 159 (515)
- Hama F Fugmann 1958, Fig. 165 (4B555)
- Megiddo VB Lamon & Shipton 1939, Fig. 23.24
- Megiddo VB Lamon & Shipton 1939, Fig. 31.148
- # Megiddo VB Lamon & Shipton 1939, Fig. 31.149
- \*\* Megiddo VB Loud 1948, Fig. 87.22
- Megiddo VIA Loud 1948, Fig. 78.16
- Megiddo VIA Harrison 2004b, Pl. 20.11-13
- Tell Afis Area E4 (Afis VII) Chiti 2005, Fig. 50.6

#### **Iron II**

- Hama E Fugmann 1958, Fig. 344 (4C756)
- Hazor VII Yadin *et al.* 1960, Pl. 63.34
- Tell Mastuma Central Area level I-2 Egami 1988, Pl. 18.4
- Tell Sheikh Hassan 3 Schneider 1999a, Fig. 16.27, 29
- Tell Sheikh Hassan 3 Schneider 1999a, Fig. 16.29

### **B.13.5 CLASS 109**

#### **Iron I**

- \*\* Megiddo VIA Harrison 2004b, Pl. 17.3
- \* Megiddo VIA Harrison 2004b, Pl. 17.6
- Megiddo VIA Harrison 2004b, Pl. 17.7
- # Pella Iron I Unpublished
- Tel Beth Shan VI James 1966, Fig. 57.9
- Tell el Ghassil Area I level 5 Joukowsky 1972, Pl. 12.38

\* Tell Kazel Area II level 6 Capet 2003, Fig. 11  
Tell Keisan 9a/b Briend & Humbert 1980, Pl. 61.18  
**Iron I-II**  
\*\* Megiddo VA-IVB Loud 1948, Fig. 88.19  
Tell el Ghassil Area I level 4 Baramki 1964, Fig. 7.1  
**Iron II-III**  
\*\* Qraye S. V. Chapman 1972, Fig. 31.309  
**Iron III**  
Sarepta Tomb 42 Saidah 1983, Pl. 55.1  
\*\* Tell Abou Danne IIc/A5 Lebeau 1983, Pl. 144.1  
**Unclear Context**  
Sarepta Area X unstrat. Pritchard 1988, Fig. 61.4

### **B.13.6 CLASS 110**

**Iron I**  
Tell Jurn Kabir Findgroup A Eidem and Ackermann 1999, Fig. 9b.5  
**Iron I-II**  
# Akhziv East Cem XVI Dayagi-Mendels 2002, 64 (2)  
Megiddo VA-IVB Lamon & Shipton 1939, Fig. 5.117  
**Iron II**  
# Hama Cem. IV Riis 1948, Figs 84-85  
**Iron I-III**  
# Akhziv South Cem VI Dayagi-Mendels 2002, Fig. 3.7(9)  
**Unclear Context**  
# Akhziv Unstrat. see Lehmann 455 (Form 462)  
# Byblos Unstrat. Dunand 1950, No. 12.061  
Jerablus Yunus cem. Woolley 1939b, Pl. 24.J5

### **B.13.7 CLASS 111**

**Iron I**  
\*\* Khalde Tomb 167 Saidah 1966, No. 58  
Megiddo VI Harrison 2004b, Pl. 22.8-10  
\* Tell Abu Hawam V/IV Hamilton 1935, 41, No. 248  
**Iron I-II**  
Megiddo VA-IVB Lamon & Shipton 1939, Fig. 8.180  
**Iron II**  
\*\* Tell Kazel Area I level 9 Badre *et al.* 1994, Fig. 11  
\* Tell Mastuma South Area Wada 1994, Fig. 6.2  
Tyre III Bikai 1978b, Pl. 6.1  
**Iron II-III**  
Deve Höyük Cem. I Moorey 1980, Fig. 2.2a-c  
**Unclear Context**  
\*\* Khalde Unstrat. Chehab 1983, Pl. XXI.4  
\* Sarepta Area X unstrat. Pritchard 1988, Fig. 61.2

### **B.13.8 CLASS 112**

**Iron I-III**  
Akhziv East Cem XXXVI Culican 1982, Fig. 9f  
Akhziv East Cem XXXVI Dayagi-Mendels 2002, Fig. 4.27(80)  
**Unclear Context**  
Khalde Unstrat. Culican 1982, Pl. 3b

## **B.14 BOTTLES**

### **B.14.1 CLASS 113**

#### **Iron III**

Tell Keisan 5 Briend & Humbert 1980, Pl. 36.1-11

Tell Keisan 5 Briend & Humbert 1980, Pl. 37.2-3

#### **Persian Period**

Tell Keisan 3 Briend & Humbert 1980, Pl. 19.8

#### **Unclear Context**

Al Mina Unstrat. Lehmann 1996, Pl. 53 (322/1)

Zincirli Unstrat. Andrae 1943, Pl. 19f

### **B.14.2 CLASS 114**

#### **Persian**

\* Tell Kazel Area I level 4 Gubel 1990a, Fig. 23.j; Gubel 1990b, Fig. 21

Sidon Persian Doumet-Serhal 2006, Fig. 23.14-17

#### **Unclear Context**

\* Byblos Unstrat. Homsy 2003, Pl. 3a

### **B.14.3 CLASS 115**

#### **Iron I-II**

Tel Beth Shan V James 1966, Fig. 13.4

Tel Beth Shan V James 1966, Fig. 15.2

#### **Iron II**

Tell Kazel Area II level 4 Badre 1990b, Fig. 37.g

#### **Iron III**

Tell Kazel Area II level 3 Badre 1990b, Fig. 34.f

# Tell Kazel Area II level 3 Badre 1990b, Fig. 34.g

Tell Kazel Area II level 3 Badre *et al.* 1994, Fig. 23.b, d

# Tell Kazel Area II level 3 Badre *et al.* 1994, Fig. 23.c

#### **Persian**

Athlit Tomb 24 Johns 1932, Fig. 82

Tell Abu Hawam II Hamilton 1934, Pl. 23.4

Tell Keisan 2 Briend & Humbert 1980, Pl. 14.16-23

Tell Keisan I Seton-Williams 1980, Pl. 108.5

#### **Unclear Context**

Jerablus Unstrat. Woolley 1921a, Pl. 20.d8

Sarepta Area X unstrat. Pritchard 1988, Fig. 63.1-5

Sarepta Area X unstrat. Pritchard 1988, Fig. 64.1, 4-5

\* Sarepta Area X unstrat. Pritchard 1988, Fig. 64.2-3

### **B.14.4 CLASS 116**

#### **Iron I**

Beirut Bey 003 LB/Iron Badre 1997b, Fig. 29.6

Beirut Bey 003 LB/Iron Badre 2001-2002, Fig. 14.7

Hazor XII Yadin *et al.* 1961, Pl. 201.25

Kamid el-Lawz Iron I Hachmann 1966, Fig. 24.2

Megiddo Tombs Guy 1938, Pls 68.18; 69.10

Megiddo VIA Harrison 2004b, Pl. 15.20

Tel Beth Shan VI James 1966, Fig. 56.8

Tell Abu Hawam V/IV Hamilton 1934, Pl. 22.1, 7

Tell Abu Hawam V/IV Hamilton 1935, 47, Nos 287-288

Tell Kazel Area I level 16 Badre & Gubel 1999-2000, Fig. 6.c

Tell Kazel Area II level 5 Badre *et al.* 1994, Fig. 33.d  
Tell Kazel Area II level 5 Badre *et al.* 1994, Fig. 39.c  
Tell Kazel Area II level 5 Capet 2003, Fig. 34.c  
Tell Kazel Area II level 5 Capet 2003, Fig. 40.i  
Tell Kazel Area II level 5 Capet 2003, Fig. 49.c  
Tell Kazel Area II level 6 Badre *et al.* 1994, Fig. 52.a  
Tell Kazel Area II level 6 Capet 2003, Fig. 15  
Tell Kazel Area IV level 5 Badre & Gubel 1999-2000, Fig. 31.a  
Tell Keisan 9c Briend & Humbert 1980, Pl. 71.4

#### **Iron I-II**

Byblos Necropolis K Salles 1980, Pl. 22.5

#### **Iron II**

Joya S. V. Chapman 1972, Fig. 23.226

#### **Iron II-III**

Qraye Guigues 1938, Pl. 9a

#### **Unclear Context**

Ras Ibn Hani Unstrat. Bounni *et al.* 1976a, Fig. 28.16

Tell Nebi Mend Unstrat. Pezard 1931, Pl. 27.8

### **B.14.5 CLASS 117**

#### **Persian**

Al Mina III see Woolley 1938b, 156

Athlit Tomb 21 Johns 1932, Pl. 22c

Deve Höyük Cem. II Moorey 1980, Fig. 4.32, 51

Tell Sukas South Harbour cem. Riis 1979, Figs 65-66

Tell Ahmar Tombs Thureau-Dangin & Dunand 1936b, Pl. 18.5

#### **Unclear Context**

Byblos Unstrat. Dunand 1939b, No. 1.142

Byblos Unstrat. Dunand 1950, No. 7.843

Byblos Unstrat. Dunand 1950, Nos 13.745, 14.776, 16.954

### **B.14.6 CLASS 118**

#### **Iron I**

Hama Cem. I Riis 1948, Figs 34-35

Hama Cem. II Riis 1948, Fig. 34

Hama F1 Riis & Buhl 1990, 129 (Form IC2)

Hama F2 Riis & Buhl 1990, 129 (Form IC2)

#### **Iron II**

Hama E Fugmann 1958, Fig. 305 (5B59)

Tille Höyük VIII Blaylock 1999, Fig. 10.15

#### **Iron II-III**

Tell Shiyuk Fawqani Area F (IX) Makinson 2005, Pl. 20.130, 132

Tell Shiyuk Fawqani Area F (IX) Makinson 2005, Pl. 22.143

#### **Iron III**

Tell Ahmar Area C level 2 Jamieson 1999, Fig. 7.5

Tell Ahmar Area C level 2 Jamieson 2000, Fig. 15.2, 4

Tell Ahmar Area C level 2 Jamieson 2005, Fig. 4.28.1-3

#### **Persian**

Kamid el-Lawz Persian Cem. Poppa 1978, Gr. 4.22; 12.8; 17.3; 21.1; 28.17; 67.5

Tell Shiyuk Fawqani Area F (X) Makinson 2005, Pl. 35.231

#### **Unclear Context**

Nayrab Unstrat. Abel & Barrois 1928, Pl. 54j

## **B.14.7 CLASS 119**

### **Iron II**

# Tyre III Bikai 1978b, Pl. 6.2

\*\* Tille Höyük VIII Blaylock 1999, Fig. 10.13

### **Iron II-III**

\* Deve Höyük Cem. I Moorey 1980, Fig. 3.16-17

Tell Shiyuk Fawqani Area F (IX) Makinson 2005, Pl. 25.168

### **Iron III**

\* Al Mina VII/VI Lehmann 1996, Pl. 39 (225/1)

Megiddo II/III Lamon & Shipton 1939, Fig. 9.6

\*\* Megiddo II/III Lamon & Shipton 1939, Fig. 9.7

Tel Dan I Pakman 1992, Fig. 5.9-10

Tell Ahmar Area C level 2 Jamieson 2005, Fig. 4.26.7-9

Tell Keisan 5 Briend & Humbert 1980, Pl. 37.13

Zincirli Iron III Andrae 1943, Pl. 22k

Zincirli Iron III Andrae 1943, Pl. 26g

### **Persian**

Hazor II Yadin *et al.* 1958, Pl. 80.22

Megiddo I Lamon & Shipton 1939, Fig. 9.4-5

### **Unclear Context**

\* Al Mina Unstrat. Peltenburg 1969, Fig. 2.1

Al Mina Unstrat. Peltenburg 1969, 94

Al Mina Unstrat. Peltenburg 1969, Figs 1.a-g; 2.j, k

Chatal Höyük Unstrat. see Lehmann 1996, 401 (Form 222); 402 (Form 225)

Jerablus Unstrat. Woolley 1921a, Pl. 20.d1, 3

Zincirli Tombs Andrae 1943, Pl. 26f

\* Zincirli Tombs Andrae 1943, Fig. 41

\* Zincirli Unstrat. Andrae 1943, Pl. 221; Fig. 55

## **B.14.8 CLASS 120**

### **Iron I-II**

\* Akhziv TC4 E. Mazar 2001, Fig. 10.10

\* Megiddo VA-IVB Loud 1948, Fig. 88.18

\* Tel Beth Shan V James 1966, Fig. 1.3

BOR Tel Beth Shan V James 1966, Fig. 9.2

### **Iron I-III**

\* Akhziv South Cem XX Dayagi-Mendels 2002, Fig. 3.16(57)

### **Iron II-III**

\* Sarepta Area Y level C Anderson 1988, Pl. 36.11

### **Iron III**

\* Tell Kazel Area II level 3 Badre 1990b, Fig. 34.h

### **Iron III-Persian**

Tell Sukas G Buhl 1983, Fig. XII.157

### **Unclear Context**

Jerablus Unstrat. Woolley 1921a, Pl. 20.d6

\* Sidon Tomb 21 Culican 1975, Fig. 1b-c

Tell Abu Hawam BOR III Hamilton 1935, Pl. 13.87

## **B.15 “ASSYRIAN” BOTTLES AND CUPS**

### **B.15.1 CLASS 121**

#### **B.15.1.1 CLASS 121a**

##### **Iron III**



Tel Dan I Pakman 1992, Fig. 5.11  
Tell Ahmar Area C level 2 Jamieson 1999, Fig. 4.6  
Tell Ahmar Area C level 2 Jamieson 2000, Fig. 6.7  
Tell Ahmar Area C level 2 Jamieson 2005, Fig. 4.17.11  
**Unclear Context**  
Jerablus Unstrat. Woolley 1921a, Pl. 20.d4-d5, d7, d9

### **B.15.1.2 CLASS 121b**

#### **Iron III**

Zincirli Iron III Andrae 1943, 50  
Tell Ahmar Area C level 2 Jamieson 1999, Fig. 4.7  
Tell Ahmar Area C level 2 Jamieson 2000, Fig. 6.2-4  
Tell Ahmar Area C level 2 Jamieson 2005, Fig. 4.17.5-8

#### **Unclear Context**

Al Mina Unstrat. see Lehmann 1996, 410 (Form 266)

### **B.15.1.3 CLASS 121c**

#### **Iron II**

Megiddo Area H level 3 (IVA) Finkelstein *et al.* 2000b, Fig. 11.46(7)  
Tell Judeideh IV see Lehmann 1996, 423 (Form 329c)  
Tille Höyük VIII Blaylock 1999, Fig. 10.7-10

#### **Iron III**

Megiddo II/III Lamon & Shipton 1939, Fig. 9.12  
Tell Ahmar Area C level 2 Jamieson 1999, Fig. 6.9, 13  
Tell Ahmar Area C level 2 Jamieson 2000, Fig. 13.9-13  
Tell Judeideh III see Lehmann 1996, 423 (Form 329c)

### **B.15.1.4 CLASS 121d**

#### **Iron II**

Tell Rifa'at 2b-c Lehmann 1996, Pl.54 (328/2)  
Tille Höyük VIII Blaylock 1999, Fig. 9.5-8

#### **Iron II-III**

Tell Shiyuk Fawqani Area F (IX) Makinson 2005, Pl. 21.138

#### **Iron III**

Al Mina VII Lehmann 1996, Pl. 53 (323b/1)  
Tell Ahmar Area C level 2 Jamieson 1999, Fig. 2.2-5  
Tell Ahmar Area C level 2 Jamieson 2000, Fig. 7.1-3  
Tell Ahmar Area C level 2 Jamieson 2005, Fig. 4.7.7-9  
Tell Keisan 5 Briend & Humbert 1980, Pl. 37.10-10c

### **B.15.1.5 CLASS 121e**

#### **Iron II**

Tell Rifa'at 2b-c Seton Williams 1961, Pl. 38.4  
Tell Sheikh Hassan 3 Schneider 1999a, Fig. 7.11(5-6)  
Tille Höyük VIII Blaylock 1999, Fig. 10.1-6

#### **Iron II-III**

Tell Shiyuk Fawqani Area F (IX) Bachelot 1999, Fig. 10  
Tell Shiyuk Fawqani Area F (IX) Makinson 2005, Pl. 10.52-53, 55, 58  
Tell Shiyuk Fawqani Area F (IX) Makinson 2005, Pl. 22.141

#### **Iron III**

Tel Dan I Pakman 1992, Fig. 5.8  
Tell Ahmar Area C level 2 Jamieson 1999, Fig. 6.1, 4, 6  
Tell Ahmar Area C level 2 Jamieson 2000, Fig. 3.35-39

Tell Ahmar Area C level 2 Jamieson 2005, Fig. 4.13.12-17  
Tell Ahmar Area C level 2 Jamieson 2005, Fig. 4.25.1-6  
Tell Jurn Kabir Findgroup C Eidem and Ackermann 1999, Fig. 8.3-4  
Tell Keisan 5 Briend & Humbert 1980, Pl. 37.11a-e  
Tell Rifa'at 2a Lehmann 1996, Pl. 17 (89c/1)  
Zincirli Iron III Andrae 1943, Pl. 24k

**Persian**

# Al Mina II Lehmann 1996, Pl. 18 (98/3)  
Tell Shiyuk Fawqani Area G level 1 Luciani 2005, Pl. 36.433-436

**Unclear Context**

Chatal Höyük Unstrat. see Lehmann 1996, 382 (Form 119)  
# Sarepta Area X unstrat. Khalifeh 1988, Pl. 24.3  
Tell Sheikh Hassan Unstrat. Schneider 1999b, Fig. 1  
Zincirli Unstrat. Andrae 1943, Pl. 24a  
Zincirli Unstrat. Andrae 1943, Pl. 25h, i

### **B.15.1.6 CLASS 121f**

**Iron II**

Chatal Höyük III see Lehmann 1996, 422 (Form 325)  
Tell Kazel Area I level 6 Gubel 1990a, Fig. 26.b  
Tell Shiyuk Fawqani Area H Al-Bahloul *et al.* 2005, Pl. 12b

**Iron III**

Tell Ahmar Area C level 2 Jamieson 1999, Fig. 2.1  
Tell Ahmar Area C level 2 Jamieson 2000, Fig. 6.9-12  
Tell Ahmar Area C level 2 Jamieson 2005, Fig. 4.7.4-6  
Tell Keisan 5 Briend & Humbert 1980, Pl. 37.6-8  
Zincirli Iron III Andrae 1943, Pl. 24h

**Unclear Context**

Tell Abu Hawam III Hamilton 1934, Pl. 23.25  
Zincirli Unstrat. Andrae 1943, Pl. 24d

## **B.16 CUPS AND CHALICES**

### **B.16.1 CLASS 122**

**Persian**

Ras al-Bassit Cem. Courbin 1993a, Fig. 17.8(C569)

**Unclear Context**

Ain Dara Unstrat. Stone & Zimansky 1999, Fig. 27.4

### **B.16.2 CLASS 123**

**Iron I**

Megiddo Area F level 5 (VIA) Finkelstein *et al.* 2000b, Fig. 11.3(4)  
Tel Beth Shan VI James 1966, Fig. 56.5  
\*\* Tell Afis Area E4 (Afis VII) Chiti 2005, Fig. 49.2  
Tell Kazel Area II level 6 Badre *et al.* 1994, Fig. 45.h  
Tell Sukas South Harbour Buhl 1996, Fig. 25.VIIIB

**Iron I-II**

\* Megiddo VA-IVB Loud 1948, Fig. 88.17  
Tel Beth Shan V James 1966, Fig. 5.10

**Iron II**

Tel Rehov Area C/E level 1 A. Mazar 1999a, Fig. 24.18

**Iron III**

Tell Ahmar Area C level 2 Jamieson 2005, Fig. 4.18.2

**Iron III-Persian**

Kefrik Unstrat. Moorey 1980, Fig. 23.563

### **B.16.3 CLASS 124**

#### **Iron I**

Megiddo VB Lamon & Shipton 1939, Fig. 7.166

Megiddo VIA Harrison 2004b, Pl. 9.8

Megiddo Tombs Guy 1938, Pl. 74.7

#### **Iron I-II**

\* Byblos Necropolis K Salles 1980, Pl. 9.12

# Megiddo VA-IVB Lamon & Shipton 1939, Fig. 8.179

# Tel Beth Shan V James 1966, Fig. 25.9

#### **Iron II**

Hazor V Yadin *et al.* 1960, Pl. 75.5

Ras al-Bassit Cem. Courbin 1993a, Fig. 9.1(C5099)

Tille Höyük VIII Blaylock 1999, Fig. 8.1

#### **Iron III**

Tell Ahmar Area C level 2 Jamieson 1999, Fig. 4.13

#### **Iron I-Persian**

Akhziv East Cem IX Dayagi-Mendels 2002, Fig. 4.7(14)

#### **Unclear Context**

Athlit Cremation cem. Johns 1934, Fig. 5.14

BOR Byblos Unstrat. Homsy 2003, Pl. 4d

### **B.16.4 CLASS 125**

#### **Iron II**

Tell Afis Area D level 4 Mazzoni 1988a, Fig. 17.12

Tell Afis Area E2 level 1 Degli Esposti 1998, Fig. 12.12

Tell Afis Area Gn level 5 Cecchini 1998, Fig. 38.9

Tell el Ghassil Area I level 1 Baramki 1964, Fig. 11.1

### **B.16.5 CLASS 126**

#### **Iron I**

Hazor IX Yadin *et al.* 1961, Pl. 175.13

Hazor IX/X Unpublished

Hazor XI Yadin *et al.* 1961, Pl. 203.6

#### **Iron II**

Hazor V Yadin *et al.* 1958, Pl. 73.2-3, 35

Hazor V Yadin *et al.* 1958, Pl. 74.19

Hazor V Ben Tor *et al.* 1997, Fig. III.42 (8)

Hazor VI Yadin *et al.* 1958, Pl. 51.30

Hazor VI Yadin *et al.* 1961, Pl. 182.22

\* Hazor VI Yadin *et al.* 1961, Pl. 219.12-13

Hazor VIII Yadin *et al.* 1960, Pl. 54.20-22

Tel Dan III Biran 1996b, Fig. 7.12, 14-15

#### **Iron III**

Tel Dan I Pakman 1992, Fig. 5.4

#### **Unclear Context**

Jerablus Yunus cem. Woolley 1939b, Pl. 14.b

Tell Nebi Mend Unstrat. Pezard 1931, Pl. 23.1.8

### **B.16.6 CLASS 127**

#### **Iron I**

Tell Abu Hawam V/IV Hamilton 1934, Pl. 22.18

Tell Abu Hawam V/IV Hamilton 1935, 48, No. 298  
Beirut Bey 003 LB/Iron Badre 1997b, Fig. 29.7-8

**Iron I-II**

Byblos Necropolis K Salles 1980, Pl. 9.10-11  
Tel Beth Shan Northern cem. Oren 1973, Fig. 43.23  
Tel Beth Shan Northern cem. Oren 1973, Fig. 47a.8

**Iron II**

Khirbet Silm S.V. Chapman 1972, Fig. 24.106

**Iron II-III**

# Tyre Al-Bass cem. Unstrat. Seeden 1991, Figs 43-44

## **B.16.7 CLASS 128**

**Iron I**

Hama Cem. I Riis 1948, Fig. 39

\* Hazor X Yadin *et al.* 1961, Pl. 207.22

Tell Kazel Area II level 6 Capet 2003, Fig. 7.a

**Iron I-II**

\*\* Byblos Necropolis K Salles 1980, Pl. 15.2-5

Byblos Necropolis K Salles 1980, Pl. 20.8-12, 16-17

**Iron II**

\* Tel Beth Shan V upper James 1966, Fig. 64.9

**Unclear Context**

\* Jerablus Unstrat. Woolley 1921a, Pl. 20.c2

Tell Judeideh Unstrat. see Lehmann 1996, 425 (Form 349)

Tell Mishrife Unstrat. du Mesnil du Buisson 1927, Pl. 69.13-16

Tell Nebi Mend Unstrat. Pezard 1931, Pl. 23.4.1-2, 4-5

## **B.16.8 CLASS 129**

**Iron I**

Megiddo VB Loud 1948, Fig. 87.24

\* Megiddo VIA Loud 1948, Fig. 79.11

Megiddo VIA Harrison 2004b, Pl. 8.9-10

\* Megiddo VIA Harrison 2004b, Pl. 8.11, 13

\* Megiddo Area F level 5 (VIA) Finkelstein *et al.* 2000b, Fig. 11.2(4)

# Megiddo VIB Loud 1948, Fig. 74.18

\* Megiddo VIB Loud 1948, Fig. 74.19

Tyre XIII Bikai 1978b, Pl. 33.23

**Iron I-II**

# Megiddo VA-IVB Lamon & Shipton 1939, Fig. 8.175

**Iron II**

Sarepta Area Y level D Anderson 1988, Pl. 33.18

**Iron III**

Tell Keisan 4 Briend & Humbert 1980, Pl. 32.4

**Persian**

Deve Höyük Cem. II Moorey 1980, Fig. 4.50

**Unclear Context**

Sarepta Area X unstrat. Pritchard 1988, Fig. 59.1, 3-4

## **B.16.9 CLASS 130**

**Iron I**

Tell Abu Hawam IV Hamilton 1935, 30, No. 170

Tell Kazel Area II level 5 Capet 2003, Fig. 46.d-f

Tell Keisan 9c Briend & Humbert 1980, Pl. 73.4-4a

**Iron II**

Tille Höyük VIII Blaylock 1999, Fig. 10.22  
**Iron II-III**  
 Tell Judeideh II/III see Lehmann 1996, 384 (Form 125c)  
**Iron III**  
 Megiddo II/III Lamon & Shipton 1939, Fig. 33.8-9  
 Zincirli Iron III Andrae 1943, 52, Pl. 23a-c  
 Zincirli Iron III Andrae 1943, Pl. 23c  
**Persian**  
 Megiddo I Lamon & Shipton 1939, Fig. 33.3  
 Tell Sukas E Buhl 1983, Fig. XIV.204  
**Unclear Context**  
 Al Mina Unstrat. see Lehmann 1996, 384 (Form 125c)  
 Athlit Cremation cem. Johns 1938, Fig. 11.3  
 Chatal Höyük Unstrat. see Lehmann 1996, 383 (Form 125b)  
 Jerablus Yunus cem. Woolley 1939b, Pl. 14.c  
 Sarepta Area X unstrat. Pritchard 1988, Fig. 59.2  
 Zincirli Unstrat. Andrae 1943, Pl. 23a-b

## B.16.10 CLASS 131

### B.16.10.1 CLASS 131a

#### Iron I

Hazor Iron I Ben Tor *et al.* 1997, Fig. II.36 (4-7)  
 # Megiddo VB Lamon & Shipton 1939, Fig. 33.19  
 Megiddo VIA Loud 1948, Fig. 79.7  
 Megiddo VIA Harrison 2004b, Pl. 8.1-3  
 Megiddo VIB Loud 1948, Fig. 74.17  
 Megiddo Tombs Guy 1938, Pls 68.19; 71.17; 73.5  
 Pella Area III level I McNicoll *et al.* 1992, Pl. 68.4  
 Sarepta Area X level V Khalifeh 1988, Type B29  
 Tel Dan V Biran 1989a, Fig. 4.7.6  
 Tel Dan V Biran 1989b, Fig. 22.6  
 \*\* Tel Dan VI Biran 1989b, Fig. 10.1  
 Tel Dan VI Biran 1994, Fig. 87.1-2  
 \* Tell Afis Area E1 level 9c Pedrazzi 2002, Fig. 24.1  
 \*\* Tell Afis Area E4 (Afis VII) Venturi 2005, Fig. 54.5  
 Tell Kazel Area II level 5 Badre 1990b, Fig. 39.a-b  
 Tell Kazel Area II level 5 Capet 2003, Fig. 46.b-c  
 Tell Kazel Area II level 6 Capet 2003, Fig. 21.e  
 Tell Keisan 9a/b Briend & Humbert 1980, Pl. 65.12  
 Tell Keisan 9c Briend & Humbert 1980, Pl. 73.6-7  
 Tell Sukas South Harbour Buhl 1996, Fig. 29.XIIIA  
 Tyre XII Bikai 1978b, Pl. 31.14

#### Iron I-II

\* Byblos Necropolis K Salles 1980, Pl. 19.4  
 Tel Beth Shan V James 1966, Fig. 31.28  
 Tel Dan IV Biran 1989b, Fig. 5.9-10  
 Tel Dan IV Biran 1989b, Fig. 26.1, 4

#### Iron II

Hama E Fugmann 1958, Fig. 310 (7A874)  
 Joya S. V. Chapman 1972, Fig. 22.220  
 Tel Beth Shan IV James 1966, Fig. 34.12  
 Tell Arqa 10 Thalmann 1983, Fig. 1.2  
 Tell Arqa 10AB Thalmann 1978a, Fig. 6.2; Chaaya 2000, Fig. 2.4  
 Tell el Ghassil Area I level 1 Baramki 1964, Fig. 10.4  
 Tell el Ghassil Area I level 3 Joukowsky 1972, Pl. 5.6  
 Tell Kazel Iron II Dunand *et al.* 1964, Pl. 11.4  
 Tell Keisan 6 Briend & Humbert 1980, Pl. 49.6

Tell Nebi Mend Trench V Level B Unpublished  
**Unclear Context**  
Athlit Cremation cem. Johns 1938, Fig. 12.1-2  
Tell Abu Hawam III Hamilton 1934, Pl. 23.24  
# Tell Abu Hawam III Hamilton 1935, Pl. 13.66

### **B.16.10.2 CLASS 131b**

#### **Iron I**

Megiddo VB Lamon & Shipton 1939, Fig. 33.18, 20  
Megiddo VIA Harrison 2004b, Pl. 8.4-5  
Megiddo Tombs Guy 1938, Pls 68.20; 74.25  
# Pella Iron I Unpublished  
Sarepta Area Y level F Anderson 1988, Pl. 29.21  
Tel Beth Shan V lower James 1966, Fig. 62.8-9  
Tel Beth Shan VI James 1966, Figs 50.8; 51.14  
Tel Dan V Biran 1994, Fig. 94.5  
Tell Keisan 9c Briend & Humbert 1980, Pl. 73.5a

#### **Iron I-II**

# Megiddo VA-IVB Loud 1948, Fig. 90.8  
Tel Beth Shan V James 1966, Figs 6.24; 19.21; 22.22  
Tel Dan IV Biran 1989b, Fig. 27.5

#### **Iron II**

Joya S. V. Chapman 1972, Fig. 22.221-222  
Tell Keisan 7 Briend & Humbert 1980, Pl. 51.13  
Tell Keisan 8 Briend & Humbert 1980, Pl. 56.13  
Tell Mishrife Operation C level II al Maqdissi 2003, Fig. 6.5

#### **Unclear Context**

Jerablus Yunus cem. Woolley 1939b, Pl. 14.c  
Tell Abu Hawam III Hamilton 1935, 23, No. 88

### **B.16.10.3 CLASS 131c**

#### **Iron I**

Megiddo VIA Harrison 2004b, Pl. 8.6-7

### **B.16.11 CLASS 132**

#### **Iron I**

\* Pella Iron I Unpublished  
# Pella Iron I Unpublished  
# Pella Area III level I McNicoll *et al.* 1992, Pl. 51.11

#### **Iron I-II**

\*\* Tell Mastuma Central Area level I Egami *et al.* 1984, Fig. 6.9

#### **Iron II**

\* Khirbet Silm S. V. Chapman 1972, Fig. 25.131  
Sarepta Area Y level D Anderson 1988, Pl. 33.5  
Tell Abou Danne IId/A6 Lebeau 1983, Pl. 28.4

#### **Iron II-III**

\* Al Mina VIII Lehmann 1996, Pl. 30 (179/1)  
Al Mina VIII see Lehmann 1996, 394 (Form 180)  
Ras Ibn Hani Iron II/III Lagarce 1983, Pl. 61.2.2

#### **Iron III**

BOR Al Mina V Lehmann 1996, Pl. 30 (180/2)

#### **Unclear Context**

\* Al Mina Unstrat. Lehmann 1996, Pl. 30 (179/2)  
Sarepta Area X unstrat. Pritchard 1988, Fig. 61.8-10

## **B.16.12 CLASS 133**

### **Iron I**

Hazor XII Yadin *et al.* 1961, Pl. 202.18

Megiddo VIA Loud 1948, Fig. 80.8

Tel Beth Shan V lower James 1966, Fig. 62.10

### **Iron I-II**

# Megiddo VA-IVB Lamon & Shipton 1939, Fig. 38.1

# Megiddo VA-IVB Loud 1948, Fig. 90.9

Tel Beth Shan V James 1966, Figs 2.3; 5.15; 11.1; 14.8

# Tel Beth Shan V James 1966, Fig. 6.23

Tel Dan IV Biran 1989b, Fig. 27.7, 13

### **Iron II**

Tell Keisan 7 Briend & Humbert 1980, Pl. 51.6-7

### **Unclear Context**

Sarepta Area X unstrat. Pritchard 1988, Fig. 57.18

## **B.17 BOWLS**

### **B.17.1 CLASS 134**

#### **B.17.1.1 CLASS 134a**

##### **Iron I**

Beirut Bey 003 LB/Iron Badre 1997b, Fig. 33.3

Hazor IX Yadin *et al.* 1961, Pl. 208.9

# Hazor IX Yadin *et al.* 1961, Pl. 212.20

# Hazor IX/X Yadin *et al.* 1958, Pl. 45.15-16

Hazor IX/X Yadin *et al.* 1961, Pl. 177.10

Hazor XI Yadin *et al.* 1961, Pl. 203.3

Hazor XII Yadin *et al.* 1961, Pl. 164.11-18

Hazor XII Yadin *et al.* 1961, Pl. 201.1, 3-5, 7

Hazor Iron I Ben Ami 2001, Fig. 5.8, 10-11, 13-16

Khalde Tomb 167 Saidah 1966, No. 59

# Megiddo VB Lamon & Shipton 1939, Fig. 30.106, 114-116, 130

Megiddo VIA Loud 1948, Figs 78.3-5, 12; 79.10

Megiddo VIA Harrison 2004b, Pl. 4.11

Megiddo VIA Harrison 2004b, Pl. 5.8-9

\* Megiddo VIA Harrison 2004b, Pl. 7.2

Megiddo VIB Loud 1948, Fig. 74.3, 6

Megiddo Tombs Guy 1938, Pls 68.4; 69.8; 70.7, 11; 71.4-5; 73.6

\* Pella Area VIII level 8 McNicoll *et al.* 1992, Pl. 64.5

Pella Iron I Unpublished

\* Ras Ibn Hani Iron I Bounni *et al.* 1979, Fig. 25.4

Sarepta Area X level V Khalifeh 1988, Type X6

Sarepta Area Y level F Anderson 1988, Pl. 29.11

\* Sarepta Area Y level G Anderson 1988, Pl. 26.7

# Tel Beth Shan V lower James 1966, Fig. 59.8

Tel Beth Shan VI James 1966, Fig. 52.18, 20

Tel Beth Shan VI lower Yadin & Geva 1986, Fig. 22.13-16

Tel Beth Shan Area S level 2 A. Mazar 1993b, Fig. 14.3

Tel Dan V Biran 1989a, Fig. 4.6.12

Tel Dan V Biran 1989a, Fig. 4.7.1

Tel Dan V/VI Biran 1994, Fig. 103.1

Tel Dan VI Biran 1989a, Fig. 4.19.2

Tell Jurn Kabir Findgroup A Eidem and Ackermann 1999, Fig. 5.14

# Tell Kazel Area II level 5 Badre 1990b, Fig. 41.d

Tell Kazel Area II level 5 Badre *et al.* 1994, Fig. 36.b

\* Tell Kazel Area II level 6 Badre *et al.* 1994, Fig. 48.c  
Tell Keisan 9a/b Briend & Humbert 1980, Pl. 65.4, 9  
Tell Keisan 9a/b Briend & Humbert 1980, Pl. 66.1  
\* Tell Keisan 9c Briend & Humbert 1980, Pl. 79.5, 5c, 6, 6c-d, 8-8a  
Tell Keisan 9c Briend & Humbert 1980, Pl. 79.5a-b, 6a-b, 7, 7a, c-e, g-h  
Tell Keisan 11/10 Briend & Humbert 1980, Pl. 81.15  
Tell Mishrife Iron I Unpublished  
Tell Qarqur 9 Unpublished  
Tell Sukas South Harbour Buhl 1996, Fig. 28.XIID  
Tell Sukas South Harbour Buhl 1996, Fig. 28.XIIE  
Tell Sukas South Harbour Buhl 1996, Fig. 28.XIIF  
Tille Höyük Sondage level 10 Summers 1993, Fig. 49.1  
Tyre XII Bikai 1978b, Pl. 31.6

#### **Iron I-II**

# Megiddo VA-IVB Lamon & Shipton 1939, Fig. 30.116  
# Megiddo VA-IVB Loud 1948, Fig. 89.9  
# Tel Beth Shan V James 1966, Fig. 20.3; 26.10  
Tel Beth Shan V James 1966, Fig. 20.6  
Tel Beth Shan V James 1966, Fig. 25.12  
Tel Beth Shan V James 1966, Fig. 47.3  
Tel Beth Shan Northern cem. Oren 1973, Figs 43.1, 14; 44a.7-12  
Tell Mastuma Central Area level I Egami & Masuda 1982, Pl. 6.2  
Tyre X Bikai 1978b, Pl. 23.5

#### **Iron II**

Hazor V Yadin *et al.* 1958, Pl. 67.2, 4  
Hazor V Yadin *et al.* 1961, Pl. 189.5  
# Hazor VI Yadin *et al.* 1958, Pl. 51.6  
# Hazor VI Yadin *et al.* 1961, Pl. 181.40  
Hazor VI Yadin *et al.* 1961, Pl. 181.42  
# Hazor VII Yadin *et al.* 1958, Pl. 49.12-13  
Hazor VII Yadin *et al.* 1960, Pl. 63.6  
Hazor VII Ben Tor *et al.* 1997, Fig. III.30 (14)  
Hazor VIII Yadin *et al.* 1958, Pl. 47.11  
Hazor VIII Yadin *et al.* 1960, Pl. 53.15, 17, 35-36  
Hazor VIII Yadin *et al.* 1960, Pl. 55.15  
# Hazor VIII Yadin *et al.* 1960, Pl. 55.22  
Megiddo Area H level 3 (IVA) Finkelstein *et al.* 2000b, Fig. 11.52(5)  
# Megiddo Area H level 3 (IVA) Finkelstein *et al.* 2000b, Fig. 11.52(7)  
Pella Iron II Unpublished  
# Tel Beth Shan IV James 1966, Fig. 67.6  
# Tel Jezreel Iron II Zimhoni 1997b, Fig. 2.3 (11-12, 14)  
Tel Jezreel Iron II Zimhoni 1997b, Fig. 2.3 (15)  
# Tel Rehov Area C/E level 1 A. Mazar 1999a, Fig. 24.3  
Tel Rehov Area C/E level 1 A. Mazar 1999a, Fig. 24.4  
Tell Abou Danne IId/A6 Lebeau 1983, Pl. 26.2-4  
Tell Afis Area D level 3 Cecchini 1988, Fig. 6.21  
Tell Afis Area D level 4 Cecchini 1988, Figs 7.11-13; 8.1  
Tell Afis Area E1 level 2 Mazzoni 1998a, Fig. 24.8, 9  
Tell Arqa 10 Unpublished  
Tell Keisan 7 Briend & Humbert 1980, Pl. 52.2, 5  
Tell Mastuma Central Area level I-2 Egami 1988, Pl. 17.7-8  
Tell Mishrife Iron II Unpublished  
Tell Nebi Mend Trench V Level B Unpublished  
\* Tell Nebi Mend Trench V Level B Unpublished  
Tell Nebi Mend Trench V Level C Unpublished  
Tyre VIII Bikai 1978b, Pl. 19.28

#### **Iron III**

# Megiddo II/III Lamon & Shipton 1939, Fig. 24.30  
# Ras al-Bassit Findgroup D Braemer 1986, Fig. 4.17  
Tell Afis Area D level 2 Mazzoni 1988a, Fig. 9.25-26



# Tell Afis Area Gc level 6 Cecchini 1998, Fig. 26.11  
 Tell Afis Area Gc level 7b Cecchini 1998, Fig. 24.3  
 Tell Ahmar Area D Iron III Jamieson 2005, Fig. 2.9-11  
 Tell Keisan 4 Briend & Humbert 1980, Pl. 29.6  
 \* Tell Keisan 4 Briend & Humbert 1980, Pl. 30.8  
**Iron II-III**  
 Tell Shiyuk Fawqani Area G level 2 Luciani 2005, Pl. 8.115  
**Iron III-Persian**  
 \*\* Tell Keisan II/III Seton-Williams 1980, Pl. 109.12  
**Unclear Context**  
 Jerablus Yunus cem. Woolley 1939b, Pl. 22.B19  
 Sarepta Area X unstrat. Pritchard 1988, Fig. 38.8  
 Tell Nebi Mend Unstrat. Pezard 1931, Pl. 25.3.3

### **B.17.1.2 CLASS 134b**

#### **Iron I**

Ain Dara Lower Mound, Iron I Stone & Zimansky 1999, Fig. 25.11  
 Beirut Bey 003 LB/Iron Badre 1997b, Fig. 33.5  
 # Hazor IX/X Yadin *et al.* 1961, Pl. 177.12  
 # Hazor X Yadin *et al.* 1960, Pl. 51.1  
 Hazor X Yadin *et al.* 1961, Pl. 171.4, 6  
 # Megiddo VB Lamon & Shipton 1939, Fig. 28.101  
 # Megiddo VB Lamon & Shipton 1939, Fig. 30.119, 121-122, 129  
 Megiddo VIA Harrison 2004b, Pl. 7.3  
 Megiddo Tombs Guy 1938, Pl. 70.8  
 Megiddo Tombs Guy 1938, Pl. 74.12  
 \* Ras Ibn Hani Iron I Bounni *et al.* 1979, Fig. 25.5-6  
 Tel Beth Shan V lower James 1966, Fig. 59.5  
 Tell Keisan 9a/b Briend & Humbert 1980, Pl. 66.10  
 \* Tell Qarqur 9 Unpublished  
 Tille Höyük I-III Blaylock 1999, Fig. 2.4  
 Tille Höyük Sondage level 10 Summers 1993, Fig. 51.3  
 Tyre XII Bikai 1978b, Pl. 31.5, 13  
**Iron I-II**  
 # Akhziv TC4 E. Mazar 2001, Fig. 7.21  
 # Megiddo VA-IVB Lamon & Shipton 1939, Fig. 24.39  
 # Megiddo VA-IVB Lamon & Shipton 1939, Fig. 30.121-122, 130  
 Tel Beth Shan V James 1966, Fig. 4.1  
 Tel Beth Shan Northern cem. Oren 1973, Fig. 42a.8  
 Tel Dan IV Biran 1982, Fig. 24.6  
 # Tel Dan IV Biran 1982, Fig. 24.14-15  
 Tell Sukas H Buhl 1983, Fig. XII.163

#### **Iron II**

Ain Dara Lower Iron II Stone & Zimansky 1999, Fig. 74.4  
 Ain Dara Lower Iron II Stone & Zimansky 1999, Fig. 25.11  
 Hama Cem. IV Riis 1948, Fig. 109  
 Hama E Fugmann 1958, Fig. 344 (4C752, H814)  
 Hama E1 Riis & Buhl 1990, 130 (Form XXXC2)  
 # Hama E1 Riis & Buhl 1990, Fig. 78 (593)  
 Hama E2 Riis & Buhl 1990, Fig. 78 (592)  
 Hazor IV Yadin *et al.* 1958, Pl. 58.2  
 # Hazor VI Yadin *et al.* 1958, Pl. 51.25-26  
 # Hazor VI Yadin *et al.* 1960, Pl. 66.32-33  
 # Hazor VI Yadin *et al.* 1961, Pl. 219.2  
 Hazor VII Yadin *et al.* 1958, Pl. 49.6-7  
 # Hazor VII Yadin *et al.* 1958, Pl. 49.8  
 Hazor VII Yadin *et al.* 1960, Pl. 63.4  
 Hazor VII Ben Tor *et al.* 1997, Fig. III.30 (13)

Hazor VII Ben Tor *et al.* 1997, Fig. III.32 (7-9)  
 Hazor VIII Yadin *et al.* 1960, Pl. 53.12, 14  
 Hazor VIII Yadin *et al.* 1960, Pl. 55.5  
 # Hazor VIII Yadin *et al.* 1961, Pl. 213.26  
 Hazor VIII Ben Tor *et al.* 1997, Fig. III.24 (4)  
 Khirbet Silm S. V. Chapman 1972, Fig. 24.107  
 \* Khirbet Silm S. V. Chapman 1972, Fig. 25.130  
 Megiddo IVA Lamon & Shipton 1939, Fig. 24.29  
 \* Megiddo IVA Lamon & Shipton 1939, Fig. 26.74  
 # Megiddo IVA Lamon & Shipton 1939, Fig. 28.101  
 # Megiddo Area H level 3 (IVA) Finkelstein *et al.* 2000b, Fig. 11.43(6, 18)  
 Sidon Iron II Doumet-Serhal 2006, Fig. 29. 11, 16, 38, 42  
 # Sarepta Area Y level D Anderson 1988, Pl. 33.17  
 # Tel Beth Shan IV James 1966, Fig. 32.4  
 # Tel Beth Shan V upper James 1966, Fig. 63.13  
 Tel Dan II Pakman 1992, Fig. 1.5  
 Tel Jezreel Findgroup A Zimhoni 1997b, Fig. 2.5 (1)  
 # Tel Jezreel Findgroup D Zimhoni 1997a, Fig. 1.2 (8)  
 Tel Jezreel Findgroup D Zimhoni 1997a, Fig. 1.2 (10)  
 # Tell Abou Danne IId/A6 Lebeau 1983, Pl. 15.4  
 Tell Afis Area L level 6a D'Amore 1998a, Fig. 6.17  
 # Tell Arqa 10 Unpublished  
 # Tyre III Bikai 1978b, Pl. 10.12  
 \*\* Tyre VIII Bikai 1978b, Pl. 22.11  
 Tyre IX Bikai 1978b, Pl. 19.19  
**Iron II-III**  
 # Tell Tayinat Building phase 3 Swift 1958, Fig. 34  
**Iron III**  
 Megiddo II/III Lamon & Shipton 1939, Fig. 24.29  
 # Tell Abou Danne IId/A5 Lebeau 1983, Pl. 104.2  
 Tell Afis Area Gc level 4 Cecchini 1998, Fig. 31.21  
 # Tell Afis Area Gc level 7b Cecchini 1998, Fig. 20.22-23  
 # Tell Afis Area Gn level 2 Cecchini 1998, Fig. 39.15  
 \* Tell Keisan 4 Briend & Humbert 1980, Pl. 30.9  
 \*\* Tell Keisan 4 Briend & Humbert 1980, Pl. 30.10  
 Tell Keisan 5 Briend & Humbert 1980, Pl. 41.3b  
**Iron I-Persian**  
 Akhziv East Cem IX Dayagi-Mendels 2002, Fig. 4.7(1)  
**Iron III-Persian**  
 Akhziv Tomb N4 E. Mazar 2004, Fig. 1.4  
**Persian**  
 Megiddo I Lamon & Shipton 1939, Fig. 24.29  
 Tell Sukas F Buhl 1983, Fig. XIII.177  
 Tille Höyük X Blaylock 1999, Fig. 13.12-13  
**Unclear Context**  
 Tell Abu Hawam III Hamilton 1935, 21, No. 72

### **B.17.1.3 CLASS 134c**

#### **Iron I**

Hama F Fugmann 1958, Fig. 165 (4B930, 4B937, 4B940, 5A505)

#### **Iron I-II**

\* Tel Beth Shan V James 1966, Fig. 31.1

Tel Beth Shan Northern cem. Oren 1973, Fig. 43.13

#### **Iron II**

# Hazor V Yadin *et al.* 1961, Pl. 225.15

# Hazor VI Yadin *et al.* 1961, Pl. 219.11

Tel Beth Shan IV James 1966, Fig. 67.26

# Tel Beth Shan IV James 1966, Fig. 67.28

Tell Abou Danne IId/A6 Lebeau 1983, Pl. 31.4  
Tell Afis Area D level 3 Mazzoni 1988a, Fig. 14.8  
Tell Afis Area D level 4 Mazzoni 1988a, Fig. 15.1  
Tell Afis Area D level 6 Mazzoni 1988a, Fig. 21.13, 20-21, 24  
Tell Judeideh IV see Lehmann 1996, 367 (Form 41)

#### **Iron II-III**

Tell Judeideh IV/III see Lehmann 1996, 367 (Form 41)

#### **Iron III**

Tell Afis Area D level 2 Mazzoni 1988a, Fig. 9.4

#### **Unclear Context**

Jerablus Yunus cem. Woolley 1939b, Pl. 23.B16  
Tell Judeideh Unstrat. see Lehmann 1996, 367 (Form 41)

### **B.17.1.4 CLASS 134d**

#### **Iron I**

# Hazor IX Yadin *et al.* 1960, Pl. 52.7  
Hazor IX Yadin *et al.* 1961, Pl. 178.12  
# Hazor IX/X Unpublished  
Hazor X Yadin *et al.* 1961, Pl. 171.11  
Pella Area III level I McNicoll *et al.* 1992, Pl. 52.1-5  
Pella Iron I Unpublished  
\*\* Sarepta Area Y level E Anderson 1988, Pl. 31.11  
\* Tel Beth Shan VI lower Yadin & Geva 1986, Fig. 22.11-12  
Tel Dan V Biran 1989b, Fig. 22.4  
Tell Abu Hawam IV Hamilton 1935, 30, No. 164  
Tell Keisan 9c Briend & Humbert 1980, Pl. 80.1

#### **Iron I-II**

Akhziv Tomb N1 E. Mazar 2004, Fig. 1.6  
Pella Area III level O McNicoll *et al.* 1992, Pl. 67.12  
Tel Beth Shan V James 1966, Figs 19.5; 31.19, 26  
Tel Beth Shan V James 1966, Fig. 47.18  
Tel Beth Shan Northern cem. Oren 1973, Fig. 43.15  
Tel Beth Shan Northern cem. Oren 1973, Fig. 46.17  
Tel Dan IV Biran 1999, Fig. 4.10  
Tell Mastuma Central Area level I Egami & Masuda 1982, Pl. 6.3

#### **Iron II**

Hama E Fugmann 1958, Fig. 188 (5A875, 5A879, 5A896, 5B676, 5B686)  
\* Hama E Fugmann 1958, Fig. 188 (5B299)  
Hama E Fugmann 1958, Fig. 216 (6B540, 6B541, 6B543, 6B544, 6B545, 6B546)  
Hama E Fugmann 1958, Figs 245 (5B658); 269 (6B482, 6B483)  
Hama E Fugmann 1958, Fig. 325 (8A57, 8A63, 8A64, 8A70, 8A155, 8A156, 8A220)  
# Hazor IV Yadin *et al.* 1958, Pl. 69.14  
# Hazor IV Yadin *et al.* 1960, Pl. 98.21  
# Hazor IV Yadin *et al.* 1961, Pl. 254.18  
# Hazor V Yadin *et al.* 1958, Pl. 74.10  
Hazor V Yadin *et al.* 1960, Pl. 82.11  
# Hazor V Yadin *et al.* 1961, Pl. 222.10  
# Hazor V Yadin *et al.* 1961, Pl. 231.5  
# Hazor VI Yadin *et al.* 1958, Pl. 51.4  
# Hazor VI Yadin *et al.* 1960, Pl. 66.15, 28  
# Hazor VI Yadin *et al.* 1961, Pl. 249.11-12  
# Hazor VII Yadin *et al.* 1958, Pl. 49.16  
# Hazor VII Yadin *et al.* 1960, Pl. 63.16, 18  
Hazor VII Ben Tor *et al.* 1997, Fig. III.33 (7)  
\* Hazor VIII Yadin *et al.* 1958, Pl. 47.10  
# Hazor VIII Yadin *et al.* 1958, Pl. 47.20  
# Hazor VIII Yadin *et al.* 1960, Pl. 54.9, 12-14  
# Hazor VIII Yadin *et al.* 1961, Pl. 247.12-13

Hazor VIII Ben Tor *et al.* 1997, Fig. III.26 (1)  
 Sidon Iron II Doumet-Serhal 2006, Fig. 31.26  
 #\* Sarepta Area Y level D Anderson 1988, Pl. 33.20  
 Tel Beth Shan IV James 1966, Fig. 68.1-2  
 Tel Dan III Biran 1999, Fig. 11.2  
 Tell Afis Area D level 3 Mazzoni 1988a, Fig. 14.10  
 Tell Afis Area D level 4 Mazzoni 1988a, Fig. 15.15-16; Cecchini 1988, Figs 7.16; 8.5  
 Tell Afis Area D level 5 Mazzoni 1988a, Fig. 20.4  
 Tell Afis Area D level 6 Mazzoni 1988a, Fig. 21.12  
 Tell Afis Area E2 level 1 Degli Esposti 1998, Fig. 10.19  
 \* Tell Afis Area E2 level 2 Degli Esposti 1998, Fig. 10.20  
 # Tell Afis Area Gc level 8a Cecchini 1998, Fig. 19.6-7  
 Tell Afis Area Ge level 1 Cecchini 1998, Fig. 16.11  
 # Tell Afis Area Gn level 5 Cecchini 1998, Fig. 38.1  
 # Tell Mastuma Central Area level I-2 Egami & Masuda 1984, Pl. 6.5  
 Tell Mastuma Central Area level I-2 Egami & Masuda 1984, Pl. 6.6  
 Tell Mastuma South Area Wada 1994, Fig. 1.6  
 Tell Mishrife Operation C level II al Maqdissi 2003, Fig. 12.2  
 Tell Mishrife Iron II Unpublished  
 Tell Nebi Mend Trench V Level B Unpublished  
 Tell Sheikh Hassan 3 Schneider 1999a, Fig. 5.5-6  
 # Tyre IV Bikai 1978b, Pl. 15.3

#### **Iron I-III**

Akhziv South Cem XI Dayagi-Mendels 2002, 23 (3)

#### **Iron II-III**

Tell Afis Area A (Afis VIII/IX) D'Amore 2005, Fig. 16.3

Hazor III/IV Yadin *et al.* 1958, Pl. 78.7

#### **Iron III**

\* Al Mina V Lehmann 1996, Pl. 16 (83d/1)

\*\* Al Mina VIII-V du Plat Taylor 1959, Fig. 1.12

Tell Afis Area B (Afis IX) Mazzoni 2000b, Fig. 3.5

Tell Afis Area D level 2 Mazzoni 1988a, Fig. 9.22

Tell Afis Area Gn level 3 Cecchini 1998, Fig. 38.18

Tell Afis Area Gc level 5 Cecchini 1998, Fig. 29.26

# Tell Afis Area Gc level 6 Cecchini 1998, Fig. 26.15

Tell Afis Area Gc level 6 Cecchini 1998, Fig. 27.7

# Tell Afis Area Gc level 7b Cecchini 1998, Fig. 20.26-27

Tell Afis Area Gc level 7b Cecchini 1998, Fig. 22.12

Tell Keisan 5 Briend & Humbert 1980, Pl. 41.5

Tell Shiyuk Fawqani Area G level 2 Luciani 2005, Pl. 10.131-132

#### **Iron II-Persian**

Akhziv South Cem 68 E. Mazar 2001, Fig. 52.3-4

#### **Persian**

\*\* Al Mina III Lehmann 1996, Pl. 25 (157/2)

Tell Rifa'at 1c Lehmann 1996, Pl. 12 (62/3)

Tell Shiyuk Fawqani Area G level 1 Luciani 2005, Pl. 40.472-473

#### **Unclear Context**

Al Mina Unstrat. Lehmann 1996, Pl. 16 (83b/2)

Jerablus Yunus cem. Woolley 1939b, Pl. 23.B17

Tell Judeideh Unstrat. see Lehmann 1996, 374 (Form 83a)

Tell Mishrife Unstrat. du Mesnil du Buisson 1935, Fig. 1.3-4

# Tell Tayinat Unstrat. Batiuk *et al.* 2005, Fig. 7.14 (4)

### **B.17.1.5 CLASS 134e**

#### **Iron I**

Hama F Fugmann 1958, Fig. 165 (5A553)

Hazor IX Yadin *et al.* 1960, Pl. 52.2

Hazor IX Yadin *et al.* 1961, Pl. 178.17

Hazor IX/X Yadin *et al.* 1958, Pl. 45.17  
# Hazor IX/X Unpublished  
Hazor X Yadin *et al.* 1961, Pl. 207.3-4  
Pella Iron I Unpublished  
Tell Mishrife Iron I Unpublished  
**Iron I-II**  
Tel Dan IV Biran 1999, Fig. 4.11  
**Iron II**  
Hama E Fugmann 1958, Fig. 269 (above 6B468)  
Hazor IV Yadin *et al.* 1958, Pl. 69.20  
Hazor V Yadin *et al.* 1960, Pl. 93.4  
# Hazor V Yadin *et al.* 1961, Pl. 222.4  
Hazor V Yadin *et al.* 1961, Pl. 223.13  
# Hazor V Ben Tor *et al.* 1997, Fig. III.42 (21)  
Hazor VI Yadin *et al.* 1958, Pl. 51.20  
# Hazor VI Yadin *et al.* 1961, Pl. 181.11  
Hazor VI Yadin *et al.* 1961, Pl. 214.28  
# Hazor VII Yadin *et al.* 1960, Pl. 63.15, 17, 24  
Hazor VII Ben Tor *et al.* 1997, Fig. III.32 (4)  
Hazor VIII Yadin *et al.* 1960, Pl. 54.6, 11  
# Hazor VIII Yadin *et al.* 1960, Pl. 54.10  
Megiddo Area H level 3 (IVA) Finkelstein *et al.* 2000b, Fig. 11.52(4)  
# Tell Abou Danne IId/A6 Lebeau 1983, Pl. 19.1-4  
Tell Afis Area B (Afis VIII) Scigliuzzo 2002, Fig. 13.2, 4  
# Tell Afis Area B (Afis VIII) Virgilio 2005, Fig. 34.3  
Tell Afis Area D level 3 Mazzoni 1988a, Fig. 14.6  
Tell Afis Area D level 4 Mazzoni 1988a, Fig. 15.14, 17; Cecchini 1988, Fig. 8.2-4  
Tell Afis Area D level 5 Mazzoni 1988a, Fig. 20.8  
Tell Afis Area D level 6 Mazzoni 1988a, Fig. 21.10-11  
Tell Afis Area E1 level 2 Mazzoni 1998a, Fig. 24.7  
# Tell Afis Area E2 level 1 Degli Esposti 1998, Fig. 10.21  
Tell Afis Area L level 4 D'Amore 1998a, Fig. 6.20  
Tell Mastuma South Area Wada 1994, Fig. 1.13  
Tell Mishrife Iron II Unpublished  
# Tell Nebi Mend Trench V Level B Unpublished  
**Iron II-III**  
Akhziv Tomb N3 E. Mazar 2004, Fig. 1.5, 9  
# Ras Ibn Hani Iron II/III Bounni *et al.* 1976a, Fig. 27.13  
**Iron III**  
Tell Afis Area D level 1 Cecchini 1988, Fig. 6.4  
Tell Afis Area D level 2 Mazzoni 1988a, Fig. 10.7-11, 13  
# Tell Afis Area Gc level 3 Cecchini 1998, Fig. 33.16  
# Tell Afis Area Gc level 4 Cecchini 1998, Fig. 31.11  
Tell Afis Area Gc level 4 Cecchini 1998, Fig. 32.4  
Tell Afis Area Gc level 6 Cecchini 1998, Fig. 27.8-10  
# Tell Afis Area Gc level 7b Cecchini 1998, Fig. 21.13, 19  
Tell Afis Area Gc level 7b Cecchini 1998, Figs 23.7-10; 24.1  
Tell Afis Area Gn level 3 Cecchini 1998, Fig. 39.10  
**Iron III-Persian**  
Tell Judeideh II/III see Lehmann 1996, 364 (Form 19)  
**Persian**  
Sidon Persian Doumet-Serhal 2006, Fig. 18.6-8  
\* Sidon Persian Doumet-Serhal 2006, Fig. 18.11-12, 14-16  
Tell Shiyuk Fawqani Area G level 1 Luciani 2005, Pl. 40.479  
Tell Shiyuk Fawqani Area G level 1 Luciani 2005, Pl. 41.480  
**Unclear Context**  
Jerablus Yunus cem. Woolley 1939b, Pl. 23.B13

## **B.17.2 CLASS 135**

### **Iron III**

# Megiddo II/III Lamon & Shipton 1939, Fig. 27.85  
Tell Keisan 4 Briend & Humbert 1980, Pls 28.12-12a; 33.1-2  
Tell Keisan 5 Briend & Humbert 1980, Pl. 45.4

### **Persian**

Beirut Bey 010 Persian Sapin & Sayegh 1998, 107(62-66)  
Tell Shiyuk Fawqani Area G level 1 Luciani 2005, Pl. 40.476

## **B.17.3 CLASS 136**

### **Iron II-III**

Tell Judeideh IV/III see Lehmann 1996, 368 (Form 53)

### **Iron III**

Ras al-Bassit Cem. Courbin 1993a, Fig. 9.7(C527)  
Tell Abou Danne IIc/A5 Lebeau 1983, Pl. 102.5

### **Unclear Context**

# Al Mina Unstrat. du Plat Taylor 1959, Fig. 6.11  
Tell Judeideh Unstrat. see Lehmann 1996, 368 (Form 53)

## **B.17.4 CLASS 137**

### **Iron II**

Tell Abou Danne IId/A6 Lebeau 1983, Pl. 33.3-4  
Tell Rifa'at 2b-c Seton Williams 1961, Pl. 38.14  
Tell Rifa'at 2b-c Seton Williams 1961, Pl. 39.1  
Tell Rifa'at 2b-c Matthers 1981b, Fig. 235.16

### **Iron II-III**

# Tell Tayinat Building phase 3 Swift 1958, Fig. 31

### **Iron III**

# Al Mina VI/V Lehmann 1996, Pl. 30 (183/1)  
Tell Tayinat Building phase 4 see Lehmann 1996, 394 (Form 183)

## **B.17.5 CLASS 138**

### **Iron II-III**

Deve Höyük Cem. I Moorey 1980, Fig. 3.9

### **Persian**

Tell Shiyuk Fawqani Area G level 1 Luciani 2005, Pl. 37.453

### **Unclear Context**

Jerablus Yunus cem. Woolley 1939b, Pl. 23.B9

## **B.17.6 CLASS 139**

### **Iron II**

Hazor IV Yadin *et al.* 1958, Pl. 30.31  
Hazor IV Yadin *et al.* 1958, Pl. 58.4  
Hazor IV Yadin *et al.* 1958, Pl. 69.32  
# Hazor IV Yadin *et al.* 1958, Pl. 71.16  
Hazor IV Yadin *et al.* 1960, Pl. 98.16  
# Hazor IV Yadin *et al.* 1960, Pl. 98.25, 27, 32  
# Hazor IV Yadin *et al.* 1960, Pl. 98.26, 28, 31, 36, 38  
# Hazor IV Yadin *et al.* 1961, Pl. 254.21-22  
# Hazor IV/V Yadin *et al.* 1958, Pl. 71.15  
Hazor V Yadin *et al.* 1958, Pl. 54.2, 14-15  
# Hazor V Yadin *et al.* 1958, Pl. 54.3

# Hazor V Yadin *et al.* 1958, Pl. 54.4  
 # Hazor V Yadin *et al.* 1960, Pl. 82.3, 12  
 Hazor V Yadin *et al.* 1960, Pl. 82.13-14  
 # Hazor V Yadin *et al.* 1960, Pl. 93.7, 10  
 # Hazor V Yadin *et al.* 1961, Pl. 225.12  
 # Hazor V Yadin *et al.* 1961, Pl. 223.15  
 # Hazor V Yadin *et al.* 1961, Pl. 222.18  
 # Hazor V Yadin *et al.* 1961, Pl. 226.6-7, 9  
 Hazor V Yadin *et al.* 1961, Pl. 226.10  
 # Hazor V Yadin *et al.* 1961, Pl. 226.11  
 Hazor V Yadin *et al.* 1961, Pl. 230.2  
 Hazor V Yadin *et al.* 1961, Pl. 251.22  
 Hazor VI Yadin *et al.* 1958, Pl. 51.19  
 # Hazor VI Yadin *et al.* 1958, Pl. 51.21  
 # Hazor VI Yadin *et al.* 1958, Pl. 51.22  
 # Hazor VI Yadin *et al.* 1960, Pl. 67.1  
 # Hazor VI Yadin *et al.* 1960, Pl. 67.2, 7  
 # Hazor VI Yadin *et al.* 1961, Pl. 219.10  
 # Hazor VI Yadin *et al.* 1961, Pl. 249.14-15  
 # Hazor VI Ben Tor *et al.* 1997, Fig. III.36 (4)  
 # Hazor VI Ben Tor *et al.* 1997, Fig. III.38 (4)  
 # Hazor VII Yadin *et al.* 1958, Pl. 49.15  
 Hazor VII Yadin *et al.* 1960, Pl. 63.21  
 # Hazor VII Yadin *et al.* 1960, Pl. 63.23  
 # Hazor VII Yadin *et al.* 1961, Pl. 214.32  
 Hazor VIII Yadin *et al.* 1958, Pl. 47.13  
 # Ras al-Bassit Findgroup A Braemer 1986, Fig. 1.1  
 # Tel Beth Shan IV James 1966, Fig. 68.3  
 # Tel Beth Shan Area P level 7 A. Mazar 2001, Fig. 12.4  
 # Tell Abou Danne IIc/A6 Lebeau 1983, Pl. 14.4  
 Tell Afis Area Gn level 5 Cecchini 1998, Fig. 38.5  
 Tell Afis Area L level 6a D'Amore 1998a, Fig. 6.18  
 Tell Nebi Mend Trench V Level B Unpublished  
 Tille Höyük VIII Blaylock 1999, Fig. 5.11-12  
 # Tille Höyük VIII Blaylock 1999, Fig. 11.21-23

**Iron II-III**

Al Mina VIII Lehmann 1996, Pl. 19 (99/3)  
 # Beirut Bey 003 abandonment Badre 1997b, Fig. 36.6  
 # Hazor III/IV Yadin *et al.* 1958, Pl. 78.8  
 Tell Shiyuk Fawqani Area F (IX) Makinson 2005, Pl. 4.19

**Iron III**

# Al Mina VII/VI du Plat Taylor 1959, Fig. 6.8  
 # Hazor III Yadin *et al.* 1958, Pl. 77.7  
 # Hazor III Yadin *et al.* 1958, Pl. 77.8, 22  
 Hazor III Yadin *et al.* 1958, Pl. 77.23  
 Megiddo II/III Lamon & Shipton 1939, Fig. 23.6, 8-9  
 \*\* Megiddo II/III Lamon & Shipton 1939, Fig. 23.12  
 # Megiddo II/III Lamon & Shipton 1939, Fig. 25.66  
 # Ras al-Bassit Findgroup E Braemer 1986, Fig. 5.26  
 Tell Abou Danne IIc/A5 Lebeau 1983, Pls 104.1; 105.1  
 # Tell Abou Danne IIc/A5 Lebeau 1983, Pl. 104.2  
 # Tell Afis Area Gc level 3 Cecchini 1998, Fig. 33.12  
 Tell Afis Area Gc level 3 Cecchini 1998, Fig. 33.15  
 # Tell Afis Area Gc level 5 Cecchini 1998, Fig. 29.15  
 # Tell Afis Area Gc level 6 Cecchini 1998, Fig. 26.8, 19-21  
 # Tell Afis Area Gc level 6 Cecchini 1998, Fig. 26.23  
 # Tell Afis Area Gc level 7b Cecchini 1998, Figs 20.14; 21.6-8, 10-12, 17  
 Tell Afis Area Gc level 7b Cecchini 1998, Fig. 22.17  
 Tell Ahmar Area C level 2 Jamieson 1999, Fig. 1.5  
 Tell Ahmar Area C level 2 Jamieson 1999, Fig. 6.10-12

Tell Ahmar Area C level 2 Jamieson 2000, Fig. 4.1-4  
# Tell Ahmar Area C level 2 Jamieson 2000, Fig. 12.6-10  
Tell Ahmar Area C level 2 Jamieson 2000, Fig. 14.5-8  
Tell Ahmar Area D Iron III Jamieson 2005, Fig. 12.1, 4, 7, 8  
Tell Ahmar Area D Iron III Jamieson 2005, Fig. 13.1, 3-4  
Tell Arqa 9 Chaaya 2000, Fig. 3.3  
Tell Jurn Kabir Findgroup C Eidem and Ackermann 1999, Fig. 8.10  
Tell Rifa'at 2a see Lehmann 1996, 379 (Form 101)

#### **Persian**

Megiddo I Lamon & Shipton 1939, Fig. 23.6, 8

#### **Unclear Context**

Jerablus Yunus cem. Woolley 1939b, Pl. 24.B32  
# Tell Nebi Mend Unstrat. Pezard 1931, Pl. 23.1.6  
# Tell Rifa'at Unstrat. Lehmann 1996, Pl. 19 (101/2)  
Tell Sheikh Hassan Unstrat. Schneider 1999b, Fig. 4c

## **B.17.7 CLASS 140**

### **Iron II**

Hama Cem. IV Riis 1948, Fig. 108  
Hama E1 Riis & Buhl 1990, 130 (Form XXXC1)  
# Hazor IV Yadin *et al.* 1958, Pl. 69.27  
# Hazor V Yadin *et al.* 1960, Pl. 93.1  
# Hazor V Yadin *et al.* 1961, Pl. 251.23  
# Hazor V Ben Tor *et al.* 1997, Fig. III.42 (7)  
# Hazor VI Yadin *et al.* 1960, Pl. 66.26  
# Hazor VI Yadin *et al.* 1961, Pl. 182.12  
# Hazor VI Yadin *et al.* 1961, Pl. 182.14  
# Hazor VI Ben Tor *et al.* 1997, Fig. III.37 (3)  
# Hazor VIII Yadin *et al.* 1960, Pl. 54.25  
# Ras al-Bassit Findgroup C Braemer 1986, Fig. 3.13

### **Iron II-III**

Hazor III/IV Yadin *et al.* 1958, Pl. 78.12, 27

## **B.17.8 CLASS 141**

### **B.17.8.1 CLASS 141a**

#### **Iron I**

Hazor IX Yadin *et al.* 1960, Pl. 52.5-6  
# Megiddo Area K level 3 (VB) Finkelstein *et al.* 2000b, Fig. 11.18(7)  
# Pella Area III level I McNicoll *et al.* 1992, Pl. 49.3  
# Pella Area III level I McNicoll *et al.* 1992, Pl. 68.3  
Sarepta Area X level V Khalifeh 1988, Type X12  
Sarepta Area X level VI Khalifeh 1988, Type X12  
Tell Jurn Kabir Findgroup A Eidem and Ackermann 1999, Fig. 5.15  
Tell Keisan 9c Briend & Humbert 1980, Pl. 80.2

#### **Iron I-II**

Akhziv Tomb N1 E. Mazar 2004, Fig. 1.2  
Sarepta Area X level VII Khalifeh 1988, Type X12

#### **Iron II**

Akhziv South Cem 73 E. Mazar 2001, Fig. 43.1  
# Beirut Bey 003 glacis II Badre 1997b, Fig. 35.6  
# Hazor IV Yadin *et al.* 1958, Pl. 58.3  
Hazor IV Yadin *et al.* 1961, Pl. 254.12  
# Hazor V Yadin *et al.* 1958, Pl. 73.30  
Hazor V Yadin *et al.* 1960, Pl. 79.13  
# Hazor V Yadin *et al.* 1960, Pl. 79.14



Hazor V Yadin *et al.* 1960, Pl. 92.10-11, 19  
 # Hazor V Yadin *et al.* 1960, Pl. 92.27  
 # Hazor V Yadin *et al.* 1961, Pl. 189.3  
 Hazor V Yadin *et al.* 1961, Pl. 226.1  
 Hazor V Yadin *et al.* 1961, Pl. 230.8  
 # Hazor V Yadin *et al.* 1961, Pl. 251.20  
 # Hazor VI Yadin *et al.* 1961, Pl. 249.9  
 # Hazor VI Ben Tor *et al.* 1997, Figs III.36 (3); III.37 (2)  
 # Hazor VII Yadin *et al.* 1961, Pl. 180.7  
 # Hazor VII Yadin *et al.* 1961, Pl. 247.8  
 # Hazor VIII Yadin *et al.* 1958, Pl. 47.19  
 Hazor VIII Yadin *et al.* 1960, Pl. 54.1, 5  
 # Megiddo Area H level 3 (IVA) Finkelstein *et al.* 2000b, Fig. 11.43(9)  
 Sarepta Area Y level D Anderson 1988, Pl. 34.3  
 Tel Beth Shan IV James 1966, Fig. 68.9  
 # Tel Beth Shan V upper James 1966, Fig. 63.6  
 Tel Dan II Pakman 1992, Fig. 1.7  
 Tell Abou Danne IId/A6 Lebeau 1983, Pls 12.1-2; 25; 30.2-3  
 # Tell Abou Danne IId/A6 Lebeau 1983, Pl. 29.4  
 Tell Afis Area D level 3 Mazzoni 1988a, Fig. 14.7  
 Tell Arqa 10AB Thalmann 1978b, Fig. 46.8  
 Tell Nebi Mend Trench V Level B Unpublished  
 Tell Sheikh Hassan 3 Schneider 1999a, Fig. 5.3-4, 6  
 # Tell Tayinat Iron II Unpublished  
 Tille Höyük VIII Blaylock 1999, Fig. 5.1  
 Tyre II Bikai 1978b, Pl. 10.28  
**Iron I-III**  
 Akhziv South Cem I Dayagi-Mendels 2002, Fig. 3.2(5)  
**Iron II-III**  
 \* Akhziv East Cem XXXI Dayagi-Mendels 2002, 86 (3)  
 Akhziv Tomb N3 E. Mazar 2004, Fig. 1.20  
 # Beirut Bey 003 storage room Badre 1997b, Fig. 45.5  
 # Ras Ibn Hani Iron II/III Bounni *et al.* 1976a, Fig. 27.16  
 Sarepta Area X level VIII Khalifeh 1988, Type X12  
 Sarepta Area Y level C Anderson 1988, Pl. 35.1, 5, 12  
 \*\* Sarepta Area Y level C Anderson 1988, Pl. 38.9  
 Tell Afis Area A (Afis VIII/IX) Soldi 2005, Fig. 20.4  
 Tell Shiyuk Fawqani Area F (IX) Makinson 2005, Pl. 5.24-25  
 Tell Shiyuk Fawqani Area F (IX) Makinson 2005, Pl. 6.26-30  
 # Tyre I Bikai 1978b, Pl. 1.12  
**Iron III**  
 Al Mina VI Lehmann 1996, Pl. 19 (103/1+3)  
 Megiddo II/III Lamon & Shipton 1939, Fig. 23.7  
 # Ras al-Bassit Findgroup D Braemer 1986, Fig. 4.20  
 # Ras al-Bassit Findgroup H Braemer 1986, Fig. 8.43  
 Tell Abou Danne IId/A5 Lebeau 1983, Pls 105.5; 106.2  
 Tell Afis Area Gc level 2 Cecchini 1998, Fig. 35.20  
 # Tell Afis Area Gc level 3 Cecchini 1998, Fig. 33.10  
 Tell Afis Area Gc level 4 Cecchini 1998, Fig. 32.1  
 # Tell Afis Area Gc level 5 Cecchini 1998, Fig. 29.13  
 Tell Afis Area Gc level 5 Cecchini 1998, Fig. 29.23, 25  
 # Tell Afis Area Gc level 6 Cecchini 1998, Fig. 26.17  
 Tell Afis Area Gc level 6 Cecchini 1998, Fig. 27.14-16  
 # Tell Afis Area Gc level 7b Cecchini 1998, Fig. 20.28  
 Tell Afis Area Gc level 7b Cecchini 1998, Fig. 22.16  
 Tell Ahmar Area C level 2 Jamieson 1999, Fig. 1.8, 10, 13  
 # Tell Ahmar Area C level 2 Jamieson 1999, Fig. 6.3, 5, 7  
 Tell Ahmar Area C level 2 Jamieson 2000, Fig. 3.1-8  
 Tell Ahmar Area C level 2 Jamieson 2005, Fig. 4.3.11-12, 14-18  
 Tell Ahmar Area D Iron III Jamieson 2005, Fig. 3.1, 3-4

Tell Ahmar Area D Iron III Jamieson 2005, Fig. 4.1-3  
Tell Jurn Kabir Findgroup C Eidem and Ackermann 1999, Fig. 8.8, 11  
# Tell Keisan 5 Briend & Humbert 1980, Pl. 40.6  
Tell Keisan 5 Briend & Humbert 1980, Pl. 41.1  
Tell Shiyuk Fawqani Area G level 2 Luciani 2005, Pl. 8.106-107, 113  
Tell Shiyuk Fawqani Area G level 2 Luciani 2005, Pl. 10.126-130  
Tell Shiyuk Fawqani Area G level 2 Luciani 2005, Pl. 13.154-156  
Tell Shiyuk Fawqani Area G level 2 Luciani 2005, Pl. 14.158-161

#### **Iron II-Persian**

Akhziv South Cem 68 E. Mazar 2001, Fig. 52.11  
# Akhziv East Cem VI Dayagi-Mendels 2002, Fig. 4.5(1)

#### **Iron III-Persian**

Kefrik Unstrat. Moorey 1980, Fig. 23.558

#### **Persian**

Kamid el-Lawz Persian Cem. Poppa 1978, Gr. 87.7  
Megiddo I Lamon & Shipton 1939, Fig. 23.7  
Sarepta Area Y level B Anderson 1988, Pl. 38.14-15  
Tell Keisan 3 Briend & Humbert 1980, Pl. 20.6, 8-9  
Tell Keisan I Seton-Williams 1980, Pl. 108.3  
Tell Shiyuk Fawqani Area F (X) Makinson 2005, Pl. 31.207-210  
Tell Shiyuk Fawqani Area G level 1 Luciani 2005, Pl. 43.498-504

#### **Unclear Context**

# Al Mina Unstrat. du Plat Taylor 1959, Fig. 6.7  
Al Mina Unstrat. Lehmann 1996, Pl. 19 (103/2)  
Jerablus Yunus cem. Woolley 1939b, Pl. 23.B2  
\*\* Sarepta Area X unstrat. Pritchard 1988, Fig. 38.3  
\* Sarepta Area X unstrat. Pritchard 1988, Fig. 38.4  
Sarepta Area X unstrat. Pritchard 1988, Fig. 38.9, 16  
Tell Sheikh Hassan Unstrat. Schneider 1999b, Fig. 5d(1)  
Tell Sheikh Hassan Unstrat. Schneider 1999b, Figs 6-7

### **B.17.8.2 CLASS 141b**

#### **Iron I**

Tell Jurn Kabir Findgroup A Eidem and Ackermann 1999, Fig. 4.12

#### **Iron I-II**

Tell Mishrife Operation H levels 5-6 Barro 2002, Fig. 107.4

#### **Iron II**

# Hazor V Yadin *et al.* 1960, Pl. 82.10  
# Hazor V Yadin *et al.* 1961, Pl. 223.12  
Tel Dan II Pakman 1992, Fig. 1.3  
Tell Sheikh Hassan 3 Schneider 1999a, Fig. 4.2(1-2)  
Tille Höyük IV-V Blaylock 1999, Fig. 4.17-19  
Tille Höyük VIII Blaylock 1999, Fig. 5.14  
Tille Höyük VIII Blaylock 1999, Fig. 11.24

#### **Iron II-III**

Tell Shiyuk Fawqani Area F (IX) Makinson 2005, Pl. 2.11  
Tell Shiyuk Fawqani Area F (IX) Makinson 2005, Pl. 3.14

#### **Iron III**

Tell Abou Danne IIc/A5 Lebeau 1983, Pl. 106.3  
# Tell Afis Area D level 2 Mazzoni 1988a, Fig. 9.11  
Tell Afis Area Gc level 2 Cecchini 1998, Fig. 35.19  
# Tell Afis Area Gc level 7b Cecchini 1998, Fig. 21.9  
Tell Ahmar Area C level 2 Jamieson 2000, Fig. 4.8-9  
Tell Ahmar Area D Iron III Jamieson 2005, Fig. 12.3, 5, 9  
Tell Jurn Kabir Findgroup C Eidem and Ackermann 1999, Fig. 8.7  
\* Tell Keisan 4 Briend & Humbert 1980, Pl. 30.3-4  
# Tell Keisan 5 Briend & Humbert 1980, Pl. 40.7  
Tell Shiyuk Fawqani Area G level 2 Luciani 2005, Pl. 8.111

## **Persian**

Tell Shiyuk Fawqani Area G level 1 Luciani 2005, Pl. 38.460

### **Unclear Context**

Tell Rifa'at 2-3 (Iron Age) Lehmann 1996, Pl. 21 (124/1)

Tell Sheikh Hassan Unstrat. Schneider 1999b, Fig. 5d(2-6)

## **B.17.8.3 CLASS 141c**

### **Iron I**

Hazor IX Yadin *et al.* 1961, Pl. 175.10

# Hazor IX Yadin *et al.* 1961, Pl. 178.33

Hazor IX/X Unpublished

Pella Area III level I McNicoll *et al.* 1992, Pl. 49.7

# Pella Area III level I McNicoll *et al.* 1992, Pl. 68.2

\* Pella Area VIII level 8 McNicoll *et al.* 1992, Pl. 64.7

# Pella Iron I Unpublished

Tell Afis Area E1 level 7 Mazzoni 1998a, Fig. 17.2

Tell Jurn Kabir Findgroup A Eidem and Ackermann 1999, Fig. 4.10-11

### **Iron I-II**

Pella Area III level O McNicoll *et al.* 1992, Pl. 67.7

### **Iron II**

Ain Dara Lower Mound Iron II Stone & Zimansky 1999, Fig. 70.132

# Beirut Bey 003 glaxis II Badre 1997b, Fig. 35.3

Hazor IV Yadin *et al.* 1960, Pl. 98.10, 13

# Hazor IV Yadin *et al.* 1960, Pl. 98.23, 39

# Hazor IV Yadin *et al.* 1961, Pl. 254.13-17

# Hazor V Yadin *et al.* 1958, Pl. 53.13, 16

# Hazor V Yadin *et al.* 1958, Pl. 54.1, 11

Hazor V Yadin *et al.* 1958, Pl. 67.12

# Hazor V Yadin *et al.* 1958, Pl. 67.23

# Hazor V Yadin *et al.* 1958, Pl. 71.5

Hazor V Yadin *et al.* 1958, Pl. 73.31

Hazor V Yadin *et al.* 1958, Pl. 74.8-9

Hazor V Yadin *et al.* 1960, Pl. 81.14-17, 21-22, 24, 26

# Hazor V Yadin *et al.* 1960, Pl. 81.18-20, 23, 25, 27-28

Hazor V Yadin *et al.* 1960, Pl. 92.12

# Hazor V Yadin *et al.* 1960, Pl. 92.13, 22-23

# Hazor V Yadin *et al.* 1961, Pl. 222.1-2, 5-6

Hazor V Yadin *et al.* 1961, Pl. 222.3

# Hazor V Yadin *et al.* 1961, Pl. 223.10-11, 14

Hazor V Yadin *et al.* 1961, Pl. 225.14

# Hazor V Yadin *et al.* 1961, Pl. 225.24-25

Hazor V Yadin *et al.* 1961, Pl. 225.27

Hazor V Yadin *et al.* 1961, Pl. 230.6-7

Hazor V Ben Tor *et al.* 1997, Fig. III.47 (5)

# Hazor VI Yadin *et al.* 1958, Pl. 51.17

# Hazor VI Yadin *et al.* 1960, Pl. 66.21

Hazor VI Yadin *et al.* 1960, Pl. 66.29

# Hazor VI Yadin *et al.* 1960, Pl. 66.30-31

Hazor VI Yadin *et al.* 1961, Pl. 182.5, 7

# Hazor VI Ben Tor *et al.* 1997, Fig. III.36 (6)

Hazor VI Ben Tor *et al.* 1997, Fig. III.37 (5)

# Hazor VI Ben Tor *et al.* 1997, Fig. III.38 (6-7)

# Hazor VII Yadin *et al.* 1958, Pl. 49.14

# Hazor VII Yadin *et al.* 1961, Pl. 180.5

# Hazor VII Ben Tor *et al.* 1997, Fig. III.33 (9-10, 18)

# Megiddo IVA Lamon & Shipton 1939, Fig. 25.62-63

# Pella Iron II Unpublished

\* Tel Beth Shan IV James 1966, Fig. 67.19

# Tel Beth Shan IV James 1966, Fig. 68.11  
 # Tel Beth Shan Area P level 7 A. Mazar 2001, Fig. 12.4  
 Tell Abou Danne IId/A6 Lebeau 1983, Pls 7.2-3; 10.1-3; 17.3-4; 21; 23; 24  
 # Tell Abou Danne IId/A6 Lebeau 1983, Pl. 15.3  
 Tell Afis Area A (Afis VIII/IX) Soldi 2005, Fig. 20.3  
 Tell Afis Area D level 6 Mazzoni 1988a, Fig. 21.8  
 # Tell Afis Area E2 level 1 Degli Esposti 1998, Fig. 10.12  
 Tell Afis Area E2 level 2 Degli Esposti 1998, Fig. 10.15  
 Tell Afis Area Gc level 8a Cecchini 1998, Fig. 19.11  
 # Tell Afis Area Gc level 8a Cecchini 1998, Fig. 19.5  
 Tell Afis Area Gc level 8b Cecchini 1998, Fig. 18.8  
 Tell Afis Area L level 2 D'Amore 1998a, Fig. 6.1  
 Tell Afis Area L level 3 D'Amore 1998a, Fig. 6.4  
 # Tell Afis Area L level 4 D'Amore 1998a, Fig. 6.3  
 Tell Afis Area L level 4 D'Amore 1998a, Fig. 6.6  
 Tell Afis Area L level 6a D'Amore 1998a, Fig. 6.5  
 Tell Arqa 10 Unpublished  
 # Tell Arqa 10AB Thalmann 1978b, Fig. 46.9  
 Tell Mastuma Central Area level I-2 Egami 1988, Pl. 17.6  
 Tell Sheikh Hassan 3 Schneider 1999a, Fig. 4.2(3)  
 # Tell Tayinat Iron II Unpublished  
 Tille Höyük VIII Blaylock 1999, Fig. 5.2  
 Tyre III Bikai 1978b, Pl. 10.33

#### **Iron I-III**

Akhziv South Cem I Dayagi-Mendels 2002, 6 (8)  
 Akhziv South Cem I Dayagi-Mendels 2002, Fig. 3.1(7)  
 # Akhziv East Cem XVII Culican 1982, Fig. 10g  
 # Akhziv East Cem XXXVI Culican 1982, Fig. 9c

#### **Iron II-III**

Akhziv South Cem XXI Dayagi-Mendels 2002, 36 (1)  
 # Beirut Bey 003 abandonment Badre 1997b, Fig. 36.11  
 # Beirut Bey 003 abandonment Badre 2000b, Fig. 5.4  
 # Beirut Bey 003 storage room Badre 1997b, Fig. 45.6  
 Sarepta Area Y level C Anderson 1988, Pl. 36.17  
 Tell Shiyuk Fawqani Area F (IX) Makinson 2005, Pl. 5.22-23

#### **Iron III**

\* Hazor III Yadin *et al.* 1958, Pl. 77.1  
 # Hazor III Yadin *et al.* 1958, Pl. 77.32  
 Megiddo II/III Lamon & Shipton 1939, Fig. 23.18  
 # Megiddo II/III Lamon & Shipton 1939, Fig. 25.61-64  
 # Ras al-Bassit Findgroup E Braemer 1986, Fig. 5.27  
 Tell Abou Danne IId/A5 Lebeau 1983, Pl. 105.3-4  
 Tell Afis Area A (Afis VIII/IX) Soldi 2005, Fig. 20.3  
 Tell Afis Area D level 1 Mazzoni 1988a, Fig. 8.6  
 Tell Afis Area D level 2 Mazzoni 1988a, Fig. 10.1-3, 5  
 # Tell Afis Area Gc level 2 Cecchini 1998, Fig. 35.2-3  
 Tell Afis Area Gc level 2 Cecchini 1998, Fig. 35.12-18  
 # Tell Afis Area Gc level 3 Cecchini 1998, Fig. 33.6-9  
 Tell Afis Area Gc level 3 Cecchini 1998, Fig. 33.13-14  
 # Tell Afis Area Gc level 4 Cecchini 1998, Fig. 31.12-14, 16  
 Tell Afis Area Gc level 4 Cecchini 1998, Fig. 31.24-28  
 # Tell Afis Area Gc level 5 Cecchini 1998, Fig. 29.11  
 # Tell Afis Area Gc level 5 Cecchini 1998, Fig. 29.12, 14  
 Tell Afis Area Gc level 5 Cecchini 1998, Fig. 29.21-22  
 # Tell Afis Area Gc level 6 Cecchini 1998, Fig. 26.14, 16, 18  
 Tell Afis Area Gc level 6 Cecchini 1998, Fig. 27.12-13, 18  
 # Tell Afis Area Gc level 7b Cecchini 1998, Figs 20.25, 30; 21.1-5, 18  
 Tell Afis Area Gc level 7b Cecchini 1998, Fig. 22.14-15  
 Tell Afis Area Gn level 2 Cecchini 1998, Fig. 39.16-17  
 # Tell Afis Area Gn level 4 Cecchini 1998, Fig. 38.10

Tell Ahmar Area D Iron III Jamieson 2005, Fig. 3.2, 5  
Tell Ahmar Area D Iron III Jamieson 2005, Fig. 5.15-16  
Tell Judeideh III see Lehmann 1996, 369 (Form 59)  
Tell Jurn Kabir Findgroup C Eidem and Ackermann 1999, Fig. 8.6  
# Tell Keisan 4 Briend & Humbert 1980, Pl. 30.1  
Tell Keisan 5 Briend & Humbert 1980, Pl. 41.2-3  
Tell Shiyuk Fawqani Area G level 2 Luciani 2005, Pl. 3.29-30  
Tell Shiyuk Fawqani Area G level 2 Luciani 2005, Pl. 13.151-153

#### **Persian**

Beirut Bey 010 Persian Doumet-Serhal & Sayegh 1998, 24(2)  
# Megiddo I Lamon & Shipton 1939, Fig. 25.61-62, 64  
Tell Afis Area Gc level 1 Cecchini 1998, Fig. 37.1  
Tell Shiyuk Fawqani Area G level 1 Luciani 2005, Pl. 38.464  
Tell Shiyuk Fawqani Area G level 1 Luciani 2005, Pl. 39.467-469  
Tell Sukas South Harbour cem. Riis 1979, Figs 33-34  
Tille Höyük X Blaylock 1999, Fig. 13.11

#### **Unclear Context**

Sarepta Area X unstrat. Pritchard 1988, Fig. 40.28  
Tell Judeideh Unstrat. see Lehmann 1996, 370 (Form 62)  
Tell Rifa'at Unstrat. see Lehmann 1996, 369 (Form 59)  
# Tell Tayinat Unstrat. Batiuk et al. 2005, Fig. 7.14 (2, 6)

### **B.17.8.4 CLASS 141d**

#### **Iron I**

# Hazor IX Yadin *et al.* 1961, Pl. 178.20  
Hazor IX Yadin *et al.* 1961, Pl. 178.21  
Pella Iron I Unpublished

#### **Iron II**

# Hazor IV Ben Tor *et al.* 1997, Fig. III.50 (1-3)  
Hazor V Yadin *et al.* 1958, Pl. 67.19-20  
Hazor V Yadin *et al.* 1960, Pl. 75.2  
Hazor V Yadin *et al.* 1960, Pl. 79.5  
# Hazor V Yadin *et al.* 1960, Pl. 80.33  
# Hazor V Yadin *et al.* 1960, Pl. 92.29  
Hazor V Yadin *et al.* 1961, Pl. 251.9  
# Hazor V Yadin *et al.* 1961, Pl. 251.14  
Hazor V Ben Tor *et al.* 1997, Fig. III.42 (22)  
# Hazor VI Yadin *et al.* 1958, Pl. 51.16  
# Hazor VI Yadin *et al.* 1960, Pl. 66.23  
Hazor VI Yadin *et al.* 1961, Pl. 182.1, 9  
# Hazor VI Ben Tor *et al.* 1997, Fig. III.41 (6)  
Hazor VII Yadin *et al.* 1960, Pl. 63.13  
# Hazor VII Yadin *et al.* 1961, Pl. 214.23  
Hazor VIII Yadin *et al.* 1958, Pl. 47.9  
# Hazor VIII Yadin *et al.* 1961, Pl. 247.7  
Pella Iron II Unpublished  
Tel Beth Shan IV James 1966, Fig. 68.5-6  
Tel Dan II Pakman 1992, Fig. 1.4, 6  
Tel Dan II Biran 1999, Fig. 7.9  
Tel Dan III Biran 1999, Fig. 4.4-5  
# Tel Jezreel Findgroup A Zimhoni 1997a, Fig. 1.6 (2)  
# Tel Jezreel Findgroup B Zimhoni 1997b, Fig. 2.8 (11)  
# Tell Abou Danne IId/A6 Lebeau 1983, Pl. 22.3  
Tell Abou Danne IId/A6 Lebeau 1983, Pl. 22.4  
Tell Afis Area B (Afis VIII) Scigliuzzo 2002, Fig. 12.1  
Tell Afis Area D level 3 Mazzoni 1988a, Fig. 14.11  
Tell Afis Area D level 4 Mazzoni 1988a, Fig. 15.22, 24  
Tell Afis Area D level 5 Mazzoni 1988a, Fig. 20.10

Tell Afis Area E1 level 2 Mazzoni 1998a, Fig. 24.10  
 Tell Afis Area E2 level 1 Degli Esposti 1998, Fig. 10.18  
 Tell Afis Area E2 level 1 Degli Esposti 1998, Fig. 11.3-4  
 Tell Afis Area Gc level 8a Cecchini 1998, Fig. 19.12  
 Tell Afis Area Gc level 8b Cecchini 1998, Fig. 18.9  
 Tell Afis Area Ge level 1 Cecchini 1998, Fig. 16.12  
 Tell Afis Area Gn level 5 Cecchini 1998, Fig. 38.7  
 Tell Mastuma Central Area level I-2 Egami & Masuda 1984, Pl. 6.8-9  
 Tell Mastuma South Area Wada 1994, Fig. 1.15  
 Tell Mishrife Operation C level II al Maqdissi 2003, Fig. 6.1-4  
 Tell Mishrife Iron II Unpublished  
 Tell Nebi Mend Trench V Level C Unpublished  
 # Tell Qarqur 8 Unpublished  
 Tell Sheikh Hassan 3 Schneider 1999a, Fig. 6.7(3)  
**Iron III**  
 Hazor III Yadin *et al.* 1958, Pl. 74.17  
 # Hazor III Yadin *et al.* 1958, Pl. 77.6  
 Tell Abou Danne IIc/A5 Lebeau 1983, Pl. 104.3-5  
 Tell Afis Area B (Afis IX) Mazzoni 2000b, Fig. 3.6  
 Tell Afis Area D level 1 Mazzoni 1988a, Fig. 8.4, 10  
 Tell Afis Area D level 2 Mazzoni 1988a, Fig. 10.4, 10  
 # Tell Afis Area Gc level 2 Cecchini 1998, Fig. 35.4  
 Tell Afis Area Gc level 4 Cecchini 1998, Fig. 32.6  
 Tell Afis Area Gc level 6 Cecchini 1998, Fig. 27.11, 19-20  
 # Tell Afis Area Gc level 7b Cecchini 1998, Fig. 20.21  
 Tell Afis Area Gc level 7b Cecchini 1998, Figs 22.18-24; 23.1-6  
 Tell Afis Area J (Afis IX) Oggiano 2002, Fig. 26.6  
**Unclear Context**  
 Tell Rifa'at 2-3 (Iron Age) Lehmann 1996, Pl. 13 (68/2)  
 Tell Tayinat Unstrat. Unpublished

## **B.17.9 CLASS 142**

**Iron II**  
 Tell Abou Danne IId/A6 Lebeau 1983, Pl. 33.1-2  
**Iron III**  
 # Tell Arqa 9 Chaaya 2000, Fig. 3.1  
 Tyre Al-Bass cem. V Núñez 2004a, Fig. 65.20  
**Iron II-Persian**  
 # Akhziv East Cem XII Dayagi-Mendels 2002, Fig. 4.10(1)  
 Akhziv South Cem 68 E. Mazar 2001, Fig. 52.12  
 # Akhziv South Cem 68 E. Mazar 2001, Fig. 52.13  
**Persian**  
 Beirut Bey 010 Persian Sapin & Sayegh 1998, 103(28)  
**Unclear Context**  
 Jerablus Yunus cem. Woolley 1939b, Pl. 23.B1, B3  
 Tell Rifa'at 2-3 (Iron Age) Lehmann 1996, Pl. 29 (177/1)

## **B.17.10 CLASS 143**

**Iron I**  
 Ain Dara Lower Mound Iron I Stone & Zimansky 1999, Fig. 70.126  
 \*\* Hazor IX Yadin *et al.* 1961, Pl. 208.31  
 Hazor IX/X Unpublished  
 # Hazor X Ben Tor *et al.* 1997, Fig. III.22 (1)  
 Pella Iron I Unpublished  
 Sarepta Area Y level G Anderson 1988, Pl. 26.10  
 Tel Beth Shan VI lower Yadin & Geva 1986, Fig. 22.10

Tell Afis Area E1 level 9c Venturi 1998a, Fig. 5.3, 9  
Tell Afis Area Ge level 3 Cecchini 1998, Fig. 14.16  
Tell Kazel Area II level 5 Badre *et al.* 1994, Fig. 32.d  
Tell Mishrife Iron I Unpublished  
Tell Qarqur 9 Unpublished

#### **Iron II**

# Hazor VI Yadin *et al.* 1961, Pl. 220.15  
# Hazor VI Ben Tor *et al.* 1997, Fig. III.36 (2)  
# Hazor VIII Ben Tor *et al.* 1997, Fig. III.26 (2)  
Khirbet Silm S. V. Chapman 1972, Fig. 24.105  
\*\* Khirbet Silm S. V. Chapman 1972, Fig. 25.138  
Sidon Iron II Doumet-Serhal 2006, Fig. 28.8  
# Tell Abou Danne IId/A6 Lebeau 1983, Pl. 28.1  
Tell Afis Area D level 5 Mazzoni 1988a, Fig. 20.5  
# Tell Afis Area Gc level 8b Cecchini 1998, Fig. 18.5  
# Tell Arqa 10CD Thalmann 1978b, Fig. 46.20  
Tell Jurn Kabir Findgroup B Eidem and Ackermann 1999, Fig. 6.9-10  
Tell Kazel Area I level 8 Gubel 1990a, Fig. 29.a  
# Tell Mastuma Central Area level I-2 Egami & Masuda 1984, Pl. 6.4  
Tell Mishrife Iron II Unpublished  
Tell Rachidiah Tomb IV Doumet 1982, Pl. XVI.90  
Tyre III Bikai 1978b, Pl. 10.8  
Tyre IV Bikai 1978b, Pls 15.21, 27; 16.6  
\*\* Tyre VIII Bikai 1978b, Pl. 19.20  
Tyre Al-Bass cem. III Núñez 2004a, Fig. 55.45-46

#### **Iron II-III**

Tell Shiyuk Fawqani Area F (IX) Makinson 2005, Pl. 3.16  
Tyre Al-Bass cem. IV Núñez 2004a, Fig. 64.8

#### **Iron III**

\*\* Al Mina VIII-V du Plat Taylor 1959, Fig. 1.11  
# Ras al-Bassit Findgroup E Braemer 1986, Fig. 5.28  
# Tell Afis Area Gc level 7b Cecchini 1998, Fig. 20.29  
# Tell Arqa 9 Thalmann 1978b, Fig. 46.18-19  
# Tell Keisan 4 Briend & Humbert 1980, Pl. 29.8  
Tell Sukas G3 Buhl 1983, Fig. XIV.213

#### **Iron II-Persian**

# Akhziv South Cem 70 E. Mazar 2001, Fig. 62.2

#### **Persian**

Beirut Bey 010 Persian Doumet-Serhal & Sayegh 1998, 19(5)  
Tell Shiyuk Fawqani Area G level 1 Luciani 2005, Pl. 33.402-403

#### **Unclear Context**

# Athlit Cremation cem. Johns 1934, Fig. 5.15  
# Tell Tayinat Unstrat. Unpublished  
Tell Tayinat Unstrat. Unpublished

## **B.17.11 CLASS 144**

### **B.17.11.1 CLASS 144a**

#### **Iron II**

# Ras al-Bassit Findgroup C Braemer 1986, Fig. 3.10  
# Sidon Iron II Doumet-Serhal 2004g, Pl. 14.8  
# Tell Arqa 10AB Thalmann 1978b, Fig. 46.3  
# Tyre III Bikai 1978b, Pl. 10.29  
# Tyre IV Bikai 1978b, Pl. 15.2, 5

#### **Iron I-III**

# Akhziv South Cem I Dayagi-Mendels 2002, 10 (7)  
Akhziv South Cem I Dayagi-Mendels 2002, Fig. 3.1(13)  
# Akhziv East Cem XXXVI Dayagi-Mendels 2002, 91 (7)

# Akhziv East Cem XXXVI Dayagi-Mendels 2002, Fig. 4.27(8)

**Iron II-III**

- # Al Mina VIII du Plat Taylor 1959, Fig. 6.10, 13
- # Al Mina VIII Lehmann 1996, Pl. 21 (120a/2)
- # Al Mina VIII Lehmann 1996, Pl. 21 (121/1)
- # Beirut Bey 003 abandonment Badre 1997b, Fig. 36.7
- # Beirut Bey 003 storage room Badre 1997b, Fig. 45.4
- # Qraye S. V. Chapman 1972, Fig. 28.302
- # Ras Ibn Hani Iron II/III Bounni *et al.* 1976a, Fig. 27.9
- # Sarepta Area Y level C Anderson 1988, Pl. 38.1

**Iron III**

- # Al Mina VI/V du Plat Taylor 1959, Fig. 6.24
- #\*\* Al Mina VIII-V du Plat Taylor 1959, Fig. 5.9
- # Ras al-Bassit Findgroup D Braemer 1986, Fig. 4.19
- # Ras al-Bassit Findgroup E Braemer 1986, Fig. 5.25

**Iron II-Persian**

Akhziv East Cem VIII Dayagi-Mendels 2002, Fig. 4.6(1)

**Unclear Context**

- # Al Mina Unstrat. see Lehmann 1996, 382 (Form 120a)
- # Athlit Cremation cem. Johns 1938, Fig. 8.2
- Sarepta Area X unstrat. Pritchard 1988, Fig. 38.10

## **B.17.11.2 CLASS 144b**

**Iron I-II**

- # Akhziv Tomb N1 E. Mazar 2004, Fig. 1.10
- Sarepta Area X level VII Khalifeh 1988, Type X2

**Iron II**

- # Akhziv South Cem 78 E. Mazar 2001, Fig. 36.2
- # Beirut Bey 003 glacis II Badre 1997b, Fig. 35.1-2
- Hazor VI Yadin *et al.* 1961, Pl. 181.13
- # Hazor VI Yadin *et al.* 1961, Pl. 182.19
- # Hazor VI Ben Tor *et al.* 1997, Fig. II.54 (12)
- # Hazor VII Yadin *et al.* 1960, Pl. 63.3, 5
- # Hazor VII Yadin *et al.* 1961, Pl. 214.13-14
- # Hazor VIII Yadin *et al.* 1960, Pl. 55.24-25
- Hazor VIII Ben Tor *et al.* 1997, Fig. III.24 (10)
- # Hazor VIII Ben Tor *et al.* 1997, Fig. III.24 (9)
- # Khalde Tomb 121 Saidah 1966, No. 22
- Pella Area VIII level 6 McNicoll *et al.* 1992, Pl. 66.11
- # Tel Dan II Biran 1999, Fig. 7.7
- # Tel Jezreel Iron II Zimhoni 1997b, Fig. 2.15 (2)
- Tell Arqa 10AB Thalmann 1978b, Fig. 46.12
- # Tell Arqa 10AB Chaaya 2000, Fig. 2.3
- Tell Arqa 10CD Thalmann 1978b, Fig. 46.15
- # Tell Rachidiah Tomb IV Doumet 1982, Pl. XVIII.78
- # Tyre III Bikai 1978b, Pl. 9.9-10

**Iron I-III**

# Akhziv East Cem XVII Dayagi-Mendels 2002, Fig. 4.14(5)

**Iron II-III**

- # Al Mina VIII du Plat Taylor 1959, Fig. 6.17, 20
- # Al Mina IX/VIII Lehmann 1996, Pl. 16 (84c/3+4); du Plat Taylor 1959, Fig. 6.15
- # Beirut Bey 003 abandonment Badre 1997b, Fig. 36.1-4
- Beirut Bey 003 abandonment Badre 1997b, Fig. 37.4, 6-7
- # Beirut Bey 003 abandonment Badre 2000b, Fig. 5.6-7
- Beirut Bey 003 abandonment Badre 2000b, Fig. 6.2
- # Qraye S. V. Chapman 1972, Fig. 28.303
- # Ras Ibn Hani Iron II/III Bounni *et al.* 1976a, Fig. 27.17
- Sarepta Area X level VIII Khalifeh 1988, Type X2, X10



Sarepta Area Y level C Anderson 1988, Pl. 35.7-8, 18  
# Sarepta Area Y level C Anderson 1988, Pl. 35.9  
Sarepta Area Y level C Anderson 1988, Pl. 36.13  
Tyre Al-Bass cem. IV Núñez 2004a, Fig. 51.2  
\* Tyre Al-Bass cem. Unstrat. Aubet 2004a, Fig. 8a

#### **Iron III**

# Al Mina VII/VI du Plat Taylor 1959, Fig. 6.18  
# Al Mina VI du Plat Taylor 1959, Fig. 6.31  
# Megiddo II/III Lamon & Shipton 1939, Fig. 24.34-35  
# Ras al-Bassit Findgroup G Braemer 1986, Fig. 7.35  
Sarepta Tomb 26 Culican 1970, Fig. 3.1  
# Tell Arqa 9 Thalmann 1978b, Fig. 46.13  
# Tell Arqa 9 Chaaya 2000, Fig. 3.2  
# Tell Keisan 5 Briend & Humbert 1980, Pl. 39.1-1b  
#\* Tell Keisan 5 Briend & Humbert 1980, Pl. 39.2-3, 5-7  
#\* Tell Keisan 5 Briend & Humbert 1980, Pl. 40.1  
# Tell Keisan 5 Briend & Humbert 1980, Pl. 40.2-5

#### **Iron III-Persian**

\* Tell Keisan II/III Seton-Williams 1980, Pl. 109.1

## **B.17.12 CLASS 145**

### **B.17.12.1 CLASS 145a**

#### **Iron I-II**

Sarepta Area X level VII Khalifeh 1988, Type X1, X4, X5

#### **Iron II**

Hazor V Yadin *et al.* 1961, Pl. 251.27  
Khalde Tomb 121 Saidah 1966, No. 19  
Ras al-Bassit Cem. Courbin 1993a, Fig. 16.5(C540)  
Tyre II Bikai 1978b, Pl. 9.4-6, 15-16  
Tyre III Bikai 1978b, Pl. 8  
Tyre III Bikai 1978b, Pl. 9.8, 11-12, 14, 17  
Tyre IV Bikai 1978b, Pl. 14, 17  
# Tyre IV Bikai 1978b, Pl. 15.9  
Tyre Al-Bass cem. II Núñez 2004a, Fig. 94.3  
Tyre Al-Bass cem. III Núñez 2004a, Fig. 52.2  
Tyre Al-Bass cem. III Núñez 2004a, Fig. 108.34-36

#### **Iron I-III**

Akhziv South Cem I Dayagi-Mendels 2002, Fig. 3.1(9)  
Akhziv South Cem VI Dayagi-Mendels 2002, 18(3-4)  
Akhziv South Cem VI Dayagi-Mendels 2002, Fig. 3.7(2)  
Akhziv East Cem XVII Culican 1982, Fig. 10i  
# Akhziv East Cem XVII Dayagi-Mendels 2002, Fig. 4.14(19)

#### **Iron II-III**

Akhziv TC2 E. Mazar 2001, Fig. 20b.7  
Akhziv Tomb N3 E. Mazar 2004, Fig. 1.8  
# Al Mina VIII du Plat Taylor 1959, Fig. 6.33, 37  
# Al Mina VIII Lehmann 1996, Pl. 6 (28/4+5)  
Beirut Bey 003 abandonment Badre 1997b, Fig. 37.3  
Beirut Bey 003 abandonment Badre 2000b, Fig. 6.1  
Sarepta Area X level VIII Khalifeh 1988, Type X1, X4, X5  
Sarepta Area Y level C Anderson 1988, Pl. 35.16-17  
# Sarepta Area Y level C Anderson 1988, Pl. 36.16  
Sarepta Area Y level C Anderson 1988, Pl. 36.18-23  
Tyre Al-Bass cem. IV Núñez 2004a, Fig. 50.2  
Tyre Al-Bass cem. IV Núñez 2004a, Fig. 75.2  
Tyre Al-Bass cem. IV Núñez 2004a, Fig. 103.2  
Tyre Al-Bass cem. Unstrat. Aubet 2004a, Fig. 8a

Tyre Al-Bass cem. Unstrat. Núñez 2004a, Fig. 117.P5  
Tyre Al-Bass cem. Unstrat. Núñez 2004a, Fig. 114.P3.2

### **Iron III**

Akhziv East Cem XXIV Dayagi-Mendels 2002, Fig. 4.18(3)  
# Al Mina V Woolley 1937, Pl. 11.2  
Al Mina V see Lehmann 1996, 387 (Form 148)  
# Al Mina VI/V Lehmann 1996, Pl. 7 (36/1)  
Megiddo II/III Lamon & Shipton 1939, Fig. 23.4  
Tyre Al-Bass cem. V Núñez 2004a, Fig. 65.18

### **Iron II-Persian**

Akhziv South Cem 72 E. Mazar 2001, Fig. 64.8-14

### **Persian**

Megiddo I Lamon & Shipton 1939, Fig. 23.4  
Sarepta Area Y level B Anderson 1988, Pl. 38.13  
Tell Keisan 3 Briend & Humbert 1980, Pl. 20.14

### **Unclear Context**

# Al Mina Unstrat. Lehmann 1996, Pl. 6 (30/1)  
Sarepta Area X unstrat. Pritchard 1988, Fig. 38.11-12

## **B.17.12.2 CLASS 145b**

### **Iron I-II**

Akhziv TC4 E. Mazar 2001, Fig. 7.6, 9

### **Iron II**

Akhziv South Cem 73 E. Mazar 2001, Fig. 43.2  
Khalde Tomb 3 Saidah 1966, No. 8  
Tell Rachidiah Tomb IV Doumet 1982, Pl. XVI.23, 72, 89  
Tyre II Bikai 1978b, Pl. 9.3, 18  
Tyre III Bikai 1978b, Pl. 8  
Tyre III Bikai 1978b, Pl. 9.13  
Tyre IV Bikai 1978b, Pl. 16.13  
Tyre Al-Bass cem. II Núñez 2004a, Fig. 81.4  
Tyre Al-Bass cem. II Núñez 2004a, Fig. 101.2  
Tyre Al-Bass cem. III Núñez 2004a, Fig. 54.3  
Tyre Al-Bass cem. III Núñez 2004a, Fig. 55.41-44  
Tyre Al-Bass cem. III Núñez 2004a, Fig. 56.2  
Tyre Al-Bass cem. III Núñez 2004a, Fig. 106.2, 5  
Tyre Al-Bass cem. III Núñez 2004a, Fig. 107.2

### **Iron I-III**

Akhziv South Cem I Dayagi-Mendels 2002, 6 (6)  
Akhziv South Cem I Dayagi-Mendels 2002, 10 (4)  
Akhziv South Cem I Dayagi-Mendels 2002, Fig. 3.1(5)  
Akhziv South Cem VI Dayagi-Mendels 2002, Fig. 3.7(1)  
Akhziv South Cem X Dayagi-Mendels 2002, Fig. 3.9(2-3)  
Akhziv South Cem XX Dayagi-Mendels 2002, Fig. 3.16(6)  
Akhziv East Cem XXXVI Dayagi-Mendels 2002, Fig.4.27(4)

### **Iron II-III**

Akhziv South Cem XVII Dayagi-Mendels 2002, 28 (1)  
Akhziv TC2 E. Mazar 2001, Fig. 20b.3-4  
# Al Mina VIII Lehmann 1996, Pl. 14 (77/1)  
# Beirut Bey 003 abandonment Badre 1997b, Fig. 36.8  
Sarepta Area Y level C Anderson 1988, Pl. 35.13-14  
Tyre I Bikai 1978b, Pl. 1.6  
Tyre Al-Bass cem. IV Núñez 2004a, Figs 62.4;71.2; 72.2; 73.2; 77.2; 78.2  
Tyre Al-Bass cem. IV Núñez 2004a, Fig. 75.5, 17, 19  
Tyre Al-Bass cem. IV/V Núñez 2004a, Fig. 61.7-8  
Tyre Al-Bass cem. Unstrat. Núñez 2004a, Fig. 112.P30, P51, P25.1, P19, P14.3  
Tyre Al-Bass cem. Unstrat. Núñez 2004a, Fig. 114.P14.1, P16

### **Iron III**

Akhziv East Cem XXIV Culican 1970, Fig. 2B.1  
Tell Keisan 5 Briend & Humbert 1980, Pl. 38.9-12  
Tell Keisan 5 Briend & Humbert 1980, Pl. 43.13  
Tyre Al-Bass cem. V Núñez 2004a, Fig. 57.11-15  
Tyre Al-Bass cem. V Núñez 2004a, Fig. 58.5, 8

#### **Iron II-Persian**

Akhziv South Cem III Dayagi-Mendels 2002, 13 (1)  
Akhziv South Cem 68 E. Mazar 2001, Fig. 52.6-7  
Akhziv South Cem 70 E. Mazar 2001, Fig. 62.1

### **B.17.13 CLASS 146**

#### **Unclear Context**

Jerablus Yunus cem. Woolley 1939b, Pl. 23.B18; Lehmann 1996 Pl. 8(43/1)

### **B.17.14 CLASS 147**

#### **Unclear Context**

Nayrab Unstrat. Abel & Barrois 1928, Pl. 541  
Tell Rifa'at Unstrat. Lehmann 1996, Pl. 8 (177/1)  
Zincirli Unstrat. Andrae 1943, Pl. 24n

### **B.17.15 CLASS 148**

#### **Iron II**

# Hazor V Yadin *et al.* 1958, Pl. 53.2  
# Hazor VII Yadin *et al.* 1958, Pl. 49.28  
# Hazor VII Yadin *et al.* 1960, Pl. 63.11, 32

#### **Iron II-III**

\* Deve Höyük Cem. I Moorey 1980, Fig. 2.7

#### **Iron III**

# Al Mina VI/V Lehmann 1996, Pl. 24 (149/1)  
# Al Mina VI/V Lehmann 1996, Pl. 24 (150/1)  
# Al Mina VII/VI Lehmann 1996, Pl. 6 (29/5)  
\* Hazor III Yadin *et al.* 1958, Pl. 77.21  
Ras al-Bassit Tell level 7 Courbin 1978, Pl. 18.15

#### **Iron III-Persian**

Kefrik Unstrat. Moorey 1980, Fig. 25.595

#### **Persian**

\* Athlit Tomb 24 Johns 1932, Fig. 77

#### **Unclear Context**

# Al Mina Unstrat. Lehmann 1996, Pl. 24 (151/1)  
Jerablus Yunus cem. Woolley 1939b, Pl. 23.B11-B12, B15  
Sarepta Area X unstrat. Pritchard 1988, Fig. 41.36

### **B.17.16 CLASS 149**

#### **Iron I**

Tille Höyük I-III Blaylock 1999, Fig. 2.1, 3

#### **Iron II**

\*\* Tell Afis Area D level 4 Mazzoni 1988a, Fig. 7.1  
Tell Afis Area Gn level 5 Cecchini 1998, Fig. 38.4  
Tille Höyük VIII Blaylock 1999, Fig. 5.3-8, 14-17, 19, 21

#### **Iron III**

# Tell Afis Area D level 2 Mazzoni 1988a, Fig. 9.23;  
# Tell Afis Area D level 2 Oggiano 1997, Pl. V.10  
Tell Afis Area Gc level 2 Cecchini 1998, Fig. 35.11

Tell Ahmar Area C level 2 Jamieson 1999, Fig. 1.14-15  
Tell Ahmar Area C level 2 Jamieson 2000, Fig. 2.23-31  
Tell Ahmar Area C level 2 Jamieson 2005, Fig. 4.25.18-20

**Iron III-Persian**

Tell Judeideh II/III see Lehmann 1996, 381 (Form 116)

**Persian**

Beirut Bey 010 Persian Sapin & Sayegh 1998, 103 Fig. 22.29-30

Tille Höyük X Blaylock 1999, Fig. 13.9, 14

**Unclear Context**

Jerablus Yunus cem. Woolley 1939b, Pl. 23.B7-B8

## **B.17.17 CLASS 150**

**Iron II**

# Megiddo Area H level 3 (IVA) Unpublished

Tel Dan III Biran 1999, Fig. 11.1

Tell Jurn Kabir Findgroup B Eidem and Ackermann 1999, Fig. 6.6

**Iron III**

# Ras al-Bassit Findgroup F Braemer 1986, Fig. 6.31

# Ras al-Bassit Findgroup G Braemer 1986, Fig. 7.38

# Tell Keisan 5 Briend & Humbert 1980, Pl. 38.8

## **B.17.18 CLASS 151**

**Iron I**

Sarepta Area X level V Khalifeh 1988, Type X9

Sarepta Area X level V Khalifeh 1988, Type X21

Sarepta Area X level VI Khalifeh 1988, Type X9

**Iron I-II**

Sarepta Area X level VII Khalifeh 1988, Type X9

Tell el Ghassil Area I level 4 Baramki 1964, Fig. 6.3

**Iron II**

Akhziv East Cem XXVI Dayagi-Mendels 2002, 73 (1)

\* Tell Rachidiah Tomb IV Doumet 1982, Pl. XVI.31

Tyre II Bikai 1978b, Pl. 9.2

**Iron I-III**

Akhziv South Cem I Dayagi-Mendels 2002, Fig. 3.3(1)

Akhziv South Cem X Dayagi-Mendels 2002, Fig. 3.9(4)

**Iron II-III**

Akhziv TC2 E. Mazar 2001, Figs 20b.5, 16

# Al Mina VIII du Plat Taylor 1959, Fig. 6.39

# Beirut Bey 003 storage room Badre 1997b, Fig. 45.1-3

Ras Ibn Hani Iron II/III Lagarce 1983, Pl. 61.1.3

Sarepta Area X level VIII Khalifeh 1988, Type X9

Tyre I Bikai 1978b, Pl. 1.7-11

**Iron III**

# Al Mina VII/VI du Plat Taylor 1959, Fig. 6.28

Tell Keisan 5 Briend & Humbert 1980, Pl. 38.1-7

Tyre Al-Bass cem. V Núñez 2004a, Fig. 105.2

**Iron II-Persian**

Akhziv East Cem VIII Dayagi-Mendels 2002, Fig. 4.6(2)

Akhziv South Cem 68 E. Mazar 2001, Fig. 52.5, 8

Akhziv South Cem 72 E. Mazar 2001, Fig. 64.15

**Iron III-Persian**

# Al Mina V/IV du Plat Taylor 1959, Fig. 6.25

**Persian**

Sarepta Area Y level B Anderson 1988, Pl. 38.20

# Sarepta Area Y level B Anderson 1988, Pl. 38.19

Tell Abu Hawam II Hamilton 1935, 15, Nos 7-8  
**Unclear Context**  
# Al Mina Unstrat. du Plat Taylor 1959, Fig. 6.30  
Byblos Unstrat. Dunand 1950, No. 12.063  
Sarepta Area X unstrat. Pritchard 1988, Fig. 38.13-14

## **B.17.19 CLASS 152**

### **Iron I**

Hama Cem. I Riis 1948, Fig. 91  
Hama F2 Riis & Buhl 1990, 130 (Form XXVIII B1)  
Hazor IX Yadin *et al.* 1960, Pl. 52.1  
# Hazor IX Yadin *et al.* 1961, Pl. 208.27  
# Hazor IX/X Yadin *et al.* 1958, Pl. 45.14  
Hazor IX/X Yadin *et al.* 1961, Pl. 177.1  
# Hazor IX/X Unpublished  
Hazor IX/X Unpublished  
Hazor X Yadin *et al.* 1961, Pl. 174.3  
# Hazor Iron I Ben Ami 2001, Fig. 5.1  
Khalde Tomb 167 Saidah 1966, No. 60  
# Megiddo VB Lamon & Shipton 1939, Figs 28.97-98, 102; 30.118, 120, 126-127, 132  
Megiddo VB Lamon & Shipton 1939, Fig. 28.99  
# Megiddo VB Loud 1948, Fig. 87.21  
# Megiddo Area K level 3 (VB) Finkelstein *et al.* 2000b, Fig. 11.18(2, 5-6)  
Megiddo VIA Harrison 2004b, Pl. 5.3  
# Pella Iron I Unpublished  
Pella Iron I Unpublished  
Sarepta Area Y level F Anderson 1988, Pl. 29.30  
# Tel Beth Shan V lower James 1966, Fig. 59.7, 10-11, 14  
Tell Qarqur 9 Unpublished  
\* Tell Rifa'at 3 Seton Williams 1961, Pl. 38.6

### **Iron I-II**

Akhziv TC4 E. Mazar 2001, Fig. 7.15  
# Megiddo VA-IVB Lamon & Shipton 1939, Figs 28.97-98; 30.120, 126-127  
Megiddo VA-IVB Lamon & Shipton 1939, Fig. 28.99  
# Megiddo VA-IVB Lamon & Shipton 1939, Fig. 28.106  
# Megiddo VA-IVB Lamon & Shipton 1939, Fig. 30.118, 132  
# Megiddo VA-IVB Loud 1948, Fig. 89.10  
Megiddo Area K level 2 (VA-IVB) Finkelstein *et al.* 2000b, Fig. 11.20(1)  
Megiddo Tombs Guy 1938, Pl. 75.7  
Pella Area III level O McNicoll *et al.* 1992, Pl. 67.13  
\* Tel Beth Shan V James 1966, Figs 3.5; 5.12; 22.13  
# Tel Beth Shan V James 1966, Figs 3.5; 6.1, 5; 18.1; 19.1, 20.5, 22.4-5; 23.5  
Tel Dan IV Biran 1982, Fig. 24.3-6  
# Tel Dan IV Biran 1982, Fig. 24.8-13  
Tell Mishrife Operation K levels 8-4 Luciani 2002, Fig. 134.5

### **Iron II**

Hama E Riis & Buhl 1990, Fig. 72 (511)  
Hama E1 Riis & Buhl 1990, 130 (Form XXVIII B1)  
Hama E2 Riis & Buhl 1990, 130 (Form XXVIII B1)  
# Hazor IV Yadin *et al.* 1958, Pl. 58.1  
# Hazor IV Yadin *et al.* 1960, Pl. 98.1, 3-6  
# Hazor IV Yadin *et al.* 1961, Pl. 254.1-2  
Hazor IV/V Yadin *et al.* 1958, Pl. 71.1  
# Hazor V Yadin *et al.* 1958, Pl. 53.4  
Hazor V Yadin *et al.* 1958, Pl. 53.9  
# Hazor V Yadin *et al.* 1958, Pl. 54.8  
Hazor V Yadin *et al.* 1958, Pl. 74.17  
# Hazor V Yadin *et al.* 1960, Pl. 79.1-2

Hazor V Yadin *et al.* 1960, Pl. 80.1-3, 15-16, 21, 23  
 # Hazor V Yadin *et al.* 1960, Pl. 80.4, 6-14, 17, 24  
 # Hazor V Yadin *et al.* 1960, Pl. 92.7  
 # Hazor V Yadin *et al.* 1961, Pl. 189.1  
 # Hazor V Yadin *et al.* 1961, Pl. 222.17, 21-22  
 # Hazor V Yadin *et al.* 1961, Pl. 223.1  
 Hazor V Yadin *et al.* 1961, Pl. 225.2  
 # Hazor V Yadin *et al.* 1961, Pl. 225.3-10  
 # Hazor V Ben Tor *et al.* 1997, Fig. III.45 (4)  
 Hazor V Ben Tor *et al.* 1997, Fig. III.47 (1)  
 # Hazor V Ben Tor *et al.* 1997, Fig. III.47 (2, 4)  
 # Hazor VI Yadin *et al.* 1958, Pl. 51.1  
 Hazor VI Yadin *et al.* 1960, Pl. 66.4-5  
 # Hazor VI Yadin *et al.* 1960, Pl. 66.6, 12  
 # Hazor VI Yadin *et al.* 1961, Pl. 181.1-2, 4-5  
 Hazor VI Yadin *et al.* 1961, Pl. 181.3, 11  
 # Hazor VI Yadin *et al.* 1961, Pl. 214.12  
 # Hazor VI Yadin *et al.* 1961, Pl. 219.1  
 # Hazor VI Yadin *et al.* 1961, Pl. 220.12  
 Hazor VI Yadin *et al.* 1961, Pl. 249.1  
 # Hazor VI Yadin *et al.* 1961, Pl. 249.2  
 # Hazor VI Ben Tor *et al.* 1997, Fig. II.54 (6)  
 # Hazor VI Ben Tor *et al.* 1997, Fig. III.38 (2)  
 Hazor VI Ben Tor *et al.* 1997, Fig. III.41 (2)  
 # Hazor VII Yadin *et al.* 1958, Pl. 49.24  
 Hazor VII Yadin *et al.* 1960, Pl. 63.1  
 # Hazor VII Yadin *et al.* 1960, Pl. 63.2, 29  
 Hazor VII Ben Tor *et al.* 1997, Fig. III.30 (1)  
 # Hazor VII Ben Tor *et al.* 1997, Fig. III.32 (6)  
 # Hazor VII Ben Tor *et al.* 1997, Fig. III.33 (16)  
 # Hazor VIII Yadin *et al.* 1958, Pl. 47.1, 15-16  
 Hazor VIII Yadin *et al.* 1960, Pl. 53.1, 7-11  
 # Hazor VIII Yadin *et al.* 1960, Pl. 53.19  
 \*\* Hazor VIII Yadin *et al.* 1960, Pl. 53.20  
 # Hazor VIII Yadin *et al.* 1960, Pl. 55.13, 16  
 Hazor VIII Ben Tor *et al.* 1997, Fig. III.24 (7)  
 # Hazor VIII Ben Tor *et al.* 1997, Fig. III.24 (11)  
 # Megiddo IVA Lamon & Shipton 1939, Fig. 24.48  
 Megiddo IVA Lamon & Shipton 1939, Fig. 28.99  
 # Megiddo Area H level 3 (IVA) Finkelstein *et al.* 2000b, Fig. 11.52(1)  
 Pella Area VIII level 6 McNicoll *et al.* 1992, Pl. 66.13  
 Pella Iron II Unpublished  
 # Pella Iron II Unpublished  
 Sidon Iron II Doumet-Serhal 2006, Fig. 31.35  
 # Tel Beth Shan IV James 1966, Fig. 35.5  
 # Tel Beth Shan IV James 1966, Fig. 37.1  
 Tel Beth Shan IV James 1966, Fig. 67.5  
 # Tel Beth Shan V upper James 1966, Fig. 45.3  
 # Tel Beth Shan V upper James 1966, Fig. 63.7-8  
 Tel Beth Shan V upper James 1966, Fig. 63.10  
 # Tel Beth Shan V upper James 1966, Fig. 63.11-12  
 # Tel Beth Shan Area P level 7 A. Mazar 2001, Fig. 12.4  
 Tel Dan II Pakman 1992, Fig. 1.2  
 Tel Dan III Biran 1996b, Fig. 7.4  
 # Tel Dan III Biran 1996b, Fig. 7.5-6  
 # Tel Dan III Biran 1999, Fig. 4.3  
 \* Tel Dan III Biran 1999, Fig. 11.3  
 Tel Dan III Biran 1999, Fig. 11.4  
 # Tel Jezreel Findgroup A Zimhoni 1997a, Figs 1.6 (1); 1.7 (1-2)  
 \* Tel Jezreel Findgroup A Zimhoni 1997a, Fig. 1.7 (5)

# Tel Jezreel Findgroup A Zimhoni 1997b, Fig. 2.5 (2)  
 # Tel Jezreel Findgroup C Zimhoni 1997a, Fig. 1.8 (3)  
 # Tel Jezreel Findgroup D Zimhoni 1997a, Figs 1.2 (12-15); 1.3 (9-10)  
 Tel Jezreel Findgroup D Zimhoni 1997a, Fig. 1.3 (8)  
 # Tel Jezreel Findgroup F Zimhoni 1997b, Fig. 2.12 (2)  
 # Tel Jezreel Iron II Zimhoni 1997b, Fig. 2.3 (10, 13)  
 Tell Afis Area D level 4 Mazzoni 1988a, Fig. 15.20  
 # Tell Arqa 10 Thalmann 1983, Fig. 1.4, 6  
 # Tell Arqa 10AB Thalmann 1978a, Fig. 6.4, 6  
 # Tell Arqa 10AB Thalmann 1978b, Fig. 46.2  
 Tell el Ghassil Area III level 2 Joukowsky 1972, Pl. 17.57  
 \*\* Tell Keisan 6 Briend & Humbert 1980, Pl. 49.2  
 # Tell Mastuma Central Area level I-1 Wakita *et al.* 1995, Fig. 7.4  
 Tell Tayinat Building phase 1 Swift 1958, Fig. 37  
 # Tyre IV Bikai 1978b, Pl. 15.18

#### **Iron I-III**

# Akhziv East Cem XXXVI Dayagi-Mendels 2002, Fig. 4.27(9)

#### **Iron II-III**

# Ras Ibn Hani Iron II/III Bounni *et al.* 1976a, Fig. 27.11  
 Tell Shiyuk Fawqani Area F (IX) Makinson 2005, Pl. 4.18

#### **Iron III**

# Al Mina VII/VI du Plat Taylor 1959, Fig. 6.29  
 Al Mina VII/VI Lehmann 1996, Pl. 20 (115/1)  
 # Hazor III Yadin *et al.* 1958, Pl. 76.14  
 # Hazor III Yadin *et al.* 1958, Pl. 77.19  
 # Megiddo II/III Lamon & Shipton 1939, Fig. 24.28  
 # Tell Abou Danne IIc/A5 Lebeau 1983, Pl. 102.4  
 # Tell Abou Danne IIc/A5 Lebeau 1983, Pl. 103.5  
 # Tell Afis Area Gc level 7b Cecchini 1998, Fig. 20.15, 17  
 Tell Ahmar Area C level 2 Jamieson 1999, Fig. 1.2  
 Tell Ahmar Area C level 2 Jamieson 2000, Fig. 2.1-4  
 Tell Ahmar Area C level 2 Jamieson 2005, Fig. 4.1.8-11  
 Tell Ahmar Area D Iron III Jamieson 2005, Fig. 2.1-2  
 # Tell Arqa 9 Thalmann 1978b, Fig. 46.1  
 Tell Jurn Kabir Findgroup C Eidem and Ackermann 1999, Fig. 8.9  
 # Tell Keisan 4 Briend & Humbert 1980, Pl. 29.1  
 # Tell Keisan 4 Briend & Humbert 1980, Pl. 30.1a, 2

#### **Persian**

# Megiddo I Lamon & Shipton 1939, Fig. 24.28

#### **Unclear Context**

Athlit Cremation cem. Johns 1938, Fig. 9.1  
 Athlit Cremation cem. Johns 1938, Figs 11.5; 12.4  
 Tell Rifa'at Unstrat. see Lehmann 1996, 380 (Form 109)

## **B.17.20 CLASS 153**

#### **Iron I**

Hama F Fugmann 1958, Fig. 165 (4B939)  
 Hama F2 Riis & Buhl 1990, Fig. 78 (591)  
 Hazor IX Yadin *et al.* 1961, Pl. 212.1-2  
 # Hazor IX/X Yadin *et al.* 1961, Pl. 177.5  
 Hazor IX/X Unpublished  
 Sarepta Area Y level E Anderson 1988, Pl. 31.16  
 Tell Keisan 9c Briend & Humbert 1980, Pl. 80.3

#### **Iron I-II**

Tyre X Bikai 1978b, Pl. 23.1

#### **Iron II**

Hama Cem. III Riis 1948, Fig. 114  
 # Hazor VI Yadin *et al.* 1961, Pl. 181.21

# Hazor VI Yadin *et al.* 1961, Pl. 219.3  
# Hazor VIII Yadin *et al.* 1960, Pl. 53.30-31  
Joya S. V. Chapman 1972, Fig. 24.250  
# Sidon Iron II Doumet-Serhal 2004g, Pl. 14.5-6  
# Sidon Iron II Doumet-Serhal 2006, Fig. 25.5-6  
# Tel Beth Shan IV James 1966, Fig. 67.3  
# Tell Arqa 10 Unpublished  
# Tell Arqa 10AB Thalmann 1978b, Fig. 46.5  
Tell Judeideh IV see Lehmann 1996, 374 (Form 81)  
Tell Keisan 7 Briend & Humbert 1980, Pl. 52.8  
Tell Keisan 8 Briend & Humbert 1980, Pl. 55.9  
Tyre IV Bikai 1978b, Pl. 16.3

#### **Iron III**

# Al Mina VII/VI du Plat Taylor 1959, Fig. 6.16  
# Tell Keisan 4 Briend & Humbert 1980, Pl. 29.2  
# Tell Keisan 4 Briend & Humbert 1980, Pl. 30.6  
# Tell Keisan 4 Briend & Humbert 1980, Pl. 35.8  
Tell Shiyuk Fawqani Area G level 2 Luciani 2005, Pl. 4.36

#### **Unclear Context**

Sarepta Area X unstrat. Pritchard 1988, Fig. 39.27  
Tell Rifa'at 2-3 (Iron Age) Seton Williams 1961, Pl. 38.2

### **B.17.21 CLASS 154**

#### **Iron I**

\* Megiddo VIA Loud 1948, Fig. 78.6-7  
\* Megiddo Area F level 5 (VIA) Finkelstein *et al.* 2000b, Fig. 11.2(3)  
\* Megiddo VIB Loud 1948, Fig. 74.4  
Megiddo Area F level 6 burial Finkelstein *et al.* 2000b, Fig. 11.1(1)  
Pella Area VIII level 8 McNicoll *et al.* 1992, Pl. 64.3  
Tell Keisan 9a/b Briend & Humbert 1980, Pl. 66.9

#### **Iron II**

Hazor V Yadin *et al.* 1961, Pl. 230.4  
Joya S. V. Chapman 1972, Fig. 24.249  
Pella Area VIII level 6 McNicoll *et al.* 1992, Pl. 66.9

#### **Iron I-III**

#\* Akhziv South Cem I Dayagi-Mendels 2002, Fig. 3.2(8)

#### **Iron II-III**

\* Tyre Al-Bass cem. IV Núñez 2004a, Fig. 60.6

#### **Iron III**

Sarepta Tomb 26 Culican 1970, Fig. 3.2

#### **Persian**

Tell Keisan 3 Briend & Humbert 1980, Pl. 20.4

### **B.17.22 CLASS 155**

#### **Iron I**

Hama Cem. II Riis 1948, Fig. 95  
# Hazor IX Yadin *et al.* 1961, Pl. 178.1, 26-28  
Hazor IX Yadin *et al.* 1961, Pl. 178.29  
# Hazor IX Yadin *et al.* 1961, Pl. 208.24-26  
# Hazor IX Yadin *et al.* 1961, Pl. 212.7  
# Hazor IX/X Yadin *et al.* 1958, Pl. 45.1  
# Megiddo VB Lamon & Shipton 1939, Fig. 28.93a  
# Megiddo Area K level 3 (VB) Finkelstein *et al.* 2000b, Fig. 11.18(3)  
Sarepta Area X level VI Khalifeh 1988, Type F1

#### **Iron I-II**

# Akhziv TC4 E. Mazar 2001, Fig. 7.22-23



Akhziv Tomb N1 E. Mazar 2004, Fig. 1.14  
# Akhziv Tomb N1 E. Mazar 2004, Fig. 1.15  
# Megiddo VA-IVB Lamon & Shipton 1939, Fig. 28.93a  
# Megiddo Tombs Guy 1938, Pl. 75.8-9  
Sarepta Area X level VII Khalifeh 1988, Type F1  
\* Tyre X Bikai 1978b, Pl. 28.6

#### **Iron II**

# Akhziv South Cem 73 E. Mazar 2001, Fig. 43.4  
Al Mina IX see Lehmann 1996, 373 (Form 78b)  
Hama Cem. III Riis 1948, Fig. 95  
# Hazor V Yadin *et al.* 1958, Pl. 54.6  
# Hazor V Yadin *et al.* 1958, Pl. 54.7  
# Hazor V Yadin *et al.* 1960, Pl. 92.5-6  
# Hazor V Yadin *et al.* 1961, Pl. 230.12  
# Hazor VII Yadin *et al.* 1958, Pl. 49.23  
Hazor VIII Yadin *et al.* 1960, Pl. 55.1  
# Hazor VIII Yadin *et al.* 1960, Pl. 55.2-3, 12  
# Khalde Tomb 121 Saidah 1966, No. 28  
# Megiddo Area H level 3 (IVA) Finkelstein *et al.* 2000b, Fig. 11.43(3)  
# Ras al-Bassit Findgroup B Braemer 1986, Fig. 2.4  
# Ras al-Bassit Findgroup C Braemer 1986, Fig. 3.7  
# Tel Beth Shan IV James 1966, Fig. 67.1  
Tel Beth Shan IV James 1966, Fig. 67.13  
# Tel Beth Shan Area P level 7 A. Mazar 2001, Fig. 12.4  
# Tel Rehov Area C/E level 1 A. Mazar 1999a, Fig. 24.1  
# Tell Afis Area E2 level 1 Degli Esposti 1998, Fig. 10.3  
Tell Afis Area L level 4 D'Amore 1998a, Fig. 6.2  
Tell Sheikh Hassan 3 Schneider 1999a, Fig. 7.11(1)  
# Tyre II Bikai 1978b, Pl. 11.1, 4, 6  
Tyre II Bikai 1978b, Pl. 11.3, 9, 11  
# Tyre II Bikai 1978b, Pl. 11.15-16  
# Tyre III Bikai 1978b, Pl. 11.2, 5, 7-8  
Tyre III Bikai 1978b, Pl. 11.10  
# Tyre III Bikai 1978b, Pl. 11.12-14  
# Tyre IV Bikai 1978b, Pl. 15.1, 4, 10-11  
# Tyre IV Bikai 1978b, Pl. 15.7  
Tyre IV Bikai 1978b, Pl. 16.4  
# Tyre VIII Bikai 1978b, Pl. 19.3, 6  
# Tyre Al-Bass cem. II Núñez 2004a, Fig. 68.4  
# Tyre Al-Bass cem. III Núñez 2004a, Fig. 52.5

#### **Iron I-III**

# Akhziv South Cem XI Dayagi-Mendels 2002, 23 (8)  
Akhziv South Cem XX Dayagi-Mendels 2002, Fig. 3.16(9)  
# Akhziv East Cem XXXVI Dayagi-Mendels 2002, Fig. 4.27(6)  
#\* Akhziv Tomb N2 E. Mazar 2004, Fig. 1.16  
# Akhziv Tomb N2 E. Mazar 2004, Fig. 1.17-18

#### **Iron II-III**

# Akhziv South Cem XVII Dayagi-Mendels 2002, 28 (2)  
# Akhziv South Cem XVIII Dayagi-Mendels 2002, 28 (4)  
# Akhziv East Cem XXIX Culican 1975-1976, Fig. A.h, q  
# Akhziv East Cem XXIX Dayagi-Mendels 2002, Fig. 4.21(10)  
Akhziv East Cem XXIX Dayagi-Mendels 2002, Fig. 4.21(11)  
# Akhziv Tomb N3 E. Mazar 2004, Fig. 1.19  
# Al Mina VIII du Plat Taylor 1959, Fig. 6.2a  
Sarepta Area X level VIII Khalifeh 1988, Type F1  
# Sarepta Area Y level C Anderson 1988, Pl. 38.3  
# Sarepta Area Y level C Anderson 1988, Pl. 38.4  
# Tyre I Bikai 1978b, Pl. 1.1  
# Tyre I Bikai 1978b, Pl. 1.2  
#\* Tyre Al-Bass cem. IV Núñez 2004a, Fig. 80.4

- # Tyre Al-Bass cem. IV/V Núñez 2004a, Fig. 61.5
- # Tyre Al-Bass cem. Unstrat. Núñez 2004a, Fig. 111.P13.2
- # Tyre Al-Bass cem. Unstrat. Núñez 2004a, Fig. 115.P22.1

#### **Iron III**

- Megiddo II/III Lamon & Shipton 1939, Fig. 24.56
- \* Megiddo II/III Lamon & Shipton 1939, Fig. 25.57
- # Ras al-Bassit Findgroup D Braemer 1986, Fig. 4.15
- # Ras al-Bassit Findgroup D Braemer 1986, Fig. 4.16
- Tell Afis Area D level 1 Mazzoni 1988a, Fig. 8.3
- Tell Ahmar Area D Iron III Jamieson 2005, Figs 45.7; 51.2
- # Tyre Al-Bass cem. V Núñez 2004a, Fig. 58.3

#### **Iron II-Persian**

- # Akhziv South Cem 68 E. Mazar 2001, Fig. 52.14
- # Akhziv South Cem 72 E. Mazar 2001, Fig. 64.18

#### **Persian**

- # Tell Keisan 3 Briend & Humbert 1980, Pl. 20.12

#### **Unclear Context**

- # Al Mina Unstrat. du Plat Taylor 1959, Fig. 6.1-3
- Byblos Unstrat. Dunand 1950, No. 9.609
- Tell Abu Hawam III Hamilton 1935, 21, No. 69
- # Tell Abu Hawam III Hamilton 1935, Fig. 9
- # Tell Abu Hawam III Hamilton 1935, Pl. 13.68
- Tell Mishrife Unstrat. du Mesnil du Buisson 1927, Pl. 79.47

### **B.17.23 CLASS 156**

#### **Iron I-II**

- Tel Beth Shan V James 1966, Fig. 22.12

#### **Iron II**

- # Akhziv East Cem XXVI Dayagi-Mendels 2002, Fig. 4.19(2)
- # Hazor V Yadin *et al.* 1958, Pl. 67.24
- # Khalde Tomb 3 Saidah 1966, No. 10

#### **Iron I-III**

- # Akhziv East Cem XVII Culican 1982, Fig. 10c

#### **Iron III**

- # Tell Keisan 5 Briend & Humbert 1980, Pl. 40.12a

#### **Persian**

- # Sarepta Area Y level B Anderson 1988, Pl. 38.16

#### **Unclear Context**

- Athlit Cremation cem. Johns 1938, Fig. 6.2
- # Athlit Cremation cem. Johns 1938, Fig. 10.2
- Athlit Cremation cem. Johns 1938, Fig. 13.3
- Jerablus Yunus cem. Woolley 1939b, Pl. 23.B4, B20

### **B.17.24 CLASS 157**

#### **Iron I**

- Hama Cem. I Riis 1948, Fig. 98
- # Hazor IX/X Unpublished
- # Hazor X Yadin *et al.* 1960, Pl. 51.3
- Hazor X Yadin *et al.* 1961, Pl. 171.2
- \* Khalde Cem. IV Saidah 1966, No. 42
- Megiddo VB Lamon & Shipton 1939, Fig. 30.134
- Megiddo VB Lamon & Shipton 1939, Fig. 31.143
- Megiddo Tombs Guy 1938, Pl. 68.1, 14
- \* Tel Beth Shan V lower James 1966, Fig. 59.2
- \* Tel Beth Shan VI James 1966, Fig. 49.9
- Tel Beth Shan VI James 1966, Fig. 52.14

# Tel Beth Shan VI James 1966, Fig. 58.5  
 Tell Abu Hawam IV Hamilton 1935, 29, No. 154  
 Tell Kazel Area II level 5 Capet 2003, Fig. 34.e  
 Tell Mishrife Iron I Unpublished  
**Iron I-II**  
 Akhziv TC4 E. Mazar 2001, Fig. 7.24  
 Byblos Necropolis K Salles 1980, Pl. 19.2, 12  
 # Megiddo VA-IVB Lamon & Shipton 1939, Fig. 28.93b  
 \* Megiddo VA-IVB Lamon & Shipton 1939, Fig. 31.143  
 # Megiddo VA-IVB Loud 1948, Fig. 89.11  
 \* Megiddo VA-IVB Loud 1948, Fig. 90.4  
 Tel Beth Shan V James 1966, Fig. 2.8  
 Tel Beth Shan Northern cem. Oren 1973, Fig. 47a.1  
 # Tel Dan IV Biran 1982, Fig. 24.18  
 # Tell Kazel Area I level 14 Badre & Gubel 1999-2000, Fig. 6.j  
**Iron II**  
 # Ain Dara Lower Mound Iron II Stone & Zimansky 1999, Fig. 74.5  
 Hama Cem. IV Riis 1948, Fig. 94  
 Hama Cem. IV Riis 1948, Fig. 99  
 Hama E Fugmann 1958, Fig. 305 (5B30)  
 Hama E Fugmann 1958, Fig. 310 (7B22)  
 Hama E1 Fugmann 1958, Fig. 188 (5B412)  
 Hama E1 Riis & Buhl 1990, 130 (Form XXVIII A2)  
 Hama E1 Riis & Buhl 1990, 130 (Form XXVIII B4)  
 Hama E1 Riis & Buhl 1990, 130 (Forms XXVIII C4 & C5)  
 Hama E2 Riis & Buhl 1990, 130 (Form XXVIII A2)  
 Hazor V Yadin *et al.* 1958, Pl. 74.13  
 # Hazor V Yadin *et al.* 1960, Pl. 80.30  
 # Hazor V Yadin *et al.* 1960, Pl. 92.9  
 \*\* Hazor V Yadin *et al.* 1961, Pl. 223.19  
 # Hazor V Yadin *et al.* 1961, Pl. 251.3-4  
 # Hazor VI Yadin *et al.* 1960, Pl. 67.3  
 # Hazor VI Yadin *et al.* 1961, Pl. 181.17-19  
 # Hazor VI Ben Tor *et al.* 1997, Fig. II.54 (18)  
 # Hazor VII Yadin *et al.* 1958, Pl. 49.9  
 # Hazor VII Yadin *et al.* 1960, Pl. 63.8, 26, 31  
 # Hazor VII Yadin *et al.* 1961, Pl. 214.18  
 # Hazor VIII Yadin *et al.* 1960, Pl. 53.21  
 # Khalde Tomb 121 Saidah 1966, No. 27  
 # Megiddo IVA Lamon & Shipton 1939, Figs 24.54; 25.59  
 # Sarepta Area Y level D Anderson 1988, Pl. 33.19  
 # Sarepta Area Y level D Anderson 1988, Pl. 33.27  
 # Tel Beth Shan IV James 1966, Fig. 38.3  
 # Tel Beth Shan IV James 1966, Fig. 67.24  
 # Tel Beth Shan V upper James 1966, Fig. 63.1  
 Tel Dan II Biran 1999, Fig. 7.5  
 Tell Afis Area J (Afis VIII) del Vesco *et al.* 2005, Fig. 57.1-2  
 # Tell Arqa 10 Unpublished  
 # Tell Arqa 10AB Chaaya 2000, Fig. 2.2  
 # Tell Arqa Tomb 1 Thalmann 1978b, Fig. 45.8  
 Tell el Ghassil Area I level 2 Baramki 1961, Fig. 3.2  
 Tell el Ghassil Area I level 2 Baramki 1964, Fig. 28.1  
 Tell el Ghassil Area I level 3 Baramki 1961, Fig. 3.2  
 Tell el Ghassil Area III level 2 Joukowsky 1972, Pl. 17.52  
 # Tell Kazel Area II level 4 Badre *et al.* 1994, Fig. 28.b  
 Tell Mishrife Iron II Unpublished  
 # Tell Nebi Mend Trench V Level C Unpublished  
 Tell Shiyuk Fawqani Area H Al-Bahloul *et al.* 2005, Pl. 9h  
 Tille Höyük IV-V Blaylock 1999, Fig. 4.2-3  
 # Tyre III Bikai 1978b, Pl. 10.22

# Tyre IX Bikai 1978b, Pl. 19.4-5

#### **Iron II-III**

\* Tyre Al-Bass cem. IV Núñez 2004a, Fig. 64.3

# Tyre Al-Bass cem. IV Núñez 2004a, Fig. 73.4

# Tyre Al-Bass cem. IV Núñez 2004a, Fig. 104.4

Tyre Al-Bass cem. Unstrat. Aubet 2004a, Fig. 8a

#### **Iron III**

Megiddo II/III Lamon & Shipton 1939, Fig. 24.50

# Megiddo II/III Lamon & Shipton 1939, Fig. 24.51, 53-54

# Megiddo II/III Lamon & Shipton 1939, Fig. 25.59

# Ras al-Bassit Findgroup E Braemer 1986, Fig. 5.23

# Tell Afis Area Gc level 4 Cecchini 1998, Fig. 31.15

# Tell Afis Area Gc level 7b Cecchini 1998, Fig. 20.20

Tell Ahmar Area C level 2 Jamieson 2000, Fig. 13.18-22

#### **Persian**

# Tell Abu Hawam II Hamilton 1935, 14, No. 1

Tell Shiyuk Fawqani Area G level 1 Luciani 2005, Pl. 35.429

#### **Unclear Context**

Jerablus Unstrat. Woolley 1921a, Pl. 20.c1

Sarepta Area X unstrat. Pritchard 1988, Fig. 38.1

Tell Mishrife Unstrat. du Mesnil du Buisson 1927, Pl. 69.17; 1935, Fig. 1.1

## **B.17.25 CLASS 158**

### **B.17.25.1 CLASS 158a**

#### **Iron I**

Hama Cem. II Riis 1948, Fig. 103

Hazor IX Yadin *et al.* 1961, Pl. 208.12

Megiddo VIA Loud 1948, Fig. 78.1, 10

Megiddo VIB Loud 1948, Fig. 74.1

Megiddo Tombs Guy 1938, Pls 68.5; 69.7; 70.9-10; 73.4, 11

\* Megiddo Tombs Guy 1938, Pl. 68.13

# Pella Iron I Unpublished

\* Pella Iron I Unpublished

Pella Iron I Unpublished

Sarepta Area Y level G Anderson 1988, Pl. 27.12

Tel Beth Shan V lower James 1966, Fig. 59.3, 6

Tel Beth Shan VI James 1966, Fig. 52.15

Tel Beth Shan VI James 1966, Figs 55.1; 57.1

Tel Beth Shan VI lower Yadin & Geva 1986, Fig. 22.3

# Tel Beth Shan VI lower Yadin & Geva 1986, Fig. 22.4

\* Tel Beth Shan VI lower Yadin & Geva 1986, Fig. 22.5

Tell Kazel Area II level 6 Badre *et al.* 1994, Fig. 48.d

Tell Kazel Area II level 6 Badre *et al.* 1994, Fig. 52.b-c

Tell Keisan 9a/b Briend & Humbert 1980, Pl. 66.7

Tell Keisan 9c Briend & Humbert 1980, Pl. 79.14a, c-e, g, j-k

Tell Sukas South Harbour Buhl 1996, Fig. 27.XIA, XIB

Tyre XI Bikai 1978b, Pl. 29.2

Tyre XII Bikai 1978b, Pl. 31.1, 2

#### **Iron I-II**

Akhziv TC4 E. Mazar 2001, Fig. 7.14

Byblos Necropolis K Salles 1980, Pl. 17.8-9, 11

Megiddo Tombs Guy 1938, Pl. 75.5

\* Tel Beth Shan V James 1966, Fig. 4.7

\* Tel Beth Shan V James 1966, Figs 6.4; 20.1

# Tel Beth Shan V James 1966, Fig. 21.3; 31.3

Tel Beth Shan V James 1966, Fig. 31.23

Tel Beth Shan Northern cem. Oren 1973, Figs 42a.1-4; 44a.1, 3-4

# Tell Kazel Area I level 14 Badre & Gubel 1999-2000, Fig. 6.i

#### **Iron II**

Hama Cem. IV Riis 1948, Fig. 103

Hama E1 Riis & Buhl 1990, 130 (Form XXXA3)

Hazor V Yadin *et al.* 1960, Pl. 80.18

# Hazor V Yadin *et al.* 1960, Pl. 80.19-20, 22

# Hazor V Yadin *et al.* 1961, Pl. 251.5-6

Hazor V Ben Tor *et al.* 1997, Fig. III.47 (3)

Hazor VI Yadin *et al.* 1961, Pl. 181.7

# Hazor VIII Yadin *et al.* 1960, Pl. 53.22

Joya S. V. Chapman 1972, Fig. 24.239

\* Tel Beth Shan IV James 1966, Fig. 39.5

\* Tel Beth Shan IV James 1966, Fig. 67.14

# Tel Jezreel Findgroup D Zimhoni 1997a, Figs 1.2 (7); 1.3 (3-5)

Tel Jezreel Iron II Zimhoni 1997b, Fig. 2.3 (1)

# Tel Jezreel Iron II Zimhoni 1997b, Fig. 2.3 (4)

# Tell Arqa 10 Thalmann 1983, Fig. 1.1

# Tell Arqa 10 Unpublished

# Tell Arqa 10AB Thalmann 1978a, Fig. 6.1

# Tell Arqa Tomb 1 Thalmann 1978b, Fig. 45.9

Tell el Ghassil Area I level 3 Joukowsky 1972, Pl. 5.1-2

Tell Kazel Area I level 13 Badre *et al.* 1994, Fig. 21

#### **Iron I-III**

Akhziv East Cem XXIX Dayagi-Mendels 2002, Fig. 4.21(5)

#### **Iron II-III**

Akhziv East Cem XXXVI Dayagi-Mendels 2002, Fig. 4.27(1)

#### **Iron III**

# Megiddo II/III Lamon & Shipton 1939, Fig. 24.44-45

### **B.17.25.2 CLASS 158b**

#### **Iron I**

Tel Beth Shan VI James 1966, Fig. 49.21

Tel Beth Shan VI James 1966, Figs 50.2; 51.10; 53.23; 55.2; 56.17

Tel Beth Shan VI lower Yadin & Geva 1986, Fig. 35.2

Tell Keisan 9c Briand & Humbert 1980, Pl. 73.10

#### **Iron I-II**

Tel Beth Shan V James 1966, Fig. 31.21

### **B.17.26 CLASS 159**

#### **Iron I**

Hama Cem. II Riis 1948, Fig. 118

\*\* Megiddo VIB Loud 1948, Fig. 74.10

Sarepta Area Y level E Anderson 1988, Pl. 31.18

Tell el Ghassil Area I level 5 Joukowsky 1972, Pl. 12.27

#### **Iron I-II**

Tell el Ghassil Area I level 4 Joukowsky 1972, Pl. 8.24

#### **Iron II**

# Tell el Ghassil Area I level 2 Joukowsky 1972, Pl. 2.8

Tell el Ghassil Area III level 3 Joukowsky 1972, Pl. 24.13

Tell el Ghassil Iron II Baramki 1961, Fig. 8.2

Tille Höyük IV-V Blaylock 1999, Fig. 4.14-16

#### **Iron III**

# Megiddo II/III Lamon & Shipton 1939, Fig. 25.65

#### **Persian**

Hazor II Yadin *et al.* 1958, Pl. 81.8

#### **Unclear Context**

Sarepta Area X unstrat. Pritchard 1988, Fig. 39.26

## B.17.27 CLASS 160

### B.17.27.1 CLASS 160a

#### Iron I

- Hama Cem. I Riis 1948, Fig. 97  
Hama Cem. II Riis 1948, Fig. 93  
Hama Cem. II Riis 1948, Fig. 97  
# Hazor IX Yadin *et al.* 1961, Pl. 175.7  
Hazor IX Yadin *et al.* 1961, Pl. 208.3, 11  
# Hazor IX/X Yadin *et al.* 1961, Pl. 164.4  
# Hazor IX/X Yadin *et al.* 1961, Pl. 177.4  
# Hazor IX/X Unpublished  
# Megiddo VB Lamon & Shipton 1939, Fig. 28.105  
Megiddo VIA Loud 1948, Fig. 78.2  
\*\* Megiddo VIA Loud 1948, Fig. 79.4  
Megiddo VIA Harrison 2004b, Pl. 5.1  
Megiddo Area F level 5 (VIA) Finkelstein *et al.* 2000b, Fig. 11.2(1)  
\* Megiddo VIB Loud 1948, Fig. 74.2  
Megiddo Tombs Guy 1938, Pl. 72.10-11  
Pella Area III level I McNicoll *et al.* 1992, Pl. 51.9  
Sarepta Area X level VI Khalifeh 1988, Type F2  
Tel Beth Shan V lower James 1966, Fig. 59.4  
# Tel Beth Shan VI James 1966, Fig. 57.2  
Tel Beth Shan VI lower Yadin & Geva 1986, Fig. 22.2  
Tel Dan V Biran 1989b, Fig. 18.1  
Tel Dan VI Biran 1989a, Fig. 4.18.1  
Tell Afis Area E1 level 7 Mazzoni 1998a, Fig. 17.1  
Tell Afis Area E1 level 9c Venturi 1998a, Fig. 7.12  
Tell Afis Area Ge level 3 Cecchini 1998, Fig. 14.18  
Tell Afis Area Ge level 5 Cecchini 1998, Fig. 14.2  
# Tell Kazel Area II level 5 Badre 1990b, Fig. 41.b  
Tell Kazel Area IV level 4 Badre & Gubel 1999-2000, Fig. 43.c  
\* Tell Keisan 9c Briend & Humbert 1980, Pl. 79.14  
Tell Keisan 9c Briend & Humbert 1980, Pl. 79.14b, f, h  
Tell Qarqur 9 Unpublished  
Tyre XIII Bikai 1978b, Pl. 33.12

#### Iron I-II

- Akhziv Tomb N1 E. Mazar 2004, Fig. 1.11  
Byblos Necropolis K Salles 1980, Pl. 17.27  
\* Megiddo VA-IVB Lamon & Shipton 1939, Fig. 28.95  
Megiddo VA-IVB Lamon & Shipton 1939, Fig. 30.123  
Sarepta Area X level VII Khalifeh 1988, Type F2  
Tel Beth Shan V James 1966, Figs 5.13; 6.2  
Tel Beth Shan V James 1966, Fig. 26.9  
Tel Beth Shan Northern cem. Oren 1973, Figs 42a.7; 44a.5  
# Tel Dan IV Biran 1982, Fig. 24.16  
Tel Dan IV Biran 1982, Fig. 24.17  
Tell el Ghassil Area III level 4 Joukowsky 1972, Pl. 26.15  
# Tyre X Bikai 1978b, Pl. 26.20

#### Iron II

- # Beirut Bey 003 glacis II Badre 1997b, Fig. 35.4-5  
Hama E Fugmann 1958, Fig. 344 (H914)  
# Hazor IV Yadin *et al.* 1961, Pl. 254.10-11  
Hazor V Yadin *et al.* 1958, Pl. 53.8  
# Hazor V Yadin *et al.* 1958, Pl. 67.14  
#\* Hazor V Yadin *et al.* 1960, Pl. 75.3  
# Hazor V Yadin *et al.* 1961, Pl. 220.13

- # Hazor V Yadin *et al.* 1961, Pl. 225.13  
 # Hazor V Yadin *et al.* 1961, Pl. 226.8  
 #\* Hazor V Ben Tor *et al.* 1997, Fig. III.45 (1)  
 # Hazor VI Yadin *et al.* 1960, Pl. 66.11  
 # Hazor VI Yadin *et al.* 1960, Pl. 67.4  
 # Hazor VI Yadin *et al.* 1961, Pl. 219.5  
 # Hazor VI Ben Tor *et al.* 1997, Fig. III.35 (16)  
 # Hazor VII Yadin *et al.* 1960, Pl. 63.25  
 # Hazor VII Yadin *et al.* 1961, Pl. 180.9  
 # Hazor VII Yadin *et al.* 1961, Pl. 214.19-20  
 # Hazor VIII Yadin *et al.* 1960, Pl. 53.23  
 Hazor VIII Ben Tor *et al.* 1997, Fig. III.24 (16)  
 # Khirbet Silm S. V. Chapman 1972, Fig. 28.152  
 #\* Ras al-Bassit Findgroup C Braemer 1986, Fig. 3.9  
 Tel Beth Shan IV James 1966, Fig. 67.15, 22  
 \* Tel Beth Shan IV James 1966, Fig. 67.23  
 # Tel Beth Shan Area P level 7 A. Mazar 2001, Fig. 12.4  
 Tel Dan II Biran 1999, Fig. 7.4  
 Tel Jezreel Findgroup B Zimhoni 1997b, Fig. 2.8 (2)  
 Tel Jezreel Findgroup D Zimhoni 1997a, Figs 1.2 (11); 1.3 (6)  
 Tell Afis Area D level 4 Mazzoni 1988a, Fig. 15.18  
 # Tell Afis Area E2 level 1 Degli Esposti 1998, Fig. 10.9-10  
 Tell Afis Area Gc level 8b Cecchini 1998, Fig. 18.7  
 Tell el Ghassil Area I level 2 Baramki 1964, Fig. 29.3  
 # Tell el Ghassil Area III level 2 Joukowsky 1972, Pl. 17.59  
 Tell Keisan 7 Briend & Humbert 1980, Pl. 52.10  
 # Tell Qarqur 8 Dornemann 2003a, Fig. 82.1  
 Tell Rachidiah Tomb IV Doumet 1982, Pl. XVIII.61  
 # Tyre II Bikai 1978b, Pl. 10.15, 21  
 Tyre III Bikai 1978b, Pl. 10.14, 20  
 # Tyre III Bikai 1978b, Pl. 10.16  
 \* Tyre IV Bikai 1978b, Pl. 15.8  
 # Tyre V Bikai 1978b, Pl. 18.7  
 # Tyre VIII Bikai 1978b, Pl. 19.21  
 # Tyre IX Bikai 1978b, Pl. 19.8  
 # Tyre Al-Bass cem. III Núñez 2004a, Fig. 54.2
- Iron I-III**  
 Akhziv South Cem I Dayagi-Mendels 2002, Fig. 3.3(2)  
 \* Akhziv South Cem XI Dayagi-Mendels 2002, 23 (4)  
 Akhziv East Cem XVII Dayagi-Mendels 2002, Fig. 4.14(3)  
 Akhziv East Cem XXXVI Culican 1982, Fig. 9n  
 Akhziv East Cem XXXVI Dayagi-Mendels 2002, Fig. 4.27(5)
- Iron II-III**  
 Akhziv East Cem XXXI Dayagi-Mendels 2002, 86 (1-2)  
 Akhziv Tomb N3 E. Mazar 2004, Fig. 1.12  
 #\* Al Mina VIII du Plat Taylor 1959, Fig. 6.4  
 # Beirut Bey 003 abandonment Badre 1997b, Fig. 36.10  
 #\* Beirut Bey 003 abandonment Badre 2000b, Fig. 5.5  
 Deve Höyük Cem. I Moorey 1980, Fig. 3.12  
 Hazor III/IV Yadin *et al.* 1958, Pl. 78.9  
 Sarepta Area X level VIII Khalifeh 1988, Type F2  
 \* Sarepta Area Y level C Anderson 1988, Pl. 35.11  
 \*\* Sarepta Area Y level C Anderson 1988, Pl. 38.2  
 # Tyre I Bikai 1978b, Pl. 1.4  
 \* Tyre Al-Bass cem. IV Núñez 2004a, Fig. 80.9  
 # Tyre Al-Bass cem. Unstrat. Núñez 2004a, Fig. 111.P7.2  
 Tyre Al-Bass cem. Unstrat. Núñez 2004a, Fig. 115.P16.2  
 Tyre Al-Bass cem. Unstrat. Núñez 2004a, Fig. 115.P22.2
- Iron III**  
 # Al Mina VI Lehmann 1996, Pl. 23 (145b/4)

# Hazor III Yadin *et al.* 1958, Pl. 77.26  
 # Megiddo II/III Lamon & Shipton 1939, Fig. 24.55  
 \* Ras al-Bassit Findgroup D Braemer 1986, Fig. 4.18  
 # Ras al-Bassit Findgroup F Braemer 1986, Fig. 6.32  
 # Ras al-Bassit Findgroup H Braemer 1986, Fig. 8.44  
 \* Tell Keisan 4 Briend & Humbert 1980, Pl. 28.5  
 # Tell Keisan 5 Briend & Humbert 1980, Pl. 41.7  
 Tell Keisan 5 Briend & Humbert 1980, Pl. 41.8  
 #\* Tell Keisan 5 Briend & Humbert 1980, Pl. 42.1  
 Tell Shiyuk Fawqani Area G level 2 Luciani 2005, Pl. 4.52-53  
 Tell Shiyuk Fawqani Area G level 2 Luciani 2005, Pl. 9.119

#### **Iron II-Persian**

# Akhziv South Cem 68 E. Mazar 2001, Fig. 52.16  
 # Akhziv South Cem 69 E. Mazar 2001, Fig. 60.1  
 Akhziv South Cem 72 E. Mazar 2001, Fig. 64.16

#### **Persian**

Athlit Tomb 20 Johns 1932, 71, Fig. 4j  
 Athlit Tomb 21 Johns 1932, 74, Fig. 4j  
 Athlit Tomb 24 Johns 1932, 98, Fig. 4j  
 Sarepta Area Y level B Anderson 1988, Pl. 38.22  
 Tell Keisan 3 Briend & Humbert 1980, Pl. 20.10  
 Tell Shiyuk Fawqani Area G level 1 Luciani 2005, Pl. 35.429

#### **Unclear Context**

Jerablus Yunus cem. Woolley 1939b, Pl. 23.B25  
 Sarepta Area X unstrat. Pritchard 1988, Fig. 38.2  
 Tell Abu Hawam III Hamilton 1935, 21, No. 70

### **B.17.27.2 CLASS 160b**

#### **Iron I**

Hama Cem. II Riis 1948, Fig. 106  
 Hama F1 Riis & Buhl 1990, 130 (Form XXXB2)  
 \* Hazor IX Yadin *et al.* 1961, Pl. 178.39  
 # Hazor IX/X Yadin *et al.* 1958, Pl. 45.8  
 # Khalde Cem. IV Saidah 1966, No. 43  
 Khalde Tomb 167 Saidah 1966, No. 61  
 Pella Area III level I McNicoll *et al.* 1992, Pl. 51.2  
 Sarepta Area Y level F Anderson 1988, Pl. 29.22  
 Tell Keisan 9a/b Briend & Humbert 1980, Pl. 66.12-13  
 Tell Qarqur 9 Unpublished

#### **Iron I-II**

Akhziv East Cem XXXIX Dayagi-Mendels 2002, Fig. 4.28(2)  
 # Tel Beth Shan V James 1966, Fig. 22.3  
 Tyre X Bikai 1978b, Pl. 23.12  
 \* Tyre X Bikai 1978b, Pl. 27.2

#### **Iron II**

# Hazor IV Yadin *et al.* 1960, Pl. 99.13  
 # Hazor V Yadin *et al.* 1960, Pl. 92.17  
 # Hazor VIII Yadin *et al.* 1958, Pl. 47.6  
 # Hazor VIII Yadin *et al.* 1960, Pl. 53.34  
 Pella Area VIII level 6 McNicoll *et al.* 1992, Pl. 66.12  
 # Sidon Iron II Doumet-Serhal 2006, Fig. 28.10  
 Tel Beth Shan IV James 1966, Fig. 67.20  
 # Tell el Ghassil Area III level 2 Joukowsky 1972, Pl. 17.60  
 # Tell Mastuma South Area Wada 1994, Fig. 1.10  
 # Tell Qarqur 8 Unpublished  
 Tell Rachidiah Tomb IV Doumet 1982, Pl. XVII.20  
 # Tyre II Bikai 1978b, Pl. 10.24-25  
 Tyre II Bikai 1978b, Pl. 10.25



- \*\* Tyre IV Bikai 1978b, Pl. 15.19
- #\* Tyre IV Bikai 1978b, Pl. 15.20
- # Tyre IV Bikai 1978b, Pl. 15.25
- \*\* Tyre VIII Bikai 1978b, Pl. 22.7
- \*\* Tyre IX Bikai 1978b, Pl. 19.27

#### **Iron I-III**

Akhziv East Cem XVII Dayagi-Mendels 2002, Fig.4.14(6)

#### **Iron II-III**

# Tyre I Bikai 1978b, Pl. 1.5

#### **Iron II-Persian**

Akhziv South Cem 68 E. Mazar 2001, Fig. 52.10

## **B.17.28 CLASS 161**

### **Iron I**

- \* Ain Dara Lower Mound Iron I Stone & Zimansky 1999, Fig. 27.2
- # Hazor IX Yadin *et al.* 1961, Pl. 175.20
- Hazor IX Yadin *et al.* 1961, Pl. 178.10
- Hazor IX Yadin *et al.* 1961, Pl. 208.18, 22
- Hazor IX/X Yadin *et al.* 1961, Pl. 164.3
- Hazor IX/X Yadin *et al.* 1961, Pl. 210.4
- Hazor IX/X Unpublished
- # Hazor X Yadin *et al.* 1960, Pl. 51.2
- Hazor X Ben Tor *et al.* 1997, Fig. III.23 (4)
- Hazor Iron I Ben Ami 2001, Fig. 5.6
- Megiddo VIA Loud 1948, Fig. 78.11
- Pella Area III level I McNicoll *et al.* 1992, Pl. 51.10
- Pella Area VIII level 7 McNicoll *et al.* 1992, Pl. 65.2
- Sarepta Area Y level E Anderson 1988, Pl. 31.19
- Tell Kazel Area II level 5 Capet 2003, Fig. 45.g
- Tell Keisan 9a/b Briend & Humbert 1980, Pl. 66.6d
- Tell Keisan 9c Briend & Humbert 1980, Pl. 79.13
- Tell Mishrife Iron I Unpublished
- Tell Sukas South Harbour Buhl 1996, Fig. 29.XIIG
- Tyre XIII Bikai 1978b, Pl. 33.1, 4, 16

### **Iron I-II**

- Megiddo VA-IVB Lamon & Shipton 1939, Fig. 30.124
- # Megiddo VA-IVB Loud 1948, Fig. 89.12
- Tell el Ghassil Area I level 4 Joukowsky 1972, Pl. 8.22
- Tell Mishrife Operation H levels 5-6 Barro 2002, Fig. 107.5

### **Iron II**

- Hazor IV Yadin *et al.* 1961, Pl. 254.26
- Hazor VIII Yadin *et al.* 1960, Pl. 54.4
- # Megiddo IVA Lamon & Shipton 1939, Fig. 25.67
- Sidon Iron II Doumet-Serhal 2006, Fig. 28.3-4
- # Sidon Iron II Doumet-Serhal 2006, Fig. 31.29
- Tel Jezreel Iron II Zimhoni 1997b, Fig. 2.3 (7)
- Tell Abou Danne IId/A6 Lebeau 1983, Pls 9.3 ;16.1-4
- Tell Afis Area B (Afis VIII) Scigliuzzo 2005, Fig. 37.2
- # Tell Arqa 10AB Chaaya 2000, Fig. 2.5
- # Tell Arqa 10CD Unpublished
- # Tell Arqa Tomb 1 Thalmann 1978b, Fig. 45.11
- Tell Jurn Kabir Findgroup B Eidem and Ackermann 1999, Fig. 6.8
- Tell Keisan 7 Briend & Humbert 1980, Pl. 52.7
- Tell Mishrife Operation C level II al Maqdissi 2003, Fig. 12.4;
- # Tell Mishrife Iron II Unpublished
- Tell Nebi Mend Trench V Level B Unpublished
- Tell Nebi Mend Trench V Level C Unpublished
- # Tell Qarqur 8 Dornemann 2003a, Fig. 82.2, 11-12

Tell Qarqur 8 Dornemann 2003a, Fig. 82.3-4  
 Tyre III Bikai 1978b, Pl. 9.20  
**Iron II-III**  
 Hazor III/IV Yadin *et al.* 1958, Pl. 78.5  
 Sarepta Area Y level C Anderson 1988, Pl. 35.2-3  
**Iron III**  
 Tell Afis Area D level 2 Mazzoni 1988a, Fig. 9.17  
 Tell Ahmar Area C level 2 Jamieson 2005, Fig. 4.2.1-2  
 Tell Keisan 5 Briend & Humbert 1980, Pl. 41.6  
 \*\* Tell Keisan 5 Briend & Humbert 1980, Pl. 41.16  
 Tell Shiyuk Fawqani Area G level 2 Luciani 2005, Pl. 5.59  
**Persian**  
 Sidon Persian Doumet-Serhal 2006, Fig. 18.6, 10  
**Unclear Context**  
 Tell Abu Hawam III Hamilton 1935, 21, No. 75  
 Tell Mishrife Operation J Morandi Bonacossi 2002, Fig. 113.5-6

## **B.17.29 CLASS 162**

### **Iron I**

Hama Cem. I Riis 1948, Fig. 107  
 Hama Cem. II Riis 1948, Fig. 107  
 Hama F1 Riis & Buhl 1990, 130 (Form XXXB3)  
 Hazor IX Yadin *et al.* 1961, Pl. 175.6, 12  
 #\* Hazor IX Yadin *et al.* 1961, Pl. 175.19  
 Hazor IX Yadin *et al.* 1961, Pl. 208.13-16, 19  
 Hazor IX/X Yadin *et al.* 1961, Pl. 210.1, 3  
 Hazor IX/X Unpublished  
 \* Hazor X Yadin *et al.* 1960, Pl. 51.5  
 # Hazor X Yadin *et al.* 1960, Pl. 51.7  
 Hazor X Yadin *et al.* 1961, Pl. 174.1  
 # Hazor X Yadin *et al.* 1961, Pl. 174.2  
 \* Hazor XI Yadin *et al.* 1961, Pl. 203.1  
 Hazor XII Yadin *et al.* 1961, Pl. 164.22  
 \* Khalde Cem. IV Saidah 1966, No. 45  
 # Megiddo VB Lamon & Shipton 1939, Figs 28.93b  
 Megiddo VB Lamon & Shipton 1939, Fig. 30.117  
 \* Megiddo VB Lamon & Shipton 1939, Fig. 30.139  
 Megiddo VB Lamon & Shipton 1939, Fig. 31.142  
 \* Megiddo VIA Loud 1948, Fig. 78.8-9  
 \* Megiddo VIA Harrison 2004b, Pl. 4.4  
 \* Megiddo VIB Loud 1948, Fig. 74.11  
 Sarepta Area X level V Khalifeh 1988, Type X26  
 Sarepta Area Y level E Anderson 1988, Pl. 31.14  
 # Sarepta Area Y level F Anderson 1988, Pl. 29.20  
 \* Sarepta Area Y level G Anderson 1988, Pl. 26.12  
 # Tel Beth Shan VI James 1966, Fig. 57.3  
 # Tel Beth Shan VI James 1966, Fig. 58.8  
 Tell Abu Hawam IV Hamilton 1935, 29, No. 156  
 Tell Abu Hawam IV Hamilton 1935, Fig. 15  
 \* Tell Afis Area E1 level 9a Venturi 2000a, Fig. 7.8  
 \*\* Tell Kazel Area II level 6 Capet 2003, Fig. 20.h  
 Tell Kazel Area II level 6 Capet 2003, Fig. 25.b  
 \* Tell Keisan 9a/b Briend & Humbert 1980, Pl. 66.5  
 Tell Keisan 9a/b Briend & Humbert 1980, Pl. 66.8  
 \* Tell Keisan 9c Briend & Humbert 1980, Pl. 80.4-5  
 Tell Sukas South Harbour Buhl 1996, Fig. 27.XID  
 \* Tyre XII Bikai 1978b, Pl. 31.8  
 Tyre XIII Bikai 1978b, Pl. 33.9

Tyre XIII Bikai 1978b, Pl. 37.4, 6, 8

\* Tyre XIV Bikai 1978b, Pl. 39.21

Tyre Al-Bass cem. I Núñez 2004a, Fig. 110.P8

#### Iron I-II

\* Akhziv TC4 E. Mazar 2001, Fig. 7.19

Akhziv TC4 E. Mazar 2001, Fig. 7.20

Akhziv Tomb N1 E. Mazar 2004, Fig. 1.1

\* Byblos Necropolis K Salles 1980, Pl. 19.6

\* Megiddo VA-IVB Lamon & Shipton 1939, Fig. 30.140; Loud 1948, Fig. 90.1

# Megiddo Area K level 2 (VA-IVB) Finkelstein *et al.* 2000b, Fig. 11.20(7)

# Tel Beth Shan V James 1966, Figs 6.3; 18.2

Tel Beth Shan V James 1966, Fig. 6.3

Tel Beth Shan V James 1966, Fig. 22.11

Tyre X Bikai 1978b, Pl. 23.2, 7

Tyre X Bikai 1978b, Pl. 26.1-4

\* Tyre X Bikai 1978b, Pl. 28.4, 7

#### Iron II

\* Beirut Bey 003 glaxis IIBadre 1997b, Fig. 35.12

Beirut Bey 003 glaxis II Badre 1998, Fig. 6.7

Hama E1 Riis & Buhl 1990, 130 (Form XXXB3)

Hama E2 Riis & Buhl 1990, 130 (Form XXXB3)

Hazor V Yadin *et al.* 1958, Pl. 73.33

Hazor V Yadin *et al.* 1958, Pl. 74.5

# Hazor V Yadin *et al.* 1960, Pl. 79.8

# Hazor V Yadin *et al.* 1960, Pl. 80.31

Hazor V Yadin *et al.* 1961, Pl. 251.26

\* Hazor VI Yadin *et al.* 1958, Pl. 51.28

# Hazor VI Yadin *et al.* 1961, Pl. 214.21

Hazor VI Yadin *et al.* 1961, Pl. 220.7, 10

# Hazor VI Yadin *et al.* 1961, Pl. 220.9

Hazor VII Yadin *et al.* 1960, Pl. 63.20

Hazor VIII Yadin *et al.* 1960, Pl. 53.24, 29

Joya S. V. Chapman 1972, Fig. 24.236-237

\* Khalde Tomb 1 Saidah 1966, No. 1

Khalde Tomb 2 Saidah 1966, No. 6

\* Khalde Tomb 121 Saidah 1966, No. 21

Khirbet Silm S. V. Chapman 1972, Fig. 24.114, 117

# Megiddo IVA Lamon & Shipton 1939, Fig. 25.68

\*\* Sidon Iron II Doumet-Serhal 2006, Fig. 24-25

\*\* Sarepta Area Y level D Anderson 1988, Pl. 33.11

Sarepta Area Y level D Anderson 1988, Pls 32.17; 33.13

Tel Beth Shan V upper James 1966, Fig. 63.5

Tel Jezreel Findgroup B Zimhoni 1997b, Fig. 2.8 (3)

Tel Jezreel Findgroup C Zimhoni 1997a, Fig. 1.8 (1)

# Tell Afis Area B (Afis VIII) Virgilio 2005, Fig. 34.2

Tell Afis Area D level 4 Mazzoni 1988a, Fig. 15.21

Tell el Ghassil Area I level 2 Baramki 1964, Fig. 29.2

Tell Keisan 7 Briend & Humbert 1980, Pl. 52.1, 3-4

\*\* Tell Keisan 7 Briend & Humbert 1980, Pl. 53.1, 7

Tell Keisan 8 Briend & Humbert 1980, Pl. 55.13-14

\* Tell Keisan 8 Briend & Humbert 1980, Pl. 55.13a

# Tell Mastuma South Area Wada 1994, Fig. 1.16

Tell Qarqur 8 Unpublished

\*\* Tell Rachidiah Tomb IV Doumet 1982, Pl. XV.5, 24, 41, 86

Tell Rachidiah Tomb IV Doumet 1982, Pl. XVI.49

#\* Tell Rifa'at 2b-c Seton Williams 1961, Pl. 39.9

\* Tell Rifa'at 2b-c Matthers 1981b, Fig. 233.8

Tell Sukas H1 Buhl 1983, Fig. XIV.197

#\* Tyre II Bikai 1978b, Pl. 10.27

\*\* Tyre III Bikai 1978b, Pl. 10.13

- # Tyre III Bikai 1978b, Pl. 10.26
- Tyre V Bikai 1978b, Pl. 18.1
- Tyre VIII Bikai 1978b, Pl. 19.15
- \*\* Tyre IX Bikai 1978b, Pl. 19.23
- \* Tyre Al-Bass cem. II Núñez 2004a, Fig. 68.6
- \*\* Tyre Al-Bass cem. II Núñez 2004a, Fig. 76.4
- Tyre Al-Bass cem. II Núñez 2004a, Fig. 93.2
- \*\* Tyre Al-Bass cem. II Núñez 2004a, Fig. 100.2
- Iron I-III**
- ## Akhziv South Cem I Dayagi-Mendels 2002, Fig. 3.1(14)
- \* Akhziv South Cem I Dayagi-Mendels 2002, Fig. 3.1(15)
- # Akhziv South Cem VI Dayagi-Mendels 2002, Fig. 3.7(5)
- Akhziv South Cem X Dayagi-Mendels 2002, Fig. 3.9(1)
- \*\* Akhziv South Cem XI Dayagi-Mendels 2002, Fig. 3.10(9-10)
- # Akhziv South Cem XX Dayagi-Mendels 2002, Fig. 3.16(8)
- Iron II-III**
- \* Beirut Bey 003 abandonment Badre 1997b, Fig. 38.13-16
- CWP Beirut Bey 003 abandonment Badre 1998, Fig. 7.2-3
- IMP Beirut Bey 003 abandonment Badre 1998, Fig. 8.13, 15
- \*\* Qraye S. V. Chapman 1972, Fig. 25.298
- # Sarepta Area Y level C Anderson 1988, Pl. 35.19
- Iron III**
- \* Al Mina VIII-V du Plat Taylor 1959, Fig. 1.10
- \*\* Al Mina VIII-V du Plat Taylor 1959, Fig. 1.13
- ## Al Mina VIII-V du Plat Taylor 1959, Fig. 5.10
- \*\* Al Mina VI/V Lehmann 1996, Pl. 24 (155/2)
- \* Al Mina VI see Lehmann 1996, 388 (Form 153)
- # Megiddo II/III Lamon & Shipton 1939, Fig. 24.46
- # Ras al-Bassit Findgroup E Braemer 1986, Fig. 5.24
- # Tell Afis Area D level 2 Mazzoni 1988a, Fig. 9.18; Oggiano 1997, Pl. V.8
- Tell Afis Area Gc level 6 Cecchini 1998, Fig. 27.5
- Tell Ahmar Area C level 2 Jamieson 1999, Fig. 1.3
- Tell Ahmar Area C level 2 Jamieson 2000, Fig. 2.5-9
- Tell Keisan 4 Briend & Humbert 1980, Pl. 29.10
- Tell Keisan 5 Briend & Humbert 1980, Pl. 41.9-11
- \* Tell Rifa'at 2a Lehmann 1996, Pl. 24 (153/1)
- Tell Shiyuk Fawqani Area G level 2 Luciani 2005, Pl. 4.38
- \*\* Tyre Al-Bass cem. V Núñez 2004a, Fig. 90.5
- Persian**
- \* Al Mina IV Lehmann 1996, Pl. 24 (155/1)
- \*\* Al Mina IV Lehmann 1996, Pl. 25 (156/4)
- # Athlit Tomb 21 Johns 1932, Fig. 37
- \* Athlit Tomb 34 Johns 1932, Fig. 88
- # Tell Kazel Area I level 4 Badre & Gubel 1999-2000, Fig. 4.d
- Tell Keisan 3 Briend & Humbert 1980, Pl. 22.6
- Unclear Context**
- \* Al Mina Unstrat. Lehmann 1996, Pl. 25 (156/3)
- \*\* Sarepta Area X unstrat. Pritchard 1988, Fig. 41.31, 33
- \* Sarepta Area X unstrat. Koehl 1985, Fig. 22.246
- Sarepta Area X unstrat. Pritchard 1988, Fig. 41.34
- \* Tell Abu Hawam III Hamilton 1935, 22, No. 85
- \*\* Tell Kazel Unstrat. Yon & Caubet 1990, Fig. 3.131
- \* Tell Kazel Unstrat. Yon & Caubet 1990, Fig. 3.160
- ## Tell Kazel Unstrat. Yon & Caubet 1990, Fig. 3.186

## **B.17.30 CLASS 163**

### **Iron I**

- \* Megiddo Area K level 3 (VB) Finkelstein *et al.* 2000b, Fig. 11.18(10)

\*\* Megiddo Tombs Guy 1938, Pl. 74.17

#### **Iron I-II**

\* Megiddo VA-IVB Loud 1948, Fig. 90.2

\* Megiddo VA-IVB Loud 1948, Fig. 90.3

\*\* Megiddo Tombs Guy 1938, Pl. 72.8

\* Tyre X Bikai 1978b, Pl. 28.5

#### **Iron II**

CWP Beirut Bey 003 glacis II Badre 1998, Fig. 6.4-5

# Hazor VI Yadin *et al.* 1961, Pl. 182.18

Hazor VII Ben Tor *et al.* 1997, Fig. III.30 (17)

BOR Tel Jezreel Findgroup D Zimhoni 1997a, Fig. 1.3 (11)

\* Tell Keisan 8 Briend & Humbert 1980, Pl. 56.1

\* Tyre VI Bikai 1978b, Pl. 18.22

\* Tyre IX Bikai 1978b, Pl. 22.15-16

#### **Iron II-III**

CWP Beirut Bey 003 abandonment Badre 1997b, Fig. 38.10

\*\* Qraye S. V. Chapman 1972, Fig. 31.307

\* Qraye S. V. Chapman 1972, Fig. 31.308

BOR Sarepta Area Y level C Anderson 1988, Pl. 38.11

#### **Iron III**

\* Al Mina V Lehmann 1996, Pl. 24 (154/1)

\* Al Mina VIII-V du Plat Taylor 1959, Fig. 1.1-6, 8

BOR Al Mina VIII-V du Plat Taylor 1959, Fig. 5.1-3, 5

\* Megiddo II/III Lamon & Shipton 1939, Fig. 29.107

\* Tell Keisan 4 Briend & Humbert 1980, Pl. 28.2

#### **Unclear Context**

BOR Tell Abu Hawam III Hamilton 1935, Fig. 8

CWP Tell Kazel Unstrat. Yon & Caubet 1990, Fig. 2.130

BOR Tell Kazel Unstrat. Yon & Caubet 1990, Fig. 3.184

## **B.17.31 CLASS 164**

#### **Iron I**

Hama Cem. I Riis 1948, Fig. 105

Hama Cem. II Riis 1948, Fig. 105

Hama F1 Riis & Buhl 1990, 130 (Form XXXB1)

Hama F2 Riis & Buhl 1990, 130 (Form XXXB1)

# Sarepta Area Y level F Anderson 1988, Pl. 29.18

\*\* Tell Abu Hawam IV Hamilton 1935, 29, No. 153

\* Tell Kazel Area II level 5 Capet 2003, Fig. 39.b

Tell Kazel Area II level 5 Capet 2003, Fig. 45.f

Tell Kazel Area II level 6 Badre 1990b, Fig. 43.e

Tell Kazel Area II level 6 Badre *et al.* 1994, Fig. 42.e-f

Tell Kazel Area II level 6 Badre *et al.* 1994, Fig. 59.a

Tell Kazel Area II level 6 Capet 2003, Fig. 4

Tell Kazel Area II level 6 Capet 2003, Fig. 12.b

Tell Kazel Area II level 6 Capet 2003, Fig. 32.i

Tell Kazel Area IV level 5 Badre & Gubel 1999-2000, Fig. 31.f-g

Tyre XI Bikai 1978b, Pl. 29.6

Tyre XII Bikai 1978b, Pl. 31.3

#### **Iron I-II**

Akhziv TC4 E. Mazar 2001, Fig. 7.17-18

\*\* Akhziv TC4 E. Mazar 2001, Fig. 7.13

Tell Kazel Area I level 14 Badre & Gubel 1999-2000, Fig. 6.h

#### **Iron II**

Hama Cem. III Riis 1948, Fig. 105

Hama E1 Riis & Buhl 1990, 130 (Form XXXB1)

Hazor V Yadin *et al.* 1961, Pl. 222.7

Hazor VI Yadin *et al.* 1961, Pl. 181.24, 39

# Hazor VII Ben Tor *et al.* 1997, Fig. III.30 (16)  
 \* Hazor VIII Yadin *et al.* 1960, Pl. 53.32  
 Megiddo IVA Lamon & Shipton 1939, Pl. 26.75  
 # Tel Beth Shan V upper James 1966, Fig. 63.3  
 Tel Rehov Area C/E level 1 A. Mazar 1999a, Fig. 24.2  
 # Tell Kazel Area II level 4 Capet 2003, Fig. 51.b  
 Tell Kazel Area II level 4 Badre 1990b, Fig. 37.c  
 Tell Kazel Area I levels 6-13 Badre & Gubel 1999-2000, Fig. 5.h  
 \*\* Tell Rachidiah Tomb IV Doumet 1982, Pl. XV.128, 133  
 \* Tell Rachidiah Tomb IV Doumet 1982, Pl. XVI.134  
 Tell Rifa'at 2b-c Seton Williams 1967, Fig. 1.d  
 Tell Rifa'at 2b-c Seton Williams 1967, Fig. 1.f  
 Tille Höyük IV-V Blaylock 1999, Fig. 4.5-6  
 Tyre VIII Bikai 1978b, Pl. 19.29

#### **Iron I-III**

Akhziv South Cem XX Dayagi-Mendels 2002, Fig. 3.16(2)  
 Akhziv East Cem XVII Dayagi-Mendels 2002, 66 (1-2)

#### **Iron II-III**

Akhziv East Cem XXIX Dayagi-Mendels 2002, 78 (1)  
 Akhziv East Cem XXIX Dayagi-Mendels 2002, Fig. 4.21(2)  
 Akhziv TC2 E. Mazar 2001, Fig. 20b.11-12  
 Tyre Al-Bass cem. Unstrat. Núñez 2004a, Fig. 112.P27.1

#### **Iron III**

# Tell Judeideh III see Lehmann 1996, 361 (Form 7)  
 \* Tell Keisan 5 Briand & Humbert 1980, Pl. 41.13

#### **Unclear Context**

Chatal Höyük Unstrat. see Lehmann 1996, 364 (Form 23)  
 \*\* Sarepta Area X unstrat. Pritchard 1988, Fig. 39.19-20  
 \* Sarepta Area X unstrat. Pritchard 1988, Fig. 39.22  
 Sarepta Area X unstrat. Pritchard 1988, Fig. 39.25

## **B.17.32 CLASS 165**

### **B.17.32.1 CLASS 165a**

#### **Iron I**

Hama F Fugmann 1958, Fig. 165 (5A515, 5A536)  
 Hama F2 Riis & Buhl 1990, 130 (Form XXXA1)  
 \* Tell Rifa'at 3 Seton Williams 1961, Pl. 39.3  
 Tell Tayinat Iron I Unpublished  
 Tille Höyük I-III Blaylock 1999, Fig. 2.2

#### **Iron I-II**

Akhziv TC4 E. Mazar 2001, Fig. 7.16  
 Byblos Necropolis K Salles 1980, Pl. 19.7-15  
 # Tel Beth Shan V James 1966, Fig. 7.2

#### **Iron II**

Hama E Fugmann 1958, Fig. 269 (6B369)  
 \* Hama E Fugmann 1958, Fig. 269 (6B476)  
 Hama E Fugmann 1958, Fig. 310 (7A873, 7B21, 7B407)  
 \* Hama E Fugmann 1958, Fig. 325 (8A185)  
 \* Hama E Riis & Buhl 1990, Fig. 75 (540)  
 Hama E1 Riis & Buhl 1990, 130 (Form XXXA1)  
 \* Hama E1 Riis & Buhl 1990, Fig. 75 (535-536)  
 \* Hama E1 Riis & Buhl 1990, Fig. 76 (545, 547, 555)  
 Hama E2 Riis & Buhl 1990, 130 (Form XXXA1)  
 \* Hama E2 Riis & Buhl 1990, Fig. 75 (539)  
 \* Hama E2 Riis & Buhl 1990, Fig. 76 (552)  
 # Megiddo IVA Lamon & Shipton 1939, Fig. 26.76  
 Tell el Ghassil Area I level 2 Baramki 1964, Fig. 32.3

# Tell el Ghassil Area I level 2 Joukowsky 1972, Pl. 2.9  
Tell Rifa'at 2b-c Seton Williams 1967, Fig. 1.c  
Tell Rifa'at 2b-c Seton Williams 1967, Fig. 1.e  
Tell Shiyuk Fawqani Area H Al-Bahloul *et al.* 2005, Pl. 5d  
# Tell Tayinat Iron II Unpublished

#### Iron III

Ras al-Bassit Cem. Courbin 1993a, Fig. 6.6(C1069)  
Tell Ahmar Area C level 2 Jamieson 2000, Fig. 14.1-4

#### Unclear Context

Jerablus Yunus cem. Woolley 1939b, Pl. 23.B22  
\* Tell Abu Hawam III Hamilton 1935, 22, No. 77  
\* Tell Abu Hawam III Hamilton 1935, 22, No. 84  
Tell Mishrife Unstrat. du Mesnil du Buisson 1926, Pl. 69.6  
Tell Mishrife Unstrat. du Mesnil du Buisson 1927, Fig. 5.21-22  
\* Tell Mishrife Unstrat. du Mesnil du Buisson 1927, Pls 79.43-44; 82.73  
\* Tell Mishrife Unstrat. du Mesnil du Buisson 1927, Pl. 81.69-70

### B.17.32.2 CLASS 165b

#### Iron I

Hama Cem. II Riis 1948, Fig. 113  
\* Hama F Fugmann 1958, Fig. 165 (4C52)  
Hama F1 Riis & Buhl 1990, 130 (Form XXXA2)  
\* Hama F1 Riis & Buhl 1990, Fig. 77 (574)  
Hama F2 Riis & Buhl 1990, 130 (Form XXXA2)

#### Iron II

Hama Cem. III Riis 1948, Fig. 113  
Hama Cem. IV Riis 1948, Fig. 102  
\* Hama E Fugmann 1958, Fig. 188 (5B693)  
\* Hama E Fugmann 1958, Figs 216 (7B682); 269 (6B368, 6B398, 6B431, 6B472, 6B492, 6B516, 7A878, 7B213)  
\* Hama E Fugmann 1958, Fig. 245 (7B682)  
Hama E Fugmann 1958, Fig. 269 (6B386)  
\* Hama E Fugmann 1958, Fig. 269 (4C56, 5B60, 6B445, 6B477, 6B515, 6C52)  
\* Hama E Fugmann 1958, Figs 269 (6B479); 305 (5B83, 5B108)  
\* Hama E Fugmann 1958, Fig. 310 (8A118)  
\* Hama E Fugmann 1958, Fig. 325 (8A152, 8A187)  
Hama E Fugmann 1958, Fig. 325 (8A68, 8A222)  
\* Hama E Fugmann 1958, Fig. 344 (4B767, 4B830, 4B835, H796)  
Hama E Fugmann 1958, Fig. 344 (4B843, 4C995)  
Hama E Riis & Buhl 1990, Fig. 76 (556-557)  
Hama E1 Riis & Buhl 1990, 130 (Form XXXA2)  
Hama E1 Riis & Buhl 1990, Fig. 76 (558)  
\* Hama E1 Riis & Buhl 1990, Fig. 77 (572-573)  
Hama E2 Riis & Buhl 1990, 130 (Form XXXA2)  
Tell Abou Danne IId/A6 Lebeau 1983, Pl. 89.7  
# Tell Abou Danne IId/A6 Lebeau 1983, Pl. 89.9  
Tell Rifa'at 2b-c Seton Williams 1967, Fig. 1.a  
\* Tell Rifa'at 2b-c see Lehmann 1996, 361 (Form 9)

### B.17.33 CLASS 166

#### Iron II

# Hama Cem. III Riis 1948, Fig. 115  
# Hama Cem. IV Riis 1948, Fig. 115  
# Hama Cem. IV Riis 1948, Fig. 116  
# Hama E Fugmann 1958, Figs 188 (5B93); 216 (Salle A); 245 (Salle N15)  
# Hama E Fugmann 1958, Figs 269 (5A499, 5A500, 6B471); 310 (8A219)  
# Hama E Fugmann 1958, Fig. 310 (7A875, 7B20, 7B418)

- # Hama E Fugmann 1958, Fig. 325 (8A58)
- # Hama E Fugmann 1958, Fig. 344 (H742, H908)
- # Hama E Riis & Buhl 1990, Fig. 80 (618, 621)
- # Hama E1 Riis & Buhl 1990, 130 (Form XXXIIB1)
- # Hama E1 Riis & Buhl 1990, 130 (Form XXXIIB2)
- Hama E1 Riis & Buhl 1990, Fig. 80 (620)
- # Tell Abou Danne Id/A6 Lebeau 1983, Pl. 89.8
- # Tell Abou Danne Id/A6 Lebeau 1983, Pls 90.6, 8
- Tell Judeideh IV see Lehmann 1996, 360 (Form 4)
- Tell Mastuma Central Area level I-2 Egami & Masuda 1984, Pl. 6.11
- # Tell Mishrife Iron II Unpublished
- # Tell Nebi Mend Trench V level B Unpublished
- # Tell Nebi Mend Trench V level C Unpublished
- Tell Rifa'at 2b-c Matthers 1981b, Fig. 233.3
- Iron III**
- # Tell Rifa'at 2a see Lehmann 1996, 360 (Form 2)
- # Tell Rifa'at 2a see Lehmann 1996, 361 (Form 4)
- # Tell Rifa'at 2a see Lehmann 1996, 361 (Form 4)
- Unclear Context**
- # Tell Mishrife Unstrat. du Mesnil du Buisson 1927, Pl. 82.94
- Tell Nebi Mend Unstrat. Pezard 1931, Pl. 24.1b
- # Tell Nebi Mend Unstrat. Pezard 1931, Pl. 24.1c
- # Tell Nebi Mend Unstrat. Pezard 1931, Pl. 27.1.2-3
- # Tell Rifa'at Unstrat. see Lehmann 1996, 361 (Form 4)

## **B.17.34 CLASS 167**

### **Iron I**

- Hazor Iron I Ben Tor *et al.* 1997, Fig. II.34 (4)

### **Iron I-II**

- Tell Mastuma Central Area level I Egami *et al.* 1984, Fig. 6.10

### **Iron II**

- Hama Cem. III Riis 1948, Fig. 117
- Hazor VI Yadin *et al.* 1958, Pl. 51.29
- Hazor VI Yadin *et al.* 1960, Pl. 67.10
- Hazor VI Yadin *et al.* 1961, Pl. 182.20
- # Megiddo IVA Lamon & Shipton 1939, Fig. 25.69

### **Iron II-III**

- # Al Mina VIII Lehmann 1996, Pl. 31 (185/1)
- # Tell Tayinat Building phase 3 Culican 1982, Pl. 7d

### **Iron III**

- # Megiddo II/III Lamon & Shipton 1939, Fig. 25.69
- # Sarepta Tomb 26 Culican 1970, Fig. 3.3
- Tell Ahmar Area C level 2 Jamieson 1999, Fig. 6.14
- Zincirli Iron III Andrae 1943, 51

### **Unclear Context**

- Athlit Cremation cem. Johns 1938, Fig. 10.1
- # Sidon Unstrat. Contenau 1920, Fig. 27e
- Tell Tayinat Unstrat. see Culican 1970, 16

## **B.17.35 CLASS 168**

### **Iron I**

- Hama Cem. I Riis 1948, Fig. 101
- Hama Cem. II Riis 1948, Fig. 101
- Hama F2 Riis & Buhl 1990, Fig. 74 (523, 526)
- Tell el Ghassil Area I level 5 Joukowsky 1972, Pl. 12.23
- Tell Kazel Area I level 15 Badre & Gubel 1999-2000, Fig. 6.f



Tell Kazel Area II level 5 Capet 2003, Fig. 40.h  
 Tell Kazel Area IV level 5 Badre & Gubel 1999-2000, Fig. 31.i  
 \* Tell Qarqur 9 Unpublished  
 Tell Tayinat Iron I Unpublished  
 Tyre XII Bikai 1978b, Pl. 32.11

**Iron I-II**  
 Tel Beth Shan Northern cem. Oren 1973, Fig. 46.1  
 # Tell Kazel Area I levels 14-16 Badre & Gubel 1999-2000, Fig. 6.e

**Iron II**  
 Ain Dara Lower Mound Iron II Stone & Zimansky 1999, Fig. 74.2  
 # Chatal Höyük III Swift 1958, Fig. 29  
 # Chatal Höyük III Swift 1958, Fig. 30  
 Hama Cem. III Riis 1948, Fig. 101  
 Hama Cem. IV Riis 1948, Fig. 101  
 Hazor V Yadin *et al.* 1960, Pl. 81.11-12  
 # Hazor V Yadin *et al.* 1961, Pl. 189.2  
 Hazor V Yadin *et al.* 1961, Pl. 225.16-17  
 # Hazor V Yadin *et al.* 1961, Pl. 225.23  
 Hazor VI Yadin *et al.* 1960, Pl. 66.16  
 # Hazor VI Yadin *et al.* 1961, Pl. 181.38  
 # Hazor VI Yadin *et al.* 1961, Pl. 219.6  
 # Hazor VII Yadin *et al.* 1961, Pl. 180.4, 6  
 # Hazor VIII Yadin *et al.* 1961, Pl. 213.25  
 # Megiddo IVA Lamon & Shipton 1939, Fig. 24.43  
 Megiddo IVA Lamon & Shipton 1939, Fig. 24.40  
 # Ras al-Bassit Findgroup A Braemer 1986, Fig. 1.2  
 \* Tel Beth Shan IV James 1966, Fig. 39.3  
 Tel Beth Shan V upper James 1966, Fig. 63.4  
 Tell Afis Area B (Afis VIII) Scigliuzzo 2002, Fig. 12.10  
 Tell Afis Area E2 level 2 Degli Esposti 1998, Fig. 10.1  
 Tell Arqa 10CD Unpublished  
 Tell Jurn Kabir Findgroup B Eidem and Ackermann 1999, Fig. 6.7  
 Tell Kazel Area II level 4 Badre *et al.* 1994, Fig. 28.d  
 Tell Mastuma Central Area level I-2 Wakita *et al.* 1995, Fig. 7.5  
 Tell Mastuma South Area Wada 1994, Fig. 1.1-2  
 Tell Rifa'at 2b-c Seton Williams 1967, Fig. 1.b  
 Tell Tayinat Building phase 2 see Lehmann 1996, 360 (Form 1)  
 Tell Tayinat Iron II see Lehmann 1996, 360 (Form 1)

**Iron II-III**  
 Tell Tayinat Building phase 3 see Lehmann 1996, 360 (Form 1)

**Iron III**  
 Megiddo II/III Lamon & Shipton 1939, Fig. 24.40-41  
 # Megiddo II/III Lamon & Shipton 1939, Fig. 24.42-43  
 Tell Afis Area Gc level 7b Cecchini 1998, Fig. 22.1  
 Tell Ahmar Area C level 2 Jamieson 1999, Fig. 6.8  
 Tell Ahmar Area C level 2 Jamieson 2000, Fig. 2.20  
 Tell Ahmar Area C level 2 Jamieson 2005, Fig. 4.1.6

**Unclear Context**  
 Ain Dara Unstrat. Stone & Zimansky 1999, Fig. 74.1  
 Athlit Cremation cem. Johns 1938, Fig. 16.3  
 Jerablus Yunus cem. Woolley 1939b, Pl. 23.B14  
 Tell Judeideh Unstrat. see Lehmann 1996, 360 (Form 1)  
 Tell Rifa'at 2-3 (Iron Age) Seton Williams 1961, Pl. 38.3  
 Tell Tayinat Unstrat. see Lehmann 1996, 360 (Form 1)

## **B.17.36 CLASS 169**

### **Iron I**

Hama F2 Riis & Buhl 1990, Fig. 74 (520-522, 524)

Tell Kazel Area II level 5 Badre 1990b, Fig. 41.e  
Tell Kazel Area II level 5 Capet 2003, Fig. 45.j-k  
Tell Kazel Area II level 6 Badre *et al.* 1994, Fig. 45.f  
Tell Kazel Area II level 6 Badre *et al.* 1994, Fig. 59.b  
Tell Kazel Area II level 6 Capet 2003, Fig. 8.i-j  
Tell Kazel Area II level 6 Capet 2003, Fig. 25.e-f  
Tell Kazel Area IV level 5 Badre & Gubel 1999-2000, Figs 31.d, h; 34.i-j  
Tell Qarqur 9 Unpublished

#### **Iron I-II**

# Tell Qarqur 8-9 Dornemann 2003a, Fig. 88.2

#### **Iron II**

# Hazor IV Yadin *et al.* 1958, Pl. 69.18  
Hazor IV Yadin *et al.* 1960, Pl. 98.17  
Hazor V Yadin *et al.* 1960, Pl. 79.12  
# Hazor V Yadin *et al.* 1961, Pl. 222.15-16  
Hazor V Yadin *et al.* 1961, Pl. 223.3-5  
# Hazor V Yadin *et al.* 1961, Pl. 223.6-8  
# Hazor V Yadin *et al.* 1961, Pl. 251.7  
# Hazor VI Yadin *et al.* 1958, Pl. 51.13  
# Hazor VI Yadin *et al.* 1960, Pl. 66.18  
Hazor VI Yadin *et al.* 1960, Pl. 66.19  
# Hazor VI Yadin *et al.* 1961, Pl. 181.25  
# Hazor VI Yadin *et al.* 1961, Pl. 220.3-4  
Hazor VII Yadin *et al.* 1960, Pl. 63.19  
# Hazor VII Yadin *et al.* 1961, Pl. 214.3  
Hazor VII Yadin *et al.* 1961, Pl. 214.29-30  
Hazor VIII Yadin *et al.* 1958, Pl. 47.7  
# Megiddo Area H level 3 (IVA) Finkelstein *et al.* 2000b, Fig. 11.43(10)  
# Megiddo Area H level 3 (IVA) Finkelstein *et al.* 2000b, Fig. 11.52(3)  
# Tel Beth Shan IV James 1966, Fig. 38.2  
Tel Dan II Pakman 1992, Fig. 1.1  
Tel Dan III Biran 1996b, Fig. 7.1-3  
Tell Abou Danne IId/A6 Lebeau 1983, Pl. 1.4  
Tell Afis Area E2 level 1 Degli Esposti 1998, Fig. 10.2  
Tell Nebi Mend Trench V Level C Unpublished  
Tell Qarqur 8 Unpublished

#### **Iron II-III**

# Beirut Bey 003 abandonment Badre 1997b, Fig. 36.8  
Beirut Bey 003 abandonment Badre 1997b, Fig. 37.5  
Deve Höyük Cem. I Moorey 1980, Fig. 3.8

#### **Iron III**

# Ras al-Bassit Findgroup H Braemer 1986, Fig. 8.41  
Tell Abou Danne IIc/A5 Lebeau 1983, 100.2  
Tell Afis Area D level 1 Mazzoni 1988a, Fig. 8.1  
Tell Ahmar Area C level 2 Jamieson 2005, Fig. 4.1.7

#### **Unclear Context**

Athlit Cremation cem. Johns 1938, Fig. 16.2

## **B.17.37 CLASS 170**

#### **Iron I**

Hazor IX Yadin *et al.* 1961, Pl. 208.6, 21  
Hazor IX/X Yadin *et al.* 1958, Pl. 45.7  
\*\* Hazor IX/X Yadin *et al.* 1961, Pl. 177.11  
Hazor IX/X Yadin *et al.* 1961, Pl. 210.2  
Hazor Iron I Ben Ami 2001, Fig. 5.5  
\* Khalde Cem. IV Saidah 1966, No. 44  
# Megiddo Area K level 3 (VB) Finkelstein *et al.* 2000b, Fig. 11.18(11)  
Megiddo VIB Loud 1948, Fig. 74.5

### Pella Iron I Unpublished

- Sarepta Area X level V Khalifeh 1988, Type X17  
Sarepta Area X level VI Khalifeh 1988, Type X17  
\*\* Sarepta Area Y level F Anderson 1988, Pl. 29.15-16  
Sarepta Area Y level F Anderson 1988, Pl. 29.19  
Sarepta Area Y level G Anderson 1988, Pl. 26.13  
Sarepta Area Y level G Anderson 1988, Pl. 27.13-14  
\*\* Tell Abu Hawam IV Hamilton 1935, 30, No. 165  
Tell Afis Area E1 level 9c Venturi 1998a, Fig. 5.8  
Tell Afis Area E1 level 9c Pedrazzi 2002, Fig. 23.12  
\* Tell Keisan 9c Briend & Humbert 1980, Pl. 11  
Tell Mastuma Central Area level I-3 Egami & Masuda 1984, Pl. 6.7  
Tell Qarqur 9 Unpublished  
\* Tyre XI Bikai 1978b, Pl. 29.8  
Tyre XII Bikai 1978b, Pl. 31.7  
\* Tyre XIII Bikai 1978b, Pl. 33.11

### Iron I-II

- Tel Beth Shan V James 1966, Fig. 20.2  
Tell Mishrife Iron I/II Unpublished  
Tell Qarqur 8-9 Dornemann 2003a, Fig. 88.4

### Iron II

- # Hazor IV Yadin *et al.* 1961, Pl. 254.9  
# Hazor V Yadin *et al.* 1958, Pl. 54.13  
Hazor V Yadin *et al.* 1958, Pl. 67.13  
# Hazor V Yadin *et al.* 1958, Pl. 67.18  
Hazor V Yadin *et al.* 1958, Pl. 74.6  
Hazor VII Ben Tor *et al.* 1997, Fig. III.30 (12)  
Hazor VIII Yadin *et al.* 1960, Pl. 54.3  
\*\* Sidon Iron II Doumet-Serhal 2006, Fig. 31.16  
Sidon Iron II Doumet-Serhal 2006, Fig. 31.12-15  
# Sarepta Area Y level D Anderson 1988, Pl. 32.13  
Tell Abou Danne IId/A6 Lebeau 1983, Pls 8.3-4; 9.4-5; 11.1  
Tell Afis Area L level 7 D'Amore 1998a, Fig. 6.15  
# Tell Arqa 10 Unpublished  
Tell Judeideh IV see Lehmann 1996, 363 (Form 16)  
Tell Judeideh IV see Lehmann 1996, 364 (Form 22)  
\* Tell Mastuma Central Area level I-2 Egami 1988, Pl. 17.5  
# Tell Nebi Mend Trench V level B Unpublished  
\* Tell Nebi Mend Trench V level C Unpublished  
Tell Nebi Mend Trench V level C Unpublished  
# Tell Qarqur 8 Unpublished  
Tell Rifa'at 2b-c Seton Williams 1967, Fig. 2.a  
Tell Rifa'at 2b-c Lehmann 1996, Pl. 4 (16/2+3)  
Tell Rifa'at 2b-c Lehmann 1996, Pl. 8 (48/1)  
Tell Sheikh Hassan 3 Schneider 1999a, Fig. 6.8(2)  
# Tyre III Bikai 1978b, Pl. 11.17  
Tyre IV Bikai 1978b, Pl. 16.15

### Iron II-III

- Qraye S. V. Chapman 1972, Fig. 24.293 Iron II-III  
Sarepta Area X level VIII Khalifeh 1988, Type X17 Iron II-III  
Sarepta Area Y level C Anderson 1988, Pl. 37.5, 8 Iron II-III  
Tell Shiyuk Fawqani Area F (IX) Makinson 2005, Pl. 2.10 Iron II-III  
Tell Shiyuk Fawqani Area G level 3 Luciani 2005, Pl. 1.4 Iron II-III

### Iron III

- \* Tell Abou Danne IIc/A5 Lebeau 1983, Pl. 101.2, 5  
Tell Abou Danne IIc/A5 Lebeau 1983, Pls 101.3-4; 102.1  
Tell Afis Area D level 2 Mazzoni 1988a, Fig. 9.9  
Tell Afis Area Gc level 6 Cecchini 1998, Fig. 27.4  
# Tell Afis Area Gc level 7b Cecchini 1998, Fig. 20.12  
# Tell Keisan 5 Briend & Humbert 1980, Pl. 40.8

# Tell Rifa'at 2a Lehmann 1996, Pl. 5 (22/2)

**Iron I-Persian**

# Akhziv East Cem IX Dayagi-Mendels 2002, Fig. 4.7(22)

**Unclear Context**

Sarepta Area X unstrat. Pritchard 1988, Fig. 38.17

Sarepta Area X unstrat. Pritchard 1988, Fig. 39.24

Tell Tayinat Unstrat. Unpublished

## **B.17.38 CLASS 171**

**Iron I-II**

Tell Qarqur 8-9 Dornemann 2003a, Fig. 88.6

**Iron II**

Hazor VII Ben Tor *et al.* 1997, Fig. III.32 (2)

Hazor VIII Yadin *et al.* 1958, Pl. 47.5

Tell Afis Area D level 4 Mazzoni 1988a, Fig. 16.10

Tell Nebi Mend Trench V Level B Unpublished

Tell Nebi Mend Trench V Level C Unpublished

Tell Sheikh Hassan 3 Schneider 1999a, Fig. 4.1(1-2)

Tell Sheikh Hassan 3 Schneider 1999a, Fig. 4.3

**Iron II-III**

Akhziv East Cem XXIX Dayagi-Mendels 2002, Fig. 4.21(3)

**Iron III-Persian**

Tell Keisan II/III Seton-Williams 1980, Pl. 109.2

**Persian**

Tell Abu Hawam II Hamilton 1935, Fig. 4

## **B.17.39 CLASS 172**

### **B.17.39.1 CLASS 172a**

**Iron I**

Beirut Bey 003 LB/Iron Badre 1997b, Fig. 33.4

Hazor IX Yadin *et al.* 1961, Pl. 175.1

# Hazor IX Yadin *et al.* 1961, Pl. 178.2

Hazor IX Yadin *et al.* 1961, Pl. 208.1-2, 4, 28

\*\* Hazor IX Yadin *et al.* 1961, Pl. 212.5

# Hazor IX Yadin *et al.* 1961, Pl. 212.6

Hazor IX/X Unpublished

Hazor XII Yadin *et al.* 1961, Pl. 146.12-13, 15-18

\* Megiddo VB Lamon & Shipton 1939, Fig. 31.144

Megiddo VIB Loud 1948, Fig. 74.7

# Pella Area III level I McNicoll *et al.* 1992, Pl. 49.4-5

Pella Iron I Unpublished

Ras Ibn Hani Iron I Bounni *et al.* 1979, 249, Fig. 25.4-6

Sarepta Area Y level G Anderson 1988, Pl. 26.11

Tel Dan V Biran 1989b, Fig. 22.1

Tell Afis Area E1 level 3 Mazzoni 1992b, Fig. 9.9

Tell Afis Area Ge level 3 Cecchini 1998, Fig. 14.19

# Tell Kazel Area II level 5 Capet 2003, Fig. 36.j

\*\* Tell Keisan 9c Briand & Humbert 1980, Pl. 80.11

**Iron I-II**

# Megiddo VA-IVB Loud 1948, Fig. 89.13

Megiddo Area K level 2 (VA-IVB) Finkelstein *et al.* 2000b, Fig. 11.20(2)

# Megiddo Area K level 2 (VA-IVB) Finkelstein *et al.* 2000b, Fig. 11.20(3-4, 6)

\* Pella Area III level O McNicoll *et al.* 1992, Pl. 67.2

Tell Mishrife Iron I/II Unpublished

Tyre X Bikai 1978b, Pl. 27.3-4

## Iron II

- Akhziv South Cem XVI Dayagi-Mendels 2002, Fig. 3.12(1)  
Akhziv South Cem 73 E. Mazar 2001, Fig. 43.3  
# Beirut Bey 003 glacis II Badre 1997b, Fig. 35.7-8  
Hazor IV Yadin *et al.* 1960, Pl. 98.35  
# Hazor V Yadin *et al.* 1958, Pl. 54.10  
# Hazor V Yadin *et al.* 1960, Pl. 79.6  
# Hazor V Yadin *et al.* 1960, Pl. 82.6  
# Hazor V Yadin *et al.* 1961, Pl. 189.9  
Hazor V Yadin *et al.* 1961, Pl. 231.14  
# Hazor V Yadin *et al.* 1961, Pl. 231.17  
Hazor VI Yadin *et al.* 1958, Pl. 51.5  
# Hazor VI Yadin *et al.* 1961, Pl. 181.14-15, 20-22  
# Hazor VII Yadin *et al.* 1958, Pl. 49.25  
# Hazor VII Yadin *et al.* 1960, Pl. 63.33  
# Hazor VIII Yadin *et al.* 1960, Pl. 53.5  
Hazor VIII Yadin *et al.* 1960, Pl. 53.13  
Khalde Tomb 4 Saidah 1966, No. 16  
# Megiddo Area H level 3 (IVA) Finkelstein *et al.* 2000b, Fig. 11.43(2)  
#\* Sidon Iron II Doumet-Serhal 2006, Fig. 25.17  
#\* Sarepta Area Y level D Anderson 1988, Pl. 33.14  
Tel Beth Shan IV James 1966, Fig. 67.27  
Tel Beth Shan V upper James 1966, Fig. 63.2  
Tel Jezreel Findgroup A Zimhoni 1997a, Fig. 1.7 (4)  
Tel Jezreel Findgroup C Zimhoni 1997a, Fig. 1.8 (2)  
# Tell Arqa 10 Thalmann 1983, Fig. 1.3  
# Tell Arqa 10AB Thalmann 1978a, Fig. 6.3  
# Tell Arqa 10AB Thalmann 1978b, Fig. 47.6-7  
# Tell Kazel Area I levels 6-13 Badre & Gubel 1999-2000, Fig. 5.e  
# Tell Kazel Area II level 4 Badre 1990b, Fig. 37.b  
\*\* Tell Keisan 7 Briend & Humbert 1980, Pl. 53.6  
Tell Keisan 8 Briend & Humbert 1980, Pl. 55.12  
\* Tell Mastuma South Area Wada 1994, Fig. 1.9  
Tell Nebi Mend Trench V Level B Unpublished  
Tell Qarqur 8 Unpublished  
# Tell Rachidiah Tomb IV Doumet 1982, Pl. XVI.56  
Tell Rifa'at 2b-c Lehmann 1996, Pl. 20 (108/1)  
# Tyre II Bikai 1978b, Pl. 11.19  
# Tyre III Bikai 1978b, Pl. 10.19  
# Tyre IV Bikai 1978b, Pl. 15.6, 23  
Tyre IV Bikai 1978b, Pl. 15.24  
Tyre V Bikai 1978b, Pl. 18.2  
# Tyre VIII Bikai 1978b, Pl. 19.24  
# Tyre IX Bikai 1978b, Pl. 19.25-26

## Iron I-III

- Akhziv South Cem XI Dayagi-Mendels 2002, 23 (6-7)  
# Akhziv South Cem XI Dayagi-Mendels 2002, Fig. 3.10(5)

## Iron II-III

- Al Mina VIII Lehmann 1996, Pl. 17 (85c2)  
# Qraye S. V. Chapman 1972, Fig. 28.304  
# Sarepta Area Y level C Anderson 1988, Pl. 35.10  
Tell Judeideh IV/III see Lehmann 1996, 388 (Form 155)

## Iron III

- \*\* Al Mina VIII-V du Plat Taylor 1959, Fig. 1.17  
\*\* Megiddo II/III Lamon & Shipton 1939, Fig. 23.25  
# Ras al-Bassit Findgroup F Braemer 1986, Fig. 6.33  
# Ras al-Bassit Findgroup G Braemer 1986, Fig. 7.39  
# Tell Afis Area Gc level 5 Cecchini 1998, Fig. 29.18  
# Tell Arqa 9 Thalmann 1978b, Fig. 46.11  
Tell Judeideh III see Lehmann 1996, 376 (Form 85c)

Tell Judeideh III see Lehmann 1996, 388 (Form 155)  
# Tell Keisan 4 Briend & Humbert 1980, Pl. 29.7  
# Tell Keisan 5 Briend & Humbert 1980, Pl. 40.7b-c  
Tyre Al-Bass cem. V Núñez 2004a, Fig. 57.17

#### **Iron II-Persian**

Akhziv South Cem 72 E. Mazar 2001, Fig. 64.6

#### **Iron III-Persian**

\*\* Tell Keisan II/III Seton-Williams 1980, Pl. 109.13

#### **Persian**

Sidon Persian Doumet-Serhal 2006, Fig. 22.25

#### **Unclear Context**

\* Al Mina Unstrat. Lehmann 1996, Pl. 24 (155/3)

Jerablus Yunus cem. Woolley 1939b, Pl. 23.B27

Zincirli Unstrat. Andrae 1943, Pl. 25p

### **B.17.39.2 CLASS 172b**

#### **Iron I**

Hazor IX/X Yadin *et al.* 1958, Pl. 45.4

# Hazor IX/X Yadin *et al.* 1958, Pl. 45.5

# Hazor IX/X Yadin *et al.* 1961, Pl. 210.6

# Hazor IX/X Yadin *et al.* 1961, Pl. 212.9-10

Hazor IX/X Unpublished

Megiddo VB Lamon & Shipton 1939, Fig. 30.131

# Megiddo VB Lamon & Shipton 1939, Fig. 30.133

Pella Iron I Unpublished

Sarepta Area X level V Khalifeh 1988, Type X29

Sarepta Area X level VI Khalifeh 1988, Type X29

Sarepta Area Y level E Anderson 1988, Pl. 31.12

Sarepta Area Y level F Anderson 1988, Pl. 29.17

# Tel Beth Shan V lower James 1966, Fig. 59.9

Tel Beth Shan VI upper Yadin & Geva 1986, Fig. 11.1

Tell Afis Area E1 level 4 Mazzoni 1992b, Fig. 10.2

Tell Afis Area E2 level 4 Degli Esposti 1998, Fig. 7.9

Tell Jurn Kabir Findgroup A Eidem and Ackermann 1999, Fig. 9b.2

Tell Keisan 9a/b Briend & Humbert 1980, Pl. 66.4-4e

Tell Keisan 11/10 Briend & Humbert 1980, Pl. 81.16

Tell Keisan IV/V Seton-Williams 1980, Pl. 110.11-12

Tell Qarqur 9 Unpublished

Tyre XI Bikai 1978b, Pl. 29.4

\*\* Tyre XIII Bikai 1978b, Pl. 33.2, 5

Tyre XIII Bikai 1978b, Pl. 33.7-8

Tyre XIII Bikai 1978b, Pl. 37.11

\* Tyre XIV Bikai 1978b, Pl. 39.23

#### **Iron I-II**

\* Byblos Necropolis K Salles 1980, Pl. 11.9

Megiddo VA-IVB Lamon & Shipton 1939, Fig. 30.131

Sarepta Area X level VII Khalifeh 1988, Type X29

Sarepta Area Y level C Anderson 1988, Pl. 35.20

# Tyre X Bikai 1978b, Pl. 23.4

\* Tyre X Bikai 1978b, Pl. 23.19

Tyre X Bikai 1978b, Pl. 26.5, 7

#### **Iron II**

Ain Dara Lower Iron II Stone & Zimansky 1999, Fig. 10.5

\* Beirut Bey 003 glacis II Badre 1997b, Fig. 35.11

Beirut Bey 003 glacis II Badre 1998, Fig. 6.6

Hazor IV/V Yadin *et al.* 1958, Pl. 71.4

\* Hazor V Yadin *et al.* 1958, Pl. 53.10

# Hazor V Yadin *et al.* 1958, Pl. 54.12

Hazor V Yadin *et al.* 1958, Pl. 67.10  
 # Hazor V Yadin *et al.* 1958, Pl. 73.16  
 Hazor V Yadin *et al.* 1961, Pl. 222.8  
 # Hazor V Yadin *et al.* 1961, Pl. 251.28  
 Hazor VI Yadin *et al.* 1958, Pl. 51.15  
 # Hazor VII Yadin *et al.* 1960, Pl. 63.7  
 Hazor VIII Yadin *et al.* 1958, Pl. 47.4  
 Hazor VIII Ben Tor *et al.* 1997, Fig. III.24 (15)  
 \*\* Joya S. V. Chapman 1972, Fig. 25.258  
 Megiddo Area H level 3 (IVA) Finkelstein *et al.* 2000b, Fig. 11.52(2)  
 # Ras al-Bassit Findgroup C Braemer 1986, Fig. 3.12  
 Sidon Iron II Doumet-Serhal 2004g, Pl. 14.2  
 \* Sidon Iron II Doumet-Serhal 2004g, Pl. 14.3  
 Sidon Iron II Doumet-Serhal 2006, Fig. 25.2  
 \* Sidon Iron II Doumet-Serhal 2006, Fig. 25.15-16  
 Sidon Iron II Doumet-Serhal 2006, Fig. 29.7-9  
 Sarepta Area Y level D Anderson 1988, Pl. 32.16  
 # Sarepta Area Y level D Anderson 1988, Pl. 33.7, 9  
 Tel Dan II Biran 1999, Fig. 7.2-3  
 # Tel Jezreel Iron II Zimhoni 1997b, Fig. 2.3 (5)  
 Tel Jezreel Iron II Zimhoni 1997b, Fig. 2.3 (8-9)  
 Tell Abou Danne IId/A6 Lebeau 1983, Pl. 8.2  
 # Tell Abou Danne IId/A6 Lebeau 1983, Pl. 14.1-2  
 # Tell Afis Area E2 level 1 Degli Esposti 1998, Fig. 10.5  
 Tell Afis Area E2 level 1 Degli Esposti 1998, Fig. 10.13  
 # Tell Afis Area Gc level 8a Cecchini 1998, Fig. 19.4  
 # Tell Afis Area Gc level 8b Cecchini 1998, Fig. 18.4  
 # Tell Afis Area L level 7 D'Amore 1998a, Fig. 6.16  
 # Tell Arqa 10CD Thalmann 1978b, Fig. 47.3  
 Tell Jurn Kabir Findgroup B Eidem and Ackermann 1999, Fig. 6.8  
 \*\* Tell Keisan 7 Briend & Humbert 1980, Pl. 53.4  
 Tell Keisan 8 Briend & Humbert 1980, Pl. 55.11-11a, 14  
 Tell Nebi Mend Trench V Level B Unpublished  
 Tell Nebi Mend Trench V Level C Unpublished  
 \* Tell Nebi Mend Trench V Level C Unpublished  
 Tell Qarqur 8 Unpublished  
 # Tell Rachidiah Tomb IV Doumet 1982, Pl. XVII.10  
 Tell Sheikh Hassan 3 Schneider 1999a, Fig. 6.8(1)  
 #\* Tyre IV Bikai 1978b, Pl. 15.12  
 # Tyre IV Bikai 1978b, Pl. 15.16-17  
 Tyre V Bikai 1978b, Pl. 18.11  
 Tyre VIII Bikai 1978b, Pl. 19.7  
 \*\* Tyre VIII Bikai 1978b, Pl. 19.17

#### **Iron II-III**

Akhziv East Cem XXIX Dayagi-Mendels 2002, Fig. 4.21(8)  
 Akhziv TC2 E. Mazar 2001, Fig. 20b.8, 15  
 # Al Mina VIII du Plat Taylor 1959, Fig. 6.6, 38  
 Sarepta Area X level VIII Khalifeh 1988, Type X29  
 # Ras Ibn Hani Iron II/III Bounni *et al.* 1976a, Fig. 27.12  
 Tell Judeideh IV/III see Lehmann 1996, 379 (Form 104)  
 Tell Shiyuk Fawqani Area F (IX) Makinson 2005, Pl. 1.4

#### **Iron III**

#\* Al Mina VIII-V du Plat Taylor 1959, Fig. 5.4  
 \* Hazor III Yadin *et al.* 1958, Pl. 77.2  
 Ras al-Bassit Cem. Courbin 1993a, Fig. 20.1(V634)  
 # Tell Afis Area D level 2 Mazzoni 1988a, Fig. 9.12  
 Tell Afis Area Gc level 2 Cecchini 1998, Fig. 35.8-9  
 # Tell Afis Area Gc level 4 Cecchini 1998, Fig. 31.4, 6-8  
 Tell Afis Area Gc level 4 Cecchini 1998, Fig. 31.23  
 # Tell Afis Area Gc level 5 Cecchini 1998, Fig. 29.5-7

# Tell Afis Area Gc level 6 Cecchini 1998, Fig. 26.12-13  
Tell Afis Area Gc level 6 Cecchini 1998, Fig. 27.2  
# Tell Afis Area Gc level 7b Cecchini 1998, Fig. 20.16, 18-19  
Tell Afis Area Gc level 7b Cecchini 1998, Fig. 22.4-5, 11  
# Tell Judeideh III see Lehmann 1996, 379 (Form 104)  
Tell Keisan 4 Briend & Humbert 1980, Pl. 29.5  
# Tell Keisan 4 Briend & Humbert 1980, Pl. 29.9  
Tell Keisan 4 Briend & Humbert 1980, Pl. 30.7  
Tell Keisan 5 Briend & Humbert 1980, Pl. 41.11a-b  
# Tell Keisan 5 Briend & Humbert 1980, Pl. 41.11c  
\*\* Tell Keisan 5 Briend & Humbert 1980, Pl. 41.14  
# Tell Rifa'at 2a Lehmann 1996, Pl. 19 (104/1)

#### **Iron II-Persian**

\*\* Akhziv South Cem 68 E. Mazar 2001, Fig. 52.9  
Akzhiv South Cem 72 E. Mazar 2001, Fig. 64.17

#### **Persian**

Sidon Persian Doumet-Serhal 2006, Fig. 22.10-11  
Tell Shiyuk Fawqani Area G level 1 Luciani 2005, Pl. 35.428  
Tille Höyük X Blaylock 1999, Fig. 13.16

#### **Unclear Context**

Sarepta Area X unstrat. Pritchard 1988, Fig. 38.5-6  
Sarepta Area X unstrat. Pritchard 1988, Fig. 39.21, 23  
Tell Abu Hawam III Hamilton 1935, 21, No. 71  
Tell Abu Hawam III Hamilton 1935, 21, No. 73  
# Tell Mishrife Unstrat. du Mesnil du Buisson 1935, Fig. 1.2  
Tell Rifa'at Unstrat. see Lehmann 1996, 380 (Form 104)

## **B.17.40 CLASS 173**

#### **Iron I-II**

# Tell Mishrife Operation H levels 5-6 Barro 2002, Fig. 107.1  
# Tell Mishrife Iron I/II Unpublished

#### **Iron II**

# Tell Abou Danne IId/A6 Lebeau 1983, Pl. 1.3  
# Tell Afis Area D level 4 Mazzoni 1988a, Fig. 15.4  
Tell Afis Area D level 4 Mazzoni 1988a, Fig. 15.5; Cecchini 1988, Fig. 8.13-15  
# Tell Afis Area Gc level 8a Cecchini 1998, Fig. 19.1  
# Tell Nebi Mend Trench V level B Unpublished  
# Tell Nebi Mend Trench V level C Unpublished  
Tell Nebi Mend Trench V level C Unpublished  
# Tell Qarqur 8 Dornemann 2003a, Fig. 81.1-8, 11-13, 15  
# Tell Rifa'at 2b-c Matthers 1981b, Fig. 233.2

#### **Iron II-III**

# Tyre Al-Bass cem. IV Núñez 2004a, Fig. 75.14

#### **Iron III**

# Tell Abou Danne IIc/A5 Lebeau 1983, Pl. 100.3-4  
# Tell Afis Area Gc level 7b Cecchini 1998, Fig. 20.7  
# Tell Rifa'at 2a Lehmann 1996, Pl. 2 (4/5)  
# Tell Rifa'at 2a Lehmann 1996, Pl. 2 (4/6)  
Tell Rifa'at 2a Lehmann 1996, Pl. 2 (4/8)

#### **Unclear Context**

# Tell Rifa'at 2-3 (Iron Age) Lehmann 1996, Pl. 2 (4/4+7)

## **B.17.41 CLASS 174**

#### **Iron I**

Hazor IX Yadin *et al.* 1961, Pl. 208.32  
# Hazor IX/X Yadin *et al.* 1958, Pl. 45.6



# Hazor Iron I Ben Ami 2001, Fig. 5.3  
 Kamid el-Lawz Iron I Marfoe 1995, Fig. 105.1  
 Pella Iron I Unpublished  
 IMP Ras al-Bassit Unstrat. Courbin 1982a, Fig. 4  
 Sarepta Area Y level F Anderson 1988, Pl. 29.14  
 Sarepta Area Y level G Anderson 1988, Pl. 27.15  
 \* Tell Afis Area E1 level 5 Mazzoni 1998a, Fig. 19.11  
 \*\* Tell Afis Area E1 level 7 Venturi 2000a, Fig. 11.8  
 Tell Afis Area E1 level 7 Venturi 2000a, Fig. 12.3  
 Tell Afis Area E1 level 9b Venturi 2000a, Fig. 6.7  
 \* Tell Afis Area E1 level 9c Pedrazzi 2002, Fig. 23.9  
 Tell Afis Area E1 level 9c Pedrazzi 2002, Fig. 23.11  
 # Tell Kazel Area II level 5 Badre 1990b, Fig. 41.c  
 Tell Qarqur 9 Unpublished

**Iron I-II**  
 \* Tell el Ghassil Area I level 4 Joukowsky 1972, Pl. 8.19  
 Tell Mishrife Iron I/II Unpublished  
 # Tell Mishrife Iron I/II Unpublished  
 # Tell Qarqur 8-9 Dornemann 2003a, Fig. 88.1  
 IMP Tyre X Bikai 1978b, Pl. 24.5

**Iron II**  
 # Hazor V Yadin *et al.* 1958, Pl. 74.4  
 # Hazor VII Yadin *et al.* 1961, Pl. 214.15  
 #\* Hazor VII Yadin *et al.* 1961, Pl. 214.17  
 Hazor VII Ben Tor *et al.* 1997, Fig. III.32 (1)  
 # Hazor VII Ben Tor *et al.* 1997, Fig. III.33 (1)  
 # Megiddo Area H level 3 (IVA) Finkelstein *et al.* 2000b, Fig. 11.43(12)  
 Ras al-Bassit Cem. Courbin 1993a, Fig. 9.2(C1078)  
 # Ras al-Bassit Findgroup A Braemer 1986, Fig. 1.3  
 Sidon Iron II Doumet-Serhal 2004g, Pl. 14.1  
 Sidon Iron II Doumet-Serhal 2006, Fig. 28.1-2  
 \*\* Sarepta Area Y level D Anderson 1988, Pl. 32.9-10  
 # Tell Abou Danne IId/A6 Lebeau 1983, Pls 3; 4.1-7; 5.1-6; 6.1-3, 5  
 Tell Afis Area D level 4 Cecchini 1988, Fig. 8.8-9  
 Tell Afis Area D level 6 Mazzoni 1988a, Fig. 21.9  
 # Tell Afis Area Gc level 8a Cecchini 1998, Fig. 19.2  
 Tell Judeideh IV see Lehmann 1996, 359 (Form 1-4)  
 \* Tell Mastuma South Area Wada 1994, Fig. 1.7  
 Tell Mishrife Operation C level II al Maqdissi 2003, Fig. 12.3  
 Tell Nebi Mend Trench V Level B Unpublished  
 \* Tell Nebi Mend Trench V Level B Unpublished  
 # Tell Qarqur 8 Dornemann 2003a, Fig. 81.9  
 # Tell Qarqur 8 Unpublished  
 Tell Qarqur 8 Unpublished  
 \* Tell Rifa'at 2b-c Seton Williams 1961, Pl. 38.7  
 # Tell Rifa'at 2b-c Matthers 1981b, Fig. 235.5  
 Tell Rifa'at 2b-c see Lehmann 1996, 360 (Form 1-4)  
 IMP Tyre II Bikai 1978b, Pl. 11.20  
 \*\* Tyre VIII Bikai 1978b, Pl. 19.18  
 \* Tyre VIII Bikai 1978b, Pl. 19.22  
 IMP Tyre IX Bikai 1978b, Pl. 22.5-6

**Iron II-III**  
 Akhziv TC2 E. Mazar 2001, Fig. 20b.13-14

**Iron III**  
 # Tell Afis Area Gc level 4 Cecchini 1998, Fig. 31.3  
 Tell Afis Area Gc level 5 Cecchini 1998, Fig. 29.19-20  
 \*\* Tell Afis Area Gc level 6 Cecchini 1998, Fig. 26.4  
 Tell Afis Area Gc level 6 Cecchini 1998, Fig. 27.6  
 Tell Afis Area Gn level 4 Cecchini 1998, Fig. 38.11  
 # Tell Arqa 9 Thalmann 1978b, Fig. 47.1

Tell Rifa'at 2a see Lehmann 1996, 360 (Form 1-4)

#### **Persian**

Sidon Persian Doumet-Serhal 2006, Fig. 22.7-8

Tell Rifa'at 1c see Lehmann 1996, 360 (Form 1-4)

Tell Shiyuk Fawqani Area G level 1 Luciani 2005, Pl. 32.375-376, 378

#### **Unclear Context**

Tell Rifa'at 2-3 (Iron Age) see Lehmann 1996, 360 (Form 1-4)

Tell Rifa'at Unstrat. see Lehmann 1996, 360 (Form 1-4)

## **B.17.42 CLASS 175**

### **Iron I**

Ain Dara Lower Mound Iron I Stone & Zimansky 1999, Fig. 27.13

Hazor IX Yadin *et al.* 1961, Pl. 212.11-12

Hazor X Ben Tor *et al.* 1997, Fig. III.23 (3)

# Megiddo Area K level 3 (VB) Finkelstein *et al.* 2000b, Fig. 11.18(8)

# Pella Iron I Unpublished

Sarepta Area X level V Khalifeh 1988, Type X25

Tell Afis Area E1 level 3 Mazzoni 1998a, Fig. 22.4-5

Tell Afis Area E1 level 9c Venturi 1998a, Fig. 5.6

Tell Afis Area E2 level 3 Degli Esposti 1998, Fig. 7.9

### **Iron I-II**

Tell Mishrife Operation K levels 8-4 Luciani 2002, Fig. 134.1

\* Tell Qarqur 8-9 Dornemann 2003a, Fig. 88.3

### **Iron II**

# Hazor IV/V Yadin *et al.* 1958, Pl. 71.8-9

# Hazor VI Yadin *et al.* 1961, Pl. 220.6

# Pella Iron II Unpublished

# Tell Abou Danne IId/A6 Lebeau 1983, Pl. 6.6

Tell Afis Area E2 level 2 Degli Esposti 1998, Fig. 10.16

# Tell Mastuma Central Area level I-2 Egami & Masuda 1984, Pl. 6.3

# Tell Mastuma South Area Wada 1994, Fig. 1.14

Tell Nebi Mend Trench V Level B Unpublished

Tell Nebi Mend Trench V Level C Unpublished

# Tell Rifa'at 2b-c Matthers 1981b, Fig. 235.4, 7

### **Iron II-III**

Tell Shiyuk Fawqani Area G level 3 Luciani 2005, Pl. 1.1

### **Iron III**

Tell Afis Area Gc level 4 Cecchini 1998, Fig. 31.20, 22

# Tell Afis Area Gc level 5 Cecchini 1998, Fig. 29.8-9

Tell Afis Area Gc level 5 Cecchini 1998, Fig. 29.19

# Tell Afis Area Gn level 3 Cecchini 1998, Fig. 38.20-21

Tell Afis Area Gn level 4 Cecchini 1998, Fig. 38.12

Tell Shiyuk Fawqani Area G level 2 Luciani 2005, Pl. 5.57, 60

### **Persian**

Tell Shiyuk Fawqani Area G level 1 Luciani 2005, Pl. 31.374

Tell Shiyuk Fawqani Area G level 1 Luciani 2005, Pl. 35.426-427

## **B.17.43 CLASS 176**

### **Iron I**

# Hazor IX/X Yadin *et al.* 1958, Pl. 45.9

# Hazor XI Yadin *et al.* 1961, Pl. 203.4

Hazor XI Yadin *et al.* 1961, Pl. 203.5

Pella Iron I Unpublished

\* Tell Abu Hawam V/IV Hamilton 1934, Pl. 22.4

\* Tell Afis Area E1 level 7 Venturi 2000a, Fig. 11.9

Tell Afis Area E1 level 7 Venturi 2000c, Fig. 9.9

Tell Afis Area E1 level 8 Venturi 1998a, Figs 5.1, 13.3  
 \* Tell Afis Area E1 level 8 Venturi 2000b, Fig. 12.6  
 Tell Afis Area E1 level 9a Venturi 1998a, Fig. 5.2, 11, 15  
 \* Tell Afis Area E1 level 9a Venturi 2000a, Fig. 7.7  
 Tell Afis Area E1 level 9b Venturi 1998a, Fig. 5.3, 11-12  
 Tell Afis Area E1 level 9c Venturi 1998a, Fig. 5.4, 12-13, 16  
 Tell Afis Area E1 level 9c Pedrazzi 2002, Fig. 23.10  
 Tell Afis Area E2 level 3 Degli Esposti 1998, Fig. 7.1  
 \* Tell Afis Area G (Iron IC) Canuti 2000, Fig. 17.5  
 Tell Jurn Kabir Findgroup A Eidem and Ackermann 1999, Fig. 4.9  
 Tell Qarqur 9 Unpublished  
 Tell Tayinat Iron I Unpublished  
 \*\* Tyre XIII Bikai 1978b, Pl. 37.9  
**Iron I-II**  
 # Tel Dan IV Biran 1982, Fig. 24.2  
 Tell Mishrife Operation K levels 8-4 Luciani 2002, Fig. 134.2  
 Tell Mishrife Iron I/II Unpublished  
**Iron II**  
 Ain Dara Lower Mound Iron II Stone & Zimansky 1999, Fig. 27.15, 17-18  
 \* Hazor IV/V Yadin *et al.* 1958, Pl. 71.7  
 Hazor V Yadin *et al.* 1958, Pl. 53.11  
 # Hazor V Yadin *et al.* 1958, Pl. 53.12  
 Hazor V Yadin *et al.* 1958, Pl. 67.6-7  
 Hazor V Yadin *et al.* 1958, Pl. 71.6  
 Hazor V Yadin *et al.* 1958, Pl. 73.24-25  
 # Hazor V Yadin *et al.* 1958, Pl. 74.7  
 Hazor V Yadin *et al.* 1960, Pls 80.37-40; 81.1  
 Hazor V Yadin *et al.* 1960, Pl. 81.2-10  
 # Hazor V Ben Tor *et al.* 1997, Fig. III.42 (5)  
 # Hazor VI Yadin *et al.* 1958, Pl. 51.14  
 # Hazor VI Yadin *et al.* 1961, Pl. 249.6  
 Sidon Iron II Doumet-Serhal 2006, Fig. 29.1  
 Sarepta Area Y level D Anderson 1988, Pl. 33.8  
 Tell Abou Danne IId/A6 Lebeau 1983, Pl. 2.1-5  
 # Tell Abou Danne IId/A6 Lebeau 1983, Pl. 2.6  
 Tell Afis Area B (Afis VIII) Scigliuzzo 2002, Fig. 13.1  
 Tell Afis Area D level 4 Mazzoni 1988a, Fig. 16.1-9, 11-14  
 Tell Afis Area D level 5 Mazzoni 1988a, Fig. 20.2-3, 6-7, 9  
 Tell Afis Area D level 6 Mazzoni 1988a, Fig. 21.18-19, 22-23, 25-26  
 Tell Afis Area E1 level 2 Mazzoni 1998a, Fig. 24.3-4  
 Tell Afis Area E2 level 1 Degli Esposti 1998, Fig. 10.6  
 \* Tell Afis Area E2 level 2 Degli Esposti 1998, Fig. 10.4  
 Tell Afis Area E2 level 2 Degli Esposti 1998, Fig. 10.7  
 Tell Afis Area Gc level 8a Cecchini 1998, Fig. 19.8  
 \* Tell Afis Area Gc level 8b Cecchini 1998, Fig. 18.1  
 Tell Afis Area Ge level 1 Cecchini 1998, Fig. 16.10  
 Tell Afis Area Ge level 2 Cecchini 1998, Fig. 15.17  
 Tell Afis Area Gn level 5 Cecchini 1998, Fig. 38.3  
 Tell Arqa 10E Unpublished  
 Tell Mastuma Central Area level I-1 Egami & Masuda 1984, Pl. 6.1  
 # Tell Mastuma Central Area level I-2 Egami & Masuda 1984, Pl. 6.2  
 Tell Mastuma Central Area level I-2 Egami 1988, Pl. 17.2-3  
 # Tell Mastuma South Area Wada 1994, Fig. 1.3  
 Tell Mishrife Operation C level II al Maqdissi & Badawi 2002, Fig. 16.2  
 Tell Mishrife Operation C level II al Maqdissi 2003, Fig. 12.1  
 Tell Nebi Mend Trench V Level B Unpublished  
 Tell Nebi Mend Trench V Level C Unpublished  
 # Tell Nebi Mend Trench V Level C Unpublished  
 # Tell Qarqur 8 Dornemann 2003a, Fig. 81.16, 18-19  
 Tell Qarqur 8 Unpublished

# Tell Rifa'at 2b-c Matthers 1981b, Fig. 235.1-2  
 Tell Rifa'at 2b-c see Lehmann 1996, 360 (Form 1)  
 Tell Shiyuk Fawqani Area H Al-Bahloul *et al.* 2005, Pl. 5c  
**Iron II-III**  
 \*\* Sarepta Area Y level C Anderson 1988, Pl. 35.15  
 Tell Shiyuk Fawqani Area F (IX) Makinson 2005, Pl. 1.1-3, 5-6  
 # Tyre I Bikai 1978b, Pl. 1.13  
**Iron III**  
 # Hazor III Yadin *et al.* 1958, Pl. 76.4  
 Tell Abou Danne IIc/A5 Lebeau 1983, Pl. 100.1  
 Tell Afis Area D level 1 Mazzoni 1988a, Fig. 8.2  
 Tell Afis Area D level 2 Mazzoni 1988a, Fig. 9.1-3, 5, 7  
 \*\* Tell Afis Area Gc level 4 Cecchini 1998, Fig. 31.1  
 Tell Afis Area Gc level 4 Cecchini 1998, Fig. 31.17  
 #\* Tell Afis Area Gc level 7b Cecchini 1998, Fig. 20.6  
 Tell Afis Area Gn level 2 Cecchini 1998, Fig. 39.14  
 Tell Afis Area J (Afis IX) Oggiano 2002, Fig. 26.2  
 Tell Ahmar Area D Iron III Jamieson 2005, Fig. 1.1, 7, 12  
 Tell Shiyuk Fawqani Area G level 2 Luciani 2005, Pl. 2.9-18  
**Persian**  
 Tell Shiyuk Fawqani Area G level 1 Luciani 2005, Pl. 31.362-366  
**Unclear Context**  
 Tell Afis Area N unstrat. Magazzu 2002, Fig. 32.4  
 Tell Judeideh Unstrat. see Lehmann 1996, 360 (Form 2)  
 Tell Mishrife Operation J Morandi Bonacossi 2002, Fig. 113.1  
 \* Tell Nebi Mend Unstrat. Pezard 1931, Pl. 24.1d  
 # Tell Rifa'at 2-3 (Iron Age) Lehmann 1996, Pl. 1 (2/3+4)  
 # Tell Tayinat Unstrat. Batiuk *et al.* 2005, Fig. 7.14 (1, 3, 5, 7-9)

## **B.17.44 CLASS 177**

**Iron II**  
 Tell Mastuma South Area Wada 1994, Fig. 2.14  
 Tell Nebi Mend Trench V Level B Unpublished  
 # Tell Qarqur 8 Dornemann 2003a, Fig. 81.10

## **B.17.45 CLASS 178**

**Iron I**  
 Tell Kazel Area II level 5 Capet 2003, Fig. 40.n  
 Tell Kazel Area II level 6 Badre *et al.* 1994, Fig. 44.e  
**Iron I-II**  
 Akhziv East Cem XXXIX Dayagi-Mendels 2002, Fig. 4.28(1)  
**Iron II**  
 Hama E Fugmann 1958, Fig. 310 (7A871)  
 Hazor VII Ben Tor *et al.* 1997, Fig. III.30 (8)  
**Iron I-III**  
 Akhziv South Cem XX Dayagi-Mendels 2002, Fig. 3.16(7)  
**Iron II-III**  
 Akhziv East Cem XXIX Dayagi-Mendels 2002, Fig. 4.21(7)  
**Iron III**  
 Tell Afis Area Gc level 6 Cecchini 1998, Fig. 27.1  
**Unclear Context**  
 #\* Al Mina Unstrat. Lehmann 1996, Pl. 7 (38/1)  
 Jerablus Yunus cem. Woolley 1939b, Pl. 23.B21

## B.17.46 CLASS 179

### Iron I

- Hama F1 Riis & Buhl 1990, Fig. 78 (587)  
\*\* Hazor IX Yadin *et al.* 1961, Pl. 208.29, 33  
# Khalde Cem. IV Saidah 1971, Fig. 1f  
# Tyre XI Bikai 1978b, Pl. 29.5

### Iron I-II

- Akhziv TC4 E. Mazar 2001, Fig. 7.11-12  
Byblos Necropolis K Salles 1980, Pl. 17.4-5  
Sarepta Area X level VII Khalifeh 1988, Type X11  
Tyre X Bikai 1978b, Pl. 23.3

### Iron II

- Akhziv South Cem XIV Dayagi-Mendels 2002, 27 (1)  
Akhziv South Cem 78 E. Mazar 2001, Fig. 36.1  
Hazor V Yadin *et al.* 1960, Pl. 79.10  
# Hazor V Yadin *et al.* 1960, Pl. 81.13  
Hazor V Yadin *et al.* 1961, Pl. 222.19  
# Hazor V Yadin *et al.* 1961, Pl. 225.20, 22  
Hazor V Yadin *et al.* 1961, Pl. 231.2  
\* Hazor VI Yadin *et al.* 1958, Pl. 51.12  
# Hazor VI Yadin *et al.* 1961, Pl. 181.27, 21, 33, 36  
Hazor VI Yadin *et al.* 1961, Pl. 181.28-30, 32, 34  
# Hazor VI Ben Tor *et al.* 1997, Fig. III.36 (5)  
Hazor VIII Yadin *et al.* 1961, Pl. 213.28  
Joya S. V. Chapman 1972, Fig. 24.240  
\*\* Joya S. V. Chapman 1972, Fig. 25.256-257  
\* Khalde Tomb 121 Saidah 1966, No. 26  
Khalde Tomb 121 Saidah 1966, No. 29  
\* Khalde Tomb 121 Saidah 1966, No. 30  
Khirbet Silm S. V. Chapman 1972, Fig. 24.108, 110  
\* Khirbet Silm S. V. Chapman 1972, Fig. 25.127  
\*\* Khirbet Silm S. V. Chapman 1972, Fig. 25.132, 135  
# Megiddo Area H level 3 (IVA) Finkelstein *et al.* 2000b, Fig. 11.43(1, 4, 7)  
Sidon Iron II Doumet-Serhal 2004g, Pl. 14.4  
Sidon Iron II Doumet-Serhal 2006, Fig. 25.3  
\*\* Tambourit Saidah 1977, Nos 1, 3  
Tambourit Saidah 1977, No. 2  
# Tel Beth Shan IV James 1966, Fig. 32.3  
Tel Beth Shan IV James 1966, Fig. 67.8  
\* Tel Beth Shan IV James 1966, Fig. 67.11  
# Tel Beth Shan V upper James 1966, Fig. 45.1  
Tel Beth Shan V upper James 1966, Fig. 63.14  
Tel Jezreel Iron II Zimhoni 1997b, Fig. 2.3 (6)  
Tell Afis Area Ge level 2 Cecchini 1998, Fig. 15.15  
Tell Arqa 10 Unpublished  
Tell Arqa 10E Unpublished  
# Tell Kazel Area II level 4 Badre 1990b, Fig. 37.a  
\* Tell Kazel Area II level 4 Capet 2003, Fig. 51.c  
\*\* Tell Keisan 7 Briend & Humbert 1980, Pl. 53.5  
Tell Rachidiah Tomb IV Doumet 1982, Pl. XVI.32, 57, 80  
Tell Rifa'at 2b-c Matthers 1981b, Fig. 233.1  
Tell Sheikh Hassan 3 Schneider 1999a, Fig. 4.1(4)  
Tyre III Bikai 1978b, Pl. 10.4, 7  
Tyre IV Bikai 1978b, Pl. 16.18-38  
\* Tyre IV Bikai 1978b, Pl. 16.39  
\*\* Tyre IV Bikai 1978b, Pl. 16.40-42  
Tyre V Bikai 1978b, Pl. 18.3  
\*\* Tyre V Bikai 1978b, Pl. 18.6  
\*\* Tyre VI Bikai 1978b, Pl. 18.5  
\*\* Tyre VII Bikai 1978b, Pl. 18.4

Tyre VIII Bikai 1978b, Pl. 19.9-12  
Tyre IX Bikai 1978b, Pl. 19.13-14  
Tyre Al-Bass cem. II Núñez 2004a, Fig. 68.5  
\* Tyre Al-Bass cem. II Núñez 2004a, Fig. 102.2  
Tyre Al-Bass cem. III Núñez 2004a, Figs 52.6; 55.37-39; 56.8.6  
Tyre Al-Bass cem. III Núñez 2004a, Fig. 96.5

#### **Iron I-III**

Akhziv South Cem I Dayagi-Mendels 2002, 10 (1-3)  
Akhziv South Cem XI Dayagi-Mendels 2002, 23 (1-2)  
Akhziv South Cem XX Dayagi-Mendels 2002, Fig. 3.16(4)  
\*\* Akhziv East Cem XXXVI Dayagi-Mendels 2002, Fig. 4.27(10)

#### **Iron II-III**

Akhziv South Cem XVIII Dayagi-Mendels 2002, 28 (1)  
Akhziv TC2 E. Mazar 2001, Fig. 20b.10  
\* Qraye S. V. Chapman 1972, Fig. 25.296  
Sarepta Area X level VIII Khalifeh 1988, Type X11  
Sarepta Area Y level C Anderson 1988, Pl. 35.6  
Sarepta Area Y level C Anderson 1988, Pl. 36.15  
Tyre Al-Bass cem. IV Núñez 2004a, Fig. 67.2  
Tyre Al-Bass cem. IV Núñez 2004a, Fig. 92.2  
\* Tyre Al-Bass cem. Unstrat. Núñez 2004a, Fig. 112.P25

#### **Iron III**

\*\* Tell Keisan 5 Briend & Humbert 1980, Pl. 41.15  
Tyre Al-Bass cem. V Núñez 2004a, Fig. 66.2

#### **Unclear Context**

Athlit Cremation cem. Johns 1938, Fig. 6.5  
Athlit Cremation cem. Johns 1938, Fig. 19.1  
Byblos Unstrat. Dunand 1950, No. 12.004  
Qasmieh S. V. Chapman 1972, Fig. 32.314a  
Sarepta Area X unstrat. Pritchard 1988, Fig. 38.7, 15  
\* Sarepta Area X unstrat. Pritchard 1988, Fig. 39.18

## **B.17.47 CLASS 180**

#### **Iron I**

Tell Jurn Kabir Findgroup A Eidem and Ackermann 1999, Fig. 4.8

#### **Iron I-II**

Tell Kazel Area I level 14 Badre & Gubel 1999-2000, Fig. 6.g  
# Tell Kazel Area I levels 14-16 Badre & Gubel 1999-2000, Fig. 6.d  
Tell Mishrife Iron I/II Unpublished

#### **Iron II**

Hazor V Ben Tor *et al.* 1997, Fig. III.44 (14)  
# Hazor V Ben Tor *et al.* 1997, Fig. III.45 (2)  
Joya S. V. Chapman 1972, Fig. 24.238  
# Megiddo Area H level 3 (IVA) Finkelstein *et al.* 2000b, Fig. 11.43(11, 14)  
# Tel Jezreel Findgroup B Zimhoni 1997b, Fig. 2.8 (1)  
# Tel Jezreel Findgroup D Zimhoni 1997a, Figs 1.2 (1-2); 1.3 (1-2)  
Tel Jezreel Findgroup D Zimhoni 1997a, Fig. 1.2 (4-5)  
\*\* Tell Arqa 10 Will *et al.* 1973, Pl. XXII.5  
Tell Arqa 10 Thalmann 1983, Fig. 1.7-8  
Tell Arqa 10AB Thalmann 1978a, Fig. 6.7-8  
Tell Arqa 10AB Thalmann 1978b, Fig. 46.17  
Tell Arqa 10AB Chaaya 2000, Fig. 2.1  
Tell Arqa Tomb 1 Thalmann 1978b, Fig. 45.3-5  
# Tell Arqa Tomb 1 Thalmann 1978b, Fig. 45.10  
Tell Kazel Area I level 9 Gubel 1990a, Fig. 30.a  
Tell Kazel Area I levels 6-13 Badre & Gubel 1999-2000, Fig. 5.f-g

#### **Iron II-III**

Akhziv South Cem XVIII Dayagi-Mendels 2002, 28 (3)

Akhziv South Cem XVIII Dayagi-Mendels 2002, Fig. 3.14(2)

Akhziv East Cem XXIX Dayagi-Mendels 2002, Fig. 4.21(9)

### **Iron III**

# Tell Keisan 5 Briend & Humbert 1980, Pl. 40.12

Tell Shiyuk Fawqani Area G level 2 Luciani 2005, Pl. 2.22-24

## **B.17.48 CLASS 181**

### **Iron I**

# Hazor IX Yadin *et al.* 1961, Pl. 175.11

Hazor IX Yadin *et al.* 1961, Pl. 178.15

# Tel Beth Shan V lower James 1966, Fig. 59.1

### **Iron I-II**

Akhziv TC4 E. Mazar 2001, Fig. 7.10

# Tel Beth Shan V James 1966, Figs 3.6; 19.2

# Tel Beth Shan V James 1966, Fig. 22.10, 15

Tell Mishrife Iron I/II Unpublished

### **Iron II**

# Chatal Höyük III Swift 1958, Fig. 32

# Hazor IV Yadin *et al.* 1961, Pl. 254.7, 27

# Hazor V Yadin *et al.* 1958, Pl. 74.12

# Hazor V Yadin *et al.* 1960, Pl. 79.9

# Hazor V Yadin *et al.* 1961, Pl. 222.25

Hazor V Yadin *et al.* 1961, Pl. 231.18

# Hazor VI Yadin *et al.* 1960, Pl. 67.6

Hazor VI Yadin *et al.* 1961, Pl. 181.23

# Hazor VI Yadin *et al.* 1961, Pl. 220.5

# Hazor VI Yadin *et al.* 1961, Pl. 249.5

# Hazor VII Yadin *et al.* 1961, Pl. 214.16

# Hazor VII Ben Tor *et al.* 1997, Fig. III.30 (9, 11)

# Hazor VIII Yadin *et al.* 1958, Pl. 47.18

# Hazor VIII Yadin *et al.* 1960, Pl. 55.29-30

# Tel Beth Shan IV James 1966, Fig. 34.15

Tel Beth Shan IV James 1966, Fig. 67.21

# Tel Beth Shan IV James 1966, Fig. 67.25

Tell Afis Area D level 4 Mazzoni 1988a, Fig. 15.3

# Tell Nebi Mend Trench V Level B Unpublished

# Tell Nebi Mend Trench V Level C Unpublished

# Tell Qarqur 8 Dornemann 2003a, Fig. 81.20-21

Tell Shiyuk Fawqani Area H Al-Bahloul *et al.* 2005, Pl. 9g

### **Iron III**

Tell Afis Area D level 2 Cecchini 1988, Fig. 6.11

Tell Shiyuk Fawqani Area G level 2 Luciani 2005, Pl. 2.19

Tell Shiyuk Fawqani Area G level 2 Luciani 2005, Pl. 3.33

### **Unclear Context**

Tell Mishrife Operation J Morandi Bonacossi 2002, Fig. 113.3

# Tell Mishrife Operation J Morandi Bonacossi 2002, Fig. 113.4

## **B.17.49 CLASS 182**

### **B.17.49.1 CLASS 182a**

#### **Iron I**

Hazor IX Yadin *et al.* 1961, Pl. 175.9

# Megiddo Area K level 3 (VB) Finkelstein *et al.* 2000b, Fig. 11.18(4)

\* Ras Ibn Hani Iron I Bounni *et al.* 1979, Fig. 25.9

Sarepta Area X level V Khalifeh 1988, Type F4

Sarepta Area Y level F Anderson 1988, Pl. 29.31-32

\*\* Tell Afis Area E1 level 9b Venturi 2000a, Fig. 6.4

Tell Keisan 9a/b Briend & Humbert 1980, Pl. 66.5a

Tell Qarqur 9 Unpublished

#### **Iron I-II**

Ain Dara Iron I/II Stone & Zimansky 1999, Fig. 70.108

Tell Mishrife Operation K levels 8-4 Luciani 2002, Fig. 134.3

Tell Mishrife Iron I/II Unpublished

#### **Iron II**

Hama E Fugmann 1958, Figs 310 (8A151); 344 (4B553)

Hama E Riis & Buhl 1990, 158 (504-506)

# Hama E Riis & Buhl 1990, Fig. 73 (519)

# Hazor IV Yadin *et al.* 1961, Pl. 254.6

# Hazor IV/V Yadin *et al.* 1958, Pl. 71.3

# Hazor VI Ben Tor *et al.* 1997, Fig. III.35 (3)

# Ras al-Bassit Findgroup B Braemer 1986, Fig. 2.5

Sidon Iron II Doumet-Serhal 2006, Fig. 29.4

# Sarepta Area Y level D Anderson 1988, Pl. 33.22

# Tel Jezreel Findgroup A Zimhoni 1997a, Fig. 1.7 (3)

Tel Jezreel Iron II Zimhoni 1997b, Fig. 2.3 (16)

Tell Afis Area D level 3 Mazzoni 1988a, Fig. 14.2, 4; Cecchini 1988, Fig. 6.18

Tell Afis Area D level 4 Mazzoni 1988a, Fig. 15.6, 8; Cecchini 1988, Fig. 7.23-33

Tell Afis Area D level 6 Mazzoni 1988a, Fig. 21.2, 5

Tell Afis Area Gn level 5 Cecchini 1998, Fig. 38.2

# Tell Afis Area L level 6a D'Amore 1998a, Fig. 6.19

Tell Mastuma Central Area level I-2 Egami & Masuda 1984, Pl. 6.10

Tell Mastuma South Area Wada 1994, Fig. 1.12

Tell Nebi Mend Trench V Level B Unpublished

# Tell Nebi Mend Trench V Level B Unpublished

Tell Nebi Mend Trench V Level C Unpublished

# Tell Qarqur 8 Dornemann 2003a, Fig. 81.22, 24

# Tell Qarqur 8 Unpublished

# Tell Rifa'at 2b-c Matthers 1981b, Fig. 233.5-7

# Tille Höyük IV-V Blaylock 1999, Fig. 4.4

# Tyre IV Bikai 1978b, Pl. 15.13-15

Tyre IV Bikai 1978b, Pl. 16.7-9

# Tyre Al-Bass cem. III Núñez 2004a, Fig. 55.31

Tyre Al-Bass cem. III Núñez 2004a, Fig. 55.32

#### **Iron II-III**

Tell Afis Area A (Afis VIII/IX) Soldi 2005, Fig. 20.1

# Tyre Al-Bass cem. IV Núñez 2004a, Fig. 69.4

#### **Iron III**

# Ras al-Bassit Findgroup G Braemer 1986, Fig. 7.34

Tell Afis Area D level 2 Cecchini 1988, Fig. 6.5-7, 9

Tell Afis Area D level 2 Mazzoni 1988a, Fig. 9.15, 20

Tell Afis Area D level 2 Mazzoni 1988a, Fig. 9.19

# Tell Afis Area Gc level 3 Cecchini 1998, Fig. 33.4-5

# Tell Afis Area Gc level 4 Cecchini 1998, Fig. 31.9

# Tell Afis Area Gc level 5 Cecchini 1998, Fig. 29.4

# Tell Afis Area Gc level 7b Cecchini 1998, Fig. 20.13

Tell Afis Area Gn level 4 Cecchini 1998, Fig. 38.13

Tell Ahmar Area C level 2 Jamieson 2000, Fig. 13.14-17

Tell Ahmar Area D Iron III Jamieson 2005, Fig. 1.2, 6

Tell Shiyuk Fawqani Area G level 2 Luciani 2005, Pl. 2.20-21

#### **Iron II-Persian**

# Akhziv South Cem 68 E. Mazar 2001, Fig. 52.15

#### **Persian**

# Sidon Persian Doumet-Serhal 2006, Fig. 22.3-4

Tell Shiyuk Fawqani Area G level 1 Luciani 2005, Pl. 32.387



## **B.17.49.2 CLASS 182b**

### **Iron I**

Hazor IX/X Unpublished

Pella Iron I Unpublished

Tell Afis Area E1 level 3 Mazzoni 1992b, Fig. 9.7

Tell Afis Area E1 level 9c Venturi 1998a, Fig. 7.14

Tyre XI Bikai 1978b, Pl. 29.7

# Tyre XII Bikai 1978b, Pl. 31.12

Tyre XIV Bikai 1978b, Pl. 39.13

### **Iron I-II**

Pella Area III level O McNicoll *et al.* 1992, Pl. 67.6

Tell Mishrife Operation H levels 5-6 Barro 2002, Fig. 107.2

# Tell Mishrife Iron I/II Unpublished

### **Iron II**

# Hazor IV Yadin *et al.* 1960, Pl. 98.7-8

# Hazor V Yadin *et al.* 1958, Pl. 53.6

Hazor V Yadin *et al.* 1958, Pl. 53.7

# Hazor V Yadin *et al.* 1958, Pl. 73.22

#\* Hazor V Yadin *et al.* 1960, Pl. 82.16

# Hazor V Ben Tor *et al.* 1997, Fig. III.42 (1)

# Hazor VII Yadin *et al.* 1958, Pl. 49.27

# Hazor VIII Yadin *et al.* 1958, Pl. 47.3

# Hazor VIII Yadin *et al.* 1960, Pl. 55.6, 8-11, 28

\* Hazor VIII Yadin *et al.* 1960, Pl. 55.31

# Hazor VIII Yadin *et al.* 1961, Pl. 247.2

# Ras al-Bassit Findgroup C Braemer 1986, Fig. 3.11

Sidon Iron II Doumet-Serhal 2006, Fig. 28.5

Tel Jezreel Findgroup C Zimhoni 1997a, Fig. 1.9 (3)

Tell Afis Area D level 3 Cecchini 1988, Fig. 6.19

Tell Afis Area D level 4 Cecchini 1988, Fig. 7.19

Tell Afis Area D level 6 Mazzoni 1988a, Fig. 21.3

Tell Afis Area E2 level 1 Degli Esposti 1998, Fig. 10.14

# Tell Afis Area Gc level 8b Cecchini 1998, Fig. 18.3

Tell Afis Area Gc level 8b Cecchini 1998, Fig. 18.6

Tell Jurn Kabir Findgroup B Eidem and Ackermann 1999, Fig. 6.5

# Tell Keisan 7 Briend & Humbert 1980, Pl. 53.12

# Tell Nebi Mend Trench V Level B Unpublished

Tell Nebi Mend Trench V Level B Unpublished

# Tell Qarqur 8 Dornemann 2003a, Fig. 81.23

# Tell Qarqur 8 Unpublished

Tell Sheikh Hassan 3 Schneider 1999a, Fig. 16.30

# Tyre III Bikai 1978b, Pl. 10.30

# Tyre VIII Bikai 1978b, Pl. 19.2

### **Iron II-III**

Tell Shiyuk Fawqani Area G level 3 Luciani 2005, Pl. 1.2-3

### **Iron III**

# Ras al-Bassit Findgroup E Braemer 1986, Fig. 5.22

Tell Afis Area D level 2 Mazzoni 1988a, Fig. 9.16

Tell Afis Area D level 2 Mazzoni 1988a, Fig. 9.21

# Tell Afis Area Gc level 2 Cecchini 1998, Fig. 35.1

Tell Afis Area Gc level 2 Cecchini 1998, Fig. 35.6-7

# Tell Afis Area Gc level 4 Cecchini 1998, Fig. 31.10

# Tell Afis Area Gc level 5 Cecchini 1998, Fig. 29.3

# Tell Afis Area Gc level 6 Cecchini 1998, Fig. 26.5, 7

# Tell Afis Area Gc level 7b Cecchini 1998, Fig. 20.8-11

Tell Afis Area Gc level 7b Cecchini 1998, Fig. 22.8

Tell Shiyuk Fawqani Area G level 2 Luciani 2005, Pl. 4.41, 56

### **Persian**

Tell Shiyuk Fawqani Area G level 1 Luciani 2005, Pl. 35.419-420

### **B.17.49.3 CLASS 182c**

#### **Iron I**

Ain Dara Lower Mound Iron I Stone & Zimansky 1999, Fig. 70.186

Pella Iron I Unpublished

Sarepta Area Y level E Anderson 1988, Pl. 31.13

Tell Jurn Kabir Findgroup A Eidem and Ackermann 1999, Fig. 4.5

Tell Qarqur 9 Unpublished

#### **Iron I-II**

Tell Mishrife Iron I/II Unpublished

# Tell Mishrife Iron I/II Unpublished

#### **Iron II**

Ain Dara Lower Mound Iron II Stone & Zimansky 1999, Fig. 70.186

Hama E Riis & Buhl 1990, Fig. 72 (509)

# Hazor IV Yadin *et al.* 1961, Pl. 254.30

\* Hazor V Yadin *et al.* 1958, Pl. 67.26

\* Hazor V Yadin *et al.* 1960, Pl. 93.16

# Hazor VI Yadin *et al.* 1961, Pl. 249.4

# Hazor VII Ben Tor *et al.* 1997, Fig. III.30 (10)

\* Hazor VIII Yadin *et al.* 1960, Pl. 55.7

# Hazor VIII Ben Tor *et al.* 1997, Fig. III.27 (1)

\*\* Sarepta Area Y level D Anderson 1988, Pl. 33.25

Tell Afis Area D level 4 Cecchini 1988, Fig. 7.20-22

Tell Afis Area D level 6 Mazzoni 1988a, Fig. 21.6

# Tell Afis Area Gc level 8a Cecchini 1998, Fig. 19.3

\*\* Tell Keisan 7 Briend & Humbert 1980, Pl. 53.9

\* Tell Keisan 7 Briend & Humbert 1980, Pl. 53.10

Tell Qarqur 8 Unpublished

Tell Rifa'at 2b-c Seton Williams 1961, Pl. 39.12

# Tell Rifa'at 2b-c Matthers 1981b, Fig. 235.6

Tell Sheikh Hassan 3 Schneider 1999a, Fig. 6.7(4)

#### **Iron III**

\* Hazor III Yadin *et al.* 1958, Pl. 77.25

Tell Afis Area D level 2 Cecchini 1988, Fig. 6.8

Tell Afis Area D level 2 Mazzoni 1988a, Fig. 9.14

# Tell Afis Area Gc level 6 Cecchini 1998, Fig. 26.9

\* Tell Keisan 4 Briend & Humbert 1980, Pl. 30.5

Tell Shiyuk Fawqani Area G level 2 Luciani 2005, Pl. 4.51, 54

#### **Persian**

Beirut Bey 010 Persian Doumet-Serhal & Sayegh 1998, 24(1)

Sidon Persian Doumet-Serhal 2006, Fig. 22.1-2

Tell Kazel Area I level 4 Gubel 1990a, Fig. 23.c-d

#### **Unclear Context**

Tell Afis Area N unstrat. Magazzu 2002, Fig. 32.3

### **B.17.50 CLASS 183**

#### **Iron I**

Ain Dara Lower Mound Iron I Stone & Zimansky 1999, Fig. 70.120

\*\* Tell Afis Area E2 level 3 Degli Esposti 1998, Fig. 7.6

\* Tell Afis Area E2 level 3 Degli Esposti 1998, Fig. 7.7

Tell Afis Area E2 level 3 Degli Esposti 1998, Fig. 7.8

Tell Afis Area G (Iron IC) Canuti 2000, Fig. 17.14

Tell Sukas South Harbour Buhl 1996, Fig. 30.XIVC

#### **Iron I-II**

Tell Mishrife Iron I/II Unpublished

Tell Qarqur 8-9 Dornemann 2003a, Fig. 88.8

#### **Iron II**

# Hazor VI Ben Tor *et al.* 1997, Fig. III.35 (12)

# Sidon Iron II Doumet-Serhal 2006, Fig. 25.7

# Tel Jezreel Findgroup B Zimhoni 1997b, Fig. 2.8 (5)  
 Tell Afis Area D level 4 Mazzoni 1988a, Fig. 15.11  
 # Tell Afis Area E2 level 1 Degli Esposti 1998, Fig. 10.8  
 \* Tell Afis Area E2 level 2 Degli Esposti 1998, Fig. 10.17  
 \* Tell Afis Area Ge level 2 Cecchini 1998, Fig. 15.14  
 Tell Afis Area Ge level 2 Cecchini 1998, Fig. 15.16  
 # Tell Nebi Mend Trench V Level B Unpublished  
 \* Tell Nebi Mend Trench V Level C Unpublished  
 Tell Nebi Mend Trench V Level C Unpublished  
 # Tell Qarqur 8 Unpublished

#### **Iron III**

\* Hazor III Yadin *et al.* 1958, Pl. 77.3  
 Tell Afis Area D level 1 Mazzoni 1988a, Fig. 8.8  
 Tell Afis Area D level 2 Mazzoni 1988a, Fig. 9.8  
 \*\* Tell Arqa 9 Thalmann 1978b, Fig. 47.7  
 # Tell Keisan 4 Briend & Humbert 1980, Pl. 29.11  
 # Tell Keisan 5 Briend & Humbert 1980, Pl. 40.10

### **B.17.51 CLASS 184**

#### **Iron I**

\* Ain Dara Lower Mound Iron I Stone & Zimansky 1999, Fig. 27.8  
 # Hazor IX Yadin *et al.* 1960, Pl. 52.8  
 # Hazor IX Yadin *et al.* 1961, Pl. 175.14  
 # Hazor IX Yadin *et al.* 1961, Pl. 178.23, 25, 31  
 Hazor IX/X Yadin *et al.* 1958, Pl. 45.12  
 # Hazor IX/X Yadin *et al.* 1961, Pl. 177.3  
 # Hazor IX/X Yadin *et al.* 1961, Pl. 210.5  
 # Hazor IX/X Unpublished  
 \*\* Hazor IX/X Unpublished  
 # Hazor X Yadin *et al.* 1961, Pl. 171.15  
 Hazor XII Yadin *et al.* 1961, Pl. 164.19  
 Megiddo VIA Loud 1948, Fig. 78.13  
 Sarepta Area X level V Khalifeh 1988, Type X24  
 Sarepta Area Y level G Anderson 1988, Pl. 27.18  
 Tell Abu Hawam V/IV Hamilton 1934, Pl. 22.15  
 Tell Jurn Kabir Findgroup A Eidem and Ackermann 1999, Fig. 4.1-4  
 \* Tell Tayinat Iron I Unpublished

#### **Iron I-II**

Akhziv TC4 E. Mazar 2001, Fig. 7.2-3  
 \* Byblos Necropolis K Salles 1980, Pl. 11.1  
 \* Byblos Necropolis K Salles 1980, Pl. 11.10  
 Byblos Necropolis K Salles 1980, Pl. 18.3  
 # Tel Beth Shan V James 1966, Fig. 48.4  
 \* Tell el Ghassil Area III level 4 Joukowsky 1972, Pl. 26.3

#### **Iron II**

# Al Mina IX du Plat Taylor 1959, Fig. 6.36  
 Chatal Höyük III Swift 1958, Fig. 36  
 Hazor V Yadin *et al.* 1960, Pl. 80.25  
 # Hazor V Yadin *et al.* 1960, Pl. 80.26-28  
 # Hazor V Yadin *et al.* 1961, Pl. 222.24  
 Hazor VI Yadin *et al.* 1958, Pl. 51.2  
 # Hazor VI Yadin *et al.* 1960, Pl. 67.5  
 # Hazor VI Yadin *et al.* 1961, Pl. 249.3  
 # Hazor VI Ben Tor *et al.* 1997, Fig. III.35 (2)  
 Hazor VII Yadin *et al.* 1960, Pl. 63.27  
 # Hazor VII Ben Tor *et al.* 1997, Fig. III.30 (18)  
 # Hazor VIII Yadin *et al.* 1958, Pl. 47.12  
 # Hazor VIII Yadin *et al.* 1960, Pl. 53.2-4

Hazor VIII Yadin *et al.* 1960, Pl. 54.18-19  
 Hazor VIII Ben Tor *et al.* 1997, Fig. III.27 (3)  
 # Sidon Iron II Doumet-Serhal 2004g, Pl. 14.9  
 # Sidon Iron II Doumet-Serhal 2006, Fig. 25.10  
 Sidon Iron II Doumet-Serhal 2006, Fig. 31.28, 30  
 Sidon Iron II Doumet-Serhal 2006, Fig. 31.31  
 # Tel Dan II Biran 1999, Fig. 7.6  
 # Tel Jezreel Findgroup B Zimhoni 1997b, Fig. 2.8 (6)  
 Tell Afis Area B (Afis VIII) Scigliuzzo 2002, Figs 12.2-5; 13.3  
 Tell Afis Area B (Afis VIII) Scigliuzzo 2005, Fig. 37.4  
 Tell Afis Area B (Afis VIII) Virgilio 2005, Fig. 34.5-7  
 # Tell Afis Area D level 3 Mazzoni 1988a, Fig. 14.3  
 Tell Afis Area D level 4 Mazzoni 1988a, Fig. 15.7, 9, 12-13  
 Tell Afis Area D level 4 Mazzoni 1988a, Fig. 15.10  
 Tell Afis Area D level 5 Mazzoni 1988a, Fig. 20.1  
 Tell Afis Area E1 level 2 Mazzoni 2000b, Fig. 6.10  
 Tell Afis Area L level 7 D'Amore 1998a, Fig. 6.26  
 # Tell Arqa 10 Unpublished  
 Tell el Ghassil Area I level 2 Joukowsky 1972, Pl. 2.4  
 Tell Judeideh IV see Lehmann 1996, 378 (Form 94)  
 Tell Jurn Kabir Findgroup B Eidem and Ackermann 1999, Fig. 6.1-3  
 Tell Mastuma Central Area level I-2 Egami 1988, Pl. 17.1  
 Tell Mastuma Central Area level I-2 Wakita *et al.* 1995, Fig. 7.6  
 Tell Mastuma South Area Wada 1994, Fig. 1.4-5  
 # Tell Qarqur 8 Dornemann 2003a, Fig. 82.16-18, 20  
 Tell Qarqur 8 Dornemann 2003a, Fig. 82.21-22, 24-25  
 # Tell Qarqur 8 Unpublished  
 Tell Qarqur 8 Unpublished  
 Tell Rifa'at 2b-c Seton Williams 1961, Pl. 39.5  
 Tell Rifa'at 2b-c Lehmann 1996, Pl. (94/1)  
 Tell Sheikh Hassan 3 Schneider 1999a, Fig. 7.11(7)  
 Tell Sukas H1 Buhl 1983, Fig. XIII.175  
 Tille Höyük IV-V Blaylock 1999, Fig. 4.8-11  
 # Tyre VIII Bikai 1978b, Pl. 19.1  
**Iron II-III**  
 Tell Afis Area A (Afis VIII/IX) D'Amore 2005, Fig. 16.1  
 Tell Afis Area A (Afis VIII/IX) Soldi 2005, Fig. 20.2  
**Iron III**  
 \* Tel Dan I Pakman 1992, Fig. 5.6  
 Tell Afis Area D level 2 Cecchini 1988, Fig. 6.10  
 Tell Afis Area D level 2 Mazzoni 1988a, Fig. 9.6, 10  
 Tell Afis Area Gn level 3 Cecchini 1998, Fig. 38.17  
 Tell Judeideh III see Lehmann 1996, 378 (Form 94)  
 Tell Keisan 4 Briend & Humbert 1980, Pl. 28.3  
 Tell Rifa'at 2a see Lehmann 1996, 378 (Form 94)  
 Zincirli Iron III Andrae 1943, Pl. 25w  
**Iron III-Persian**  
 Tell Judeideh II/III see Lehmann 1996, 377 (Form 89c)  
**Persian**  
 \* Beirut Bey 010 Persian Doumet-Serhal & Sayegh 1998, 24(3)  
 \*\* Beirut Bey 010 Persian Doumet-Serhal & Sayegh 1998, 24(4)  
 Tell Sukas E Buhl 1983, Fig. XII.164  
**Unclear Context**  
 Jerablus Yunus cem. Woolley 1939b, Pl. 23.B26  
 Tell Judeideh Unstrat. see Lehmann 1996, 378 (Form 94)  
 Tell Mishrife Unstrat. du Mesnil du Buisson 1927, Pl. 79.48

## **B.17.52 CLASS 185**

### **Iron I**

Hama Cem. I Riis 1948, Fig. 92

### **Iron II**

Hama E1 Riis & Buhl 1990, 130 (Form XXVIII B2)

Tell Nebi Mend Trench V level C Unpublished

## **B.17.53 CLASS 186**

### **Iron I**

\* Tell Afis Area E1 level 7 Mazzoni 1998a, Fig. 16.1

\* Tell Afis Area E1 level 9a Venturi 2000a, Fig. 7.14

\* Tell Rifa'at 3 Seton Williams 1961, Pl. 40.2

## **B.17.54 CLASS 187**

### **Iron I**

Hama F Fugmann 1958, Fig. 165 (4B956)

\* Tell Afis Area E2 level 4 Degli Esposti 1998, Fig. 7.4

Tell Afis Area G (Iron IC) Canuti 2000, Fig. 17.13

Tell Afis Area Ge level 5 Cecchini 1998, Fig. 14.1

Tell Rifa'at 3 Seton Williams 1961, Pl. 38.9

\* Tell Tayinat Iron I Unpublished

### **Iron I-II**

Tell Mishrife Iron I/II Unpublished

### **Iron II**

Ain Dara Lower Mound Iron II Stone & Zimansky 1999, Fig. 74.3

Tell Afis Area E2 level 2 Degli Esposti 1998, Fig. 10.23

Tell Afis Area Ge level 1 Cecchini 1998, Fig. 16.8

# Tell Nebi Mend Trench V Level C Unpublished

# Tell Qarqur 8 Unpublished

Tell Rifa'at 2b-c Seton Williams 1961, Pl. 38.8

Tell Rifa'at 2b-c Seton Williams 1961, Pl. 39.11

Tell Rifa'at 2b-c Matthers 1981b, Fig. 235.8

Tell Shiyuk Fawqani Area H Al-Bahloul *et al.* 2005, Pl. 8b-c

Tille Höyük IV-V Blaylock 1999, Fig. 4.12

### **Iron II-III**

Deve Höyük Cem. I Moorey 1980, Fig. 3.11

### **Iron III**

# Al Mina VI/V du Plat Taylor 1959, Fig. 6.27

# Al Mina VII/VI du Plat Taylor 1959, Fig. 6.27

Tell Afis Area Gc level 7b Cecchini 1998, Fig. 22.7, 9

Tell Afis Area Gn level 3 Cecchini 1998, Fig. 38.16

# Tell Keisan 5 Briend & Humbert 1980, Pl. 40.9

### **Unclear Context**

Tell Sheikh Hassan Unstrat. Schneider 1999b, Fig. 3.5-6

## **B.17.55 CLASS 188**

### **Iron I**

\* Ain Dara Lower Mound Iron I Stone & Zimansky 1999, Fig. 27.1, 3, 6

Ain Dara Lower Mound Iron I Stone & Zimansky 1999, Fig. 27.7

Ain Dara Lower Mound Iron I Stone & Zimansky 1999, Fig. 70.170, 175

Hama Cem. II Riis 1948, Fig. 89

Hama Cem. II Riis 1948, Fig. 96

Hama F1 Riis & Buhl 1990, 130 (Form XXVIII A2)

Hama F2 Riis & Buhl 1990, Fig. 72 (510)

#\* Hazor IX Yadin *et al.* 1961, Pl. 175.18  
 Hazor XII Yadin *et al.* 1961, Pl. 201.6  
 Hazor Iron I Ben Ami 2001, Fig. 5.7, 12  
 \* Kamid el-Lawz Iron I Hachmann 1966, Fig. 21.5  
 \* Megiddo VB Lamon & Shipton 1939, Fig. 30.141  
 \* Megiddo VIA Loud 1948, Fig. 78.20  
 Megiddo Area F level 5 (VIA) Finkelstein *et al.* 2000b, Fig. 11.2(2)  
 Megiddo VIB Loud 1948, Fig. 74.8  
 \* Megiddo VIB Loud 1948, Fig. 74.9  
 \* Megiddo Area F level 6 burial Finkelstein *et al.* 2000b, Fig. 11.1(2)  
 Megiddo Tombs Guy 1938, Pl. 69.3  
 \* Ras Ibn Hani Iron I Badre 1983, Fig. 1g  
 Sarepta Area X level V Khalifeh 1988, Type X23  
 IMP Sarepta Area Y level F Anderson 1988, Pl. 30.10  
 Sarepta Area Y level G Anderson 1988, Pl. 26.20, 22  
 \* Sarepta Area Y level G Anderson 1988, Pl. 26.26  
 Sarepta Area Y level G Anderson 1988, Pl. 27.19  
 #\* Sarepta Area Y level G Anderson 1988, Pl. 28.19  
 Tel Beth Shan VI James 1966, Fig. 52.21  
 Tel Dan V Biran 1989b, Figs 22.2; 24.1  
 Tel Dan VI Biran 1989a, Fig. 4.12.1  
 \* Tell Afis Area E1 level 3 Bonatz 1998, Fig. 2.1  
 \* Tell Afis Area E1 level 7 Bonatz 1998, Fig. 2.2  
 \* Tell Afis Area E1 level 7 Venturi 2000a, Fig. 11.3, 5-6  
 \* Tell Afis Area E1 level 7 Venturi 2000b, Fig. 12.5  
 \* Tell Afis Area E1 level 7 Venturi 2000c, Fig. 9.3; 2000a, Fig. 11.2, 4  
 \* Tell Afis Area E1 level 8 Bonatz 1998, Fig. 2.3-4  
 \* Tell Afis Area E1 level 8 Bonatz 1998, Fig. 3.5-6, 8  
 \* Tell Afis Area E1 level 8 Venturi 2000b, Fig. 12.3-4  
 \* Tell Afis Area E1 level 9a Venturi 2000a, Fig. 7.2  
 \* Tell Afis Area E1 level 9a Venturi 2000a, Fig. 9.2  
 \* Tell Afis Area E1 level 9a Venturi 2000b, Fig. 12.1-2  
 \* Tell Afis Area E1 level 9b Venturi 2002, Fig. 21.1-2  
 \* Tell Afis Area E1 level 9b Venturi 2000a, Fig. 6.2  
 \*\* Tell Afis Area E1 level 9c Pedrazzi 2002, Fig. 23.1  
 \* Tell Afis Area E1 level 9c Pedrazzi 2002, Fig. 23.3-6  
 \* Tell Afis Area E1 level 9c Pedrazzi 2002, Fig. 24.2  
 # Tell Afis Area E4 (Afis VII) Chiti 2005, Fig. 50.2  
 \* Tell Afis Area E4 (Afis VII) Venturi 2005, Fig. 54.1  
 \*\* Tell Afis Area E4 (Afis VII) Venturi 2005, Fig. 54.2-4, 6  
 \* Tell Afis Area G (Iron IA) Canuti 2000, Fig. 17.1  
 \*\* Tell Afis Area G (Iron IA) Canuti 2000, Fig. 17.2  
 Tell Jurn Kabir Findgroup A Eidem and Ackermann 1999, Fig. 4.6  
 Tell Kazel Area II level 5 Badre *et al.* 1994, Fig. 39.b  
 \* Tell Kazel Area II level 5 Badre *et al.* 1994, Fig. 39.f  
 \* Tell Kazel Area II level 5 Capet 2003, Fig. 37.b  
 \* Tell Kazel Area II level 5 Capet 2003, Fig. 40.k, m  
 Tell Kazel Area II level 5 Capet 2003, Fig. 46.a  
 \* Tell Kazel Area II level 6 Badre *et al.* 1994, Fig. 55.d  
 Tell Kazel Area II level 6 Badre *et al.* 1994, Fig. 55.e  
 Tell Kazel Area II level 6 Capet 2003, Fig. 8.g  
 \*\* Tell Kazel Area II level 6 Capet 2003, Fig. 23.a  
 Tell Kazel Area IV level 3 Badre & Gubel 1999-2000, Fig. 46.d-h  
 Tell Kazel Area IV level 4 Badre & Gubel 1999-2000, Fig. 43.b  
 \* Tell Keisan 9a/b Briend & Humbert 1980, Pl. 66.2  
 Tell Keisan 9a/b Briend & Humbert 1980, Pl. 66.2a-n  
 Tell Keisan 9c Briend & Humbert 1980, Pl. 79.3  
 Tell Keisan 11/10 Briend & Humbert 1980, Pl. 81.20  
 \* Tell Qarqur 9 Unpublished  
 \*\* Tell Qarqur 9 Unpublished

# Tell Qarqur 9 Unpublished

Tell Sukas South Harbour Buhl 1996, Fig. 28.XIIC

\* Tell Tayinat Iron I Harrison *et al.* 2006, Fig. 10.A2542

\* Tell Tayinat Iron I Harrison *et al.* 2006, Fig. 10.B2361

\* Tell Tayinat Iron I Harrison *et al.* 2006, Fig. 10.Z192

\* Tell Tayinat Iron I Unpublished

Tille Höyük Sondage level 10 Summers 1993, Fig. 54.3

# Tyre XII Bikai 1978b, Pl. 31.4

\* Tyre XIII Bikai 1978b, Pls 34.2, 5, 7, 9, 12; 37.7

\*\* Tyre XIII Bikai 1978b, Pl. 37.10

\*\* Tyre XIV Bikai 1978b, Pl. 39.14

\* Tyre XIV Bikai 1978b, Pl. 39.20

**Iron I-II**

\* Byblos Necropolis K Salles 1980, Pl. 11.2-3, 8

Tel Beth Shan Northern cem. Oren 1973, Fig. 47a.7

\*\* Tell Qarqur 8-9 Dornemann 2003a, Fig. 88.5

Tell Sukas H Buhl 1983, Fig. XIII.187

Tyre X Bikai 1978b, Pl. 27.5

\* Tyre X Bikai 1978b, Pl. 28.3, 8

**Iron II**

Hama Cem. III Riis 1948, Fig. 90

Hama E Fugmann 1958, Fig. 344 (4B14)

Hama E1 Fugmann 1958, Fig. 325 (8A67)

Hama E1 Riis & Buhl 1990, 130 (Form XXVIII A1)

Hama E1 Riis & Buhl 1990, 130 (Form XXVIII A2)

Hama E1 Riis & Buhl 1990, 130 (Form XXVIII C2)

Hama E2 Riis & Buhl 1990, 130 (Form XXVIII A2)

Ras al-Bassit Cem. Courbin 1993a, Fig. 16.4(C531)

\* Sarepta Area Y level D Anderson 1988, Pl. 32.19

Tell Afis Area B (Afis VIII) Virgilio 2005, Fig. 34.4

Tell Afis Area D level 4 Cecchini 1988, Fig. 7.5, 10

Tell Afis Area D level 6 Mazzoni 1988a, Fig. 21.4

Tell Afis Area E2 level 1 Degli Esposti 1998, Fig. 10.11, 22

\* Tell Afis Area E2 level 1 Degli Esposti 1998, Fig. 11.6

\* Tell Kazel Iron II Dunand *et al.* 1964, Pl. 11.3

Tell Keisan 8 Briend & Humbert 1980, Pl. 55.10

\* Tell Keisan 8 Briend & Humbert 1980, Pl. 56.2

Tell Nebi Mend Trench V Level B Unpublished

Tell Nebi Mend Trench V Level C Unpublished

\* Tell Rifa'at 2b-c Seton Williams 1961, Pl. 38.11

# Tyre II Bikai 1978b, Pl. 10.17

\* Tyre II Bikai 1978b, Pl. 11.21

\*\* Tyre VI Bikai 1978b, Pl. 18.16

Tyre IX Bikai 1978b, Pl. 20.11

\* Tyre IX Bikai 1978b, Pl. 21.6

\* Tyre IX Bikai 1978b, Pl. 22.17

**Iron II-III**

\* Beirut Bey 003 abandonment Badre 1997b, Fig. 38.1

\*\* Beirut Bey 003 abandonment Badre 1997b, Fig. 38.2, 4-7

BOR Beirut Bey 003 abandonment Badre 1997b, Fig. 38.3, 8a

# Ras Ibn Hani Iron II/III Bounni *et al.* 1978, 283, Fig. 29.3

**Iron III**

BOR Al Mina VIII-V du Plat Taylor 1959, Fig. 5.11-12

Tell Afis Area D level 2 Mazzoni 1988a, Fig. 9.13

Tell Afis Area Gc level 4 Cecchini 1998, Fig. 32.3

Tell Afis Area Gc level 7b Cecchini 1998, Fig. 22.13

**Unclear Context**

Jerablus Yunus cem. Woolley 1939b, Pl. 15.d.2

Jerablus Yunus cem. Woolley 1939b, Pl. 15.e.1

\* Sarepta Area X unstrat. Koehl 1985, Figs 20.193-196; 21.212

Sarepta Area X unstrat. Pritchard 1988, Fig. 59.7  
\*\* Tell Afis Area N unstrat. Magazzu 2002, Fig. 32.2  
\* Tell Kazel Unstrat. Yon & Caubet 1990, Fig. 2.129  
\*\* Tell Kazel Unstrat. Yon & Caubet 1990, Fig. 3.149  
BOR Tell Kazel Unstrat. Yon & Caubet 1990, Fig. 3.176  
\* Tell Nebi Mend Unstrat. Pezard 1931, Pl. 23.4.6  
Tell Nebi Mend Unstrat. Pezard 1931, Pl. 25.3.6

## **B.17.56 CLASS 189**

### **Iron I**

Sarepta Area X level V Khalifeh 1988, Type F5  
Sarepta Area Y level F Anderson 1988, Pl. 29.24  
Sarepta Area Y level G Anderson 1988, Pl. 26.21  
Tell Sukas South Harbour Buhl 1996, Fig. 27.XIIA, XIIB

### **Iron II**

Tell Afis Area D level 4 Cecchini 1988, Fig. 7.4  
Tell Jurn Kabir Findgroup B Eidem and Ackermann 1999, Fig. 7.4  
Tell Qarqur 8 Unpublished  
# Tyre III Bikai 1978b, Pl. 10.18-19

### **Iron II-III**

# Akhziv East Cem XXIX Culican 1975-1976, Fig. A.o  
# Akhziv East Cem XXIX Dayagi-Mendels 2002, Fig. 4.21(4)

### **Unclear Context**

Jerablus Yunus cem. Woolley 1939b, Pl. 23.B28-B29

## **B.17.57 CLASS 190**

### **Iron I-II**

# Tell Mishrife Iron I/II Unpublished

### **Iron II**

# Hama Cem. IV Riis 1948, Fig. 110  
# Hama E Fugmann 1958, Figs 188 (5B411, 5B414); 216 (6C161, 6C163)  
# Hama E1 Riis & Buhl 1990, 130 (Form XXXC3)  
# Hama E1 Riis & Buhl 1990, Fig. 78 (599)  
Tell Judeideh IV see Lehmann 1996, 377 (Form 89b)

### **Unclear Context**

Tell Tayinat Unstrat. Unpublished

## **B.17.58 CLASS 191**

### **Iron I**

IMP Tell Afis Area E1 level 4 Bonatz 1998, Fig. 5.3  
Tell Afis Area E1 level 9c Pedrazzi 2002, Fig. 23.2

### **Iron I-II**

IMP Megiddo VA-IVB Lamon & Shipton 1939, Fig. 32.169  
IMP Tell Sukas H Riis 1960, Fig. 13  
IMP Tyre X Bikai 1978b, Pl. 24.6

### **Iron II**

\* Al Mina IX Boardman 1959, Nos 8-9  
\* Al Mina IX Boardman 1959, No. 20  
IMP Hama Cem. IV Riis 1948, Fig. 134  
IMP Hama E Fugmann 1958, Figs 310 (7B23); 344 (L941)  
# Ras al-Bassit Findgroup C Braemer 1986, Fig. 3.8  
IMP Sidon Iron II Doumet-Serhal 2006, Fig. 25.19  
Tell Mastuma Central Area level I-2 Wakita *et al.* 2000, Fig. 9.5  
IMP Tell Qarqur 8 Dornemann 2003a, 47, Fig. 82.15



IMP Tyre VIII Bikai 1978b, Pl. 22.3  
IMP Tyre IX Bikai 1978b, Pl. 22.1-2  
IMP Tyre IX Bikai 1978b, Pl. 22.4

#### **Iron I-III**

IMP Akhziv East Cem XVII Dayagi-Mendels 2002, Fig. 4.14(21)

#### **Iron II-III**

IMP Al Mina IX/VIII Robertson 1940, Fig. 1.a-k  
IMP Al Mina IX/VIII Robertson 1940, Fig. 1.l-q  
\* Al Mina IX/VIII Boardman 1959, Nos 10, 13  
\*\* Al Mina VIII Boardman 1959, No. 4  
\* Al Mina VIII Boardman 1959, No. 15  
IMP Beirut Bey 003 abandonment Badre 1998, Fig. 8.1-2, 4  
IMP Beirut Bey 003 abandonment Badre 1998, Fig. 8.3  
IMP Beirut Bey 003 abandonment Badre 1998, Fig. 8.6  
IMP Tell Judeideh IV/III see Lehmann 1996, 467 (Form G3)

#### **Iron III**

\* Al Mina VII Boardman 1959, No. 16  
\* Al Mina VII/VI Boardman 1959, No. 17  
\* Tell Keisan 4 Briend & Humbert 1980, Pl. 29.13  
Tell Keisan 4 Briend & Humbert 1980, Pl. 29.14  
# Tell Keisan 5 Briend & Humbert 1980, Pl. 40.11

#### **Persian**

IMP Ras al-Bassit Cem. Courbin 1993a, Fig. 17.4(C563)  
IMP Ras al-Bassit Cem. Courbin 1993a, Fig. 17.5(C564), 6(C565)  
IMP Tell Keisan 3 Briend & Humbert 1980, Pl. 22.1-5  
IMP Tell Sukas South Harbour cem. Riis 1979, Figs 53-55, 67-70, 75-76, 85-86

#### **Unclear Context**

\* Al Mina Unstrat. Boardman 1959, No. 23  
\*\* Al Mina Unstrat. Boardman 1959, Nos 1-2  
\*\* Al Mina Unstrat. Boardman 1959, Nos 5-6, 24  
\* Al Mina Unstrat. Boardman 1959, Nos 19, 21-22  
\* Al Mina Unstrat. Boardman 1959, Nos 3, 7, 11-13, 18  
IMP Byblos Unstrat. Dunand 1950, No. 8.892, 17.605  
IMP Sarepta Area X Unstrat. Koehl 1985, Fig. 23.251-252  
IMP Tell Kazel Unstrat. Yon & Caubet 1990, Fig. 3.174  
IMP Tyre Unstrat. Coldstream & Bikai 1988, Nos 9-75

## **B.17.59 CLASS 192**

#### **Iron I-II**

Tell Mastuma Central Area level I Egami & Masuda 1982, Pl. 6.1  
Tell Mishrife Iron I/II Unpublished

#### **Iron II**

Tell Judeideh IV see Lehmann 1996, 383 (Form 122)

#### **Iron III**

Tell Judeideh III see Lehmann 1996, 383 (Form 122)

#### **Unclear Context**

# Al Mina Unstrat. du Plat Taylor 1959, Fig. 6.35  
Tell Judeideh Unstrat. see Lehmann 1996, 383 (Form 122)

## **B.17.60 CLASS 193**

#### **Iron II**

# Megiddo IVA Lamon & Shipton 1939, Fig. 26.81  
Tell Abou Danne IId/A6 Lebeau 1983, Pls 7.4; 11.3  
Tell Arqa 10 Thalmann 1978b, Fig. 47.13  
Tell Arqa 10 Unpublished  
Tell Kazel Area II level 4 Badre 1990b, Fig. 37.d-f  
Tell Qarqur 8 Dornemann 2003a, Fig. 83.21, 23

Tyre III Bikai 1978b, Pl. 10.19

#### **Iron II-III**

Beirut Bey 003 abandonment Badre 1997b, Fig. 37.8

Sarepta Area Y level C Anderson 1988, Pl. 37.10

#### **Iron III**

\* Al Mina V Lehmann 1996, Pl. 26 (164/1)

Al Mina V Lehmann 1996, Pl. 26 (165/1)

Al Mina V Lehmann 1996, Pl. 26 (168/2)

Megiddo II/III Lamon & Shipton 1939, Fig. 23.13-17

Tel Dan I Pakman 1992, Fig. 4.1-2

Tell Arqa 9 Thalmann 1978b, Fig. 47.12

Tell Judeideh III see Lehmann 1996, 391 (Form 168)

Tell Judeideh III see Lehmann 1996, 392 (Form 169a)

Tell Keisan 4 Briend & Humbert 1980, Pl. 28.1

Tell Keisan 4 Briend & Humbert 1980, Pl. 31.1-6

Tell Keisan 5 Briend & Humbert 1980, Pl. 45.5

#### **Iron III-Persian**

Tell Judeideh II/III see Lehmann 1996, 392 (Form 169a)

#### **Persian**

Al Mina IV Lehmann 1996, Pl. 26 (167/1)

Beirut Bey 010 Persian Doumet-Serhal & Sayegh 1998, 17

Beirut Bey 010 Persian Sapin & Sayegh 1998, 101(14)

Beirut Bey 010 Persian Sapin & Sayegh 1998, 104 (37-38)

Hazor II Yadin *et al.* 1958, Pl. 79.17-18, 20-21, 23-24, 26-27

Hazor II Yadin *et al.* 1960, Pl. 75.20-23

Hazor II Yadin *et al.* 1961, Pl. 257.1-10

Megiddo I Lamon & Shipton 1939, Fig. 23.13-14, 16

Sidon Persian Doumet-Serhal 2006, Fig. 18.2

Tell Judeideh II see Lehmann 1996, 392 (Form 169a)

Tell Kazel Area I level 4 Gubel 1990b, Fig. 2h

Tell Keisan 3 Briend & Humbert 1980, Pl. 20.15-21

Tell Rifa'at 1c Lehmann 1996, Pl. 28 (174/1)

Tell Rifa'at 1c Lehmann 1996, Pl. 28 (174/3)

Tell Sukas F Buhl 1983, Figs XII.167; XIV.189

Tell Sukas South Harbour Sanctuary Riis 1979, Fig. 154

#### **Unclear Context**

Byblos Unstrat. Dunand 1950, No. 11.473

Byblos Unstrat. Dunand 1950, No. 15.683

Sarepta Area X unstrat. Pritchard 1988, Fig. 40.29

Tell Rachidiah Tomb V Doumet 1982, Pl. XXII.2

# APPENDIX C

## Site Data

### C.1 Abou Danne, Tell

#### **Iib/A4**

Class 1a see Lehmann 1996, 450 (Form 438ab)

Class 9a see Lehmann 1996, 453 (Form 458)

Class 93a Tefnin 1980a, Fig. 7a-b

#### **Iic/A5**

Class 1a Lebeau 1983, Pl. 119.1-2

Class 9a Lebeau 1983, Pl. 119.3

Class 28 Lebeau 1983, Pl. 132.1

Class 37b Lebeau 1983, Pl. 135.3-4

Class 56 Lebeau 1983, Pls 111; 112.5-9

Class 93a Lebeau 1983, Pl. 136.3

Class 109 Lebeau 1983, Pl. 144.1

Class 134b Lebeau 1983, Pl. 104.2

Class 136 Lebeau 1983, Pl. 102.5

Class 139 Lebeau 1983, Pls 104.1-2; 105.1

Class 141a Lebeau 1983, Pls 105.5; 106.2

Class 141b Lebeau 1983, Pl. 106.3

Class 141c Lebeau 1983, Pl. 105.3-4

Class 141d Lebeau 1983, Pl. 104.3-5

Class 152 Lebeau 1983, Pl. 102.4

Class 152 Lebeau 1983, Pl. 103.5

Class 169 Lebeau 1983, 100.2

Class 170 Lebeau 1983, Pls 101.2-5; 102.1

Class 173b Lebeau 1983, Pl. 100.3-4

Class 176 Lebeau 1983, Pl. 100.1

#### **Iid/A6**

Class 1a Lebeau 1983, Pls 48.3-5; 49.1-7

Class 1b Lebeau 1983, Pl. 50.1-4

Class 2 Lebeau 1983, Pl. 51.1

Class 9a Lebeau 1983, Pl. 52.4-6

Class 9b Lebeau 1983, Pl. 51.2

Class 14 Lebeau 1983, Pl. 98.3

Class 28 Lebeau 1983, Pl. 97.1

Class 33 Lebeau 1983, Pls 78.1-3; 79.1-3

Class 37b Lebeau 1983, Pls 81.1-4; 82

Class 56 Lebeau 1983, Pl. 34.2-6

Class 84 Lebeau 1983, Pl. 144.2-3

Class 132 Lebeau 1983, Pl. 28.4

Class 134a Lebeau 1983, Pl. 26.2-4

Class 134b Lebeau 1983, Pl. 15.4

Class 134c Lebeau 1983, Pl. 31.4

Class 134e Lebeau 1983, Pl. 19.1-4

Class 137 Lebeau 1983, Pl. 33.3-4

Class 139 Lebeau 1983, Pl. 14.4

Class 141a Lebeau 1983, Pls 12.1-2; 25; 29.4;  
30.2-3

Class 141c Lebeau 1983, Pls 7.2-3; 10.1-3;  
15.3; 17.3-4; 21; 23; 24

Class 141d Lebeau 1983, Pl. 22.3-4

Class 142 Lebeau 1983, Pl. 33.1-2

Class 143 Lebeau 1983, Pl. 28.1

Class 161 Lebeau 1983, Pls 9.3; 16.1-4

Class 165b Lebeau 1983, Pl. 89.7, 9

Class 166 Lebeau 1983, Pls 89.8; 90.6, 8

Class 169 Lebeau 1983, Pl. 1.4

Class 170 Lebeau 1983, Pls 8.3-4; 9.4-5; 11.1

Class 173a Lebeau 1983, Pls 8.2; 14.1-2

Class 173b Lebeau 1983, Pl. 1.3

Class 174 Lebeau 1983, Pls 3; 4.1-7; 5.1-6;  
6.1-3, 5

Class 175 Lebeau 1983, Pl. 6.6

Class 176 Lebeau 1983, Pl. 2.1-6

Class 193 Lebeau 1983, Pls 7.4; 11.3

### C.2 Abu Hawam, Tell

#### **Stratum II**

Class 9a Hamilton 1935, Fig. 6

Class 12c Hamilton 1934, Pl. 23.5

Class 12c Hamilton 1935, Fig. 5

Class 25 Hamilton 1934, Pl. 23.14

Class 25 Hamilton 1935, Fig. 3

Class 27 Hamilton 1934, Pl. 23.12-13

Class 73 Hamilton 1934, Pl. 23.10

Class 93a Hamilton 1935, Fig. 7

Class 98 Hamilton 1934, Pl. 23.1, 8-9

Class 100b Hamilton 1934, Pl. 23.2

Class 115 Hamilton 1934, Pl. 23.4

Class 151 Hamilton 1935, 15, Nos 7-8

Class 157 Hamilton 1935, 14, No. 1

Class 171 Hamilton 1935, Fig. 4

#### **Stratum III**

Class 6 Hamilton 1935, 22, No. 80

Class 6 Hamilton 1935, Pl. 13.76

Class 8b Hamilton 1935, Fig. 10b

Class 8c Hamilton 1935, Fig. 10a

Class 8e Hamilton 1935, 23, No. 90

Class 12a Hamilton 1935, 23, No. 93

Class 12b Hamilton 1935, 23, No. 92  
 Class 12c Hamilton 1935, 23, No. 94  
 Class 19 Hamilton 1935, 24, No. 97  
 Class 42 Hamilton 1934, Pl. 23.23  
 Class 57b Hamilton 1935, Pl. 13.79  
 Class 73 Hamilton 1935, Pl. 13.82  
 Class 77 Hamilton 1934, Pl. 23.22  
 Class 77 Hamilton 1935, 19, No. 52  
 Class 84 Hamilton 1935, Pl. 13.86  
 Class 85b Hamilton 1935, Pl. 13.78  
 Class 88 Hamilton 1935, Pl. 13.67  
 Class 100b Hamilton 1934, Pl. 23.30  
 Class 100b Hamilton 1935, Fig. 12  
 Class 100b Hamilton 1935, 20, Nos 57-58  
 Class 100d Hamilton 1935, Pl. 13.91  
 Class 102a Hamilton 1934, Pl. 23.28  
 Class 102a Hamilton 1935, 19, Nos 53-54  
 Class 102a Hamilton 1935, Pl. 13.89  
 Class 102b Hamilton 1934, Pl. 23.26-27  
 Class 102b Hamilton 1935, 19, Nos 55-56  
 Class 103a Hamilton 1934, Pl. 23.19-21  
 Class 103a Hamilton 1935, Pl. 13.63  
 Class 103a Hamilton 1935, 20, Nos 60-61  
 Class 103a Hamilton 1935, Fig. 11  
 Class 120 Hamilton 1935, Pl. 13.87  
 Class 121f Hamilton 1934, Pl. 23.25  
 Class 131a Hamilton 1934, Pl. 23.24  
 Class 131a Hamilton 1935, Pl. 13.66  
 Class 134b Hamilton 1935, 21, No. 72  
 Class 131b Hamilton 1935, 23, No. 88  
 Class 155 Hamilton 1935, Fig. 9  
 Class 155 Hamilton 1935, Pl. 13.68  
 Class 155 Hamilton 1935, 21, No. 69  
 Class 160a Hamilton 1935, 21, No. 70  
 Class 161 Hamilton 1935, 21, No. 75  
 Class 162 Hamilton 1935, 22, No. 85  
 Class 163 Hamilton 1935, Fig. 8  
 Class 165a Hamilton 1935, 22, No. 77  
 Class 165a Hamilton 1935, 22, No. 84  
 Class 173a Hamilton 1935, 21, No. 71

Class 173a Hamilton 1935, 21, No. 73

#### **Stratum IV**

Class 6 Hamilton 1935, 29, No. 160  
 Class 12c Hamilton 1935, 30, No. 163  
 Class 57c Hamilton 1935, Fig. 13  
 Class 77 Hamilton 1935, 28, No. 152  
 Class 77 Hamilton 1935, Pl. 14.158  
 Class 78 Hamilton 1935, Fig. 14  
 Class 100b Hamilton 1935, 30, No. 167  
 Class 102a Hamilton 1935, Pl. 14.161-162  
 Class 102a Hamilton 1935, 30, No. 166  
 Class 102b Hamilton 1935, Pl. 14.157  
 Class 102c Hamilton 1935, 31, No. 171  
 Class 130 Hamilton 1935, 30, No. 170  
 Class 134d Hamilton 1935, 30, No. 164  
 Class 157 Hamilton 1935, 29, No. 154  
 Class 162 Hamilton 1935, 29, No. 156  
 Class 162 Hamilton 1935, Fig. 15  
 Class 164 Hamilton 1935, 29, No. 153  
 Class 170 Hamilton 1935, 30, No. 165

#### **Stratum V/IV**

Class 4b Hamilton 1934, Pl. 22.17  
 Class 12a Hamilton 1935, 49, No. 300  
 Class 12b Hamilton 1934, Pl. 22.26  
 Class 12c Hamilton 1934, Pl. 22.24-25  
 Class 21 Hamilton 1935, 48, No. 296  
 Class 78 Hamilton 1934, Pl. 22.8  
 Class 78 Hamilton 1935, 41, No. 251  
 Class 102a Hamilton 1934, Pl. 22.3  
 Class 102b Hamilton 1934, Pl. 22.11  
 Class 102b Hamilton 1935, 41, No. 246  
 Class 102c Hamilton 1934, Pl. 22.2  
 Class 104 Hamilton 1935, 40, No. 241  
 Class 111 Hamilton 1935, 41, No. 248  
 Class 116 Hamilton 1934, Pl. 22.1, 7  
 Class 116 Hamilton 1935, 47, Nos 287-288  
 Class 127 Hamilton 1934, Pl. 22.18  
 Class 127 Hamilton 1935, 48, No. 298  
 Class 176 Hamilton 1934, Pl. 22.4  
 Class 184 Hamilton 1934, Pl. 22.15

## **C.3 Afis, Tell**

### **Area A (Afis VIII/IX)**

Class 1a Soldi 2005, Fig. 20.9-10  
 Class 1b Soldi 2005, Fig. 20.11  
 Class 9a Maternawi 2005, Fig. 26.7  
 Class 134d D'Amore 2005, Fig. 16.3  
 Class 141a Soldi 2005, Fig. 20.4  
 Class 141c Soldi 2005, Fig. 20.3  
 Class 182a Soldi 2005, Fig. 20.1  
 Class 184 D'Amore 2005, Fig. 16.1  
 Class 184 Soldi 2005, Fig. 20.2

### **Area B (Afis IX)**

Class 1b Mazzoni 2000b, Fig. 3.14, 16  
 Class 1c Scigliuzzo 2002, Fig. 13.9  
 Class 5 Mazzoni 2000b, Fig. 3.13  
 Class 54 Scigliuzzo 2002, Fig. 13.7  
 Class 134d Mazzoni 2000b, Fig. 3.5  
 Class 141d Mazzoni 2000b, Fig. 3.6

### **Area B (Afis VIII)**

Class 1b Scigliuzzo 2002, Fig. 12.9  
 Class 1b Scigliuzzo 2005, Fig. 37.1  
 Class 1c Scigliuzzo 2002, Fig. 13.9  
 Class 1c Virgilio 2005, Fig. 34.10  
 Class 7b Virgilio 2005, Fig. 34.9  
 Class 37b Scigliuzzo 2002, Figs 12.11; 13.10-11  
 Class 37b Virgilio 2005, Fig. 35.9  
 Class 53b Scigliuzzo 2005, Fig. 37.8  
 Class 54 Scigliuzzo 2002, Fig. 13.7  
 Class 54 Virgilio 2005, Fig. 35.5  
 Class 54 Scigliuzzo 2005, Fig. 37.5  
 Class 56 Scigliuzzo 2002, Fig. 12.8  
 Class 80 Virgilio 2005, Fig. 35.1  
 Class 102a Virgilio 2005, Fig. 35.2  
 Class 134e Scigliuzzo 2002, Fig. 13.2, 4

- Class 134e Virgilio 2005, Fig. 34.3  
 Class 141d Scigliuzzo 2002, Fig. 12.1  
 Class 161 Scigliuzzo 2005, Fig. 37.2  
 Class 162 Virgilio 2005, Fig. 34.2  
 Class 168 Scigliuzzo 2002, Fig. 12.10  
 Class 176 Scigliuzzo 2002, Fig. 13.1  
 Class 184 Scigliuzzo 2002, Figs 12.2-5; 13.3  
 Class 184 Virgilio 2005, Fig. 34.5-7  
 Class 184 Scigliuzzo 2005, Fig. 37.4  
 Class 188 Virgilio 2005, Fig. 34.4
- Area D level 1**  
 Class 1a Mazzoni 1988a, Fig. 8.15-16  
 Class 1b Mazzoni 1988a, Fig. 8.11-14  
 Class 37b Mazzoni 1988a, Fig. 8.17-18  
 Class 37b Cecchini 1988, Fig. 9.1-2  
 Class 54 Mazzoni 1988a, Fig. 8.7  
 Class 134e Cecchini 1988, Fig. 6.4  
 Class 141c Mazzoni 1988a, Fig. 8.6  
 Class 141d Mazzoni 1988a, Fig. 8.4, 10  
 Class 155 Mazzoni 1988a, Fig. 8.3  
 Class 169 Mazzoni 1988a, Fig. 8.1  
 Class 176 Mazzoni 1988a, Fig. 8.2  
 Class 183 Mazzoni 1988a, Fig. 8.8; Mazzoni 1988a, Fig. 8.8
- Area D level 2**  
 Class 1a Mazzoni 1988a, Fig. 12.1-4, 6  
 Class 1b Mazzoni 1988a, Fig. 12.5, 8  
 Class 1c Mazzoni 1988a, Fig. 12.9, 12-13  
 Class 1d Mazzoni 1988a, Fig. 12.7, 10  
 Class 7b Mazzoni 1988a, Fig. 12.11  
 Class 37b Cecchini 1988, Fig. 9.3-4  
 Class 37b Mazzoni 1988a, Fig. 13.1-9  
 Class 54 Cecchini 1988, Fig. 6.15-16  
 Class 54 Mazzoni 1988a, Fig. 10.6, 12, 14, 17-18  
 Class 105 Mazzoni 1988a, Fig. 11.1-2  
 Class 134a Mazzoni 1988a, Fig. 9.25-26  
 Class 134c Mazzoni 1988a, Fig. 9.4  
 Class 134d Mazzoni 1988a, Fig. 9.22  
 Class 134e Mazzoni 1988a, Fig. 10.7-11, 13  
 Class 141b Mazzoni 1988a, Fig. 9.11  
 Class 141c Mazzoni 1988a, Fig. 10.1-3, 5  
 Class 141d Mazzoni 1988a, Fig. 10.4, 10  
 Class 149 Mazzoni 1988a, Fig. 9.23; Oggiano 1997, Pl. V.10  
 Class 161 Mazzoni 1988a, Fig. 9.17  
 Class 162 Mazzoni 1988a, Fig. 9.18; Oggiano 1997, Pl. V.8  
 Class 170 Mazzoni 1988a, Fig. 9.9  
 Class 173a Mazzoni 1988a, Fig. 9.12  
 Class 176 Mazzoni 1988a, Fig. 9.1-3, 5, 7  
 Class 181 Cecchini 1988, Fig. 6.11  
 Class 182a Cecchini 1988, Fig. 6.5-7, 9  
 Class 182a Mazzoni 1988a, Fig. 9.15, 19-20  
 Class 182b Mazzoni 1988a, Fig. 9.16, 21  
 Class 182c Cecchini 1988, Fig. 6.8  
 Class 182c Mazzoni 1988a, Fig. 9.14  
 Class 183 Mazzoni 1988a, Fig. 9.8  
 Class 184 Cecchini 1988, Fig. 6.10  
 Class 184 Mazzoni 1988a, Fig. 9.6, 10
- Class 188 Mazzoni 1988a, Fig. 9.13
- Area D level 3**  
 Class 1a Mazzoni 1988a, Fig. 14.16  
 Class 1b Mazzoni 1988a, Fig. 14.13, 15  
 Class 1c Mazzoni 1988a, Fig. 14.12  
 Class 37b Mazzoni 1988a, Fig. 14.17-19  
 Class 37b Cecchini 1988, Figs 9.5-6; 10.1-2  
 Class 54 Mazzoni 1988a, Fig. 14.5; Cecchini 1988, Fig. 6.23  
 Class 100b Mazzoni 1988a, Fig. 14.1  
 Class 134a Cecchini 1988, Fig. 6.21  
 Class 134c Mazzoni 1988a, Fig. 14.8  
 Class 134d Mazzoni 1988a, Fig. 14.10  
 Class 134e Mazzoni 1988a, Fig. 14.6  
 Class 141a Mazzoni 1988a, Fig. 14.7  
 Class 141d Mazzoni 1988a, Fig. 14.11  
 Class 182a Cecchini 1988, Fig. 6.18  
 Class 182a Mazzoni 1988a, Fig. 14.2, 4  
 Class 182b Cecchini 1988, Fig. 6.19  
 Class 184 Mazzoni 1988a, Fig. 14.3
- Area D level 4**  
 Class 1a Mazzoni 1988a, Fig. 19.45  
 Class 1b Mazzoni 1988a, Fig. 19.3, 6  
 Class 1c Mazzoni 1988a, Fig. 19.1-2, 7-8  
 Class 1d Mazzoni 1988a, Fig. 17.11, 13  
 Class 5 Mazzoni 1988a, Fig. 19.10; Cecchini 1988, Fig. 7.8  
 Class 12c Mazzoni 1988a, Fig. 7.5  
 Class 12b Cecchini 1988, Fig. 11.16  
 Class 15 Cecchini 1988, Fig. 11.17  
 Class 37b Cecchini 1988, Figs 10.3-6; 11.1-6  
 Class 37b Mazzoni 1988a, Fig. 19.11, 14, 16, 18  
 Class 54 Cecchini 1988, Fig. 7.1  
 Class 54 Mazzoni 1988a, Fig. 17.1-10  
 Class 56 Cecchini 1988, Fig. 7.2  
 Class 57c Mazzoni 1988a, Fig. 18.18  
 Class 68 Mazzoni 1988a, Fig. 18.16, 19  
 Class 125 Mazzoni 1988a, Fig. 17.12  
 Class 134a Cecchini 1988, Figs 7.11-13; 8.1  
 Class 134c Mazzoni 1988a, Fig. 15.1  
 Class 134d Mazzoni 1988a, Fig. 15.15-16; Cecchini 1988, Figs 7.16; 8.5  
 Class 134e Mazzoni 1988a, Fig. 15.14, 17; Cecchini 1988, Fig. 8.2-4  
 Class 141d Mazzoni 1988a, Fig. 15.22, 24  
 Class 149 Mazzoni 1988a, Fig. 7.1  
 Class 152 Mazzoni 1988a, Fig. 15.20  
 Class 160a Mazzoni 1988a, Fig. 15.18  
 Class 162 Mazzoni 1988a, Fig. 15.21  
 Class 171 Mazzoni 1988a, Fig. 16.10  
 Class 173b Cecchini 1988, Fig. 8.13-15  
 Class 173b Mazzoni 1988a, Fig. 15.4-5  
 Class 174 Cecchini 1988, Fig. 8.8-9  
 Class 176 Mazzoni 1988a, Fig. 16.1-9, 11-14  
 Class 181 Mazzoni 1988a, Fig. 15.3  
 Class 182a Mazzoni 1988a, Fig. 15.6, 8; Cecchini 1988, Fig. 7.23-33  
 Class 182b Cecchini 1988, Fig. 7.19  
 Class 182c Cecchini 1988, Fig. 7.20-22

Class 183 Mazzoni 1988a, Fig. 15.11  
Class 184 Mazzoni 1988a, Fig. 15.7, 9-10, 12-13

Class 188 Cecchini 1988, Fig. 7.5, 10  
Class 189 Cecchini 1988, Fig. 7.4

#### **Area D level 5**

Class 1c Mazzoni 1988a, Fig. 20.17  
Class 37b Mazzoni 1988a, Fig. 20.18-20  
Class 56 Mazzoni 1988a, Fig. 20.16  
Class 134e Mazzoni 1988a, Fig. 20.8  
Class 134d Mazzoni 1988a, Fig. 20.4  
Class 141d Mazzoni 1988a, Fig. 20.10  
Class 143 Mazzoni 1988a, Fig. 20.5  
Class 176 Mazzoni 1988a, Fig. 20.2-3, 6-7, 9  
Class 184 Mazzoni 1988a, Fig. 20.1

#### **Area D level 6**

Class 1b Mazzoni 1988a, Fig. 22.17  
Class 1c Mazzoni 1988a, Fig. 22.15-16, 18  
Class 1d Mazzoni 1988a, Fig. 22.19-20  
Class 15 Mazzoni 1988a, Fig. 22.10  
Class 37b Mazzoni 1988a, Fig. 23.1-6  
Class 54 Mazzoni 1988a, Fig. 22.1-4  
Class 134c Mazzoni 1988a, Fig. 21.13, 20-21, 24

Class 134d Mazzoni 1988a, Fig. 21.12  
Class 134e Mazzoni 1988a, Fig. 21.10-11  
Class 141c Mazzoni 1988a, Fig. 21.8

#### **Area E1 level 3**

Class 1a Mazzoni 1998a, Fig. 22.7-8  
Class 5 Mazzoni 1998a, Fig. 22.10  
Class 7b Mazzoni 1998a, Fig. 22.9  
Class 37b Mazzoni 1990a, Fig. 6  
Class 37b Mazzoni 1998a, Fig. 23.2, 5  
Class 53b Mazzoni 1992b, Fig. 9.5  
Class 57b Mazzoni 1998a, Fig. 22.2  
Class 172 Mazzoni 1992b, Fig. 9.9  
Class 175 Mazzoni 1998a, Fig. 22.4-5  
Class 182b Mazzoni 1992b, Fig. 9.7  
Class 188 Bonatz 1998, Fig. 2.1

#### **Area E1 level 4**

Class 1a Mazzoni 1998a, Fig. 20.7-8  
Class 5 Mazzoni 1998a, Fig. 20.11  
Class 7b see Lehman 1996, 452 (Form 446)  
Class 12b Mazzoni 1992b, Fig. 10.4  
Class 12b Mazzoni 1998a, Fig. 19.12  
Class 37a Mazzoni 1998a, Fig. 23.1, 6  
Class 37b Mazzoni 1990a, Fig. 6  
Class 37b Mazzoni 1998a, Fig. 23.3-4  
Class 57b Mazzoni 1998a, Fig. 19.1-2  
Class 173a Mazzoni 1992b, Fig. 10.2  
Class 191 Bonatz 1998, Fig. 5.3

#### **Area E1 level 5**

Class 1a Mazzoni 1998a, Fig. 20.9  
Class 5 Mazzoni 1998a, Fig. 20.10  
Class 37a Mazzoni 1998a, Fig. 21.1-2  
Class 37b Mazzoni 1990a, Fig. 6  
Class 37b Mazzoni 1998a, Fig. 21.3  
Class 56 Mazzoni 1992b, Fig. 11.3  
Class 56 Mazzoni 1998a, Fig. 19.4  
Class 174 Mazzoni 1998a, Fig. 19.11

Class 174 Mazzoni 1988a, Fig. 21.9  
Class 176 Mazzoni 1988a, Fig. 21.18-19, 22-23, 25-26

Class 182a Mazzoni 1988a, Fig. 21.2, 5  
Class 182b Mazzoni 1988a, Fig. 21.3  
Class 182c Mazzoni 1988a, Fig. 21.6  
Class 188 Mazzoni 1988a, Fig. 21.4

#### **Area E1 level 1**

Class 8a Mazzoni 1992b, Fig. 13.1  
Class 37b Mazzoni 1992b, Fig. 15.1

#### **Area E1 level 2**

Class 1a Mazzoni 1998a, Fig. 25.10  
Class 1b Mazzoni 1998a, Fig. 25.9 | 2000b, Fig. 6.12-15  
Class 7b see Lehmann 1996, 452 (Form 446)  
Class 8a Mazzoni 1998a, Fig. 25.11  
Class 37a Mazzoni 1998a, Fig. 26.5  
Class 37b Mazzoni 1990a, Fig. 6  
Class 37b Mazzoni 1998a, Fig. 26.1-4  
Class 53b see Lehmann 1996, 395 (Form 191)  
Class 54 Mazzoni 1998a, Fig. 25.1-3, 5  
Class 134a Mazzoni 1998a, Fig. 24.8, 9  
Class 134e Mazzoni 1998a, Fig. 24.7  
Class 141d Mazzoni 1998a, Fig. 24.10  
Class 176 Mazzoni 1998a, Fig. 24.3-4  
Class 184 Mazzoni 2000b, Fig. 6.10

#### **Area E1 level 6**

Class 5 Mazzoni 1998a, Fig. 18.16-18  
Class 7b Mazzoni 1998a, Fig. 18.15  
Class 37a Mazzoni 1998a, Fig. 21.5-6, 8  
Class 37a Venturi 2000a, Fig. 12.16, 19  
Class 37b Mazzoni 1990a, Fig. 6  
Class 37b Mazzoni 1998a, Fig. 21.3, 7

#### **Area E1 level 7**

Class 4d Venturi 2000c, Fig. 9.15  
Class 5 Venturi 2000b, Fig. 12.15  
Class 5 Venturi 2000c, Fig. 9.14, 16  
Class 37a Mazzoni 1998a, Fig. 17.7-9  
Class 37b Mazzoni 1998a, Fig. 17.6  
Class 40a Venturi 2000a, Fig. 11.11  
Class 42 Mazzoni 1998a, Fig. 16.8  
Class 53b Venturi 2000c, Fig. 9.8  
Class 56 Mazzoni 1998a, Fig. 16.5  
Class 57b Mazzoni 1998a, Fig. 16.7, 9-10; Venturi 2000a, Fig. 11.1

Class 141c Mazzoni 1998a, Fig. 17.2  
Class 160a Mazzoni 1998a, Fig. 17.1  
Class 174 Venturi 2000a, Fig. 11.8; 12.3  
Class 176 Venturi 2000a, Fig. 11.9  
Class 176 Venturi 2000c, Fig. 9.9  
Class 186 Mazzoni 1998a, Fig. 16.1  
Class 188 Venturi 2000a, Fig. 11.2-6  
Class 188 Venturi 2000b, Fig. 12.5  
Class 188 Venturi 2000c, Fig. 9.3  
Class 188 Bonatz 1998, Fig. 2.2

#### **Area E1 level 8**

Class 3 Venturi 1998a, Fig. 8.2  
Class 4b Venturi 1998a, Figs 8.5; 9.5, 13.8, 10  
Class 5 Venturi 1998a, Fig. 8.3

Class 15 Venturi 1998a, Fig. 4.7  
 Class 37b Venturi 1998a, Figs 10.1-3; 12.18  
 Class 53b Venturi 2002, Fig. 21.3, 5  
 Class 176 Venturi 1998a, Figs 5.1, 13.3  
 Class 176 Venturi 2000b, Fig. 12.6  
 Class 188 Bonatz 1998, Figs 2.3-4; 3.5-6, 8  
 Class 188 Venturi 2000b, Fig. 12.3-4  
**Area E1 level 9a**  
 Class 4b Venturi 1998a, Fig. 8.4  
 Class 4b Venturi 2000a, Fig. 10.1, 4, 8  
 Class 5 Venturi 1998a, Figs 8.1; 9.1  
 Class 5 Venturi 2000a, Figs 8.10-11; 10.2  
 Class 7b Venturi 2000a, Fig. 10.9  
 Class 15 Venturi 1998a, Fig. 4.6  
 Class 37a Venturi 1998a, Fig. 10.4-6  
 Class 37b Venturi 2000a, Fig. 8.14-15  
 Class 40a Venturi 1998a, Fig. 6.2  
 Class 40a Venturi 2000a, Fig. 9.8-9  
 Class 48b Venturi 2000a, Fig. 7.10  
 Class 56 Venturi 1998a, Figs 6.3; 7.15  
 Class 57b Venturi 2000a, Fig. 7.13  
 Class 102a Venturi 2000a, Fig. 7.16  
 Class 162 Venturi 2000a, Fig. 7.8  
 Class 176 Venturi 1998a, Fig. 5.2, 11, 15  
 Class 176 Venturi 2000a, Fig. 7.7  
 Class 186 Venturi 2000a, Fig. 7.14  
 Class 188 Venturi 2000a, Figs 7.2; 9.2  
 Class 188 Venturi 2000b, Fig. 12.1-2  
**Area E1 level 9b**  
 Class 4d Venturi 2000a, Fig. 6.12  
 Class 37a Venturi 2000a, Fig. 6.17-18  
 Class 37b Venturi 2000a, Fig. 6.15  
 Class 56 Venturi 1998a, Fig. 4.1  
 Class 56 Venturi 2000a, Fig. 6.13-14, 16  
 Class 56 Venturi 2002, Fig. 21.4  
 Class 174 Venturi 2000a, Fig. 6.7  
 Class 176 Venturi 1998a, Fig. 5.3, 11-12  
 Class 182a Venturi 2000a, Fig. 6.4  
 Class 188 Venturi 2000a, Fig. 6.2  
 Class 188 Venturi 2002, Fig. 21.1-2  
**Area E1 level 9c**  
 Class 5 Pedrazzi 2002, Fig. 23.13  
 Class 15 Venturi 2000c, Fig. 6.1  
 Class 35 Venturi 1998a, Fig. 11.1-4  
 Class 36 Venturi 2000c, Fig. 6.2-3  
 Class 37a Pedrazzi 2002, Fig. 24.3  
 Class 53b Pedrazzi 2002, Fig. 23.7  
 Class 56 Venturi 1998a, Fig. 6.4-6  
 Class 131a Pedrazzi 2002, Fig. 24.1  
 Class 143 Venturi 1998a, Fig. 5.3, 9  
 Class 160a Venturi 1998a, Fig. 7.12  
 Class 170 Venturi 1998a, Fig. 5.8  
 Class 170 Pedrazzi 2002, Fig. 23.12  
 Class 174 Pedrazzi 2002, Fig. 23.9, 11  
 Class 175 Venturi 1998a, Fig. 5.6  
 Class 176 Venturi 1998a, Fig. 5.4, 12-13, 16  
 Class 176 Pedrazzi 2002, Fig. 23.10  
 Class 182b Venturi 1998a, Fig. 7.14  
 Class 188 Pedrazzi 2002, Figs 23.1, 3-6; 24.2  
 Class 191 Pedrazzi 2002, Fig. 23.2

**Area E2 level 1**  
 Class 1a Degli Esposti 1998, Fig. 12.19  
 Class 37b Degli Esposti 1998, Fig. 13.5  
 Class 125 Degli Esposti 1998, Fig. 12.12  
 Class 134d Degli Esposti 1998, Fig. 10.19  
 Class 134e Degli Esposti 1998, Fig. 10.21  
 Class 141c Degli Esposti 1998, Fig. 10.12  
 Class 141d Degli Esposti 1998, Figs 10.18;  
 11.3-4  
 Class 155 Degli Esposti 1998, Fig. 10.3  
 Class 160a Degli Esposti 1998, Fig. 10.9-10  
 Class 169 Degli Esposti 1998, Fig. 10.2  
 Class 173a Degli Esposti 1998, Fig. 10.5, 13  
 Class 176 Degli Esposti 1998, Fig. 10.6  
 Class 182b Degli Esposti 1998, Fig. 10.14  
 Class 183 Degli Esposti 1998, Fig. 10.8  
 Class 188 Degli Esposti 1998, Figs 10.11, 22;  
 11.6  
**Area E2 level 2**  
 Class 1a Degli Esposti 1998, Fig. 12.18, 21-22  
 Class 37b Degli Esposti 1998, Fig. 13.1, 3  
 Class 56 Degli Esposti 1998, Fig. 11.2, 5  
 Class 134d Degli Esposti 1998, Fig. 10.20  
 Class 141c Degli Esposti 1998, Fig. 10.15  
 Class 168 Degli Esposti 1998, Fig. 10.1  
 Class 175 Degli Esposti 1998, Fig. 10.16  
 Class 176 Degli Esposti 1998, Fig. 10.4, 7  
 Class 183 Degli Esposti 1998, Fig. 10.17  
 Class 187 Degli Esposti 1998, Fig. 10.23  
**Area E2 level 3**  
 Class 40b Degli Esposti 1998, Fig. 7.12  
 Class 56 Degli Esposti 1998, Fig. 7.19  
 Class 175 Degli Esposti 1998, Fig. 7.9  
 Class 176 Degli Esposti 1998, Fig. 7.1  
 Class 183 Degli Esposti 1998, Fig. 7.6-8  
**Area E2 level 4**  
 Class 1a Degli Esposti 1998, Fig. 9.2  
 Class 4b Degli Esposti 1998, Fig. 9.4  
 Class 4c Degli Esposti 1998, Fig. 9.1  
 Class 4d Degli Esposti 1998, Fig. 9.3  
 Class 5 Degli Esposti 1998, Fig. 9.5  
 Class 37b Degli Esposti 1998, Fig. 13.4, 6-10  
 Class 173a Degli Esposti 1998, Fig. 7.9  
 Class 187 Degli Esposti 1998, Fig. 7.4  
**Area E4 (Afis VII)**  
 Class 5 Chiti 2005, Fig. 49.9, 11  
 Class 37b Chiti 2005, Fig. 50.7  
 Class 53b Chiti 2005, Fig. 49.1  
 Class 108 Chiti 2005, Fig. 50.6  
 Class 123 Chiti 2005, Fig. 49.2  
 Class 131a Venturi 2005, Fig. 54.5  
 Class 188 Chiti 2005, Fig. 50.2  
 Class 188 Venturi 2005, Fig. 54.1-4, 6  
**Area G (Iron IA)**  
 Class 53b Canuti 2000, Fig. 17.3  
 Class 188 Canuti 2000, Fig. 17.1-2  
**Area G (Iron IC)**  
 Class 3 Canuti 2000, Fig. 17.16  
 Class 53b Canuti 2000, Fig. 17.6  
 Class 56 Canuti 2000, Fig. 17.7, 15

- Class 176 Canuti 2000, Fig. 17.5  
 Class 183 Canuti 2000, Fig. 17.14  
 Class 187 Canuti 2000, Fig. 17.13
- Area Gc level 1**  
 Class 1c Cecchini 1998, Fig. 37.4-5  
 Class 141c Cecchini 1998, Fig. 37.1
- Area Gc level 2**  
 Class 1a Cecchini 1998, Fig. 36.15-18  
 Class 1c Cecchini 1998, Fig. 36.21  
 Class 15 Cecchini 1998, Fig. 37.6-7  
 Class 37b Cecchini 1998, Fig. 36.24  
 Class 100b Cecchini 1998, Fig. 36.8  
 Class 141a Cecchini 1998, Fig. 35.20  
 Class 141b Cecchini 1998, Fig. 35.19  
 Class 141c Cecchini 1998, Fig. 35.2-3, 12-18  
 Class 141d Cecchini 1998, Fig. 35.4  
 Class 149 Cecchini 1998, Fig. 35.11  
 Class 173a Cecchini 1998, Fig. 35.8-9  
 Class 182b Cecchini 1998, Fig. 35.1, 6-7
- Area Gc level 3**  
 Class 1a Cecchini 1998, Fig. 34.5-6  
 Class 1d Cecchini 1998, Fig. 34.3  
 Class 5 Cecchini 1998, Fig. 34.7-8  
 Class 7b Cecchini 1998, Fig. 34.4  
 Class 56 Cecchini 1998, Fig. 33.17  
 Class 134e Cecchini 1998, Fig. 33.16  
 Class 139 Cecchini 1998, Fig. 33.12, 15  
 Class 141a Cecchini 1998, Fig. 33.10  
 Class 141c Cecchini 1998, Fig. 33.6-9, 13-14  
 Class 182a Cecchini 1998, Fig. 33.4-5
- Area Gc level 4**  
 Class 1a Cecchini 1998, Fig. 32.18-20  
 Class 1b Cecchini 1998, Fig. 32.21  
 Class 1c Cecchini 1998, Fig. 32.22  
 Class 12a Cecchini 1998, Fig. 37.11  
 Class 37b Cecchini 1998, Fig. 32.23  
 Class 134b Cecchini 1998, Fig. 31.21  
 Class 134e Cecchini 1998, Figs 31.11; 32.4  
 Class 141a Cecchini 1998, Fig. 32.1  
 Class 141c Cecchini 1998, Fig. 31.12-14, 16, 24-28  
 Class 141d Cecchini 1998, Fig. 32.6  
 Class 157 Cecchini 1998, Fig. 31.15  
 Class 173a Cecchini 1998, Fig. 31.4, 6-8, 23  
 Class 174 Cecchini 1998, Fig. 31.3  
 Class 175 Cecchini 1998, Fig. 31.20, 22  
 Class 176 Cecchini 1998, Fig. 31.1, 17  
 Class 182a Cecchini 1998, Fig. 31.9  
 Class 182b Cecchini 1998, Fig. 31.10  
 Class 188 Cecchini 1998, Fig. 32.3
- Area Gc level 5**  
 Class 1a Cecchini 1998, Fig. 30.16-17  
 Class 5 Cecchini 1998, Fig. 30.18  
 Class 7b Cecchini 1998, Fig. 30.19  
 Class 54 Cecchini 1998, Fig. 29.16  
 Class 56 Cecchini 1998, Fig. 30.1-2  
 Class 102b Cecchini 1998, Fig. 29.2  
 Class 134d Cecchini 1998, Fig. 29.26  
 Class 139 Cecchini 1998, Fig. 29.15  
 Class 141a Cecchini 1998, Fig. 29.13, 23, 25
- Class 141c Cecchini 1998, Fig. 29.11-12, 14, 21-22  
 Class 172 Cecchini 1998, Fig. 29.18  
 Class 173a Cecchini 1998, Fig. 29.5-7  
 Class 174 Cecchini 1998, Fig. 29.19-20  
 Class 175 Cecchini 1998, Fig. 29.8-9, 19  
 Class 182a Cecchini 1998, Fig. 29.4  
 Class 182b Cecchini 1998, Fig. 29.3
- Area Gc level 6**  
 Class 1a Cecchini 1998, Fig. 28.23-24, 27  
 Class 1b Cecchini 1998, Fig. 28.26  
 Class 5 Cecchini 1998, Figs 26.22; 28.25  
 Class 54 Cecchini 1998, Figs 27.21; 28.2  
 Class 134a Cecchini 1998, Fig. 26.11  
 Class 134d Cecchini 1998, Figs 26.15; 27.7  
 Class 134e Cecchini 1998, Fig. 27.8-10  
 Class 139 Cecchini 1998, Figs 26.8, 19-21, 23  
 Class 141a Cecchini 1998, Figs 26.17; 27.14-16  
 Class 141c Cecchini 1998, Fig. 26.14, 16, 18  
 Class 141c Cecchini 1998, Fig. 27.12-13, 18  
 Class 141d Cecchini 1998, Fig. 27.11, 19-20  
 Class 162 Cecchini 1998, Fig. 27.5  
 Class 170 Cecchini 1998, Fig. 27.4  
 Class 173a Cecchini 1998, Fig. 26.12-13  
 Class 173a Cecchini 1998, Fig. 27.2  
 Class 174 Cecchini 1998, Fig. 26.4  
 Class 174 Cecchini 1998, Fig. 27.6  
 Class 178 Cecchini 1998, Fig. 27.1  
 Class 182b Cecchini 1998, Fig. 26.5, 7  
 Class 182c Cecchini 1998, Fig. 26.9
- Area Gc level 7b**  
 Class 1b Cecchini 1998, Fig. 25.15-22  
 Class 12b Cecchini 1998, Fig. 37.8-9  
 Class 54 Cecchini 1998, Fig. 21.20  
 Class 56 Cecchini 1998, Fig. 21.23  
 Class 134a Cecchini 1998, Fig. 24.3  
 Class 134b Cecchini 1998, Fig. 20.22-23  
 Class 134d Cecchini 1998, Fig. 20.26-27  
 Class 134d Cecchini 1998, Fig. 22.12  
 Class 134e Cecchini 1998, Fig. 21.13, 19  
 Class 134e Cecchini 1998, Figs 23.7-10; 24.1  
 Class 139 Cecchini 1998, Fig. 20.14  
 Class 139 Cecchini 1998, Fig. 21.6-8, 10-12, 17  
 Class 139 Cecchini 1998, Fig. 22.17  
 Class 141a Cecchini 1998, Fig. 20.28  
 Class 141a Cecchini 1998, Fig. 22.16  
 Class 141b Cecchini 1998, Fig. 21.9  
 Class 141c Cecchini 1998, Figs 20.25, 30; 21.1-5, 18; 22.14-15  
 Class 141d Cecchini 1998, Fig. 20.21  
 Class 141d Cecchini 1998, Figs 22.18-24; 23.1-6  
 Class 143 Cecchini 1998, Fig. 20.29  
 Class 152 Cecchini 1998, Fig. 20.15, 17  
 Class 153 Cecchini 1998, Fig. 22.6  
 Class 157 Cecchini 1998, Fig. 20.20  
 Class 168 Cecchini 1998, Fig. 22.1  
 Class 170 Cecchini 1998, Fig. 20.12



Class 173a Cecchini 1998, Fig. 20.16, 18-19  
 Class 173a Cecchini 1998, Fig. 22.4-5, 11  
 Class 173b Cecchini 1998, Fig. 20.7  
 Class 176 Cecchini 1998, Fig. 20.6  
 Class 182a Cecchini 1998, Fig. 20.13  
 Class 182b Cecchini 1998, Fig. 20.8-11  
 Class 182b Cecchini 1998, Fig. 22.8  
 Class 187 Cecchini 1998, Fig. 22.7, 9  
 Class 188 Cecchini 1998, Fig. 22.13  
**Area Gc level 8a**  
 Class 1a Cecchini 1998, Fig. 19.21  
 Class 3 Cecchini 1998, Fig. 19.20  
 Class 37b Cecchini 1998, Fig. 19.22  
 Class 54 Cecchini 1998, Fig. 19.9  
 Class 56 Cecchini 1998, Fig. 19.10  
 Class 134d Cecchini 1998, Fig. 19.6-7  
 Class 141c Cecchini 1998, Fig. 19.5, 11  
 Class 141d Cecchini 1998, Fig. 19.12  
 Class 173a Cecchini 1998, Fig. 19.4  
 Class 173b Cecchini 1998, Fig. 19.1  
 Class 174 Cecchini 1998, Fig. 19.2  
 Class 176 Cecchini 1998, Fig. 19.8  
 Class 182c Cecchini 1998, Fig. 19.3  
**Area Gc level 8b**  
 Class 141c Cecchini 1998, Fig. 18.8  
 Class 141d Cecchini 1998, Fig. 18.9  
 Class 143 Cecchini 1998, Fig. 18.5  
 Class 160a Cecchini 1998, Fig. 18.7  
 Class 173a Cecchini 1998, Fig. 18.4  
 Class 176 Cecchini 1998, Fig. 18.1  
 Class 182b Cecchini 1998, Fig. 18.3, 6  
**Area Ge level 1**  
 Class 5 Cecchini 1998, Fig. 16.17  
 Class 37b Cecchini 1998, Fig. 16.18  
 Class 134d Cecchini 1998, Fig. 16.11  
 Class 141d Cecchini 1998, Fig. 16.12  
 Class 176 Cecchini 1998, Fig. 16.10  
 Class 187 Cecchini 1998, Fig. 16.8  
**Area Ge level 2**  
 Class 37b Cecchini 1998, Figs 16.7; 17.2-3  
 Class 56 Cecchini 1998, Fig. 15.19  
 Class 176 Cecchini 1998, Fig. 15.17  
 Class 179 Cecchini 1998, Fig. 15.15  
 Class 183 Cecchini 1998, Fig. 15.14, 16  
**Area Ge level 3**  
 Class 1a Cecchini 1998, Fig. 15.10  
 Class 5 Cecchini 1998, Fig. 15.8  
 Class 7b Cecchini 1998, Fig. 15.9  
 Class 37b Cecchini 1998, Fig. 15.11, 13  
 Class 42 Cecchini 1998, Fig. 14.22  
 Class 143 Cecchini 1998, Fig. 14.16  
 Class 160a Cecchini 1998, Fig. 14.18  
 Class 172 Cecchini 1998, Fig. 14.19  
**Area Ge level 4**  
 Class 5 Cecchini 1998, Fig. 14.12  
 Class 37a Cecchini 1998, Fig. 14.14-15  
**Area Ge level 5**  
 Class 37b Cecchini 1998, Fig. 17.1  
 Class 160a Cecchini 1998, Fig. 14.2  
 Class 187 Cecchini 1998, Fig. 14.1

**Area Gn level 2**  
 Class 1a Cecchini 1998, Fig. 39.22-23  
 Class 1b Cecchini 1998, Fig. 39.21  
 Class 1c Cecchini 1998, Fig. 39.24  
 Class 134b Cecchini 1998, Fig. 39.15  
 Class 141c Cecchini 1998, Fig. 39.16-17  
 Class 176 Cecchini 1998, Fig. 39.14  
**Area Gn level 3**  
 Class 1b Cecchini 1998, Fig. 39.11-12  
 Class 1c Cecchini 1998, Fig. 39.13  
 Class 56 Cecchini 1998, Fig. 39.1  
 Class 134d Cecchini 1998, Fig. 38.18  
 Class 134e Cecchini 1998, Fig. 39.10  
 Class 175 Cecchini 1998, Fig. 38.20-21  
 Class 184 Cecchini 1998, Fig. 38.17  
 Class 187 Cecchini 1998, Fig. 38.16  
**Area Gn level 4**  
 Class 1b Cecchini 1998, Fig. 38.14  
 Class 1c Cecchini 1998, Fig. 38.15  
 Class 141c Cecchini 1998, Fig. 38.10  
 Class 174 Cecchini 1998, Fig. 38.11  
 Class 175 Cecchini 1998, Fig. 38.12  
 Class 182a Cecchini 1998, Fig. 38.13  
**Area Gn level 5**  
 Class 1a Cecchini 1998, Fig. 38.6  
 Class 125 Cecchini 1998, Fig. 38.9  
 Class 134d Cecchini 1998, Fig. 38.1  
 Class 139 Cecchini 1998, Fig. 38.5  
 Class 141d Cecchini 1998, Fig. 38.7  
 Class 149 Cecchini 1998, Fig. 38.4  
 Class 176 Cecchini 1998, Fig. 38.3  
 Class 182a Cecchini 1998, Fig. 38.2  
**Area J (Afis IX)**  
 Class 1b Oggiano 2002, Fig. 26.5  
 Class 15 Oggiano 2002, Fig. 26.4  
 Class 54 Oggiano 2002, Fig. 26.3  
 Class 141d Oggiano 2002, Fig. 26.6  
 Class 176 Oggiano 2002, Fig. 26.2  
**Area J (Afis VIII)**  
 Class 157 del Vesco et al 2005, Fig. 57.1-2  
**Area L level 2**  
 Class 141c D'Amore 1998a, Fig. 6.1  
**Area L level 3**  
 Class 1c D'Amore 1998a, Fig. 6.14  
 Class 56 D'Amore 1998a, Fig. 6.13  
 Class 141c D'Amore 1998a, Fig. 6.4  
**Area L level 4**  
 Class 134e D'Amore 1998a, Fig. 6.20  
 Class 141c D'Amore 1998a, Fig. 6.3, 6  
 Class 155 D'Amore 1998a, Fig. 6.2  
**Area L level 6a**  
 Class 1c D'Amore 1998a, Fig. 6.25  
 Class 134b D'Amore 1998a, Fig. 6.17  
 Class 139 D'Amore 1998a, Fig. 6.18  
 Class 141c D'Amore 1998a, Fig. 6.5  
 Class 182a D'Amore 1998a, Fig. 6.19  
**Area L level 7**  
 Class 170 D'Amore 1998a, Fig. 6.15  
 Class 173a D'Amore 1998a, Fig. 6.16  
 Class 184 D'Amore 1998a, Fig. 6.26

#### **Area N unstrat.**

Class 5 Cecchini 2005, Fig. 63.12-13  
Class 7a Magazzu 2002, Fig. 32.5  
Class 37a Cecchini 2005, Fig. 63.11  
Class 48b Cecchini 2005, Fig. 63.10  
Class 53b Magazzu 2002, Fig. 32.1

Class 53b Cecchini 2005, Fig. 64.3  
Class 57b Cecchini 2005, Fig. 64.2  
Class 102c Cecchini 2005, Fig. 64.1  
Class 176 Magazzu 2002, Fig. 32.4  
Class 182c Magazzu 2002, Fig. 32.3  
Class 188 Magazzu 2002, Fig. 32.2

## **C.4 Ahmar, Tell**

### **Area C level 2**

Class 1a Jamieson 1999, Fig. 5.1, 3  
Class 1a Jamieson 1999, Fig. 10  
Class 1b Jamieson 2000, Fig. 11.3, 9  
Class 1c Jamieson 1999, Fig. 5.2, 4  
Class 2 Jamieson 2000, Fig. 5.10  
Class 4c Jamieson 2000, Fig. 11.7  
Class 12a Jamieson 2005, Fig. 4.15.2-3  
Class 12b Jamieson 2000, Fig. 8.1-4  
Class 15 Jamieson 1999, Fig. 4.15  
Class 15 Jamieson 2000, Fig. 8.5-9  
Class 24b Jamieson 1999, Fig. 8.6  
Class 28 Jamieson 2000, Fig. 15.1, 3, 5-8  
Class 28 Jamieson 2005, Fig. 4.28.8-10  
Class 33 Jamieson 1999, Fig. 9  
Class 37a Jamieson 2005, Fig. 4.12.5  
Class 37b Jamieson 1999, Fig. 9  
Class 44 Jamieson 1999, Fig. 8.7  
Class 48a Jamieson 1999, Fig. 3.2  
Class 48a Jamieson 2000, Fig. 5.6-9  
Class 48a Jamieson 2000, Fig. 7.7, 9, 11  
Class 48b Jamieson 2000, Fig. 7.8, 10  
Class 48b Jamieson 2005, Fig. 4.11.1-2  
Class 49 Jamieson 2000, Fig. 5.1-5  
Class 50 Jamieson 1999, Fig. 7.6  
Class 53b Jamieson 1999, Fig. 4.1-2, 4-5  
Class 121f Jamieson 2005, Fig. 4.7.4-6  
Class 123 Jamieson 2005, Fig. 4.18.2  
Class 124 Jamieson 1999, Fig. 4.13  
Class 139 Jamieson 1999, Fig. 1.5  
Class 139 Jamieson 1999, Fig. 6.10-12  
Class 139 Jamieson 2000, Fig. 4.1-4  
Class 139 Jamieson 2000, Fig. 12.6-10  
Class 139 Jamieson 2000, Fig. 14.5-8  
Class 141a Jamieson 1999, Fig. 1.8, 10, 13  
Class 141a Jamieson 1999, Fig. 6.3, 5, 7  
Class 141a Jamieson 2000, Fig. 3.1-8  
Class 141a Jamieson 2005, Fig. 4.3.11-12, 14-18  
Class 141b Jamieson 2000, Fig. 4.8-9  
Class 149 Jamieson 1999, Fig. 1.14-15  
Class 149 Jamieson 2000, Fig. 2.23-31  
Class 149 Jamieson 2005, Fig. 4.25.18-20  
Class 152 Jamieson 1999, Fig. 1.2  
Class 152 Jamieson 2000, Fig. 2.1-4  
Class 152 Jamieson 2005, Fig. 4.1.8-11  
Class 157 Jamieson 2000, Fig. 13.18-22  
Class 161 Jamieson 2005, Fig. 4.2.1-2  
Class 162 Jamieson 1999, Fig. 1.3  
Class 162 Jamieson 2000, Fig. 2.5-9  
Class 165a Jamieson 2000, Fig. 14.1-4

Class 53b Jamieson 2000, Fig. 3.22  
Class 54 Jamieson 1999, Fig. 3.1  
Class 71a Jamieson 2000, Fig. 6.18-21  
Class 118 Jamieson 1999, Fig. 7.5  
Class 118 Jamieson 2000, Fig. 15.2, 4  
Class 118 Jamieson 2005, Fig. 4.28.1-3  
Class 119 Jamieson 2005, Fig. 4.26.7-9  
Class 121a Jamieson 1999, Fig. 4.6  
Class 121a Jamieson 2000, Fig. 6.7  
Class 121a Jamieson 2005, Fig. 4.17.11  
Class 121b Jamieson 1999, Fig. 4.7  
Class 121b Jamieson 2000, Fig. 6.2-4  
Class 121b Jamieson 2005, Fig. 4.17.5-8  
Class 121c Jamieson 1999, Fig. 6.9, 13  
Class 121c Jamieson 2000, Fig. 13.9-13  
Class 121d Jamieson 1999, Fig. 2.2-5  
Class 121d Jamieson 2000, Fig. 7.1-3  
Class 121d Jamieson 2005, Fig. 4.7.7-9  
Class 121e Jamieson 1999, Fig. 6.1, 4, 6  
Class 121e Jamieson 2000, Fig. 3.35-39  
Class 121e Jamieson 2005, Fig. 4.13.12-17  
Class 121e Jamieson 2005, Fig. 4.25.1-6  
Class 121f Jamieson 1999, Fig. 2.1  
Class 121f Jamieson 1999, Fig. 4.14  
Class 121f Jamieson 2000, Fig. 6.9-12  
Class 167 Jamieson 1999, Fig. 6.14  
Class 168 Jamieson 1999, Fig. 6.8  
Class 168 Jamieson 2000, Fig. 2.20  
Class 168 Jamieson 2005, Fig. 4.1.6  
Class 169 Jamieson 2005, Fig. 4.1.7  
Class 182a Jamieson 2000, Fig. 13.14-17

### **Area D Iron III**

Class 1a Jamieson 2005, Fig. 42.1-3  
Class 1b Jamieson 2005, Fig. 42.4-6  
Class 4d Jamieson 2005, Fig. 15.6-9  
Class 33 Jamieson 2005, Fig. 31.1  
Class 53b Jamieson 2005, Figs 15.3-4; 50.6  
Class 134a Jamieson 2005, Fig. 2.9-11  
Class 139 Jamieson 2005, Fig. 12.1, 4, 7, 8  
Class 139 Jamieson 2005, Fig. 13.1, 3-4  
Class 141a Jamieson 2005, Fig. 3.1, 3-4  
Class 141a Jamieson 2005, Fig. 4.1-3  
Class 141b Jamieson 2005, Fig. 12.3, 5, 9  
Class 141c Jamieson 2005, Fig. 3.2, 5  
Class 141c Jamieson 2005, Fig. 5.15-16  
Class 152 Jamieson 2005, Fig. 2.1-2  
Class 155 Jamieson 2005, Figs 45.7; 51.2  
Class 176 Jamieson 2005, Fig. 1.1, 7, 12  
Class 182a Jamieson 2005, Fig. 1.2, 6

### **Tombs**

## C.5 Ain Dara

### Lower Iron I

Class 7b Stone & Zimansky 1999, Fig. 71.315  
 Class 37a Stone & Zimansky 1999, Fig. 81.1  
 Class 80 Stone & Zimansky 1999, Fig. 80  
 Class 143 Stone & Zimansky 1999, Fig. 70.126  
 Class 161 Stone & Zimansky 1999, Fig. 27.2  
 Class 175 Stone & Zimansky 1999, Fig. 27.13  
 Class 182c Stone & Zimansky 1999, Fig. 70.186  
 Class 183 Stone & Zimansky 1999, Fig. 70.120  
 Class 184 Stone & Zimansky 1999, Fig. 27.8  
 Class 188 Stone & Zimansky 1999, Fig. 27.1, 3  
 Class 188 Stone & Zimansky 1999, Fig. 27.7  
 Class 188 Stone & Zimansky 1999, Fig. 70.170,  
 175

Class 188 Stone & Zimansky 1999, Fig. 27.6

### Lower Iron II

Class 1a Stone & Zimansky 1999, Fig. 70.226  
 Class 1a Stone & Zimansky 1999, Fig. 71.230,  
 233

Class 1a Stone & Zimansky 1999, Fig. 74.6-8  
 Class 37b Stone & Zimansky 1999, Fig. 10.4  
 Class 37b Stone & Zimansky 1999, Fig. 79.2, 4  
 Class 134b Stone & Zimansky 1999, Fig. 74.4  
 Class 141c Stone & Zimansky 1999, Fig. 70.132  
 Class 157 Stone & Zimansky 1999, Fig. 74.5  
 Class 168 Stone & Zimansky 1999, Fig. 74.2  
 Class 173a Stone & Zimansky 1999, Fig. 10.5  
 Class 176 Stone & Zimansky 1999, Fig. 27.15,  
 17-18

Class 182c Stone & Zimansky 1999, Fig. 70.186  
 Class 187 Stone & Zimansky 1999, Fig. 74.3

### Unstratified

Class 37b Stone & Zimansky 1999, Fig. 75  
 Class 56 Stone & Zimansky 1999, Fig. 27.10  
 Class 122 Stone & Zimansky 1999, Fig. 27.4  
 Class 134b Stone & Zimansky 1999, Fig. 25.11  
 Class 168 Stone & Zimansky 1999, Fig. 74.1  
 Class 182a Stone & Zimansky 1999, Fig. 70.108

## C.6 Akhziv

### East Cem II

Class 85b Dayagi-Mendels 2002, 37 (1)

### East Cem IV

Class 82a Dayagi-Mendels 2002, 43 (1-2)  
 Class 90b Dayagi-Mendels 2002, Fig. 4.3(3)  
 Class 102b Dayagi-Mendels 2002, 43 (4)

### East Cem V

Class 82a Dayagi-Mendels 2002, Fig. 4.4(1)  
 Class 100b Dayagi-Mendels 2002, 44 (2-4)

### East Cem VI

Class 25 Dayagi-Mendels 2002, Fig. 4.5(4)  
 Class 26 Dayagi-Mendels 2002, Fig. 4.5(2)  
 Class 26 Dayagi-Mendels 2002, 45 (3)  
 Class 90b Dayagi-Mendels 2002, Fig. 4.5(7)  
 Class 90b Dayagi-Mendels 2002, 45 (5)  
 Class 100b Dayagi-Mendels 2002, 45 (6)  
 Class 141a Dayagi-Mendels 2002, Fig. 4.5(1)

### East Cem VIII

Class 25 Dayagi-Mendels 2002, Fig. 4.6(3)  
 Class 25 Dayagi-Mendels 2002, 46 (4)  
 Class 144a Dayagi-Mendels 2002, Fig. 4.6(1)  
 Class 151 Dayagi-Mendels 2002, Fig. 4.6(2)

### East Cem IX

Class 82a Dayagi-Mendels 2002, Fig. 4.7(2)  
 Class 82a Dayagi-Mendels 2002, 47 (3)  
 Class 82d Dayagi-Mendels 2002, Fig. 4.7(6)  
 Class 82e Dayagi-Mendels 2002, Fig. 4.7(5)  
 Class 82e Dayagi-Mendels 2002, 47 (7)  
 Class 85a Dayagi-Mendels 2002, Fig. 4.7(9)  
 Class 85b Dayagi-Mendels 2002, Fig. 4.7(10)  
 Class 85b Dayagi-Mendels 2002, 47 (11)  
 Class 87 Dayagi-Mendels 2002, Fig. 4.7(8)  
 Class 90a Dayagi-Mendels 2002, Fig. 4.7(12)

Class 90a Dayagi-Mendels 2002, 47 (13)

Class 90b Dayagi-Mendels 2002, Fig. 4.7(21)

Class 100b Dayagi-Mendels 2002, Fig. 4.7(15,  
 18-19)

Class 100b Dayagi-Mendels 2002, 47 (16-17)

Class 100c Dayagi-Mendels 2002, Fig. 4.7(20)

Class 103a Dayagi-Mendels 2002, Fig. 4.7(23)

Class 124 Dayagi-Mendels 2002, Fig. 4.7(14)

Class 134b Dayagi-Mendels 2002, Fig. 4.7(1)

Class 170 Dayagi-Mendels 2002, Fig. 4.7(22)

### East Cem X

Class 25 Dayagi-Mendels 2002, Fig. 4.8(1-2)

Class 25 Dayagi-Mendels 2002, 54 (3)

### East Cem XI

Class 25 Dayagi-Mendels 2002, 56 (1)

Class 82a Dayagi-Mendels 2002, Fig. 4.9(2, 4)

Class 82c Dayagi-Mendels 2002, Fig. 4.9(3)

Class 86 Dayagi-Mendels 2002, 56 (6)

Class 87 Dayagi-Mendels 2002, 56 (5)

Class 100b Dayagi-Mendels 2002, Fig. 4.7(7)

Class 100b Dayagi-Mendels 2002, 56 (8-12)

### East Cem XII

Class 6 Dayagi-Mendels 2002, Fig. 4.10(12)

Class 12c Dayagi-Mendels 2002, Fig. 4.10(13)

Class 25 Dayagi-Mendels 2002, 57 (2)

Class 30 Dayagi-Mendels 2002, Fig. 4.10(11)

Class 73 Dayagi-Mendels 2002, Fig. 4.10(10)

Class 82a Dayagi-Mendels 2002, Fig. 4.10(4)

Class 82a Dayagi-Mendels 2002, 57 (3)

Class 85a Dayagi-Mendels 2002, Fig. 4.10(5)

Class 100b Dayagi-Mendels 2002, 57 (6-9)

Class 142 Dayagi-Mendels 2002, Fig. 4.10(1)

### East Cem XIII

- Class 25 Dayagi-Mendels 2002, 58 (1)  
**East Cem XIV**  
Class 7b Dayagi-Mendels 2002, Fig. 4.12(12)  
Class 73 Dayagi-Mendels 2002, Fig. 4.12(4)  
Class 82a Dayagi-Mendels 2002, 62 (1-3)  
Class 85a Dayagi-Mendels 2002, Fig. 4.12(9)  
Class 85a Dayagi-Mendels 2002, 62 (5-8)  
Class 100b Dayagi-Mendels 2002, 63 (10-11)  
**East Cem XVI**  
Class 102a Dayagi-Mendels 2002, 64 (1)  
Class 110 Dayagi-Mendels 2002, 64 (2)  
**East Cem XVII**  
Class 25 Dayagi-Mendels 2002, 66 (8)  
Class 42 Dayagi-Mendels 2002, 66 (7)  
Class 80 Culican 1982, Fig. 10f  
Class 80 Dayagi-Mendels 2002, 66 (20)  
Class 82a Culican 1982, Fig. 10a  
Class 82a Dayagi-Mendels 2002, 66 (9-10)  
Class 85b Dayagi-Mendels 2002, 66 (15-16)  
Class 86 Culican 1982, Fig. 10b  
Class 86 Dayagi-Mendels 2002, 66 (14)  
Class 87 Dayagi-Mendels 2002, Fig. 4.14(13)  
Class 87 Dayagi-Mendels 2002, 66 (12)  
Class 90a Culican 1982, Fig. 10d  
Class 100b Dayagi-Mendels 2002, 66 (17-18)  
Class 141c Culican 1982, Fig. 10g  
Class 144b Dayagi-Mendels 2002, Fig. 4.14(5)  
Class 145a Culican 1982, Fig. 10i  
Class 145a Dayagi-Mendels 2002, Fig. 4.14(19)  
Class 156 Culican 1982, Fig. 10c  
Class 160a Dayagi-Mendels 2002, Fig. 4.14(3)  
Class 160b Dayagi-Mendels 2002, Fig.4.14(6)  
Class 164 Dayagi-Mendels 2002, 66 (1-2)  
Class 191 Dayagi-Mendels 2002, Fig. 4.14(21)  
**East Cem XXIV**  
Class 25 Dayagi-Mendels 2002, 72 (1)  
Class 30 Dayagi-Mendels 2002, Fig. 4.18(2)  
Class 85a Culican 1970, Fig. 2B.4  
Class 90a Culican 1970, Fig. 2B.3  
Class 92 Culican 1970, Fig. 2B.2  
Class 100b Culican 1970, Fig. 2B.5  
Class 145a Dayagi-Mendels 2002, Fig. 4.18(3)  
Class 145b Culican 1970, Fig. 2B.1  
**East Cem XXVI**  
Class 85a Dayagi-Mendels 2002, Fig. 4.19(3)  
Class 85b Dayagi-Mendels 2002, 73 (4)  
Class 90a Dayagi-Mendels 2002, Fig. 4.19(5)  
Class 151 Dayagi-Mendels 2002, 73 (1)  
Class 156 Dayagi-Mendels 2002, Fig. 4.19(2)  
**East Cem XXVIII**  
Class 7b Dayagi-Mendels 2002, 75 (5)  
Class 100b Dayagi-Mendels 2002, 75 (1-3)  
**East Cem XXIX**  
Class 4b Culican 1975-1976, Fig. A.y  
Class 4c Dayagi-Mendels 2002, Fig. 4.21(6)  
Class 7a Dayagi-Mendels 2002, Fig. 4.21(30)  
Class 21 Culican 1975-1976, Fig. A.x  
Class 74 Culican 1975-1976, Fig. A.t  
Class 81 Dayagi-Mendels 2002, Fig. 4.21(33-34)  
Class 82a Culican 1975-1976, Fig. A.c-d  
Class 82a Dayagi-Mendels 2002, Fig. 4.21(12)  
Class 82d Culican 1975-1976, Fig. A.b, u  
Class 82d Dayagi-Mendels 2002, Fig. 4.21(13, 28)  
Class 82d Dayagi-Mendels 2002, 78 (14)  
Class 84 Dayagi-Mendels 2002, Fig. 4.21(35)  
Class 84 Dayagi-Mendels 2002, 80 (36)  
Class 85a Culican 1975-1976, Fig. A.g, n  
Class 85b Culican 1975-1976, Fig. A.m  
Class 85b Dayagi-Mendels 2002, Fig. 4.21(18, 20)  
Class 85b Dayagi-Mendels 2002, 78 (19)  
Class 87 Culican 1975-1976, Fig. A.e-f  
Class 87 Dayagi-Mendels 2002, Fig. 4.21(16)  
Class 87 Dayagi-Mendels 2002, 78 (15, 17)  
Class 88 Culican 1975-1976, Fig. A.r  
Class 90a Culican 1975-1976, Fig. A.s  
Class 90a Dayagi-Mendels 2002, Fig. 4.21(21)  
Class 100b Culican 1975-1976, Fig. A.v  
Class 100b Dayagi-Mendels 2002, Fig. 4.21(22, 25-26)  
Class 100b Dayagi-Mendels 2002, 78 (23-24, 27)  
Class 100c Dayagi-Mendels 2002, Fig. 4.21(29)  
Class 100d Culican 1975-1976, Fig. A.z3  
Class 155 Culican 1975-1976, Fig. A.h, q  
Class 155 Dayagi-Mendels 2002, Fig. 4.21(10-11)  
Class 158a Dayagi-Mendels 2002, Fig. 4.21(5)  
Class 164 Dayagi-Mendels 2002, Fig. 4.21(2)  
Class 164 Dayagi-Mendels 2002, 78 (1)  
Class 171 Dayagi-Mendels 2002, Fig. 4.21(3)  
Class 173a Dayagi-Mendels 2002, Fig. 4.21(8)  
Class 178 Dayagi-Mendels 2002, Fig. 4.21(7)  
Class 180 Dayagi-Mendels 2002, Fig. 4.21(9)  
Class 189 Culican 1975-1976, Fig. A.o  
Class 189 Dayagi-Mendels 2002, Fig. 4.21(4)  
**East Cem XXX**  
Class 85b Dayagi-Mendels 2002, 85 (1)  
**East Cem XXXI**  
Class 141a Dayagi-Mendels 2002, 86 (3)  
Class 160a Dayagi-Mendels 2002, 86 (1-2)  
**East Cem XXXVI**  
Class 21 Dayagi-Mendels 2002, Fig. 4.27(78)  
Class 25 Dayagi-Mendels 2002, 91 (11)  
Class 73 Dayagi-Mendels 2002, 91 (20-21)  
Class 81 Dayagi-Mendels 2002, Fig. 4.27(84)  
Class 82a Culican 1982, Fig. 9a-b  
Class 82a Dayagi-Mendels 2002, Fig. 4.27(14, 16)  
Class 82a Dayagi-Mendels 2002, 91 (12-13)  
Class 82b Dayagi-Mendels 2002, Fig. 4.27(18)  
Class 82e Dayagi-Mendels 2002, Fig. 4.27(15, 17, 19)  
Class 83 Culican 1982, Fig. 9g  
Class 84 Culican 1982, Fig. 9j-k

- Class 84 Dayagi-Mendels 2002, Fig. 4.27(81)  
Class 85a Dayagi-Mendels 2002, Fig. 4.27(29, 51)  
Class 85b Culican 1982, Fig. 9l  
Class 85b Dayagi-Mendels 2002, Fig. 4.27(40, 43-44)  
Class 85b Dayagi-Mendels 2002, 91 (38-39)  
Class 85b Dayagi-Mendels 2002, 94 (42, 45-50, 52-53)  
Class 86 Dayagi-Mendels 2002, Fig. 4.27(31, 35)  
Class 86 Dayagi-Mendels 2002, 91 (30, 32-34, 37)  
Class 87 Culican 1982, Fig. 9d-e  
Class 87 Dayagi-Mendels 2002, Fig. 4.27(25, 28)  
Class 87 Dayagi-Mendels 2002, 91 (22-24, 26-27)  
Class 88 Dayagi-Mendels 2002, Fig. 4.27(56)  
Class 90a Dayagi-Mendels 2002, Fig. 4.27(58)  
Class 90b Dayagi-Mendels 2002, Fig. 4.27(59)  
Class 92 Dayagi-Mendels 2002, Fig. 4.27(77)  
Class 97 Dayagi-Mendels 2002, Fig. 4.27(36, 55)  
Class 97 Dayagi-Mendels 2002, 94 (54)  
Class 100b Culican 1982, Fig. 9m  
Class 100b Dayagi-Mendels 2002, Fig. 4.27(66, 75)  
Class 100b Dayagi-Mendels 2002, 94 (63-65, 67-71)  
Class 100b Dayagi-Mendels 2002, 95 (72-74, 76)  
Class 102a Culican 1982, Fig. 9i  
Class 102a Dayagi-Mendels 2002, 94 (60-62)  
Class 112 Culican 1982, Fig. 9f  
Class 112 Dayagi-Mendels 2002, Fig. 4.27(80)  
Class 141c Culican 1982, Fig. 9c  
Class 144a Dayagi-Mendels 2002, Fig. 4.27(8)  
Class 144a Dayagi-Mendels 2002, 91 (7)  
Class 145b Dayagi-Mendels 2002, Fig.4.27(4)  
Class 152 Dayagi-Mendels 2002, Fig. 4.27(9)  
Class 155 Dayagi-Mendels 2002, Fig. 4.27(6)  
Class 158a Dayagi-Mendels 2002, Fig. 4.27(1)  
Class 160a Culican 1982, Fig. 9n  
Class 160a Dayagi-Mendels 2002, Fig. 4.27(5)  
Class 179 Dayagi-Mendels 2002, Fig. 4.27(10)  
**East Cem XXXVII**  
Class 90a Dayagi-Mendels 2002, 102 (1)  
**East Cem XXXIX**  
Class 12c Dayagi-Mendels 2002, Fig. 4.28(8)  
Class 73 Dayagi-Mendels 2002, Fig. 4.28(4)  
Class 82c Dayagi-Mendels 2002, Fig. 4.28(3)  
Class 84 Dayagi-Mendels 2002, 103 (9)  
Class 100b Dayagi-Mendels 2002, 103 (6)  
Class 102b Dayagi-Mendels 2002, 103 (5)  
Class 160b Dayagi-Mendels 2002, Fig. 4.28(2)  
Class 178 Dayagi-Mendels 2002, Fig. 4.28(1)  
**East Cem XLI**  
Class 25 Dayagi-Mendels 2002, Fig. 4.29(1)  
**East Cem XLII**  
Class 25 Dayagi-Mendels 2002, 106 (1-2)  
**East Cem XLIII**  
Class 85a Dayagi-Mendels 2002, 106 (XLIII.1)  
Class 100b Dayagi-Mendels 2002, 106 (XLIII.2)  
**East Cem XLV**  
Class 25 Dayagi-Mendels 2002, 106 (XLV.1)  
**East Cem XLVI**  
Class 25 Dayagi-Mendels 2002, 107 (3)  
Class 42 Dayagi-Mendels 2002, Fig. 4.31(1-2)  
**East Cem LIII**  
Class 25 Dayagi-Mendels 2002, 109 (LIII.1)  
**South Cem I**  
Class 7a Dayagi-Mendels 2002, Figs 3.1(83); 3.2(42)  
Class 24a Dayagi-Mendels 2002, Fig. 3.1(16, 19)  
Class 24a Dayagi-Mendels 2002, 6 (17-18)  
Class 24a Dayagi-Mendels 2002, 10 (9)  
Class 77 Dayagi-Mendels 2002, Fig. 3.2(23)  
Class 80 Dayagi-Mendels 2002, Fig. 3.1(85-86)  
Class 80 Dayagi-Mendels 2002, 10-11 (43-44)  
Class 82a Dayagi-Mendels 2002, Fig. 3.1(33)  
Class 82a Dayagi-Mendels 2002, 6 (20-32, 34-36)  
Class 82a Dayagi-Mendels 2002, 10 (11-18)  
Class 82c Dayagi-Mendels 2002, Fig. 3.2(10)  
Class 82d Dayagi-Mendels 2002, 6 (37)  
Class 84 Dayagi-Mendels 2002, Fig. 3.2(26)  
Class 84 Dayagi-Mendels 2002, 8 (84)  
Class 85a Dayagi-Mendels 2002, Fig. 3.2(22)  
Class 85b Dayagi-Mendels 2002, Fig. 3.1(50)  
Class 85b Dayagi-Mendels 2002, 10 (21)  
Class 85b Dayagi-Mendels 2002, 12 (3)  
Class 87 Dayagi-Mendels 2002, Fig. 3.1(38)  
Class 87 Dayagi-Mendels 2002, 6 (39-46)  
Class 87 Dayagi-Mendels 2002, 10 (19)  
Class 88 Dayagi-Mendels 2002, Fig. 3.1(55)  
Class 90a Dayagi-Mendels 2002, Fig. 3.2(24)  
Class 90a Dayagi-Mendels 2002, 10 (25)  
Class 97 Dayagi-Mendels 2002, Fig. 3.1(49, 61)  
Class 97 Dayagi-Mendels 2002, Fig. 3.2(20)  
Class 100b Dayagi-Mendels 2002, Fig. 3.2(37)  
Class 100b Dayagi-Mendels 2002, 8 (71-82)  
Class 100b Dayagi-Mendels 2002, 10 (34-36, 38-41)  
Class 102a Dayagi-Mendels 2002, Fig. 3.1(65)  
Class 102a Dayagi-Mendels 2002, 10 (27-33)  
Class 102b Dayagi-Mendels 2002, 8 (66-70)  
Class 141a Dayagi-Mendels 2002, Fig. 3.2(5)  
Class 141c Dayagi-Mendels 2002, Fig. 3.1(7)  
Class 141c Dayagi-Mendels 2002, 6 (8)  
Class 144a Dayagi-Mendels 2002, Fig. 3.1(13)  
Class 144a Dayagi-Mendels 2002, 10 (7)  
Class 145a Dayagi-Mendels 2002, Fig. 3.1(9)  
Class 145b Dayagi-Mendels 2002, Fig. 3.1(5)  
Class 145b Dayagi-Mendels 2002, 6 (6)

Class 145b Dayagi-Mendels 2002, 10 (4)  
 Class 151 Dayagi-Mendels 2002, Fig. 3.3(1)  
 Class 154 Dayagi-Mendels 2002, Fig. 3.2(8)  
 Class 160a Dayagi-Mendels 2002, Fig. 3.3(2)  
 Class 162 Dayagi-Mendels 2002, Fig. 3.1(14-15)  
 Class 179 Dayagi-Mendels 2002, 10 (1-3)  
**South Cem III**  
 Class 24a Dayagi-Mendels 2002, Fig. 3.4(5)  
 Class 26 Dayagi-Mendels 2002, Fig. 3.4(4)  
 Class 42 Dayagi-Mendels 2002, Fig. 3.4(3)  
 Class 47 Dayagi-Mendels 2002, Fig. 3.4(6)  
 Class 82a Dayagi-Mendels 2002, 13 (7-9)  
 Class 82e Dayagi-Mendels 2002, Fig. 3.4(10)  
 Class 84 Dayagi-Mendels 2002, Fig. 3.4(22)  
 Class 85b Dayagi-Mendels 2002, Fig. 3.4(15)  
 Class 85b Dayagi-Mendels 2002, 15 (16)  
 Class 87 Dayagi-Mendels 2002, Fig. 3.4(12-13)  
 Class 87 Dayagi-Mendels 2002, 15 (11, 14)  
 Class 100b Dayagi-Mendels 2002, Fig. 3.4(20)  
 Class 100b Dayagi-Mendels 2002, 15 (18-19, 21)  
 Class 145b Dayagi-Mendels 2002, 13 (1)  
**South Cem IV**  
 Class 85b Dayagi-Mendels 2002, Fig. 3.5(2)  
 Class 85b Dayagi-Mendels 2002, 16 (1, 3)  
 Class 100b Dayagi-Mendels 2002, 16 (4-5)  
**South Cem V**  
 Class 82a Dayagi-Mendels 2002, 17 (1)  
**South Cem VI**  
 Class 8c Dayagi-Mendels 2002, Fig. 3.7(8)  
 Class 97 Dayagi-Mendels 2002, Fig. 3.7(6)  
 Class 102a Dayagi-Mendels 2002, 18 (7)  
 Class 110 Dayagi-Mendels 2002, Fig. 3.7(9)  
 Class 145a Dayagi-Mendels 2002, Fig. 3.7(2)  
 Class 145a Dayagi-Mendels 2002, 18(3-4)  
 Class 145b Dayagi-Mendels 2002, Fig. 3.7(1)  
 Class 162 Dayagi-Mendels 2002, Fig. 3.7(5)  
**South Cem X**  
 Class 80 Dayagi-Mendels 2002, Fig. 3.9(29)  
 Class 82a Dayagi-Mendels 2002, Fig. 3.9(7, 9)  
 Class 82a Dayagi-Mendels 2002, 21 (6, 8)  
 Class 84 Dayagi-Mendels 2002, Fig. 3.9(28)  
 Class 85a Dayagi-Mendels 2002, Fig. 3.9(13, 18)  
 Class 85b Dayagi-Mendels 2002, Fig. 3.9(20)  
 Class 87 Dayagi-Mendels 2002, Fig. 3.9(17)  
 Class 87 Dayagi-Mendels 2002, 21 (10-12, 14-15, 19)  
 Class 97 Dayagi-Mendels 2002, Fig. 3.9(16)  
 Class 100b Dayagi-Mendels 2002, 21 (24-27)  
 Class 102a Dayagi-Mendels 2002, 21 (21-23)  
 Class 145b Dayagi-Mendels 2002, Fig. 3.9(2-3)  
 Class 151 Dayagi-Mendels 2002, Fig. 3.9(4)  
 Class 162 Dayagi-Mendels 2002, Fig. 3.9(1)  
**South Cem XI**  
 Class 80 Dayagi-Mendels 2002, Fig. 3.10(28-29)

Class 80 Dayagi-Mendels 2002, 24 (23-27)  
 Class 84 Dayagi-Mendels 2002, 24 (22)  
 Class 97 Dayagi-Mendels 2002, 24 (11-12)  
 Class 100b Dayagi-Mendels 2002, Fig. 3.10(21)  
 Class 102a Dayagi-Mendels 2002, 24 (13-20)  
 Class 134d Dayagi-Mendels 2002, 23 (3)  
 Class 155 Dayagi-Mendels 2002, 23 (8)  
 Class 160a Dayagi-Mendels 2002, 23 (4)  
 Class 162 Dayagi-Mendels 2002, Fig. 3.10(9-10)  
 Class 172 Dayagi-Mendels 2002, Fig. 3.10(5)  
 Class 172 Dayagi-Mendels 2002, 23 (6-7)  
 Class 179 Dayagi-Mendels 2002, 23 (1-2)  
**South Cem XIV**  
 Class 179 Dayagi-Mendels 2002, 27 (1)  
**South Cem XVI**  
 Class 172 Dayagi-Mendels 2002, Fig. 3.12(1)  
**South Cem XVII**  
 Class 90a Dayagi-Mendels 2002, Fig. 3.13(1)  
 Class 145b Dayagi-Mendels 2002, 28 (1)  
 Class 155 Dayagi-Mendels 2002, 28 (2)  
**South Cem XVIII**  
 Class 12c Dayagi-Mendels 2002, 29 (15)  
 Class 82a Dayagi-Mendels 2002, Fig. 3.14(5)  
 Class 82a Dayagi-Mendels 2002, 28 (6)  
 Class 85b Dayagi-Mendels 2002, Fig. 3.14(9)  
 Class 85b Dayagi-Mendels 2002, 29 (8)  
 Class 87 Dayagi-Mendels 2002, 28 (7)  
 Class 155 Dayagi-Mendels 2002, 28 (4)  
 Class 179 Dayagi-Mendels 2002, 28 (1)  
 Class 180 Dayagi-Mendels 2002, Fig. 3.14(2)  
 Class 180 Dayagi-Mendels 2002, 28 (3)  
 Class 100b Dayagi-Mendels 2002, Fig. 3.14(11)  
 Class 100b Dayagi-Mendels 2002, 29 (10, 12-14)  
**South Cem XX**  
 Class 77 Dayagi-Mendels 2002, Fig. 3.16(48)  
 Class 77 Dayagi-Mendels 2002, 32 (47)  
 Class 81 Dayagi-Mendels 2002, Fig. 3.16(49-50)  
 Class 81 Dayagi-Mendels 2002, 32 (51)  
 Class 82a Dayagi-Mendels 2002, Fig. 3.16(10, 14)  
 Class 82d Dayagi-Mendels 2002, Fig. 3.16(13)  
 Class 82e Dayagi-Mendels 2002, Fig. 3.16(12)  
 Class 84 Dayagi-Mendels 2002, Fig. 3.16(52-56)  
 Class 85b Dayagi-Mendels 2002, 31 (16-21)  
 Class 88 Dayagi-Mendels 2002, Fig. 3.16(15)  
 Class 97 Dayagi-Mendels 2002, Fig. 3.16(22)  
 Class 100b Dayagi-Mendels 2002, Fig. 3.16(42)  
 Class 100b Dayagi-Mendels 2002, 32 (43-46)  
 Class 102a Dayagi-Mendels 2002, 31 (33-34)  
 Class 102b Dayagi-Mendels 2002, Fig. 3.16(23, 32, 37)

Class 102b Dayagi-Mendels 2002, 31-32 (24-31, 35-36, 38-40)

Class 102e Dayagi-Mendels 2002, Fig. 3.16(41)

Class 120 Dayagi-Mendels 2002, Fig. 3.16(57)

Class 145b Dayagi-Mendels 2002, Fig. 3.16(6)

Class 155 Dayagi-Mendels 2002, Fig. 3.16(9)

Class 162 Dayagi-Mendels 2002, Fig. 3.16(8)

Class 164 Dayagi-Mendels 2002, Fig. 3.16(2)

Class 178 Dayagi-Mendels 2002, Fig. 3.16(7)

Class 179 Dayagi-Mendels 2002, Fig. 3.16(4)

#### **South Cem XXI**

Class 4b Dayagi-Mendels 2002, 36 (11)

Class 24a Dayagi-Mendels 2002, 36 (2)

Class 82a Dayagi-Mendels 2002, 36 (3-6)

Class 87 Dayagi-Mendels 2002, 36 (7-8)

Class 100b Dayagi-Mendels 2002, 36 (9-10)

Class 141c Dayagi-Mendels 2002, 36 (1)

#### **South Cem 68**

Class 82a E. Mazar 2002, Fig. 52.22-25

Class 85b E. Mazar 2002, Fig. 52.17-18

Class 100b E. Mazar 2002, Fig. 52.26

Class 102b E. Mazar 2002, Fig. 52.27

Class 134d E. Mazar 2002, Fig. 52.3-4

Class 141a E. Mazar 2002, Fig. 52.11

Class 142 E. Mazar 2002, Fig. 52.12-13

Class 145b E. Mazar 2002, Fig. 52.6-7

Class 151 E. Mazar 2002, Fig. 52.5, 8

Class 155 E. Mazar 2002, Fig. 52.14

Class 160a E. Mazar 2002, Fig. 52.16

Class 160b E. Mazar 2002, Fig. 52.10

Class 173a E. Mazar 2002, Fig. 52.9

Class 182a E. Mazar 2002, Fig. 52.15

#### **South Cem 69**

Class 24a E. Mazar 2002, Fig. 60.4-5

Class 56 E. Mazar 2002, Fig. 60.3

Class 160a E. Mazar 2002, Fig. 60.1

#### **South Cem 70**

Class 24b E. Mazar 2002, Fig. 62.3-4

Class 82a E. Mazar 2002, Fig. 62.5-6

Class 85a E. Mazar 2002, Fig. 62.11

Class 85b E. Mazar 2002, Fig. 62.9

Class 87 E. Mazar 2002, Fig. 62.7-8

Class 100b E. Mazar 2002, Fig. 62.12-13

Class 143 E. Mazar 2002, Fig. 62.2

Class 145b E. Mazar 2002, Fig. 62.1

#### **South Cem 72**

Class 7b E. Mazar 2002, Fig. 64.24

Class 25 E. Mazar 2002, Fig. 64.20

Class 73 E. Mazar 2002, Fig. 65.17

Class 81 E. Mazar 2002, Fig. 65.12

Class 82a E. Mazar 2002, Fig. 65.1-3

Class 85a E. Mazar 2002, Fig. 65.4

Class 100b E. Mazar 2002, Fig. 65.13-15

Class 102b E. Mazar 2002, Fig. 65.16

Class 145a E. Mazar 2002, Fig. 64.8-14

Class 151 E. Mazar 2002, Fig. 64.15

Class 155 E. Mazar 2002, Fig. 64.18

Class 160a E. Mazar 2002, Fig. 64.16

Class 172 E. Mazar 2002, Fig. 64.6

Class 173a E. Mazar 2002, Fig. 64.17

#### **South Cem 73**

Class 82a E. Mazar 2002, Fig. 43.5-6

Class 85a E. Mazar 2002, Fig. 43.7

Class 85b E. Mazar 2002, Fig. 43.8

Class 141a E. Mazar 2002, Fig. 43.1

Class 145b E. Mazar 2002, Fig. 43.2

Class 155 E. Mazar 2002, Fig. 43.4

Class 172 E. Mazar 2002, Fig. 43.3

#### **South Cem 78**

Class 144b E. Mazar 2002, Fig. 36.2

Class 179 E. Mazar 2002, Fig. 36.1

#### **South Cem 500**

Class 82a E. Mazar 2002, Fig. 69.3-4

Class 85a E. Mazar 2002, Fig. 69.6

#### **TC2**

Class 24a E. Mazar 2002, Fig. 20b.9

Class 24b E. Mazar 2002, Fig. 20b.6, 18

Class 26 E. Mazar 2002, Fig. 20a.1-2

Class 80 E. Mazar 2002, Fig. 21.7

Class 80 E. Mazar 2002, Fig. 26.1-7

Class 82a E. Mazar 2002, Fig. 20b.17

Class 82d E. Mazar 2002, Fig. 21.8

Class 84 E. Mazar 2002, Fig. 21.1-2, 4-6

Class 102a E. Mazar 2002, Fig. 22.8-9

Class 102a E. Mazar 2002, Fig. 23.1-7

Class 102a E. Mazar 2002, Fig. 25.22, 24-25

Class 102b E. Mazar 2002, Fig. 22.1-7

Class 145a E. Mazar 2002, Fig. 20b.7

Class 145b E. Mazar 2002, Fig. 20b.3-4

Class 151 E. Mazar 2002, Figs 20b.5, 16

Class 164 E. Mazar 2002, Fig. 20b.11-12

Class 169 E. Mazar 2002, Fig. 20b.16

Class 173a E. Mazar 2002, Fig. 20b.8, 15

Class 174 E. Mazar 2002, Fig. 20b.13-14

Class 179 E. Mazar 2002, Fig. 20b.10

#### **TC3**

Class 78 E. Mazar 2002, Fig. 5.1

Class 102a E. Mazar 2002, Fig. 5.2-3

Class 102b E. Mazar 2002, Fig. 5.4

#### **TC4**

Class 24b E. Mazar 2002, Fig. 8.1

Class 73 E. Mazar 2002, Fig. 7.7

Class 73 E. Mazar 2002, Fig. 9.6

Class 76 E. Mazar 2002, Fig. 10.5

Class 77 E. Mazar 2002, Fig. 8.3-4

Class 79 E. Mazar 2002, Fig. 10.12

Class 80 E. Mazar 2002, Fig. 11.1-8

Class 80 E. Mazar 2002, Fig. 12.1-5

Class 83 E. Mazar 2002, Fig. 10.9

Class 82a E. Mazar 2002, Fig. 9.3-5

Class 82b E. Mazar 2002, Fig. 9.1-2

Class 84 E. Mazar 2002, Fig. 10.6-8

Class 85b E. Mazar 2002, Fig. 8.5-7

Class 88 E. Mazar 2002, Fig. 9.8-11

Class 89 E. Mazar 2002, Fig. 9.7

Class 100b E. Mazar 2002, Fig. 10.1-3

Class 102a E. Mazar 2002, Figs 14.7-9; 15.1-8

Class 102a E. Mazar 2002, Fig. 16.1-5

Class 102b E. Mazar 2002, Fig. 12.6-7

Class 102b E. Mazar 2002, Fig. 13.1-7  
 Class 102b E. Mazar 2002, Fig. 14.1-6  
 Class 120 E. Mazar 2002, Fig. 10.10  
 Class 134b E. Mazar 2002, Fig. 7.21  
 Class 145b E. Mazar 2002, Fig. 7.6, 9  
 Class 152 E. Mazar 2002, Fig. 7.15  
 Class 155 E. Mazar 2002, Fig. 7.22-23  
 Class 157 E. Mazar 2002, Fig. 7.24  
 Class 158a E. Mazar 2002, Fig. 7.14  
 Class 162 E. Mazar 2002, Fig. 7.19-20  
 Class 164 E. Mazar 2002, Fig. 7.13, 17-18  
 Class 165a E. Mazar 2002, Fig. 7.16  
 Class 179 E. Mazar 2002, Fig. 7.11-12  
 Class 181 E. Mazar 2002, Fig. 7.10  
 Class 184 E. Mazar 2002, Fig. 7.2-3  
**Tomb N1**  
 Class 49 E. Mazar 2004, Fig. 2.1  
 Class 80 E. Mazar 2004, Fig. 16.8  
 Class 82a E. Mazar 2004, Fig. 10.4  
 Class 82c E. Mazar 2004, Fig. 6.1  
 Class 84 E. Mazar 2004, Fig. 16.2-3  
 Class 84 E. Mazar 2004, Fig. 14.17-21, 23-24, 26-35  
 Class 100b E. Mazar 2004, Fig. 13.2, 4, 9, 11, 17  
 Class 102a E. Mazar 2004, Fig. 14.37-44  
 Class 102b E. Mazar 2004, Fig. 14.1-4, 6-7, 9-10, 12, 14-15  
 Class 134d E. Mazar 2004, Fig. 1.6  
 Class 141a E. Mazar 2004, Fig. 1.2  
 Class 144b E. Mazar 2004, Fig. 1.10  
 Class 155 E. Mazar 2004, Fig. 1.14-15  
 Class 160a E. Mazar 2004, Fig. 1.11  
 Class 162 E. Mazar 2004, Fig. 1.1  
**Tomb N2**  
 Class 12b E. Mazar 2004, Fig. 15.1  
 Class 80 E. Mazar 2004, Fig. 16.6-7  
 Class 84 E. Mazar 2004, Fig. 16.4  
 Class 85a E. Mazar 2004, Fig. 7.13-14  
 Class 100b E. Mazar 2004, Fig. 12.1  
 Class 100b E. Mazar 2004, Fig. 13.3, 7, 14, 24, 27  
 Class 102a E. Mazar 2004, Fig. 14.36, 45  
 Class 102b E. Mazar 2004, Fig. 14.5, 8, 11, 13, 16, 22, 25  
 Class 155 E. Mazar 2004, Fig. 1.16-18  
**Tomb N3**

Class 49 E. Mazar 2004, Fig. 16.1  
 Class 73 E. Mazar 2004, Fig. 10.13  
 Class 80 E. Mazar 2004, Fig. 12.6  
 Class 81 E. Mazar 2004, Fig. 16.5  
 Class 82a E. Mazar 2004, Fig. 6.2-9, 11-13, 15-19  
 Class 82a E. Mazar 2004, Fig. 10.4, 16  
 Class 85a E. Mazar 2004, Fig. 7.1, 3, 12, 15-17  
 Class 85a E. Mazar 2004, Fig. 8.1, 3-6, 8-9  
 Class 85a E. Mazar 2004, Fig. 9.1  
 Class 85b E. Mazar 2004, Fig. 7.2, 4-11  
 Class 87 E. Mazar 2004, Fig. 9.2, 6-8, 10-12  
 Class 90b E. Mazar 2004, Fig. 12.3-4  
 Class 97 E. Mazar 2004, Fig. 11.3  
 Class 100b E. Mazar 2004, Fig. 13.1, 6, 8, 10, 12-13, 15-16  
 Class 134e E. Mazar 2004, Fig. 1.5, 9  
 Class 141a E. Mazar 2004, Fig. 1.20  
 Class 145a E. Mazar 2004, Fig. 1.8  
 Class 155 E. Mazar 2004, Fig. 1.19  
 Class 160a E. Mazar 2004, Fig. 1.12  
**Tomb N4**  
 Class 12c E. Mazar 2004, Fig. 15.2-4  
 Class 25 E. Mazar 2004, Fig. 3.2  
 Class 26 E. Mazar 2004, Fig. 3.1  
 Class 30 E. Mazar 2004, Fig. 5.3  
 Class 42 E. Mazar 2004, Fig. 4.2  
 Class 73 E. Mazar 2004, Fig. 10.7, 10  
 Class 82a E. Mazar 2004, Fig. 6.10  
 Class 82a E. Mazar 2004, Fig. 10.1-2, 9, 14  
 Class 82a E. Mazar 2004, Fig. 12.5  
 Class 82d E. Mazar 2004, Fig. 10.15  
 Class 85a E. Mazar 2004, Fig. 8.2, 7  
 Class 87 E. Mazar 2004, Fig. 9.3-5, 9  
 Class 90b E. Mazar 2004, Fig. 12.2  
 Class 97 E. Mazar 2004, Fig. 11.1-2, 4  
 Class 100b E. Mazar 2004, Fig. 13.20, 22  
 Class 134b E. Mazar 2004, Fig. 1.4  
**Unstratified**  
 Class 42 Culican 1982, Pl. 7a  
 Class 74 Culican 1982, Pl. 4e  
 Class 77 Culican 1982, Pl. 4k  
 Class 82e Culican 1982, Pl. 4i  
 Class 88 Culican 1982, Pl. 4b, g  
 Class 110 see Lehmann 455 (Form 462)

## C.7 Arqa, Tell

### Stratum 9

Class 1b Unpublished  
 Class 1c Unpublished  
 Class 4a Thalmann 1978b, Fig. 44.6  
 Class 6 Thalmann 1978b, Fig. 44.4  
 Class 23 Chaaya 2000, Fig. 3a  
 Class 24b Thalmann 1983, Fig. 2i, l  
 Class 24b Chaaya 2000, Fig. 3b  
 Class 24b Unpublished  
 Class 27 Thalmann 1990, 54 n. 9

Class 28 Thalmann 1983, Fig. 2g  
 Class 57b Thalmann 1990, Fig. 1.5  
 Class 100b Chaaya 2000, Fig. 3.4-5  
 Class 100b Unpublished  
 Class 139 Chaaya 2000, Fig. 3.3  
 Class 142 Chaaya 2000, Fig. 3.1  
 Class 143 Thalmann 1978b, Fig. 46.18-19  
 Class 144b Thalmann 1978b, Fig. 46.13  
 Class 144b Chaaya 2000, Fig. 3.2  
 Class 152 Thalmann 1978b, Fig. 46.1



Class 172 Thalmann 1978b, Fig. 46.11  
Class 174 Thalmann 1978b, Fig. 47.1  
Class 183 Thalmann 1978b, Fig. 47.7  
Class 193 Thalmann 1978b, Fig. 47.12

#### **Stratum 10**

Class 4a Unpublished  
Class 4b Unpublished  
Class 6 Thalmann 1983, Fig. 1.5  
Class 6 Unpublished  
Class 18 Unpublished  
Class 19 Unpublished  
Class 71b Unpublished  
Class 82a Unpublished  
Class 88 Unpublished  
Class 100b Unpublished  
Class 131a Thalmann 1983, Fig. 1.2  
Class 134a Unpublished  
Class 134b Unpublished  
Class 141c Unpublished  
Class 152 Thalmann 1983, Fig. 1.4, 6  
Class 153 Unpublished  
Class 157 Unpublished  
Class 158a Thalmann 1983, Fig. 1.1  
Class 158a Unpublished  
Class 170 Unpublished  
Class 172 Thalmann 1983, Fig. 1.3  
Class 179 Unpublished  
Class 180 Will *et al.* 1973, Pl. XXII.5  
Class 180 Thalmann 1983, Fig. 1.7-8  
Class 184 Unpublished  
Class 193 Thalmann 1978b, Fig. 47.13  
Class 193 Unpublished

#### **Stratum 10AB**

Class 1a Thalmann 1978b, Fig. 44.3  
Class 4a Chaaya 2000, Fig. 2.8  
Class 6 Thalmann 1978a, Fig. 6.5  
Class 6 Chaaya 2000, Fig. 2.6  
Class 18 Thalmann 1983, Fig. 2e-f  
Class 18 Chaaya 2000, Fig. 2.9

## **C.8 'Athlit**

#### **Cremation cem.**

Class 4b Johns 1934, Fig. 5.13  
Class 5 Johns 1934, Fig. 5.12  
Class 6 Johns 1934, Fig. 5.11  
Class 7a Johns 1938, Fig. 4.6  
Class 12b Johns 1938, Fig. 4.5  
Class 12b Johns 1938, Fig. 8.3  
Class 12b Johns 1938, Fig. 9.2  
Class 12c Johns 1938, Fig. 6.7  
Class 19 Johns 1938, Fig. 7.2  
Class 48a Johns 1938, Fig. 19.2  
Class 57c Johns 1938, Fig. 8.1  
Class 57c Johns 1938, Fig. 12.3  
Class 79 Johns 1938, Fig. 4.4  
Class 82b Johns 1938, Fig. 6.1  
Class 82e Johns 1938, Fig. 16.4  
Class 84 Johns 1938, Fig. 4.1-2

Class 18 Unpublished  
Class 19 Chaaya 2000, Fig. 2.7  
Class 131a Thalmann 1978a, Fig. 6.2  
Class 131a Chaaya 2000, Fig. 2.4  
Class 141a Thalmann 1978b, Fig. 46.8  
Class 141c Thalmann 1978b, Fig. 46.9  
Class 144a Thalmann 1978b, Fig. 46.3  
Class 144b Thalmann 1978b, Fig. 46.12  
Class 144b Chaaya 2000, Fig. 2.3  
Class 152 Thalmann 1978a, Fig. 6.4, 6  
Class 152 Thalmann 1978b, Fig. 46.2  
Class 153 Thalmann 1978b, Fig. 46.5  
Class 157 Chaaya 2000, Fig. 2.2  
Class 158a Thalmann 1978a, Fig. 6.1  
Class 161 Chaaya 2000, Fig. 2.5  
Class 172 Thalmann 1978a, Fig. 6.3  
Class 172 Thalmann 1978b, Fig. 47.6-7  
Class 180 Thalmann 1978a, Fig. 6.7-8  
Class 180 Thalmann 1978b, Fig. 46.17  
Class 180 Chaaya 2000, Fig. 2.1

#### **Stratum 10CD**

Class 18 Unpublished  
Class 143 Thalmann 1978b, Fig. 46.20  
Class 144b Thalmann 1978b, Fig. 46.15  
Class 161 Unpublished  
Class 168 Unpublished  
Class 173a Thalmann 1978b, Fig. 47.3

#### **Stratum 10E**

Class 176 Unpublished  
Class 179 Unpublished

#### **Tomb 1**

Class 4a Thalmann 1978b, Fig. 45.16  
Class 6 Thalmann 1978b, Fig. 45.1  
Class 15 Thalmann 1978b, Fig. 45.2  
Class 18 Thalmann 1978b, Fig. 23.1-2  
Class 157 Thalmann 1978b, Fig. 45.8  
Class 158a Thalmann 1978b, Fig. 45.9  
Class 161 Thalmann 1978b, Fig. 45.11  
Class 180 Thalmann 1978b, Fig. 45.3-5, 10

Class 84 Johns 1938, Fig. 6.3-4  
Class 84 Johns 1938, Fig. 11.4  
Class 85a Johns 1938, Fig. 7.1  
Class 85a Johns 1938, Fig. 16.6  
Class 88 Johns 1938, Fig. 11.1-2  
Class 88 Johns 1938, Fig. 13.1  
Class 100b Johns 1938, Fig. 4.3  
Class 100b Johns 1938, Fig. 16.8  
Class 124 Johns 1934, Fig. 5.14  
Class 130 Johns 1938, Fig. 11.3  
Class 131a Johns 1938, Fig. 12.1-2  
Class 143 Johns 1934, Fig. 5.15  
Class 144a Johns 1938, Fig. 8.2  
Class 152 Johns 1938, Fig. 9.1  
Class 152 Johns 1938, Figs 11.5; 12.4  
Class 156 Johns 1938, Fig. 6.2  
Class 156 Johns 1938, Fig. 10.2

Class 156 Johns 1938, Fig. 13.3  
Class 167 Johns 1938, Fig. 10.1  
Class 168 Johns 1938, Fig. 16.3  
Class 169 Johns 1938, Fig. 16.2  
Class 172 Johns 1938, Fig. 13.2  
Class 179 Johns 1938, Fig. 6.5  
Class 179 Johns 1938, Fig. 19.1

#### **Tomb 12**

Class 6 Johns 1932, 65, Fig. 4g  
Class 24a Johns 1932, 65, Fig. 3b  
Class 24b Johns 1932, 65, Fig. 3d  
Class 25 Johns 1932, 65, Fig. 3c

#### **Tomb 16**

Class 24a Johns 1932, Fig. 16l, n  
Class 24b Johns 1932, Fig. 16k  
Class 25 Johns 1932, Fig. 16m  
Class 27 Johns 1932, 60, Fig. 4f  
Class 117 Johns 1932, Fig. 19

#### **Tomb 20**

Class 24a Johns 1932, 70, Fig. 3b  
Class 24b Johns 1932, 70, Fig. 3d  
Class 25 Johns 1932, 70, Fig. 3c  
Class 100b Johns 1932, Fig. 34  
Class 160a Johns 1932, 71, Fig. 4j

#### **Tomb 21**

Class 24a Johns 1932, 73, Fig. 3b  
Class 24b Johns 1932, 73, Fig. 3d  
Class 25 Johns 1932, 73, Fig. 3c  
Class 117 Johns 1932, Pl. 22c  
Class 160a Johns 1932, 74, Fig. 4j  
Class 162 Johns 1932, Fig. 37

#### **Tomb 21b**

Class 6 Johns 1932, 78, Fig. 4g  
Class 24a Johns 1932, 78, Fig. 3b  
Class 24b Johns 1932, 78, Fig. 3d  
Class 25 Johns 1932, 78, Fig. 3c

Class 27 Johns 1932, 78-79, Fig. 4f  
Class 84 Johns 1932, Fig. 47

#### **Tomb 22**

Class 24a Johns 1932, 83, Fig. 3b  
Class 24b Johns 1932, 83, Fig. 3d  
Class 25 Johns 1932, 83, Fig. 3c

#### **Tomb 23**

Class 6 Johns 1932, Fig. 71  
Class 12c Johns 1932, Fig. 72  
Class 24a Johns 1932, 84, 88, Fig. 3b  
Class 24b Johns 1932, 84, 88-89, Fig. 3d  
Class 25 Johns 1932, 84, 88, Fig. 3c  
Class 28 Johns 1932, 84, 88, Fig. 3e  
Class 82e Johns 1932, Pl. 29b  
Class 98 Johns 1932, 91, Fig. 4h

#### **Tomb 24**

Class 4b Johns 1932, Fig. 79  
Class 24a Johns 1932, 95-96, Fig. 3b  
Class 24b Johns 1932, 95-96, Fig. 3d  
Class 25 Johns 1932, 95-96, Fig. 3c  
Class 27 Johns 1932, 95-96, Fig. 4f  
Class 28 Johns 1932, 98, Fig. 3e  
Class 115 Johns 1932, Fig. 82  
Class 148 Johns 1932, Fig. 77  
Class 160a Johns 1932, 98, Fig. 4j

#### **Tomb 34**

Class 24a Johns 1932, 100, Fig. 3b  
Class 24b Johns 1932, 100, Fig. 3d  
Class 25 Johns 1932, 100, Fig. 3c  
Class 162 Johns 1932, Fig. 88

#### **Tomb 35**

Class 24a Johns 1932, 101, Fig. 3b  
Class 24b Johns 1932, 101, Fig. 3d  
Class 25 Johns 1932, 101, Fig. 3c  
Class 27 Johns 1932, 101, Fig. 4f

## **C.9 Beirut**

### **Bey 003 LB/Iron**

Class 12a Badre 2001-2002, Fig. 14.3-5  
Class 22 Badre 2001-2002, Fig. 14.6  
Class 116 Badre 1997b, Fig. 29.6  
Class 116 Badre 2001-2002, Fig. 14.7  
Class 127 Badre 1997b, Fig. 29.7-8  
Class 134a Badre 1997b, Fig. 33.3  
Class 134b Badre 1997b, Fig. 33.5  
Class 172 Badre 1997b, Fig. 33.4

### **Bey 003 glacis I**

Class 7a Badre 1997b, Fig. 33.10-12  
Class 47 Badre 1997b, Fig. 34b.13-17, 19  
Class 54 Badre 1997b, Fig. 34b.18  
Class 56 Badre 1997b, Fig. 34a.1-3  
Class 107b Badre 1997b, Fig. 33.13

### **Bey 003 glacis II**

Class 62 Badre 1997b, Fig. 35.13-14  
Class 62 Badre 1998, Fig. 6.8  
Class 141a Badre 1997b, Fig. 35.6  
Class 141c Badre 1997b, Fig. 35.3  
Class 144b Badre 1997b, Fig. 35.1-2

Class 160a Badre 1997b, Fig. 35.4-5  
Class 162 Badre 1997b, Fig. 35.12  
Class 162 Badre 1998, Fig. 6.7  
Class 163 Badre 1998, Fig. 6.4-5  
Class 172 Badre 1997b, Fig. 35.7-8  
Class 173a Badre 1997b, Fig. 35.11  
Class 173a Badre 1998, Fig. 6.6

### **Bey 003 abandonment**

Class 24b Badre 1997b, Fig. 37.1-2  
Class 42 Badre 1997b, Fig. 37.9  
Class 62 Badre 1998, Fig. 7.6-7  
Class 80 Badre 1997b, Fig. 38.8  
Class 82a Badre 1997b, Fig. 36.13-14  
Class 82a Badre 2000b, Fig. 5.10  
Class 82d Badre 1997b, Fig. 37.15  
Class 84 Badre 1997b, Fig. 38.11  
Class 84 Badre 1998, Fig. 8.11  
Class 87 Badre 1997b, Fig. 36.12  
Class 87 Badre 2000b, Fig. 5.9  
Class 92 Badre 1997b, Fig. 37.14  
Class 100b Badre 1997b, Fig. 37.10-13

Class 100b Badre 2000b, Fig. 6.5-6  
 Class 139 Badre 1997b, Fig. 36.6  
 Class 141c Badre 1997b, Fig. 36.11  
 Class 141c Badre 2000b, Fig. 5.4  
 Class 144a Badre 1997b, Fig. 36.7  
 Class 144b Badre 1997b, Fig. 36.1-4  
 Class 144b Badre 1997b, Fig. 37.4, 6-7  
 Class 144b Badre 2000b, Fig. 5.6-7  
 Class 144b Badre 2000b, Fig. 6.2  
 Class 145a Badre 1997b, Fig. 37.3  
 Class 145a Badre 2000b, Fig. 6.1  
 Class 145b Badre 1997b, Fig. 36.8  
 Class 160a Badre 1997b, Fig. 36.10  
 Class 160a Badre 2000b, Fig. 5.5  
 Class 162 Badre 1997b, Fig. 38.13-16  
 Class 162 Badre 1998, Fig. 7.2-3  
 Class 162 Badre 1998, Fig. 8.13, 15  
 Class 163 Badre 1997b, Fig. 38.10  
 Class 169 Badre 1997b, Fig. 36.8  
 Class 169 Badre 1997b, Fig. 37.5  
 Class 188 Badre 1997b, Fig. 38.1-8a  
 Class 191 Badre 1998, Fig. 8.1-4, 6  
 Class 193 Badre 1997b, Fig. 37.8  
**Bey 003 storage room**  
 Class 23 Badre 1997b, Fig. 44.2  
 Class 24a Badre 1997b, Fig. 44.4-5  
 Class 24b Badre 1997b, Fig. 44.3, 6  
 Class 26 Badre 1997b, Fig. 41.1-7  
 Class 26 Badre 1997b, Fig. 42.1-5  
 Class 27 Badre 1998, Fig. 9.2  
 Class 27 Badre 1997b, Fig. 42.6  
 Class 45 Badre 1997b, Fig. 45.14  
 Class 46 Badre 1998, Fig. 9.1  
 Class 85a Badre 1997b, Fig. 45.12  
 Class 87 Badre 1997b, Fig. 45.13  
 Class 100b Badre 1997b, Fig. 45.7-11  
 Class 141a Badre 1997b, Fig. 45.5

Class 141c Badre 1997b, Fig. 45.6  
 Class 144a Badre 1997b, Fig. 45.4  
 Class 151 Badre 1997b, Fig. 45.1-3  
**Bey 010 Persian**  
 Class 6 Sapin & Sayegh 1998, 106(48-55)  
 Class 9a Doumet-Serhal & Sayegh 1998, 19(6-10); 20  
 Class 9a Doumet-Serhal & Sayegh 1998, 21(1-6, 8-10); 22  
 Class 9a Sapin & Sayegh 1998, 105  
 Class 9a Sapin & Sayegh 1998, 110(82-83)  
 Class 9b Doumet-Serhal & Sayegh 1998, 21(7)  
 Class 15 Sapin & Sayegh 1998, 109(80-81)  
 Class 18 Elayi & Sayegh 2000, Fig. 42  
 Class 18 Elayi & Sayegh 2000, Pls 42-46  
 Class 18 Bettles 2003a, 88  
 Class 25 Jabak *et al.* 1998, 36; 37  
 Class 25 Bettles 2003a  
 Class 42 Sapin & Sayegh 1998, 110(84-85)  
 Class 135 Sapin & Sayegh 1998, 107(62-66)  
 Class 142 Sapin & Sayegh 1998, 103(28)  
 Class 143 Doumet-Serhal & Sayegh 1998, 19(5)  
 Class 149 Sapin & Sayegh 1998, 103 Fig. 22.29-30  
 Class 184 Doumet-Serhal & Sayegh 1998, 24(3-4)  
 Class 193 Doumet-Serhal & Sayegh 1998, 17  
 Class 193 Sapin & Sayegh 1998, 101(14)  
 Class 193 Sapin & Sayegh 1998, 104(37-38)  
 Class 141c Doumet-Serhal & Sayegh 1998, 24(2)  
 Class 182c Doumet-Serhal & Sayegh 1998, 24(1)  
**Unstratified**  
 Class 102a Chehab 1983, Pl. XIX.4

## C.10 Beth Shean

### Stratum IV

Class 2 James 1966, Fig. 34.10  
 Class 2 James 1966, Fig. 69.14  
 Class 3 James 1966, Fig. 69.12  
 Class 4a James 1966, Fig. 69.4  
 Class 4b James 1966, Fig. 38.9  
 Class 7a James 1966, Figs 35.2; 36.6  
 Class 7a James 1966, Fig. 69.16, 20  
 Class 7b James 1966, Fig. 69.7-8, 10  
 Class 12c James 1966, Fig. 32.1  
 Class 14 James 1966, Fig. 72.6  
 Class 16c James 1966, Fig. 39.7  
 Class 22 James 1966, Fig. 70.2  
 Class 24a James 1966, Fig. 70.7  
 Class 24a James 1966, Fig. 72.10  
 Class 24b James 1966, Figs 37.7  
 Class 24b James 1966, Fig. 70.1, 3  
 Class 26 James 1966, Fig. 72.11  
 Class 28 James 1966, Fig. 72.12  
 Class 38b James 1966, Fig. 39.9

Class 44 James 1966, Fig. 72.1  
 Class 49 James 1966, Fig. 68.12-20  
 Class 67 James 1966, Fig. 72.3  
 Class 68 James 1966, Fig. 72.13  
 Class 71b James 1966, Fig. 37.6  
 Class 73 James 1966, Fig. 71.3  
 Class 82b James 1966, Fig. 71.4  
 Class 88 James 1966, Fig. 37.8  
 Class 88 James 1966, Fig. 71.14-15  
 Class 91 James 1966, Fig. 71.7-9  
 Class 97 James 1966, Fig. 71.16  
 Class 100a James 1966, Fig. 71.10  
 Class 100b James 1966, Figs 33.3; 37.2, 4  
 Class 100b James 1966, Fig. 70.9-13  
 Class 100b James 1966, Fig. 72.9  
 Class 100c James 1966, Fig. 34.5  
 Class 100c James 1966, Fig. 70.14, 17-18  
 Class 100e James 1966, Fig. 70.19  
 Class 102a James 1966, Fig. 72.2; 4-5  
 Class 102b James 1966, Fig. 35.3

Class 105 James 1966, Fig. 70.15  
 Class 131a James 1966, Fig. 34.12  
 Class 134a James 1966, Fig. 67.6  
 Class 134b James 1966, Fig. 32.4  
 Class 134c James 1966, Fig. 67.26, 28  
 Class 134d James 1966, Fig. 68.1-2  
 Class 139 James 1966, Fig. 68.3  
 Class 141a James 1966, Fig. 68.9  
 Class 141c James 1966, Fig. 67.19  
 Class 141c James 1966, Fig. 68.11  
 Class 141d James 1966, Fig. 68.5-6  
 Class 144a James 1966, Fig. 67.2  
 Class 152 James 1966, Fig. 35.5  
 Class 152 James 1966, Fig. 37.1  
 Class 152 James 1966, Fig. 67.5  
 Class 153 James 1966, Fig. 67.3  
 Class 155 James 1966, Fig. 67.1, 13  
 Class 157 James 1966, Fig. 38.3  
 Class 157 James 1966, Fig. 67.24  
 Class 168 James 1966, Fig. 39.3  
 Class 158a James 1966, Fig. 39.5  
 Class 158a James 1966, Fig. 67.14  
 Class 160a James 1966, Fig. 67.15, 22-23  
 Class 160b James 1966, Fig. 67.20  
 Class 169 James 1966, Fig. 38.2  
 Class 172 James 1966, Fig. 67.27  
 Class 179 James 1966, Fig. 32.3  
 Class 179 James 1966, Fig. 67.8, 11  
 Class 181 James 1966, Fig. 34.15  
 Class 181 James 1966, Fig. 67.21, 25  
**Area P level 7**  
 Class 7a A. Mazar 2001, Fig. 12.4  
 Class 49 A. Mazar 2001, Fig. 12.4  
 Class 82b A. Mazar 2001, Fig. 12.4  
 Class 86 A. Mazar 2001, Fig. 12.4  
 Class 100a A. Mazar 2001, Fig. 12.4  
 Class 100b A. Mazar 2001, Fig. 12.4  
 Class 100c A. Mazar 2001, Fig. 12.4  
 Class 102a A. Mazar 2001, Fig. 12.4  
 Class 139 A. Mazar 2001, Fig. 12.4  
 Class 141c A. Mazar 2001, Fig. 12.4  
 Class 152 A. Mazar 2001, Fig. 12.4  
 Class 155 A. Mazar 2001, Fig. 12.4  
 Class 160a A. Mazar 2001, Fig. 12.4  
**Stratum V Upper**  
 Class 6 James 1966, Fig. 63.19  
 Class 8c James 1966, Fig. 66.7-8  
 Class 8d James 1966, Fig. 66.6, 9  
 Class 13 James 1966, Fig. 66.12  
 Class 26 James 1966, Fig. 65.1  
 Class 34 James 1966, Fig. 64.12  
 Class 42 James 1966, Fig. 64.11  
 Class 64 James 1966, Fig. 40.1-14  
 Class 64 James 1966, Figs 64.4, 6-7; 65.2  
 Class 82a James 1966, Fig. 66.2  
 Class 82b James 1966, Fig. 66.3  
 Class 91 James 1966, Fig. 66.5  
 Class 100b James 1966, Fig. 65.3-5  
 Class 100c James 1966, Fig. 65.7-8  
 Class 102b James 1966, Fig. 66.14

Class 106 James 1966, Fig. 66.1  
 Class 128 James 1966, Fig. 64.9  
 Class 134b James 1966, Fig. 63.13  
 Class 141a James 1966, Fig. 63.6  
 Class 152 James 1966, Fig. 45.3  
 Class 152 James 1966, Fig. 63.7-8, 10-12  
 Class 157 James 1966, Fig. 63.1  
 Class 162 James 1966, Fig. 63.5  
 Class 164 James 1966, Fig. 63.3  
 Class 168 James 1966, Fig. 63.4  
 Class 172 James 1966, Fig. 63.2  
 Class 179 James 1966, Fig. 45.1  
 Class 179 James 1966, Fig. 63.14  
**Stratum V**  
 Class 4c James 1966, Fig. 20.17  
 Class 6 James 1966, Fig. 2.7  
 Class 6 James 1966, Figs 16.1; 18.11  
 Class 6 James 1966, Figs 20.16; 21.1; 22.7  
 Class 7a James 1966, Fig. 10.4, 7-8  
 Class 8b James 1966, Figs 3.1-2; 18.6  
 Class 8c James 1966, Figs 25.15; 29.8  
 Class 8d James 1966, Fig. 2.2  
 Class 8d James 1966, Fig. 19.20  
 Class 9b James 1966, Fig. 26.14-15  
 Class 12b James 1966, Fig. 31.10  
 Class 12c James 1966, Figs 3.8; 5.28; 29.3  
 Class 13 James 1966, Figs 13.2; 18.16; 22.2  
 Class 14 James 1966, Fig. 1.5  
 Class 14 James 1966, Fig. 3.3  
 Class 14 James 1966, Fig. 25.16  
 Class 15 James 1966, Fig. 26.16  
 Class 21 James 1966, Figs 5.11; 6.16-17, 19  
 Class 22 James 1966, Figs 5.6; 6.18  
 Class 26 James 1966, Fig. 19.17  
 Class 38a James 1966, Fig. 7.7-8  
 Class 38a James 1966, Fig. 19.8  
 Class 38a James 1966, Figs 22.19; 23.3  
 Class 42 James 1966, Fig. 22.26  
 Class 44 James 1966, Fig. 47.11  
 Class 48a James 1966, Fig. 7.9  
 Class 49 James 1966, Fig. 23.8  
 Class 54 James 1966, Fig. 25.1  
 Class 57a James 1966, Fig. 31.35  
 Class 57b James 1966, Fig. 7.6  
 Class 64 James 1966, Figs 4.5; 29.4  
 Class 67 James 1966, Fig. 31.14  
 Class 71b James 1966, Fig. 8.4  
 Class 75 James 1966, Fig. 1.9  
 Class 75 James 1966, Figs 5.7; 18.27; 20.9  
 Class 75 James 1966, Figs 30.9; 23.7; 29.10  
 Class 80 James 1966, Fig. 22.9  
 Class 81 James 1966, Fig. 22.1  
 Class 82e James 1966, Figs 4.4; 19.13  
 Class 84 James 1966, Fig. 1.4  
 Class 84 James 1966, Fig. 8.3  
 Class 84 James 1966, Figs 13.8; 18.21  
 Class 86 James 1966, Fig. 22.8  
 Class 100a James 1966, Figs 1.8; 7.3-4; 19.12,  
 18  
 Class 100b James 1966, Figs 1.6; 3.7; 6.11, 13

Class 100b James 1966, Figs 10.12; 11.2; 14.1  
 Class 100b James 1966, Figs 15.3; 17.2; 22.23  
 Class 100c James 1966, Figs 10.11; 15.1, 4;  
 16.3; 17.1; 25.10, 14  
 Class 100d James 1966, Fig. 10.10  
 Class 100d James 1966, Figs 18.22; 22.14  
 Class 102a James 1966, Fig. 22.17, 21  
 Class 102b James 1966, Fig. 18.17  
 Class 102e James 1966, Fig. 22.18  
 Class 103a James 1966, Fig. 8.5  
 Class 103a James 1966, Fig. 13.1  
 Class 105 James 1966, Fig. 10.13  
 Class 106 James 1966, Fig. 23.10  
 Class 115 James 1966, Fig. 13.4  
 Class 115 James 1966, Fig. 15.2  
 Class 120 James 1966, Fig. 1.3  
 Class 120 James 1966, Fig. 9.2  
 Class 123 James 1966, Fig. 5.10  
 Class 124 James 1966, Fig. 25.9  
 Class 131a James 1966, Fig. 31.28  
 Class 131b James 1966, Fig. 6.24  
 Class 131b James 1966, Figs 19.21; 22.22  
 Class 133 James 1966, Figs 2.3; 11.1; 14.8  
 Class 133 James 1966, Figs 5.15; 6.23  
 Class 134a James 1966, Figs 20.3, 6; 26.10  
 Class 134a James 1966, Fig. 25.12  
 Class 134a James 1966, Fig. 47.3  
 Class 134b James 1966, Fig. 4.1  
 Class 134c James 1966, Fig. 31.1  
 Class 134d James 1966, Fig. 19.5  
 Class 134d James 1966, Fig. 31.19, 26  
 Class 134d James 1966, Fig. 47.18  
 Class 152 James 1966, Figs 3.5; 5.12; 6.1, 5  
 Class 152 James 1966, Figs 18.1; 19.1; 23.5  
 Class 152 James 1966, Fig. 20.5; 22.4-5, 13  
 Class 156 James 1966, Fig. 22.12  
 Class 157 James 1966, Fig. 2.8  
 Class 158a James 1966, Fig. 4.7  
 Class 158a James 1966, Figs 6.4; 20.1  
 Class 158a James 1966, Fig. 21.3; 31.3, 23  
 Class 158b James 1966, Fig. 31.21  
 Class 160a James 1966, Figs 5.13; 6.2  
 Class 160a James 1966, Fig. 26.9  
 Class 160b James 1966, Fig. 22.3  
 Class 162 James 1966, Figs 6.3; 18.2  
 Class 162 James 1966, Fig. 22.11  
 Class 165a James 1966, Fig. 7.2  
 Class 170 James 1966, Fig. 20.2  
 Class 181 James 1966, Figs 3.6; 19.2  
 Class 181 James 1966, Fig. 22.10, 15  
 Class 184 James 1966, Fig. 48.4  
**Stratum V Lower**  
 Class 6 James 1966, Fig. 60.2  
 Class 8b James 1966, Fig. 61.14-15  
 Class 12b James 1966, Fig. 62.1  
 Class 13 James 1966, Fig. 62.2  
 Class 21 James 1966, Fig. 62.3-5  
 Class 22 James 1966, Fig. 62.6-7  
 Class 26 James 1966, Fig. 60.6  
 Class 64 James 1966, Fig. 60.3

Class 75 James 1966, Figs 60.8; 61.10-11  
 Class 81 James 1966, Fig. 61.12  
 Class 82e James 1966, Fig. 61.9  
 Class 84 James 1966, Fig. 61.6  
 Class 100a James 1966, Fig. 61.2  
 Class 100b James 1966, Figs 60.10; 61.1, 3-4,  
 7  
 Class 100d James 1966, Fig. 61.5  
 Class 131b James 1966, Fig. 62.8-9  
 Class 133 James 1966, Fig. 62.10  
 Class 134a James 1966, Fig. 59.8  
 Class 134b James 1966, Fig. 59.5  
 Class 152 James 1966, Fig. 59.7, 10-11, 14  
 Class 157 James 1966, Fig. 59.2  
 Class 158a James 1966, Fig. 59.3, 6  
 Class 160a James 1966, Fig. 59.4  
 Class 173a James 1966, Fig. 59.9  
 Class 181 James 1966, Fig. 59.1  
**Stratum VI Upper**  
 Class 8c Yadin & Geva 1986, Fig. 11.8  
 Class 8d Yadin & Geva 1986, Fig. 11.7  
 Class 16a Yadin & Geva 1986, Fig. 12  
 Class 38a Yadin & Geva 1986, Fig. 11.4  
 Class 40a Yadin & Geva 1986, Fig. 11.2  
 Class 100b Yadin & Geva 1986, Fig. 11.9  
 Class 103a Yadin & Geva 1986, Fig. 11.10  
 Class 173a Yadin & Geva 1986, Fig. 11.1  
**Stratum VI**  
 Class 8b James 1966, Fig. 53.1, 3-4, 6  
 Class 8d James 1966, Fig. 50.12-13  
 Class 10 James 1966, Fig. 53.2  
 Class 12a James 1966, Figs 50.14; 51.12  
 Class 13 James 1966, Figs 50.6-7; 51.9  
 Class 15 James 1966, Fig. 53.14  
 Class 16a James 1966, Fig. 51.15  
 Class 16a James 1966, Fig. 54.8  
 Class 16b James 1966, Fig. 49.3  
 Class 22 James 1966, Figs 49.1; 54.16  
 Class 22 James 1966, Figs 50.9, 20; 51.4, 13  
 Class 39 James 1966, Fig. 57.7  
 Class 38a James 1966, Fig. 53.22  
 Class 38a James 1966, Fig. 54.2  
 Class 38b James 1966, Figs 52.17; 55.9  
 Class 40a James 1966, Fig. 52.13  
 Class 40a James 1966, Fig. 55.4, 6  
 Class 57d James 1966, Fig. 57.12  
 Class 60 James 1966, Fig. 52.5  
 Class 71b James 1966, Fig. 56.2  
 Class 78 James 1966, Fig. 51.11  
 Class 80 James 1966, Fig. 50.5  
 Class 100b James 1966, Fig. 52.11, 23  
 Class 100b James 1966, Fig. 57.6, 8  
 Class 102a James 1966, Figs 50.9; 52.3  
 Class 102a James 1966, Figs 56.14; 57.13  
 Class 102b James 1966, Fig. 53.21  
 Class 102b James 1966, Fig. 56.15  
 Class 104 James 1966, Fig. 49.4  
 Class 104 James 1966, Fig. 54.3  
 Class 107b James 1966, Fig. 56.7  
 Class 109 James 1966, Fig. 57.9

Class 116 James 1966, Fig. 56.8  
 Class 123 James 1966, Fig. 56.5  
 Class 131b James 1966, Figs 50.8; 51.14  
 Class 134a James 1966, Fig. 52.18, 20  
 Class 157 James 1966, Fig. 49.9  
 Class 157 James 1966, Fig. 52.14  
 Class 157 James 1966, Fig. 58.5  
 Class 158a James 1966, Fig. 52.15  
 Class 158a James 1966, Figs 55.1; 57.1  
 Class 158b James 1966, Figs 49.21; 50.2  
 Class 158b James 1966, Figs 51.10; 53.23  
 Class 158b James 1966, Figs 55.2; 56.17  
 Class 160a James 1966, Fig. 57.2  
 Class 162 James 1966, Fig. 57.3  
 Class 162 James 1966, Fig. 58.8  
 Class 188 James 1966, Fig. 52.21

#### **Stratum VI Lower**

Class 4c Yadin & Geva 1986, Fig. 27.9  
 Class 8c Yadin & Geva 1986, Fig. 25.2-3  
 Class 8d Yadin & Geva 1986, Fig. 25.1  
 Class 13 Yadin & Geva 1986, Fig. 34.2  
 Class 16a Yadin & Geva 1986, Figs 28; 29; 30.1; 31.2  
 Class 16a Yadin & Geva 1986, Fig. 32.4  
 Class 16b Yadin & Geva 1986, Figs 30.2; 31.1, 3  
 Class 16b Yadin & Geva 1986, Fig. 33.1  
 Class 16c Yadin & Geva 1986, Fig. 33.2  
 Class 22 Yadin & Geva 1986, Fig. 27.11  
 Class 22 Yadin & Geva 1986, Fig. 32.2-3, 5  
 Class 38a Yadin & Geva 1986, Fig. 23.2-3  
 Class 38b Yadin & Geva 1986, Fig. 23.4  
 Class 39 Yadin & Geva 1986, Fig. 33.4  
 Class 42 Yadin & Geva 1986, Fig. 24  
 Class 54 Yadin & Geva 1986, Fig. 23.1, 6  
 Class 71a Yadin & Geva 1986, Fig. 26.5-7  
 Class 71b Yadin & Geva 1986, Fig. 26.4  
 Class 71b Yadin & Geva 1986, Fig. 27.1, 5  
 Class 76 Yadin & Geva 1986, Fig. 27.2  
 Class 100b Yadin & Geva 1986, Fig. 27.6-8  
 Class 102a Yadin & Geva 1986, Fig. 27.12-13  
 Class 134a Yadin & Geva 1986, Fig. 22.13-16  
 Class 134d Yadin & Geva 1986, Fig. 22.11-12  
 Class 143 Yadin & Geva 1986, Fig. 22.10  
 Class 158a Yadin & Geva 1986, Fig. 22.3-5  
 Class 158b Yadin & Geva 1986, Fig. 35.2  
 Class 160a Yadin & Geva 1986, Fig. 22.2

#### **Area S level 2**

Class 8b A. Mazar 1993b, Fig. 14.4-5  
 Class 16a A. Mazar 1993b, Fig. 14.9  
 Class 22 A. Mazar 1993b, Fig. 14.8  
 Class 38a A. Mazar 1993b, Fig. 14.1  
 Class 134a A. Mazar 1993b, Fig. 14.3

#### **Northern cemetery**

Class 12a Oren 1973, Figs 41.1-2; 42a.13  
 Class 12b Oren 1973, Figs 42b.16; 43.18; 46.8  
 Class 12b Oren 1973, Figs 42a.11-12, 14-15; 43.2-5  
 Class 12c Oren 1973, Fig. 44a.14  
 Class 12c Oren 1973, Fig. 47a.11  
 Class 12d Oren 1973, Fig. 42b.18-20  
 Class 12d Oren 1973, Fig. 47b.31  
 Class 61 Oren 1973, Fig. 48c.28  
 Class 76 Oren 1973, Fig. 44b.20  
 Class 77 Oren 1973, Fig. 43.20  
 Class 78 Oren 1973, Fig. 44b.18-19  
 Class 100b Oren 1973, Fig. 41.12  
 Class 100b Oren 1973, Figs 42b.28; 43.8  
 Class 100d Oren 1973, Figs 41.11; 43.9  
 Class 102a Oren 1973, Fig. 41.4-5, 7  
 Class 102a Oren 1973, Fig. 43.19, 21  
 Class 102a Oren 1973, Fig. 44b.27-28, 30-31  
 Class 102a Oren 1973, Fig. 46.11, 13-14  
 Class 102a Oren 1973, Fig. 48b.12-13  
 Class 102b Oren 1973, Fig. 41.3, 6, 8  
 Class 102b Oren 1973, Fig. 42b.25-27  
 Class 102b Oren 1973, Fig. 43.10; 44b.26, 29  
 Class 102c Oren 1973, Fig. 47b.19  
 Class 102c Oren 1973, Fig. 48b.14-15  
 Class 103a Oren 1973, Fig. 42b.22  
 Class 103b Oren 1973, Fig. 48c.25  
 Class 104 Oren 1973, Fig. 41.9-10  
 Class 104 Oren 1973, Fig. 42b.23-24  
 Class 104 Oren 1973, Fig. 43.6  
 Class 104 Oren 1973, Fig. 44b.22-25  
 Class 104 Oren 1973, Fig. 46.10  
 Class 104 Oren 1973, Fig. 47a.13  
 Class 104 Oren 1973, Fig. 48b.21  
 Class 104 Oren 1973, Fig. 50.10  
 Class 106 Oren 1973, Fig. 42b.21  
 Class 107b Oren 1973, Fig. 47b.24  
 Class 127 Oren 1973, Fig. 43.23  
 Class 127 Oren 1973, Fig. 47a.8  
 Class 134a Oren 1973, Fig. 43.1, 14  
 Class 134a Oren 1973, Fig. 44a.7-12  
 Class 134b Oren 1973, Fig. 42a.8  
 Class 134c Oren 1973, Fig. 43.13  
 Class 134d Oren 1973, Fig. 43.15  
 Class 134d Oren 1973, Fig. 46.17  
 Class 157 Oren 1973, Fig. 47a.1  
 Class 158a Oren 1973, Fig. 42a.1-4  
 Class 158a Oren 1973, Fig. 44a.1, 3-4  
 Class 160a Oren 1973, Figs 42a.7; 44a.5  
 Class 168 Oren 1973, Fig. 46.1  
 Class 188 Oren 1973, Fig. 47a.7

## **C.11 Byblos**

#### **Necropolis K**

Class 4c Salles 1980, Pl. 26.4  
 Class 12c Salles 1980, Pl. 28.1  
 Class 16a Salles 1980, Pl. 26.8

Class 16b Salles 1980, Pl. 27.6-7  
 Class 21 Salles 1980, Pl. 26.7  
 Class 22 Salles 1980, Pl. 25.6  
 Class 26 Salles 1980, Pl. 27.9

Class 42 Salles 1980, Pl. 26.1  
 Class 44 Salles 1980, Pl. 26.5  
 Class 49 Salles 1980, Pl. 13.1  
 Class 54 Salles 1980, Pl. 16.1-2  
 Class 54 Salles 1980, Pls 25.1, 26.2  
 Class 74 Salles 1980, Pl. 20.18  
 Class 84 Salles 1980, Pl. 9.1  
 Class 93a Salles 1980, Pl. 21.3  
 Class 102a Salles 1980, Pl. 14.1-4, 6  
 Class 102b Salles 1980, Pls 10.10; 21.12  
 Class 103a Salles 1980, Pl. 14.7  
 Class 104 Salles 1980, Pl. 12.1-7, 9  
 Class 116 Salles 1980, Pl. 22.5  
 Class 124 Salles 1980, Pl. 9.12  
 Class 127 Salles 1980, Pl. 9.10-11  
 Class 128 Salles 1980, Pl. 15.2-5  
 Class 128 Salles 1980, Pl. 20.8-12, 16-17  
 Class 131a Salles 1980, Pl. 19.4  
 Class 157 Salles 1980, Pl. 19.2, 12  
 Class 158a Salles 1980, Pl. 17.8-9, 11  
 Class 160a Salles 1980, Pl. 17.27  
 Class 162 Salles 1980, Pl. 19.6  
 Class 165a Salles 1980, Pl. 19.7-15  
 Class 173a Salles 1980, Pl. 11.9  
 Class 179 Salles 1980, Pl. 17.4-5  
 Class 184 Salles 1980, Pl. 11.1, 10  
 Class 184 Salles 1980, Pl. 18.3  
 Class 188 Salles 1980, Pl. 11.2-3, 8  
**Unstratified**  
 Class 4a Homsy 2003, Pl. 12  
 Class 5 Homsy 2003, Pl. 8e  
 Class 12c Dunand 1950, Nos 10.195, 11.362,  
 12.257, 14.653, 14.778  
 Class 16b Dunand 1950, No. 13.571  
 Class 18 Dunand 1950, No. 7.910  
 Class 18 Homsy 2003, Pl. 9b  
 Class 19 Homsy 2003, Pl. 10d  
 Class 20 Dunand 1950, No. 9.037  
 Class 20 Dunand 1950, No. 12.541  
 Class 21 Homsy 2003, Pl. 11e  
 Class 23 Homsy 2003, Pl. 9a, c-d  
 Class 24a Dunand 1950, No. 11.120  
 Class 24a Dunand 1950, No. 12.540  
 Class 24b Dunand 1950, No. 9.384  
 Class 24b Homsy 2003, Pl. 10b  
 Class 25 Dunand 1950, No. 18.743  
 Class 25 Homsy 2003, Pl. 10c  
 Class 26 Dunand 1950, No. 9.014  
 Class 26 Dunand 1950, No. 11.119  
 Class 26 Homsy 2003, Pl. 10a  
 Class 27 Dunand 1939b, No. 56.3, 56.5

Class 27 Dunand 1950, No. 12.681-682  
 Class 27 Homsy 2003, Pls 1a-b, 2a-b  
 Class 28 Dunand 1950, No. 11.291  
 Class 28 Dunand 1950, No. 12.679-680  
 Class 28 Dunand 1950, No. 13.186  
 Class 28 Homsy 2003, Pl. 8a-d  
 Class 30 Culican 1970, Fig. 1D.2  
 Class 30 Homsy 2003, Pl. 3b  
 Class 30 Homsy 2003, Pl. 11b-d  
 Class 44 Lehmann 1996, Pl. 62 (361b/1)  
 Class 44 Homsy 2003, Pl. 11f  
 Class 71b Lehmann 1996, Pl. 46 (282/1-2)  
 Class 75 Homsy 2003, Pl. 4c  
 Class 75 Homsy 2003, Pl. 5a-b  
 Class 78 Homsy 2003, Pl. 5e  
 Class 80 Montet 1929, No. 996  
 Class 82a Homsy 2003, Pl. 4a  
 Class 82c Dunand 1950, No. 8.655  
 Class 85b Homsy 2003, Pl. 6b-e  
 Class 88 Dunand 1950, No. 7.673  
 Class 88 Homsy 2003, Pl. 4b  
 Class 88 Homsy 2003, Pl. 6a  
 Class 89 Dunand 1950, Nos 6.872, 9.179  
 Class 89 Dunand 1950, No. 14.278  
 Class 91 Dunand 1950, No. 9.858  
 Class 91 Homsy 2003, Pl. 3c  
 Class 92 Culican 1970, Fig. 1D.1  
 Class 94 Dunand 1950, No. 13.818  
 Class 95 Dunand 1950, No. 9.349  
 Class 95 Homsy 2003, Pl. 5c  
 Class 100a Dunand 1939b, No. 6.090  
 Class 100a Homsy 2003, Pl. 14g  
 Class 100b Montet 1929, No. 1.001  
 Class 100b Dunand 1950, Nos 6.871, 9.864,  
 9.928, 12.311  
 Class 100b Homsy 2003, Pl. 13a-j  
 Class 100b Homsy 2003, Pl. 14a-d  
 Class 110 Dunand 1950, No. 12.061  
 Class 114 Homsy 2003, Pl. 3a  
 Class 117 Dunand 1939b, No. 1.142  
 Class 117 Dunand 1950, No. 7.843  
 Class 117 Dunand 1950, Nos 13.745, 14.776,  
 16.954  
 Class 124 Homsy 2003, Pl. 4d  
 Class 151 Dunand 1950, No. 12.063  
 Class 155 Dunand 1950, No. 9.609  
 Class 179 Dunand 1950, No. 12.004  
 Class 191 Dunand 1950, Nos 8.892, 17.605  
 Class 193 Dunand 1950, No. 11.473  
 Class 193 Dunand 1950, No. 15.683

## C.12 Chatal Höyük

### Building Phase III

Class 37b Haines 1971, Pl. 4d  
 Class 40a Swift 1958, Fig. 38  
 Class 57b Haines 1971, Pl. 4c  
 Class 57b Haines 1971, Pl. 11b  
 Class 73 Swift 1958, Fig. 42

Class 80 Swift 1958, Fig. 45  
 Class 82a see Lehmann 1996, 417 (Form 302)  
 Class 85b see Lehmann 1996, 403 (Form 235)  
 Class 102a Swift 1958, Fig. 46  
 Class 106 Swift 1958, Fig. 43  
 Class 121f see Lehmann 1996, 422 (Form 325)

Class 168 Swift 1958, Fig. 29-30  
 Class 181 Swift 1958, Fig. 32  
 Class 184 Swift 1958, Fig. 36  
**Unstratified**  
 Class 1a see Lehmann 1996, 450 (Form 438b)  
 Class 57b Lehmann 1996, Pl. 53 (321/3)  
 Class 80 see Lehmann 1996, 409 (Form 261)  
 Class 82e Swift 1958, Fig. 41

Class 119 see Lehmann 1996, 401 (Form 222);  
 402 (Form 225)  
 Class 121e see Lehmann 1996, 382 (Form  
 119)  
 Class 130 see Lehmann 1996, 383 (Form  
 125b)  
 Class 164 see Lehmann 1996, 364 (Form 23)

## C.13 Dan, Tel

### Stratum I

Class 4a Pakman 1992, Fig. 4.4  
 Class 4c Pakman 1992, Fig. 4.6  
 Class 7a Pakman 1992, Fig. 4.5  
 Class 9a Pakman 1992, Fig. 4.7  
 Class 18 Pakman 1992, Fig. 6.2  
 Class 24a Pakman 1992, Fig. 6.3  
 Class 26 Pakman 1992, Fig. 6.5  
 Class 27 Pakman 1992, Fig. 6.7  
 Class 29 Pakman 1992, Fig. 5.5, 7  
 Class 37b Pakman 1992, Fig. 7.1; Biran 1994,  
 Fig. 223.2

Class 49 Pakman 1992, Fig. 4.3  
 Class 73 Pakman 1992, Fig. 5.3  
 Class 91 Pakman 1992, Fig. 5.1-2  
 Class 119 Pakman 1992, Fig. 5.9-10  
 Class 121a Pakman 1992, Fig. 5.11  
 Class 121e Pakman 1992, Fig. 5.8  
 Class 126 Pakman 1992, Fig. 5.4  
 Class 184 Pakman 1992, Fig. 5.6  
 Class 193 Pakman 1992, Fig. 4.1-2

### Stratum II

Class 7a Pakman 1992, Fig. 1.8-10  
 Class 7a Biran 1999, Fig. 7.13  
 Class 13 Biran 1994, Fig. 212  
 Class 16b Pakman 1992, Fig. 3.5-6  
 Class 16b Biran 1994, Fig. 168.3-4  
 Class 17 Pakman 1992, Fig. 3.7  
 Class 17 Biran 1994, Fig. 168.5-6  
 Class 17 Biran 1999, Fig. 7.14-15  
 Class 18 Pakman 1992, Fig. 3.4  
 Class 24b Pakman 1992, Fig. 3.1-2  
 Class 24b Biran 1994, Fig. 168.2  
 Class 48b Pakman 1992, Fig. 2.3  
 Class 48b Biran 1994, Fig. 168.1  
 Class 54 Pakman 1992, Fig. 2.2  
 Class 73 Pakman 1992, Fig. 2.9  
 Class 82d Pakman 1992, Fig. 2.7-8  
 Class 88 Pakman 1992, Fig. 2.5  
 Class 97 Pakman 1992, Fig. 2.6  
 Class 100b Pakman 1992, Fig. 2.4  
 Class 100b Biran 1994, Fig. 214  
 Class 134b Pakman 1992, Fig. 1.5  
 Class 141a Pakman 1992, Fig. 1.7  
 Class 141b Pakman 1992, Fig. 1.3  
 Class 141d Pakman 1992, Fig. 1.4, 6  
 Class 141d Biran 1999, Fig. 7.9  
 Class 144b Biran 1999, Fig. 7.7  
 Class 152 Pakman 1992, Fig. 1.2

Class 157 Biran 1999, Fig. 7.5  
 Class 160a Biran 1999, Fig. 7.4  
 Class 169 Pakman 1992, Fig. 1.1  
 Class 173a Biran 1999, Fig. 7.2-3  
 Class 184 Biran 1999, Fig. 7.6

### Stratum III

Class 4b Biran 1999, Fig. 4.6  
 Class 8b Biran 1999, Fig. 4.7  
 Class 8b Biran 1999, Fig. 11.6-9  
 Class 12b Biran 1996b, Fig. 7.10-11  
 Class 12d Biran 1996b, Fig. 7.7, 9  
 Class 14 Biran 1996b, Fig. 7.13  
 Class 17 Biran 1994, Fig. 124.1  
 Class 100b Biran 1999, Fig. 11.13  
 Class 105 Biran 1999, Fig. 11.12  
 Class 126 Biran 1996b, Fig. 7.12, 14-15  
 Class 134d Biran 1999, Fig. 11.2  
 Class 141d Biran 1999, Fig. 4.4-5  
 Class 150 Biran 1999, Fig. 11.1  
 Class 152 Biran 1996b, Fig. 7.4-6  
 Class 152 Biran 1999, Fig. 4.3  
 Class 152 Biran 1999, Fig. 11.3-4  
 Class 169 Biran 1996b, Fig. 7.1-3

### Stratum IV

Class 2 Biran 1989b, Fig. 26.11  
 Class 7a Biran 1982, Fig. 25.2, 7  
 Class 7b Biran 1989b, Fig. 5.8  
 Class 8a Biran 1982, Fig. 25.3  
 Class 8b Biran 1982, Fig. 25.5  
 Class 8b Biran 1989b, Figs 5.1-3; 27.1-4  
 Class 8c Biran 1982, Fig. 25.1  
 Class 8e Biran 1982, Fig. 25.4, 6  
 Class 8e Biran 1989b, Fig. 5.1-3  
 Class 12a Biran 1989b, Fig. 5.13  
 Class 14 Biran 1989b, Fig. 27.11  
 Class 17 Biran 1982, Fig. 26.3-4  
 Class 18 Biran 1982, Fig. 26.1, 4-5  
 Class 35 Biran 1994, Fig. 128.1-2  
 Class 37b Biran 1982, Fig. 27.7  
 Class 61 Biran 1982, Fig. 27.6  
 Class 68 Biran 1982, Fig. 27.5  
 Class 73 Biran 1982, Fig. 27.3  
 Class 76 Biran 1982, Fig. 27.4  
 Class 78 Biran 1989b, Fig. 5.12  
 Class 84 Biran 1982, Fig. 27.1  
 Class 88 Biran 1982, Fig. 27.2  
 Class 103a Biran 1989b, Fig. 4.2  
 Class 103a Biran 1994, Fig. 104.6  
 Class 107b Biran 1989b, Fig. 5.11



Class 131a Biran 1989b, Fig. 5.9-10  
 Class 131a Biran 1989b, Fig. 26.1, 4  
 Class 131b Biran 1989b, Fig. 27.5  
 Class 133 Biran 1989b, Fig. 27.7, 13  
 Class 134b Biran 1982, Fig. 24.6, 14-15  
 Class 134d Biran 1999, Fig. 4.10  
 Class 134e Biran 1999, Fig. 4.11  
 Class 152 Biran 1982, Fig. 24.3-6, 8-13  
 Class 157 Biran 1982, Fig. 24.18  
 Class 160a Biran 1982, Fig. 24.16-17  
 Class 176 Biran 1982, Fig. 24.2

#### **Stratum V**

Class 8b Biran 1989a, Fig. 4.6.8, 13  
 Class 8c Biran 1989a, Fig. 4.7.4-5  
 Class 8d Biran 1989a, Fig. 4.6.1-7  
 Class 8d Biran 1989b, Figs 17.1-2; 24.2-3  
 Class 8d Biran 1989b, Fig. 18.2-3  
 Class 8e Biran 1989a, Fig. 4.6.14-16  
 Class 10 Biran 1994, Fig. 98.6  
 Class 12b Biran 1994, Fig. 98.10  
 Class 16a Biran 1994, Fig. 99.5  
 Class 31 Biran 1989a, Fig. 4.7.8  
 Class 32 Biran 1989a, Fig. 4.7.9  
 Class 34 Biran 1989a, Fig. 4.1  
 Class 38a Biran 1989a, Fig. 4.7.3  
 Class 38a Biran 1994, Fig. 98.9  
 Class 39 Biran 1994, Fig. 98.8  
 Class 40a Biran 1989b, Fig. 22.3  
 Class 48b Biran 1989a, Fig. 4.6.9  
 Class 54 Biran 1989a, Fig. 4.6.10  
 Class 57b Biran 1994, Fig. 99.4  
 Class 68 Biran 1989b, Fig. 22.7  
 Class 71a Biran 1989b, Fig. 24.5  
 Class 73 Biran 1989a, Fig. 4.7.7  
 Class 73 Biran 1989b, Fig. 24.4, 6  
 Class 102b Biran 1994, Fig. 99.1-2  
 Class 103a Biran 1994, Fig. 99.3  
 Class 131a Biran 1989a, Fig. 4.7.6  
 Class 131a Biran 1989b, Fig. 22.6  
 Class 131b Biran 1994, Fig. 94.5  
 Class 134a Biran 1989a, Fig. 4.6.12  
 Class 134a Biran 1989a, Fig. 4.7.1  
 Class 134d Biran 1989b, Fig. 22.4

Class 160a Biran 1989b, Fig. 18.1  
 Class 172 Biran 1989b, Fig. 22.1  
 Class 188 Biran 1989b, Figs 22.2; 24.1

#### **Stratum V/VI**

Class 4c Biran 1994, Fig. 103.6  
 Class 8d Biran 1994, Fig. 103.3-4  
 Class 73 Biran 1994, Fig. 103.5  
 Class 102a Biran 1994, Fig. 103.7  
 Class 103b Biran 1994, Fig. 103.2  
 Class 134a Biran 1994, Fig. 103.1

#### **Stratum VI**

Class 4b Biran 1989a, Fig. 4.16.4  
 Class 7b Biran 1989a, Fig. 4.16.1  
 Class 8b Biran 1989a, Fig. 4.16.2-6  
 Class 8d Biran 1989a, Fig. 4.18.11, 13; 4.19.4-6

Class 8e Biran 1989a, Fig. 4.19.7-11  
 Class 8e Biran 1989b, Fig. 12.1-5  
 Class 16a Biran 1994, Fig. 87.6  
 Class 22 Biran 1989a, Fig. 4.10  
 Class 22 Biran 1994, Fig. 87.7  
 Class 31 Biran 1989a, Fig. 4.12.6  
 Class 31 Biran 1989a, Fig. 4.16.9  
 Class 34 Biran 1989a, Fig. 4.23.1-4  
 Class 38a Biran 1989a, Fig. 4.12.2  
 Class 39 Biran 1989a, Fig. 4.18.4, 10  
 Class 54 Biran 1989a, Fig. 4.18.3  
 Class 54 Biran 1994, Fig. 87.3  
 Class 57b Biran 1989a, Fig. 4.24.6  
 Class 102a Biran 1989a, Fig. 4.18.9  
 Class 102a Biran 1994, Fig. 87.5  
 Class 102a Biran 1994, Fig. 93.4  
 Class 103a Biran 1994, Fig. 87.4  
 Class 131a Biran 1989b, Fig. 10.1  
 Class 131a Biran 1994, Fig. 87.1-2  
 Class 134a Biran 1989a, Fig. 4.19.2  
 Class 160a Biran 1989a, Fig. 4.18.1  
 Class 188 Biran 1989a, Fig. 4.12.1

#### **Unstratified**

Class 7b Biran 1994, Fig. 165.2  
 Class 17 Biran 1994, Fig. 165.1  
 Class 35 Biran 1994, Fig. 138

## **C.14 Deve Höyük**

### **Phase I**

Class 50 Moorey 1980, Fig. 2.3-4  
 Class 53a Moorey 1980, Fig. 3.19  
 Class 57c Moorey 1980, Fig. 2.5-6  
 Class 72 Moorey 1980, Figs 3.27; 4.28  
 Class 84 Moorey 1980, Fig. 3.13-14  
 Class 94 Moorey 1980, Fig. 3.20-21  
 Class 96 Moorey 1980, Fig. 3.15  
 Class 101 Moorey 1980, Fig. 3.23-25  
 Class 111 Moorey 1980, Fig. 2.2a-c  
 Class 119 Moorey 1980, Fig. 3.16-17  
 Class 138 Moorey 1980, Fig. 3.9  
 Class 148 Moorey 1980, Fig. 2.7

Class 160a Moorey 1980, Fig. 3.12  
 Class 169 Moorey 1980, Fig. 3.8  
 Class 187 Moorey 1980, Fig. 3.11

### **Phase II**

Class 73 Moorey 1980, Fig. 4.46  
 Class 93a Moorey 1980, Fig. 4.29, 33-36  
 Class 93b Moorey 1980, Fig. 4.42-45  
 Class 95 Moorey 1980, Fig. 4.30, 39-41  
 Class 99 Moorey 1980, Fig. 4.56  
 Class 105 Moorey 1980, Fig. 4.37  
 Class 117 Moorey 1980, Fig. 4.32, 51  
 Class 129 Moorey 1980, Fig. 4.50

## C.15 Ghassil, Tell el-

### Area I level 1

Class 4b Baramki 1964, Fig. 18.3  
Class 4b Baramki 1964, Fig. 20.1  
Class 4c Baramki 1964, Fig. 14.1  
Class 4c Baramki 1964, Fig. 19.1  
Class 7b Baramki 1964, Fig. 21.1  
Class 12b Joukowsky 1972, Pl. 1.23  
Class 12c Baramki 1964, Fig. 14.4  
Class 14 Baramki 1964, Fig. 9.1  
Class 18 Baramki 1964, Fig. 16.1  
Class 22 Baramki 1964, Fig. 15.1  
Class 31 Joukowsky 1972, Pl. 1.16  
Class 37b Baramki 1964, Fig. 23.1  
Class 48b Joukowsky 1972, Pl. 1.17  
Class 68 Baramki 1964, Fig. 24.1  
Class 81 Baramki 1964, Fig. 8.7  
Class 81 Baramki 1964, Fig. 17.1  
Class 82b Baramki 1964, Fig. 17.4  
Class 82e Baramki 1964, Fig. 9.4  
Class 82e Baramki 1964, Fig. 11.3  
Class 88 Baramki 1964, Fig. 10.1  
Class 88 Baramki 1964, Fig. 12.3  
Class 90a Baramki 1961, Fig. 1.2  
Class 100b Baramki 1964, Fig. 11.2  
Class 100b Baramki 1964, Fig. 17.5  
Class 100b Baramki 1964, Fig. 18.1  
Class 100c Joukowsky 1972, Pl. 1.9  
Class 125 Baramki 1964, Fig. 11.1  
Class 131a Baramki 1964, Fig. 10.4

### Area I level 2

Class 4b Baramki 1964, Fig. 5.2  
Class 4b Baramki 1964, Fig. 33.1  
Class 4b Baramki 1964, Fig. 35.2  
Class 4b Baramki 1964, Fig. 36.1  
Class 4b Baramki 1964, Fig. 41.2  
Class 4b Joukowsky 1972, Pl. 2.16, 18  
Class 5 Baramki 1964, Fig. 33.2  
Class 5 Joukowsky 1972, Pl. 2.17  
Class 6 Baramki 1964, Fig. 25.4  
Class 7a Baramki 1964, Fig. 36.3, 5  
Class 12c Joukowsky 1972, Pl. 4.12-13  
Class 14 Baramki 1961, Fig. 7.1  
Class 14 Baramki 1964, Fig. 34.4-5  
Class 14 Baramki 1964, Fig. 40.1  
Class 14 Joukowsky 1972, Pl. 2.10-13  
Class 18 Joukowsky 1972, Pl. 3.14  
Class 19 Baramki 1964, Fig. 35.1  
Class 19 Joukowsky 1972, Pl. 4.1  
Class 54 Baramki 1964, Fig. 41.1  
Class 57c Baramki 1964, Fig. 27.6  
Class 59 Baramki 1964, Fig. 31.3  
Class 59 Baramki 1964, Fig. 38.4  
Class 59 Baramki 1964, Fig. 40.3  
Class 68 Baramki 1964, Fig. 4.1  
Class 71b Baramki 1964, Fig. 28.3  
Class 73 Joukowsky 1972, Pl. 2.27, 31  
Class 74 Baramki 1964, Fig. 34.2

Class 78 Baramki 1964, Fig. 5.1  
Class 80 Joukowsky 1972, Pl. 2.35  
Class 82a Joukowsky 1972, Pl. 2.33  
Class 82e Baramki 1964, Fig. 1.1  
Class 84 Baramki 1964, Fig. 37.1  
Class 85b Baramki 1964, Fig. 2.4  
Class 88 Baramki 1964, Fig. 37.2  
Class 91 Joukowsky 1972, Pl. 2.30  
Class 100b Baramki 1964, Fig. 2.2  
Class 100b Joukowsky 1972, Pl. 2.23-26  
Class 100c Baramki 1964, Fig. 27.5  
Class 100e Baramki 1964, Fig. 25.2  
Class 100e Baramki 1964, Fig. 33.4  
Class 103a Baramki 1964, Fig. 3.1-2  
Class 103a Joukowsky 1972, Pl. 2.6-7  
Class 105 Baramki 1964, Fig. 28.4  
Class 157 Baramki 1961, Fig. 3.2  
Class 157 Baramki 1964, Fig. 28.1  
Class 159 Joukowsky 1972, Pl. 2.8  
Class 160a Baramki 1964, Fig. 29.3  
Class 162 Baramki 1964, Fig. 29.2  
Class 165a Baramki 1964, Fig. 32.3  
Class 165a Joukowsky 1972, Pl. 2.9  
Class 184 Joukowsky 1972, Pl. 2.4

### Area I level 3

Class 4c Joukowsky 1972, Pl. 5.14  
Class 6 Joukowsky 1972, Pl. 5.9  
Class 8a Joukowsky 1972, Pl. 5.10  
Class 8b Joukowsky 1972, Pl. 5.11, 13  
Class 8d Baramki 1961, Fig. 3.3; Pl. 7.3  
Class 12c Baramki 1964, Fig. 4.3  
Class 18 Baramki 1961, Fig. 9.2  
Class 18 Baramki 1964, Fig. 2.3  
Class 21 Baramki 1961, Fig. 3.1  
Class 21 Joukowsky 1972, Pl. 6.2  
Class 24b Joukowsky 1972, Pl. 6.9-10  
Class 40a Baramki 1961, Fig. 10.1  
Class 40b Joukowsky 1972, Pl. 5.15  
Class 42 Baramki 1964, Fig. 7.3  
Class 61 Joukowsky 1972, Pl. 6.3, 7  
Class 85a Baramki 1964, Fig. 1.2  
Class 88 Baramki 1961, Figs 9.1; 10.3  
Class 88 Baramki 1964, Fig. 1.4  
Class 100c Baramki 1964, Fig. 2.1  
Class 103a Joukowsky 1972, Pl. 5.3-4  
Class 105 Joukowsky 1972, Pl. 5.22  
Class 131a Joukowsky 1972, Pl. 5.6  
Class 157 Baramki 1961, Fig. 3.2  
Class 158a Joukowsky 1972, Pl. 5.1-2

### Area I level 4

Class 4b Baramki 1961, Fig. 6.2; Pl. 8.4  
Class 4b Joukowsky 1972, Pl. 8.31-32  
Class 5 Joukowsky 1972, Pl. 8.38-39, 41  
Class 6 Baramki 1966, Fig. 4.1  
Class 7a Joukowsky 1972, Pl. 8.40, 42  
Class 8c Joukowsky 1972, Pl. 8.33  
Class 8d Joukowsky 1972, Pl. 8.25

Class 14 Baramki 1961, Fig. 6.4  
 Class 14 Joukowsky 1972, Pl. 8.27  
 Class 18 Baramki 1964, Fig. 3.3  
 Class 22 Joukowsky 1972, Pl. 10.1  
 Class 40a Baramki 1961, Fig. 5.3  
 Class 40a Baramki 1961, Fig. 6.3  
 Class 54 Joukowsky 1972, Pl. 8.26  
 Class 57b Baramki 1961, Fig. 4.1  
 Class 57b Joukowsky 1972, Pl. 10.5  
 Class 81 Baramki 1964, Fig. 7.2  
 Class 84 Joukowsky 1972, Pl. 9.15  
 Class 88 Baramki 1961, Fig. 4.3  
 Class 100b Baramki 1961, Fig. 4.2  
 Class 100b Baramki 1966, Fig. 3.5  
 Class 100b Joukowsky 1972, Pl. 9.13  
 Class 102a Baramki 1964, Fig. 2.5  
 Class 102a Joukowsky 1972, Pl. 9.18  
 Class 102b Baramki 1964, Fig. 5.3  
 Class 102b Joukowsky 1972, Pl. 9.19  
 Class 103a Baramki 1961, Fig. 5.4  
 Class 103a Baramki 1966, Fig. 3.4  
 Class 103a Joukowsky 1972, Pl. 8.29  
 Class 105 Baramki 1961, Fig. 4.4  
 Class 105 Joukowsky 1972, Pl. 9.16-17  
 Class 106 Baramki 1961, Fig. 5.1  
 Class 106 Joukowsky 1972, Pl. 9.24  
 Class 107b Joukowsky 1972, Pl. 9.23  
 Class 109 Baramki 1964, Fig. 7.1  
 Class 151 Baramki 1964, Fig. 6.3  
 Class 159 Joukowsky 1972, Pl. 8.24  
 Class 161 Joukowsky 1972, Pl. 8.22  
 Class 174 Joukowsky 1972, Pl. 8.19  
**Area I level 5**  
 Class 4d Joukowsky 1972, Pl. 12.30  
 Class 12a Joukowsky 1972, Pl. 13.24  
 Class 12c Joukowsky 1972, Pl. 13.23  
 Class 31 Joukowsky 1972, Pl. 13.1-2  
 Class 31 Joukowsky 1972, Pl. 14  
 Class 35 Joukowsky 1972, Pl. 13.13  
 Class 57b Joukowsky 1972, Pl. 12.44  
 Class 103a Joukowsky 1972, Pl. 12.22  
 Class 105 Joukowsky 1972, Pl. 12.40  
 Class 109 Joukowsky 1972, Pl. 12.38  
 Class 159 Joukowsky 1972, Pl. 12.27  
 Class 168 Joukowsky 1972, Pl. 12.23  
**Area III level 1**  
 Class 12c Joukowsky 1972, Pl. 16.21  
 Class 14 Joukowsky 1972, Pl. 15.20  
 Class 20 Joukowsky 1972, Pl. 16.12  
 Class 31 Joukowsky 1972, Pl. 16.8  
 Class 37b Joukowsky 1972, Pl. 16.7  
 Class 106 Joukowsky 1972, Pl. 15.30  
**Area III level 2**  
 Class 4b Joukowsky 1972, Pl. 17.70-72  
 Class 4c Joukowsky 1972, Pl. 17.79  
 Class 7b Joukowsky 1972, Pl. 17.80-81  
 Class 8c Joukowsky 1972, Pl. 17.82  
 Class 8e Joukowsky 1972, Pl. 17.83  
 Class 14 Joukowsky 1972, Pl. 18.1  
 Class 19 Joukowsky 1972, Pl. 20.1

Class 44 Joukowsky 1972, Pl. 18.43  
 Class 59 Joukowsky 1972, Pl. 19.10, 13, 15  
 Class 68 Joukowsky 1972, Pl. 18.34  
 Class 71b Joukowsky 1972, Pl. 18.47  
 Class 73 Joukowsky 1972, Pl. 18.35  
 Class 74 Joukowsky 1972, Pl. 18.44  
 Class 82c Joukowsky 1972, Pl. 18.36  
 Class 93a Joukowsky 1972, Pl. 18.33  
 Class 100b Joukowsky 1972, Pl. 18.40  
 Class 100c Joukowsky 1972, Pl. 18.30  
 Class 100e Joukowsky 1972, Pl. 18.31  
 Class 105 Joukowsky 1972, Pl. 18.27-29  
 Class 152 Joukowsky 1972, Pl. 17.57  
 Class 157 Joukowsky 1972, Pl. 17.52  
 Class 160a Joukowsky 1972, Pl. 17.59  
 Class 160b Joukowsky 1972, Pl. 17.60  
**Area III level 3**  
 Class 3 Joukowsky 1972, Pl. 24.12  
 Class 4d Joukowsky 1972, Pl. 24.15  
 Class 7b Joukowsky 1972, Pl. 24.16, 20  
 Class 8d Joukowsky 1972, Pl. 24.19  
 Class 12b Joukowsky 1972, Pl. 25.3, 5  
 Class 14 Joukowsky 1972, Pl. 25.8  
 Class 57b Joukowsky 1972, Pl. 25.9  
 Class 76 Joukowsky 1972, Pl. 24.32, 34  
 Class 159 Joukowsky 1972, Pl. 24.13  
**Area III level 4**  
 Class 4a Joukowsky 1972, Pl. 26.12  
 Class 4b Baramki 1966, Fig. 4.2  
 Class 4b Joukowsky 1972, Pl. 26.6, 9  
 Class 4c Baramki 1966, Fig. 3.2  
 Class 4c Joukowsky 1972, Pl. 26.5, 7-8, 10-11  
 Class 4d Joukowsky 1972, Pl. 26.13  
 Class 14 Joukowsky 1972, Pl. 26.2  
 Class 22 Joukowsky 1972, Pl. 27.3  
 Class 31 Joukowsky 1972, Pl. 27.23-25  
 Class 57b Joukowsky 1972, Pl. 26.27, 30  
 Class 88 Baramki 1966, Fig. 5  
 Class 100b Joukowsky 1972, Pl. 26.22  
 Class 103a Joukowsky 1972, Pl. 26.4  
 Class 160a Joukowsky 1972, Pl. 26.15  
 Class 184 Joukowsky 1972, Pl. 26.3  
**Area III level 5**  
 Class 4b Baramki 1966, Fig. 7.4  
 Class 4b Joukowsky 1972, Pl. 28.6  
 Class 14 Baramki 1966, 37  
 Class 57a Joukowsky 1972, Pl. 28.11  
 Class 100b Baramki 1966, Fig. 7.2  
**Area III level 6**  
 Class 4d Joukowsky 1972, Pl. 29.7-8, 10  
 Class 8a Baramki 1966, Fig. 8.4  
 Class 57b Joukowsky 1972, Pl. 29.11  
 Class 100b Baramki 1966, Fig. 8.2  
**Area III level 7**  
 Class 102a Joukowsky 1972, Pl. 30.3  
 Class 102b Joukowsky 1972, Pl. 30.2  
**Iron II**  
 Class 4c Baramki 1966, Fig. 6  
 Class 159 Baramki 1961, Fig. 8.2

## C.16 Hama

### Cemetery I

- Class 7a Riis 1948, Fig. 60
- Class 36 Riis 1948, Fig. 33
- Class 40a Riis 1948, Figs 56, 58, 61
- Class 40c Riis 1948, Fig. 57
- Class 42 Riis 1948, Fig. 59
- Class 48a Riis 1948, Fig. 52
- Class 53b Riis 1948, Figs 78-79
- Class 57a Riis 1948, Figs 23-29, 31
- Class 57d Riis 1948, Figs 51, 55
- Class 57e Riis 1948, Figs 41-43
- Class 59 Riis 1948, Fig. 48
- Class 68 Riis 1948, Fig. 66
- Class 71a Riis 1948, Figs 63, 65
- Class 71b Riis 1948, Fig. 64
- Class 73 Riis 1948, Fig. 73
- Class 101 Riis 1948, Figs 49, 53
- Class 102c Riis 1948, Fig. 81
- Class 105 Riis 1948, Fig. 40
- Class 105 Riis 1948, Fig. 71-72
- Class 118 Riis 1948, Figs 34-35
- Class 128 Riis 1948, Fig. 39
- Class 152 Riis 1948, Fig. 91
- Class 157 Riis 1948, Fig. 98
- Class 160a Riis 1948, Fig. 97
- Class 162 Riis 1948, Fig. 107
- Class 164 Riis 1948, Fig. 105
- Class 168 Riis 1948, Fig. 101
- Class 185 Riis 1948, Fig. 92

### Cemetery II

- Class 40a Riis 1948, Figs 56, 58, 61
- Class 42 Riis 1948, Fig. 59
- Class 57a Riis 1948, Figs 23-29
- Class 57c Riis 1948, Fig. 45
- Class 57e Riis 1948, Figs 42-43
- Class 68 Riis 1948, Figs 66-67
- Class 118 Riis 1948, Fig. 34
- Class 155 Riis 1948, Fig. 95
- Class 158a Riis 1948, Fig. 103
- Class 159 Riis 1948, Fig. 118
- Class 160a Riis 1948, Figs 93, 97
- Class 160b Riis 1948, Fig. 106
- Class 162 Riis 1948, Fig. 107
- Class 164 Riis 1948, Fig. 105
- Class 165b Riis 1948, Fig. 113
- Class 188 Riis 1948, Figs 96, 101
- Class 188 Riis 1948, Fig. 89

### Cemetery III

- Class 42 Riis 1948, Fig. 59
- Class 57a Riis 1948, Figs 26-29
- Class 57c Riis 1948, Figs 44-45
- Class 68 Riis 1948, Fig. 66
- Class 78 Riis 1948, Fig. 82
- Class 153 Riis 1948, Fig. 114
- Class 155 Riis 1948, Fig. 95
- Class 164 Riis 1948, Fig. 105
- Class 165b Riis 1948, Fig. 113

Class 166 Riis 1948, Fig. 115

Class 167 Riis 1948, Fig. 117

Class 168 Riis 1948, Fig. 101

Class 188 Riis 1948, Fig. 90

### Cemetery IV

Class 40a Riis 1948, Fig. 58

Class 53b Riis 1948, Fig. 36

Class 57a Riis 1948, Figs 28-30, 32

Class 57c Riis 1948, Fig. 45

Class 57e Riis 1948, Fig. 43

Class 59 Riis 1948, Fig. 50

Class 60 Riis 1948, Figs 47, 54

Class 61 Riis 1948, Fig. 46

Class 68 Riis 1948, Fig. 37

Class 68 Riis 1948, Figs 67-70

Class 78 Riis 1948, Fig. 82

Class 81 Riis 1948, Fig. 133b

Class 82d Riis 1948, Fig. 74

Class 82e Riis 1948, Fig. 75

Class 84 Riis 1948, Fig. 133c

Class 105 Riis 1948, Fig. 40

Class 105 Riis 1948, Fig. 83

Class 110 Riis 1948, Figs 84-85

Class 134b Riis 1948, Fig. 109

Class 140 Riis 1948, Fig. 108

Class 157 Riis 1948, Figs 94, 99

Class 158a Riis 1948, Fig. 103

Class 165b Riis 1948, Fig. 102

Class 166 Riis 1948, Figs 115-116

Class 168 Riis 1948, Fig. 101

Class 190 Riis 1948, Fig. 110

Class 191 Riis 1948, Fig. 134

### Cemetery Unstratified

Class 48b Riis 1948, Fig. 62

### Stratum F

Class 40a Fugmann 1958, Fig. 165 (4B931)

Class 53b Fugmann 1958, Fig. 165 (5A503)

Class 73 Fugmann 1958, Fig. 165 (4B10)

Class 93a Fugmann 1958, Fig. 165 (5A555)

Class 102c Fugmann 1958, Fig. 165 (4A923-4A924)

Class 105 Fugmann 1958, Fig. 165 (5B118)

Class 108 Fugmann 1958, Fig. 165 (4B555)

Class 134c Fugmann 1958, Fig. 165 (4B930, 4B937, 4B940, 5A505)

Class 134e Fugmann 1958, Fig. 165 (5A553)

Class 153 Fugmann 1958, Fig. 165 (4B939)

Class 165a Fugmann 1958, Fig. 165 (5A515, 5A536)

Class 165b Fugmann 1958, Fig. 165 (4C52)

Class 187 Fugmann 1958, Fig. 165 (4B956)

### Stratum F1

Class 37b Riis & Buhl 1990, 129 (Pithoi)

Class 42 Riis & Buhl 1990, 129 (Form XIC2)

Class 53b Riis & Buhl 1990, 130 (Form XIX)

Class 53b Riis & Buhl 1990, Fig. 68 (461)

Class 57a Riis & Buhl 1990, 129 (Form IA1)

- Class 57a Riis & Buhl 1990, 129 (Form IA4)  
 Class 73 Riis & Buhl 1990, 130 (Form XVIA)  
 Class 78 Riis & Buhl 1990, 130 (Form XXIIIB)  
 Class 105 Riis & Buhl 1990, 129 (Form III)  
 Class 105 Riis & Buhl 1990, 130 (Form XXIII)  
 Class 118 Riis & Buhl 1990, 129 (Form IC2)  
 Class 160b Riis & Buhl 1990, 130 (Form XXXB2)  
 Class 162 Riis & Buhl 1990, 130 (Form XXXB3)  
 Class 164 Riis & Buhl 1990, 130 (Form XXXB1)  
 Class 165b Riis & Buhl 1990, Fig. 77 (574)  
 Class 165b Riis & Buhl 1990, 130 (Form XXXA2)  
 Class 179 Riis & Buhl 1990, Fig. 78 (587)  
 Class 188 Riis & Buhl 1990, 130 (Form XXVIII A2)
- Stratum F2**  
 Class 36 Riis & Buhl 1990, 129 (Form IC1)  
 Class 40a Riis & Buhl 1990, 129 (Form XIC1)  
 Class 42 Riis & Buhl 1990, 129 (Form XIC2)  
 Class 53b Riis & Buhl 1990, 130 (Form XIX)  
 Class 53b Riis & Buhl 1990, Figs 67 (459); 68 (460)  
 Class 57a Riis & Buhl 1990, 129 (Form IA5)  
 Class 57e Riis & Buhl 1990, 129 (Form VIA2)  
 Class 71a Riis & Buhl 1990, 129 (Form XIIA1)  
 Class 73 Riis & Buhl 1990, 130 (Form XVIA)  
 Class 102c Riis & Buhl 1990, Fig. 68 (466-467)  
 Class 105 Riis & Buhl 1990, Fig. 69 (477)  
 Class 105 Riis & Buhl 1990, 130 (Form XXIII)  
 Class 108 Riis & Buhl 1990, 159 (515)  
 Class 118 Riis & Buhl 1990, 129 (Form IC2)  
 Class 152 Riis & Buhl 1990, 130 (Form XXVIII B1)  
 Class 153 Riis & Buhl 1990, Fig. 78 (591)  
 Class 164 Riis & Buhl 1990, 130 (Form XXXB1)  
 Class 165a Riis & Buhl 1990, 130 (Form XXXA1)  
 Class 165b Riis & Buhl 1990, 130 (Form XXXA2)  
 Class 168 Riis & Buhl 1990, Fig. 74 (523, 526)  
 Class 169 Riis & Buhl 1990, Fig. 74 (520-522, 524)  
 Class 188 Riis & Buhl 1990, Fig. 72 (510)
- Stratum E**  
 Class 4c Fugmann 1958, Figs 269 (5B58); 305 (5B31)  
 Class 7b Fugmann 1958, Fig. 310 (8A60)  
 Class 12b Fugmann 1958, Fig. 310 (7A872)  
 Class 12d Fugmann 1958, Fig. 269 (6B365)  
 Class 37b Fugmann 1958, Fig. 245 (Salle N15)
- Class 37b Fugmann 1958, Fig. 269 (6B580, 6B612)  
 Class 37b Fugmann 1958, Fig. 269 (7A606)  
 Class 37b Riis & Buhl 1990, Fig. 62 (418)  
 Class 40a Fugmann 1958, Fig. 216 (6B581)  
 Class 40a Fugmann 1958, Fig. 310 (7B17)  
 Class 40a Riis & Buhl 1990, Fig. 64 (432-433)  
 Class 48a Fugmann 1958, Fig. 325 (8A51)  
 Class 48b Fugmann 1958, Fig. 269 (6B389)  
 Class 48b Fugmann 1958, Fig. 310 (7B19)  
 Class 48b Fugmann 1958, Fig. 344 (4B580)  
 Class 49 Fugmann 1958, Fig. 310 (7A870)  
 Class 49 Fugmann 1958, Fig. 310 (7B16)  
 Class 49 Fugmann 1958, Fig. 325 (8A53)  
 Class 49 Riis & Buhl 1990, Fig. Fig. 64 (435)  
 Class 51 Fugmann 1958, Fig. 344 (H737)  
 Class 53b Fugmann 1958, Fig. 188 (5B874)  
 Class 53b Fugmann 1958, Fig. 344 (4B768)  
 Class 57a Fugmann 1958, Fig. 344 (L905)  
 Class 57c Fugmann 1958, Fig. 188 (5A842)  
 Class 60 Fugmann 1958, Fig. 310 (7B18)  
 Class 61 Fugmann 1958, Fig. 269 (6B470)  
 Class 68 Fugmann 1958, Fig. 310 (7B198)  
 Class 71a Riis & Buhl 1990, Fig. 66 (449)  
 Class 73 Riis & Buhl 1990, Fig. 67 (451)  
 Class 78 Fugmann 1958, Fig. 344 (4B828)  
 Class 84 Fugmann 1958, Fig. 325 (8A162)  
 Class 102b Fugmann 1958, Fig. 344 (4C854)  
 Class 102c Fugmann 1958, Fig. 344 (O101)  
 Class 105 Fugmann 1958, Fig. 216 (6C162)  
 Class 108 Fugmann 1958, Fig. 344 (4C756)  
 Class 118 Fugmann 1958, Fig. 305 (5B59)  
 Class 131a Fugmann 1958, Fig. 310 (7A874)  
 Class 134b Fugmann 1958, Fig. 344 (4C752)  
 Class 134b Fugmann 1958, Fig. 344 (H814)  
 Class 134d Fugmann 1958, Fig. 188 (5A875, 5A879, 5A896, 5B676, 5B686, 5B299)  
 Class 134d Fugmann 1958, Fig. 216 (6B540, 6B541, 6B543, 6B544, 6B545, 6B546)  
 Class 134d Fugmann 1958, Figs 245 (5B658); 269 (6B482, 6B483); 325 (8A220)  
 Class 134d Fugmann 1958, Fig. 325 (8A57, 8A63, 8A64, 8A70, 8A155, 8A156)  
 Class 134e Fugmann 1958, Fig. 269 (above 6B468)  
 Class 152 Riis & Buhl 1990, Fig. 72 (511)  
 Class 157 Fugmann 1958, Fig. 305 (5B30)  
 Class 157 Fugmann 1958, Fig. 310 (7B22)  
 Class 160a Fugmann 1958, Fig. 344 (H914)  
 Class 165a Fugmann 1958, Fig. 269 (6B369)  
 Class 165a Fugmann 1958, Fig. 269 (6B476)  
 Class 165a Fugmann 1958, Fig. 310 (7A873, 7B21, 7B407)  
 Class 165a Fugmann 1958, Fig. 325 (8A185)  
 Class 165a Riis & Buhl 1990, Fig. 75 (540)  
 Class 165b Fugmann 1958, Figs 188 (5B693); 216 (7B682)  
 Class 165b Fugmann 1958, Fig. 245 (7B682)  
 Class 165b Fugmann 1958, Fig. 269 (6B386)

Class 165b Fugmann 1958, Fig. 269 (4C56, 5B60, 6B445, 6B477, 6B515, 6C52)  
 Class 165b Fugmann 1958, Fig. 269 (6B431, 6B472, 6B492, 6B516, 7A878, 7B213)  
 Class 165b Fugmann 1958, Figs 269 (6B368, 6B398, 6B479); 305 (5B83, 5B108)  
 Class 165b Fugmann 1958, Fig. 310 (8A118)  
 Class 165b Fugmann 1958, Fig. 325 (8A68)  
 Class 165b Fugmann 1958, Fig. 325 (8A152, 8A187, 8A222)  
 Class 165b Fugmann 1958, Fig. 344 (4C995)  
 Class 165b Fugmann 1958, Fig. 344 (4B835, 4B843, 4B767, 4B830, H796)  
 Class 165b Riis & Buhl 1990, Fig. 76 (556-557)  
 Class 166 Fugmann 1958, Figs 188 (5B93); 216 (Salle A); 245 (Salle N15)  
 Class 166 Fugmann 1958, Figs 269 (5A499, 5A500, 6B471); 344 (H742, H908)  
 Class 166 Fugmann 1958, Figs 310 (7A875, 7B20, 7B418, 8A219); 325 (8A58)  
 Class 166 Riis & Buhl 1990, Fig. 80 (618, 621)  
 Class 178 Fugmann 1958, Fig. 310 (7A871)  
 Class 182a Fugmann 1958, Figs 310 (8A151); 344 (4B553)  
 Class 182a Riis & Buhl 1990, 158 (504-506)  
 Class 182a Riis & Buhl 1990, Fig. 73 (519)  
 Class 182c Riis & Buhl 1990, Fig. 72 (509)  
 Class 188 Fugmann 1958, Fig. 344 (4B14)  
 Class 190 Fugmann 1958, Figs 188 (5B411, 5B414); 216 (6C161, 6C163)  
 Class 191 Fugmann 1958, Figs 310 (7B23); 344 (L941)  
**Stratum E1**  
 Class 7a Riis & Buhl 1990, 129 (Form XID)  
 Class 37b Riis & Buhl 1990, 129 (Pithoi)  
 Class 37b Riis & Buhl 1990, 137 (415-416), Fig. 61 (415)  
 Class 40a Riis & Buhl 1990, 129 (Form XIC1)  
 Class 40a Riis & Buhl 1990, 129 (Form XIE1)  
 Class 40c Riis & Buhl 1990, 129 (Form XIB)  
 Class 42 Riis & Buhl 1990, 129 (Form XIC2)  
 Class 48b Riis & Buhl 1990, 129 (Form XIE2)  
 Class 48b Riis & Buhl 1990, Fig. 66 (448)  
 Class 53b Riis & Buhl 1990, 130 (Form XIX)  
 Class 57a Riis & Buhl 1990, 129 (Forms IA1 & IA5)  
 Class 57a Riis & Buhl 1990, 129 (Form IA2)  
 Class 57a Riis & Buhl 1990, 129 (Form IA8)  
 Class 57c Riis & Buhl 1990, 129 (Form VIB2)  
 Class 61 Riis & Buhl 1990, 129 (Form VIB3)  
 Class 68 Riis & Buhl 1990, 129 (Form XIID4); Fig. 67 (450)  
 Class 82e Riis & Buhl 1990, 130 (Form XVIB)  
 Class 105 Riis & Buhl 1990, 129 (Form III)  
 Class 105 Riis & Buhl 1990, 130 (Form XXIII)  
 Class 134b Riis & Buhl 1990, Fig. 78 (593)

Class 134b Riis & Buhl 1990, 130 (Form XXXC2)  
 Class 140 Riis & Buhl 1990, 130 (Form XXXC1)  
 Class 152 Riis & Buhl 1990, 130 (Form XXVIII B1)  
 Class 157 Fugmann 1958, Fig. 188 (5B412)  
 Class 157 Riis & Buhl 1990, 130 (Form XXVIII A2)  
 Class 157 Riis & Buhl 1990, 130 (Form XXVIII B4)  
 Class 157 Riis & Buhl 1990, 130 (Forms XXVIII C4 & C5)  
 Class 158a Riis & Buhl 1990, 130 (Form XXXA3)  
 Class 162 Riis & Buhl 1990, 130 (Form XXXB3)  
 Class 164 Riis & Buhl 1990, 130 (Form XXXB1)  
 Class 165a Riis & Buhl 1990, Fig. 75 (535-536)  
 Class 165a Riis & Buhl 1990, Fig. 76 (545, 547)  
 Class 165a Riis & Buhl 1990, Fig. 76 (555)  
 Class 165a Riis & Buhl 1990, 130 (Form XXXA1)  
 Class 165b Riis & Buhl 1990, Fig. 76 (558)  
 Class 165b Riis & Buhl 1990, Fig. 77 (572-573)  
 Class 165b Riis & Buhl 1990, 130 (Form XXXA2)  
 Class 166 Riis & Buhl 1990, Fig. 80 (620)  
 Class 166 Riis & Buhl 1990, 130 (Form XXXIIB1)  
 Class 166 Riis & Buhl 1990, 130 (Form XXXIIB2)  
 Class 185 Riis & Buhl 1990, 130 (Form XXVIII B2)  
 Class 188 Fugmann 1958, Fig. 325 (8A67)  
 Class 188 Riis & Buhl 1990, 130 (Form XXVIII A1)  
 Class 188 Riis & Buhl 1990, 130 (Form XXVIII A2)  
 Class 188 Riis & Buhl 1990, 130 (Form XXVIII C2)  
 Class 190 Riis & Buhl 1990, Fig. 78 (599)  
 Class 190 Riis & Buhl 1990, 130 (Form XXXC3)  
**Stratum E2**  
 Class 37b Riis & Buhl 1990, 129 (Pithoi)  
 Class 42 Riis & Buhl 1990, 129 (Form XIC2)  
 Class 53b Riis & Buhl 1990, Fig. 67 (457)  
 Class 53b Riis & Buhl 1990, 130 (Form XIX)  
 Class 53b Riis & Buhl 1990, 146 (458)  
 Class 57a Riis & Buhl 1990, 129 (Form IA1)  
 Class 57a Riis & Buhl 1990, 129 (Form IA4)  
 Class 78 Riis & Buhl 1990, 130 (Form XXII B)  
 Class 105 Riis & Buhl 1990, 129 (Form III)  
 Class 105 Riis & Buhl 1990, 130 (Form XXIII)

Class 134b Riis & Buhl 1990, Fig. 78 (592)  
Class 152 Riis & Buhl 1990, 130 (Form  
XXVIII B1)  
Class 157 Riis & Buhl 1990, 130 (Form  
XXVIII A2)  
Class 162 Riis & Buhl 1990, 130 (Form  
XXX B3)  
Class 165a Riis & Buhl 1990, Fig. 75 (539)

Class 165a Riis & Buhl 1990, Fig. 76 (552)  
Class 165a Riis & Buhl 1990, 130 (Form  
XXX A1)  
Class 165b Riis & Buhl 1990, 130 (Form  
XXX A2)  
Class 188 Riis & Buhl 1990, 130 (Form  
XXVIII A2)

## C.17 Hazor

### Stratum II

Class 4c Yadin et al. 1960, Pl. 75.26  
Class 9a Yadin et al. 1958, Pl. 80.23-27  
Class 9a Yadin et al. 1961, Pl. 191.15  
Class 9a Yadin et al. 1961, Pl. 257.12-14  
Class 12c Yadin et al. 1961, Pl. 191.16  
Class 12c Yadin et al. 1961, Pl. 258.2-3  
Class 15 Yadin et al. 1958, Pl. 82.15-17  
Class 18 Yadin et al. 1958, Pl. 83.1  
Class 18 Yadin et al. 1961, Pl. 257.27  
Class 23 Yadin et al. 1958, Pl. 81.2  
Class 28 Yadin et al. 1958, Pl. 81.1, 3-4  
Class 28 Yadin et al. 1958, Pl. 83.3  
Class 98 Yadin et al. 1958, Pl. 80.1-10  
Class 98 Yadin et al. 1961, Pl. 191.1-6, 8-12  
Class 102b Yadin et al. 1961, Pl. 258.1  
Class 119 Yadin et al. 1958, Pl. 80.22  
Class 159 Yadin et al. 1958, Pl. 81.8  
Class 193 Yadin et al. 1958, Pl. 79.17-18, 20-  
21, 23-24, 26-27  
Class 193 Yadin et al. 1960, Pl. 75.20-23  
Class 193 Yadin et al. 1961, Pl. 257.1-10

### Stratum III

Class 7a Yadin et al. 1958, Pl. 76.9, 19  
Class 8a Yadin et al. 1958, Pl. 76.8  
Class 13 Yadin et al. 1958, Pl. 77.16  
Class 102a Yadin et al. 1958, Pl. 77.28-29  
Class 134c Yadin et al. 1958, Pl. 77.20  
Class 139 Yadin et al. 1958, Pl. 77.7-8, 23  
Class 141c Yadin et al. 1958, Pl. 77.1, 32  
Class 141d Yadin et al. 1958, Pl. 74.17  
Class 141d Yadin et al. 1958, Pl. 77.6  
Class 148 Yadin et al. 1958, Pl. 77.21  
Class 152 Yadin et al. 1958, Pl. 76.14  
Class 152 Yadin et al. 1958, Pl. 77.19  
Class 160a Yadin et al. 1958, Pl. 77.26  
Class 173a Yadin et al. 1958, Pl. 77.2  
Class 176 Yadin et al. 1958, Pl. 76.4  
Class 182c Yadin et al. 1958, Pl. 77.25  
Class 183 Yadin et al. 1958, Pl. 77.3

### Stratum III/IV

Class 7a Yadin et al. 1958, Pl. 78.16  
Class 56 Yadin et al. 1958, Pl. 78.15  
Class 100c Yadin et al. 1958, Pl. 78.17  
Class 134d Yadin et al. 1958, Pl. 78.7  
Class 139 Yadin et al. 1958, Pl. 78.8  
Class 140 Yadin et al. 1958, Pl. 78.12, 27  
Class 160a Yadin et al. 1958, Pl. 78.9  
Class 161 Yadin et al. 1958, Pl. 78.5

### Stratum IV

Class 2 Yadin et al. 1958, Pl. 58.10  
Class 4b Yadin et al. 1958, Pl. 70.8  
Class 4b Yadin et al. 1960, Pl. 99.16  
Class 4c Yadin et al. 1961, Pl. 255.10  
Class 5 Yadin et al. 1960, Pl. 99.17-19  
Class 7a Yadin et al. 1958, Pl. 58.8  
Class 7a Yadin et al. 1958, Pl. 72.5-6  
Class 7a Yadin et al. 1958, Pl. 70.6-7  
Class 7a Yadin et al. 1960, Pl. 99.15, 21-22  
Class 7a Yadin et al. 1961, Pl. 255.8  
Class 7a Ben Tor et al. 1997, Fig. III.50 (9-10)  
Class 8a Ben Tor et al. 1997, Fig. III.50 (8, 11)  
Class 10 Yadin et al. 1961, Pl. 256.1  
Class 12b Yadin et al. 1960, Pl. 100.25-27  
Class 16b Yadin et al. 1960, Pl. 101.6  
Class 22 Yadin et al. 1960, Pl. 101.2, 8  
Class 24a Yadin et al. 1960, Pl. 101.9  
Class 24b Yadin et al. 1960, Pl. 101.10, 12-15  
Class 24b Yadin et al. 1961, Pl. 255.23  
Class 26 Yadin et al. 1960, Pl. 101.11  
Class 28 Yadin et al. 1960, Pl. 100.32  
Class 54 Yadin et al. 1958, Pl. 70.1, 3-4  
Class 54 Yadin et al. 1958, Pl. 71.21-22  
Class 54 Yadin et al. 1960, Pl. 99.1, 3, 5-7, 9  
Class 54 Yadin et al. 1960, Pl. 107.19  
Class 74 Yadin et al. 1960, Pl. 100.22  
Class 88 Yadin et al. 1960, Pl. 100.15-18  
Class 91 Yadin et al. 1958, Pl. 72.7  
Class 100c Yadin et al. 1960, Pl. 100.14  
Class 134b Yadin et al. 1958, Pl. 58.2  
Class 134d Yadin et al. 1958, Pl. 69.14  
Class 134d Yadin et al. 1960, Pl. 98.21  
Class 134d Yadin et al. 1961, Pl. 254.18  
Class 134e Yadin et al. 1958, Pl. 69.20  
Class 135 Yadin et al. 1960, Pl. 98.43  
Class 139 Yadin et al. 1958, Pl. 30.31  
Class 139 Yadin et al. 1958, Pl. 58.4  
Class 139 Yadin et al. 1958, Pl. 69.32  
Class 139 Yadin et al. 1958, Pl. 71.16  
Class 139 Yadin et al. 1960, Pl. 98.16, 25-28  
Class 139 Yadin et al. 1960, Pl. 98.31-32, 36,  
38  
Class 139 Yadin et al. 1961, Pl. 254.21-22  
Class 140 Yadin et al. 1958, Pl. 69.27  
Class 141a Yadin et al. 1958, Pl. 58.3  
Class 141a Yadin et al. 1961, Pl. 254.12  
Class 141c Yadin et al. 1960, Pl. 98.10  
Class 141c Yadin et al. 1960, Pl. 98.13, 23, 39

Class 141c Yadin et al. 1961, Pl. 254.13-17  
 Class 141d Ben Tor et al. 1997, Fig. III.50 (1-3)  
 Class 152 Yadin et al. 1958, Pl. 58.1  
 Class 152 Yadin et al. 1960, Pl. 98.1, 3-6  
 Class 152 Yadin et al. 1961, Pl. 254.1-2  
 Class 160a Yadin et al. 1961, Pl. 254.10-11  
 Class 160b Yadin et al. 1960, Pl. 99.13  
 Class 161 Yadin et al. 1961, Pl. 254.26  
 Class 169 Yadin et al. 1958, Pl. 69.18  
 Class 169 Yadin et al. 1960, Pl. 98.17  
 Class 170 Yadin et al. 1961, Pl. 254.9  
 Class 172 Yadin et al. 1960, Pl. 98.35  
 Class 181 Yadin et al. 1961, Pl. 254.7, 27  
 Class 182a Yadin et al. 1961, Pl. 254.6  
 Class 182b Yadin et al. 1960, Pl. 98.7-8  
 Class 182c Yadin et al. 1961, Pl. 254.30  
**Stratum IV/V**  
 Class 7a Yadin et al. 1958, Pl. 72.1-4  
 Class 12d Yadin et al. 1958, Pl. 71.25  
 Class 97 Yadin et al. 1958, Pl. 72.7  
 Class 139 Yadin et al. 1958, Pl. 71.15  
 Class 152 Yadin et al. 1958, Pl. 71.1  
 Class 173a Yadin et al. 1958, Pl. 71.4  
 Class 175 Yadin et al. 1958, Pl. 71.8-9  
 Class 176 Yadin et al. 1958, Pl. 71.7  
 Class 182a Yadin et al. 1958, Pl. 71.3  
**Stratum V**  
 Class 4b Yadin et al. 1960, Pl. 85.13  
 Class 4b Yadin et al. 1961, Pl. 189.9  
 Class 4b Yadin et al. 1961, Pl. 227.13  
 Class 4b Yadin et al. 1961, Pl. 252.10  
 Class 4b Yadin et al. 1958, Pl. 55.1  
 Class 4c Yadin et al. 1958, Pl. 55.5  
 Class 5 Yadin et al. 1958, Pl. 73.38  
 Class 5 Yadin et al. 1960, Pl. 94.19  
 Class 5 Yadin et al. 1961, Pl. 189.10  
 Class 5 Yadin et al. 1961, Pl. 252.11  
 Class 7a Yadin et al. 1958, Pl. 55.3-4, 6-10  
 Class 7a Yadin et al. 1958, Pl. 67.36  
 Class 7a Yadin et al. 1958, Pl. 73.39  
 Class 7a Yadin et al. 1958, Pl. 74.22-23  
 Class 7a Yadin et al. 1960, Pl. 75.4  
 Class 7a Yadin et al. 1960, Pl. 79.20  
 Class 7a Yadin et al. 1960, Pl. 85.1-7, 9-11  
 Class 7a Yadin et al. 1961, Pl. 189.11  
 Class 7a Yadin et al. 1961, Pl. 190.2-3  
 Class 7a Yadin et al. 1961, Pl. 221.3  
 Class 7a Yadin et al. 1961, Pl. 224.1-4  
 Class 7a Yadin et al. 1961, Pl. 227.11-12, 14-19  
 Class 7a Yadin et al. 1961, Pl. 230.16  
 Class 7a Yadin et al. 1961, Pl. 231.6  
 Class 7a Yadin et al. 1961, Pl. 252.12  
 Class 7a Ben Tor et al. 1997, Fig. III.42 (15)  
 Class 7a Ben Tor et al. 1997, Fig. III.44 (6)  
 Class 7a Ben Tor et al. 1997, Fig. III.47 (10-11)  
 Class 7b Yadin et al. 1958, Pl. 55.2  
 Class 8a Yadin et al. 1958, Pl. 73.5

Class 8a Yadin et al. 1958, Pl. 74.21  
 Class 8b Yadin et al. 1958, Pl. 67.34, 37  
 Class 8b Yadin et al. 1958, Pl. 73.14, 37  
 Class 8d Yadin et al. 1958, Pl. 73.4  
 Class 8e Yadin et al. 1960, Pl. 85.17  
 Class 8e Ben Tor et al. 1997, Fig. III.42 (12-13)  
 Class 10 Yadin et al. 1958, Pl. 56.25  
 Class 10 Yadin et al. 1961, Pl. 253.5-6  
 Class 11b Yadin et al. 1958, Pl. 69.10  
 Class 11b Yadin et al. 1958, Pl. 73.9  
 Class 11b Yadin et al. 1958, Pl. 74.31  
 Class 12b Yadin et al. 1958, Pl. 57.18-21  
 Class 12b Yadin et al. 1960, Pl. 75.17-18  
 Class 12b Yadin et al. 1960, Pl. 88.12-14  
 Class 12b Yadin et al. 1960, Pl. 97.13  
 Class 12b Yadin et al. 1961, Pl. 221.17  
 Class 12b Yadin et al. 1961, Pl. 224.14-15  
 Class 12b Yadin et al. 1961, Pl. 232.1-7, 11-12  
 Class 12c Yadin et al. 1960, Pl. 88.15-17  
 Class 12c Ben Tor et al. 1997, Fig. III.42 (9)  
 Class 12d Yadin et al. 1961, Pl. 232.8  
 Class 13 Yadin et al. 1960, Pl. 107.18  
 Class 13 Yadin et al. 1961, Pl. 232.13  
 Class 14 Yadin et al. 1958, Pl. 54.18  
 Class 15 Yadin et al. 1958, Pl. 57.22-23  
 Class 15 Yadin et al. 1961, Pl. 189.26  
 Class 15 Yadin et al. 1961, Pl. 232.14-18  
 Class 15 Yadin et al. 1961, Pl. 253.9  
 Class 15 Ben Tor et al. 1997, Fig. III.47 (28)  
 Class 16b Yadin et al. 1960, Pl. 75.16  
 Class 16b Yadin et al. 1960, Pl. 89.1, 4-5, 8-10  
 Class 16b Yadin et al. 1961, Pl. 229.2, 6-7  
 Class 16b Ben Tor et al. 1997, Fig. III.43 (6)  
 Class 16b Ben Tor et al. 1997, Fig. III.46 (2)  
 Class 17 Yadin et al. 1958, Pl. 68.3-4  
 Class 17 Yadin et al. 1958, Pl. 84.17  
 Class 17 Yadin et al. 1960, Pl. 89.3  
 Class 22 Yadin et al. 1960, Pl. 90.8, 10  
 Class 22 Yadin et al. 1961, Pl. 221.9  
 Class 23 Yadin et al. 1960, Pl. 79.26  
 Class 24b Yadin et al. 1958, Pl. 57.11  
 Class 24b Yadin et al. 1960, Pl. 79.24-25  
 Class 24b Yadin et al. 1960, Pls 90.1-7  
 Class 24b Yadin et al. 1960, Pl. 91.1-13  
 Class 24b Yadin et al. 1961, Pl. 229.9-13  
 Class 24b Yadin et al. 1961, Pl. 253.1  
 Class 24b Ben Tor et al. 1997, Figs III.43 (7); 46 (1)  
 Class 28 Yadin et al. 1961, Pl. 189.24  
 Class 29 Yadin et al. 1961, Pl. 228.13  
 Class 44 Ben Tor et al. 1997, Fig. III.46 (3)  
 Class 47 Yadin et al. 1960, Pl. 96.2  
 Class 48b Yadin et al. 1960, Pl. 83.10-11  
 Class 48b Yadin et al. 1960, Pl. 84.1  
 Class 48b Yadin et al. 1960, Pl. 94.7  
 Class 48b Yadin et al. 1960, Pl. 107.10  
 Class 48b Yadin et al. 1961, Pl. 227.1  
 Class 48b Yadin et al. 1961, Pl. 230.11  
 Class 48b Ben Tor et al. 1997, Fig. III.43 (1)



- Class 48b Ben Tor et al. 1997, Fig. III.48 (7)
- Class 49 Yadin et al. 1960, Pl. 83.13
- Class 49 Yadin et al. 1961, Pl. 227.3-4
- Class 54 Yadin et al. 1958, Pl. 54.19, 21, 24
- Class 54 Yadin et al. 1960, Pl. 79.19
- Class 54 Yadin et al. 1960, Pl. 83.1-4, 7, 9
- Class 54 Yadin et al. 1960, Pl. 84.3
- Class 54 Yadin et al. 1960, Pl. 107.11
- Class 54 Yadin et al. 1961, Pl. 222.28-30
- Class 54 Yadin et al. 1961, Pl. 223.20
- Class 54 Yadin et al. 1961, Pl. 226.14-15
- Class 54 Yadin et al. 1961, Pl. 252.1, 9
- Class 54 Ben Tor et al. 1997, Fig. III.42 (23)
- Class 56 Yadin et al. 1958, Pl. 54.29
- Class 61 Yadin et al. 1961, Pl. 190.5
- Class 64 Yadin et al. 1958, Pl. 57.12-13
- Class 67 Yadin et al. 1960, Pl. 89.11
- Class 67 Yadin et al. 1960, Pl. 96.3
- Class 67 Yadin et al. 1961, Pl. 228.24-25
- Class 70 Yadin et al. 1961, Pl. 228.3
- Class 73 Yadin et al. 1961, Pl. 228.2
- Class 77 Yadin et al. 1961, Pl. 224.10
- Class 82a Yadin et al. 1958, Pl. 69.8
- Class 82b Yadin et al. 1961, Pl. 189.17
- Class 82c Yadin et al. 1960, Pl. 87.3
- Class 82c Yadin et al. 1961, Pl. 228.12
- Class 84 Yadin et al. 1961, Pl. 228.22
- Class 84 Ben Tor et al. 1997, Fig. III.42 (16)
- Class 86 Yadin et al. 1961, Pl. 224.9
- Class 86 Yadin et al. 1961, Pl. 228.7-9
- Class 87 Yadin et al. 1960, Pl. 87.13-14, 19
- Class 88 Yadin et al. 1958, Pl. 56.18
- Class 88 Yadin et al. 1960, Pl. 87.6
- Class 90a Yadin et al. 1960, Pl. 88.4
- Class 90a Yadin et al. 1961, Pl. 230.20
- Class 90b Yadin et al. 1960, Pl. 88.1-2
- Class 91 Yadin et al. 1958, Pl. 56.22
- Class 91 Yadin et al. 1960, Pl. 75.10
- Class 91 Yadin et al. 1960, Pl. 79.18
- Class 91 Yadin et al. 1960, Pl. 87.4-5
- Class 91 Yadin et al. 1960, Pl. 218.9-10
- Class 97 Yadin et al. 1958, Pl. 56.17
- Class 97 Yadin et al. 1960, Pl. 97.1
- Class 97 Yadin et al. 1961, Pl. 224.8
- Class 97 Yadin et al. 1961, Pl. 230.22
- Class 100b Yadin et al. 1958, Pl. 56.1-3
- Class 100b Yadin et al. 1958, Pl. 73.6
- Class 100b Yadin et al. 1960, Pl. 86.7-8, 10-15
- Class 100b Yadin et al. 1960, Pl. 107.14
- Class 100b Yadin et al. 1961, Pl. 224.7
- Class 100b Yadin et al. 1961, Pl. 228.14-16
- Class 100b Ben Tor et al. 1997, Fig. III.42 (17-18)
- Class 100b Ben Tor et al. 1997, Fig. III.44 (7)
- Class 100b Ben Tor et al. 1997, Fig. III.47 (14)
- Class 100c Yadin et al. 1958, Pl. 56.5
- Class 100c Yadin et al. 1960, Pl. 79.21-23
- Class 100c Yadin et al. 1960, Pl. 86.2-4, 9, 16-18
- Class 100c Yadin et al. 1961, Pl. 224.5-6
- Class 100c Yadin et al. 1961, Pl. 252.13
- Class 100c Ben Tor et al. 1997, Fig. III.42 (3)
- Class 100d Ben Tor et al. 1997, Fig. III.47 (15)
- Class 102a Yadin et al. 1958; Pl. 56.23
- Class 102b Yadin et al. 1960, Pl. 88.7-8
- Class 102b Yadin et al. 1961, Pl. 228.23, 26
- Class 106 Yadin et al. 1961, Pl. 228.1
- Class 121a Yadin et al. 1960, Pl. 97.11
- Class 124 Yadin et al. 1960, Pl. 75.5
- Class 126 Yadin et al. 1958, Pl. 73.2-3, 35
- Class 126 Yadin et al. 1958, Pl. 74.19
- Class 126 Ben Tor et al. 1997, Fig. III.42 (8)
- Class 134a Yadin et al. 1958, Pl. 67.2, 4
- Class 134a Yadin et al. 1961, Pl. 189.5
- Class 134d Yadin et al. 1958, Pl. 74.10
- Class 134d Yadin et al. 1960, Pl. 82.11
- Class 134d Yadin et al. 1961, Pl. 222.10
- Class 134d Yadin et al. 1961, Pl. 231.5
- Class 134e Yadin et al. 1960, Pl. 93.4
- Class 134e Yadin et al. 1961, Pl. 222.4
- Class 134e Yadin et al. 1961, Pl. 223.13
- Class 134e Ben Tor et al. 1997, Fig. III.42 (21)
- Class 139 Yadin et al. 1958, Pl. 54.2-4, 14-15
- Class 139 Yadin et al. 1960, Pl. 82.3, 12-14
- Class 139 Yadin et al. 1960, Pl. 93.7, 10
- Class 139 Yadin et al. 1961, Pl. 222.18
- Class 139 Yadin et al. 1961, Pl. 223.15
- Class 139 Yadin et al. 1961, Pl. 225.12
- Class 139 Yadin et al. 1961, Pl. 226.6-7, 9-11
- Class 139 Yadin et al. 1961, Pl. 230.2
- Class 139 Yadin et al. 1961, Pl. 251.22
- Class 140 Yadin et al. 1960, Pl. 93.1
- Class 140 Yadin et al. 1961, Pl. 251.23
- Class 140 Ben Tor et al. 1997, Fig. III.42 (7)
- Class 141a Yadin et al. 1958, Pl. 73.30
- Class 141a Yadin et al. 1960, Pl. 79.13-14
- Class 141a Yadin et al. 1960, Pl. 92.10-11, 19, 27
- Class 141a Yadin et al. 1961, Pl. 189.3
- Class 141a Yadin et al. 1961, Pl. 226.1
- Class 141a Yadin et al. 1961, Pl. 230.8
- Class 141a Yadin et al. 1961, Pl. 251.20
- Class 141b Yadin et al. 1960, Pl. 82.10
- Class 141b Yadin et al. 1961, Pl. 223.12
- Class 141c Yadin et al. 1958, Pl. 53.13, 16
- Class 141c Yadin et al. 1958, Pl. 54.1, 11
- Class 141c Yadin et al. 1958, Pl. 67.12, 23
- Class 141c Yadin et al. 1958, Pl. 71.5
- Class 141c Yadin et al. 1958, Pl. 73.31
- Class 141c Yadin et al. 1958, Pl. 74.8-9
- Class 141c Yadin et al. 1960, Pl. 81.14-28
- Class 141c Yadin et al. 1960, Pl. 92.12-13, 22-23
- Class 141c Yadin et al. 1961, Pl. 222.1-3, 5-6
- Class 141c Yadin et al. 1961, Pl. 223.10-11, 14
- Class 141c Yadin et al. 1961, Pl. 225.14, 24-25, 27
- Class 141c Yadin et al. 1961, Pl. 230.6-7
- Class 141c Ben Tor et al. 1997, Fig. III.47 (5)
- Class 141d Yadin et al. 1958, Pl. 67.19-20

- Class 141d Yadin et al. 1960, Pl. 75.2  
 Class 141d Yadin et al. 1960, Pl. 79.5  
 Class 141d Yadin et al. 1960, Pl. 80.33  
 Class 141d Yadin et al. 1960, Pl. 92.29  
 Class 141d Yadin et al. 1961, Pl. 251.9, 14  
 Class 141d Ben Tor et al. 1997, Fig. III.42 (22)  
 Class 145a Yadin et al. 1961, Pl. 251.27  
 Class 148 Yadin et al. 1958, Pl. 53.2  
 Class 152 Yadin et al. 1958, Pl. 53.4, 9  
 Class 152 Yadin et al. 1958, Pl. 54.8  
 Class 152 Yadin et al. 1958, Pl. 74.17  
 Class 152 Yadin et al. 1960, Pl. 79.1-2  
 Class 152 Yadin et al. 1960, Pl. 80.1-4, 6-17, 21, 23-24  
 Class 152 Yadin et al. 1960, Pl. 92.7  
 Class 152 Yadin et al. 1961, Pl. 189.1  
 Class 152 Yadin et al. 1961, Pl. 222.17, 21-22  
 Class 152 Yadin et al. 1961, Pl. 223.1  
 Class 152 Yadin et al. 1961, Pl. 225.2-10  
 Class 152 Ben Tor et al. 1997, Fig. III.45(4)  
 Class 152 Ben Tor et al. 1997, Fig. III.47(1-2, 4)  
 Class 154 Yadin et al. 1961, Pl. 230.4  
 Class 155 Yadin et al. 1958, Pl. 54.6-7  
 Class 155 Yadin et al. 1960, Pl. 92.5-6  
 Class 155 Yadin et al. 1961, Pl. 230.12  
 Class 156 Yadin et al. 1958, Pl. 67.24  
 Class 157 Yadin et al. 1958, Pl. 74.13  
 Class 157 Yadin et al. 1960, Pl. 80.30  
 Class 157 Yadin et al. 1960, Pl. 92.9  
 Class 157 Yadin et al. 1961, Pl. 223.19  
 Class 157 Yadin et al. 1961, Pl. 251.3-4  
 Class 158a Yadin et al. 1960, Pl. 80.18-20, 22  
 Class 158a Yadin et al. 1961, Pl. 251.5-6  
 Class 158a Ben Tor et al. 1997, Fig. III.47 (3)  
 Class 160a Yadin et al. 1958, Pl. 53.8  
 Class 160a Yadin et al. 1958, Pl. 67.14  
 Class 160a Yadin et al. 1960, Pl. 75.3  
 Class 160a Yadin et al. 1961, Pl. 220.13  
 Class 160a Yadin et al. 1961, Pl. 225.13  
 Class 160a Yadin et al. 1961, Pl. 226.8  
 Class 160a Ben Tor et al. 1997, Fig. III.45 (1)  
 Class 160b Yadin et al. 1960, Pl. 92.17  
 Class 162 Yadin et al. 1958, Pl. 73.33  
 Class 162 Yadin et al. 1958, Pl. 74.5  
 Class 162 Yadin et al. 1960, Pl. 79.8  
 Class 162 Yadin et al. 1960, Pl. 80.31  
 Class 162 Yadin et al. 1961, Pl. 251.26  
 Class 164 Yadin et al. 1961, Pl. 222.7  
 Class 168 Yadin et al. 1960, Pl. 81.11-12  
 Class 168 Yadin et al. 1961, Pl. 189.2  
 Class 168 Yadin et al. 1961, Pl. 225.16-17, 23  
 Class 169 Yadin et al. 1960, Pl. 79.12  
 Class 169 Yadin et al. 1961, Pl. 222.15-16  
 Class 169 Yadin et al. 1961, Pl. 223.3-8  
 Class 169 Yadin et al. 1961, Pl. 251.7  
 Class 170 Yadin et al. 1958, Pl. 54.13  
 Class 170 Yadin et al. 1958, Pl. 67.13, 18  
 Class 170 Yadin et al. 1958, Pl. 74.6  
 Class 172 Yadin et al. 1958, Pl. 54.10  
 Class 172 Yadin et al. 1960, Pl. 79.6  
 Class 172 Yadin et al. 1960, Pl. 82.6  
 Class 172 Yadin et al. 1961, Pl. 189.9  
 Class 172 Yadin et al. 1961, Pl. 231.14, 17  
 Class 173a Yadin et al. 1958, Pl. 53.10  
 Class 173a Yadin et al. 1958, Pl. 54.12  
 Class 173a Yadin et al. 1958, Pl. 67.10  
 Class 173a Yadin et al. 1958, Pl. 73.16  
 Class 173a Yadin et al. 1961, Pl. 222.8  
 Class 173a Yadin et al. 1961, Pl. 251.28  
 Class 174 Yadin et al. 1958, Pl. 74.4  
 Class 176 Yadin et al. 1958, Pl. 53.12  
 Class 176 Yadin et al. 1958, Pl. 67.6-7  
 Class 176 Yadin et al. 1958, Pl. 73.24-25  
 Class 176 Yadin et al. 1958, Pl. 74.7  
 Class 176 Ben Tor et al. 1997, Fig. III.42 (5)  
 Class 179 Yadin et al. 1960, Pl. 79.10  
 Class 179 Yadin et al. 1960, Pl. 81.13  
 Class 179 Yadin et al. 1961, Pl. 222.19  
 Class 179 Yadin et al. 1961, Pl. 225.20-22  
 Class 179 Yadin et al. 1961, Pl. 231.2  
 Class 180 Ben Tor et al. 1997, Fig. III.44 (14)  
 Class 180 Ben Tor et al. 1997, Fig. III.45 (2)  
 Class 181 Yadin et al. 1958, Pl. 74.12  
 Class 181 Yadin et al. 1960, Pl. 79.9  
 Class 181 Yadin et al. 1961, Pl. 222.25  
 Class 181 Yadin et al. 1961, Pl. 231.18  
 Class 182b Yadin et al. 1958, Pl. 53.6-7  
 Class 182b Yadin et al. 1958, Pl. 73.22  
 Class 182b Yadin et al. 1960, Pl. 82.16  
 Class 182b Ben Tor et al. 1997, Fig. III.42 (1)  
 Class 182c Yadin et al. 1958, Pl. 67.26  
 Class 182c Yadin et al. 1960, Pl. 93.16  
 Class 184 Yadin et al. 1960, Pl. 80.25-28  
 Class 184 Yadin et al. 1961, Pl. 222.24
- Stratum VI**  
 Class 4b Yadin et al. 1960, Pl. 69.5  
 Class 4b Yadin et al. 1961, Pl. 184.5  
 Class 4b Ben Tor et al. 1997, Fig. II.58 (27)  
 Class 4c Yadin et al. 1961, Pl. 184.11  
 Class 5 Yadin et al. 1960, Pl. 69.12, 14  
 Class 5 Ben Tor et al. 1997, Fig. III.35 (17)  
 Class 7a Yadin et al. 1958, Pl. 52.8-11  
 Class 7a Yadin et al. 1960, Pl. 69.4, 6-11, 13, 15-20  
 Class 7a Yadin et al. 1961, Pl. 185.6-10, 12-14  
 Class 7a Yadin et al. 1961, Pl. 215.9  
 Class 7a Yadin et al. 1961, Pl. 219.17-18  
 Class 7a Yadin et al. 1961, Pl. 220.22-23  
 Class 7a Ben Tor et al. 1997, Fig. III.36 (12-13)  
 Class 7a Ben Tor et al. 1997, Fig. III.38 (11-13)  
 Class 7a Ben Tor et al. 1997, Fig. III.39 (15-17)  
 Class 7a Ben Tor et al. 1997, Fig. II.54 (25-26)  
 Class 8a Yadin et al. 1961, Pl. 249.26, 28  
 Class 8a Yadin et al. 1961, Pl. 249.27  
 Class 8b Ben Tor et al. 1997, Fig. II.54 (23)  
 Class 8e Ben Tor et al. 1997, Fig. III.35 (5-6)

- Class 10 Yadin et al. 1958, Pl. 51.27  
Class 10 Yadin et al. 1961, Pl. 250.17  
Class 12b Yadin et al. 1958, Pl. 52.30-33  
Class 12b Yadin et al. 1960, Pl. 74.5-9  
Class 12b Yadin et al. 1961, Pl. 250.16  
Class 12b Ben Tor et al. 1997, Figs III.35 (4); III.37 (6)  
Class 12c Yadin et al. 1960, Pl. 74.10  
Class 12c Yadin et al. 1961, Pl. 186.2-4, 7  
Class 14 Yadin et al. 1961, Pl. 249.19-20  
Class 15 Yadin et al. 1961, Pl. 250.18-19  
Class 16a Yadin et al. 1961, Pl. 186.2, 5  
Class 16b Yadin et al. 1960, Pl. 71.11, 17  
Class 16b Yadin et al. 1961, Pl. 186.3-4, 6-7  
Class 16b Ben Tor et al. 1997, Fig. II.55 (4)  
Class 17 Yadin et al. 1960, Pl. 71.14  
Class 19 Yadin et al. 1961, Pl. 186.14  
Class 22 Yadin et al. 1960, Pl. 71.5-6  
Class 22 Yadin et al. 1961, Pl. 216.15  
Class 22 Yadin et al. 1961, Pl. 250.8  
Class 24a Yadin et al. 1961, Pl. 186.15, 18  
Class 24a Yadin et al. 1960, Pl. 73.4  
Class 24b Yadin et al. 1960, Pls 72.1-9; 73.1-3, 5-16  
Class 24b Yadin et al. 1961, Pl. 186.11-12  
Class 24b Ben Tor et al. 1997, Fig. II.55 (5)  
Class 24b Ben Tor et al. 1997, Fig. III.37 (11)  
Class 24b Ben Tor et al. 1997, Fig. III.40 (5)  
Class 29 Yadin et al. 1960, Pl. 71.7  
Class 29 Ben Tor et al. 1997, Fig. III.39 (28)  
Class 30 Yadin et al. 1961, Pl. 219.22  
Class 39 Yadin et al. 1961, Pl. 184.3  
Class 40b Yadin et al. 1960, Pl. 68.8  
Class 44 Ben Tor et al. 1997, Fig. II.54 (33)  
Class 44 Ben Tor et al. 1997, Fig. III.39 (27)  
Class 48b Yadin et al. 1958, Pl. 52.5  
Class 48b Yadin et al. 1960, Pl. 68.5-6  
Class 48b Yadin et al. 1961, Pl. 183.9  
Class 48b Yadin et al. 1961, Pl. 186.1  
Class 48b Yadin et al. 1961, Pl. 219.15  
Class 49 Yadin et al. 1960, Pl. 68.4  
Class 49 Yadin et al. 1961, Pl. 183.13  
Class 54 Yadin et al. 1958, Pl. 51.31-32  
Class 54 Yadin et al. 1958, Pl. 52.2  
Class 54 Yadin et al. 1960, Pl. 67.10-13  
Class 54 Yadin et al. 1960, Pl. 68.1-2  
Class 54 Yadin et al. 1961, Pl. 183.1-7, 14-16  
Class 54 Yadin et al. 1961, Pl. 219.16  
Class 54 Yadin et al. 1961, Pl. 249.21  
Class 56 Yadin et al. 1960, Pl. 68.7  
Class 57b Yadin et al. 1960, Pl. 74.1  
Class 67 Yadin et al. 1960, Pl. 74.3-4  
Class 67 Yadin et al. 1961, Pl. 185.11  
Class 70 Yadin et al. 1961, Pl. 185.1-2  
Class 71a Yadin et al. 1961, Pl. 250.1  
Class 71b Yadin et al. 1960, Pl. 70.16  
Class 71b Yadin et al. 1961, Pl. 250.4  
Class 73 Yadin et al. 1960, Pl. 70.15  
Class 77 Yadin et al. 1961, Pl. 186.1  
Class 82e Yadin et al. 1958, Pl. 52.13  
Class 82e Yadin et al. 1961, Pl. 185.5  
Class 84 Ben Tor et al. 1997, Fig. II.54 (31)  
Class 84 Ben Tor et al. 1997, Fig. III.39 (26)  
Class 85a Yadin et al. 1958, Pl. 52.22  
Class 85a Yadin et al. 1960, Pl. 70.25  
Class 85b Ben Tor et al. 1997, Fig. III.37 (4)  
Class 87 Yadin et al. 1961, Pl. 219.20  
Class 90a Yadin et al. 1958, Pl. 52.23  
Class 91 Yadin et al. 1960, Pl. 70.19-21  
Class 91 Yadin et al. 1960, Pl. 219.20  
Class 91 Yadin et al. 1961, Pl. 185.4  
Class 97 Yadin et al. 1960, Pl. 70.17  
Class 97 Yadin et al. 1961, Pl. 185.7  
Class 100b Yadin et al. 1958, Pl. 52.14-15  
Class 100b Yadin et al. 1960, Pl. 70.1-3, 8, 10  
Class 100b Yadin et al. 1961, Pl. 184.17-22  
Class 100b Yadin et al. 1961, Pl. 215.13  
Class 100b Yadin et al. 1961, Pl. 220.24-27  
Class 100b Ben Tor et al. 1997, Fig. III.41 (18)  
Class 100c Yadin et al. 1960, Pl. 70.4, 7, 9  
Class 102b Yadin et al. 1958, Pl. 52.25  
Class 102b Yadin et al. 1960, Pl. 70.26-27  
Class 102b Yadin et al. 1961, Pl. 219.29  
Class 102b Yadin et al. 1961, Pl. 220.32  
Class 103b Yadin et al. 1958, Pl. 52.24  
Class 105 Yadin et al. 1961, Pl. 184.16  
Class 105 Yadin et al. 1961, Pl. 220.30  
Class 106 Yadin et al. 1958, Pl. 52.20  
Class 126 Yadin et al. 1958, Pl. 51.30  
Class 126 Yadin et al. 1961, Pl. 182.22  
Class 126 Yadin et al. 1961, Pl. 219.12-13  
Class 134a Yadin et al. 1958, Pl. 51.6  
Class 134a Yadin et al. 1961, Pl. 181.40, 42  
Class 134b Yadin et al. 1958, Pl. 51.25-26  
Class 134b Yadin et al. 1960, Pl. 66.32-33  
Class 134b Yadin et al. 1961, Pl. 219.2  
Class 134c Yadin et al. 1961, Pl. 219.11  
Class 134d Yadin et al. 1958, Pl. 51.4  
Class 134d Yadin et al. 1960, Pl. 66.15, 28  
Class 134d Yadin et al. 1961, Pl. 249.11-12  
Class 134e Yadin et al. 1958, Pl. 51.20  
Class 134e Yadin et al. 1961, Pl. 181.11  
Class 134e Yadin et al. 1961, Pl. 214.28  
Class 139 Yadin et al. 1958, Pl. 51.19, 21-22  
Class 139 Yadin et al. 1960, Pl. 67.1-2, 7  
Class 139 Yadin et al. 1961, Pl. 219.10  
Class 139 Yadin et al. 1961, Pl. 249.14-15  
Class 139 Ben Tor et al. 1997, Fig. III.36 (4)  
Class 139 Ben Tor et al. 1997, Fig. III.38 (4)  
Class 140 Yadin et al. 1960, Pl. 66.26  
Class 140 Yadin et al. 1961, Pl. 182.12, 14  
Class 140 Ben Tor et al. 1997, Fig. III.37 (3)  
Class 141a Yadin et al. 1961, Pl. 249.9  
Class 141a Ben Tor et al. 1997, Figs III.36 (3); III.37 (2)  
Class 141c Yadin et al. 1958, Pl. 51.17  
Class 141c Yadin et al. 1960, Pl. 66.21, 29-31  
Class 141c Yadin et al. 1961, Pl. 182.5, 7  
Class 141c Ben Tor et al. 1997, Fig. III.36 (6)  
Class 141c Ben Tor et al. 1997, Fig. III.37 (5)

- Class 141c Ben Tor et al. 1997, Fig. III.38 (6-7)
- Class 141d Yadin et al. 1958, Pl. 51.16
- Class 141d Yadin et al. 1960, Pl. 66.23
- Class 141d Yadin et al. 1961, Pl. 182.1, 9
- Class 141d Ben Tor et al. 1997, Fig. III.41 (6)
- Class 143 Yadin et al. 1961, Pl. 220.15
- Class 143 Ben Tor et al. 1997, Fig. III.36 (2)
- Class 144b Yadin et al. 1961, Pl. 181.13
- Class 144b Yadin et al. 1961, Pl. 182.19
- Class 144b Ben Tor et al. 1997, Fig. II.54 (12)
- Class 152 Yadin et al. 1958, Pl. 51.1
- Class 152 Yadin et al. 1960, Pl. 66.4-6, 12
- Class 152 Yadin et al. 1961, Pl. 181.1-5, 11
- Class 152 Yadin et al. 1961, Pl. 214.12
- Class 152 Yadin et al. 1961, Pl. 219.1
- Class 152 Yadin et al. 1961, Pl. 220.12
- Class 152 Yadin et al. 1961, Pl. 249.1-2
- Class 152 Ben Tor et al. 1997, Fig. II.54 (6)
- Class 152 Ben Tor et al. 1997, Fig. III.38 (2)
- Class 152 Ben Tor et al. 1997, Fig. III.41 (2)
- Class 153 Yadin et al. 1961, Pl. 181.21
- Class 153 Yadin et al. 1961, Pl. 219.3
- Class 157 Yadin et al. 1960, Pl. 67.3
- Class 157 Yadin et al. 1961, Pl. 181.17-19
- Class 157 Ben Tor et al. 1997, Fig. II.54 (18)
- Class 158a Yadin et al. 1961, Pl. 181.7
- Class 160a Yadin et al. 1960, Pl. 66.11
- Class 160a Yadin et al. 1960, Pl. 67.4
- Class 160a Yadin et al. 1961, Pl. 219.5
- Class 160a Ben Tor et al. 1997, Fig. III.35 (16)
- Class 162 Yadin et al. 1958, Pl. 51.28
- Class 162 Yadin et al. 1961, Pl. 214.21
- Class 162 Yadin et al. 1961, Pl. 220.7, 9-10
- Class 163 Yadin et al. 1961, Pl. 182.18
- Class 164 Yadin et al. 1961, Pl. 181.24, 39
- Class 167 Yadin et al. 1958, Pl. 51.29
- Class 167 Yadin et al. 1960, Pl. 67.10
- Class 167 Yadin et al. 1961, Pl. 182.20
- Class 168 Yadin et al. 1960, Pl. 66.16
- Class 168 Yadin et al. 1961, Pl. 181.38
- Class 168 Yadin et al. 1961, Pl. 219.6
- Class 169 Yadin et al. 1958, Pl. 51.13
- Class 169 Yadin et al. 1960, Pl. 66.18-19
- Class 169 Yadin et al. 1961, Pl. 181.25
- Class 169 Yadin et al. 1961, Pl. 220.3-4
- Class 172 Yadin et al. 1958, Pl. 51.5
- Class 172 Yadin et al. 1961, Pl. 181.14-15
- Class 173a Yadin et al. 1958, Pl. 51.15
- Class 175 Yadin et al. 1961, Pl. 220.6
- Class 176 Yadin et al. 1958, Pl. 51.14
- Class 176 Yadin et al. 1961, Pl. 249.6
- Class 179 Yadin et al. 1958, Pl. 51.12
- Class 179 Yadin et al. 1961, Pl. 181.20-22, 27-30, 32-34, 36
- Class 179 Ben Tor et al. 1997, Fig. III.36 (5)
- Class 181 Yadin et al. 1960, Pl. 67.6
- Class 181 Yadin et al. 1961, Pl. 181.23
- Class 181 Yadin et al. 1961, Pl. 220.5
- Class 181 Yadin et al. 1961, Pl. 249.5
- Class 182a Ben Tor et al. 1997, Fig. III.35 (3)
- Class 182c Yadin et al. 1961, Pl. 249.4
- Class 183 Ben Tor et al. 1997, Fig. III.35 (12)
- Class 184 Yadin et al. 1958, Pl. 51.2
- Class 184 Yadin et al. 1960, Pl. 67.5
- Class 184 Yadin et al. 1961, Pl. 249.3
- Class 184 Ben Tor et al. 1997, Fig. III.35 (2)
- Stratum VII**
- Class 4d Ben Tor et al. 1997, Fig. III.30 (26)
- Class 5 Yadin et al. 1960, Pl. 64.8, 11
- Class 5 Ben Tor et al. 1997, Fig. III.32 (23)
- Class 7a Yadin et al. 1958, Pl. 50.6-7, 9
- Class 7a Yadin et al. 1960, Pl. 64.10, 12
- Class 7a Yadin et al. 1961, Pl. 180.11-12
- Class 7a Yadin et al. 1961, Pl. 215.7
- Class 7a Yadin et al. 1961, Pl. 218.8
- Class 7a Yadin et al. 1961, Pl. 248.5-9, 11
- Class 7a Ben Tor et al. 1997, Fig. III.31 (10)
- Class 7a Ben Tor et al. 1997, Fig. III.33 (8)
- Class 7a Ben Tor et al. 1997, Fig. III.34 (18-19)
- Class 7b Ben Tor et al. 1997, Fig. III.31 (11)
- Class 8a Yadin et al. 1960, Pl. 64.7, 9, 14
- Class 8a Ben Tor et al. 1997, Fig. III.30 (24)
- Class 8a Ben Tor et al. 1997, Fig. III.32 (24-26)
- Class 8b Yadin et al. 1961, Pl. 215.11
- Class 8c Yadin et al. 1961, Pl. 180.10
- Class 8e Ben Tor et al. 1997, Fig. III.30 (22-23)
- Class 10 Ben Tor et al. 1997, Fig. III.30 (27-28)
- Class 11b Yadin et al. 1958, Pl. 50.40
- Class 12b Yadin et al. 1958, Pl. 50.37-39
- Class 12b Yadin et al. 1960, Pl. 65.11-12, 14
- Class 12b Ben Tor et al. 1997, Fig. III.32 (17)
- Class 12c Yadin et al. 1960, Pl. 65.10, 13
- Class 12c Yadin et al. 1961, Pl. 216.10-11
- Class 12d Yadin et al. 1961, Pl. 248.22
- Class 14 Yadin et al. 1958, Pl. 49.31
- Class 14 Yadin et al. 1961, Pl. 180.13
- Class 14 Ben Tor et al. 1997, Fig. III.32 (14)
- Class 15 Yadin et al. 1961, Pl. 218.9
- Class 15 Yadin et al. 1961, Pl. 248.24
- Class 16b Yadin et al. 1960, Pl. 65.4
- Class 16b Yadin et al. 1961, Pl. 218.3, 6
- Class 18 Yadin et al. 1961, Pl. 216.6-7
- Class 23 Yadin et al. 1961, Pl. 218.1
- Class 24a Yadin et al. 1961, Pl. 180.19
- Class 24b Yadin et al. 1961, Pl. 180.20
- Class 24b Yadin et al. 1961, Pl. 216.9
- Class 40a Yadin et al. 1958, Pl. 50.3
- Class 42 Ben Tor et al. 1997, Fig. III.33 (22)
- Class 48b Yadin et al. 1961, Pl. 215.6
- Class 48b Yadin et al. 1961, Pl. 247.23, 26
- Class 54 Yadin et al. 1958, Pl. 49.32-33
- Class 54 Yadin et al. 1960, Pl. 64.1, 3
- Class 54 Yadin et al. 1961, Pl. 247.24-25
- Class 56 Yadin et al. 1960, Pl. 64.2, 4, 6
- Class 56 Yadin et al. 1961, Pl. 215.5

- Class 57b Ben Tor et al. 1997, Fig. III.30 (30)  
Class 64 Yadin et al. 1960, Pl. 65.8-9  
Class 64 Yadin et al. 1961, Pl. 218.10, 13-14  
Class 67 Yadin et al. 1961, Pl. 215.23  
Class 73 Yadin et al. 1958, Pl. 50.20  
Class 82a Yadin et al. 1958, Pl. 50.16  
Class 82d Yadin et al. 1960, Pl. 64.19  
Class 84 Yadin et al. 1958, Pl. 50.14  
Class 85a Yadin et al. 1961, Pl. 248.16  
Class 85b Yadin et al. 1958, Pl. 50.15  
Class 86 Yadin et al. 1958, Pl. 50.23  
Class 87 Yadin et al. 1960, Pl. 64.22  
Class 87 Yadin et al. 1961, Pl. 215.14  
Class 88 Yadin et al. 1960, Pl. 64.20-21, 23  
Class 100b Yadin et al. 1958, Pl. 50.10-12  
Class 100b Yadin et al. 1960, Pl. 64.17  
Class 100b Yadin et al. 1961, Pl. 180.15-17  
Class 100b Yadin et al. 1961, Pl. 248.12  
Class 100b Ben Tor et al. 1997, Fig. III.30 (4)  
Class 100b Ben Tor et al. 1997, Fig. III.33 (13)  
Class 100c Yadin et al. 1961, Pl. 248.14  
Class 100c Ben Tor et al. 1997, Fig. III.33 (12)  
Class 100d Yadin et al. 1958, Pl. 50.13  
Class 102a Yadin et al. 1960, Pl. 65.3  
Class 108 Yadin et al. 1960, Pl. 63.34  
Class 134a Yadin et al. 1958, Pl. 49.12-13  
Class 134a Yadin et al. 1960, Pl. 63.6  
Class 134a Ben Tor et al. 1997, Fig. III.30 (14)  
Class 134b Yadin et al. 1958, Pl. 49.6-8  
Class 134b Yadin et al. 1960, Pl. 63.4  
Class 134b Ben Tor et al. 1997, Fig. III.30 (13)  
Class 134b Ben Tor et al. 1997, Fig. III.32 (7-9)  
Class 134d Yadin et al. 1958, Pl. 49.16  
Class 134d Yadin et al. 1960, Pl. 63.16, 18  
Class 134d Ben Tor et al. 1997, Fig. III.33 (7)  
Class 134e Yadin et al. 1960, Pl. 63.15, 17, 24  
Class 134e Ben Tor et al. 1997, Fig. III.32 (4)  
Class 139 Yadin et al. 1958, Pl. 49.15  
Class 139 Yadin et al. 1960, Pl. 63.21, 23  
Class 139 Yadin et al. 1961, Pl. 214.32  
Class 141a Yadin et al. 1961, Pl. 180.7  
Class 141a Yadin et al. 1961, Pl. 247.8  
Class 141c Yadin et al. 1958, Pl. 49.14  
Class 141c Yadin et al. 1961, Pl. 180.5  
Class 141c Ben Tor et al. 1997, Fig. III.33 (9-10, 18)  
Class 141d Yadin et al. 1960, Pl. 63.13  
Class 141d Yadin et al. 1961, Pl. 214.23  
Class 144b Yadin et al. 1960, Pl. 63.3, 5  
Class 144b Yadin et al. 1961, Pl. 214.13-14  
Class 148 Yadin et al. 1958, Pl. 49.28  
Class 148 Yadin et al. 1960, Pl. 63.11, 32  
Class 152 Yadin et al. 1958, Pl. 49.24  
Class 152 Yadin et al. 1960, Pl. 63.1-2, 29  
Class 152 Ben Tor et al. 1997, Fig. III.30 (1)  
Class 152 Ben Tor et al. 1997, Fig. III.32 (6)  
Class 152 Ben Tor et al. 1997, Fig. III.33 (16)  
Class 155 Yadin et al. 1958, Pl. 49.23  
Class 157 Yadin et al. 1958, Pl. 49.9  
Class 157 Yadin et al. 1960, Pl. 63.8, 26, 31  
Class 157 Yadin et al. 1961, Pl. 214.18  
Class 160a Yadin et al. 1960, Pl. 63.25  
Class 160a Yadin et al. 1961, Pl. 180.9  
Class 160a Yadin et al. 1961, Pl. 214.19-20  
Class 162 Yadin et al. 1960, Pl. 63.20  
Class 163 Ben Tor et al. 1997, Fig. III.30 (17)  
Class 164 Ben Tor et al. 1997, Fig. III.30 (16)  
Class 168 Yadin et al. 1961, Pl. 180.4, 6  
Class 169 Yadin et al. 1960, Pl. 63.19  
Class 169 Yadin et al. 1961, Pl. 214.3, 29-30  
Class 170 Ben Tor et al. 1997, Fig. III.30 (12)  
Class 171 Ben Tor et al. 1997, Fig. III.32 (2)  
Class 172 Yadin et al. 1958, Pl. 49.25  
Class 172 Yadin et al. 1960, Pl. 63.33  
Class 173a Yadin et al. 1960, Pl. 63.7  
Class 174 Yadin et al. 1961, Pl. 214.15, 17  
Class 174 Ben Tor et al. 1997, Fig. III.32 (1)  
Class 174 Ben Tor et al. 1997, Fig. III.33 (1)  
Class 178 Ben Tor et al. 1997, Fig. III.30 (8)  
Class 181 Yadin et al. 1961, Pl. 214.16  
Class 181 Ben Tor et al. 1997, Fig. III.30 (9, 11)  
Class 182b Yadin et al. 1958, Pl. 49.27  
Class 182c Ben Tor et al. 1997, Fig. III.30 (10)  
Class 184 Yadin et al. 1960, Pl. 63.27  
Class 184 Ben Tor et al. 1997, Fig. III.30 (18)
- Stratum VIII**
- Class 1a Ben Tor et al. 1997, Fig. III.24 (21)  
Class 4a Yadin et al. 1960, Pl. 59.1-2  
Class 4b Yadin et al. 1960, Pl. 57.24  
Class 4b Ben Tor et al. 1997, Fig. III.27 (15)  
Class 4d Yadin et al. 1960, Pl. 57.25  
Class 4d Yadin et al. 1960, Pl. 58.1-2  
Class 7a Yadin et al. 1961, Pl. 248.10  
Class 7a Ben Tor et al. 1997, Fig. III.27 (5, 7-9)  
Class 8a Yadin et al. 1960, Pl. 57.14, 17-21  
Class 8a Ben Tor et al. 1997, Fig. III.26 (5)  
Class 8b Yadin et al. 1960, Pl. 57.4, 7, 11  
Class 8d Ben Tor et al. 1997, Fig. III.24 (25)  
Class 8e Yadin et al. 1958, Pl. 48.1-3  
Class 8e Yadin et al. 1960, Pl. 57.6, 9-10, 12-13, 23  
Class 10 Yadin et al. 1958, Pl. 48.17-18  
Class 10 Yadin et al. 1960, Pl. 62.1-2  
Class 11b Yadin et al. 1960, Pl. 62.9-10  
Class 12a Ben Tor et al. 1997, Fig. III.24 (20)  
Class 12b Yadin et al. 1960, Pl. 61.18-21  
Class 12c Yadin et al. 1958, Pl. 48.16  
Class 12c Yadin et al. 1960, Pl. 61.16-17, 24-25  
Class 14 Yadin et al. 1960, Pl. 55.43-44  
Class 14 Ben Tor et al. 1997, Fig. III.25 (5)  
Class 15 Yadin et al. 1960, Pl. 62.5-8  
Class 16a Ben Tor et al. 1997, Fig. III.25 (10, 12-13)  
Class 16b Ben Tor et al. 1997, Figs III.25 (11); 27 (24)  
Class 16c Yadin et al. 1960, Pl. 59.7

- Class 17 Yadin et al. 1960, Pl. 60.1, 3-8  
 Class 19 Yadin et al. 1960, Pl. 59.4  
 Class 37b Yadin et al. 1958, Pl. 47.25, 27  
 Class 40a Yadin et al. 1960, Pl. 56.3  
 Class 54 Yadin et al. 1960, Pl. 56.7-14  
 Class 64 Yadin et al. 1960, Pl. 61.1-11  
 Class 73 Yadin et al. 1960, Pl. 58.13-14  
 Class 77 Ben Tor et al. 1997, Fig. III.25 (2)  
 Class 82a Yadin et al. 1960, Pl. 58.27  
 Class 82e Yadin et al. 1960, Pl. 58.25  
 Class 85b Yadin et al. 1960, Pl. 58.20, 23-24  
 Class 87 Yadin et al. 1960, Pl. 58.16  
 Class 88 Yadin et al. 1960, Pl. 58.18, 21  
 Class 100b Yadin et al. 1960, Pl. 58.5-9  
 Class 100b Yadin et al. 1961, Pl. 248.13  
 Class 100b Ben Tor et al. 1997, Fig. III.25 (1)  
 Class 100c Yadin et al. 1960, Pl. 58.3  
 Class 102b Yadin et al. 1960, Pl. 58.12  
 Class 126 Yadin et al. 1960, Pl. 54.20-22  
 Class 134a Yadin et al. 1958, Pl. 47.11  
 Class 134a Yadin et al. 1960, Pl. 53.15, 17, 35-36  
 Class 134a Yadin et al. 1960, Pl. 55.15, 22  
 Class 134b Yadin et al. 1960, Pl. 53.12, 14  
 Class 134b Yadin et al. 1960, Pl. 55.5  
 Class 134b Yadin et al. 1961, Pl. 213.26  
 Class 134b Ben Tor et al. 1997, Fig. III.24 (4)  
 Class 134d Yadin et al. 1958, Pl. 47.10, 20  
 Class 134d Yadin et al. 1960, Pl. 54.9, 12-14  
 Class 134d Yadin et al. 1961, Pl. 247.12-13  
 Class 134d Ben Tor et al. 1997, Fig. III.26 (1)  
 Class 134e Yadin et al. 1960, Pl. 54.6, 10-11  
 Class 139 Yadin et al. 1958, Pl. 47.13  
 Class 140 Yadin et al. 1960, Pl. 54.25  
 Class 141a Yadin et al. 1958, Pl. 47.19  
 Class 141a Yadin et al. 1960, Pl. 54.1, 5  
 Class 141d Yadin et al. 1958, Pl. 47.9  
 Class 141d Yadin et al. 1961, Pl. 247.7  
 Class 143 Ben Tor et al. 1997, Fig. III.26 (2)  
 Class 144b Yadin et al. 1960, Pl. 55.24-25  
 Class 144b Ben Tor et al. 1997, Fig. III.24 (9-10)  
 Class 152 Yadin et al. 1958, Pl. 47.1, 15-16  
 Class 152 Yadin et al. 1960, Pl. 53.1  
 Class 152 Yadin et al. 1960, Pl. 53.1, 7-11, 13, 16, 19-20  
 Class 152 Ben Tor et al. 1997, Fig. III.24 (7, 11)  
 Class 153 Yadin et al. 1960, Pl. 53.30-31  
 Class 155 Yadin et al. 1960, Pl. 55.1-3, 12  
 Class 157 Yadin et al. 1960, Pl. 53.21  
 Class 158a Yadin et al. 1960, Pl. 53.22  
 Class 160a Yadin et al. 1960, Pl. 53.23  
 Class 160a Ben Tor et al. 1997, Fig. III.24 (16)  
 Class 160b Yadin et al. 1958, Pl. 47.6  
 Class 160b Yadin et al. 1960, Pl. 53.34  
 Class 161 Yadin et al. 1960, Pl. 54.4  
 Class 162 Yadin et al. 1960, Pl. 53.24, 29  
 Class 164 Yadin et al. 1960, Pl. 53.32  
 Class 168 Yadin et al. 1961, Pl. 213.25  
 Class 169 Yadin et al. 1958, Pl. 47.7  
 Class 170 Yadin et al. 1960, Pl. 54.3  
 Class 171 Yadin et al. 1958, Pl. 47.5  
 Class 172 Yadin et al. 1960, Pl. 53.5, 13  
 Class 173a Yadin et al. 1958, Pl. 47.4  
 Class 173a Ben Tor et al. 1997, Fig. III.24 (15)  
 Class 179 Yadin et al. 1961, Pl. 213.28  
 Class 181 Yadin et al. 1958, Pl. 47.18  
 Class 181 Yadin et al. 1960, Pl. 55.29-30  
 Class 182b Yadin et al. 1958, Pl. 47.3  
 Class 182b Yadin et al. 1960, Pl. 55.6, 8-11, 28, 31  
 Class 182b Yadin et al. 1961, Pl. 247.2  
 Class 182c Yadin et al. 1960, Pl. 55.7  
 Class 182c Ben Tor et al. 1997, Fig. III.27 (1)  
 Class 184 Yadin et al. 1958, Pl. 47.12  
 Class 184 Yadin et al. 1960, Pl. 53.2-4  
 Class 184 Yadin et al. 1960, Pl. 54.18-19  
 Class 184 Ben Tor et al. 1997, Fig. III.27 (3)  
**Stratum IX**  
 Class 8a Yadin et al. 1960, Pl. 52.13  
 Class 8b Yadin et al. 1960, Pl. 52.14-15  
 Class 8b Yadin et al. 1961, Pl. 179.3-6  
 Class 8b Yadin et al. 1961, Pl. 209.1-2, 4, 9-12  
 Class 8c Yadin et al. 1961, Pl. 212.28-32  
 Class 8d Yadin et al. 1961, Pl. 212.25-27  
 Class 8e Yadin et al. 1961, Pl. 175.25-28  
 Class 8e Yadin et al. 1961, Pl. 209.3, 5-8  
 Class 10 Yadin et al. 1960, Pl. 52.26-27  
 Class 10 Yadin et al. 1961, Pl. 179.20-22  
 Class 12a Yadin et al. 1961, Pl. 213.14  
 Class 12b Yadin et al. 1961, Pl. 176.14-15  
 Class 12b Yadin et al. 1961, Pl. 178.19  
 Class 12b Yadin et al. 1961, Pl. 179.17  
 Class 12c Yadin et al. 1960, Pl. 52.25  
 Class 12c Yadin et al. 1961, Pl. 179.18-19  
 Class 12c Yadin et al. 1961, Pl. 208.46-47  
 Class 13 Yadin et al. 1961, Pl. 176.16-17  
 Class 14 Yadin et al. 1961, Pl. 208.34  
 Class 16c Yadin et al. 1961, Pl. 209.13-14  
 Class 17 Yadin et al. 1961, Pl. 179.16  
 Class 73 Yadin et al. 1961, Pl. 176.2-3  
 Class 73 Yadin et al. 1961, Pl. 208.41  
 Class 78 Yadin et al. 1961, Pl. 176.6  
 Class 82a Yadin et al. 1961, Pl. 176.5  
 Class 82c Yadin et al. 1961, Pl. 208.37  
 Class 84 Yadin et al. 1960, Pl. 52.17  
 Class 100b Yadin et al. 1961, Pl. 179.7-8  
 Class 100b Yadin et al. 1961, Pl. 208.36  
 Class 102b Yadin et al. 1961, Pl. 208.39  
 Class 105 Yadin et al. 1961, Pl. 179.9  
 Class 126 Yadin et al. 1961, Pl. 175.13  
 Class 134a Yadin et al. 1961, Pl. 208.9  
 Class 134a Yadin et al. 1961, Pl. 212.20  
 Class 134d Yadin et al. 1960, Pl. 52.7  
 Class 134d Yadin et al. 1961, Pl. 178.12  
 Class 134e Yadin et al. 1960, Pl. 52.2  
 Class 134e Yadin et al. 1961, Pl. 178.17  
 Class 141a Yadin et al. 1960, Pl. 52.5-6  
 Class 141c Yadin et al. 1961, Pl. 175.10

Class 141c Yadin et al. 1961, Pl. 178.33  
 Class 141d Yadin et al. 1961, Pl. 178.20-21  
 Class 143 Yadin et al. 1961, Pl. 208.31  
 Class 144b Yadin et al. 1961, Pl. 175.3, 15  
 Class 152 Yadin et al. 1960, Pl. 52.1  
 Class 152 Yadin et al. 1961, Pl. 208.27  
 Class 153 Yadin et al. 1961, Pl. 212.1-2  
 Class 155 Yadin et al. 1961, Pl. 178.1, 24-29  
 Class 155 Yadin et al. 1961, Pl. 212.7  
 Class 158a Yadin et al. 1961, Pl. 208.12  
 Class 160a Yadin et al. 1961, Pl. 175.7  
 Class 160a Yadin et al. 1961, Pl. 208.3, 11  
 Class 160b Yadin et al. 1961, Pl. 178.39  
 Class 161 Yadin et al. 1961, Pl. 175.20  
 Class 161 Yadin et al. 1961, Pl. 178.10  
 Class 161 Yadin et al. 1961, Pl. 208.18, 22  
 Class 162 Yadin et al. 1961, Pl. 175.6, 12, 19  
 Class 162 Yadin et al. 1961, Pl. 208.13-16, 19  
 Class 170 Yadin et al. 1961, Pl. 208.6, 21  
 Class 172 Yadin et al. 1961, Pl. 175.1  
 Class 172 Yadin et al. 1961, Pl. 178.2  
 Class 172 Yadin et al. 1961, Pl. 208.1-2, 4, 28  
 Class 172 Yadin et al. 1961, Pl. 212.5-6  
 Class 173a Yadin et al. 1961, Pl. 212.9-10  
 Class 174 Yadin et al. 1961, Pl. 208.32  
 Class 175 Yadin et al. 1961, Pl. 212.11-12  
 Class 179 Yadin et al. 1961, Pl. 208.29, 33  
 Class 181 Yadin et al. 1961, Pl. 175.11  
 Class 181 Yadin et al. 1961, Pl. 178.15  
 Class 182a Yadin et al. 1961, Pl. 175.9  
 Class 184 Yadin et al. 1960, Pl. 52.8  
 Class 184 Yadin et al. 1961, Pl. 175.14  
 Class 184 Yadin et al. 1961, Pl. 178.23, 25, 31  
 Class 188 Yadin et al. 1961, Pl. 175.18

#### **Stratum IX/X**

Class 4b Unpublished  
 Class 5 Yadin et al. 1958, Pl. 45.21  
 Class 5 Yadin et al. 1961, Pl. 210.12, 14, 16,  
 18  
 Class 6 Unpublished  
 Class 7b Unpublished  
 Class 8b Yadin et al. 1961, Pl. 164.7  
 Class 8b Unpublished  
 Class 8c Unpublished  
 Class 8e Yadin et al. 1958, Pl. 45.18-20, 22  
 Class 8e Yadin et al. 1961, Pl. 210.11, 13, 15,  
 17, 19-22  
 Class 10 Yadin et al. 1958, Pl. 46.15-16  
 Class 10 Yadin et al. 1961, Pl. 211.16  
 Class 12b Yadin et al. 1958, Pl. 46.11-13  
 Class 12b Yadin et al. 1961, Pl. 211.15  
 Class 12c Yadin et al. 1961, Pl. 177.17-18  
 Class 13 Yadin et al. 1961, Pl. 177.19-21  
 Class 14 Yadin et al. 1961, Pl. 210.9  
 Class 16b Unpublished  
 Class 16c Yadin et al. 1961, Pl. 211.1-4  
 Class 19 Yadin et al. 1960, Pl. 52.21  
 Class 20 Unpublished  
 Class 39 Unpublished  
 Class 48b Unpublished

Class 54 Unpublished  
 Class 56 Unpublished  
 Class 64 Unpublished  
 Class 77 Unpublished  
 Class 80 Unpublished  
 Class 82a Unpublished  
 Class 82b Yadin et al. 1961, Pl. 177.15-16  
 Class 82c Unpublished  
 Class 84 Yadin et al. 1958, Pl. 46.1  
 Class 84 Yadin et al. 1961, Pl. 177.14  
 Class 84 Unpublished  
 Class 85b Unpublished  
 Class 100b Yadin et al. 1961, Pl. 210.23-24  
 Class 100b Unpublished  
 Class 100c Yadin et al. 1960, Pl. 51.14  
 Class 100c Unpublished  
 Class 100d Yadin et al. 1961, Pl. 164.8, 10  
 Class 100d Unpublished  
 Class 102a Yadin et al. 1961, Pl. 177.13  
 Class 107a Unpublished  
 Class 126 Unpublished  
 Class 134a Yadin et al. 1958, Pl. 45.15-16  
 Class 134a Yadin et al. 1961, Pl. 177.10  
 Class 134b Yadin et al. 1961, Pl. 177.12  
 Class 134d Unpublished  
 Class 134e Yadin et al. 1958, Pl. 45.17  
 Class 134e Unpublished  
 Class 141c Unpublished  
 Class 143 Unpublished  
 Class 152 Yadin et al. 1958, Pl. 45.14  
 Class 152 Yadin et al. 1961, Pl. 177.1  
 Class 152 Unpublished  
 Class 153 Yadin et al. 1961, Pl. 177.5  
 Class 153 Unpublished  
 Class 155 Yadin et al. 1958, Pl. 45.1  
 Class 157 Unpublished  
 Class 160a Yadin et al. 1961, Pl. 164.4  
 Class 160a Yadin et al. 1961, Pl. 177.4  
 Class 160a Unpublished  
 Class 160b Yadin et al. 1958, Pl. 45.8  
 Class 161 Yadin et al. 1961, Pl. 164.3  
 Class 161 Yadin et al. 1961, Pl. 210.4  
 Class 161 Unpublished  
 Class 162 Yadin et al. 1961, Pl. 210.1, 3  
 Class 162 Unpublished  
 Class 170 Yadin et al. 1958, Pl. 45.7  
 Class 170 Yadin et al. 1961, Pl. 177.11  
 Class 170 Yadin et al. 1961, Pl. 210.2  
 Class 172 Unpublished  
 Class 173a Yadin et al. 1958, Pl. 45.4-5  
 Class 173a Yadin et al. 1961, Pl. 210.6  
 Class 173a Yadin et al. 1961, Pl. 212.9-10  
 Class 173a Unpublished  
 Class 174 Yadin et al. 1958, Pl. 45.6  
 Class 176 Yadin et al. 1958, Pl. 45.9  
 Class 182b Unpublished  
 Class 184 Yadin et al. 1958, Pl. 45.12  
 Class 184 Yadin et al. 1961, Pl. 177.3  
 Class 184 Yadin et al. 1961, Pl. 210.5  
 Class 184 Unpublished

## **Stratum X**

- Class 8a Yadin et al. 1961, Pl. 171.23-24, 26-27  
Class 8a Ben Tor et al. 1997, Fig. III.22 (7)  
Class 8b Yadin et al. 1960, Pl. 51.11-13  
Class 8b Yadin et al. 1961, Pl. 207.9-17  
Class 8b Ben Tor et al. 1997, Fig. III.23 (7-10)  
Class 8b Ben Tor et al. 1997, Fig. III.21 (3-18)  
Class 8e Yadin et al. 1961, Pl. 171.20-22  
Class 8e Yadin et al. 1961, Pl. 174.10-11  
Class 10 Yadin et al. 1961, Pl. 207.27  
Class 12c Yadin et al. 1961, Pl. 174.18  
Class 14 Yadin et al. 1961, Pl. 171.16-17  
Class 18 Yadin et al. 1961, Pl. 172.10-14  
Class 40a Yadin et al. 1961, Pl. 207.6  
Class 64 Yadin et al. 1961, Pl. 207.26  
Class 73 Yadin et al. 1961, Pl. 172.2  
Class 73 Yadin et al. 1961, Pl. 207.18  
Class 84 Yadin et al. 1961, Pl. 172.1  
Class 103a Ben Tor et al. 1997, Fig. III.21 (21)  
Class 128 Yadin et al. 1961, Pl. 207.22  
Class 134b Yadin et al. 1960, Pl. 51.1  
Class 134b Yadin et al. 1961, Pl. 171.4, 6  
Class 134d Yadin et al. 1961, Pl. 171.11  
Class 134e Yadin et al. 1961, Pl. 207.3-4  
Class 143 Ben Tor et al. 1997, Fig. III.22 (1)  
Class 144b Yadin et al. 1960, Pl. 51.8  
Class 152 Yadin et al. 1961, Pl. 174.3  
Class 157 Yadin et al. 1960, Pl. 51.3  
Class 157 Yadin et al. 1961, Pl. 171.2  
Class 161 Yadin et al. 1960, Pl. 51.2  
Class 161 Ben Tor et al. 1997, Fig. III.23 (4)  
Class 162 Yadin et al. 1960, Pl. 51.5, 7  
Class 162 Yadin et al. 1961, Pl. 174.1-2  
Class 175 Ben Tor et al. 1997, Fig. III.23 (3)  
Class 184 Yadin et al. 1961, Pl. 171.15
- ## **Stratum XI**
- Class 8b Yadin et al. 1961, Pl. 203.8-9  
Class 8c Yadin et al. 1961, Pl. 203.7, 10  
Class 8c Ben Tor et al. 1997, Fig. III.19 (2-3)  
Class 8e Yadin et al. 1961, Pl. 203.12  
Class 12a Yadin et al. 1961, Pl. 203.20-21  
Class 22 Yadin et al. 1961, Pl. 203.16  
Class 60 Yadin et al. 1961, Pl. 203.15  
Class 71b Yadin et al. 1961, Pl. 205.1  
Class 73 Yadin et al. 1961, Pl. 203.18  
Class 102b Yadin et al. 1961, Pl. 203.19  
Class 102b Ben Tor et al. 1997, Fig. III.19 (4)  
Class 126 Yadin et al. 1961, Pl. 203.6  
Class 134a Yadin et al. 1961, Pl. 203.3  
Class 162 Yadin et al. 1961, Pl. 203.1  
Class 176 Yadin et al. 1961, Pl. 203.4-5
- ## **Stratum XII**
- Class 8b Yadin et al. 1961, Pl. 165.14, 17

- Class 8b Yadin et al. 1961, Pl. 201.11-17  
Class 8c Yadin et al. 1961, Pl. 165.2, 5, 8, 10, 13  
Class 8c Yadin et al. 1961, Pl. 170.13  
Class 8c Ben Tor et al. 1997, Fig. III.18 (3)  
Class 8d Yadin et al. 1961, Pl. 166.4, 6, 8  
Class 8e Yadin et al. 1961, Pl. 166.2-3,  
Class 8e Yadin et al. 1961, Pl. 170.7-10  
Class 12a Yadin et al. 1961, Pl. 170.21  
Class 12c Yadin et al. 1961, Pl. 169.7  
Class 16a Yadin et al. 1961, Pl. 202.7-9  
Class 22 Yadin et al. 1961, Pl. 169.1-2  
Class 31 Yadin et al. 1961, Pl. 167.8, 10  
Class 56 Yadin et al. 1961, Pl. 201.9  
Class 66 Yadin et al. 1961, Pl. 201.24  
Class 73 Yadin et al. 1961, Pl. 166.10-12  
Class 73 Yadin et al. 1961, Pl. 201.20-21  
Class 80 Yadin et al. 1961, Pl. 202.1-2  
Class 102a Yadin et al. 1961, Pl. 166.13  
Class 102b Yadin et al. 1961, Pl. 202.3  
Class 103a Yadin et al. 1961, Pl. 201.28  
Class 103a Ben Tor et al. 1997, Fig. III.20 (8)  
Class 103b Yadin et al. 1961, Pl. 201.26-27  
Class 116 Yadin et al. 1961, Pl. 201.25  
Class 133 Yadin et al. 1961, Pl. 202.18  
Class 134a Yadin et al. 1961, Pl. 164.11-18  
Class 134a Yadin et al. 1961, Pl. 201.1, 3-5, 7  
Class 162 Yadin et al. 1961, Pl. 164.22  
Class 172 Yadin et al. 1961, Pl. 146.12-13, 15-18  
Class 184 Yadin et al. 1961, Pl. 164.19  
Class 188 Yadin et al. 1961, Pl. 201.6

## **Iron I**

- Class 6 Ben Tor et al. 1997, Fig. II.36 (11)  
Class 8c Ben Ami 2001, Fig. 6.2-4, 10-13  
Class 8d Ben Tor et al. 1997, Fig. II.34 (23-24)  
Class 8d Ben Ami 2001, Fig. 6.1, 5-9  
Class 13 Ben Tor et al. 1997, Fig. II.34 (5)  
Class 16b Ben Ami 2001, Fig. 8.16  
Class 34 Ben Ami 2001, Fig. 7.12-13  
Class 40a Ben Ami 2001, Fig. 5.18  
Class 56 Ben Tor et al. 1997, Fig. II.34 (14)  
Class 102b Yadin et al. 1961, Pl. 196.25  
Class 103a Ben Tor et al. 1997, Fig. III.20 (8)  
Class 131a Ben Tor et al. 1997, Fig. II.36 (4-7)  
Class 134a Ben Ami 2001, Fig. 5.8, 10-11, 13-16  
Class 152 Ben Ami 2001, Fig. 5.1  
Class 161 Ben Ami 2001, Fig. 5.6  
Class 167 Ben Tor et al. 1997, Fig. II.34 (4)  
Class 170 Ben Ami 2001, Fig. 5.5  
Class 174 Ben Ami 2001, Fig. 5.3  
Class 188 Ben Ami 2001, Fig. 5.7, 12

## **C.18 Jerablus**

### **Unstratified**

- Class 33 Woolley 1921a, Fig. 53 right  
Class 115 Woolley 1921a, Pl. 20.d8

- Class 119 Woolley 1921a, Pl. 20.d1, 3  
Class 120 Woolley 1921a, Pl. 20.d6  
Class 121a Woolley 1921a, Pl. 20.d4



Class 121a Woolley 1921a, Pl. 20.d5  
 Class 121a Woolley 1921a, Pl. 20.d7  
 Class 121a Woolley 1921a, Pl. 20.d9  
 Class 128 Woolley 1921a, Pl. 20.c2  
 Class 157 Woolley 1921a, Pl. 20.c1  
**Yunus cem.**  
 Class 1c Woolley 1939b, Pl. 15.a.4  
 Class 4b Woolley 1939b, Pl. 25.M1  
 Class 37b Woolley 1939b, Pl. 25.Bath D  
 Class 38b Woolley 1939b, Pl. 22.K7-K10  
 Class 39 Woolley 1939b, Pl. 14.d  
 Class 39 Woolley 1939b, Pl. 22.K1, K18  
 Class 40b Woolley 1939b, Pl. 22.K15  
 Class 42 Woolley 1939b, Pl. 22.K4  
 Class 50 Woolley 1939b, Pl. 9.1, 4-6  
 Class 50 Woolley 1939b, Pls 10.1-2; 13.1-8  
 Class 50 Woolley 1939b, Pl. 22.K3  
 Class 52 Woolley 1939b, Pls 9.2-3; 10.3-4  
 Class 52 Woolley 1939b, Pl. 22.K2  
 Class 53b Woolley 1939b, Pl. 25.M6  
 Class 53b Woolley 1939b, Pl. 12.a  
 Class 53c Woolley 1939b, Pl. 22.K6  
 Class 54 Woolley 1939b, Pl. 14.d  
 Class 54 Woolley 1939b, Pl. 22.K11-K13, K16  
 Class 57a Woolley 1939b, Pls 14.f; 22.U1-U2  
 Class 57c Woolley 1939b, Pl. 11.4  
 Class 57c Woolley 1939b, Pls 10.5-6; 11.1-3, 5-6  
 Class 57c Woolley 1939b, Pl. 13.9-11  
 Class 57c Woolley 1939b, Pl. 22.U3-U4  
 Class 68 Woolley 1939b, Pl. 24.J9  
 Class 71a Woolley 1939b, Pl. 24.J6  
 Class 73 Woolley 1939b, Pl. 24.J7-J8

Class 84 Woolley 1939b, Pl. 16.a.1  
 Class 84 Woolley 1939b, Pl. 16.b.1-3  
 Class 85b Woolley 1939b, Pl. 16.a.2  
 Class 101 Woolley 1939b, Pl. 14.a  
 Class 105 Woolley 1939b, Pl. 24.J3-J4  
 Class 106 Woolley 1939b, Pl. 24.J1  
 Class 107a Woolley 1939b, Pl. 24.J2  
 Class 110 Woolley 1939b, Pl. 24.J5  
 Class 126 Woolley 1939b, Pl. 14.b  
 Class 130 Woolley 1939b, Pl. 14.c  
 Class 131b Woolley 1939b, Pl. 14.c  
 Class 134a Woolley 1939b, Pl. 22.B19  
 Class 134c Woolley 1939b, Pl. 23.B16  
 Class 134d Woolley 1939b, Pl. 23.B17  
 Class 134e Woolley 1939b, Pl. 23.B13  
 Class 138 Woolley 1939b, Pl. 23.B9  
 Class 139 Woolley 1939b, Pl. 24.B32  
 Class 141a Woolley 1939b, Pl. 23.B2  
 Class 142 Woolley 1939b, Pl. 23.B1, B3  
 Class 146 Woolley 1939b, Pl. 23.B18  
 Class 148 Woolley 1939b, Pl. 23.B11-B12, B15  
 Class 149 Woolley 1939b, Pl. 23.B7-B8  
 Class 156 Woolley 1939b, Pl. 23.B4, B20  
 Class 160a Woolley 1939b, Pl. 23.B25  
 Class 165a Woolley 1939b, Pl. 23.B22  
 Class 168 Woolley 1939b, Pl. 23.B14  
 Class 172 Woolley 1939b, Pl. 23.B27  
 Class 178 Woolley 1939b, Pl. 23.B21  
 Class 184 Woolley 1939b, Pl. 23.B26  
 Class 188 Woolley 1939b, Pl. 15.d.2  
 Class 188 Woolley 1939b, Pl. 15.e.1  
 Class 189 Woolley 1939b, Pl. 23.B28-B29

## C.19 Jezreel, Tel

### Findgroup A

Class 7a Zimhoni 1997a, Fig. 1.7 (11)  
 Class 8b Zimhoni 1997a, Fig. 1.6 (3)  
 Class 8b Zimhoni 1997a, Fig. 1.7 (9)  
 Class 8b Zimhoni 1997b, Fig. 2.6 (1)  
 Class 8c Zimhoni 1997a, Fig. 1.7(8, 11-12, 14)  
 Class 8c Zimhoni 1997b, Fig. 2.6 (2)  
 Class 8d Zimhoni 1997a, Figs 1.6 (4-5); 1.7 (13)  
 Class 8d Zimhoni 1997b, Fig. 2.6 (3)  
 Class 14 Zimhoni 1997a, Fig. 1.7 (15)  
 Class 18 Zimhoni 1997a, Fig. 1.7 (24)  
 Class 22 Zimhoni 1997a, Fig. 1.7 (18)  
 Class 54 Zimhoni 1997a, Fig. 1.7 (6-7)  
 Class 54 Zimhoni 1997b, Fig. 2.5 (5-7)  
 Class 55 Zimhoni 1997b, Fig. 2.5 (4)  
 Class 64 Zimhoni 1997a, Fig. 1.6 (6-12)  
 Class 64 Zimhoni 1997b, Fig. 2.7 (1-4, 7-8)  
 Class 80 Zimhoni 1997b, Fig. 2.15 (1)  
 Class 134b Zimhoni 1997b, Fig. 2.5 (1)  
 Class 141d Zimhoni 1997a, Fig. 1.6 (2)  
 Class 152 Zimhoni 1997a, Fig. 1.6 (1)  
 Class 152 Zimhoni 1997a, Fig. 1.7 (1-2, 5)

Class 152 Zimhoni 1997b, Fig. 2.5 (2)  
 Class 172 Zimhoni 1997a, Fig. 1.7 (4)  
 Class 182a Zimhoni 1997a, Fig. 1.7 (3)

### Findgroup B

Class 6 Zimhoni 1997b, Fig. 2.9 (2)  
 Class 8c Zimhoni 1997b, Fig. 2.9 (1)  
 Class 15 Zimhoni 1997b, Fig. 2.9 (8)  
 Class 16a Zimhoni 1997b, Fig. 2.9 (2-4)  
 Class 16b Zimhoni 1997b, Fig. 2.9 (1, 5-6)  
 Class 20 Zimhoni 1997b, Fig. 2.9 (3)  
 Class 26 Zimhoni 1997b, Fig. 2.9 (5)  
 Class 38a Zimhoni 1997b, Fig. 2.8 (7)  
 Class 54 Zimhoni 1997b, Fig. 2.8 (8-9)  
 Class 71b Zimhoni 1997b, Fig. 2.9 (3)  
 Class 100a Zimhoni 1997b, Fig. 2.9 (6)  
 Class 100d Zimhoni 1997b, Fig. 2.9 (7)  
 Class 102b Zimhoni 1997b, Fig. 2.9 (5)  
 Class 141d Zimhoni 1997b, Fig. 2.8 (11)  
 Class 160a Zimhoni 1997b, Fig. 2.8 (2)  
 Class 162 Zimhoni 1997b, Fig. 2.8 (3)  
 Class 180 Zimhoni 1997b, Fig. 2.8 (1)  
 Class 183 Zimhoni 1997b, Fig. 2.8 (5)  
 Class 184 Zimhoni 1997b, Fig. 2.8 (6)

### **Findgroup C**

- Class 55 Zimhoni 1997a, Fig. 1.9 (2)
- Class 152 Zimhoni 1997a, Fig. 1.8 (3)
- Class 162 Zimhoni 1997a, Fig. 1.8 (1)
- Class 172 Zimhoni 1997a, Fig. 1.8 (2)
- Class 182b Zimhoni 1997a, Fig. 1.9 (3)

### **Findgroup D**

- Class 8b Zimhoni 1997a, Fig. 1.5 (1-2)
- Class 8c Zimhoni 1997a, Fig. 1.4 (2-5)
- Class 8d Zimhoni 1997a, Fig. 1.5 (3-5)
- Class 8e Zimhoni 1997a, Fig. 1.4 (6)
- Class 38a Zimhoni 1997a, Fig. 1.2 (17)
- Class 38a Zimhoni 1997a, Fig. 1.3 (12)
- Class 54 Zimhoni 1997a, Fig. 1.2 (16)
- Class 55 Zimhoni 1997a, Fig. 1.3 (13)
- Class 64 Zimhoni 1997a, Fig. 1.4 (11)
- Class 134b Zimhoni 1997a, Fig. 1.2 (8, 10)
- Class 152 Zimhoni 1997a, Fig. 1.2 (12-15)
- Class 152 Zimhoni 1997a, Fig. 1.3 (8-10)
- Class 158a Zimhoni 1997a, Figs 1.2 (7); 1.3 (3-5)
- Class 160a Zimhoni 1997a, Figs 1.2 (11); 1.3 (6)
- Class 163 Zimhoni 1997a, Fig. 1.3 (11)
- Class 180 Zimhoni 1997a, Fig. 1.2 (1-2, 4-5)

## **C.20 Joya**

- Class 4a S.V. Chapman 1972, Fig. 22.217
- Class 12b S.V. Chapman 1972, Fig. 23.227
- Class 12c S.V. Chapman 1972, Fig. 23.230, 235
- Class 14 S.V. Chapman 1972, Fig. 22.218
- Class 18 S.V. Chapman 1972, Fig. 21.215
- Class 21 S.V. Chapman 1972, Fig. 22.219
- Class 42 S.V. Chapman 1972, Fig. 18.209-211
- Class 42 S.V. Chapman 1972, Fig. 19.212-213
- Class 42 S.V. Chapman 1972, Fig. 20.214
- Class 73 S.V. Chapman 1972, Fig. 11.173
- Class 74 S.V. Chapman 1972, Fig. 11.172
- Class 77 S.V. Chapman 1972, Fig. 5.193
- Class 77 S.V. Chapman 1972, Fig. 30.264
- Class 78 S.V. Chapman 1972, Fig. 3.191-192
- Class 79 S.V. Chapman 1972, Fig. 30.263
- Class 81 S.V. Chapman 1972, Fig. 31.266
- Class 82a S.V. Chapman 1972, Fig. 26.259
- Class 82b S.V. Chapman 1972, Fig. 27.261
- Class 82e S.V. Chapman 1972, Fig. 10.171
- Class 85b S.V. Chapman 1972, Fig. 6.178
- Class 88 S.V. Chapman 1972, Fig. 6.185
- Class 88 S.V. Chapman 1972, Fig. 8.190
- Class 90a S.V. Chapman 1972, Fig. 6.186
- Class 90a S.V. Chapman 1972, Fig. 7.175-176

## **C.21 Judeideh, Tell**

### **Stratum II**

- Class 193 see Lehmann 1996, 392 (Form 169a)

- Class 180 Zimhoni 1997a, Fig. 1.3 (1-2)

### **Findgroup F**

- Class 8b Zimhoni 1997b, Fig. 2.12 (3)
- Class 8d Zimhoni 1997b, Fig. 2.12 (4)
- Class 54 Zimhoni 1997b, Fig. 2.12 (1)
- Class 64 Zimhoni 1997b, Fig. 2.12 (6-7)
- Class 81 Zimhoni 1997b, Fig. 2.12 (5)
- Class 152 Zimhoni 1997b, Fig. 2.12 (2)

### **Unstratified**

- Class 7a Zimhoni 1997a, Fig. 1.10 (1-2)
- Class 8b Zimhoni 1997b, Fig. 2.4 (1-2)
- Class 8e Zimhoni 1997b, Fig. 2.4 (3-4)
- Class 54 Zimhoni 1997b, Fig. 2.3 (17)
- Class 56 Zimhoni 1997b, Fig. 2.2 (6)
- Class 134a Zimhoni 1997b, Fig. 2.3 (11)
- Class 134a Zimhoni 1997b, Fig. 2.3 (11-12, 14-15)
- Class 144b Zimhoni 1997b, Fig. 2.15 (2)
- Class 152 Zimhoni 1997b, Fig. 2.3 (10, 13)
- Class 158a Zimhoni 1997b, Fig. 2.3 (1, 4)
- Class 161 Zimhoni 1997b, Fig. 2.3 (7)
- Class 173a Zimhoni 1997b, Fig. 2.3 (5, 8-9)
- Class 179 Zimhoni 1997b, Fig. 2.3 (6)
- Class 182a Zimhoni 1997b, Fig. 2.3 (16)

- Class 97 S. V. Chapman 1972, Fig. 8.189
- Class 102a S. V. Chapman 1972, Fig. 12.197-198
- Class 102a S. V. Chapman 1972, Fig. 14.200, 203, 205, 207
- Class 102b S. V. Chapman 1972, Fig. 12.196
- Class 102e S. V. Chapman 1972, Fig. 17.195
- Class 106 S. V. Chapman 1972, Fig. 1.168-169
- Class 107a S. V. Chapman 1972, Fig. 28.262
- Class 116 S. V. Chapman 1972, Fig. 23.226
- Class 131a S. V. Chapman 1972, Fig. 22.220
- Class 131b S. V. Chapman 1972, Fig. 22.221-222
- Class 153 S. V. Chapman 1972, Fig. 24.250
- Class 154 S. V. Chapman 1972, Fig. 24.249
- Class 158a S. V. Chapman 1972, Fig. 24.239
- Class 162 S. V. Chapman 1972, Fig. 24.236-237
- Class 173a S. V. Chapman 1972, Fig. 25.258
- Class 179 S. V. Chapman 1972, Fig. 24.240
- Class 179 S. V. Chapman 1972, Fig. 25.256-257
- Class 180 S. V. Chapman 1972, Fig. 24.238

### **Stratum II/III**

- Class 130 see Lehmann 1996, 384 (Form 125c)

Class 134e see Lehmann 1996, 364 (Form 19)  
Class 149 see Lehmann 1996, 381 (Form 116)  
Class 184 see Lehmann 1996, 377 (Form 89c)  
Class 193 see Lehmann 1996, 392 (Form 169a)

### **Stratum III**

Class 9b see Lehmann 1996, 451 (Form 443)  
Class 27 see Lehmann 1996, 444 (Form 421)  
Class 28 see Lehmann 1996, 443 (Form 418)  
Class 28 see Lehmann 1996, 443 (Form 420)  
Class 33 see Lehmann 1996, 429 (Form 364)  
Class 37b see Lehmann 1996, 428 (Form 363)  
Class 58 see Lehmann 1996, 426 (Form 359a)  
Class 95 see Lehmann 1996, 412 (Form 274)  
Class 121c see Lehmann 1996, 423 (Form 329c)  
Class 141c see Lehmann 1996, 369 (Form 59)  
Class 164 see Lehmann 1996, 361 (Form 7)  
Class 172 see Lehmann 1996, 388 (Form 155)  
Class 172 see Lehmann 1996, 376 (Form 85c)  
Class 173a see Lehmann 1996, 379 (Form 104)  
Class 184 see Lehmann 1996, 378 (Form 94)  
Class 192 see Lehmann 1996, 383 (Form 122)  
Class 193 see Lehmann 1996, 391 (Form 168)  
Class 193 see Lehmann 1996, 392 (Form 169a)

### **Stratum IV/III**

Class 37b Lehmann 1996, Pl. 67 (371/1)  
Class 43 see Lehmann 1996, 397 (Form 208)  
Class 58 see Lehmann 1996, 426 (Form 359a)  
Class 77 see Lehmann 1996, 409 (Form 260)  
Class 95 see Lehmann 1996, 412 (Form 274)  
Class 134c see Lehmann 1996, 367 (Form 41)  
Class 136 see Lehmann 1996, 368 (Form 53)  
Class 172 see Lehmann 1996, 388 (Form 155)  
Class 173a see Lehmann 1996, 379 (Form 104)  
Class 191 see Lehmann 1996, 467 (Form G3)

### **Stratum IV**

Class 1a see Lehmann 1996, 450 (Form 438a)  
Class 1b see Lehmann 1996, 451 (Form 440)  
Class 40a see Lehmann 1996, 396 (Form 194)  
Class 57b Swift 1958, Fig. 39  
Class 77 see Lehmann 1996, 409 (Form 260)  
Class 82b see Lehmann 1996, 416 (Form 300)  
Class 105 Lehmann 1996, Pl. 47 (284/1)  
Class 121c see Lehmann 1996, 423 (Form 329c)

Class 134c see Lehmann 1996, 367 (Form 41)  
Class 153 see Lehmann 1996, 374 (Form 81)  
Class 166 see Lehmann 1996, 360 (Form 4)  
Class 170 see Lehmann 1996, 363 (Form 16)  
Class 170 see Lehmann 1996, 364 (Form 22)  
Class 174 see Lehmann 1996, 359 (Form 1-4)  
Class 184 see Lehmann 1996, 378 (Form 94)  
Class 190 see Lehmann 1996, 377 (Form 89b)  
Class 192 see Lehmann 1996, 383 (Form 122)

### **Unstratified**

Class 1a see Lehmann 1996, 450 (Form 438a); 453 (Form 449)  
Class 1c see Lehmann 1996, 450 (Form 439a)  
Class 28 see Lehmann 1996, 443 (Form 420)  
Class 37b see Lehmann 1996, 428 (Form 363)  
Class 43 see Lehmann 1996, 398 (Form 208)  
Class 54 see Lehmann 1996, 370 (Form 61a)  
Class 62 see Lehmann 1996, 420 (Form 315)  
Class 77 see Lehmann 1996, 409 (Form 260)  
Class 95 see Lehmann 1996, 412 (Form 274)  
Class 105 see Lehmann 1996, 414 (Form 285)  
Class 128 see Lehmann 1996, 425 (Form 349)  
Class 134c see Lehmann 1996, 367 (Form 41)  
Class 134d see Lehmann 1996, 374 (Form 83a)  
Class 136 see Lehmann 1996, 368 (Form 53)  
Class 141c see Lehmann 1996, 370 (Form 62)  
Class 168 see Lehmann 1996, 360 (Form 1)  
Class 176 see Lehmann 1996, 360 (Form 2)  
Class 184 see Lehmann 1996, 378 (Form 94)  
Class 192 see Lehmann 1996, 383 (Form 122)

## **C.22 Jurn Kabir, Tell**

### **Findgroup A**

Class 3 Eidem & Ackermann 1999, Fig. 5.22  
Class 5 Eidem & Ackermann 1999, Fig. 5.26  
Class 7b Eidem & Ackermann 1999, Fig. 5.23  
Class 56 Eidem & Ackermann 1999, Fig. 5.24  
Class 110 Eidem & Ackermann 1999, Fig. 9b.5  
Class 134a Eidem & Ackermann 1999, Fig. 5.14  
Class 141a Eidem & Ackermann 1999, Fig. 5.15  
Class 141b Eidem & Ackermann 1999, Fig. 4.12  
Class 141c Eidem & Ackermann 1999, Fig. 4.10-11  
Class 173a Eidem & Ackermann 1999, Fig. 9b.2

Class 176 Eidem & Ackermann 1999, Fig. 4.9  
Class 180 Eidem & Ackermann 1999, Fig. 4.8  
Class 182c Eidem & Ackermann 1999, Fig. 4.5

Class 184 Eidem & Ackermann 1999, Fig. 4.1-4  
Class 188 Eidem & Ackermann 1999, Fig. 4.6

### **Findgroup B**

Class 1b Eidem & Ackermann 1999, Fig. 7.17  
Class 143 Eidem & Ackermann 1999, Fig. 6.9-10  
Class 150 Eidem & Ackermann 1999, Fig. 6.6  
Class 161 Eidem & Ackermann 1999, Fig. 6.8  
Class 168 Eidem & Ackermann 1999, Fig. 6.7  
Class 173a Eidem & Ackermann 1999, Fig. 6.8  
Class 182b Eidem & Ackermann 1999, Fig. 6.5  
Class 184 Eidem & Ackermann 1999, Fig. 6.1-

Class 189 Eidem & Ackermann 1999, Fig. 7.4  
**Findgroup C**  
Class 1a Eidem & Ackermann 1999, Fig. 9a.19  
Class 1b Eidem & Ackermann 1999, Fig. 9a.20  
Class 56 Eidem & Ackermann 1999, Fig. 9a.17  
Class 121e Eidem & Ackermann 1999, Fig. 8.3-4

Class 139 Eidem & Ackermann 1999, Fig. 8.10  
Class 141a Eidem & Ackermann 1999, Fig. 8.8, 11  
Class 141b Eidem & Ackermann 1999, Fig. 8.7  
Class 141c Eidem & Ackermann 1999, Fig. 8.6  
Class 152 Eidem & Ackermann 1999, Fig. 8.9

## C.23 Kamid el-Loz

### Area S unstratified

Class 54 Heinz et al. 2004, Pl. 1f

### Iron I

Class 4b Marfoe 1995, Fig. 104.7  
Class 4c Marfoe 1995, Fig. 105.8  
Class 5 Heinz et al. 2004, Pl. 1a-d  
Class 6 Marfoe 1995, Fig. 103.2, 4, 6  
Class 8a Heinz et al. 2004, Fig. 54.2  
Class 8b Marfoe 1995, Fig. 105.5  
Class 8c Marfoe 1995, Figs 104.4; 105.4  
Class 8d Marfoe 1995, Figs 104.2, 5; 105.2-3  
Class 8e Hachmann 1966, Fig. 24.4  
Class 8e Heinz et al. 2004, Pl. 1e  
Class 8e Heinz et al. 2004, Fig. 54.1  
Class 14 Marfoe 1995, Fig. 105.9-11  
Class 16a Marfoe 1995, Fig. 106.5  
Class 57c Marfoe 1995, Fig. 106.6  
Class 100b Marfoe 1995, Fig. 103.3  
Class 100c Marfoe 1995, Fig. 103.1  
Class 102b Marfoe 1995, Fig. 103.5

Class 102b Heinz et al. 2004, Fig. 46  
Class 103a Hachmann 1966, Fig. 23.3, 5  
Class 103a Marfoe 1995, Fig. 106.2-3  
Class 103b Hachmann 1966, Fig. 23.1, 6  
Class 103b Marfoe 1995, Fig. 106.1, 4  
Class 104 Hachmann 1966, Fig. 22.3  
Class 104 Hachmann 1966, Fig. 23.2-4, 10-11  
Class 106 Marfoe 1995, Fig. 104.1, 3, 6  
Class 116 Hachmann 1966, Fig. 24.2  
Class 174 Marfoe 1995, Fig. 105.1  
Class 188 Hachmann 1966, Fig. 21.5

### Persian Cemetery

Class 54 Poppa 1978, Gr. 16.5  
Class 57a Poppa 1978, Gr. 81.2  
Class 73 Poppa 1978, Gr. 37.1  
Class 101 Poppa 1978, Gr. 82.1;  
Class 117 Poppa 1978, Gr. 2.17; 76.38  
Class 118 Poppa 1978, Gr. 4.22; 12.8; 17.3; 21.1; 28.17; 67.5  
Class 141a Poppa 1978, Gr. 87.7

## C.24 Kazel, Tell

### Area I level 4

Class 9a Gubel 1990a, Fig. 23.e  
Class 9a Gubel 1990b, Fig. 2g  
Class 12c Gubel 1990a, Fig. 24.d-e  
Class 12c Badre & Gubel 1999-2000, Fig. 4.a  
Class 27 Dunand & Saliby 1957, 11.  
Class 27 Badre et al. 1994, Fig. 8.e  
Class 27 Badre & Gubel 1999-2000, Fig. 3.e-f  
Class 28 Gubel 1990a, Fig. 23.a, 1  
Class 28 Gubel 1990b, Fig. 2a-b  
Class 71a Gubel 1990a, Fig. 23.f  
Class 72 Gubel 1990a, Fig. 24.a  
Class 94 Gubel 1990b, Fig. 2i  
Class 114 Gubel 1990a, Fig. 23.j  
Class 114 Gubel 1990b, Fig. 2i  
Class 162 Badre & Gubel 1999-2000, Fig. 4.d  
Class 182c Gubel 1990a, Fig. 23.c-d  
Class 193 Gubel 1990b, Fig. 2h

### Area I level 6

Class 121f Gubel 1990a, Fig. 26.b

### Area I level 8

Class 143 Gubel 1990a, Fig. 29.a

### Area I level 9

Class 4a Gubel 1990a, Fig. 30.d  
Class 4b Gubel 1990a, Fig. 30.b

Class 6 Gubel 1990a, Fig. 30.c  
Class 35 Gubel 1990a, Fig. 30.e  
Class 111 Badre et al. 1994, Fig. 11  
Class 180 Gubel 1990a, Fig. 30.a

### Area I levels 9-10

Class 15 Badre et al. 1994, Fig. 20.b-c  
Class 18 Badre et al. 1994, Fig. 19  
Class 78 Badre et al. 1994, Fig. 18.a  
Class 80 Badre et al. 1994, Fig. 18.b

### Area I level 13

Class 158a Badre et al. 1994, Fig. 21

### Area I levels 6-13

Class 19 Badre & Gubel 1999-2000, Fig. 5.a  
Class 26 Badre & Gubel 1999-2000, Fig. 5.b  
Class 85b Badre & Gubel 1999-2000, Fig. 5.d  
Class 164 Badre & Gubel 1999-2000, Fig. 5.h  
Class 172 Badre & Gubel 1999-2000, Fig. 5.e  
Class 180 Badre & Gubel 1999-2000, Fig. 5.f-g

### Area I level 14

Class 157 Badre & Gubel 1999-2000, Fig. 6.j  
Class 158a Badre & Gubel 1999-2000, Fig. 6.i  
Class 164 Badre & Gubel 1999-2000, Fig. 6.h  
Class 180 Badre & Gubel 1999-2000, Fig. 6.g

### Area I level 15

Class 168 Badre & Gubel 1999-2000, Fig. 6.f

**Area I level 16**

Class 116 Badre & Gubel 1999-2000, Fig. 6.c

**Area I levels 14-16**

Class 29 Badre & Gubel 1999-2000, Fig. 6.a

Class 80 Badre & Gubel 1999-2000, Fig. 6.b

Class 168 Badre & Gubel 1999-2000, Fig. 6.e

Class 180 Badre & Gubel 1999-2000, Fig. 6.d

**Area II level 3**

Class 27 Badre et al. 1994, Fig. 23.a

Class 71a Badre 1990b, Fig. 34.c

Class 115 Badre 1990b, Fig. 34.f-g

Class 115 Badre et al. 1994, Fig. 23.b-d

Class 120 Badre 1990b, Fig. 34.h

**Area II level 4**

Class 4b Badre et al. 1994, Fig. 28.h

Class 6 Badre et al. 1994, Fig. 28.g

Class 16b Badre 1990b, Fig. 37.i-k

Class 36 Capet 2003, Fig. 51.a

Class 42 Badre et al. 1994, Fig. 28.e

Class 44 Badre et al. 1994, Fig. 28.f

Class 73 Badre et al. 1994, Fig. 28.a

Class 102b Badre 1990b, Fig. 37.h

Class 115 Badre 1990b, Fig. 37.g

Class 157 Badre et al. 1994, Fig. 28.b

Class 164 Badre 1990b, Fig. 37.c

Class 164 Capet 2003, Fig. 51.b

Class 168 Badre et al. 1994, Fig. 28.d

Class 172 Badre 1990b, Fig. 37.b

Class 179 Badre 1990b, Fig. 37.a

Class 179 Capet 2003, Fig. 51.c

Class 193 Badre 1990b, Fig. 37.d-f

**Area II level 5**

Class 4c Badre et al. 1994, Fig. 33.a

Class 4c Capet 2003, Figs 37.a; 40.a

Class 4d Capet 2003, Fig. 38.b

Class 8a Badre 1990b, Fig. 41.f-g

Class 8e Badre et al. 1994, Fig. 33.a

Class 12a Badre 1990b, Fig. 39.d-e

Class 12b Capet 2003, Fig. 34.g

Class 16a Capet & Gubel 2000, Fig. 10

Class 16a Capet 2003, Fig. 36.a

Class 16b Badre et al. 1994, Fig. 31.a, c, f

Class 16b Capet 2003, Fig. 34.a

Class 16b Capet 2003, Figs 36.b-e; 43.a-g

Class 16c Badre et al. 1994, Fig. 31.b, d, e

Class 22 Capet 2003, Fig. 43.h

Class 36 Capet 2003, Fig. 48.a

Class 36 Capet 2003, Figs 43.i; 49.b

Class 40a Capet & Gubel 2000, Fig. 12-13

Class 40a Capet 2003, Fig. 37.c

Class 40c Badre et al. 1994, Fig. 35.d

Class 41a Capet 2003, Fig. 45.a-b

Class 42 Capet 2003, Fig. 44.a, c

Class 53b Capet 2003, Fig. 45.c

Class 56 Badre et al. 1994, Figs 35.c; 39.a

Class 57a Badre 1990b, Fig. 41.a

Class 57d Badre et al. 1994, Fig. 35.a

Class 57d Capet & Gubel 2000, Fig. 14

Class 57d Capet 2003, Fig. 43.j-k

Class 62 Badre et al. 1994, Fig. 35.b

Class 69 Capet 2003, Fig. 36.h

Class 69 Capet 2003, Fig. 44.e-f

Class 71a Capet 2003, Fig. 36.i

Class 71a Capet 2003, Fig. 48.b

Class 73 Badre et al. 1994, Fig. 33.e-f

Class 82e Badre 1990b, Fig. 39.g

Class 102a Badre et al. 1994, Fig. 32.a-b

Class 102a Capet 2003, Fig. 40.f

Class 102b Capet 2003, Fig. 34.d

Class 102c Badre et al. 1994, Fig. 39.e

Class 102c Capet 2003, Fig. 36.k

Class 105 Badre et al. 1994, Fig. 33.c

Class 105 Capet & Gubel 2000, Fig. 11

Class 105 Capet 2003, Fig. 36.g

Class 105 Capet 2003, Fig. 40.j

Class 116 Badre et al. 1994, Fig. 33.d

Class 116 Badre et al. 1994, Fig. 39.c

Class 116 Capet 2003, Fig. 34.c

Class 116 Capet 2003, Fig. 40.i

Class 116 Capet 2003, Fig. 49.c

Class 130 Capet 2003, Fig. 46.d-f

Class 131a Badre 1990b, Fig. 39.a-b

Class 131a Capet 2003, Fig. 46.b-c

Class 134a Badre 1990b, Fig. 41.d

Class 134a Badre et al. 1994, Fig. 36.b

Class 143 Badre et al. 1994, Fig. 32.d

Class 157 Capet 2003, Fig. 34.e

Class 160a Badre 1990b, Fig. 41.b

Class 161 Capet 2003, Fig. 45.g

Class 164 Capet 2003, Fig. 39.b

Class 164 Capet 2003, Fig. 45.f

Class 168 Capet 2003, Fig. 40.h

Class 169 Badre 1990b, Fig. 41.e

Class 169 Capet 2003, Fig. 45.j-k

Class 172 Capet 2003, Fig. 36.j

Class 174 Badre 1990b, Fig. 41.c

Class 188 Badre et al. 1994, Fig. 39.b

Class 188 Badre et al. 1994, Fig. 39.f

Class 188 Capet 2003, Fig. 37.b

Class 188 Capet 2003, Fig. 40.k, m-n

Class 188 Capet 2003, Fig. 46.a

**Area II level 6**

Class 4c Capet 2003, Fig. 21.h-j

Class 4c Capet 2003, Fig. 26.b-c

Class 7b Badre et al. 1994, Fig. 42.g-h

Class 12a Badre et al. 1994, Fig. 47.h

Class 12b Capet 2003, Fig. 21.d

Class 16b Capet 2003, Fig. 6.a-b

Class 21 Badre et al. 1994, Fig. 45.b

Class 22 Badre et al. 1994, Fig. 42.a

Class 22 Badre et al. 1994, Fig. 44.a

Class 35 Badre 1990b, Fig. 44.a

Class 36 Capet 2003, Fig. 25.c

Class 40a Badre 1990b, Fig. 43.c

Class 40a Badre et al. 1994, Fig. 48.f

Class 40a Badre et al. 1994, Fig. 49.b

Class 42 Capet 2003, Fig. 17.a

Class 53b Badre et al. 1994, Fig. 48.e

Class 53b Badre et al. 1994, Fig. 49.d

Class 57a Badre et al. 1994, Fig. 41.d-e  
 Class 57a Capet 2003, Fig. 21.g  
 Class 69 Capet 2003, Fig. 6.d  
 Class 102a Badre et al. 1994, Fig. 52.f  
 Class 102b Badre et al. 1994, Fig. 52.e  
 Class 102c Badre et al. 1994, Fig. 41.a  
 Class 103b Badre et al. 1994, Fig. 45.g  
 Class 103b Badre et al. 1994, Fig. 59.c  
 Class 103b Capet 2003, Fig. 7.d  
 Class 104 Capet 2003, Fig. 7.e  
 Class 104 Capet 2003, Fig. 27.a  
 Class 109 Capet 2003, Fig. 11  
 Class 116 Badre et al. 1994, Fig. 52.a  
 Class 116 Capet 2003, Fig. 15  
 Class 123 Badre et al. 1994, Fig. 45.h  
 Class 128 Capet 2003, Fig. 7.a  
 Class 131a Capet 2003, Fig. 21.e  
 Class 134a Badre et al. 1994, Fig. 48.c  
 Class 158a Badre et al. 1994, Fig. 48.d  
 Class 158a Badre et al. 1994, Fig. 52.b-c  
 Class 162 Capet 2003, Fig. 20.h  
 Class 162 Capet 2003, Fig. 25.b  
 Class 164 Badre 1990b, Fig. 43.e  
 Class 164 Badre et al. 1994, Fig. 42.e-f  
 Class 164 Badre et al. 1994, Fig. 59.a  
 Class 164 Capet 2003, Fig. 4  
 Class 164 Capet 2003, Fig. 12.b  
 Class 164 Capet 2003, Fig. 32.i  
 Class 169 Badre et al. 1994, Fig. 45.f  
 Class 169 Badre et al. 1994, Fig. 59.b  
 Class 169 Capet 2003, Fig. 8.i-j  
 Class 169 Capet 2003, Fig. 25.e-f  
 Class 178 Badre et al. 1994, Fig. 44.e  
 Class 188 Badre et al. 1994, Fig. 55.d-e  
 Class 188 Capet 2003, Fig. 8.g  
 Class 188 Capet 2003, Fig. 23.a

**Area IV level 3**  
 Class 12b Badre & Gubel 1999-2000, Fig. 46.c  
 Class 15 Badre & Gubel 1999-2000, Fig. 46.a  
 Class 82e Badre & Gubel 1999-2000, Fig. 46.d  
 Class 188 Badre & Gubel 1999-2000, Fig. 46.d-h

**Area IV level 4**  
 Class 42 Badre & Gubel 1999-2000, Fig. 44.b  
 Class 57a Badre & Gubel 1999-2000, Fig. 43.a  
 Class 82e Badre & Gubel 1999-2000, Fig. 43.e-g  
 Class 102a Badre & Gubel 1999-2000, Fig. 44.a

Class 160a Badre & Gubel 1999-2000, Fig. 43.c  
 Class 188 Badre & Gubel 1999-2000, Fig. 43.b

**Area IV level 5**  
 Class 12b Badre & Gubel 1999-2000, Fig. 36.l-m  
 Class 16b Badre & Gubel 1999-2000, Fig. 32  
 Class 35 Badre & Gubel 1999-2000, Fig. 41.e  
 Class 36 Badre & Gubel 1999-2000, Fig. 37.j-k, m  
 Class 40a Badre & Gubel 1999-2000, Fig. 37.b  
 Class 41a Badre & Gubel 1999-2000, Fig. 41.b  
 Class 41b Badre & Gubel 1999-2000, Fig. 37.l  
 Class 42 Badre & Gubel 1999-2000, Fig. 31.g, j-k  
 Class 102b Badre & Gubel 1999-2000, Fig. 34.f  
 Class 116 Badre & Gubel 1999-2000, Fig. 31.a  
 Class 164 Badre & Gubel 1999-2000, Fig. 31.f-g  
 Class 168 Badre & Gubel 1999-2000, Fig. 31.i  
 Class 169 Badre & Gubel 1999-2000, Figs 31.d, h; 34.i-j

#### **Iron I**

Class 42 Dunand et al. 1964, Pl. 12.4  
 Class 53b Dunand et al. 1964, Pl. 13.3-4  
 Class 69 Dunand et al. 1964, Pl. 13.1  
 Class 88 Dunand & Saliby 1957, Pl. 7.4  
 Class 88 Dunand et al. 1964, Pl. 13.2  
 Class 100b Dunand & Saliby 1957, Pl. 7.1

#### **Iron II**

Class 8d Dunand et al. 1964, Pl. 10.4  
 Class 12c Dunand et al. 1964, Pl. 11.5  
 Class 21 Dunand et al. 1964, Pl. 10.2  
 Class 59 Dunand et al. 1964, Pl. 10.3  
 Class 84 Dunand et al. 1964, Pl. 11.1  
 Class 131a Dunand et al. 1964, Pl. 11.4  
 Class 188 Dunand et al. 1964, Pl. 11.3

#### **Unstratified**

Class 84 Yon & Caubet 1990, Fig. 3.182  
 Class 162 Yon & Caubet 1990, Fig. 3.131  
 Class 162 Yon & Caubet 1990, Fig. 3.160  
 Class 162 Yon & Caubet 1990, Fig. 3.186  
 Class 163 Yon & Caubet 1990, Fig. 2.130  
 Class 163 Yon & Caubet 1990, Fig. 3.184  
 Class 188 Yon & Caubet 1990, Fig. 2.129  
 Class 188 Yon & Caubet 1990, Fig. 3.149  
 Class 188 Yon & Caubet 1990, Fig. 3.176  
 Class 191 Yon & Caubet 1990, Fig. 3.174

## **C.25 Kefrik**

Class 49 Moorey 1980, Fig. 23.557  
 Class 53b Moorey 1980, Figs 23.565; 25.583  
 Class 84 Moorey 1980, Fig. 23.559-562  
 Class 85b Moorey 1980, Fig. 23.564

Class 123 Moorey 1980, Fig. 23.563  
 Class 141a Moorey 1980, Fig. 23.558  
 Class 148 Moorey 1980, Fig. 25.595

## B.26 Keisan, Tell

### Stratum 2 (French)

- Class 9a Briend & Humbert 1980, Pl. 11.1a-n, 2a-f, 3a-c
- Class 15 Briend & Humbert 1980, Pl. 10.11
- Class 18 Briend & Humbert 1980, Pls 7.7; 8.1-4, 6-7
- Class 19 Briend & Humbert 1980, Pl. 7.6
- Class 23 Briend & Humbert 1980, Pl. 7.1, 8
- Class 25 Briend & Humbert 1980, Pl. 7.3-5
- Class 56 Briend & Humbert 1980, Pl. 12.10
- Class 68 Briend & Humbert 1980, Pl. 9.3-11
- Class 74 Briend & Humbert 1980, Pl. 9.2
- Class 102b Briend & Humbert 1980, Pl. 10.17-21
- Class 115 Briend & Humbert 1980, Pl. 14.16-23

### Stratum 3 (French)

- Class 1c Briend & Humbert 1980, Pl. 21.6-7
- Class 9a Briend & Humbert 1980, Pl. 21.9-9a
- Class 12c Briend & Humbert 1980, Pl. 21.1-5
- Class 18 Briend & Humbert 1980, Pl. 18.1
- Class 20 Briend & Humbert 1980, Pl. 18.11
- Class 23 Briend & Humbert 1980, Pl. 18.2-4, 8-9
- Class 54 Briend & Humbert 1980, Pl. 20.22-22a
- Class 73 Briend & Humbert 1980, Pl. 19.10
- Class 81 Briend & Humbert 1980, Pl. 19.4-5
- Class 100b Briend & Humbert 1980, Pl. 19.7a, 9
- Class 113 Briend & Humbert 1980, Pl. 19.8
- Class 141a Briend & Humbert 1980, Pl. 20.6, 8-9
- Class 145a Briend & Humbert 1980, Pl. 20.14
- Class 154 Briend & Humbert 1980, Pl. 20.4
- Class 155 Briend & Humbert 1980, Pl. 20.12
- Class 160a Briend & Humbert 1980, Pl. 20.10
- Class 162 Briend & Humbert 1980, Pl. 22.6
- Class 191 Briend & Humbert 1980, Pl. 22.1-5
- Class 193 Briend & Humbert 1980, Pl. 20.15-21

### Stratum 4 (French)

- Class 2 Briend & Humbert 1980, Pl. 34.3
- Class 3 Briend & Humbert 1980, Pl. 34.5, 7-9
- Class 4b Briend & Humbert 1980, Pl. 28.4
- Class 4b Briend & Humbert 1980, Pl. 34.2, 6
- Class 5 Briend & Humbert 1980, Pl. 28.6
- Class 5 Briend & Humbert 1980, Pl. 35.2
- Class 6 Briend & Humbert 1980, Pl. 33.8
- Class 7b Briend & Humbert 1980, Pl. 34.1
- Class 7b Briend & Humbert 1980, Pl. 35.6
- Class 8a Briend & Humbert 1980, Pl. 34.10e
- Class 8c Briend & Humbert 1980, Pl. 34.10
- Class 8d Briend & Humbert 1980, Pl. 35.1, 3, 5
- Class 8e Briend & Humbert 1980, Pl. 34.10a-d
- Class 12c Briend & Humbert 1980, Pl. 32.8-9

- Class 15 Briend & Humbert 1980, Pl. 32.7
- Class 18 Briend & Humbert 1980, Pl. 25.6
- Class 24a Briend & Humbert 1980, Pl. 25.1, 4-5, 7-8
- Class 24a Briend & Humbert 1980, Pl. 27.1-7
- Class 25 Briend & Humbert 1980, Pl. 27.8
- Class 26 Briend & Humbert 1980, Pls 25.2-3; 27.9
- Class 26 Briend & Humbert 1980, Pl. 26.1-9
- Class 27 Briend & Humbert 1980, Pl. 23.1-6
- Class 27 Briend & Humbert 1980, Pl. 24.1-7
- Class 42 Briend & Humbert 1980, Pl. 28.9
- Class 85a Briend & Humbert 1980, Pl. 28.8
- Class 100a Briend & Humbert 1980, Pl. 28.7
- Class 100b Briend & Humbert 1980, Pl. 28.11
- Class 100b Briend & Humbert 1980, Pl. 33.3-4
- Class 102b Briend & Humbert 1980, Pl. 33.9
- Class 129 Briend & Humbert 1980, Pl. 32.4
- Class 134a Briend & Humbert 1980, Pl. 29.6
- Class 134a Briend & Humbert 1980, Pl. 30.8
- Class 134b Briend & Humbert 1980, Pl. 30.9-10
- Class 135 Briend & Humbert 1980, Pl. 28.12a
- Class 135 Briend & Humbert 1980, Pl. 33.1-2
- Class 141b Briend & Humbert 1980, Pl. 30.3-4
- Class 141c Briend & Humbert 1980, Pl. 30.1
- Class 143 Briend & Humbert 1980, Pl. 29.8
- Class 152 Briend & Humbert 1980, Pl. 29.1
- Class 152 Briend & Humbert 1980, Pl. 30.1a, 2
- Class 153 Briend & Humbert 1980, Pl. 29.2
- Class 153 Briend & Humbert 1980, Pl. 30.6
- Class 153 Briend & Humbert 1980, Pl. 35.8
- Class 160a Briend & Humbert 1980, Pl. 28.5
- Class 162 Briend & Humbert 1980, Pl. 29.10
- Class 163 Briend & Humbert 1980, Pl. 28.2
- Class 172 Briend & Humbert 1980, Pl. 29.7
- Class 173a Briend & Humbert 1980, Pl. 29.5, 9
- Class 173a Briend & Humbert 1980, Pl. 30.7
- Class 182c Briend & Humbert 1980, Pl. 30.5
- Class 183 Briend & Humbert 1980, Pl. 29.11
- Class 184 Briend & Humbert 1980, Pl. 28.3
- Class 191 Briend & Humbert 1980, Pl. 29.13-14
- Class 193 Briend & Humbert 1980, Pl. 28.1
- Class 193 Briend & Humbert 1980, Pl. 31.1-6

### Stratum 5 (French)

- Class 2 Briend & Humbert 1980, Pl. 46.6
- Class 4b Briend & Humbert 1980, Pl. 46.7
- Class 5 Briend & Humbert 1980, Pl. 46.4
- Class 7a Briend & Humbert 1980, Pl. 46.4a
- Class 7b Briend & Humbert 1980, Pl. 46.5
- Class 8c Briend & Humbert 1980, Pl. 46.1
- Class 8d Briend & Humbert 1980, Pl. 46.2
- Class 10 Briend & Humbert 1980, Pl. 46.8
- Class 12c Briend & Humbert 1980, Pl. 43.12

Class 12c Briend & Humbert 1980, Pl. 44.6-8  
 Class 15 Briend & Humbert 1980, Pl. 45.7-12  
 Class 16b Briend & Humbert 1980, Pl. 47.7-8  
 Class 18 Briend & Humbert 1980, Pl. 47.9  
 Class 24a Briend & Humbert 1980, Pl. 47.1-3  
 Class 26 Briend & Humbert 1980, Pl. 47.4  
 Class 42 Briend & Humbert 1980, Pl. 44.1  
 Class 45 Briend & Humbert 1980, Pl. 43.1  
 Class 53b Briend & Humbert 1980, Pl. 45.1-1c  
 Class 54 Briend & Humbert 1980, Pl. 42.2-2a  
 Class 54 Briend & Humbert 1980, Pl. 43.4  
 Class 57b Briend & Humbert 1980, Pl. 44.2  
 Class 73 Briend & Humbert 1980, Pl. 44.4  
 Class 85a Briend & Humbert 1980, Pl. 44.3  
 Class 91 Briend & Humbert 1980, Pl. 37.1-1a  
 Class 100b Briend & Humbert 1980, Pl. 43.8-8a  
 Class 102a Briend & Humbert 1980, Pl. 42.7-8  
 Class 102b Briend & Humbert 1980, Pl. 43.9  
 Class 113 Briend & Humbert 1980, Pl. 36.1-11  
 Class 113 Briend & Humbert 1980, Pl. 37.2-3  
 Class 119 Briend & Humbert 1980, Pl. 37.13  
 Class 121d Briend & Humbert 1980, Pl. 37.10-10c  
 Class 121e Briend & Humbert 1980, Pl. 37.11a-e  
 Class 121f Briend & Humbert 1980, Pl. 37.6-8  
 Class 134b Briend & Humbert 1980, Pl. 41.3b, 5  
 Class 135 Briend & Humbert 1980, Pl. 45.4  
 Class 141a Briend & Humbert 1980, Pl. 40.6  
 Class 141a Briend & Humbert 1980, Pl. 41.1  
 Class 141b Briend & Humbert 1980, Pl. 40.7  
 Class 141c Briend & Humbert 1980, Pl. 41.2-3  
 Class 144b Briend & Humbert 1980, Pl. 39.1-7j  
 Class 144b Briend & Humbert 1980, Pl. 40.1-5  
 Class 145b Briend & Humbert 1980, Pl. 38.9-12  
 Class 145b Briend & Humbert 1980, Pl. 43.13  
 Class 150 Briend & Humbert 1980, Pl. 38.8  
 Class 151 Briend & Humbert 1980, Pl. 38.1-7  
 Class 156 Briend & Humbert 1980, Pl. 40.12a  
 Class 160a Briend & Humbert 1980, Pl. 41.7-8  
 Class 160a Briend & Humbert 1980, Pl. 42.1  
 Class 161 Briend & Humbert 1980, Pl. 41.6, 16  
 Class 162 Briend & Humbert 1980, Pl. 41.9-11  
 Class 164 Briend & Humbert 1980, Pl. 41.13  
 Class 170 Briend & Humbert 1980, Pl. 40.8  
 Class 172 Briend & Humbert 1980, Pl. 40.7b-c  
 Class 173a Briend & Humbert 1980, Pl. 41.11a-c, 14  
 Class 179 Briend & Humbert 1980, Pl. 41.15  
 Class 180 Briend & Humbert 1980, Pl. 40.12  
 Class 183 Briend & Humbert 1980, Pl. 40.10  
 Class 187 Briend & Humbert 1980, Pl. 40.9  
 Class 191 Briend & Humbert 1980, Pl. 40.11  
 Class 193 Briend & Humbert 1980, Pl. 45.5  
**Stratum 6 (French)**

Class 8c Briend & Humbert 1980, Pl. 49.9  
 Class 8d Briend & Humbert 1980, Pl. 49.9a  
 Class 13 Briend & Humbert 1980, Pl. 49.8  
 Class 16a Briend & Humbert 1980, Pl. 48.3  
 Class 16c Briend & Humbert 1980, Pl. 48.4-5  
 Class 26 Briend & Humbert 1980, Pl. 48.1  
 Class 38b Briend & Humbert 1980, Pl. 49.7  
 Class 42 Briend & Humbert 1980, Pl. 49.1  
 Class 54 Briend & Humbert 1980, Pl. 49.5  
 Class 100b Briend & Humbert 1980, Pl. 49.3  
 Class 131a Briend & Humbert 1980, Pl. 49.6  
 Class 152 Briend & Humbert 1980, Pl. 49.2  
**Stratum 7 (French)**  
 Class 4d Briend & Humbert 1980, Pl. 52.14  
 Class 5 Briend & Humbert 1980, Pl. 52.15  
 Class 8c Briend & Humbert 1980, Pl. 52.13b-d  
 Class 8d Briend & Humbert 1980, Pl. 52.13  
 Class 10 Briend & Humbert 1980, Pl. 52.16  
 Class 12b Briend & Humbert 1980, Pl. 51.10-12  
 Class 16a Briend & Humbert 1980, Pl. 50.1-2  
 Class 16b Briend & Humbert 1980, Pl. 50.3-5  
 Class 18 Briend & Humbert 1980, Pl. 50.7-8  
 Class 39 Briend & Humbert 1980, Pl. 53.8  
 Class 40a Briend & Humbert 1980, Pl. 52.9, 12  
 Class 78 Briend & Humbert 1980, Pl. 51.9  
 Class 85a Briend & Humbert 1980, Pl. 51.3  
 Class 107b Briend & Humbert 1980, Pl. 51.1  
 Class 131b Briend & Humbert 1980, Pl. 51.13  
 Class 133 Briend & Humbert 1980, Pl. 51.6-7  
 Class 134a Briend & Humbert 1980, Pl. 52.2, 5  
 Class 153 Briend & Humbert 1980, Pl. 52.8  
 Class 160a Briend & Humbert 1980, Pl. 52.10  
 Class 161 Briend & Humbert 1980, Pl. 52.7  
 Class 162 Briend & Humbert 1980, Pl. 52.1, 3-4  
 Class 162 Briend & Humbert 1980, Pl. 53.1, 7  
 Class 172 Briend & Humbert 1980, Pl. 53.6  
 Class 173a Briend & Humbert 1980, Pl. 53.4  
 Class 179 Briend & Humbert 1980, Pl. 53.5  
 Class 182b Briend & Humbert 1980, Pl. 53.12  
 Class 182c Briend & Humbert 1980, Pl. 53.9-10  
**Stratum 8 (French)**  
 Class 4c Briend & Humbert 1980, Pl. 55.6  
 Class 7a Briend & Humbert 1980, Pl. 55.8  
 Class 8b Briend & Humbert 1980, Pl. 55.2  
 Class 8c Briend & Humbert 1980, Pl. 55.7  
 Class 8d Briend & Humbert 1980, Pl. 55.1, 3  
 Class 10 Briend & Humbert 1980, Pl. 55.4-5  
 Class 16a Briend & Humbert 1980, Pl. 54  
 Class 100b Briend & Humbert 1980, Pl. 56.5-7  
 Class 131b Briend & Humbert 1980, Pl. 56.13  
 Class 153 Briend & Humbert 1980, Pl. 55.9  
 Class 162 Briend & Humbert 1980, Pl. 55.13-14  
 Class 163 Briend & Humbert 1980, Pl. 56.1  
 Class 172 Briend & Humbert 1980, Pl. 55.12



Class 173a Briend & Humbert 1980, Pl. 55.11a, 14  
 Class 188 Briend & Humbert 1980, Pl. 55.10  
 Class 188 Briend & Humbert 1980, Pl. 56.2  
**Stratum 9a/b (French)**  
 Class 8b Briend & Humbert 1980, Pl. 63.7-9  
 Class 8c Briend & Humbert 1980, Pl. 63.2, 5-6  
 Class 8d Briend & Humbert 1980, Pl. 63.4  
 Class 8e Briend & Humbert 1980, Pl. 63.1-1b  
 Class 10 Briend & Humbert 1980, Pl. 63.3  
 Class 12b Briend & Humbert 1980, Pl. 66.14-17  
 Class 16a Briend & Humbert 1980, Pl. 58.1-8  
 Class 16b Briend & Humbert 1980, Pl. 57.9  
 Class 16b Briend & Humbert 1980, Pl. 59.1  
 Class 20 Briend & Humbert 1980, Pl. 57.8  
 Class 26 Briend & Humbert 1980, Pls 59.2-6; 601-4  
 Class 29 Briend & Humbert 1980, Pl. 57.3  
 Class 31 Briend & Humbert 1980, Pl. 57.1  
 Class 38a Briend & Humbert 1980, Pl. 64.1  
 Class 38b Briend & Humbert 1980, Pl. 64.3  
 Class 54 Briend & Humbert 1980, Pl. 65.1-3, 5  
 Class 55 Briend & Humbert 1980, Pl. 64.2-2f  
 Class 66 Briend & Humbert 1980, Pl. 61.11, 14  
 Class 71a Briend & Humbert 1980, Pl. 57.7  
 Class 71a Briend & Humbert 1980, Pl. 61.4, 6  
 Class 80 Briend & Humbert 1980, Pl. 62.3-4, 6, 8  
 Class 100b Briend & Humbert 1980, Pl. 62.7  
 Class 100c Briend & Humbert 1980, Pl. 61.7  
 Class 102a Briend & Humbert 1980, Pl. 62.9  
 Class 102b Briend & Humbert 1980, Pl. 62.1, 10-11  
 Class 102e Briend & Humbert 1980, Pl. 62.2  
 Class 103a Briend & Humbert 1980, Pl. 61.10, 13  
 Class 109 Briend & Humbert 1980, Pl. 61.18  
 Class 131a Briend & Humbert 1980, Pl. 65.12  
 Class 134a Briend & Humbert 1980, Pl. 65.4, 9  
 Class 134a Briend & Humbert 1980, Pl. 66.1  
 Class 134b Briend & Humbert 1980, Pl. 66.10  
 Class 154 Briend & Humbert 1980, Pl. 66.9  
 Class 158a Briend & Humbert 1980, Pl. 66.7  
 Class 160b Briend & Humbert 1980, Pl. 66.12-13  
 Class 161 Briend & Humbert 1980, Pl. 66.6d  
 Class 162 Briend & Humbert 1980, Pl. 66.5, 8  
 Class 173a Briend & Humbert 1980, Pl. 66.4-4e  
 Class 182a Briend & Humbert 1980, Pl. 66.5a  
 Class 188 Briend & Humbert 1980, Pl. 66.2-2n  
**Stratum 9c (French)**  
 Class 4c Briend & Humbert 1980, Pl. 77.5  
 Class 7a Briend & Humbert 1980, Pl. 77.2  
 Class 8c Briend & Humbert 1980, Pl. 77.1a-f, 2a-e  
 Class 8d Briend & Humbert 1980, Pl. 77.3

Class 10 Briend & Humbert 1980, Pl. 77.6  
 Class 12b Briend & Humbert 1980, Pl. 77.7-8  
 Class 16a Briend & Humbert 1980, Pl. 69.2-3  
 Class 16b Briend & Humbert 1980, Pl. 67.1-2a, 4-5  
 Class 21 Briend & Humbert 1980, Pl. 69.6  
 Class 34 Briend & Humbert 1980, Pl. 68.1-3  
 Class 38a Briend & Humbert 1980, Pl. 78.2-2b, j-n  
 Class 38a Briend & Humbert 1980, Pl. 79.2  
 Class 38b Briend & Humbert 1980, Pl. 78.10  
 Class 54 Briend & Humbert 1980, Pl. 78.4  
 Class 54 Briend & Humbert 1980, Pl. 79.1  
 Class 54 Briend & Humbert 1980, Pl. 80.6  
 Class 55 Briend & Humbert 1980, Pl. 78.2f-g  
 Class 56 Briend & Humbert 1980, Pl. 80.12  
 Class 66 Briend & Humbert 1980, Pl. 71.7-8  
 Class 71a Briend & Humbert 1980, Pl. 71.5  
 Class 71a Briend & Humbert 1980, Pl. 72.1  
 Class 75 Briend & Humbert 1980, Pl. 71.5b  
 Class 76 Briend & Humbert 1980, Pl. 70.4  
 Class 82c Briend & Humbert 1980, Pl. 70.3a-t  
 Class 82e Briend & Humbert 1980, Pl. 70.2  
 Class 102a Briend & Humbert 1980, Pl. 74.1-5  
 Class 102a Briend & Humbert 1980, Pl. 75.1-6  
 Class 102a Briend & Humbert 1980, Pl. 76.2-4  
 Class 103b Briend & Humbert 1980, Pl. 70.1  
 Class 104 Briend & Humbert 1980, Pl. 72.6  
 Class 116 Briend & Humbert 1980, Pl. 71.4  
 Class 130 Briend & Humbert 1980, Pl. 73.4-4a  
 Class 131a Briend & Humbert 1980, Pl. 73.6-7  
 Class 131b Briend & Humbert 1980, Pl. 73.5a  
 Class 134a Briend & Humbert 1980, Pl. 79.5-8  
 Class 134d Briend & Humbert 1980, Pl. 80.1  
 Class 141a Briend & Humbert 1980, Pl. 80.2  
 Class 153 Briend & Humbert 1980, Pl. 80.3  
 Class 158a Briend & Humbert 1980, Pl. 79.14a, c-e, g, j-k  
 Class 158b Briend & Humbert 1980, Pl. 73.10  
 Class 160a Briend & Humbert 1980, Pl. 79.14  
 Class 160a Briend & Humbert 1980, Pl. 79.14b, f, h  
 Class 161 Briend & Humbert 1980, Pl. 79.13  
 Class 162 Briend & Humbert 1980, Pl. 80.4-5  
 Class 170 Briend & Humbert 1980, Pl. 11  
 Class 172 Briend & Humbert 1980, Pl. 80.11  
 Class 188 Briend & Humbert 1980, Pl. 79.3  
**Stratum 11/10 (French)**  
 Class 8d Briend & Humbert 1980, Pl. 81.8  
 Class 38a Briend & Humbert 1980, Pl. 81.11  
 Class 38b Briend & Humbert 1980, Pl. 81.12  
 Class 54 Briend & Humbert 1980, Pl. 81.9-10, 11c  
 Class 104 Briend & Humbert 1980, Pl. 81.6-7  
 Class 134a Briend & Humbert 1980, Pl. 81.15  
 Class 173a Briend & Humbert 1980, Pl. 81.16  
 Class 188 Briend & Humbert 1980, Pl. 81.20  
**Stratum I (British)**  
 Class 5 Seton-Williams 1980, Pl. 108.7  
 Class 9a Seton-Williams 1980, Pl. 108.8, 10

Class 25 Seton-Williams 1980, Pl. 108.11-12  
Class 100b Seton-Williams 1980, Pl. 108.4, 6  
Class 115 Seton-Williams 1980, Pl. 108.5  
Class 141a Seton-Williams 1980, Pl. 108.3  
**Stratum II/III (British)**  
Class 5 Seton-Williams 1980, Pl. 109.5  
Class 8c Seton-Williams 1980, Pl. 109.14  
Class 10 Seton-Williams 1980, Pl. 109.3  
Class 88 Seton-Williams 1980, Pl. 109.16  
Class 102a Seton-Williams 1980, Pl. 109.17

Class 134a Seton-Williams 1980, Pl. 109.12  
Class 144b Seton-Williams 1980, Pl. 109.1  
Class 171 Seton-Williams 1980, Pl. 109.2  
Class 172 Seton-Williams 1980, Pl. 109.13  
**Stratum IV/V (British)**  
Class 8d Seton-Williams 1980, Pl. 110.1-5  
Class 15 Seton-Williams 1980, Pl. 110.13  
Class 100b Seton-Williams 1980, Pl. 110.7  
Class 173a Seton-Williams 1980, Pl. 110.11-12

## C.27 Khalde

### **Tomb 1**

Class 86 Saidah 1966, No. 2  
Class 162 Saidah 1966, No. 1

### **Tomb 2**

Class 21 Saidah 1966, No. 5  
Class 102b Saidah 1966, No. 4  
Class 162 Saidah 1966, No. 6

### **Tomb 3**

Class 42 Saidah 1966, No. 7  
Class 82a Saidah 1966, No. 9  
Class 85a Saidah 1966, No. 11  
Class 88 Saidah 1966, No. 12  
Class 145b Saidah 1966, No. 8  
Class 156 Saidah 1966, No. 10

### **Tomb 4**

Class 78 Saidah 1966, No. 13  
Class 102a Saidah 1966, No. 15  
Class 103b Saidah 1966, No. 14  
Class 172 Saidah 1966, No. 16

### **Tomb 121**

Class 42 Saidah 1966, Nos 17, 20  
Class 47 Saidah 1966, No. 18  
Class 82e Saidah 1966, No. 25  
Class 90a Saidah 1966, Nos 23-24  
Class 100b Saidah 1966, Nos 31-34  
Class 144b Saidah 1966, No. 22  
Class 145a Saidah 1966, No. 19  
Class 155 Saidah 1966, No. 28  
Class 157 Saidah 1966, No. 27  
Class 162 Saidah 1966, No. 21  
Class 179 Saidah 1966, Nos 26, 29-30

### **Tomb 165**

Class 103a Saidah 1966, No. 48

### **Tomb 166**

Class 78 Saidah 1966, No. 52  
Class 102a Saidah 1966, Nos 50-51  
Class 107b Saidah 1966, No. 49

### **Tomb 167**

Class 78 Saidah 1966, Nos 55-56  
Class 102a Saidah 1966, No. 54  
Class 107b Saidah 1966, No. 57  
Class 111 Saidah 1966, No. 58  
Class 134a Saidah 1966, No. 59  
Class 152 Saidah 1966, No. 60  
Class 160b Saidah 1966, No. 61

### **Cemetery Phase IV**

Class 42 Saidah 1966, No. 47  
Class 73 Saidah 1966, No. 41  
Class 157 Saidah 1966, No. 42  
Class 160b Saidah 1966, No. 43  
Class 162 Saidah 1966, No. 45  
Class 170 Saidah 1966, No. 44  
Class 179 Saidah 1971, Fig. 1f

### **Unstratified**

Class 21 Chehab 1983, Pl. XX.1  
Class 24b see Lehmann 1996, 434 (Form 385)  
Class 26 see Lehmann 1996, 436 (Form 390)  
Class 42 Chehab 1983, Pl. XX.1  
Class 77 Culican 1982, Pl. 5a-b  
Class 82a Culican 1982, Pl. 5c  
Class 82b Culican 1982, Pl. 5d  
Class 85b Saidah 1971, 197 1d-e  
Class 88 Chehab 1983, Pl. XX.1  
Class 102b Chehab 1983, Pl. XX.1  
Class 107b Culican 1982, Pl. 1e-f  
Class 111 Chehab 1983, Pl. XXI.4  
Class 112 Culican 1982, Pl. 3b

## C.28 Khirbet Silm

Class 8e S. V. Chapman 1972, Fig. 22.83  
Class 15 S. V. Chapman 1972, Fig. 17.79  
Class 42 S. V. Chapman 1972, Figs 18.80  
Class 42 S. V. Chapman 1972, Fig. 19.81  
Class 65 S. V. Chapman 1972, Fig. 28.156  
Class 73 S. V. Chapman 1972, Fig. 9.13-14  
Class 73 S. V. Chapman 1972, Fig. 10.18  
Class 74 S. V. Chapman 1972, Fig. 9.12  
Class 74 S. V. Chapman 1972, Fig. 11.19

Class 77 S. V. Chapman 1972, Fig. 4.51-52  
Class 77 S. V. Chapman 1972, Fig. 5.57, 59  
Class 77 S. V. Chapman 1972, Fig. 31.163  
Class 78 S. V. Chapman 1972, Fig. 3.46  
Class 79 S. V. Chapman 1972, Fig. 17.75, 77  
Class 79 S. V. Chapman 1972, Fig. 30.159  
Class 80 S. V. Chapman 1972, Fig. 31.164-165, 167  
Class 81 S. V. Chapman 1972, Fig. 10.15

Class 82a S. V. Chapman 1972, Fig. 26.139, 143-144  
 Class 82b S. V. Chapman 1972, Figs 10.16-17; 11.21, 23-24; 27.149  
 Class 82c S. V. Chapman 1972, Fig. 26.146  
 Class 82c S. V. Chapman 1972, Fig. 27.147-148  
 Class 82e S. V. Chapman 1972, Fig. 26.145  
 Class 84 S. V. Chapman 1972, Fig. 31.161-162  
 Class 85b S. V. Chapman 1972, Fig. 6.33, 40-41  
 Class 88 S. V. Chapman 1972, Fig. 6.42  
 Class 88 S. V. Chapman 1972, Fig. 7.25  
 Class 88 S. V. Chapman 1972, Fig. 8.43-45  
 Class 88 S. V. Chapman 1972, Fig. 27.151  
 Class 88 Culican 1982, Fig. 4d  
 Class 90a S. V. Chapman 1972, Fig. 29.157  
 Class 90b S. V. Chapman 1972, Fig. 29.158  
 Class 97 S. V. Chapman 1972, Fig. 7.32  
 Class 100b S. V. Chapman 1972, Fig. 23.86, 89, 92

Class 100b S. V. Chapman 1972, Fig. 28.155  
 Class 102a S. V. Chapman 1972, Fig. 13.63, 73  
 Class 102a S. V. Chapman 1972, Fig. 12.62  
 Class 102c S. V. Chapman 1972, Fig. 4.50  
 Class 103a S. V. Chapman 1972, Fig. 22.84  
 Class 106 S. V. Chapman 1972, Fig. 1.1, 3  
 Class 106 S. V. Chapman 1972, Fig. 2.9  
 Class 107b S. V. Chapman 1972, Fig. 2.4, 6-7  
 Class 107b Culican 1982, Pl. 8e  
 Class 127 S. V. Chapman 1972, Fig. 24.106  
 Class 132 S. V. Chapman 1972, Fig. 25.131  
 Class 134b S. V. Chapman 1972, Fig. 24.107  
 Class 134b S. V. Chapman 1972, Fig. 25.130  
 Class 143 S. V. Chapman 1972, Fig. 24.105  
 Class 143 S. V. Chapman 1972, Fig. 25.138  
 Class 160a S. V. Chapman 1972, Fig. 28.152  
 Class 162 S. V. Chapman 1972, Fig. 24.114, 117  
 Class 166 S. V. Chapman 1972, Fig. 28.154  
 Class 179 S. V. Chapman 1972, Fig. 24.108, 110  
 Class 179 S. V. Chapman 1972, Fig. 25.127, 132, 135

## C.29 Mastuma, Tell (Syria)

### Central Area level I

Class 1a Egami & Masuda 1982, Pl. 6.6  
 Class 1a Egami 1983, Fig. 4.1  
 Class 1a Wakita et al. 2000, Fig. 10.8  
 Class 1b Wakita et al. 2000, Fig. 10.5, 7  
 Class 1d Wakita et al. 2000, Fig. 10.10  
 Class 2 Wakita et al. 2000, Fig. 10.6  
 Class 5 Wakita et al. 2000, Fig. 10.9  
 Class 57b Wakita et al. 2000, Fig. 10.1, 3  
 Class 134a Egami & Masuda 1982, Pl. 6.2  
 Class 134d Egami & Masuda 1982, Pl. 6.3  
 Class 167 Egami et al. 1984, Fig. 6.10  
 Class 192 Egami & Masuda 1982, Pl. 6.1

### Central Area level I-1

Class 1a Egami & Masuda 1984, Pl. 7.2  
 Class 12a Wakita et al. 1995, Fig. 7.8  
 Class 37b Egami & Masuda 1984, Pl. 8.10-11, 16-18

Class 37b Egami 1988, Pl. 18.J1-J2  
 Class 37b Wakita et al. 1995, Fig. 14.1  
 Class 37b Wakita et al. 1995, Pls 2.1; 2.2  
 Class 84 Wakita et al. 2000, Fig. 9.1  
 Class 87 Wakita et al. 2000, Fig. 9.2  
 Class 101 Wakita et al. 1995, Fig. 7.3  
 Class 152 Wakita et al. 1995, Fig. 7.4  
 Class 176 Egami & Masuda 1984, Pl. 6.1

### Central Area level I-2

Class 1a Egami 1988, Pl. 18.5  
 Class 1b Egami & Masuda 1984, Pl. 7.1, 4  
 Class 1d Egami 1988, Pl. 18.2  
 Class 37b Egami & Masuda 1984, Pl. 7.10  
 Class 37b Egami & Masuda 1984, Pl. 8.1, 5-8, 12, 19  
 Class 37b Egami 1988, Pl. 19.J3-J10  
 Class 37b Wakita et al. 1995, Fig. 7.10  
 Class 40a Egami 1988, Pl. 18.1

Class 57b Egami & Masuda 1984, Pl. 7.6  
 Class 57b Egami 1988, Pl. 17.9  
 Class 59 Egami & Masuda 1984, Pl. 7.5, 8  
 Class 68 Wakita et al. 1995, Fig. 7.2  
 Class 105 Egami 1988, Pl. 17.12-13  
 Class 105 Wakita et al. 1995, Fig. 7.7  
 Class 108 Egami 1988, Pl. 18.4  
 Class 134a Egami 1988, Pl. 17.7-8  
 Class 134d Egami & Masuda 1984, Pl. 6.5-6  
 Class 141c Egami 1988, Pl. 17.6  
 Class 141d Egami & Masuda 1984, Pl. 6.8-9  
 Class 143 Egami & Masuda 1984, Pl. 6.4  
 Class 166 Egami & Masuda 1984, Pl. 6.11  
 Class 168 Wakita et al. 1995, Fig. 7.5  
 Class 170 Egami 1988, Pl. 17.5  
 Class 175 Egami & Masuda 1984, Pl. 6.3  
 Class 176 Egami & Masuda 1984, Pl. 6.2  
 Class 176 Egami 1988, Pl. 17.2-3  
 Class 182a Egami & Masuda 1984, Pl. 6.10  
 Class 184 Egami 1988, Pl. 17.1  
 Class 184 Wakita et al. 1995, Fig. 7.6  
 Class 191 Wakita et al. 2000, Fig. 9.5

### Central Area level I-3

Class 1b Egami & Masuda 1984, Pl. 7.3  
 Class 37a Egami & Masuda 1984, Pl. 8.3, 9  
 Class 37b Egami & Masuda 1984, Pl. 8.2, 4, 13-14

Class 37b Wakita et al. 1995, Fig. 7.9  
 Class 170 Egami & Masuda 1984, Pl. 6.7

### South Area

Class 1a Wada 1994, Fig. 2.6, 8  
 Class 2 Wada 1994, Fig. 2.7  
 Class 37a Wada 1994, Fig. 4.6, 17-19  
 Class 37b Wada 1994, Fig. 4.8-13  
 Class 37b Wada 1994, Fig. 5.1-10, 21-22  
 Class 40a Wada 1994, Fig. 2.2

Class 40c Wada 1994, Fig. 2.3  
 Class 57b Wada 1994, Fig. 3.13  
 Class 68 Wada 1994, Fig. 3.11-12  
 Class 92 Wada 1994, Fig. 3.4  
 Class 105 Wada 1994, Fig. 3.5  
 Class 111 Wada 1994, Fig. 6.2  
 Class 134d Wada 1994, Fig. 1.6  
 Class 134e Wada 1994, Fig. 1.13  
 Class 141d Wada 1994, Fig. 1.15  
 Class 160b Wada 1994, Fig. 1.10

Class 162 Wada 1994, Fig. 1.16  
 Class 168 Wada 1994, Fig. 1.1-2  
 Class 172 Wada 1994, Fig. 1.9  
 Class 174 Wada 1994, Fig. 1.7  
 Class 175 Wada 1994, Fig. 1.14  
 Class 176 Wada 1994, Fig. 1.3  
 Class 177 Wada 1994, Fig. 2.14  
 Class 182a Wada 1994, Fig. 1.12  
 Class 184 Wada 1994, Fig. 1.4-5

## C.30 Megiddo

### Stratum I

Class 3 Lamon & Shipton 1939, Fig. 39.9  
 Class 7a Lamon & Shipton 1939, Fig. 39  
 Class 9a Lamon & Shipton 1939, Fig. 9.33  
 Class 12c Lamon & Shipton 1939, Fig. 37. 8,  
 10, 12  
 Class 15 Lamon & Shipton 1939, Fig. 34.1-4,  
 7  
 Class 23 Lamon & Shipton 1939, Fig. 14.73  
 Class 24a Lamon & Shipton 1939, Fig. 16.79-  
 80  
 Class 24b Lamon & Shipton 1939, Fig. 17.83  
 Class 27 Lamon & Shipton 1939, Fig. 12.63-  
 64  
 Class 29 Lamon & Shipton 1939, Fig. 9.23  
 Class 29 Lamon & Shipton 1939, Fig. 14.71  
 Class 49 Lamon & Shipton 1939, Fig. 27.83-  
 84  
 Class 67 Lamon & Shipton 1939, Fig. 12.62  
 Class 68 Lamon & Shipton 1939, Fig. 2.68  
 Class 93a Lamon & Shipton 1939, Fig. 1.8  
 Class 98 Lamon & Shipton 1939, Fig. 1.3-5  
 Class 100b Lamon & Shipton 1939, Fig. 1.11,  
 13  
 Class 100c Lamon & Shipton 1939, Fig. 2.49-  
 51  
 Class 119 Lamon & Shipton 1939, Fig. 9.4-5  
 Class 130 Lamon & Shipton 1939, Fig. 33.3  
 Class 134b Lamon & Shipton 1939, Fig. 24.29  
 Class 139 Lamon & Shipton 1939, Fig. 23.6, 8  
 Class 141a Lamon & Shipton 1939, Fig. 23.7  
 Class 141c Lamon & Shipton 1939, Fig.  
 25.61-62, 64  
 Class 145a Lamon & Shipton 1939, Fig. 23.4  
 Class 152 Lamon & Shipton 1939, Fig. 24.28  
 Class 193 Lamon & Shipton 1939, Fig. 23.13-  
 14, 16

### Stratum II/III

Class 3 Lamon & Shipton 1939, Fig. 39.9  
 Class 4b Lamon & Shipton 1939, Fig. 10.38  
 Class 6 Lamon & Shipton 1939, Fig. 5.112,  
 118-119  
 Class 7a Lamon & Shipton 1939, Fig. 39  
 Class 10 Lamon & Shipton 1939, Fig. 24.26-  
 27  
 Class 11b Lamon & Shipton 1939, Fig. 35.2-3

Class 12b Lamon & Shipton 1939, Fig. 37.13-  
 15  
 Class 12c Lamon & Shipton 1939, Fig. 37.6-8,  
 10, 12  
 Class 12d Lamon & Shipton 1939, Fig. 37.16  
 Class 13 Lamon & Shipton 1939, Fig. 38.3  
 Class 14 Lamon & Shipton 1939, Fig. 23.20-  
 23  
 Class 15 Lamon & Shipton 1939, Fig. 34.2-3,  
 5-7, 9-10, 12  
 Class 17 Lamon & Shipton 1939, Fig. 15.76-  
 77  
 Class 24a Lamon & Shipton 1939, Fig. 16.79-  
 80  
 Class 24b Lamon & Shipton 1939, Fig. 14.72  
 Class 28 Lamon & Shipton 1939, Fig. 16.82  
 Class 29 Lamon & Shipton 1939, Fig. 9.24  
 Class 29 Lamon & Shipton 1939, Fig. 14.71  
 Class 34 Lamon & Shipton 1939, Fig. 17.86  
 Class 44 Lamon & Shipton 1939, Fig. 9.29-30  
 Class 48a Lamon & Shipton 1939, Fig. 17.84  
 Class 48b Lamon & Shipton 1939, Fig. 18.90  
 Class 48b Lamon & Shipton 1939, Fig. 28.88  
 Class 49 Lamon & Shipton 1939, Fig. 26.73  
 Class 49 Lamon & Shipton 1939, Fig. 27.83-  
 84, 86  
 Class 57b Lamon & Shipton 1939, Fig. 10.37  
 Class 64 Lamon & Shipton 1939, Fig. 11.54,  
 57  
 Class 67 Lamon & Shipton 1939, Fig. 12.62  
 Class 68 Lamon & Shipton 1939, Fig. 2.68  
 Class 70 Lamon & Shipton 1939, Fig. 2.69  
 Class 82a Lamon & Shipton 1939, Fig. 3.83-  
 85  
 Class 82e Lamon & Shipton 1939, Fig. 3.86,  
 89  
 Class 84 Lamon & Shipton 1939, Fig. 5.123  
 Class 84 Lamon & Shipton 1939, Fig. 17.87  
 Class 85b Lamon & Shipton 1939, Fig. 3.79  
 Class 87 Lamon & Shipton 1939, Fig. 3.78  
 Class 88 Lamon & Shipton 1939, Fig. 4.93  
 Class 91 Lamon & Shipton 1939, Fig. 2.67  
 Class 100a Lamon & Shipton 1939, Fig. 2.71  
 Class 100b Lamon & Shipton 1939, Fig. 1.10-  
 11, 13  
 Class 100c Lamon & Shipton 1939, Fig. 1.41-  
 42

Class 100c Lamon & Shipton 1939, Fig. 2.49-51  
 Class 100e Lamon & Shipton 1939, Fig. 1.23, 40  
 Class 103a Lamon & Shipton 1939, Fig. 9.35  
 Class 105 Lamon & Shipton 1939, Fig. 1.34-35  
 Class 119 Lamon & Shipton 1939, Fig. 9.6-7  
 Class 121c Lamon & Shipton 1939, Fig. 9.12  
 Class 130 Lamon & Shipton 1939, Fig. 33.8-9  
 Class 134a Lamon & Shipton 1939, Fig. 24.30  
 Class 134b Lamon & Shipton 1939, Fig. 24.29  
 Class 135 Lamon & Shipton 1939, Fig. 27.85  
 Class 139 Lamon & Shipton 1939, Fig. 23.6, 8-9, 12  
 Class 139 Lamon & Shipton 1939, Fig. 25.66  
 Class 141a Lamon & Shipton 1939, Fig. 23.7  
 Class 141c Lamon & Shipton 1939, Fig. 23.18  
 Class 141c Lamon & Shipton 1939, Fig. 25.61-64  
 Class 144b Lamon & Shipton 1939, Fig. 24.34-35  
 Class 145a Lamon & Shipton 1939, Fig. 23.4  
 Class 152 Lamon & Shipton 1939, Fig. 24.28, 48  
 Class 155 Lamon & Shipton 1939, Fig. 24.56  
 Class 155 Lamon & Shipton 1939, Fig. 25.57  
 Class 157 Lamon & Shipton 1939, Fig. 24.50-51, 53-54, 59  
 Class 158a Lamon & Shipton 1939, Fig. 24.44-45  
 Class 159 Lamon & Shipton 1939, Fig. 25.65  
 Class 160a Lamon & Shipton 1939, Fig. 24.55  
 Class 162 Lamon & Shipton 1939, Fig. 24.46  
 Class 163 Lamon & Shipton 1939, Fig. 29.107  
 Class 167 Lamon & Shipton 1939, Fig. 25.69  
 Class 168 Lamon & Shipton 1939, Fig. 24.40-43  
 Class 172 Lamon & Shipton 1939, Fig. 23.25  
 Class 193 Lamon & Shipton 1939, Fig. 23.13-17  
**Stratum IVA**  
 Class 12b Lamon & Shipton 1939, Fig. 37.10  
 Class 15 Lamon & Shipton 1939, Fig. 34.13-15  
 Class 17 Lamon & Shipton 1939, Fig. 15.76  
 Class 19 Lamon & Shipton 1939, Fig. 11.48-49  
 Class 24b Lamon & Shipton 1939, Figs 14.72; 16.81  
 Class 38a Lamon & Shipton 1939, Fig. 28.89  
 Class 48a Lamon & Shipton 1939, Fig. 17.84  
 Class 48b Lamon & Shipton 1939, Fig. 18.89  
 Class 64 Lamon & Shipton 1939, Fig. 11.54, 57  
 Class 82a Lamon & Shipton 1939, Fig. 3.83-85  
 Class 82e Lamon & Shipton 1939, Fig. 3.86, 89

Class 100b Lamon & Shipton 1939, Figs 1.16; 2.47  
 Class 100c Lamon & Shipton 1939, Fig. 2.50  
 Class 100c Lamon & Shipton 1939, Fig. 11.53  
 Class 134b Lamon & Shipton 1939, Fig. 24.29  
 Class 134b Lamon & Shipton 1939, Fig. 26.74  
 Class 134b Lamon & Shipton 1939, Fig. 28.101  
 Class 141c Lamon & Shipton 1939, Fig. 25.62-63  
 Class 152 Lamon & Shipton 1939, Fig. 24.48  
 Class 152 Lamon & Shipton 1939, Fig. 28.99  
 Class 157 Lamon & Shipton 1939, Figs 24.54; 25.59  
 Class 161 Lamon & Shipton 1939, Fig. 25.67  
 Class 162 Lamon & Shipton 1939, Fig. 25.68  
 Class 164 Lamon & Shipton 1939, Pl. 26.75  
 Class 165a Lamon & Shipton 1939, Fig. 26.76  
 Class 167 Lamon & Shipton 1939, Fig. 25.69  
 Class 168 Lamon & Shipton 1939, Fig. 24.40, 43  
 Class 193 Lamon & Shipton 1939, Fig. 26.81  
**Stratum VA-IVB**  
 Class 4c Lamon & Shipton 1939, Fig. 7.169  
 Class 6 Lamon & Shipton 1939, Figs 5.112, 119; 7.167, 170  
 Class 6 Loud 1948, Fig. 89.3  
 Class 8d Loud 1948, Fig. 90.5-6  
 Class 12b Lamon & Shipton 1939, Fig. 38.19  
 Class 13 Lamon & Shipton 1939, Fig. 38.6  
 Class 14 Lamon & Shipton 1939, Fig. 23.20  
 Class 15 Loud 1948, Fig. 90.9  
 Class 16a Lamon & Shipton 1939, Fig. 20.122, 124  
 Class 16c Lamon & Shipton 1939, Fig. 21.123  
 Class 18 Lamon & Shipton 1939, Fig. 20.119  
 Class 19 Lamon & Shipton 1939, Fig. 20.120-121  
 Class 22 Lamon & Shipton 1939, Fig. 22.130  
 Class 29 Lamon & Shipton 1939, Fig. 19.114  
 Class 29 Lamon & Shipton 1939, Fig. 22.131  
 Class 38a Lamon & Shipton 1939, Fig. 31.154  
 Class 38b Loud 1948, Fig. 89.14  
 Class 40a Lamon & Shipton 1939, Fig. 29.112  
 Class 42 Lamon & Shipton 1939, Fig. 22.127  
 Class 42 Loud 1948, Fig. 89.7  
 Class 49 Lamon & Shipton 1939, Fig. 29.112  
 Class 55 Lamon & Shipton 1939, Fig. 29.110  
 Class 57b Lamon & Shipton 1939, Fig. 19.105  
 Class 57b Lamon & Shipton 1939, Fig. 22.128  
 Class 57b Loud 1948, Fig. 89.1-2  
 Class 64 Lamon & Shipton 1939, Fig. 20.116  
 Class 66 Lamon & Shipton 1939, Fig. 11.52  
 Class 66 Lamon & Shipton 1939, Fig. 19.106  
 Class 71a Lamon & Shipton 1939, Figs 6.154, 159; 8.178  
 Class 71a Loud 1948, Fig. 88.3-4  
 Class 75 Lamon & Shipton 1939, Fig. 6.144-145

- Class 76 Lamon & Shipton 1939, Fig. 7.171, 173
- Class 77 Loud 1948, Fig. 88.15
- Class 78 Lamon & Shipton 1939, Fig. 36.12
- Class 80 Loud 1948, Fig. 90.7
- Class 81 Lamon & Shipton 1939, Fig. 8.176
- Class 81 Loud 1948, Fig. 88.6-9
- Class 82c Loud 1948, Fig. 88.2
- Class 82d Loud 1948, Fig. 88.1
- Class 82e Lamon & Shipton 1939, Fig. 6.156
- Class 84 Lamon & Shipton 1939, Fig. 5.123
- Class 84 Lamon & Shipton 1939, Fig. 17.87
- Class 84 Loud 1948, Fig. 89.6
- Class 88 Lamon & Shipton 1939, Figs 6.146-147; 7.174; 8.177
- Class 90a Lamon & Shipton 1939, Fig. 7.172
- Class 100a Loud 1948, Fig. 88.13
- Class 100b Lamon & Shipton 1939, Fig. 2.46-47
- Class 100b Lamon & Shipton 1939, Fig. 5.120-121, 141-142
- Class 100b Loud 1948, Fig. 88.12
- Class 100c Lamon & Shipton 1939, Fig. 2.52
- Class 100c Loud 1948, Fig. 88.11
- Class 100d Lamon & Shipton 1939, Fig. 5.124-126, 128
- Class 100d Loud 1948, Fig. 88.10
- Class 100e Lamon & Shipton 1939, Fig. 5.134-135
- Class 100e Loud 1948, Fig. 88.16
- Class 102d Lamon & Shipton 1939, Fig. 22.129
- Class 103a Lamon & Shipton 1939, Fig. 19.95
- Class 103b Loud 1948, Fig. 89.5
- Class 109 Loud 1948, Fig. 88.19
- Class 110 Lamon & Shipton 1939, Fig. 5.117
- Class 111 Lamon & Shipton 1939, Fig. 8.180
- Class 120 Loud 1948, Fig. 88.18
- Class 123 Loud 1948, Fig. 88.17
- Class 124 Lamon & Shipton 1939, Fig. 8.179
- Class 129 Lamon & Shipton 1939, Fig. 8.175
- Class 131b Loud 1948, Fig. 90.8
- Class 133 Lamon & Shipton 1939, Fig. 38.1
- Class 133 Loud 1948, Fig. 90.9
- Class 134a Lamon & Shipton 1939, Fig. 30.116
- Class 134a Loud 1948, Fig. 89.9
- Class 134b Lamon & Shipton 1939, Fig. 24.39
- Class 134b Lamon & Shipton 1939, Fig. 30.121-122, 130
- Class 152 Lamon & Shipton 1939, Fig. 28.97-99, 106
- Class 152 Lamon & Shipton 1939, Fig. 30.118, 120, 126-127, 132
- Class 152 Loud 1948, Fig. 89.10
- Class 155 Lamon & Shipton 1939, Fig. 28.93a
- Class 157 Lamon & Shipton 1939, Fig. 28.93b
- Class 157 Lamon & Shipton 1939, Fig. 31.143
- Class 157 Loud 1948, Fig. 89.11
- Class 157 Loud 1948, Fig. 90.4
- Class 160a Lamon & Shipton 1939, Fig. 28.95
- Class 160a Lamon & Shipton 1939, Fig. 30.123
- Class 161 Lamon & Shipton 1939, Fig. 30.124
- Class 161 Loud 1948, Fig. 89.12
- Class 162 Lamon & Shipton 1939, Fig. 30.140
- Class 162 Loud 1948, Fig. 90.1
- Class 163 Loud 1948, Fig. 90.2-3
- Class 172 Loud 1948, Fig. 89.13
- Class 173a Lamon & Shipton 1939, Fig. 30.131
- Class 191 Lamon & Shipton 1939, Fig. 32.169
- Stratum VB**
- Class 4b Lamon & Shipton 1939, Fig. 40.17, 21
- Class 6 Lamon & Shipton 1939, Figs 5.119; 7.167; 20.115
- Class 8b Lamon & Shipton 1939, Fig. 40.20
- Class 8c Lamon & Shipton 1939, Fig. 40.19
- Class 10 Lamon & Shipton 1939, Fig. 30.136
- Class 10 Lamon & Shipton 1939, Fig. 31.152
- Class 12a Lamon & Shipton 1939, Fig. 37.17
- Class 12b Lamon & Shipton 1939, Fig. 38.18-19
- Class 13 Lamon & Shipton 1939, Fig. 38.4-6
- Class 14 Lamon & Shipton 1939, Fig. 31.146-147
- Class 16a Lamon & Shipton 1939, Fig. 21.122-123
- Class 18 Lamon & Shipton 1939, Fig. 20.119
- Class 19 Lamon & Shipton 1939, Fig. 20.120
- Class 22 Lamon & Shipton 1939, Fig. 20.121
- Class 34 Lamon & Shipton 1939, Fig. 21.126
- Class 38a Lamon & Shipton 1939, Figs 29.110; 31.153-154; 32.161-163
- Class 64 Lamon & Shipton 1939, Fig. 20.116
- Class 66 Lamon & Shipton 1939, Fig. 19.111
- Class 71a Lamon & Shipton 1939, Fig. 6.154, 159-160
- Class 75 Lamon & Shipton 1939, Fig. 6.155
- Class 77 Lamon & Shipton 1939, Fig. 36.13
- Class 82a Lamon & Shipton 1939, Fig. 6.148
- Class 82e Lamon & Shipton 1939, Fig. 6.156
- Class 84 Lamon & Shipton 1939, Fig. 5.123
- Class 84 Lamon & Shipton 1939, Fig. 17.87
- Class 88 Lamon & Shipton 1939, Fig. 6.146-147
- Class 100b Lamon & Shipton 1939, Fig. 5.120-121, 140-142
- Class 100b Loud 1948, Fig. 87.14, 19
- Class 100d Lamon & Shipton 1939, Fig. 5.130, 132, 137
- Class 100d Loud 1948, Fig. 87.16-18
- Class 100e Loud 1948, Fig. 87.15
- Class 102b Loud 1948, Fig. 87.23
- Class 103a Lamon & Shipton 1939, Fig. 19.96-97, 99
- Class 103a Loud 1948, Fig. 87.20
- Class 106 Lamon & Shipton 1939, Fig. 6.153

- Class 108 Lamon & Shipton 1939, Figs 23.24;  
31.148-149
- Class 108 Loud 1948, Fig. 87.22
- Class 124 Lamon & Shipton 1939, Fig. 7.166
- Class 129 Loud 1948, Fig. 87.24
- Class 131a Lamon & Shipton 1939, Fig. 33.19
- Class 131b Lamon & Shipton 1939, Fig.  
33.18, 20
- Class 134a Lamon & Shipton 1939, Fig.  
30.106, 114-116, 130
- Class 134b Lamon & Shipton 1939, Figs  
28.101; 30.119, 121-122, 129
- Class 152 Lamon & Shipton 1939, Fig. 28.97-  
99, 102
- Class 152 Loud 1948, Fig. 87.21
- Class 152 Lamon & Shipton 1939, Fig.  
30.118, 120, 126-127, 132
- Class 155 Lamon & Shipton 1939, Fig. 28.93a
- Class 157 Lamon & Shipton 1939, Fig. 30.134
- Class 157 Lamon & Shipton 1939, Fig. 31.143
- Class 160a Lamon & Shipton 1939, Fig.  
28.105
- Class 162 Lamon & Shipton 1939, Figs 28.93b
- Class 162 Lamon & Shipton 1939, Figs  
30.117, 139; 31.142
- Class 172 Lamon & Shipton 1939, Fig. 31.144
- Class 173a Lamon & Shipton 1939, Fig.  
30.131, 133
- Class 188 Lamon & Shipton 1939, Fig. 30.141
- Stratum VI**
- Class 16a Loud 1948, Fig. 83.8
- Class 16b Loud 1948, Fig. 83.9
- Class 111 Harrison 2004b, Pl. 22.8-10
- Stratum VIA**
- Class 4c Loud 1948, Fig. 75.18
- Class 4c Loud 1948, Fig. 77.5-6
- Class 4c Harrison 2004b, Pl. 9.2, 6, 9, 14
- Class 6 Loud 1948, Fig. 75.17
- Class 8c Harrison 2004b, Pl. 9.1, 7
- Class 8d Loud 1948, Fig. 79.6
- Class 8d Harrison 2004b, Pl. 9.3
- Class 8e Harrison 2004b, Pl. 9.4
- Class 10 Harrison 2004b, Pl. 4.10, 12
- Class 12a Loud 1948, Fig. 79.7, 9
- Class 12a Harrison 2004b, Pl. 20.1, 4
- Class 12b Loud 1948, Fig. 79.8
- Class 12b Harrison 2004b, Pl. 20.7
- Class 12c Harrison 2004b, Pl. 20.6
- Class 13 Loud 1948, Fig. 79.12
- Class 13 Harrison 2004b, Pl. 20.9-10
- Class 15 Loud 1948, Fig. 80.9
- Class 16a Loud 1948, Figs 76.2-4; 77.2
- Class 16a Harrison 2004b, Pl. 10.3
- Class 16b Harrison 2004b, Pl. 10.2
- Class 16b Harrison 2004b, Pl. 11.2
- Class 21 Loud 1948, Fig. 77.4
- Class 21 Harrison 2004b, Pl. 13.2, 7
- Class 22 Loud 1948, Fig. 77.3
- Class 22 Harrison 2004b, Pl. 13.5
- Class 26 Harrison 2004b, Pl. 11.3
- Class 34 Harrison 2004b, Pl. 12.1-2
- Class 38a Loud 1948, Fig. 78.14-15
- Class 38a Harrison 2004b, Pl. 5.11, 13, 15
- Class 40a Loud 1948, Fig. 78.17-19
- Class 40a Loud 1948, Fig. 79.2
- Class 40b Loud 1948, Fig. 79.3
- Class 49 Loud 1948, Fig. 79.5
- Class 54 Loud 1948, Fig. 79.1
- Class 54 Harrison 2004b, Pl. 6.1
- Class 66 Loud 1948, Fig. 77.12-13
- Class 66 Harrison 2004b, Pl. 14.7-8, 10
- Class 71a Loud 1948, Fig. 75.1-5, 11
- Class 71a Harrison 2004b, Pl. 15.13-14
- Class 71b Harrison 2004b, Pl. 16.13
- Class 76 Loud 1948, Fig. 75.6-10, 12-13
- Class 76 Harrison 2004b, Pl. 15.12, 15, 17
- Class 76 Harrison 2004b, Pl. 16.7, 10, 12
- Class 78 Loud 1948, Fig. 80.1-4
- Class 78 Harrison 2004b, Pl. 15.9
- Class 78 Harrison 2004b, Pl. 18.3, 5-6
- Class 100a Harrison 2004b, Pl. 15.18-19
- Class 100b Loud 1948, Fig. 75.14-16
- Class 100b Harrison 2004b, Pl. 15.2, 4-6, 8
- Class 102a Loud 1948, Fig. 80.5
- Class 102a Harrison 2004b, Pl. 18.8, 10, 12
- Class 102a Harrison 2004b, Pl. 19.1
- Class 102d Loud 1948, Fig. 80.6
- Class 102d Harrison 2004b, Pl. 19.2
- Class 102e Loud 1948, Fig. 80.7
- Class 102e Harrison 2004b, Pl. 19.6
- Class 103a Loud 1948, Fig. 77.9-10
- Class 103a Harrison 2004b, Pl. 7.13
- Class 103b Loud 1948, Fig. 77.7
- Class 103b Harrison 2004b, Pl. 7.7-8, 11
- Class 104 Harrison 2004b, Pl. 19.4
- Class 105 Loud 1948, Fig. 75.19
- Class 106 Loud 1948, Fig. 76.1
- Class 106 Harrison 2004b, Pl. 17.4
- Class 107b Loud 1948, Fig. 75.20-23
- Class 108 Loud 1948, Fig. 78.16
- Class 108 Harrison 2004b, Pl. 20.11-13
- Class 109 Harrison 2004b, Pl. 17.3, 6-7
- Class 116 Harrison 2004b, Pl. 15.20
- Class 124 Harrison 2004b, Pl. 9.8
- Class 129 Loud 1948, Fig. 79.11
- Class 129 Harrison 2004b, Pl. 8.9-11, 13
- Class 131a Loud 1948, Fig. 79.7
- Class 131a Harrison 2004b, Pl. 8.1-3
- Class 131b Harrison 2004b, Pl. 8.4-5
- Class 131c Harrison 2004b, Pl. 8.6-7
- Class 133 Loud 1948, Fig. 80.8
- Class 134a Loud 1948, Figs 78.3-5, 12; 79.10
- Class 134a Harrison 2004b, Pls 4.11; 5.8-9;  
7.2
- Class 134b Harrison 2004b, Pl. 7.3
- Class 152 Harrison 2004b, Pl. 5.3
- Class 154 Loud 1948, Fig. 78.6-7
- Class 158a Loud 1948, Fig. 78.1, 10
- Class 160a Loud 1948, Fig. 78.2
- Class 160a Loud 1948, Fig. 79.4

Class 160a Harrison 2004b, Pl. 5.1  
Class 161 Loud 1948, Fig. 78.11  
Class 162 Loud 1948, Fig. 78.8-9  
Class 162 Harrison 2004b, Pl. 4.4  
Class 184 Loud 1948, Fig. 78.13  
Class 188 Loud 1948, Fig. 78.20

#### **Stratum VIB**

Class 12b Loud 1948, Fig. 74.13  
Class 16a Loud 1948, Fig. 73.6-8, 10  
Class 40a Harrison 2004b, Pl. 3.1  
Class 54 Loud 1948, Fig. 74.12  
Class 60 Harrison 2004b, Pl. 3.12  
Class 66 Loud 1948, Fig. 73.11  
Class 71a Loud 1948, Fig. 73.1  
Class 71b Loud 1948, Fig. 73.2  
Class 76 Loud 1948, Fig. 73.3  
Class 100b Loud 1948, Fig. 73.4-5  
Class 102a Harrison 2004b, Pl. 3.17  
Class 102b Loud 1948, Fig. 74.14  
Class 102d Loud 1948, Fig. 74.15  
Class 102e Loud 1948, Fig. 74.16  
Class 103a Loud 1948, Fig. 73.12  
Class 129 Loud 1948, Fig. 74.18-19  
Class 131a Loud 1948, Fig. 74.17  
Class 134a Loud 1948, Fig. 74.3, 6  
Class 154 Loud 1948, Fig. 74.4  
Class 158a Loud 1948, Fig. 74.1  
Class 159 Loud 1948, Fig. 74.10  
Class 160a Loud 1948, Fig. 74.2  
Class 162 Loud 1948, Fig. 74.11  
Class 170 Loud 1948, Fig. 74.5  
Class 172 Loud 1948, Fig. 74.7  
Class 188 Loud 1948, Fig. 74.8-9

#### **Tombs**

Class 4b Guy 1938, Pl. 75.11  
Class 8d Guy 1938, Pl. 75.10  
Class 11a Guy 1938, Pl. 75.15  
Class 11b Guy 1938, Pl. 75.14  
Class 12a Guy 1938, Pls 68.11; 70.6; 71.18;  
73.14  
Class 12b Guy 1938, Pl. 74.23-24  
Class 12c Guy 1938, Pl. 74.9  
Class 16a Guy 1938, Pls 69.4; 70.1, 4; 72.2;  
73.10  
Class 16b Guy 1938, Pl. 69.1  
Class 16b Guy 1938, Pl. 72.1, 13  
Class 19 Guy 1938, Pl. 75.12  
Class 26 Guy 1938, Pl. 73.7  
Class 38a Guy 1938, Pls 68.12; 71.6-16; 73.1-  
2, 12-13; 74.16  
Class 40a Guy 1938, Pls 69.9; 70.12-15; 71.1;  
73.3  
Class 40b Guy 1938, Pls 8.10; 68.3, 16; 70.17  
Class 42 Guy 1938, Pl. 69.5  
Class 54 Guy 1938, Pl. 68.7, 15  
Class 54 Guy 1938, Pl. 69.6  
Class 71a Guy 1938, Pl. 72.12  
Class 88 Guy 1938, Pl. 72.9  
Class 100b Guy 1938, Pl. 74.2, 5, 18  
Class 100d Guy 1938, Pl. 74.3, 19-20

Class 100e Guy 1938, Pl. 68.6  
Class 100e Guy 1938, Pl. 74.4, 6  
Class 102a Guy 1938, Pls 68.2, 9-10; 70.2-3,  
5; 72.3-7; 73.8-9; 74.14-15  
Class 103a Guy 1938, Pl. 71.19  
Class 103b Guy 1938, Pl. 69.2  
Class 107b Guy 1938, Pl. 68.8  
Class 116 Guy 1938, Pls 68.18; 69.10  
Class 124 Guy 1938, Pl. 74.7  
Class 131a Guy 1938, Pls 68.19; 71.17; 73.5  
Class 131b Guy 1938, Pls 68.20; 74.25  
Class 134a Guy 1938, Pls 68.4; 69.8; 70.7, 11;  
71.4-5; 73.6  
Class 134b Guy 1938, Pl. 70.8  
Class 134b Guy 1938, Pl. 74.12  
Class 152 Guy 1938, Pl. 75.7  
Class 155 Guy 1938, Pl. 75.8-9  
Class 157 Guy 1938, Pl. 68.1, 14  
Class 158a Guy 1938, Pls 68.5, 13; 69.7; 70.9-  
10; 73.4, 11; 75.5  
Class 160a Guy 1938, Pl. 72.10-11  
Class 163 Guy 1938, Pl. 72.8  
Class 163 Guy 1938, Pl. 74.17  
Class 188 Guy 1938, Pl. 69.3

#### **Area H level 3 (IVA)**

Class 4b Finkelstein et al. 2000b, Fig.  
11.53(12)  
Class 7a Finkelstein et al. 2000b, Figs 11.44(5,  
7-8); 45 (1-4); 53(4, 10)  
Class 8b Finkelstein et al. 2000b, Figs  
11.44(6); 53(7)  
Class 12b Finkelstein et al. 2000b, Fig.  
11.47(13-14)  
Class 12c Finkelstein et al. 2000b, Fig.  
11.53(11)  
Class 14 Finkelstein et al. 2000b, Fig.  
11.43(13)  
Class 15 Finkelstein et al. 2000b, Fig. 11.53(9)  
Class 16a Finkelstein et al. 2000b, Fig.  
11.47(3)  
Class 17 Finkelstein et al. 2000b, Fig. 11.47(7-  
12)  
Class 22 Finkelstein et al. 2000b, Figs  
11.46(10, 12); 47(3, 6)  
Class 24b Finkelstein et al. 2000b, Figs  
11.47(4); 53(13)  
Class 48a Finkelstein et al. 2000b, Fig.  
11.46(11)  
Class 54 Finkelstein et al. 2000b, Fig. 11.44(1-  
4)  
Class 54 Finkelstein et al. 2000b, Fig. 11.52(8-  
12)  
Class 67 Finkelstein et al. 2000b, Fig.  
11.46(13-14)  
Class 73 Finkelstein et al. 2000b, Figs  
11.45(6); 46(9)  
Class 82e Finkelstein et al. 2000b, Figs  
11.45(5, 7); 46(5)  
Class 83 Finkelstein et al. 2000b, Fig. 11.53(6)  
Class 86 Finkelstein et al. 2000b, Fig. 11.53(3)



Class 100b Finkelstein et al. 2000b, Fig. 11.46(1, 3)  
 Class 100b Finkelstein et al. 2000b, Fig. 11.53(2)  
 Class 121c Finkelstein et al. 2000b, Fig. 11.46(7)  
 Class 134a Finkelstein et al. 2000b, Fig. 11.52(5, 7)  
 Class 134b Finkelstein et al. 2000b, Fig. 11.43(6, 18)  
 Class 134e Finkelstein et al. 2000b, Fig. 11.52(4)  
 Class 141a Finkelstein et al. 2000b, Fig. 11.43(9)  
 Class 150 Unpublished  
 Class 152 Finkelstein et al. 2000b, Fig. 11.52(1)  
 Class 155 Finkelstein et al. 2000b, Fig. 11.43(3)  
 Class 169 Finkelstein et al. 2000b, Fig. 11.43(10)  
 Class 169 Finkelstein et al. 2000b, Fig. 11.52(3)  
 Class 172 Finkelstein et al. 2000b, Fig. 11.43(2)  
 Class 173a Finkelstein et al. 2000b, Fig. 11.52(2)  
 Class 174 Finkelstein et al. 2000b, Fig. 11.43(12)  
 Class 179 Finkelstein et al. 2000b, Fig. 11.43(1, 4, 7)  
 Class 180 Finkelstein et al. 2000b, Fig. 11.43(11, 14)  
**Area K level 2 (VA-IVB)**  
 Class 7a Finkelstein et al. 2000b, Fig. 11.21(4)  
 Class 8b Finkelstein et al. 2000b, Fig. 11.21(5)  
 Class 8c Finkelstein et al. 2000b, Fig. 11.21(2-3)  
 Class 8d Finkelstein et al. 2000b, Fig. 11.21(1)  
 Class 16c Finkelstein et al. 2000b, Fig. 11.21(7)  
 Class 38b Finkelstein et al. 2000b, Fig. 11.20(9)  
 Class 40b Finkelstein et al. 2000b, Fig. 11.20(12)  
 Class 54 Finkelstein et al. 2000b, Fig. 11.20(10, 13)  
 Class 64 Finkelstein et al. 2000b, Fig. 11.21(8)  
 Class 71b Finkelstein et al. 2000b, Fig. 11.21(9)  
 Class 152 Finkelstein et al. 2000b, Fig. 11.20(1)  
 Class 162 Finkelstein et al. 2000b, Fig. 11.20(7)  
 Class 172 Finkelstein et al. 2000b, Fig. 11.20(2-4, 6)  
**Area K level 3 (VB)**  
 Class 8b Finkelstein et al. 2000b, Fig. 11.19(1, 5)

Class 8c Finkelstein et al. 2000b, Fig. 11.19(3-4)  
 Class 8d Finkelstein et al. 2000b, Fig. 11.19(2)  
 Class 12b Finkelstein et al. 2000b, Fig. 11.18(16)  
 Class 19 Finkelstein et al. 2000b, Fig. 11.19(15)  
 Class 26 Finkelstein et al. 2000b, Fig. 11.19(18)  
 Class 38b Finkelstein et al. 2000b, Fig. 11.18(13-15)  
 Class 85b Finkelstein et al. 2000b, Fig. 11.19(16)  
 Class 100a Finkelstein et al. 2000b, Fig. 11.19(17)  
 Class 100b Finkelstein et al. 2000b, Fig. 11.19(14)  
 Class 100c Finkelstein et al. 2000b, Fig. 11.19(10, 13)  
 Class 100d Finkelstein et al. 2000b, Fig. 11.19(7)  
 Class 141a Finkelstein et al. 2000b, Fig. 11.18(7)  
 Class 152 Finkelstein et al. 2000b, Fig. 11.18(2, 5-6)  
 Class 155 Finkelstein et al. 2000b, Fig. 11.18(3)  
 Class 163 Finkelstein et al. 2000b, Fig. 11.18(10)  
 Class 170 Finkelstein et al. 2000b, Fig. 11.18(11)  
 Class 175 Finkelstein et al. 2000b, Fig. 11.18(8)  
 Class 182a Finkelstein et al. 2000b, Fig. 11.18(4)  
**Area F level 5 (VIA)**  
 Class 4c Finkelstein et al. 2000b, Fig. 11.2(11)  
 Class 8c Finkelstein et al. 2000b, Fig. 11.2(9)  
 Class 8d Finkelstein et al. 2000b, Fig. 11.2(12)  
 Class 8e Finkelstein et al. 2000b, Fig. 11.2(10)  
 Class 12b Finkelstein et al. 2000b, Fig. 11.3(10)  
 Class 16a Finkelstein et al. 2000b, Fig. 11.4(4-8, 10)  
 Class 16b Finkelstein et al. 2000b, Fig. 11.4(3, 11)  
 Class 16c Finkelstein et al. 2000b, Fig. 11.4(9)  
 Class 38a Finkelstein et al. 2000b, Fig. 11.2(6-7)  
 Class 42 Finkelstein et al. 2000b, Fig. 11.2(8)  
 Class 66 Finkelstein et al. 2000b, Fig. 11.3(8)  
 Class 71a Finkelstein et al. 2000b, Fig. 11.3(1)  
 Class 78 Finkelstein et al. 2000b, Fig. 11.3(7)  
 Class 100b Finkelstein et al. 2000b, Fig. 11.3(2)  
 Class 123 Finkelstein et al. 2000b, Fig. 11.3(4)  
 Class 129 Finkelstein et al. 2000b, Fig. 11.2(4)  
 Class 154 Finkelstein et al. 2000b, Fig. 11.2(3)  
 Class 160a Finkelstein et al. 2000b, Fig. 11.2(1)

Class 188 Finkelstein et al. 2000b, Fig. 11.2(2)  
**Area F level 6 burial**  
Class 102a Finkelstein et al. 2000b, Fig.  
11.1(3)

Class 154 Finkelstein et al. 2000b, Fig. 11.1(1)  
Class 188 Finkelstein et al. 2000b, Fig. 11.1(2)

## C.31 Mina, al

### Stratum II

Class 28 see Woolley 1938b, 134  
Class 121e Lehmann 1996, Pl. 18 (98/3)

### Stratum III

Class 4c Lehmann 1996, Pl. 86 (457/1+3)  
Class 12c Woolley 1938b, Fig. 15.1  
Class 20 Woolley 1938b, Fig. 26.6  
Class 20 see Woolley 1938b, 137  
Class 23 Woolley 1938b, Fig. 26.5  
Class 23 see Woolley 1938b, 140, 143  
Class 27 Woolley 1938b, Fig. 26.1  
Class 27 see Woolley 1938b, 143  
Class 28 Woolley 1938b, Fig. 26.3  
Class 28 Lehmann 1996, Pl. 78 (420/3)  
Class 28 see Woolley 1938b, 137  
Class 58 Lehmann 1996, Pl. 60 (359a/2)  
Class 58 Lehmann 1996, Pl. 60 (359b/2)  
Class 58 Lehmann 1996, Pl. 61 (359b/4-7)  
Class 58 see Lehmann 1996, 426 (Form 359a)  
Class 58 see Lehmann 1996, 427 (Form 359c)  
Class 93a Woolley 1938b, Fig. 28.L5  
Class 93a see Woolley 1938b, 139-140  
Class 94 Woolley 1938b, Fig. 28.L4  
Class 95 Woolley 1938a, Fig. 11  
Class 95 Woolley 1938b, Fig. 28.L1  
Class 95 see Woolley 1938b, 140-142  
Class 95 Lehmann 1996, Pl. 44 (269/3+4)  
Class 95 Lehmann 1996, Pl. 45 (274/1-3)  
Class 100a Woolley 1938b, Fig. 28.L3  
Class 100a Woolley 1938b, 141-142  
Class 117 Woolley 1938b, Fig. 19.1  
Class 117 see Woolley 1938b, 156  
Class 134d Lehmann 1996, Pl. 25 (157/2)

### Stratum IV/III

Class 58 Lehmann 1996, Pl. 60 (359a/5)  
Class 58 Lehmann 1996, Pl. 60 (359b/1)  
Class 58 Lehmann 1996, Pl. 61 (359d/1)  
Class 95 see Lehmann 1996, 411 (Form 269)

### Stratum IV

Class 2 Woolley 1938b, Fig. 27.21  
Class 18 Woolley 1938b, Fig. 26.2  
Class 23 Woolley 1938b, Fig. 26.5  
Class 46 Woolley 1938b, Fig. 28.24  
Class 58 Lehmann 1996, Pl. 60 (359a/3+4;  
359a/6)  
Class 58 Lehmann 1996, Pl. 61 (359c/5)  
Class 93a Lehmann 1996, Pl. 44 (267b/3)  
Class 95 Woolley 1938b, Fig. 28.L1  
Class 162 Lehmann 1996, Pl. 24 (155/1)  
Class 162 Lehmann 1996, Pl. 25 (156/4)  
Class 193 Lehmann 1996, Pl. 26 (167/1)

### Stratum V/IV

Class 151 du Plat Taylor 1959, Fig. 6.25

### Stratum V

Class 18 Woolley 1938b, Fig. 26.2  
Class 20 Woolley 1938b, Fig. 26.6  
Class 23 Woolley 1938b, Fig. 26.5  
Class 58 Lehmann 1996, Pl. 61 (359c/3)  
Class 77 Lehmann 1996, Pl. 43 (263/1)  
Class 81 du Plat Taylor 1959, Fig. 1.15  
Class 84 du Plat Taylor 1959, Fig. 2.13  
Class 132 Lehmann 1996, Pl. 30 (180/2)  
Class 134d Lehmann 1996, Pl. 16 (83d/1)  
Class 145a Woolley 1937, Pl. 11.2  
Class 145a see Lehmann 1996, 387 (Form  
148)  
Class 163 Lehmann 1996, Pl. 24 (154/1)  
Class 193 Lehmann 1996, Pl. 26 (164/1)  
Class 193 Lehmann 1996, Pl. 26 (165/1)  
Class 193 Lehmann 1996, Pl. 26 (168/2)

### Stratum VI/V

Class 58 Lehmann 1996, Pl. 60 (359a/4)  
Class 62 du Plat Taylor 1959, Fig. 3.5-6, 9  
Class 137 Lehmann 1996, Pl. 30 (183/1)  
Class 144a du Plat Taylor 1959, Fig. 6.24  
Class 145a Lehmann 1996, Pl. 7 (36/1)  
Class 148 Lehmann 1996, Pl. 24 (149/1)  
Class 148 Lehmann 1996, Pl. 24 (150/1)  
Class 162 Lehmann 1996, Pl. 24 (155/2)  
Class 187 du Plat Taylor 1959, Fig. 6.27

### Stratum VI

Class 28 see Lehmann 1996, 437 (Form 388-  
92)

Class 57c Woolley 1938b, Fig. 27.12  
Class 58 Lehmann 1996, Pl. 61 (359c/4)  
Class 141a Lehmann 1996, Pl. 19 (103/1+3)  
Class 144b du Plat Taylor 1959, Fig. 6.31  
Class 160a Lehmann 1996, Pl. 23 (145b/4)  
Class 162 see Lehmann 1996, 388 (Form 153)

### Stratum VII/VI

Class 82a du Plat Taylor 1959, Fig. 7.7  
Class 86 du Plat Taylor 1959, Fig. 7.5-6  
Class 119 Lehmann 1996, Pl. 39 (225/1)  
Class 139 du Plat Taylor 1959, Fig. 6.8  
Class 144b du Plat Taylor 1959, Fig. 6.18  
Class 148 Lehmann 1996, Pl. 6 (29/5)  
Class 151 du Plat Taylor 1959, Fig. 6.28  
Class 152 du Plat Taylor 1959, Fig. 6.29  
Class 152 Lehmann 1996, Pl. 20 (115/1)  
Class 153 du Plat Taylor 1959, Fig. 6.16  
Class 187 du Plat Taylor 1959, Fig. 6.27  
Class 191 Boardman 1959, No. 17

### Stratum VII

Class 18 Woolley 1938b, Fig. 26.2  
Class 42 du Plat Taylor 1959, Fig. 3.13  
Class 85a du Plat Taylor 1959, Fig. 2.8

Class 87 du Plat Taylor 1959, Fig. 7.1, 3-4  
Class 121d Lehmann 1996, Pl. 53 (323b/1)  
Class 191 Boardman 1959, No. 16

#### **Stratum VIII/VII**

Class 12d Lehmann 1996, Pl. 81 (422/1)  
Class 84 du Plat Taylor 1959, Fig. 1.14

#### **Strata VIII-V**

Class 42 du Plat Taylor 1959, Fig. 3.13  
Class 46 du Plat Taylor 1959, Fig. 3.14-15  
Class 62 du Plat Taylor 1959, Fig. 3.7  
Class 80 du Plat Taylor 1959, Fig. 2.1, 5-6  
Class 84 du Plat Taylor 1959, Fig. 5.8  
Class 134d du Plat Taylor 1959, Fig. 1.12  
Class 143 du Plat Taylor 1959, Fig. 1.11  
Class 144a du Plat Taylor 1959, Fig. 5.9  
Class 162 du Plat Taylor 1959, Fig. 1.10, 13  
Class 162 du Plat Taylor 1959, Fig. 5.10  
Class 163 du Plat Taylor 1959, Fig. 1.1-6, 8  
Class 163 du Plat Taylor 1959, Fig. 5.1-3, 5  
Class 172 du Plat Taylor 1959, Fig. 1.17  
Class 173a du Plat Taylor 1959, Fig. 5.4  
Class 188 du Plat Taylor 1959, Fig. 5.11-12

#### **Stratum VIII**

Class 18 Woolley 1938b, Fig. 26.2  
Class 19 Woolley 1937, Pl. 13.1  
Class 57b Woolley 1938b, Fig. 27.11  
Class 62 du Plat Taylor 1959, Fig. 3.1  
Class 81 du Plat Taylor 1959, Fig. 1.15  
Class 84 du Plat Taylor 1959, Fig. 2.12-13  
Class 85b du Plat Taylor 1959, Fig. 2.9  
Class 100b see Lehmann 1996, 398 (Form 210)  
Class 132 Lehmann 1996, Pl. 30 (179/1)  
Class 132 see Lehmann 1996, 394 (Form 180)  
Class 139 Lehmann 1996, Pl. 19 (99/3)  
Class 144a du Plat Taylor 1959, Fig. 6.10, 13  
Class 144a Lehmann 1996, Pl. 21 (120a/2)  
Class 144a Lehmann 1996, Pl. 21 (121/1)  
Class 144b du Plat Taylor 1959, Fig. 6.17, 20  
Class 145a du Plat Taylor 1959, Fig. 6.33, 37  
Class 145a Lehmann 1996, Pl. 6 (28/4+5)  
Class 145b Lehmann 1996, Pl. 14 (77/1)  
Class 151 du Plat Taylor 1959, Fig. 6.39  
Class 155 du Plat Taylor 1959, Fig. 6.2a  
Class 160a du Plat Taylor 1959, Fig. 6.4  
Class 167 Lehmann 1996, Pl. 31 (185/1)  
Class 172 Lehmann 1996, Pl. 17 (85c2)  
Class 173a du Plat Taylor 1959, Fig. 6.6, 38  
Class 191 Boardman 1959, Nos 4, 15

#### **Stratum IX/VIII**

Class 18 see Lehmann 1996, 431 (Form 380)  
Class 106 Woolley 1937, Pl. 11.2

Class 144b Lehmann 1996, Pl. 16 (84c/3+4)  
Class 144b du Plat Taylor 1959, Fig. 6.15  
Class 191 Robertson 1940, Fig. 1

Class 191 Boardman 1959, Nos 10, 13

#### **Stratum IX**

Class 81 du Plat Taylor 1959, Fig. 1.15  
Class 155 see Lehmann 1996, 373 (Form 78b)  
Class 184 du Plat Taylor 1959, Fig. 6.36  
Class 191 Boardman 1959, Nos 8-9, 20

#### **Unstratified**

Class 1a Lehmann 1996, Pl. 83 (438a/3)  
Class 9a Lehmann 1996, Pl. 86 (Form 458/2)  
Class 15 Woolley 1938b, Fig. 28.23  
Class 19 du Plat Taylor 1959, Fig. 3.11  
Class 25 Woolley 1938b, Fig. 26.7  
Class 43 Woolley 1938a, Fig. 10  
Class 43 Lehmann 1996, Pl. 37 (208/1-2)  
Class 48b Lehmann 1996, Pl. 34 (194/3)  
Class 62 du Plat Taylor 1959, Fig. 4.3  
Class 82e see Lehmann 1996, 418 (Form 306)  
Class 85b du Plat Taylor 1959, Fig. 2.10-11  
Class 90a du Plat Taylor 1959, Fig. 2.7  
Class 91 Woolley 1938b, Fig. 27.18  
Class 93a Lehmann 1996, Pl. 44 (267d/1; 268/1)  
Class 94 Lehmann 1996, Pl. 39 (229/1-5)  
Class 95 see Lehmann 1996, 411 (Form 269)  
Class 100a Lehmann 1996, Pl. 38 (219/3+4)  
Class 113 Lehmann 1996, Pl. 53 (322/1)  
Class 119 Peltenburg 1969, 94  
Class 119 Peltenburg 1969, Figs 1.a-g; 2.j-l  
Class 121b see Lehmann 1996, 410 (Form 266)  
Class 130 see Lehmann 1996, 384 (Form 125c)  
Class 132 Lehmann 1996, Pl. 30 (179/2)  
Class 136 du Plat Taylor 1959, Fig. 6.11  
Class 141a du Plat Taylor 1959, Fig. 6.7  
Class 141a Lehmann 1996, Pl. 19 (103/2)  
Class 144a see Lehmann 1996, 382 (Form 120a)  
Class 145a Lehmann 1996, Pl. 6 (30/1)  
Class 148 Lehmann 1996, Pl. 24 (151/1)  
Class 151 du Plat Taylor 1959, Fig. 6.30  
Class 155 du Plat Taylor 1959, Fig. 6.1-3  
Class 162 Lehmann 1996, Pl. 25 (156/3)  
Class 172 Lehmann 1996, Pl. 24 (155/3)  
Class 178 Lehmann 1996, Pl. 7 (38/1)  
Class 191 Boardman 1959, Nos 1-3, 5-7, 11-13, 18-19, 21-24  
Class 192 du Plat Taylor 1959, Fig. 6.35  
Class 134d Lehmann 1996, Pl. 16 (83b/2)

## **C.32 Mishrifeh, Tell**

#### **Iron I/II**

Class 1a Unpublished  
Class 1c Unpublished  
Class 4b Unpublished  
Class 4c Unpublished

Class 4d Unpublished  
Class 5 Unpublished  
Class 6 Unpublished  
Class 37a Unpublished  
Class 37b Unpublished

Class 49 Unpublished  
 Class 56 Unpublished  
 Class 134a Unpublished  
 Class 134d Unpublished  
 Class 134e Unpublished  
 Class 141d Unpublished  
 Class 143 Unpublished  
 Class 157 Unpublished  
 Class 161 Unpublished  
 Class 166 Unpublished  
 Class 170 Unpublished  
 Class 172 Unpublished  
 Class 173b Unpublished  
 Class 174 Unpublished  
 Class 176 Unpublished  
 Class 180 Unpublished  
 Class 181 Unpublished  
 Class 182a Unpublished  
 Class 182b Unpublished  
 Class 182c Unpublished  
 Class 183 Unpublished  
 Class 187 Unpublished  
 Class 190 Unpublished  
 Class 192 Unpublished

#### **Operation C level II**

Class 37b al Maqdissi & Badawi 2002, Fig. 17.2-4  
 Class 37b al Maqdissi 2003, Fig. 13  
 Class 131b al Maqdissi 2003, Fig. 6.5  
 Class 134d al Maqdissi 2003, Fig. 12.2  
 Class 141d al Maqdissi 2003, Fig. 6.1-4  
 Class 161 al Maqdissi 2003, Fig. 12.4;  
 Class 174 al Maqdissi 2003, Fig. 12.3  
 Class 176 al Maqdissi & Badawi 2002, Fig. 16.2  
 Class 176 al Maqdissi 2003, Fig. 12.1

#### **Operation H levels 5-6**

Class 4d Barro 2002, Fig. 107.9  
 Class 141b Barro 2002, Fig. 107.4  
 Class 161 Barro 2002, Fig. 107.5  
 Class 173b Barro 2002, Fig. 107.1  
 Class 182b Barro 2002, Fig. 107.2

#### **Operation J**

Class 37b Morandi Bonacossi 2002, Fig. 113.11-13  
 Class 161 Morandi Bonacossi 2002, Fig. 113.5-6  
 Class 176 Morandi Bonacossi 2002, Fig. 113.1  
 Class 181 Morandi Bonacossi 2002, Fig. 113.3-4

## **C.33 Nayrab**

#### **Nayrab Unstratified**

Class 2 Carriere & Barrois 1927, Fig. 1.A  
 Class 6 Abel & Barrois 1928, Pl. 54f  
 Class 23 Carriere & Barrois 1927, Fig. 1.J21  
 Class 28 Carriere & Barrois 1927, Fig. 1.B-C  
 Class 37b Carriere & Barrois 1927, Fig. 1.J2, J25-J26

#### **Operation K levels 8-4**

Class 54 Luciani 2002, Fig. 134.6-7  
 Class 152 Luciani 2002, Fig. 134.5  
 Class 175 Luciani 2002, Fig. 134.1  
 Class 176 Luciani 2002, Fig. 134.2  
 Class 182a Luciani 2002, Fig. 134.3

#### **Unstratified**

Class 7a du Mesnil du Buisson 1930, Pl. 32.12  
 Class 12a du Mesnil du Buisson 1927, Fig. 5.23  
 Class 12c du Mesnil du Buisson 1935, Fig. 49.191b  
 Class 19 du Mesnil du Buisson 1927, Pl. 75.40  
 Class 28 du Mesnil du Buisson 1927, Pl. 75.32  
 Class 37b du Mesnil du Buisson 1926, Figs 19.1-5; 20  
 Class 37b du Mesnil du Buisson 1935, Fig. 47.165, 175  
 Class 41a du Mesnil du Buisson 1927, Pl. 69.19  
 Class 51 du Mesnil du Buisson 1935, Fig. 46.170  
 Class 53b du Mesnil du Buisson 1927, Pl. 69.3, 10  
 Class 53b du Mesnil du Buisson 1935, Fig. 48.169  
 Class 54 du Mesnil du Buisson 1935, Fig. 49.191a  
 Class 57a du Mesnil du Buisson 1927, Pl. 69.11  
 Class 57b du Mesnil du Buisson 1927, Pl. 81.66  
 Class 61 du Mesnil du Buisson 1935, Fig. 6.140  
 Class 73 du Mesnil du Buisson 1927, Pl. 69.4-5  
 Class 102c du Mesnil du Buisson 1926, Fig 8; 1927 Pl. 69.7  
 Class 105 du Mesnil du Buisson 1926, Figs 21-22  
 Class 106 du Mesnil du Buisson 1927, Pl. 82.83  
 Class 128 du Mesnil du Buisson 1927, Pl. 69.13-16  
 Class 134d du Mesnil du Buisson 1935, Fig. 1.3-4  
 Class 155 du Mesnil du Buisson 1927, Pl. 79.47  
 Class 157 du Mesnil du Buisson 1927, Pl. 69.17; 1935, Fig. 1.1  
 Class 165a du Mesnil du Buisson 1926, Pl. 69.6  
 Class 165a du Mesnil du Buisson 1927, Fig. 5.21-22  
 Class 165a du Mesnil du Buisson 1927, Pls 79.43-44; 81.69-70; 82.73  
 Class 166 du Mesnil du Buisson 1927, Pl. 82.94  
 Class 173a du Mesnil du Buisson 1935, Fig. 1.2  
 Class 184 du Mesnil du Buisson 1927, Pl. 79.48

Class 28 Carriere & Barrois 1927, Fig. 1.J17-18, J23  
 Class 28 Abel & Barrois 1928, Pl. 54c-d  
 Class 33 Carriere & Barrois 1927, Fig. 1.J29  
 Class 33 Abel & Barrois 1928, Pl. 54a  
 Class 37b Abel & Barrois 1928, Pl. 54b  
 Class 37b Abel & Barrois 1928, Fig. 7

Class 44 Abel & Barrois 1928, Pl. 54e  
Class 57b Abel & Barrois 1928, Pl. 54h  
Class 68 Abel & Barrois 1928, Pl. 54k  
Class 95 Carriere & Barrois 1927, Pl. 55.C  
Class 95 Abel & Barrois 1928, Pl. 54g

Class 102a Abel & Barrois 1928, Pl. 54i  
Class 105 Carriere & Barrois 1927, Fig. 1.J2a  
Class 118 Abel & Barrois 1928, Pl. 54j  
Class 147 Abel & Barrois 1928, Pl. 54l

## C.34 Nebi Mend, Tell

### Trench V Level B

Class 4b Unpublished  
Class 4c Unpublished  
Class 4d Unpublished  
Class 6 Unpublished  
Class 7a Unpublished  
Class 7b Unpublished  
Class 14 Unpublished  
Class 15 Unpublished  
Class 37b Unpublished  
Class 53b Unpublished  
Class 54 Unpublished  
Class 56 Unpublished  
Class 73 Unpublished  
Class 131a Unpublished  
Class 134a Unpublished  
Class 134d Unpublished  
Class 134e Unpublished  
Class 139 Unpublished  
Class 141a Unpublished  
Class 161 Unpublished  
Class 166 Unpublished  
Class 170 Unpublished  
Class 171 Unpublished  
Class 172 Unpublished  
Class 173a Unpublished  
Class 173b Unpublished  
Class 174 Unpublished  
Class 175 Unpublished  
Class 176 Unpublished  
Class 177 Unpublished  
Class 181 Unpublished  
Class 182a Unpublished  
Class 182b Unpublished  
Class 183 Unpublished  
Class 188 Unpublished

### Trench V Level C

Class 4b Unpublished  
Class 4c Unpublished  
Class 6 Unpublished  
Class 10 Unpublished  
Class 37b Unpublished  
Class 134a Unpublished  
Class 141d Unpublished  
Class 157 Unpublished

Class 161 Unpublished  
Class 166 Unpublished  
Class 169 Unpublished  
Class 170 Unpublished  
Class 171 Unpublished  
Class 173a Unpublished  
Class 173b Unpublished  
Class 175 Unpublished  
Class 176 Unpublished  
Class 181 Unpublished  
Class 182a Unpublished  
Class 183 Unpublished  
Class 185 Unpublished  
Class 187 Unpublished  
Class 188 Unpublished

### Unstratified

Class 4c Pezard 1931, Pl. 25.3.2  
Class 4d Pezard 1931, Pl. 25.2.4  
Class 5 Pezard 1931, Pl. 25.3.1  
Class 6 Pezard 1931, Pl. 23.4.3  
Class 12b Pezard 1931, Pl. 27.4  
Class 14 Pezard 1931, Pl. 23.1.10  
Class 28 Pezard 1931, Pl. 23.3.2  
Class 37b Pezard 1931, Pl. 22.4  
Class 37b Pezard 1931, Pl. 23.3.1  
Class 37b Pezard 1931, Pl. 40.1.3  
Class 56 Pezard 1931, Pl. 25.2.5  
Class 95 Pezard 1931, Pl. 23.1.2  
Class 100d Pezard 1931, Pl. 27.2.7  
Class 102b Pezard 1931, Pl. 40.2.5-6  
Class 104 Pezard 1931, Pl. 38  
Class 105 Pezard 1931, Pl. 23.4.7  
Class 105 Pezard 1931, Pl. 24.2b  
Class 106 Pezard 1931, Pl. 24.2.6  
Class 116 Pezard 1931, Pl. 27.8  
Class 126 Pezard 1931, Pl. 23.1.8  
Class 128 Pezard 1931, Pl. 23.4.1-2, 4-5  
Class 134a Pezard 1931, Pl. 25.3.3  
Class 139 Pezard 1931, Pl. 23.1.6  
Class 166 Pezard 1931, Pl. 24.1b-c  
Class 166 Pezard 1931, Pl. 27.1.2-3  
Class 176 Pezard 1931, Pl. 24.1d  
Class 188 Pezard 1931, Pl. 23.4.6  
Class 188 Pezard 1931, Pl. 25.3.6

## C.35 Pella

### Area III level I

Class 4d McNicoll et al. 1992, Pl. 68.5  
Class 5 McNicoll et al. 1992, Pl. 68.7

Class 7b McNicoll et al. 1992, Pl. 50.11  
Class 8b McNicoll et al. 1992, Pl. 50.5  
Class 8c McNicoll et al. 1992, Pl. 51.4

Class 8d McNicoll et al. 1992, Pl. 51.5-8  
Class 12b McNicoll et al. 1992, Pl. 49.10  
Class 38a McNicoll et al. 1992, Pl. 52.9  
Class 38b McNicoll et al. 1992, Pl. 51.1  
Class 56 McNicoll et al. 1992, Pl. 49.13  
Class 57b McNicoll et al. 1992, Pl. 68.6  
Class 131a McNicoll et al. 1992, Pl. 68.4  
Class 132 McNicoll et al. 1992, Pl. 51.11  
Class 134d McNicoll et al. 1992, Pl. 52.1-5  
Class 141a McNicoll et al. 1992, Pl. 49.3  
Class 141a McNicoll et al. 1992, Pl. 68.3  
Class 141c McNicoll et al. 1992, Pl. 49.7  
Class 141c McNicoll et al. 1992, Pl. 68.2  
Class 160a McNicoll et al. 1992, Pl. 51.9  
Class 160b McNicoll et al. 1992, Pl. 51.2  
Class 161 McNicoll et al. 1992, Pl. 51.10  
Class 172 McNicoll et al. 1992, Pl. 49.4-5

#### **Area III level O**

Class 8c McNicoll et al. 1992, Pl. 67.4  
Class 8d McNicoll et al. 1992, Pl. 67.5  
Class 8e McNicoll et al. 1992, Pl. 67.14  
Class 38a McNicoll et al. 1992, Pl. 67.3  
Class 134d McNicoll et al. 1992, Pl. 67.12  
Class 141c McNicoll et al. 1992, Pl. 67.7  
Class 152 McNicoll et al. 1992, Pl. 67.13  
Class 172 McNicoll et al. 1992, Pl. 67.2  
Class 182b McNicoll et al. 1992, Pl. 67.6

#### **Area VIII level 6**

Class 6 McNicoll et al. 1992, Pl. 66.7  
Class 8b McNicoll et al. 1992, Pl. 66.4, 6  
Class 38a McNicoll et al. 1992, Pl. 66.2  
Class 144b McNicoll et al. 1992, Pl. 66.11  
Class 152 McNicoll et al. 1992, Pl. 66.13  
Class 154 McNicoll et al. 1992, Pl. 66.9  
Class 160b McNicoll et al. 1992, Pl. 66.12

#### **Area VIII level 7**

Class 8c McNicoll et al. 1992, Pl. 65.12  
Class 8d McNicoll et al. 1992, Pl. 65.10  
Class 54 McNicoll et al. 1992, Pl. 65.6  
Class 56 McNicoll et al. 1992, Pl. 65.4  
Class 161 McNicoll et al. 1992, Pl. 65.2

#### **Area VIII level 8**

Class 8d McNicoll et al. 1992, Pl. 64.2  
Class 38a McNicoll et al. 1992, Pl. 64.8  
Class 54 McNicoll et al. 1992, Pl. 64.1, 4  
Class 134a McNicoll et al. 1992, Pl. 64.5  
Class 141c McNicoll et al. 1992, Pl. 64.7  
Class 154 McNicoll et al. 1992, Pl. 64.3

#### **Iron I**

Class 4c Unpublished  
Class 4d Unpublished  
Class 5 Unpublished

Class 7b Unpublished  
Class 8b Unpublished  
Class 8c Unpublished  
Class 8d Unpublished  
Class 8e Unpublished  
Class 12b Unpublished  
Class 13 Unpublished  
Class 16a Unpublished  
Class 38a Unpublished  
Class 38b Unpublished  
Class 54 Unpublished  
Class 55 Unpublished  
Class 100b Unpublished  
Class 100d Unpublished  
Class 109 Unpublished  
Class 131b Unpublished  
Class 132 Unpublished  
Class 134a Unpublished  
Class 134d Unpublished  
Class 134e Unpublished  
Class 141c Unpublished  
Class 141d Unpublished  
Class 143 Unpublished  
Class 152 Unpublished  
Class 158a Unpublished  
Class 170 Unpublished  
Class 172 Unpublished  
Class 173a Unpublished  
Class 174 Unpublished  
Class 175 Unpublished  
Class 176 Unpublished  
Class 182b Unpublished  
Class 182c Unpublished

#### **Iron II**

Class 4c Unpublished  
Class 5 Unpublished  
Class 7a Unpublished  
Class 7b Unpublished  
Class 8b Unpublished  
Class 8c Unpublished  
Class 15 Unpublished  
Class 16a Unpublished  
Class 16b Unpublished  
Class 54 Unpublished  
Class 77 Unpublished  
Class 88 Unpublished  
Class 97 Unpublished  
Class 100b Unpublished  
Class 134a Unpublished  
Class 141c Unpublished  
Class 141d Unpublished  
Class 152 Unpublished  
Class 175 Unpublished

## **C.36 Qarqur, Tell**

#### **Stratum 8**

Class 1a Dornemann 2003a, Fig. 83.18-19  
Class 1a Unpublished  
Class 1b Unpublished

Class 1c Dornemann 2003a, Fig. 83.22, 24  
Class 5 Dornemann 2003a, Fig. 83.12  
Class 5 Unpublished  
Class 7b Unpublished

Class 12c Unpublished  
 Class 28 Dornemann 2003a, Fig. 30  
 Class 28 Unpublished  
 Class 37b Unpublished  
 Class 54 Unpublished  
 Class 56 Dornemann 2003a, Fig. 83.13-14  
 Class 57a Taylor 1984, No. 1-7  
 Class 141d Unpublished  
 Class 160a Dornemann 2003a, Fig. 82.1  
 Class 160b Unpublished  
 Class 161 Dornemann 2003a, Fig. 82.2-4, 11-12  
 Class 162 Unpublished  
 Class 169 Unpublished  
 Class 170 Unpublished  
 Class 172 Unpublished  
 Class 173a Unpublished  
 Class 173b Dornemann 2003a, Fig. 81.1-8, 11-13, 15  
 Class 174 Dornemann 2003a, Fig. 81.9  
 Class 174 Unpublished  
 Class 176 Dornemann 2003a, Fig. 81.16, 18-19  
 Class 176 Unpublished  
 Class 177 Dornemann 2003a, Fig. 81.10  
 Class 181 Dornemann 2003a, Fig. 81.20-21  
 Class 182a Dornemann 2003a, Fig. 81.22, 24  
 Class 182a Unpublished  
 Class 182b Dornemann 2003a, Fig. 81.23  
 Class 182b Unpublished  
 Class 182c Unpublished  
 Class 183 Unpublished  
 Class 184 Dornemann 2003a, Fig. 82.16-18, 20-22, 24-25  
 Class 184 Unpublished  
 Class 187 Unpublished  
 Class 189 Unpublished  
 Class 191 Dornemann 2003a, Fig. 82.15  
 Class 193 Dornemann 2003a, Fig. 83.21, 23

### **C.37 Qasmieh**

Class 42 S. V. Chapman 1972, Fig. 32.314  
 Class 77 S. V. Chapman 1972, Fig. 32.312  
 Class 82a S. V. Chapman 1972, Fig. 32.316

### **C.38 Graye**

Class 12c S. V. Chapman 1972, Fig. 23.285  
 Class 15 S. V. Chapman 1972, Fig. 17.282  
 Class 77 S. V. Chapman 1972, Fig. 5.270  
 Class 87 S. V. Chapman 1972, Fig. 27.300  
 Class 88 S. V. Chapman 1972, Fig. 7.268  
 Class 102a Guigues 1938, Pl. 9b  
 Class 102a S. V. Chapman 1972, Fig. 13.272  
 Class 102a S. V. Chapman 1972, Fig. 15.275-277  
 Class 102a S. V. Chapman 1972, Fig. 16.278  
 Class 102b S. V. Chapman 1972, Figs 13.271; 15.274; 16.279-281  
 Class 103b Guigues 1938, Pl. 9c

### **Stratum 8-9**

Class 5 Dornemann 2003a, Fig. 88.21-22  
 Class 54 Dornemann 2003a, Fig. 88.18, 20  
 Class 56 Dornemann 2003a, Fig. 88.17, 19  
 Class 169 Dornemann 2003a, Fig. 88.2  
 Class 170 Dornemann 2003a, Fig. 88.4  
 Class 171 Dornemann 2003a, Fig. 88.6  
 Class 174 Dornemann 2003a, Fig. 88.1  
 Class 175 Dornemann 2003a, Fig. 88.3  
 Class 183 Dornemann 2003a, Fig. 88.8  
 Class 188 Dornemann 2003a, Fig. 88.5

### **Stratum 9**

Class 1a Unpublished  
 Class 1b Unpublished  
 Class 4b Unpublished  
 Class 5 Unpublished  
 Class 7a Unpublished  
 Class 37a Unpublished  
 Class 37b Unpublished  
 Class 54 Unpublished  
 Class 56 Unpublished  
 Class 143 Unpublished  
 Class 152 Unpublished  
 Class 168 Unpublished  
 Class 169 Unpublished  
 Class 170 Unpublished  
 Class 174 Unpublished  
 Class 176 Unpublished  
 Class 188 Unpublished  
 Class 134a Unpublished  
 Class 134b Unpublished  
 Class 160a Unpublished  
 Class 160b Unpublished  
 Class 173a Unpublished  
 Class 182a Unpublished  
 Class 182c Unpublished

Class 102a S. V. Chapman 1972, Fig. 32.313  
 Class 179 S. V. Chapman 1972, Fig. 32.314a

Class 104 Guigues 1938, Pl. 9e  
 Class 107a S. V. Chapman 1972, Fig. 28.301  
 Class 109 S. V. Chapman 1972, Fig. 31.309  
 Class 116 Guigues 1938, Pl. 9a  
 Class 144a S. V. Chapman 1972, Fig. 28.302  
 Class 144b S. V. Chapman 1972, Fig. 28.303  
 Class 162 S. V. Chapman 1972, Fig. 25.298  
 Class 163 S. V. Chapman 1972, Fig. 31.307-308  
 Class 170 S. V. Chapman 1972, Fig. 24.293  
 Class 172 S. V. Chapman 1972, Fig. 28.304  
 Class 179 S. V. Chapman 1972, Fig. 25.296

## C.39 Rachidiah, Tell

### Tomb I

- Class 19 Doumet-Serhal 2004b, Fig. 3
- Class 42 Chehab 1983, Pl. XXII.1
- Class 42 Doumet-Serhal 2004b, Figs 5-6, 11, 15
- Class 46 Doumet-Serhal 2004b, Figs 16-18
- Class 48a Doumet-Serhal 2004b, Fig. 19
- Class 62 Doumet-Serhal 2004b, Fig. 9
- Class 81 Doumet-Serhal 2004h, Figs 5-6
- Class 82a Chehab 1983, Pl. XXII.2
- Class 100b Doumet-Serhal 2004a, 58

### Tomb II

- Class 18 Doumet-Serhal 2004b, Fig. 2
- Class 42 Doumet-Serhal 2003a, Fig. 22
- Class 42 Doumet-Serhal 2004b, Figs 4, 7, 10, 12-14
- Class 45 Doumet-Serhal 2003a, Fig. 26
- Class 62 Doumet-Serhal 2004b, Fig. 8

### Tomb IV

- Class 42 Doumet 1982, Pl. I.3-4
- Class 42 Doumet 1982, Pl. II.16, 38, 41
- Class 42 Doumet 1982, Pl. III.53-54
- Class 42 Doumet 1982, Pl. IV.62, 124
- Class 42 Doumet 1982, Pl. V.2
- Class 42 Doumet 1982, Pl. VI.12, 17
- Class 42 Doumet 1982, Pl. VII.18, 22
- Class 42 Doumet 1982, Pl. VIII.37/45, 48
- Class 42 Doumet 1982, Pl. IX.49
- Class 42 Griffiths 2003, 58 (Jar 16)
- Class 42 Griffiths 2003, 59 (Jar 17)
- Class 42 Bordreuil 2004, Figs 2-3
- Class 45 Doumet 1982, Pl. V.7
- Class 77 Doumet 1982, Pl. XI.11
- Class 77 Doumet 1982, Pl. XII.25, 30, 33, 42
- Class 77 Doumet 1982, Pl. XIII.95
- Class 80 Doumet 1982, Pl. XIII.106
- Class 81 Doumet 1982, Pl. XI.35, 43
- Class 82a Doumet 1982, Pl. X.50, 54, 59
- Class 82b Doumet 1982, Pl. X.34
- Class 82e Doumet 1982, Pl. X.40
- Class 85b Doumet 1982, Pl. XIII.70
- Class 88 Doumet 1982, Pl. XI.64

- Class 88 Doumet 1982, Pl. XIII.55, 58
- Class 90a Doumet 1982, Pl. XIII.46
- Class 102a Doumet 1982, Pl. XVIII.6, 94
- Class 107a Doumet 1982, Pl. XIV.28
- Class 107b Doumet 1982, Pl. XIV.8
- Class 143 Doumet 1982, Pl. XVI.90
- Class 144b Doumet 1982, Pl. XVIII.78
- Class 145b Doumet 1982, Pl. XVI.23, 72, 89
- Class 151 Doumet 1982, Pl. XVI.31
- Class 160a Doumet 1982, Pl. XVIII.61
- Class 160b Doumet 1982, Pl. XVII.20
- Class 162 Doumet 1982, Pl. XV.5, 24, 41, 86
- Class 162 Doumet 1982, Pl. XVI.49
- Class 164 Doumet 1982, Pl. XV.128, 133
- Class 164 Doumet 1982, Pl. XVI.134
- Class 172 Doumet 1982, Pl. XVI.56
- Class 173a Doumet 1982, Pl. XVII.10
- Class 179 Doumet 1982, Pl. XVI.32, 57, 80

### Tomb V

- Class 12c Doumet 1982, Pl. XXII.4
- Class 18 Doumet 1982, Pl. XXII.1
- Class 193 Doumet 1982, Pl. XXII.2

### Unstratified

- Class 24a Macridi-Bey 1904a, Pl. 6.19
- Class 42 Macridi-Bey 1904a, Pl. 6.1, 3, 13-15
- Class 42 Culican 1982, Pl. 11a-b
- Class 42 Doumet-Serhal 2003a, Fig. 11
- Class 42 Bordreuil 2004, Figs 4, 7
- Class 46 Culican 1982, Pl. 11c
- Class 47 Doumet-Serhal 2003a, Fig. 4
- Class 61 Macridi-Bey 1904a, Pl. 6.22
- Class 62 Culican 1982, Pl. 11d
- Class 77 Macridi-Bey 1904a, Pl. 6.11
- Class 82a Macridi-Bey 1904a, Pl. 6.2
- Class 82e Macridi-Bey 1904a, Pl. 6.20
- Class 84 Macridi-Bey 1904a, Pl. 6.7
- Class 85a Macridi-Bey 1904a, Pl. 6.6
- Class 88 Macridi-Bey 1904a, Pl. 6.12
- Class 100b Macridi-Bey 1904a, Pl. 6.5
- Class 102b Macridi-Bey 1904a, Pl. 6.8-9
- Class 107a Macridi-Bey 1904a, Pl. 6.17

## C.40 Ras al-Bassit

### Necropolis Iron II

- Class 57c Courbin 1993a, Fig. 7.3(C537)
- Class 62 Courbin 1993a, Fig. 12.3(C530)
- Class 62 Courbin 1993a, Fig. 13.1(C1)
- Class 84 Courbin 1993a, Fig. 16.2(C1079), 3(C1080)
- Class 174 Courbin 1993a, Fig. 9.2(C1078)
- Class 188 Courbin 1993a, Fig. 16.4(C531)

### Necropolis Iron IIB

- Class 18 Courbin 1993a, Fig. 5.3(C516)
- Class 19 Courbin 1993a, Fig. 5.5(C542)

- Class 19 Courbin 1993a, Fig. 11.1(C519)
  - Class 19 Courbin 1993a, Fig. 11.3(C128)
  - Class 19 Courbin 1993a, Fig. 11.4(C1075)
  - Class 42 Courbin 1993a, Fig. 13.4(C545)
  - Class 44 Courbin 1993a, Fig. 17.1(C539)
  - Class 59 Courbin 1993a, Fig. 7.2(C910)
  - Class 62 Courbin 1993a, Fig. 11.2(C514)
  - Class 102b Courbin 1993a, Fig. 9.3(C1064)
  - Class 124 Courbin 1993a, Fig. 9.1(C5099)
  - Class 145a Courbin 1993a, Fig. 16.5(C540)
- ### Necropolis Iron II-III



Class 19 Courbin 1993a, Fig. 5.6(C524)  
Class 42 Courbin 1993a, Fig. 14.2(C507)  
Class 42 Courbin 1993a, Fig. 14.3(C528)  
**Necropolis Iron III**  
Class 24b Courbin 1993a, Fig. 5.4(C1882)  
Class 24b Courbin 1993a, Fig. 10.2(C1878),  
3(C1880)

Class 24b Courbin 1993a, Fig. 10.4(C6964)  
Class 26 Courbin 1993a, Fig. 10.7(CC5753)  
Class 42 Courbin 1993a, Fig. 14.1(C1081)  
Class 42 Courbin 1993a, Fig. 14.4(C1070)  
Class 42 Courbin 1993a, Fig. 14.5(C5752)  
Class 42 Courbin 1993a, Fig. 15.1(C523)  
Class 57b Courbin 1993a, Fig. 7.4(C511)  
Class 59 Courbin 1993a, Fig. 6.1(C520)  
Class 59 Courbin 1993a, Fig. 7.1(C518)  
Class 62 Courbin 1993a, Fig. 7.5(C529)  
Class 62 Courbin 1993a, Fig. 12.5(C546)  
Class 62 Courbin 1993a, Fig. 13.3(C522)  
Class 80 Courbin 1993a, Fig. 16.1(C1068)  
Class 80 Courbin 1993a, Fig. 15.2(C515)  
Class 80 Courbin 1993a, Fig. 15.3(C1881)  
Class 80 Courbin 1993a, Fig. 15.4(C1066)  
Class 80 Courbin 1993a, Fig. 15.5(C1070)  
Class 100b Courbin 1993a, Fig. 9.5(C1861)  
Class 101 Courbin 1993a, Fig. 9.4(C1071)  
Class 136 Courbin 1993a, Fig. 9.7(C527)  
Class 165a Courbin 1993a, Fig. 6.6(C1069)  
Class 173a Courbin 1993a, Fig. 20.1(V634)

#### **Necropolis Persian**

Class 24b Courbin 1993a, Fig. 10.1(C1818)  
Class 58 Courbin 1993a, Fig. 17.3(C567)  
Class 122 Courbin 1993a, Fig. 17.8(C569)  
Class 191 Courbin 1993a, Fig. 17.4(C563)  
Class 191 Courbin 1993a, Fig. 17.5(C564)  
Class 191 Courbin 1993a, Fig. 17.6(C565)

#### **Assemblage A**

Class 139 Braemer 1986, Fig. 1.1  
Class 168 Braemer 1986, Fig. 1.2  
Class 174 Braemer 1986, Fig. 1.3

#### **Assemblage B**

Class 155 Braemer 1986, Fig. 2.4  
Class 182a Braemer 1986, Fig. 2.5

#### **Assemblage C**

Class 140 Braemer 1986, Fig. 3.13  
Class 144a Braemer 1986, Fig. 3.10  
Class 155 Braemer 1986, Fig. 3.7  
Class 160a Braemer 1986, Fig. 3.9  
Class 173a Braemer 1986, Fig. 3.12  
Class 182b Braemer 1986, Fig. 3.11  
Class 191 Braemer 1986, Fig. 3.8

#### **Assemblage D**

Class 87 Braemer 1986, Fig. 4.21  
Class 134a Braemer 1986, Fig. 4.17  
Class 141a Braemer 1986, Fig. 4.20  
Class 144a Braemer 1986, Fig. 4.19  
Class 155 Braemer 1986, Fig. 4.15-16  
Class 160a Braemer 1986, Fig. 4.18

#### **Assemblage E**

Class 91 Braemer 1986, Fig. 5.29  
Class 139 Braemer 1986, Fig. 5.26  
Class 141c Braemer 1986, Fig. 5.27  
Class 143 Braemer 1986, Fig. 5.28  
Class 144a Braemer 1986, Fig. 5.25  
Class 157 Braemer 1986, Fig. 5.23  
Class 162 Braemer 1986, Fig. 5.24  
Class 182b Braemer 1986, Fig. 5.22

#### **Assemblage F**

Class 150 Braemer 1986, Fig. 6.31  
Class 160a Braemer 1986, Fig. 6.32  
Class 172 Braemer 1986, Fig. 6.33

#### **Assemblage G**

Class 144b Braemer 1986, Fig. 7.35  
Class 150 Braemer 1986, Fig. 7.38  
Class 172 Braemer 1986, Fig. 7.39  
Class 182a Braemer 1986, Fig. 7.34

#### **Assemblage H**

Class 141a Braemer 1986, Fig. 8.43  
Class 160a Braemer 1986, Fig. 8.44  
Class 169 Braemer 1986, Fig. 8.41

#### **Tell level 3**

Class 80 Courbin 1982a, Fig. 1-2

#### **Tell level 7**

Class 148 Courbin 1978, Pl. 18.15

#### **Unstratified**

Class 42 Courbin 1986, Fig. 11  
Class 174 Courbin 1986, Fig. 16  
Class 174 Courbin 1982a, Fig. 4

## **C.41 Ras Ibn Hani**

### **Iron I**

Class 1a Bounni et al. 1979, Fig. 27.1-2  
Class 16b Bounni et al. 1979, Fig. 26.4-7  
Class 42 Badre 1983, Fig. 1f  
Class 42 Badre 1983, Fig. 2c-d  
Class 48b Badre 1983, Fig. 2e  
Class 54 Badre 1983, Fig. 1b  
Class 56 Bounni et al. 1979, Fig. 25.8  
Class 56 Badre 1983, Fig. 1a, e  
Class 134a Bounni et al. 1979, Fig. 25.4  
Class 134b Bounni et al. 1979, Fig. 25.5-6  
Class 172 Bounni et al. 1979, 249, Fig. 25.4-6  
Class 182a Bounni et al. 1979, Fig. 25.9

Class 188 Badre 1983, Fig. 1g

### **Iron II/III**

Class 132 Lagarce 1983, Pl. 61.2.2  
Class 134e Bounni et al. 1976a, Fig. 27.13  
Class 141a Bounni et al. 1976a, Fig. 27.16  
Class 144a Bounni et al. 1976a, Fig. 27.9  
Class 144b Bounni et al. 1976a, Fig. 27.17  
Class 151 Lagarce 1983, Pl. 61.1.3  
Class 152 Bounni et al. 1976a, Fig. 27.11  
Class 173a Bounni et al. 1976a, Fig. 27.12  
Class 188 Bounni et al. 1978, 283, Fig. 29.3

#### **Unstratified**

Class 48b Bounni et al. 1976a, Fig. 28.17  
Class 80 Bounni et al. 1978, Figs 31.8; 32

Class 82a Bounni et al. 1978, Fig. 31.13  
Class 116 Bounni et al. 1976a, Fig. 28.16

## C.42 Rehov, Tel

### Area C/E level 1

Class 6 A. Mazar 1999a, Fig. 24.10  
Class 8b A. Mazar 1999a, Fig. 24.8  
Class 8c A. Mazar 1999a, Fig. 24.9  
Class 12c A. Mazar 1999a, Fig. 24.19  
Class 16c A. Mazar 1999a, Fig. 24.13  
Class 17 A. Mazar 1999a, Fig. 24.12  
Class 54 A. Mazar 1999a, Fig. 24.7

Class 55 A. Mazar 1999a, Fig. 24.6  
Class 57b A. Mazar 1999a, Fig. 24.14  
Class 64 A. Mazar 1999a, Fig. 24.15  
Class 71b A. Mazar 1999a, Fig. 24.17  
Class 123 A. Mazar 1999a, Fig. 24.18  
Class 134a A. Mazar 1999a, Fig. 24.3-4  
Class 155 A. Mazar 1999a, Fig. 24.1  
Class 164 A. Mazar 1999a, Fig. 24.2

## C.43 Rifa'at, Tell

### Stratum 1c

Class 93a see Lehmann 1996, 411 (Form 267b)  
Class 134d Lehmann 1996, Pl. 12 (62/3)  
Class 174 see Lehmann 1996, 360 (Form 1-4)  
Class 193 Lehmann 1996, Pl. 28 (174/1)  
Class 193 Lehmann 1996, Pl. 28 (174/3)

### Stratum 2a

Class 1a see Lehmann 1996, 450 (Form 438a)  
Class 9b Lehmann 1996, Pl. 84 (443/1)  
Class 54 see Lehmann 1996, 370 (Form 61a)  
Class 93a Lehmann 1996, Pl. 44 (267a/1)  
Class 121e Lehmann 1996, Pl. 17 (89c/1)  
Class 139 see Lehmann 1996, 379 (Form 101)  
Class 162 Lehmann 1996, Pl. 24 (153/1)  
Class 166 see Lehmann 1996, 360 (Form 2)  
Class 166 see Lehmann 1996, 361 (Form 4)  
Class 170 Lehmann 1996, Pl. 5 (22/2)  
Class 173a Lehmann 1996, Pl. 19 (104/1)  
Class 173b Lehmann 1996, Pl. 2 (4/5-6, 8)  
Class 174 see Lehmann 1996, 360 (Form 1-4)  
Class 184 see Lehmann 1996, 378 (Form 94)

### Stratum 2b-c

Class 1a see Lehmann 1996, 450 (Form 438a)  
Class 5 see Lehmann 1996, 452 (Form 444)  
Class 33 see Lehmann 1996, 429 (Form 364)  
Class 37b Matthers 1981b, Fig. 233.10-11  
Class 37b see Lehmann 1996, 428 (Form 363)  
Class 53b Seton Williams 1967, Fig. 2.b-c  
Class 53b see Lehmann 1996, 395 (Form 191)  
Class 56 Seton Williams 1961, Pl. 39.15  
Class 84 Matthers 1981b, Fig. 233.9  
Class 105 Lehmann 1996, Pl. 47 (285/3)  
Class 121d Lehmann 1996, Pl. 54 (328/2)  
Class 121e Seton Williams 1961, Pl. 38.4  
Class 137 Seton Williams 1961, Pl. 38.14  
Class 137 Seton Williams 1961, Pl. 39.1  
Class 137 Matthers 1981b, Fig. 235.16  
Class 162 Seton Williams 1961, Pl. 39.9  
Class 162 Matthers 1981b, Fig. 233.8  
Class 164 Seton Williams 1967, Fig. 1.d, f  
Class 165a Seton Williams 1967, Fig. 1.c, e  
Class 165b Seton Williams 1967, Fig. 1.a

Class 165b see Lehmann 1996, 361 (Form 9)  
Class 166 Matthers 1981b, Fig. 233.3  
Class 168 Seton Williams 1967, Fig. 1.b  
Class 170 Seton Williams 1967, Fig. 2.a  
Class 170 Lehmann 1996, Pl. 4 (16/2+3)  
Class 170 Lehmann 1996, Pl. 8 (48/1)  
Class 172 Lehmann 1996, Pl. 20 (108/1)  
Class 173b Matthers 1981b, Fig. 233.2  
Class 174 Seton Williams 1961, Pl. 38.7  
Class 174 Matthers 1981b, Fig. 235.5  
Class 174 see Lehmann 1996, 360 (Form 1-4)  
Class 175 Matthers 1981b, Fig. 235.4, 7  
Class 176 Matthers 1981b, Fig. 235.1-2  
Class 176 see Lehmann 1996, 360 (Form 1)  
Class 179 Matthers 1981b, Fig. 233.1  
Class 182a Matthers 1981b, Fig. 233.5-7  
Class 182c Seton Williams 1961, Pl. 39.12  
Class 182c Matthers 1981b, Fig. 235.6  
Class 184 Seton Williams 1961, Pl. 39.5  
Class 184 Lehmann 1996, Pl. (94/1)  
Class 187 Seton Williams 1961, Pl. 38.8  
Class 187 Seton Williams 1961, Pl. 39.11  
Class 187 Matthers 1981b, Fig. 235.8  
Class 188 Seton Williams 1961, Pl. 38.11

### Stratum 2-3

Class 1a see Lehmann 1996, 450 (Form 438b)  
Class 4d Seton Williams 1961, Pl. 39.13  
Class 54 see Lehmann 1996, 371 (Form 61a)  
Class 141b Lehmann 1996, Pl. 21 (124/1)  
Class 141d Lehmann 1996, Pl. 13 (68/2)  
Class 142 Lehmann 1996, Pl. 29 (177/1)  
Class 153 Seton Williams 1961, Pl. 38.2  
Class 168 Seton Williams 1961, Pl. 38.3  
Class 173b Lehmann 1996, Pl. 2 (4/4+7)  
Class 174 see Lehmann 1996, 360 (Form 1-4)  
Class 176 Lehmann 1996, Pl. 1 (2/3+4)

### Stratum 3

Class 152 Seton Williams 1961, Pl. 38.6  
Class 165a Seton Williams 1961, Pl. 39.3  
Class 186 Seton Williams 1961, Pl. 40.2  
Class 187 Seton Williams 1961, Pl. 38.9

### Unstratified

Class 1a Lehmann 1996, Pl. 83 (438a/1)

Class 1a see Lehmann 1996, 450 (Form 438a)  
Class 1b Lehmann 1996, Pl. 83 (438a/2)  
Class 9b Lehmann 1996, Pl. 84 (442/1)  
Class 28 Lehmann 1996, Pl. 78 (420/4)  
Class 53b see Lehmann 1996, 427 (Form 362)  
Class 139 Lehmann 1996, Pl. 19 (101/2)  
Class 141c see Lehmann 1996, 369 (Form 59)

Class 147 Lehmann 1996, Pl. 8 (177/1)  
Class 152 see Lehmann 1996, 380 (Form 109)  
Class 166 see Lehmann 1996, 361 (Form 4)  
Class 173a see Lehmann 1996, 380 (Form 104)  
Class 174 see Lehmann 1996, 360 (Form 1-4)

## C.44 Sarepta

### Area X level V

Class 4b Khalifeh 1988, Type CP14  
Class 4c Khalifeh 1988, Type CP6  
Class 6 Khalifeh 1988, Type CP10, CP11  
Class 8a Khalifeh 1988, Type CP16  
Class 12b Khalifeh 1988, Type L5, L7  
Class 54 Khalifeh 1988, Type K7  
Class 56 Khalifeh 1988, Type K5, K6, K8, K9  
Class 102d Khalifeh 1988, Type PF4, PF5, PF6

Class 131a Khalifeh 1988, Type B29  
Class 134a Khalifeh 1988, Type X6  
Class 141a Khalifeh 1988, Type X12  
Class 151 Khalifeh 1988, Type X9  
Class 151 Khalifeh 1988, Type X21  
Class 162 Khalifeh 1988, Type X26  
Class 170 Khalifeh 1988, Type X17  
Class 173a Khalifeh 1988, Type X29  
Class 175 Khalifeh 1988, Type X25  
Class 182a Khalifeh 1988, Type F4  
Class 184 Khalifeh 1988, Type X24  
Class 188 Khalifeh 1988, Type X23  
Class 189 Khalifeh 1988, Type F5

### Area X level VI

Class 6 Khalifeh 1988, Type CP11  
Class 54 Khalifeh 1988, Type K7  
Class 56 Khalifeh 1988, Type K5, K6, K8, K9  
Class 89 Khalifeh 1988, Type DJ3  
Class 102b Khalifeh 1988, Type PF2  
Class 141a Khalifeh 1988, Type X12  
Class 151 Khalifeh 1988, Type X9  
Class 155 Khalifeh 1988, Type F1  
Class 160a Khalifeh 1988, Type F2  
Class 170 Khalifeh 1988, Type X17  
Class 173a Khalifeh 1988, Type X29

### Area X level VII

Class 12c Khalifeh 1988, Type L9  
Class 54 Khalifeh 1988, Type K7  
Class 56 Khalifeh 1988, Type K5, K6; K8, K9  
Class 100b Khalifeh 1988, Type J1, J3  
Class 141a Khalifeh 1988, Type X12  
Class 144b Khalifeh 1988, Type X2  
Class 145a Khalifeh 1988, Type X1, X4, X5  
Class 151 Khalifeh 1988, Type X9  
Class 155 Khalifeh 1988, Type F1  
Class 160a Khalifeh 1988, Type F2  
Class 173a Khalifeh 1988, Type X29  
Class 179 Khalifeh 1988, Type X11

### Area X level VIII

Class 12c Khalifeh 1988, Type L9

Class 89 Khalifeh 1988, Type DJ3  
Class 100b Khalifeh 1988, Type J1, J3  
Class 102b Khalifeh 1988, Type PF2  
Class 141a Khalifeh 1988, Type X12  
Class 144b Khalifeh 1988, Type X2, X10  
Class 145a Khalifeh 1988, Type X1, X4, X5  
Class 151 Khalifeh 1988, Type X9  
Class 155 Khalifeh 1988, Type F1  
Class 160a Khalifeh 1988, Type F2  
Class 170 Khalifeh 1988, Type X17  
Class 173a Khalifeh 1988, Type X29  
Class 179 Khalifeh 1988, Type X11

### Area X unstratified

Class 4b Pritchard 1988, Fig. 53.1  
Class 4c Pritchard 1988, Fig. 53.4  
Class 6 Pritchard 1988, Fig. 53.2  
Class 9a Pritchard 1988, Fig. 53.5-6  
Class 12a Pritchard 1988, Fig. 56.1  
Class 12b Pritchard 1988, Fig. 56.2-4  
Class 12c Pritchard 1988, Figs 56.5-9; 57.10-15

Class 18 Pritchard 1988, Fig. 43.1, 9-10  
Class 19 Pritchard 1988, Fig. 43.4  
Class 24b Pritchard 1988, Fig. 43.2  
Class 26 Pritchard 1988, Fig. 43.3, 5, 8, 11  
Class 42 Pritchard 1988, Fig. 43.12  
Class 47 Pritchard 1988, Fig. 40.30  
Class 71a Pritchard 1988, Fig. 47.13  
Class 73 Pritchard 1988, Fig. 47.14  
Class 77 Pritchard 1988, Fig. 45.2  
Class 77 Pritchard 1988, Fig. 46.3-5  
Class 78 Pritchard 1988, Fig. 45.1  
Class 79 Pritchard 1988, Fig. 47.16  
Class 80 Koehl 1985, Fig. 21.217  
Class 85a Pritchard 1988, Fig. 47.18-19  
Class 88 Pritchard 1988, Fig. 46.7  
Class 88 Pritchard 1988, Fig. 47.10-11  
Class 89 Pritchard 1988, Fig. 46.8  
Class 90a Pritchard 1988, Fig. 46.9  
Class 90b Pritchard 1988, Fig. 47.17  
Class 100b Pritchard 1988, Fig. 49.1-15  
Class 102a Pritchard 1988, Fig. 52.2-6  
Class 102b Pritchard 1988, Fig. 52.1  
Class 104 Koehl 1985, Fig. 18.154-155  
Class 107a Pritchard 1988, Fig. 46.6  
Class 109 Pritchard 1988, Fig. 61.4  
Class 111 Pritchard 1988, Fig. 61.2  
Class 115 Pritchard 1988, Fig. 63.1-5  
Class 115 Pritchard 1988, Fig. 64.1-5  
Class 121e Khalifeh 1988, Pl. 24.3

Class 129 Pritchard 1988, Fig. 59.1, 3-4  
 Class 130 Pritchard 1988, Fig. 59.2  
 Class 132 Pritchard 1988, Fig. 61.8-10  
 Class 133 Pritchard 1988, Fig. 57.18  
 Class 134a Pritchard 1988, Fig. 38.8  
 Class 141a Pritchard 1988, Fig. 38.3-4, 9, 16  
 Class 141c Pritchard 1988, Fig. 40.28  
 Class 144a Pritchard 1988, Fig. 38.10  
 Class 145a Pritchard 1988, Fig. 38.11-12  
 Class 148 Pritchard 1988, Fig. 41.36  
 Class 151 Pritchard 1988, Fig. 38.13-14  
 Class 153 Pritchard 1988, Fig. 39.27  
 Class 157 Pritchard 1988, Fig. 38.1  
 Class 159 Pritchard 1988, Fig. 39.26  
 Class 160a Pritchard 1988, Fig. 38.2  
 Class 162 Koehl 1985, Fig. 22.246  
 Class 162 Pritchard 1988, Fig. 41.31, 33-34  
 Class 164 Pritchard 1988, Fig. 39.19-20, 22,  
 25  
 Class 170 Pritchard 1988, Fig. 38.17  
 Class 170 Pritchard 1988, Fig. 39.24  
 Class 173a Pritchard 1988, Fig. 38.5-6  
 Class 173a Pritchard 1988, Fig. 39.21, 23  
 Class 179 Pritchard 1988, Fig. 38.7, 15  
 Class 179 Pritchard 1988, Fig. 39.18  
 Class 188 Koehl 1985, Fig. 20. 193  
 Class 188 Koehl 1985, Figs 20.194-196;  
 21.212  
 Class 188 Pritchard 1988, Fig. 59.7  
 Class 191 Koehl 1985, Fig. 23.251-252  
 Class 193 Pritchard 1988, Fig. 40.29  
**Area Y level B**  
 Class 12c Anderson 1988, Pl. 38.18  
 Class 18 Anderson 1988, Pl. 38.24  
 Class 100b Anderson 1988, Pl. 38.17  
 Class 141a Anderson 1988, Pl. 38.14-15  
 Class 145a Anderson 1988, Pl. 38.13  
 Class 151 Anderson 1988, Pl. 38.19-20  
 Class 156 Anderson 1988, Pl. 38.16  
 Class 160a Anderson 1988, Pl. 38.22  
**Area Y level C**  
 Class 4b Anderson 1988, Pl. 36.8  
 Class 10 Anderson 1988, Pl. 35.21-22  
 Class 24a Anderson 1988, Pl. 37.11, 13  
 Class 24b Anderson 1988, Pl. 37.12  
 Class 82e Anderson 1988, Pl. 37.1  
 Class 85b Anderson 1988, Pl. 36.9  
 Class 100b Anderson 1988, Pl. 37.2  
 Class 100b Anderson 1988, Pl. 38.8  
 Class 120 Anderson 1988, Pl. 36.11  
 Class 141a Anderson 1988, Pl. 35.1, 5, 12  
 Class 141a Anderson 1988, Pl. 38.9  
 Class 141c Anderson 1988, Pl. 36.17  
 Class 144a Anderson 1988, Pl. 38.1  
 Class 144b Anderson 1988, Pls 35.7-9, 18;  
 36.13  
 Class 145a Anderson 1988, Pl. 35.17  
 Class 145a Anderson 1988, Pls 35.16; 36.16,  
 18-23  
 Class 145b Anderson 1988, Pl. 35.13-14

Class 155 Anderson 1988, Pl. 38.3-4  
 Class 160a Anderson 1988, Pl. 35.11  
 Class 160a Anderson 1988, Pl. 38.2  
 Class 161 Anderson 1988, Pl. 35.2-3  
 Class 162 Anderson 1988, Pl. 35.19  
 Class 163 Anderson 1988, Pl. 38.11  
 Class 170 Anderson 1988, Pl. 37.5, 8  
 Class 172 Anderson 1988, Pl. 35.10  
 Class 173a Anderson 1988, Pl. 35.20  
 Class 176 Anderson 1988, Pl. 35.15  
 Class 179 Anderson 1988, Pl. 35.6  
 Class 179 Anderson 1988, Pl. 36.15  
 Class 193 Anderson 1988, Pl. 37.10  
**Area Y level D**  
 Class 4c Anderson 1988, Pl. 33.16  
 Class 6 Anderson 1988, Pl. 33.10, 15  
 Class 12b Anderson 1988, Pl. 32.18  
 Class 12b Anderson 1988, Pl. 34.16  
 Class 24b Anderson 1988, Pl. 32.7  
 Class 56 Anderson 1988, Pl. 34.10  
 Class 70 Anderson 1988, Pl. 33.4  
 Class 80 Anderson 1988, Pl. 32.20  
 Class 80 Anderson 1988, Pl. 34.17  
 Class 82a Anderson 1988, Pl. 34.5  
 Class 100b Anderson 1988, Pl. 33.23-24  
 Class 129 Anderson 1988, Pl. 33.18  
 Class 132 Anderson 1988, Pl. 33.5  
 Class 134b Anderson 1988, Pl. 33.17  
 Class 134d Anderson 1988, Pl. 33.20  
 Class 141a Anderson 1988, Pl. 34.3  
 Class 157 Anderson 1988, Pl. 33.19, 27  
 Class 162 Anderson 1988, Pl. 32.17  
 Class 162 Anderson 1988, Pl. 33.11, 13  
 Class 170 Anderson 1988, Pl. 32.13  
 Class 172 Anderson 1988, Pl. 33.14  
 Class 173a Anderson 1988, Pl. 32.16  
 Class 173a Anderson 1988, Pl. 33.7, 9  
 Class 174 Anderson 1988, Pl. 32.9-10  
 Class 176 Anderson 1988, Pl. 33.8  
 Class 182a Anderson 1988, Pl. 33.22  
 Class 182c Anderson 1988, Pl. 33.25  
 Class 188 Anderson 1988, Pl. 32.19  
**Area Y level E**  
 Class 8d Anderson 1988, Pl. 31.24  
 Class 13 Anderson 1988, Pl. 31.20  
 Class 54 Anderson 1988, Pl. 31.3-4  
 Class 85b Anderson 1988, Pl. 31.15  
 Class 100b Anderson 1988, Pl. 31.22  
 Class 102b Anderson 1988, Pl. 31.17  
 Class 134d Anderson 1988, Pl. 31.11  
 Class 153 Anderson 1988, Pl. 31.16  
 Class 159 Anderson 1988, Pl. 31.18  
 Class 161 Anderson 1988, Pl. 31.19  
 Class 162 Anderson 1988, Pl. 31.14  
 Class 173a Anderson 1988, Pl. 31.12  
 Class 182c Anderson 1988, Pl. 31.13  
**Area Y level F**  
 Class 6 Anderson 1988, Pl. 30.1  
 Class 7a Anderson 1988, Pl. 30.6  
 Class 8d Anderson 1988, Pl. 30.3

Class 12b Anderson 1988, Pl. 30.14  
 Class 38a Anderson 1988, Pl. 30.7  
 Class 56 Anderson 1988, Pl. 30.8-9  
 Class 100b Anderson 1988, Pl. 30.5  
 Class 102a Anderson 1988, Pl. 29.29  
 Class 131b Anderson 1988, Pl. 29.21  
 Class 134a Anderson 1988, Pl. 29.11  
 Class 152 Anderson 1988, Pl. 29.30  
 Class 160b Anderson 1988, Pl. 29.22  
 Class 162 Anderson 1988, Pl. 29.20  
 Class 164 Anderson 1988, Pl. 29.18  
 Class 170 Anderson 1988, Pl. 29.15-16, 19  
 Class 173a Anderson 1988, Pl. 29.17  
 Class 174 Anderson 1988, Pl. 29.14  
 Class 182a Anderson 1988, Pl. 29.31-32  
 Class 188 Anderson 1988, Pl. 30.10  
 Class 189 Anderson 1988, Pl. 29.24  
**Area Y level G**  
 Class 4c Anderson 1988, Pl. 28.9  
 Class 6 Anderson 1988, Pl. 28.7-8  
 Class 8a Anderson 1988, Pl. 28.11  
 Class 13 Anderson 1988, Pl. 28.18  
 Class 16a Anderson 1988, Pl. 26.1  
 Class 20 Anderson 1988, Pl. 27.7  
 Class 54 Anderson 1988, Pl. 26.8-9  
 Class 56 Anderson 1988, Pl. 26.4, 6  
 Class 56 Anderson 1988, Pl. 28.1-5  
 Class 102a Anderson 1988, Pl. 27.1  
 Class 102b Anderson 1988, Pl. 26.17  
 Class 102b Anderson 1988, Pl. 28.12, 16-17  
 Class 103b Anderson 1988, Pl. 28.6  
 Class 104 Anderson 1988, Pls 26.24; 27.4-6;  
 28.21-22  
 Class 134a Anderson 1988, Pl. 26.7  
 Class 143 Anderson 1988, Pl. 26.10

Class 158a Anderson 1988, Pl. 27.12  
 Class 162 Anderson 1988, Pl. 26.12  
 Class 170 Anderson 1988, Pl. 26.13  
 Class 170 Anderson 1988, Pl. 27.13-14  
 Class 172 Anderson 1988, Pl. 26.11  
 Class 174 Anderson 1988, Pl. 27.15  
 Class 184 Anderson 1988, Pl. 27.18  
 Class 188 Anderson 1988, Pl. 26.20, 22, 26  
 Class 188 Anderson 1988, Pl. 27.19  
 Class 188 Anderson 1988, Pl. 28.19  
 Class 189 Anderson 1988, Pl. 26.21  
**Tomb 16**  
 Class 87 Culican 1970, Fig. 3.10  
**Tomb 26**  
 Class 12c Culican 1970, Fig. 3.4  
 Class 20 Culican 1970, Fig. 3.6  
 Class 85a Culican 1970, Fig. 3.8  
 Class 89 Culican 1970, Fig. 3.7  
 Class 92 Culican 1970, Fig. 3.5  
 Class 102b Culican 1970, Fig. 3.9  
 Class 144b Culican 1970, Fig. 3.1  
 Class 154 Culican 1970, Fig. 3.2  
 Class 167 Culican 1970, Fig. 3.3  
**Tomb 42**  
 Class 12c Culican 1975, Fig. 2c  
 Class 87 Saidah 1983, Pl. 55.1  
 Class 89 Culican 1975, Fig. 2b  
 Class 91 Culican 1975, Fig. 2a  
 Class 100b Saidah 1983, Pl. 55.1  
 Class 102b Saidah 1983, Pl. 55.1  
 Class 109 Saidah 1983, Pl. 55.1  
**Unstratified**  
 Class 85b Archaeology 24(1971), 62  
 Class 90a Seeden 1991, Figs 46-47

## C.45 Sheikh Hassan, Tell

### Assemblage 3

Class 1a Schneider 1999a, Fig. 9.15(1)  
 Class 2 Schneider 1999a, Fig. 9.15(2-3)  
 Class 7b Schneider 1999a, Fig. 10.17  
 Class 15 Schneider 1999a, Fig. 11.20(3)  
 Class 15 Schneider 1999a, Fig. 12.20  
 Class 37a Schneider 1999a, Fig. 12.21(1)  
 Class 40a Schneider 1999a, Fig. 3.3  
 Class 40a Schneider 1999a, Fig. 8.13(1-2)  
 Class 52 Schneider 1999a, Fig. 12.21(3-4)  
 Class 53c Schneider 1999a, Fig. 3.1  
 Class 56 Schneider 1999a, Fig. 8.13(3); 14(1)  
 Class 108 Schneider 1999a, Fig. 16.27, 29  
 Class 121e Schneider 1999a, Fig. 7.11(5-6)  
 Class 134d Schneider 1999a, Fig. 5.5-6  
 Class 141a Schneider 1999a, Fig. 5.3-4, 6  
 Class 141b Schneider 1999a, Fig. 4.2(1-2)  
 Class 141c Schneider 1999a, Fig. 4.2(3)  
 Class 141d Schneider 1999a, Fig. 6.7(3)

Class 155 Schneider 1999a, Fig. 7.11(1)  
 Class 170 Schneider 1999a, Fig. 6.8(2)  
 Class 171 Schneider 1999a, Fig. 4.1(1-2)  
 Class 171 Schneider 1999a, Fig. 4.3  
 Class 173a Schneider 1999a, Fig. 6.8(1)  
 Class 179 Schneider 1999a, Fig. 4.1(4)  
 Class 182b Schneider 1999a, Fig. 16.30  
 Class 182c Schneider 1999a, Fig. 6.7(4)  
 Class 184 Schneider 1999a, Fig. 7.11(7)  
**Unstratified**  
 Class 48b Boese 1995, 72, Fig. 9b  
 Class 53c Boese 1995, 72, Fig. 9a  
 Class 121e Schneider 1999b, Fig. 1  
 Class 139 Schneider 1999b, Fig. 4c  
 Class 141a Schneider 1999b, Fig. 5d(1)  
 Class 141a Schneider 1999b, Figs 6-7  
 Class 141b Schneider 1999b, Fig. 5d(2-6)  
 Class 187 Schneider 1999b, Fig. 3.5-6

## C.46 Shiyukh Fawqani, Tell

### Area F (IX)

Class 1a Makinson 2005, Pl. 11.66-67  
Class 1a Makinson 2005, Pl. 12.70-71  
Class 1a Makinson 2005, Pl. 13.76-79  
Class 1b Makinson 2005, Pl. 12.69, 72  
Class 1b Makinson 2005, Pl. 13.74-75  
Class 1c Makinson 2005, Pl. 13.81  
Class 4c Makinson 2005, Pl. 13.80  
Class 15 Makinson 2005, Pl. 26.176-178  
Class 28 Makinson 2005, Pl. 23.146-148  
Class 37b Makinson 2005, Pl. 14.82  
Class 42 Makinson 2005, Pl. 15.92  
Class 50 Makinson 2005, Pl. 14.85-88  
Class 50 Makinson 2005, Pl. 15.90  
Class 57a Makinson 2005, Pl. 20.128  
Class 71a Makinson 2005, Pl. 23.150-153  
Class 118 Makinson 2005, Pl. 20.130, 132  
Class 118 Makinson 2005, Pl. 22.143  
Class 119 Makinson 2005, Pl. 25.168  
Class 121d Makinson 2005, Pl. 21.138  
Class 121e Bachelot 1999, Fig. 10  
Class 121e Makinson 2005, Pl. 10.52-53, 55,  
58

Class 121e Makinson 2005, Pl. 22.141  
Class 134a Makinson 2005, Pl. 3.13  
Class 139 Makinson 2005, Pl. 4.19  
Class 141a Makinson 2005, Pl. 5.24-25  
Class 141a Makinson 2005, Pl. 6.26-30  
Class 141b Makinson 2005, Pl. 2.11  
Class 141b Makinson 2005, Pl. 3.14  
Class 141c Makinson 2005, Pl. 5.22-23  
Class 143 Makinson 2005, Pl. 3.16  
Class 152 Makinson 2005, Pl. 4.18  
Class 170 Makinson 2005, Pl. 2.10  
Class 173a Makinson 2005, Pl. 1.4  
Class 176 Makinson 2005, Pl. 1.1-3, 5-6

### Area F (X)

Class 1a Makinson 2005, Pl. 34.225  
Class 1b Makinson 2005, Pl. 34.224  
Class 15 Makinson 2005, Pl. 36.241  
Class 24b Makinson 2005, Pl. 35.230  
Class 118 Makinson 2005, Pl. 35.231  
Class 141a Makinson 2005, Pl. 31.207-210

### Area G level 1

Class 1a Luciani 2005, Pl. 51.598  
Class 1b Luciani 2005, Pl. 51.599-600  
Class 1c Luciani 2005, Pl. 52.601  
Class 5 Luciani 2005, Pl. 56.637-638  
Class 7b Luciani 2005, Pl. 56.639-642  
Class 40b Luciani 2005, Pl. 55.636  
Class 57a Luciani 2005, Pl. 82.102  
Class 63 Luciani 2000, Fig. 3.5  
Class 74 Luciani 2005, Pl. 80.94  
Class 121e Luciani 2005, Pl. 36.433-436  
Class 134d Luciani 2005, Pl. 40.472-473  
Class 134e Luciani 2005, Pl. 40.479  
Class 134e Luciani 2005, Pl. 41.480

Class 135 Luciani 2005, Pl. 40.476  
Class 138 Luciani 2005, Pl. 37.453  
Class 141a Luciani 2005, Pl. 43.498-504  
Class 141b Luciani 2005, Pl. 38.460  
Class 141c Luciani 2005, Pl. 38.464  
Class 141c Luciani 2005, Pl. 39.467-469  
Class 143 Luciani 2005, Pl. 33.402-403  
Class 157 Luciani 2005, Pl. 35.429  
Class 160a Luciani 2005, Pl. 32.388  
Class 173a Luciani 2005, Pl. 35.428  
Class 174 Luciani 2005, Pl. 32.375-376, 378  
Class 175 Luciani 2005, Pl. 31.374  
Class 175 Luciani 2005, Pl. 35.426-427  
Class 176 Luciani 2005, Pl. 31.362-366  
Class 182a Luciani 2005, Pl. 32.387  
Class 182b Luciani 2005, Pl. 35.419-420

### Area G level 2

Class 1a Luciani 2005, Pl. 4.37  
Class 1a Luciani 2005, Pl. 20.238-243  
Class 1b Luciani 2005, Pl. 21.244  
Class 1c Luciani 2005, Pl. 26.296  
Class 4c Luciani 2005, Pl. 26.302  
Class 37a Luciani 2005, Pl. 25.291-292  
Class 37b Luciani 2005, Pl. 25.293  
Class 134a Luciani 2005, Pl. 8.115  
Class 134d Luciani 2005, Pl. 10.131-132  
Class 141a Luciani 2005, Pl. 8.106-107, 113  
Class 141a Luciani 2005, Pl. 10.126-130  
Class 141a Luciani 2005, Pl. 13.154-156  
Class 141a Luciani 2005, Pl. 14.158-161  
Class 141b Luciani 2005, Pl. 8.111  
Class 141c Luciani 2005, Pl. 3.29-30  
Class 141c Luciani 2005, Pl. 13.151-153  
Class 153 Luciani 2005, Pl. 4.36  
Class 160a Luciani 2005, Pl. 4.52-53  
Class 160a Luciani 2005, Pl. 9.119  
Class 161 Luciani 2005, Pl. 5.59  
Class 162 Luciani 2005, Pl. 4.38  
Class 175 Luciani 2005, Pl. 5.57, 60  
Class 176 Luciani 2005, Pl. 2.9-18  
Class 180 Luciani 2005, Pl. 2.22-24  
Class 181 Luciani 2005, Pl. 2.19  
Class 181 Luciani 2005, Pl. 3.33  
Class 182a Luciani 2005, Pl. 2.20-21  
Class 182b Luciani 2005, Pl. 4.41, 56  
Class 182c Luciani 2005, Pl. 4.51, 54

### Area G level 3

Class 170 Luciani 2005, Pl. 1.4  
Class 175 Luciani 2005, Pl. 1.1  
Class 182b Luciani 2005, Pl. 1.2-3

### Area H

Class 40a Bachelot 1999, Fig. 14  
Class 40b Al-Bahloul et al. 2005, Pl. 5a  
Class 52 Al-Bahloul et al. 2005, Pl. 6b  
Class 52 Al-Bahloul et al. 2005, Pl. 12c  
Class 57a Luciani 2000, Fig. 2.4  
Class 57a Al-Bahloul et al. 2005, Pl. 2a

Class 57a Al-Bahloul et al. 2005, Pl. 4  
Class 57a Al-Bahloul et al. 2005, Pl. 7a  
Class 57a Al-Bahloul et al. 2005, Pl. 8a  
Class 57a Al-Bahloul et al. 2005, Pl. 9a  
Class 63 Al-Bahloul et al. 2005, Pl. 1a  
Class 121f Al-Bahloul et al. 2005, Pl. 12b

Class 157 Al-Bahloul et al. 2005, Pl. 9h  
Class 165a Al-Bahloul et al. 2005, Pl. 5d  
Class 176 Al-Bahloul et al. 2005, Pl. 5c  
Class 181 Al-Bahloul et al. 2005, Pl. 9g  
Class 187 Al-Bahloul et al. 2005, Pl. 8b-c

## C.47 Sidon

### Iron II

Class 6 Doumet-Serhal 2006, Fig. 33.12-13  
Class 7a Doumet-Serhal 2006, Fig. 33.10-11  
Class 54 Doumet-Serhal 2006, Fig. 30.1  
Class 82a Doumet-Serhal 2000, Pl. 21.3-4  
Class 86 Doumet-Serhal 2000, Pl. 21.1-2  
Class 134b Doumet-Serhal 2006, Fig. 29. 11, 16, 38, 42  
Class 134d Doumet-Serhal 2006, Fig. 31.26  
Class 143 Doumet-Serhal 2006, Fig. 28.8  
Class 144a Doumet-Serhal 2004g, Pl. 14.8  
Class 152 Doumet-Serhal 2006, Fig. 31.35  
Class 153 Doumet-Serhal 2004g, Pl. 14.5-6  
Class 153 Doumet-Serhal 2006, Fig. 25.5-6  
Class 160b Doumet-Serhal 2006, Fig. 28.10  
Class 161 Doumet-Serhal 2006, Fig. 28.3-4  
Class 161 Doumet-Serhal 2006, Fig. 31.29  
Class 162 Doumet-Serhal 2006, Fig. 24-25  
Class 170 Doumet-Serhal 2006, Fig. 31.12-16  
Class 172 Doumet-Serhal 2006, Fig. 25.17  
Class 173a Doumet-Serhal 2004g, Pl. 14.2-3  
Class 173a Doumet-Serhal 2006, Fig. 25.2, 15-16  
Class 173a Doumet-Serhal 2006, Fig. 29.7-9  
Class 174 Doumet-Serhal 2004g, Pl. 14.1  
Class 174 Doumet-Serhal 2006, Fig. 28.1-2  
Class 176 Doumet-Serhal 2006, Fig. 29.1  
Class 179 Doumet-Serhal 2004g, Pl. 14.4  
Class 179 Doumet-Serhal 2006, Fig. 25.3  
Class 182a Doumet-Serhal 2006, Fig. 29.4  
Class 182b Doumet-Serhal 2006, Fig. 28.5  
Class 183 Doumet-Serhal 2006, Fig. 25.7  
Class 184 Doumet-Serhal 2004g, Pl. 14.9  
Class 184 Doumet-Serhal 2006, Fig. 25.10

Class 184 Doumet-Serhal 2006, Fig. 31.28, 30-31

Class 191 Doumet-Serhal 2006, Fig. 25.19

### Persian

Class 9a Doumet-Serhal 2006, Fig. 18.37-38  
Class 27 Doumet-Serhal 2006, Fig. 18.27-29  
Class 114 Doumet-Serhal 2006, Fig. 23.14-17  
Class 134e Doumet-Serhal 2006, Fig. 18.6-8, 11-12, 14-16  
Class 161 Doumet-Serhal 2006, Fig. 18.6, 10  
Class 172 Doumet-Serhal 2006, Fig. 22.25  
Class 173a Doumet-Serhal 2006, Fig. 22.10-11  
Class 174 Doumet-Serhal 2006, Fig. 22.7-8  
Class 182a Doumet-Serhal 2006, Fig. 22.3-4  
Class 182c Doumet-Serhal 2006, Fig. 22.1-2  
Class 193 Doumet-Serhal 2006, Fig. 18.2

### Tomb 21

Class 88 Culican 1975, Fig. 1e  
Class 91 Culican 1975, Fig. 1a  
Class 92 Culican 1975, Fig. 1d  
Class 120 Culican 1975, Fig. 1b-c

### Unstratified

Class 4b Saidah 1983, Pl. 53.1  
Class 6 Contenau 1920, Fig. 27c  
Class 12c Contenau 1920, Fig. 27d  
Class 12c Saidah 1983, Pl. 53.1  
Class 27 Contenau 1920, Fig. 16a  
Class 29 Culican 1975, Fig. 4b  
Class 44 Riis & Buhl 1990, Fig. 87  
Class 89 Saidah 1983, Pl. 53.1  
Class 91 Culican 1975, Fig. 4a  
Class 100a Saidah 1983, Pl. 53.1  
Class 167 Contenau 1920, Fig. 27e

## C.48 Sukas, Tell

### Stratum E

Class 9a Buhl 1983, Fig. IX.93  
Class 15 Buhl 1983, Fig. XIV.217  
Class 18 Buhl 1983, Fig. III.34-35  
Class 18 Buhl 1983, Fig. IV.38  
Class 19 Buhl 1983, Fig. III.33  
Class 27 Buhl 1983, Figs V.62; VI.63  
Class 42 Buhl 1983, Fig. VIII.82  
Class 42 Buhl 1983, Fig. XVI.280-281  
Class 43 Ploug 1973, No. 409  
Class 43 Buhl 1983, Fig. VIII.81  
Class 58 Riis 1970, Fig. 42c

Class 93a Buhl 1983, Fig. X.122-123  
Class 100a Buhl 1983, Fig. XII.156, 158;  
Class 100a Riis 1979, Figs 63-64, 91-92  
Class 130 Buhl 1983, Fig. XIV.204  
Class 184 Buhl 1983, Fig. XII.164

### Stratum F

Class 1c Buhl 1983, Fig. IX.90  
Class 6 Buhl 1983, Fig. IX.92  
Class 12d Buhl 1983, Fig. XVIII.355  
Class 15 Buhl 1983, Fig. XIV.218-219  
Class 16a Buhl 1983, Fig. II.22  
Class 16b Buhl 1983, Fig. II.20-21

Class 17 Buhl 1983, Pl. II.30  
 Class 18 Buhl 1983, Pl. III.37  
 Class 26 Buhl 1983, Fig. I.4  
 Class 27 Buhl 1983, Figs V.56-59, 61; VII.64-71, 75, 78-79  
 Class 28 Buhl 1983, Pl. III.46  
 Class 28 Buhl 1983, Fig. IV.47-48  
 Class 42 Buhl 1983, Fig. VIII.82  
 Class 43 Ploug 1973, No. 409  
 Class 58 Riis 1970, Fig. 42  
 Class 58 Ploug 1973, No. 372  
 Class 95 Ploug 1973, No. 93  
 Class 95 Buhl 1983, Fig. X.121  
 Class 95 Lund 1986, Fig. 123  
 Class 100b Buhl 1983, Fig. XI.133  
 Class 134b Buhl 1983, Fig. XIII.177  
 Class 193 Buhl 1983, Figs XII.167; XIV.189  
**Stratum G**  
 Class 1c Buhl 1983, Fig. IX.90  
 Class 4d Buhl 1983, Fig. IX.94  
 Class 12a Buhl 1983, Fig. XVIII.333  
 Class 16a Buhl 1983, Fig. I.3  
 Class 16a Buhl 1983, Fig. II.22  
 Class 16b Buhl 1983, Fig. II.14, 20-21  
 Class 25 Buhl 1983, Fig. IV.44  
 Class 26 Buhl 1983, Fig. I.5, 10  
 Class 26 Buhl 1983, Fig. II.19  
 Class 27 Buhl 1983, Fig. V.56  
 Class 28 Buhl 1983, Pl. III.46  
 Class 28 Buhl 1983, Fig. IV.47-48  
 Class 100b Buhl 1983, Fig. XII.159  
 Class 120 Buhl 1983, Fig. XII.157  
**Stratum G1**  
 Class 43 Lund 1986, Fig. 81  
 Class 54 Buhl 1983, Pl. XVII.285  
 Class 58 Ploug 1973, No. 373  
**Stratum G2**  
 Class 1a Buhl 1983, Fig. IX.97  
 Class 4a Buhl 1983, Fig. VIII.83  
 Class 9a Buhl 1983, Fig. IX.95  
 Class 12a Buhl 1983, Fig. XVIII.337  
 Class 12c Buhl 1983, Fig. XVIII.335  
 Class 16b Buhl 1983, Pl. I.12  
 Class 93a Buhl 1983, Fig. X.119  
 Class 100b Buhl 1983, Fig. XII.155  
**Stratum G3**  
 Class 12c Buhl 1983, Fig. XVIII.346  
 Class 26 Buhl 1983, Fig. II.16  
 Class 82b Buhl 1983, Fig. XVI.274  
 Class 85b Buhl 1983, Fig. X.106  
 Class 100b Lund 1986, Fig. Fig. 44  
 Class 143 Buhl 1983, Fig. XIV.213  
**Stratum H**  
 Class 12a Buhl 1983, Fig. XVIII.334  
 Class 12a Buhl 1983, Fig. XVIII.336  
 Class 16a Buhl 1983, Fig. III.24  
 Class 18 Buhl 1983, Fig. III.36  
 Class 22 Buhl 1983, Pl. II.15

Class 42 Buhl 1983, Fig. VIII.80  
 Class 42 Lund 1986, Fig. 28  
 Class 54 Buhl 1983, Fig. VIII.84  
 Class 57c Buhl 1983, Fig. I.1  
 Class 86 Buhl 1983, Fig. XI.136  
 Class 102c Buhl 1983, Fig. XI.137  
 Class 134b Buhl 1983, Fig. XII.163  
 Class 188 Buhl 1983, Fig. XIII.187  
**Stratum H1**  
 Class 10 Buhl 1983, Fig. XVI.240  
 Class 162 Buhl 1983, Fig. XIV.197  
 Class 184 Buhl 1983, Fig. XIII.175  
**Stratum H2**  
 Class 16a Buhl 1983, Fig. I.11;  
 Class 60 Buhl 1983, Pl. XVII.278  
 Class 100b Buhl 1983, Fig. XI.138  
**South Harbour**  
 Class 12b Buhl 1996, Figs 31.XVIIA;  
 32.XVIID  
 Class 12b Buhl 1996, Fig. 31.XVIIA(6097 SH  
 59)  
 Class 12b Buhl 1996, Fig. 32.XVIIB (3591/1)  
 Class 18 Buhl 1996, Fig. 21.IIB  
 Class 21 Buhl 1996, Fig. 22  
 Class 56 Buhl 1996, Fig. 23.IVA, IVC  
 Class 56 Buhl 1996, Fig. 23.IVA(9069/1)  
 Class 103a Buhl 1996, Fig. 37.IIA1 3455/1  
 Class 103b Buhl 1996, Fig. 37.IIA2-3  
 Class 104 Buhl 1996, Fig. 37.IIB1-3  
 Class 123 Buhl 1996, Fig. 25.VIIIB  
 Class 131a Buhl 1996, Fig. 29.XIIIA  
 Class 134a Buhl 1996, Fig. 28.XIID-F  
 Class 158a Buhl 1996, Fig. 27.XIA, XIB  
 Class 161 Buhl 1996, Fig. 29.XIIG  
 Class 162 Buhl 1996, Fig. 27.XID  
 Class 183 Buhl 1996, Fig. 30.XIVC  
 Class 188 Buhl 1996, Fig. 28.XIIC  
 Class 189 Buhl 1996, Fig. 27.XIIA, XIIB  
**South Harbour cemetery**  
 Class 22 Buhl 1983, 9  
 Class 27 Riis 1979, Figs 26, 28-31, 48, 52  
 Class 92 Riis 1979, Figs 73-74  
 Class 71b Riis 1979, Figs 20-21, 43-44  
 Class 82e Riis 1979, Figs 14-15  
 Class 100a Riis 1979, Figs 63-64, 91-92  
 Class 117 Riis 1979, Figs 65-66  
 Class 141c Riis 1979, Figs 33-34  
 Class 191 Riis 1979, Figs 53-55, 67-70, 75-76,  
 85-86  
**South Harbour Sanctuary**  
 Class 9a Riis 1979, Figs 114, 146  
 Class 15 Riis 1979, Figs 116-117  
 Class 27 Riis 1979, Figs 118-119, 145, 148,  
 155, 159-162, 171, 189-191  
 Class 193 Riis 1979, Fig. 154  
**Unstratified**  
 Class 58 Ploug 1973, Nos 375-376



## C.49 Tambourit

Class 42 Saidah 1977, No. 10  
Class 47 Saidah 1977, Nos 4-5, 11  
Class 57c Saidah 1977, No. 6

Class 90a Saidah 1977, Nos 7-9  
Class 179 Saidah 1977, Nos 1-3

## C.50 Ta'yinat, Tell

### Building Phase 1

Class 78 see Lehmann 1996, 410 (Form 261)  
Class 152 Swift 1958, Fig. 37

### Building Phase 2

Class 78 see Lehmann 1996, 410 (Form 261)  
Class 168 see Lehmann 1996, 360 (Form 1)

### Building Phase 3

Class 78 see Lehmann 1996, 410 (Form 261)  
Class 134b Swift 1958, Fig. 34  
Class 137 Swift 1958, Fig. 31  
Class 167 Culican 1982, Pl. 7d  
Class 168 see Lehmann 1996, 360 (Form 1)

### Building Phase 4

Class 26 see Lehmann 1996, 436 (Form 390, 392)  
Class 137 see Lehmann 1996, 394 (Form 183)

### Iron I

Class 4c Unpublished  
Class 7b Unpublished  
Class 56 Unpublished  
Class 57b Harrison et al. 2006, Fig. 11  
Class 57b Unpublished  
Class 165a Unpublished  
Class 168 Unpublished  
Class 176 Unpublished  
Class 184 Unpublished

Class 187 Unpublished

Class 188 Harrison et al. 2006, Fig. 10.A2542  
Class 188 Harrison et al. 2006, Fig. 10.B2361  
Class 188 Harrison et al. 2006, Fig. 10.Z192  
Class 188 Unpublished

### Iron II

Class 1a Unpublished  
Class 28 Unpublished  
Class 141a Unpublished  
Class 141c Unpublished  
Class 165a Unpublished  
Class 168 see Lehmann 1996, 360 (Form 1)

### Unstratified

Class 26 Unpublished  
Class 104 Unpublished  
Class 107b Unpublished  
Class 134d Batiuk et al. 2005, Fig. 7.14 (4)  
Class 141c Batiuk et al. 2005, Fig. 7.14 (2, 6)  
Class 141d Unpublished  
Class 143 Unpublished  
Class 167 see Culican 1970, 16  
Class 168 see Lehmann 1996, 360 (Form 1)  
Class 170 Unpublished  
Class 176 Batiuk et al. 2005, Fig. 7.14 (1, 3, 5, 7-9)  
Class 190 Unpublished

## C.51 Tille Hoyuk

### Strata I-III

Class 40a Blaylock 1999, Fig. 1.16-17  
Class 41b Blaylock 1999, Fig. 2.8  
Class 56 Blaylock 1999, Fig. 1.4-6  
Class 60 Blaylock 1999, Fig. 2.7  
Class 73 Blaylock 1999, Fig. 2.10  
Class 105 Blaylock 1999, Fig. 2.5-6  
Class 134b Blaylock 1999, Fig. 2.4  
Class 149 Blaylock 1999, Fig. 2.1, 3  
Class 165a Blaylock 1999, Fig. 2.2

### Strata IV-V

Class 141b Blaylock 1999, Fig. 4.17-19  
Class 157 Blaylock 1999, Fig. 4.2-3  
Class 159 Blaylock 1999, Fig. 4.14-16  
Class 164 Blaylock 1999, Fig. 4.5-6  
Class 182a Blaylock 1999, Fig. 4.4  
Class 184 Blaylock 1999, Fig. 4.8-11  
Class 187 Blaylock 1999, Fig. 4.12

### Stratum VIII

Class 2 Blaylock 1999, Fig. 7.4

Class 4c Blaylock 1999, Fig. 7.1-3  
Class 7b Blaylock 1999, Fig. 11.10-13, 17-18  
Class 12c Blaylock 1999, Fig. 10.16  
Class 15 Blaylock 1999, Fig. 7.7  
Class 41b Blaylock 1999, Fig. 6.1-3, 6  
Class 56 Blaylock 1999, Fig. 11.19  
Class 68 Blaylock 1999, Fig. 8.3, 5-6  
Class 101 Blaylock 1999, Fig. 6.5  
Class 118 Blaylock 1999, Fig. 10.15  
Class 119 Blaylock 1999, Fig. 10.13  
Class 121c Blaylock 1999, Fig. 10.7-10  
Class 121d Blaylock 1999, Fig. 9.5-8  
Class 121e Blaylock 1999, Fig. 10.1-6  
Class 124 Blaylock 1999, Fig. 8.1  
Class 130 Blaylock 1999, Fig. 10.22  
Class 139 Blaylock 1999, Fig. 5.11-12  
Class 139 Blaylock 1999, Fig. 11.21-23  
Class 141a Blaylock 1999, Fig. 5.1  
Class 141b Blaylock 1999, Fig. 5.14  
Class 141b Blaylock 1999, Fig. 11.24

Class 141c Blaylock 1999, Fig. 5.2  
Class 149 Blaylock 1999, Fig. 5.3-8, 14-17,  
19, 21

#### **Stratum X**

Class 15 Blaylock 1999, Fig. 12.1  
Class 134b Blaylock 1999, Fig. 13.12-13  
Class 141c Blaylock 1999, Fig. 13.11  
Class 149 Blaylock 1999, Fig. 13.9, 14  
Class 173a Blaylock 1999, Fig. 13.16  
Class 184 Blaylock 1999, Fig. 13.8

#### **Sondage level 10**

Class 4c Summers 1993, Fig. 45.9  
Class 4c Summers 1993, Fig. 54.1  
Class 35 Summers 1993, Fig. 50.1

Class 35 Summers 1993, Fig. 53.3  
Class 35 Summers 1993, Fig. 55.1-3  
Class 37a Summers 1993, Fig. 50.2  
Class 41a Summers 1993, Fig. 48.2  
Class 41a Summers 1993, Fig. 51.6  
Class 41b Summers 1993, Fig. 51.4-5  
Class 53b Summers 1993, Fig. 51.1  
Class 53b Summers 1993, Fig. 53.1-2  
Class 101 Summers 1993, Figs 34.1-3; 47.3  
Class 102c Summers 1993, Fig. 34.5-6  
Class 134a Summers 1993, Fig. 49.1  
Class 134b Summers 1993, Fig. 51.3  
Class 188 Summers 1993, Fig. 54.3

## **C.52 Tyre**

#### **Stratum I**

Class 4b Bikai 1978b, Pl. 1.17  
Class 18 Bikai 1978b, Pl. 1.14  
Class 24b Bikai 1978b, Pl. 1.16  
Class 85a Bikai 1978b, Pl. 1.3  
Class 141a Bikai 1978b, Pl. 1.12  
Class 145b Bikai 1978b, Pl. 1.6  
Class 151 Bikai 1978b, Pl. 1.7-11  
Class 155 Bikai 1978b, Pl. 1.1-2  
Class 160a Bikai 1978b, Pl. 1.4  
Class 160b Bikai 1978b, Pl. 1.5  
Class 176 Bikai 1978b, Pl. 1.13

#### **Stratum II**

Class 1a Bikai 1978b, Pl. 12.33  
Class 4b Bikai 1978b, Pl. 12.26-28  
Class 5 Bikai 1978b, Pl. 12.30  
Class 6 Bikai 1978b, Pl. 12.29  
Class 18 Bikai 1978b, Pl. 4.1  
Class 19 Bikai 1978b, Pl. 7.1-2  
Class 24a Bikai 1978b, Pls 2.6, 8; 3.7-8  
Class 24b Bikai 1978b, Pls 2.1-5, 7, 9-11; 3.4-6; 4.3-5  
Class 26 Bikai 1978b, Pls 3.1-3; 4.2  
Class 70 Bikai 1978b, Pl. 6.12  
Class 87 Bikai 1978b, Pl. 6.4-5  
Class 90a Bikai 1978b, Pl. 6.9  
Class 141a Bikai 1978b, Pl. 10.28  
Class 145a Bikai 1978b, Pl. 9.4-6, 15-16  
Class 145b Bikai 1978b, Pl. 9.3, 18  
Class 151 Bikai 1978b, Pl. 9.2  
Class 155 Bikai 1978b, Pl. 11.1, 3-4, 6, 9, 11, 15-16  
Class 160a Bikai 1978b, Pl. 10.15, 21  
Class 160b Bikai 1978b, Pl. 10.24-25  
Class 162 Bikai 1978b, Pl. 10.27  
Class 172 Bikai 1978b, Pl. 11.19  
Class 174 Bikai 1978b, Pl. 11.20  
Class 188 Bikai 1978b, Pl. 10.17  
Class 188 Bikai 1978b, Pl. 11.21

#### **Stratum III**

Class 4b Bikai 1978b, Pl. 12.31  
Class 6 Bikai 1978b, Pl. 12.24-25, 32  
Class 11a Bikai 1978b, Pl. 10.3, 5-6

Class 11b Bikai 1978b, Pl. 10.1-2  
Class 12b Bikai 1978b, Pl. 7.6  
Class 12c Bikai 1978b, Pl. 7.5  
Class 19 Bikai 1978b, Pl. 7.3  
Class 20 Bikai 1978b, Pl. 7.7  
Class 42 Bikai 1978b, Pl. 7.8  
Class 70 Bikai 1978b, Pl. 6.10-11  
Class 74 Bikai 1978b, Pl. 6.7  
Class 85a Bikai 1978b, Pl. 5.14  
Class 85b Bikai 1978b, Pl. 5.15-17  
Class 87 Bikai 1978b, Pl. 5.19-23  
Class 90a Bikai 1978b, Pl. 5.4, 18  
Class 90a Bikai 1978b, Pl. 6.6, 8  
Class 90b Bikai 1978b, Pl. 5.1-3, 5-8  
Class 92 Bikai 1978b, Pl. 5.9, 11  
Class 100b Bikai 1978b, Pl. 12.1-23  
Class 111 Bikai 1978b, Pl. 6.1  
Class 119 Bikai 1978b, Pl. 6.2  
Class 134b Bikai 1978b, Pl. 10.12  
Class 141c Bikai 1978b, Pl. 10.33  
Class 143 Bikai 1978b, Pl. 10.8  
Class 144a Bikai 1978b, Pl. 10.29  
Class 144b Bikai 1978b, Pl. 9.9-10  
Class 145a Bikai 1978b, Pl. 9.8, 11-12, 14, 17  
Class 145b Bikai 1978b, Pl. 9.13  
Class 155 Bikai 1978b, Pl. 11.2, 5, 7-8, 10, 12-14  
Class 157 Bikai 1978b, Pl. 10.22  
Class 160a Bikai 1978b, Pl. 10.14, 16, 20  
Class 161 Bikai 1978b, Pl. 9.20  
Class 162 Bikai 1978b, Pl. 10.13, 26  
Class 170 Bikai 1978b, Pl. 11.17  
Class 172 Bikai 1978b, Pl. 10.19  
Class 179 Bikai 1978b, Pl. 10.4, 7  
Class 182b Bikai 1978b, Pl. 10.30  
Class 189 Bikai 1978b, Pl. 10.18-19  
Class 193 Bikai 1978b, Pl. 10.19

#### **Stratum IV**

Class 4a Bikai 1978b, Pl. 17.3-4  
Class 8a Bikai 1978b, Pl. 17.2  
Class 12b Bikai 1978b, Pl. 14.9  
Class 18 Bikai 1978b, Pl. 14.13, 16  
Class 56 Bikai 1978b, Pl. 14.15

Class 90a Bikai 1978b, Pl. 14.8  
 Class 100b Bikai 1978b, Pl. 14.7  
 Class 134d Bikai 1978b, Pl. 15.3  
 Class 143 Bikai 1978b, Pls 15.21, 27; 16.6  
 Class 144a Bikai 1978b, Pl. 15.2, 5  
 Class 145a Bikai 1978b, Pl. 15.9  
 Class 145b Bikai 1978b, Pl. 16.13  
 Class 152 Bikai 1978b, Pl. 15.18  
 Class 153 Bikai 1978b, Pl. 16.3  
 Class 155 Bikai 1978b, Pl. 15.1, 4, 7, 10-11  
 Class 155 Bikai 1978b, Pl. 16.4  
 Class 160a Bikai 1978b, Pl. 15.8  
 Class 160b Bikai 1978b, Pl. 15.19-20, 25  
 Class 170 Bikai 1978b, Pl. 16.15  
 Class 172 Bikai 1978b, Pl. 15.6, 23-24  
 Class 173a Bikai 1978b, Pl. 15.12, 16-17  
 Class 179 Bikai 1978b, Pl. 16.18-42  
 Class 182a Bikai 1978b, Pl. 15.13-15  
 Class 182a Bikai 1978b, Pl. 16.7-9

#### **Stratum V**

Class 3 Bikai 1978b, Pl. 18.13  
 Class 6 Bikai 1978b, Pl. 18.15  
 Class 18 Bikai 1978b, Pl. 18.14  
 Class 100b Bikai 1978b, Pl. 18.8-9  
 Class 160a Bikai 1978b, Pl. 18.7  
 Class 162 Bikai 1978b, Pl. 18.1  
 Class 172 Bikai 1978b, Pl. 18.2  
 Class 173a Bikai 1978b, Pl. 18.11  
 Class 179 Bikai 1978b, Pl. 18.3, 6

#### **Stratum VI**

Class 7b Bikai 1978b, Pl. 18.19  
 Class 82d Bikai 1978b, Pl. 18.18  
 Class 163 Bikai 1978b, Pl. 18.22  
 Class 179 Bikai 1978b, Pl. 18.5  
 Class 188 Bikai 1978b, Pl. 18.16

#### **Stratum VII**

Class 179 Bikai 1978b, Pl. 18.4

#### **Stratum VIII**

Class 5 Bikai 1978b, Pl. 20.12  
 Class 7b Bikai 1978b, Pl. 20.13  
 Class 18 Bikai 1978b, Pl. 21.5  
 Class 73 Bikai 1978b, Pl. 20.7  
 Class 84 Bikai 1978b, Pl. 22.9-10  
 Class 100b Bikai 1978b, Pl. 20.5  
 Class 134a Bikai 1978b, Pl. 19.28  
 Class 134b Bikai 1978b, Pl. 22.11  
 Class 143 Bikai 1978b, Pl. 19.20  
 Class 155 Bikai 1978b, Pl. 19.3, 6  
 Class 160a Bikai 1978b, Pl. 19.21  
 Class 160b Bikai 1978b, Pl. 22.7  
 Class 162 Bikai 1978b, Pl. 19.15  
 Class 164 Bikai 1978b, Pl. 19.29  
 Class 172 Bikai 1978b, Pl. 19.24  
 Class 173a Bikai 1978b, Pl. 19.7, 17  
 Class 174 Bikai 1978b, Pl. 19.18, 22  
 Class 179 Bikai 1978b, Pl. 19.9-12  
 Class 182b Bikai 1978b, Pl. 19.2  
 Class 184 Bikai 1978b, Pl. 19.1  
 Class 191 Bikai 1978b, Pl. 22.3

#### **Stratum IX**

Class 4d Bikai 1978b, Pl. 20.10  
 Class 10 Bikai 1978b, Pl. 20.16, 18  
 Class 16c Bikai 1978b, Pl. 21.12  
 Class 18 Bikai 1978b, Pl. 21.13  
 Class 26 Bikai 1978b, Pl. 21.1, 11  
 Class 73 Bikai 1978b, Pl. 20.8  
 Class 77 Bikai 1978b, Pl. 21.9  
 Class 77 Bikai 1978b, Pl. 22.8  
 Class 82b Bikai 1978b, Pl. 20.1  
 Class 134b Bikai 1978b, Pl. 19.19  
 Class 157 Bikai 1978b, Pl. 19.4-5  
 Class 160a Bikai 1978b, Pl. 19.8  
 Class 160b Bikai 1978b, Pl. 19.27  
 Class 162 Bikai 1978b, Pl. 19.23  
 Class 163 Bikai 1978b, Pl. 22.15-16  
 Class 172 Bikai 1978b, Pl. 19.25-26  
 Class 174 Bikai 1978b, Pl. 22.5-6  
 Class 179 Bikai 1978b, Pl. 19.13-14  
 Class 188 Bikai 1978b, Pl. 20.11  
 Class 188 Bikai 1978b, Pl. 21.6  
 Class 188 Bikai 1978b, Pl. 22.17  
 Class 191 Bikai 1978b, Pl. 22.1-2, 4

#### **Stratum X**

Class 4b Bikai 1978b, Pl. 23.13-15  
 Class 4b Bikai 1978b, Pl. 27.7  
 Class 5 Bikai 1978b, Pl. 23.18  
 Class 6 Bikai 1978b, Pls 23.16; 27.6, 8, 10, 12  
 Class 7a Bikai 1978b, Pl. 27.9, 11  
 Class 10 Bikai 1978b, Pl. 23.17  
 Class 12a Bikai 1978b, Pl. 26.9  
 Class 12b Bikai 1978b, Pl. 26.10  
 Class 16b Bikai 1978b, Pl. 26.13, 15, 17-18, 21  
 Class 62 Bikai 1978b, Pl. 28.9  
 Class 71a Bikai 1978b, Pl. 25.8  
 Class 76 Bikai 1978b, Pl. 25.7  
 Class 77 Bikai 1978b, Pl. 25.14  
 Class 78 Bikai 1978b, Pl. 25.12, 15  
 Class 80 Bikai 1978b, Pl. 28.1-2  
 Class 100b Bikai 1978b, Pl. 25.2-5  
 Class 100c Bikai 1978b, Pl. 25.1  
 Class 102b Bikai 1978b, Pl. 25.6  
 Class 134a Bikai 1978b, Pl. 23.5  
 Class 153 Bikai 1978b, Pl. 23.1  
 Class 155 Bikai 1978b, Pl. 28.6  
 Class 160a Bikai 1978b, Pl. 26.20  
 Class 160b Bikai 1978b, Pl. 23.12  
 Class 160b Bikai 1978b, Pl. 27.2  
 Class 162 Bikai 1978b, Pl. 23.2, 7  
 Class 162 Bikai 1978b, Pl. 26.1-4  
 Class 162 Bikai 1978b, Pl. 28.4, 7  
 Class 163 Bikai 1978b, Pl. 28.5  
 Class 172 Bikai 1978b, Pl. 27.3-4  
 Class 173a Bikai 1978b, Pl. 23.4, 19  
 Class 173a Bikai 1978b, Pl. 26.5, 7  
 Class 174 Bikai 1978b, Pl. 24.5  
 Class 179 Bikai 1978b, Pl. 23.3  
 Class 188 Bikai 1978b, Pl. 27.5  
 Class 188 Bikai 1978b, Pl. 28.3, 8  
 Class 191 Bikai 1978b, Pl. 24.6

**Stratum XI**

- Class 6 Bikai 1978b, Pl. 29.9
- Class 10 Bikai 1978b, Pl. 29.10
- Class 16c Bikai 1978b, Pl. 29.14
- Class 107b Bikai 1978b, Pl. 29.3
- Class 158a Bikai 1978b, Pl. 29.2
- Class 164 Bikai 1978b, Pl. 29.6
- Class 170 Bikai 1978b, Pl. 29.8
- Class 173a Bikai 1978b, Pl. 29.4
- Class 179 Bikai 1978b, Pl. 29.5
- Class 182b Bikai 1978b, Pl. 29.7

**Stratum XII**

- Class 4d Bikai 1978b, Pl. 32.14
- Class 6 Bikai 1978b, Pl. 32.12
- Class 12c Bikai 1978b, Pl. 31.9
- Class 18 Bikai 1978b, Pl. 31.19
- Class 54 Bikai 1978b, Pl. 32.13
- Class 77 Bikai 1978b, Pl. 31.15
- Class 80 Bikai 1978b, Pl. 32.7
- Class 102b Bikai 1978b, Pl. 31.10
- Class 131a Bikai 1978b, Pl. 31.14
- Class 134a Bikai 1978b, Pl. 31.6
- Class 134b Bikai 1978b, Pl. 31.5, 13
- Class 158a Bikai 1978b, Pl. 31.1, 2
- Class 162 Bikai 1978b, Pl. 31.8
- Class 164 Bikai 1978b, Pl. 31.3
- Class 168 Bikai 1978b, Pl. 32.11
- Class 170 Bikai 1978b, Pl. 31.7
- Class 182b Bikai 1978b, Pl. 31.12
- Class 188 Bikai 1978b, Pl. 31.4

**Stratum XIII**

- Class 2 Bikai 1978b, Pl. 35.3
- Class 4c Bikai 1978b, Pl. 37.18, 20
- Class 6 Bikai 1978b, Pl. 35.2, 4-8
- Class 7a Bikai 1978b, Pl. 35.9
- Class 16b Bikai 1978b, Pl. 34.10
- Class 16b Bikai 1978b, Pl. 35.11
- Class 26 Bikai 1978b, Pl. 35.12-13
- Class 38a Bikai 1978b, Pl. 35.7
- Class 78 Bikai 1978b, Pl. 33.22, 25
- Class 88 Bikai 1978b, Pl. 37.13
- Class 100b Bikai 1978b, Pl. 33.17-18
- Class 100b Bikai 1978b, Pl. 37.1
- Class 102b Bikai 1978b, Pl. 37.3
- Class 129 Bikai 1978b, Pl. 33.23
- Class 160a Bikai 1978b, Pl. 33.12
- Class 161 Bikai 1978b, Pl. 33.1, 4, 16
- Class 162 Bikai 1978b, Pl. 37.4, 6, 8-9
- Class 170 Bikai 1978b, Pl. 33.11
- Class 173a Bikai 1978b, Pl. 33.2, 5, 7-8
- Class 173a Bikai 1978b, Pl. 37.11
- Class 176 Bikai 1978b, Pl. 37.9
- Class 188 Bikai 1978b, Pl. 34.2, 5, 7, 9, 12
- Class 188 Bikai 1978b, Pl. 37.7, 10

**Stratum XIV**

- Class 8d Bikai 1978b, Pl. 39.16, 19, 22, 24
- Class 32 Bikai 1978b, Pl. 40
- Class 55 Bikai 1978b, Pl. 39.27
- Class 100b Bikai 1978b, Pl. 39.1-3
- Class 102b Bikai 1978b, Pl. 39.4-5

- Class 162 Bikai 1978b, Pl. 39.21
- Class 173a Bikai 1978b, Pl. 39.23
- Class 182b Bikai 1978b, Pl. 39.13
- Class 188 Bikai 1978b, Pl. 39.14, 20

**Al-Bass Cemetery I**

- Class 162 Núñez 2004a, Fig. 110.P8

**Al-Bass Cemetery II**

- Class 16c Núñez 2004a, Fig. 68.1
- Class 40c Núñez 2004a, Fig. 102.1
- Class 42 Núñez 2004a, Fig. 81.1
- Class 42 Núñez 2004a, Fig. 93.1
- Class 42 Núñez 2004a, Fig. 94.1
- Class 42 Núñez 2004a, Fig. 100.1
- Class 42 Núñez 2004a, Fig. 101.1
- Class 62 Núñez 2004a, Fig. 76.1
- Class 77 Núñez 2004a, Fig. 81.2
- Class 77 Núñez 2004a, Fig. 93.4
- Class 77 Núñez 2004a, Fig. 100.4-6
- Class 80 Núñez 2004a, Fig. 102.4
- Class 82a Núñez 2004a, Fig. 68.2-3
- Class 82a Núñez 2004a, Fig. 76.2
- Class 82b Núñez 2004a, Fig. 102.3
- Class 100b Núñez 2004a, Fig. 93.3
- Class 100b Núñez 2004a, Fig. 100.3
- Class 107b Núñez 2004a, Fig. 76.3
- Class 145a Núñez 2004a, Fig. 94.3
- Class 145b Núñez 2004a, Fig. 81.4
- Class 145b Núñez 2004a, Fig. 101.2
- Class 155 Núñez 2004a, Fig. 68.4
- Class 162 Núñez 2004a, Fig. 68.6
- Class 162 Núñez 2004a, Fig. 76.4
- Class 162 Núñez 2004a, Fig. 93.2
- Class 162 Núñez 2004a, Fig. 100.2
- Class 179 Núñez 2004a, Fig. 68.5
- Class 179 Núñez 2004a, Fig. 102.2

**Al-Bass Cemetery III**

- Class 42 Núñez 2004a, Fig. 56.1
- Class 42 Núñez 2004a, Fig. 89.1
- Class 42 Núñez 2004a, Fig. 95.1
- Class 42 Núñez 2004a, Fig. 96.1
- Class 42 Núñez 2004a, Fig. 106.1
- Class 42 Núñez 2004a, Fig. 107.1
- Class 46 Núñez 2004a, Fig. 52.1
- Class 46 Núñez 2004a, Fig. 54.1
- Class 46 Núñez 2004a, Fig. 70.1
- Class 82a Núñez 2004a, Fig. 52.3
- Class 82a Núñez 2004a, Fig. 56.3
- Class 82a Núñez 2004a, Fig. 96.3
- Class 82b Núñez 2004a, Fig. 52.4
- Class 85b Núñez 2004a, Fig. 53.2, 5
- Class 85b Núñez 2004a, Fig. 89.2
- Class 85b Núñez 2004a, Fig. 106.3
- Class 90a Núñez 2004a, Fig. 70.2
- Class 143 Núñez 2004a, Fig. 55.45-46
- Class 145a Núñez 2004a, Fig. 52.2
- Class 145a Núñez 2004a, Fig. 108.34-36
- Class 145b Núñez 2004a, Fig. 54.3
- Class 145b Núñez 2004a, Fig. 55.41-44
- Class 145b Núñez 2004a, Fig. 56.2
- Class 145b Núñez 2004a, Fig. 106.2, 5

Class 145b Núñez 2004a, Fig. 107.2  
 Class 155 Núñez 2004a, Fig. 52.5  
 Class 179 Núñez 2004a, Fig. 52.6  
 Class 179 Núñez 2004a, Figs 55.37-39; 56.8.6  
 Class 179 Núñez 2004a, Fig. 96.5  
 Class 160a Núñez 2004a, Fig. 54.2  
 Class 182a Núñez 2004a, Fig. 55.31-32

**Al-Bass Cemetery IV**

Class 42 Núñez 2004a, Fig. 50.1  
 Class 42 Núñez 2004a, Fig. 60.1  
 Class 42 Núñez 2004a, Fig. 62.1  
 Class 42 Núñez 2004a, Fig. 63.1  
 Class 42 Núñez 2004a, Fig. 64.1  
 Class 42 Núñez 2004a, Fig. 67.1  
 Class 42 Núñez 2004a, Fig. 69.1  
 Class 42 Núñez 2004a, Fig. 72.1  
 Class 42 Núñez 2004a, Fig. 75.1  
 Class 42 Núñez 2004a, Fig. 77.1  
 Class 42 Núñez 2004a, Fig. 78.1  
 Class 42 Núñez 2004a, Fig. 82.1  
 Class 42 Núñez 2004a, Fig. 83.1, 5  
 Class 42 Núñez 2004a, Fig. 84.1  
 Class 42 Núñez 2004a, Fig. 86.1  
 Class 42 Núñez 2004a, Fig. 87.1  
 Class 42 Núñez 2004a, Fig. 92.1  
 Class 42 Núñez 2004a, Fig. 103.1  
 Class 42 Núñez 2004a, Fig. 104.1  
 Class 42 Núñez 2004a, Fig. 109.1-2, 4-5  
 Class 45 Núñez 2004a, Fig. 51.1  
 Class 45 Núñez 2004a, Fig. 71.1  
 Class 45 Núñez 2004a, Fig. 73.1(158)  
 Class 45 Núñez 2004a, Fig. 79.1  
 Class 45 Núñez 2004a, Fig. 85.1  
 Class 46 Núñez 2004a, Fig. 80.1  
 Class 46 Núñez 2004a, Fig. 98.1  
 Class 46 Núñez 2004a, Fig. 99.1  
 Class 46 Núñez 2004a, Fig. 110.P12.1  
 Class 62 Núñez 2004a, Fig. 74.1  
 Class 77 Núñez 2004a, Fig. 99.3  
 Class 77 Núñez 2004a, Fig. 111.P13.1  
 Class 82a Núñez 2004a, Fig. 50.3  
 Class 82a Núñez 2004a, Fig. 51.3  
 Class 82a Núñez 2004a, Fig. 60.2-3  
 Class 82a Núñez 2004a, Fig. 67.3  
 Class 82a Núñez 2004a, Fig. 71.3  
 Class 82a Núñez 2004a, Fig. 75.3-4  
 Class 82a Núñez 2004a, Fig. 77.3  
 Class 82a Núñez 2004a, Fig. 80.2  
 Class 82a Núñez 2004a, Fig. 98.2  
 Class 82a Núñez 2004a, Fig. 104.3  
 Class 82b Núñez 2004a, Fig. 63.3  
 Class 82e Núñez 2004a, Fig. 83.2  
 Class 85b Núñez 2004a, Fig. 50.4  
 Class 85b Núñez 2004a, Fig. 60.5  
 Class 85b Núñez 2004a, Fig. 64.2  
 Class 85b Núñez 2004a, Fig. 71.4  
 Class 85b Núñez 2004a, Fig. 73.3  
 Class 85b Núñez 2004a, Fig. 74.2  
 Class 85b Núñez 2004a, Fig. 78.3  
 Class 85b Núñez 2004a, Fig. 80.3

Class 85b Núñez 2004a, Fig. 92.3  
 Class 85b Núñez 2004a, Fig. 99.2, 4  
 Class 85b Núñez 2004a, Fig. 103.3  
 Class 87 Núñez 2004a, Fig. 86.3  
 Class 90a Núñez 2004a, Fig. 60.4  
 Class 100b Núñez 2004a, Fig. 110.12  
 Class 143 Núñez 2004a, Fig. 64.8  
 Class 144b Núñez 2004a, Fig. 51.2  
 Class 145a Núñez 2004a, Fig. 50.2  
 Class 145a Núñez 2004a, Fig. 75.2  
 Class 145a Núñez 2004a, Fig. 103.2  
 Class 145b Núñez 2004a, Figs 62.4; 71.2;  
 72.2; 73.2; 77.2; 78.2  
 Class 145b Núñez 2004a, Fig. 75.5, 17, 19  
 Class 154 Núñez 2004a, Fig. 60.6  
 Class 155 Núñez 2004a, Fig. 80.4  
 Class 157 Núñez 2004a, Fig. 73.4  
 Class 157 Núñez 2004a, Fig. 64.3  
 Class 157 Núñez 2004a, Fig. 104.4  
 Class 160a Núñez 2004a, Fig. 80.9  
 Class 173b Núñez 2004a, Fig. 75.14  
 Class 179 Núñez 2004a, Fig. 67.2  
 Class 179 Núñez 2004a, Fig. 92.2  
 Class 182a Núñez 2004a, Fig. 69.4

**Al-Bass Cemetery IV/V**

Class 42 Núñez 2004a, Fig. 61.1  
 Class 87 Núñez 2004a, Fig. 61.2  
 Class 145b Núñez 2004a, Fig. 61.7-8  
 Class 155 Núñez 2004a, Fig. 61.5

**Al-Bass Cemetery V**

Class 4b Núñez 2004a, Fig. 105.1  
 Class 42 Núñez 2004a, Fig. 57.1  
 Class 42 Núñez 2004a, Fig. 58.1  
 Class 42 Núñez 2004a, Fig. 90.1  
 Class 45 Núñez 2004a, Fig. 66.1  
 Class 46 Núñez 2004a, Fig. 65.1  
 Class 82a Núñez 2004a, Fig. 65.3  
 Class 82a Núñez 2004a, Fig. 90.2  
 Class 82d Núñez 2004a, Fig. 57.2  
 Class 85a Núñez 2004a, Fig. 58.2  
 Class 85a Núñez 2004a, Fig. 66.3  
 Class 85a Núñez 2004a, Fig. 90.3  
 Class 87 Núñez 2004a, Fig. 57.3  
 Class 90b Núñez 2004a, Fig. 105.3  
 Class 142 Núñez 2004a, Fig. 65.20  
 Class 145a Núñez 2004a, Fig. 65.18  
 Class 145b Núñez 2004a, Fig. 57.11-15  
 Class 145b Núñez 2004a, Fig. 58.5, 8  
 Class 151 Núñez 2004a, Fig. 105.2  
 Class 155 Núñez 2004a, Fig. 58.3  
 Class 162 Núñez 2004a, Fig. 90.5  
 Class 172 Núñez 2004a, Fig. 57.17  
 Class 179 Núñez 2004a, Fig. 66.2

**Al-Bass Cemetery Unstratified**

Class 16a Seeden 1991, Figs 45-46  
 Class 40c Núñez 2004a, Fig. 118.P2.2  
 Class 42 Seeden 1991, Figs 1-12  
 Class 42 Seeden 1991, Figs 15-18  
 Class 42 Aubet 2004a, Fig. 8a  
 Class 42 Núñez 2004a, Fig. 91.1

Class 42 Núñez 2004a, Fig. 111.P27  
Class 42 Núñez 2004a, Fig. 111.P9  
Class 42 Núñez 2004a, Fig. 113.P5.2  
Class 42 Núñez 2004a, Fig. 113.P20  
Class 42 Núñez 2004a, Fig. 116.P10.2  
Class 45 Núñez 2004a, Fig. 88.1  
Class 45 Núñez 2004a, Fig. 116.P12  
Class 47 Seeden 1991, Figs 13-14  
Class 73 Seeden 1991, Figs 39-40  
Class 77 Núñez 2004a, Fig. 111.P13.1  
Class 77 Núñez 2004a, Fig. 116.P17  
Class 77 Núñez 2004a, Fig. 118.P1.1  
Class 82a Seeden 1991, Figs 23-30  
Class 82a Aubet 2004a, Fig. 8a  
Class 82a Núñez 2004a, Fig. 81.2  
Class 82a Núñez 2004a, Fig. 113.P15  
Class 82b Seeden 1991, Figs 19-20  
Class 85b Seeden 1991, Figs 33-38  
Class 85b Aubet 2004a, Fig. 8a  
Class 85b Núñez 2004a, Fig. 115.P20

Class 85b Núñez 2004a, Fig. 116.P14.1  
Class 87 Seeden 1991, Figs 31-32  
Class 90a Seeden 1991, Figs 21-22  
Class 107b Seeden 1991, Figs 41-42  
Class 127 Seeden 1991, Figs 43-44  
Class 144b Aubet 2004a, Fig. 8a  
Class 145a Aubet 2004a, Fig. 8a  
Class 145a Núñez 2004a, Fig. 114.P3.2  
Class 145a Núñez 2004a, Fig. 117.P5  
Class 145b Núñez 2004a, Fig. 112.P30; P51;  
P25.1; P19; P14.3  
Class 145b Núñez 2004a, Fig. 114.P14.1; P16  
Class 155 Núñez 2004a, Fig. 111.P13.2  
Class 155 Núñez 2004a, Fig. 115.P22.1  
Class 157 Aubet 2004a, Fig. 8a  
Class 160a Núñez 2004a, Fig. 111.P7.2  
Class 160a Núñez 2004a, Fig. 115.P22.2  
Class 160a Núñez 2004a, Fig. 115.P16.2  
Class 164 Núñez 2004a, Fig. 112.P27.1  
Class 179 Núñez 2004a, Fig. 112.P25

## C.53 Zincirli

### Iron III

Class 10 Andrae 1943, Pl. 28n, p  
Class 36 Andrae 1943, Pl. 28d-e  
Class 36 Andrae 1943, Pl. 30c; Fig. 66  
Class 53b Andrae 1943, Fig. 34  
Class 101 Andrae 1943, Pl. 22b  
Class 102a Andrae 1943, Pl. 19c, e  
Class 105 Andrae 1943, Pl. 19b  
Class 119 Andrae 1943, Pl. 22k  
Class 119 Andrae 1943, Pl. 26g  
Class 121b Andrae 1943, 50  
Class 121e Andrae 1943, Pl. 24k  
Class 121f Andrae 1943, Pl. 24h  
Class 130 Andrae 1943, 52, Pl. 23a-c  
Class 130 Andrae 1943, Pl. 23c  
Class 167 Andrae 1943, 51  
Class 184 Andrae 1943, Pl. 25w

### Tombs

Class 119 Andrae 1943, Fig. 41  
Class 119 Andrae 1943, Pl. 26f

### Unstratified

Class 53b Andrae 1943, Pl. 23k, n, o  
Class 53b Andrae 1943, Pl. 29e  
Class 88 Andrae 1943, Pl. 28g  
Class 100c Andrae 1943, Pl. 27d  
Class 106 Andrae 1943, Fig. 63  
Class 113 Andrae 1943, Pl. 19f  
Class 119 Andrae 1943, Pl. 22i; Fig. 55  
Class 121e Andrae 1943, Pl. 24a  
Class 121e Andrae 1943, Pl. 25h, i  
Class 121f Andrae 1943, Pl. 24d  
Class 130 Andrae 1943, Pl. 23a-b  
Class 147 Andrae 1943, Pl. 24n  
Class 172 Andrae 1943, Pl. 25p

## APPENDIX D

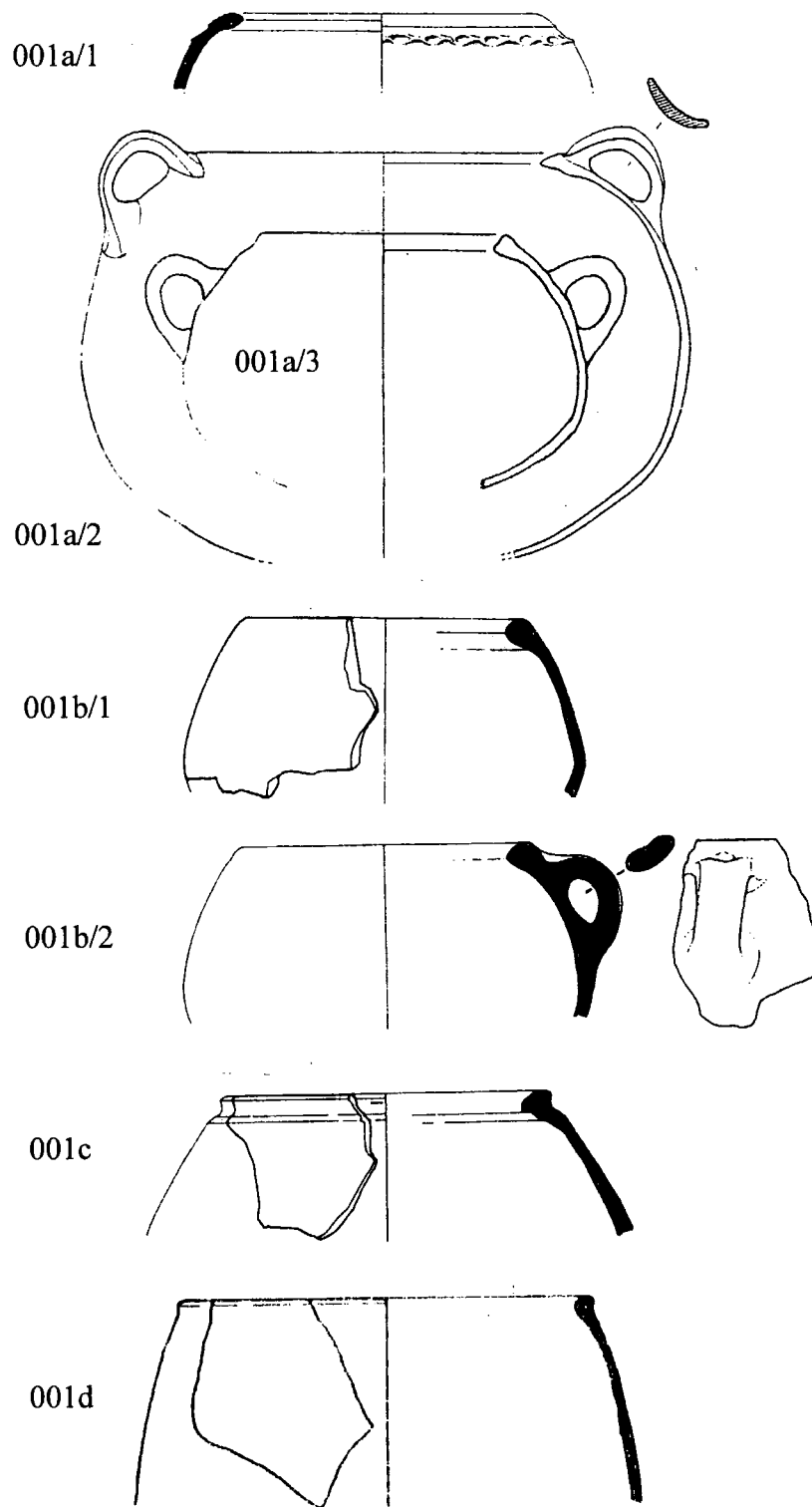
### Iron I CLASSES and Late Bronze Age examples

CLASS	LBA Context	LBA Reference
4	Tell Bazi	Otto 2006, Abb. 43.17a-b
6	Sarepta	Anderson 1988, Pl. 28.7-9
8		
12	Tel Dan	Ben Dov 2002, Fig. 2.61.70-76
13	Sarepta	Anderson 1988, Pl. 28.18
16	Tell Kazel	Badre & Gubel 1999-2000, Fig. 32
21	Sarepta	Anderson 1988, Pl. 27.7
22	Hazor	Yadin <i>et al.</i> 1958, Pl. 86.1, 8, 9
26	Sarepta	Anderson 1988, Pl. 26.1
31	Hazor	Yadin <i>et al.</i> 1958, Pl. 88.11
34	Tell Nami	Artzy 1994, <i>passim</i>
35	Tell Bazi	Otto 2006, Abb. 44.21
37	Tell Afis	Mazzoni 2002e, Pls 63.57; 64.58
38	Tyre	Bikai 1978b, Pl. 41.6
40	Tell Arqa	Thalman 2006b, Pl. 118.13
42	Tel Dan	Ben Dov 2002, Fig. 2.54.14, 16
53	Tell Bazi	Otto 2006, Abb. 42.3b
57		
71	Tel Dan	Ben Dov 2002, Fig. 2.57.34, 38
73		
78		
80	Tell Bazi	Otto 2006, Abb. 43.14a
100	Tyre	Bikai 1978b, Pl. 39.1-3
102	Hazor	Yadin <i>et al.</i> 1960, Pl. 130.10-13
103	Sarepta	Anderson 1988, Pl. 28.6
104	Ras Ibn Hani	Bounni <i>et al.</i> 1998, Fig. 152.5;
105		
107		
116	Ras Ibn Hani	Bounni <i>et al.</i> 1998, Fig. 152.6
123	Tell Bazi	Otto 2006, Abb. 42.4b
131	Ras Shamra	Schaeffer 1949, 269, Fig. 115
134	Ras Ibn Hani	Bounni <i>et al.</i> 1998, Fig. 159.5, 8
157	Tell Bazi	Otto 2006, Abb. 42.7a-b
158	Ras Ibn Hani	Bounni <i>et al.</i> 1998, Fig. 159.3-4
160	Tyre	Bikai 1978b, Pl. 42.5
161	Sarepta	Anderson 1988, Pl. 27.20
164	Tell Bazi	Otto 2006, Abb. 42.10a-b
165	Tell Arqa	Thalman 2006b, Pl. 106.12
168	Tell Arqa	Thalman 2006b, Pl. 106.13
184	Tel Dan	Ben Dov 2002, Figs 2.29.7; 54.5-7
187	Tell Arqa	Thalman 2006b, Pl. 107.11
188	Ras Ibn Hani	Bounni <i>et al.</i> 1978, Fig. 28.1

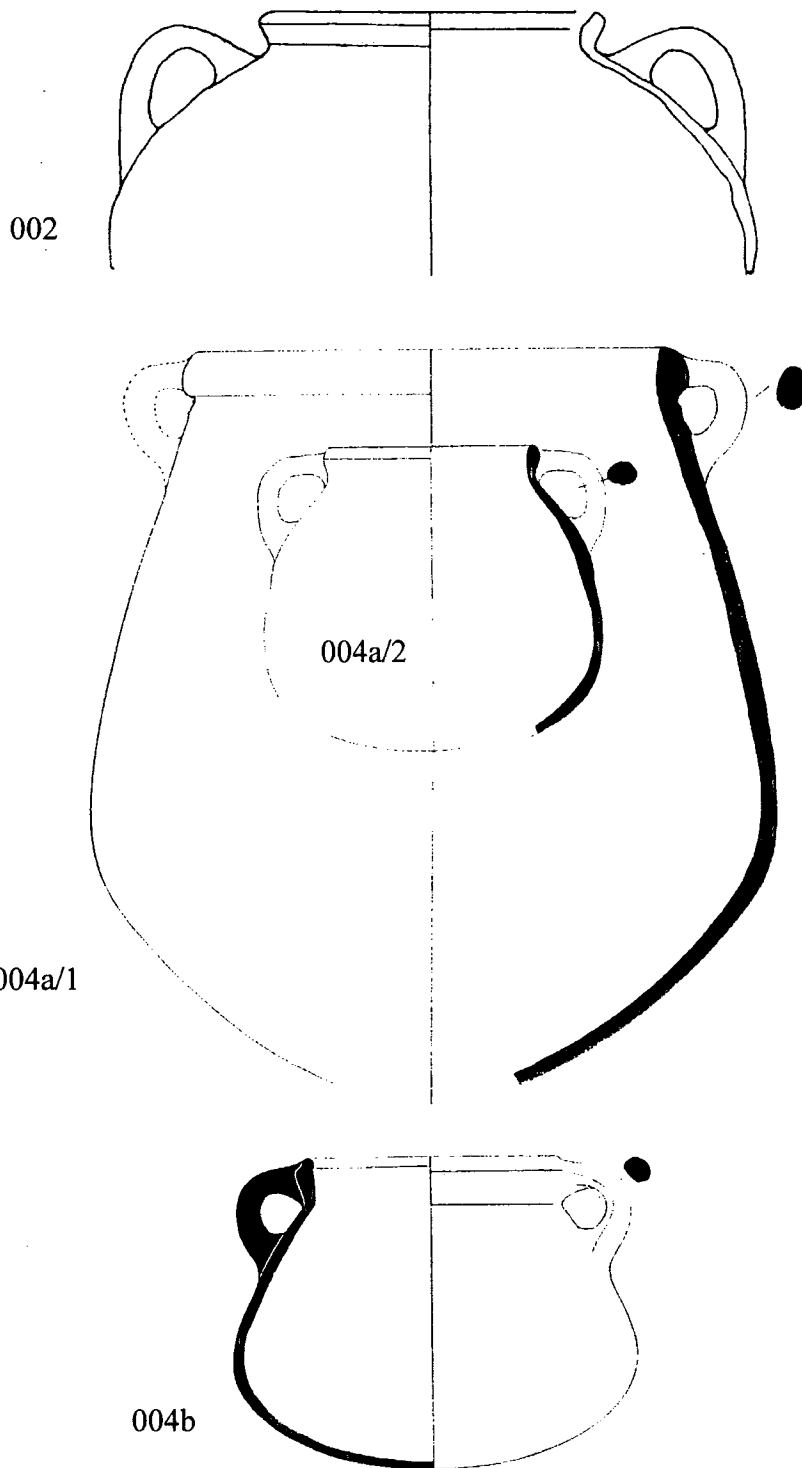
## FIGURES



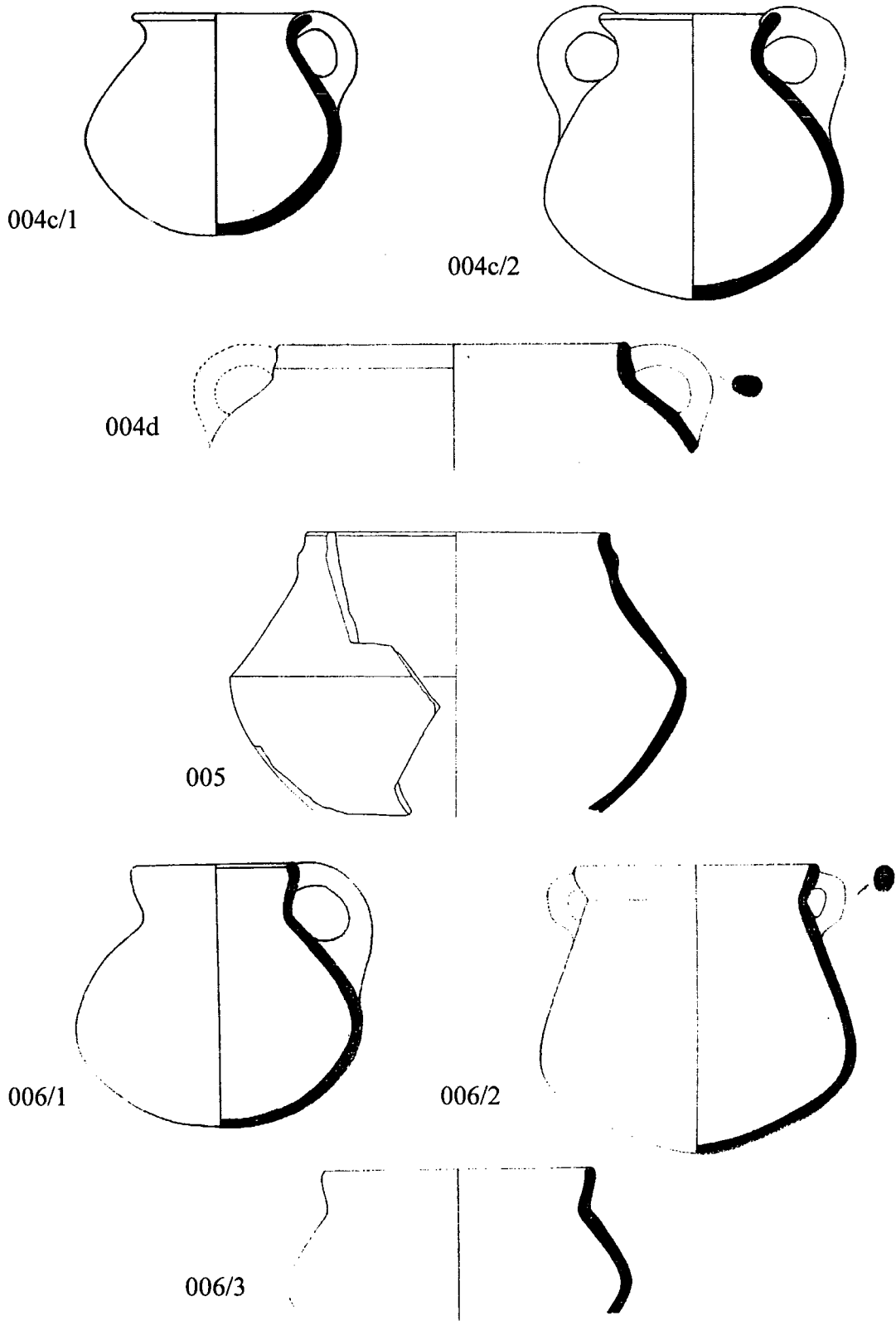




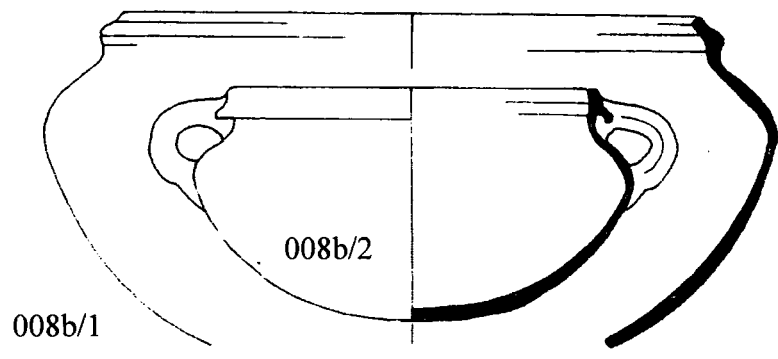
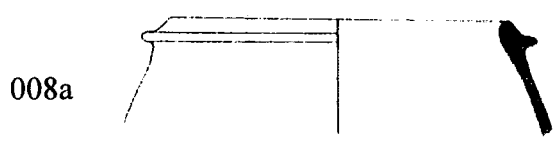
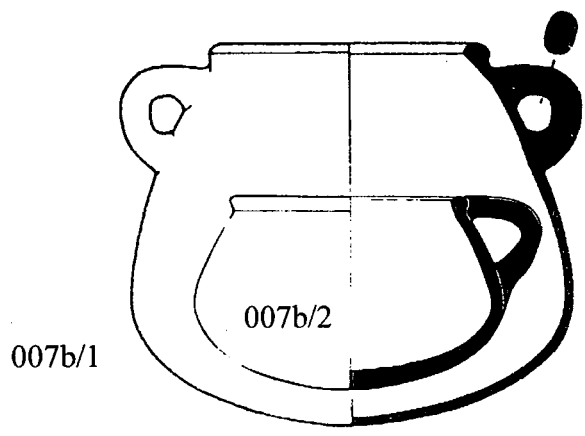
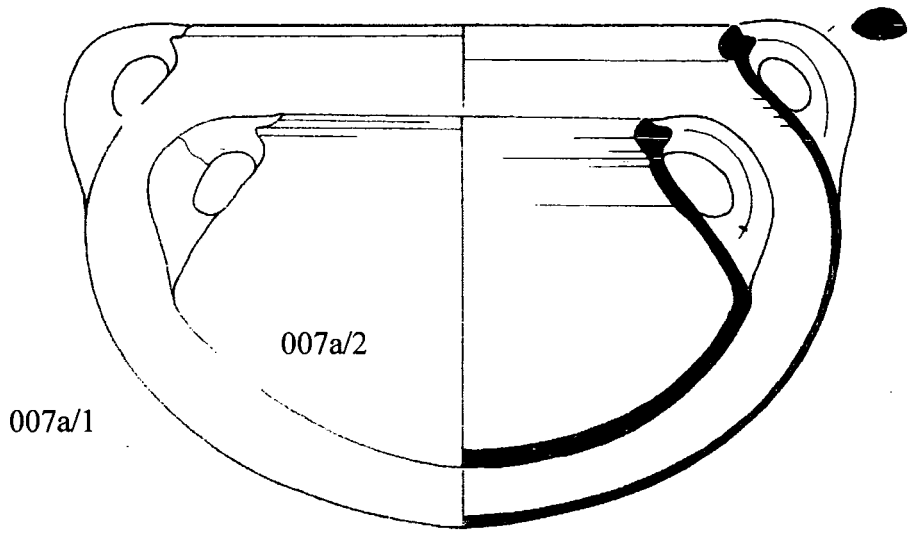
**Fig. 1 Cooking Pot CLASSES Used in This Study**



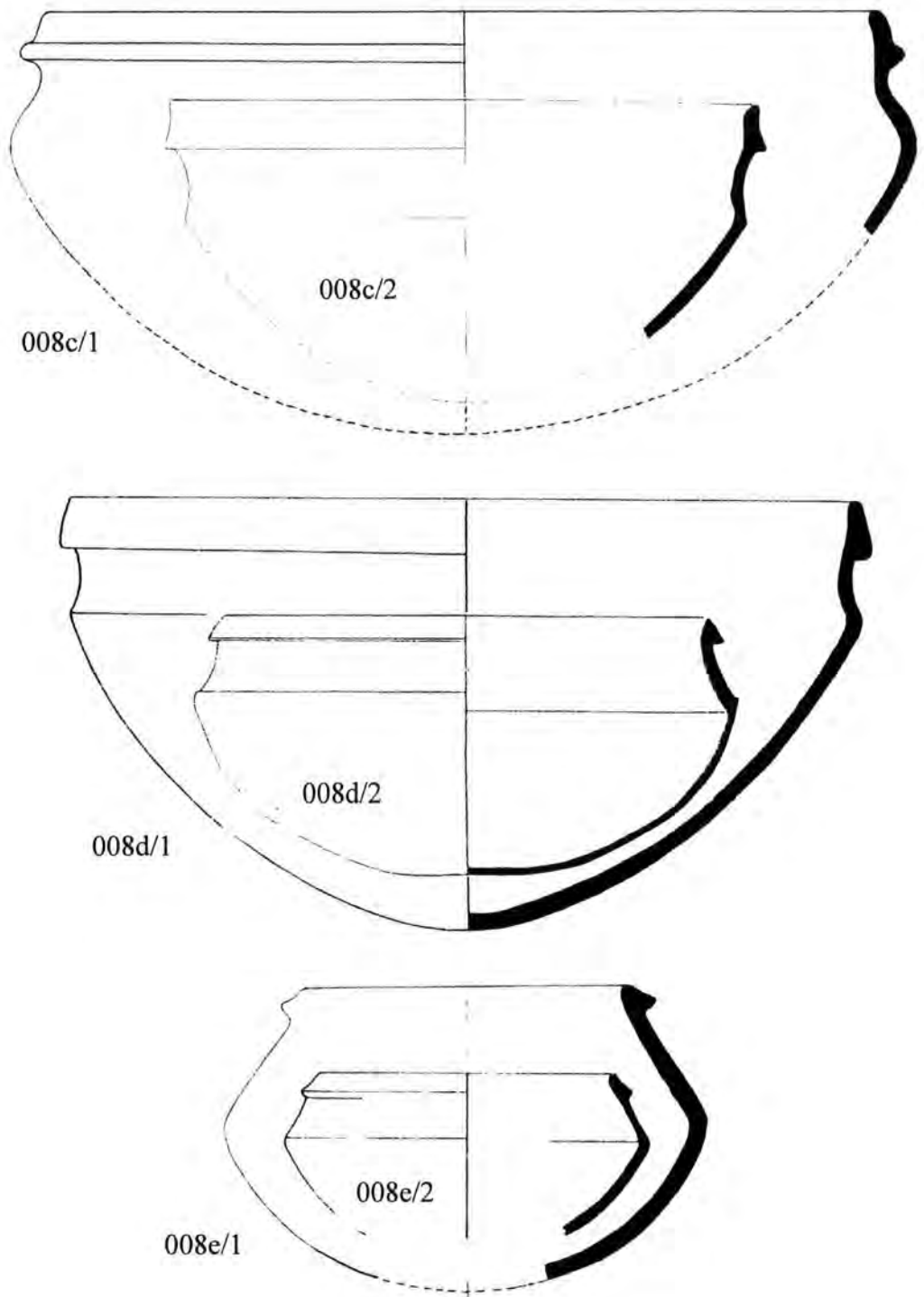
**Fig. 2 Cooking Pot CLASSES Used in This Study**



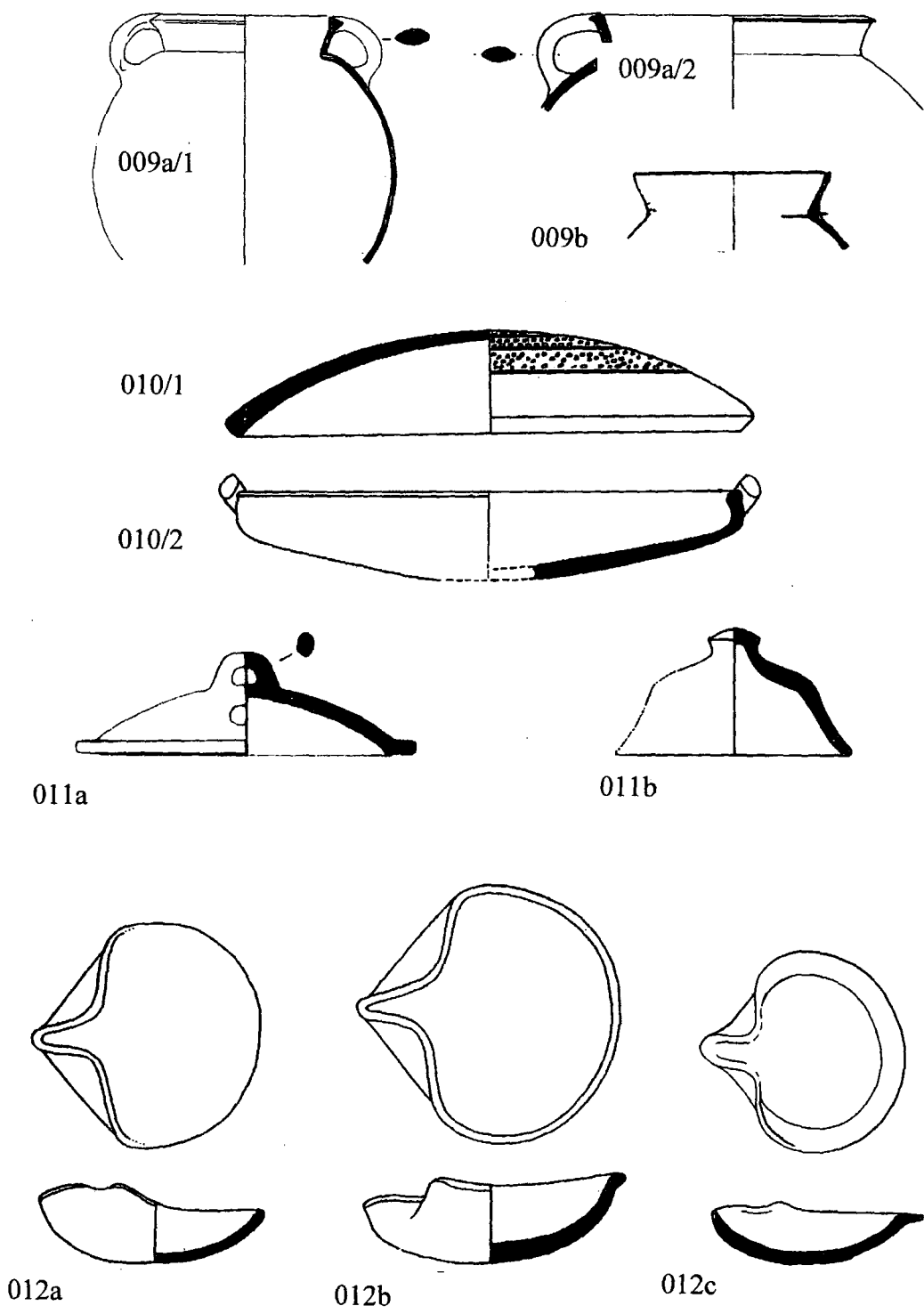
**Fig. 3 Cooking Pot CLASSES Used in This Study**



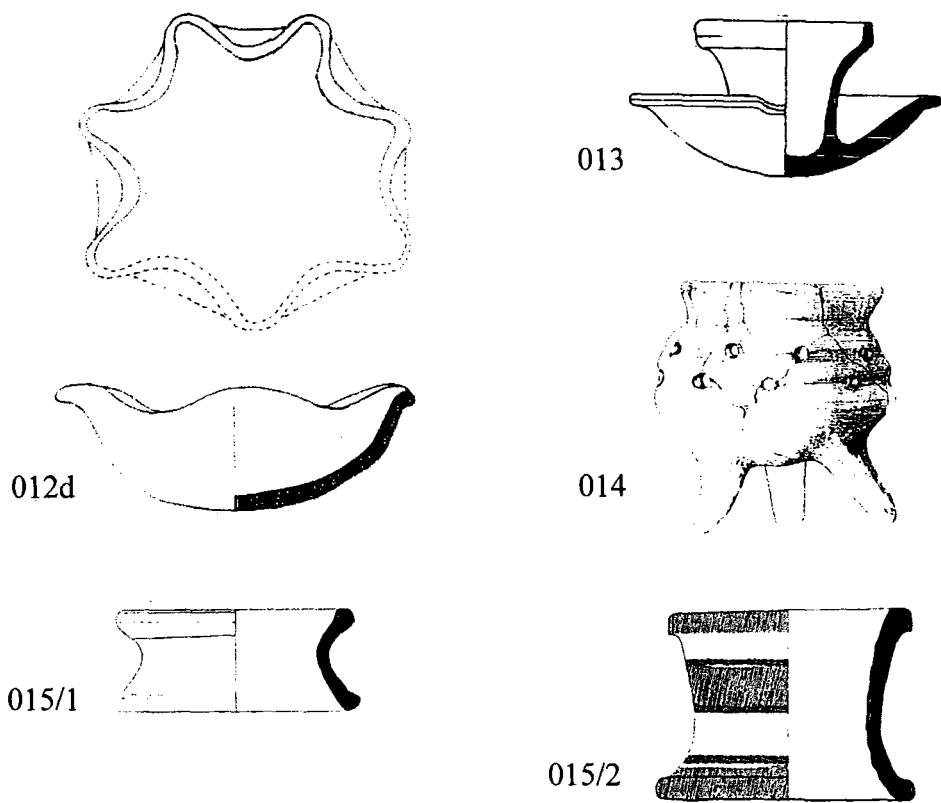
**Fig. 4 Cooking Pot CLASSES Used in This Study**



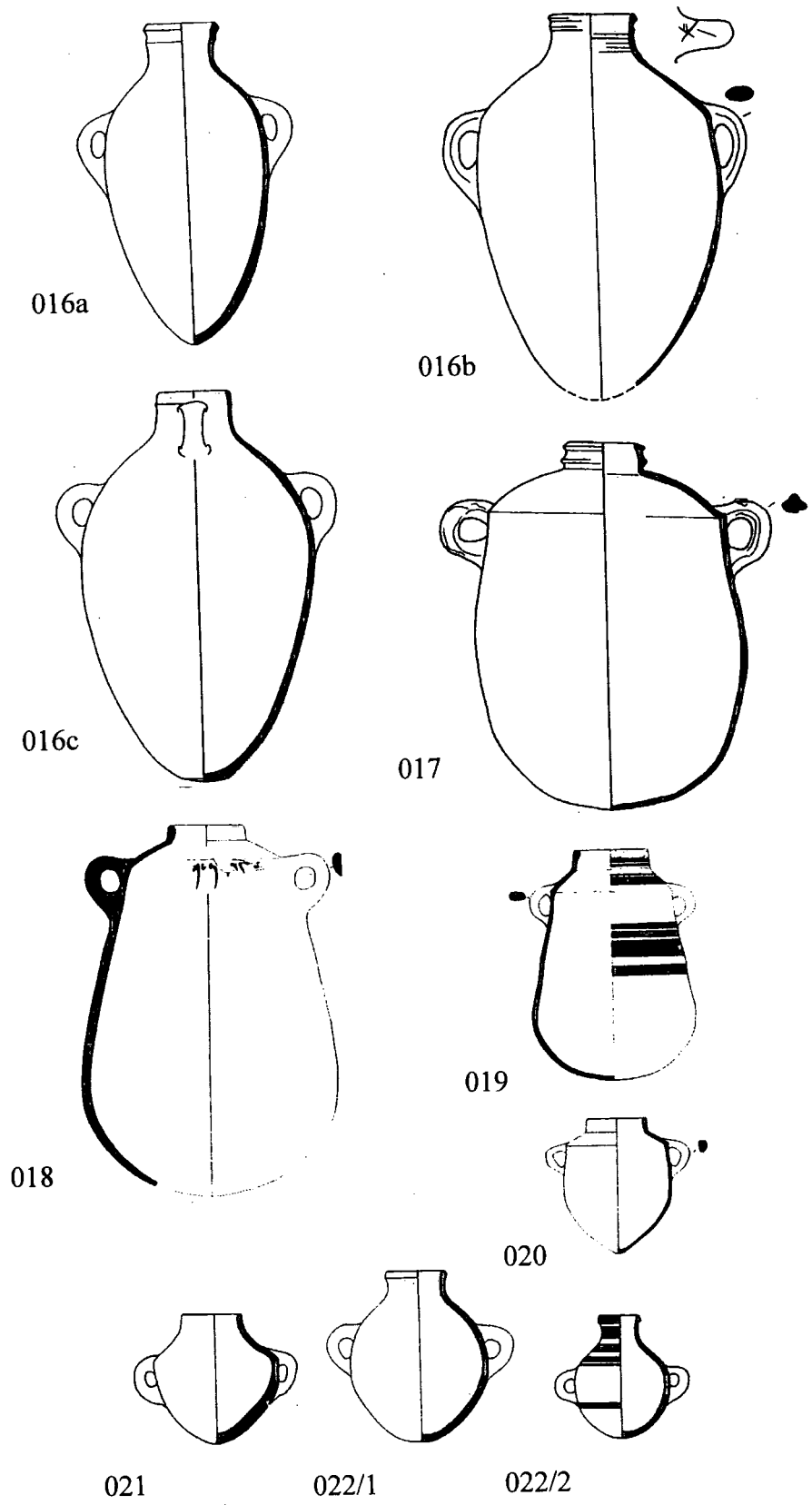
**Fig. 5 Cooking Pot CLASSES Used in This Study**



**Fig. 6 Cooking Pot and Lid CLASSES Used in This Study**

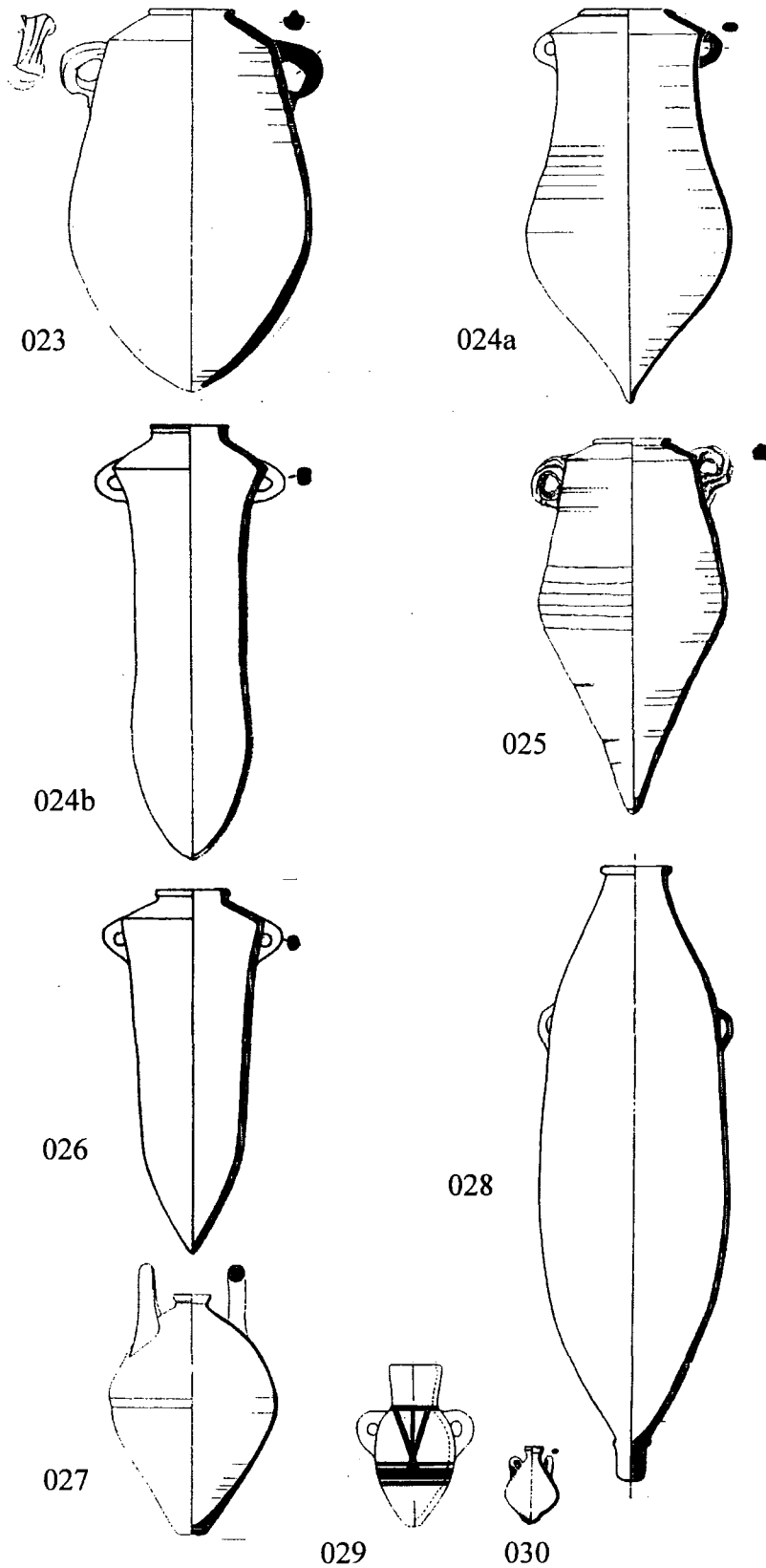


**Fig. 7 Lid and Miscellaneous CLASSES Used in This Study**

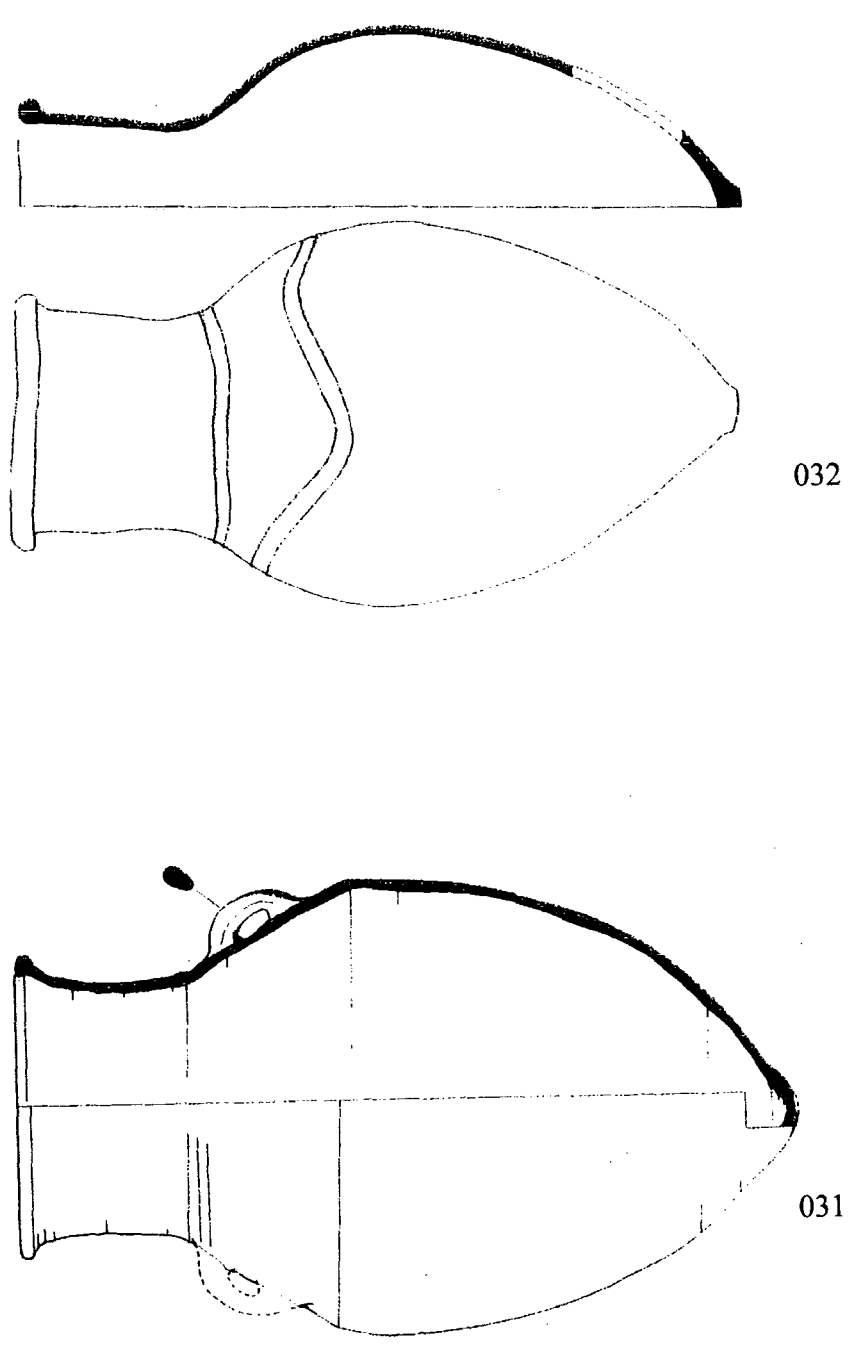


**Fig. 8 Transport Amphora CLASSES Used in This Study**

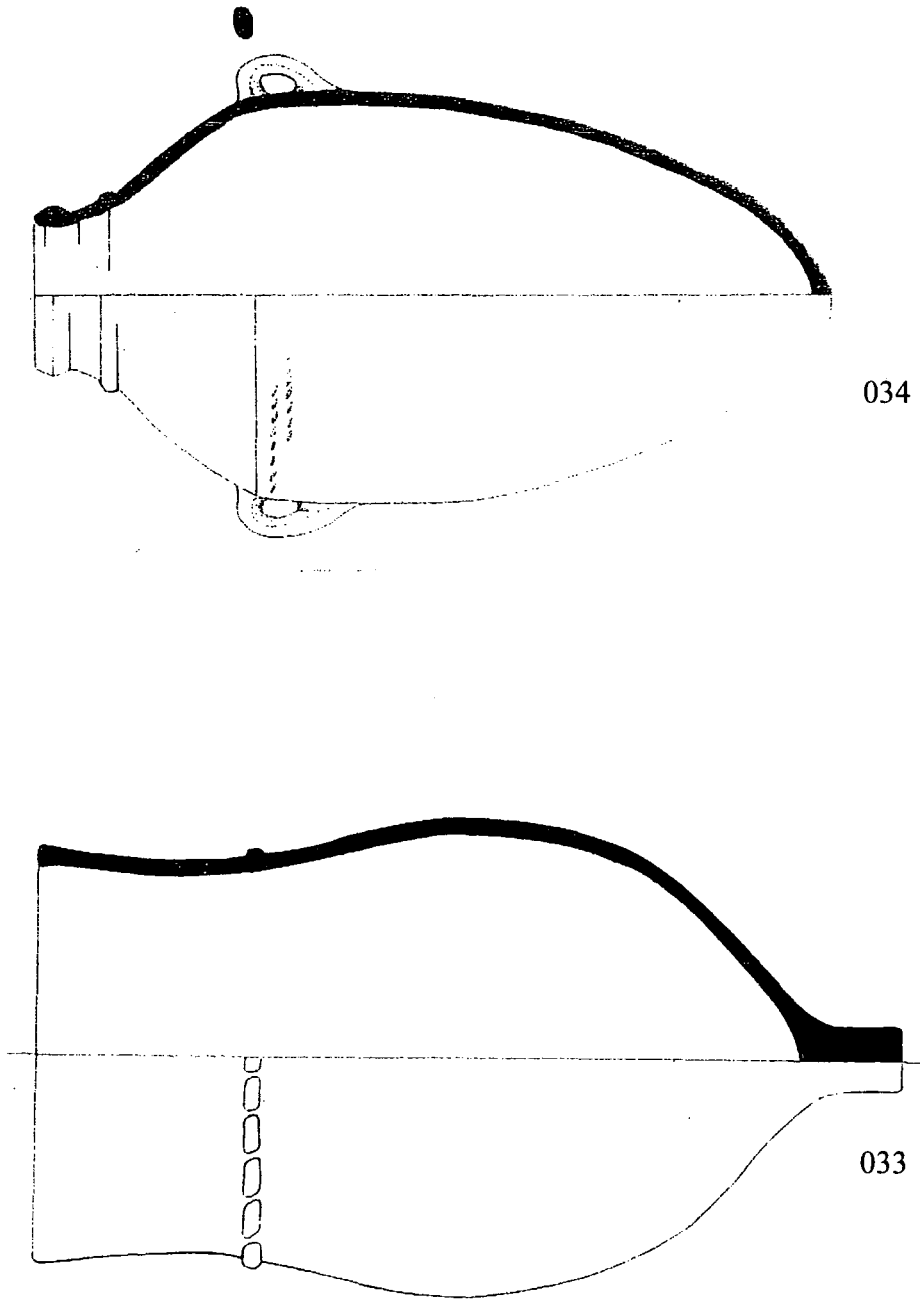




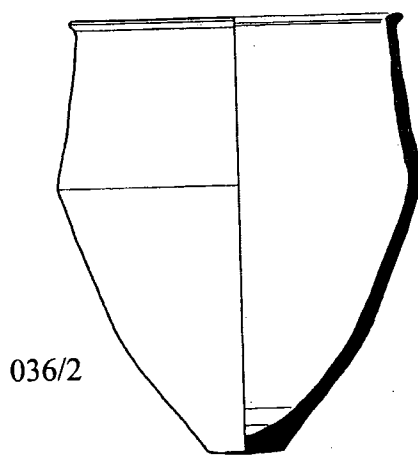
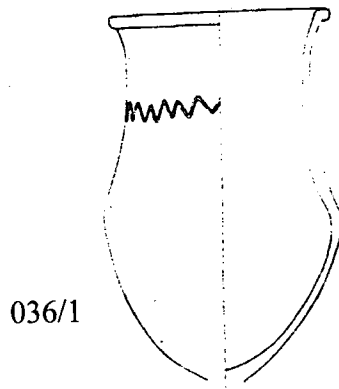
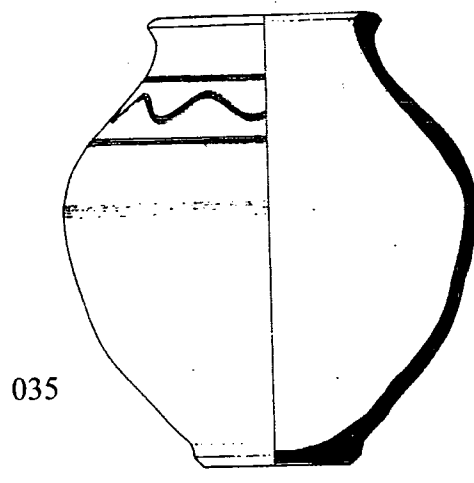
**Fig. 9 Transport Amphora CLASSES Used in This Study**



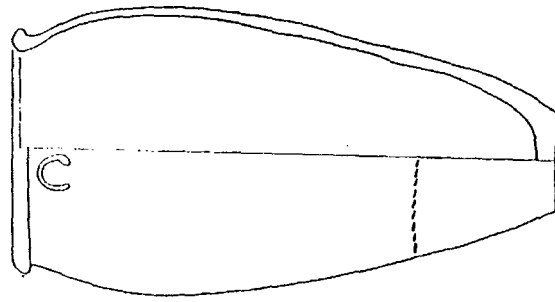
**Fig. 10 Pithoi CLASSES Used in This Study**



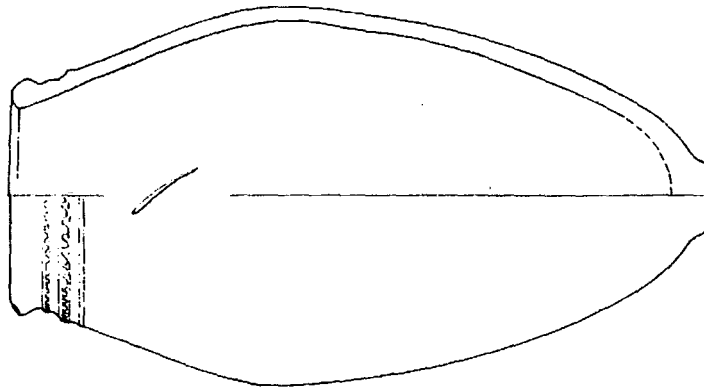
**Fig. 11 Pithoi CLASSES Used in This Study**



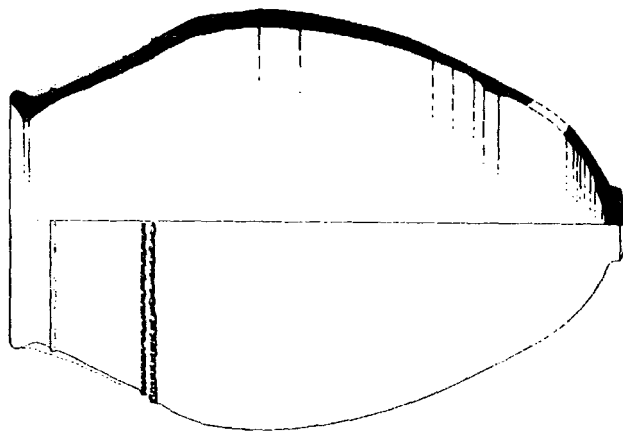
**Fig. 12 Pithoi CLASSES Used in This Study**



037b/2

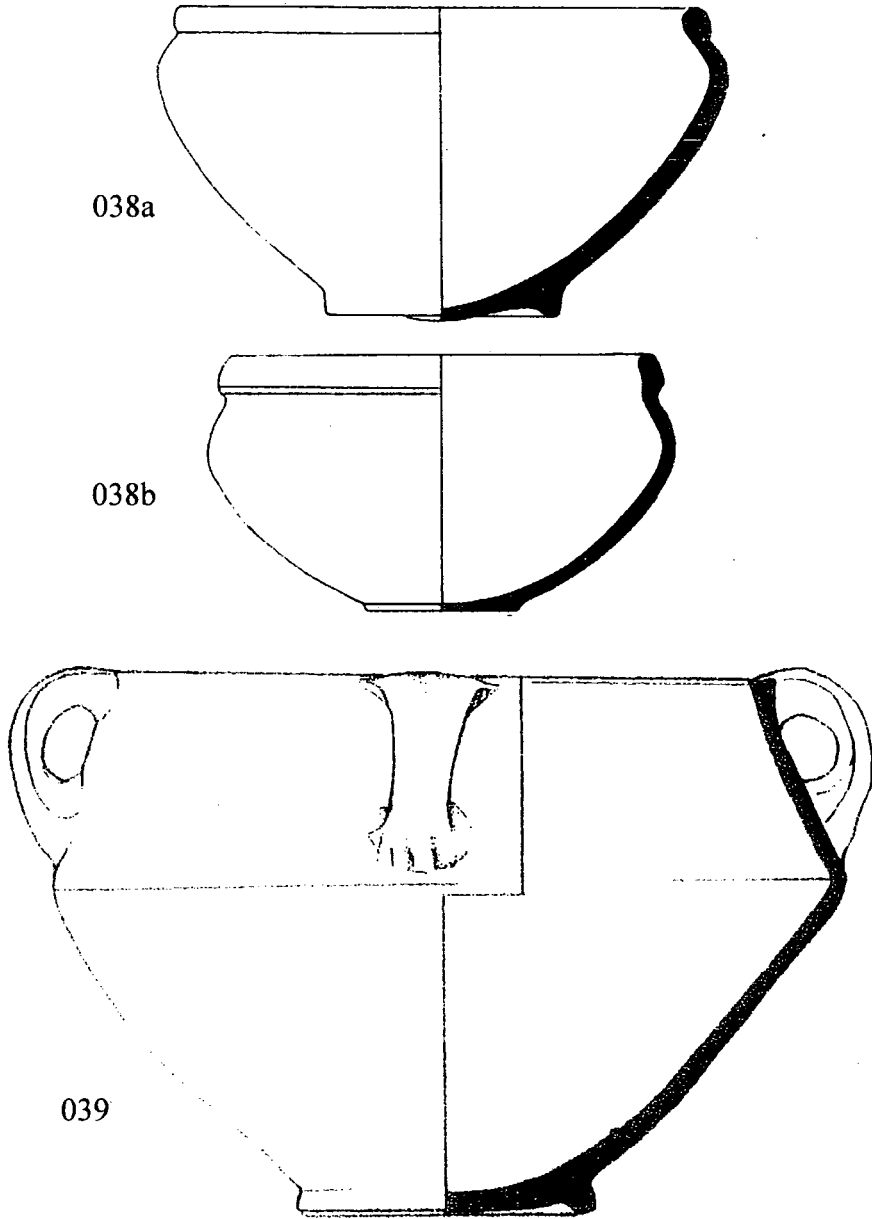


037b/1

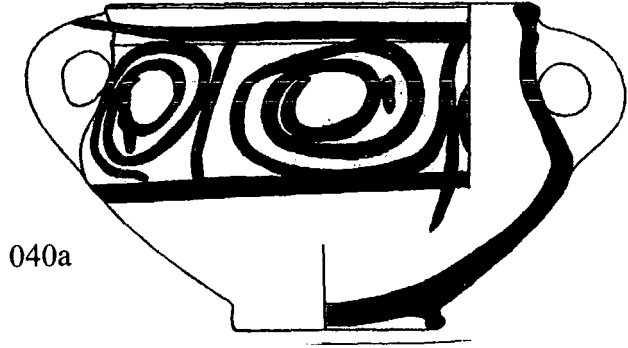


037a

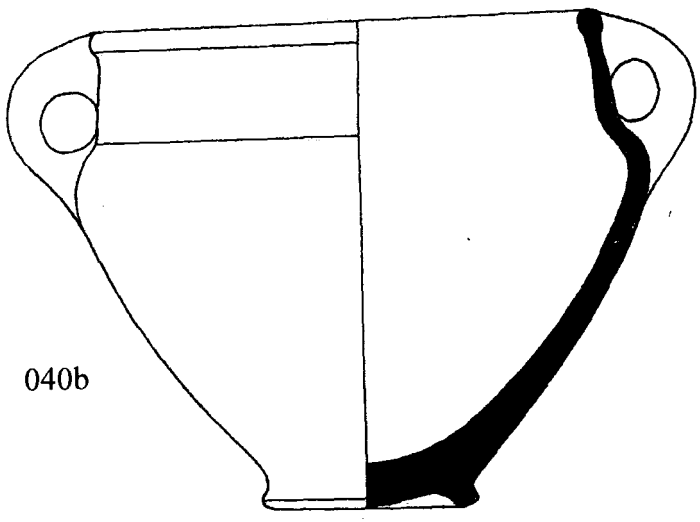
**Fig. 13 Pithoi CLASSES Used in This Study**



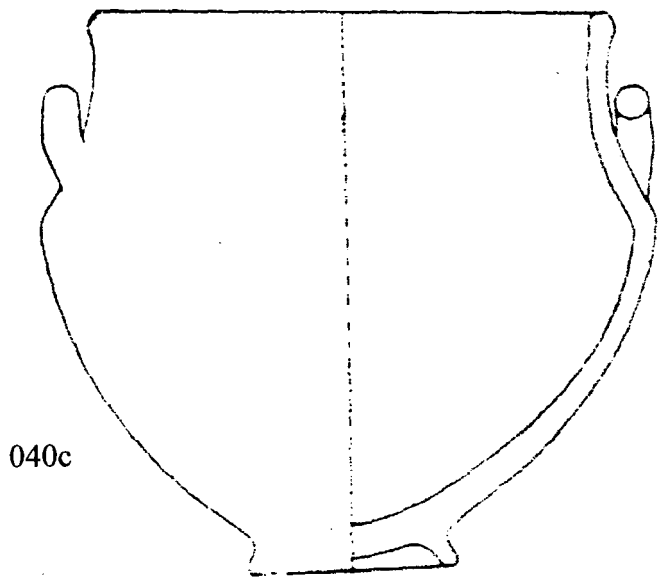
**Fig. 14 Krater CLASSES Used in This Study**



040a

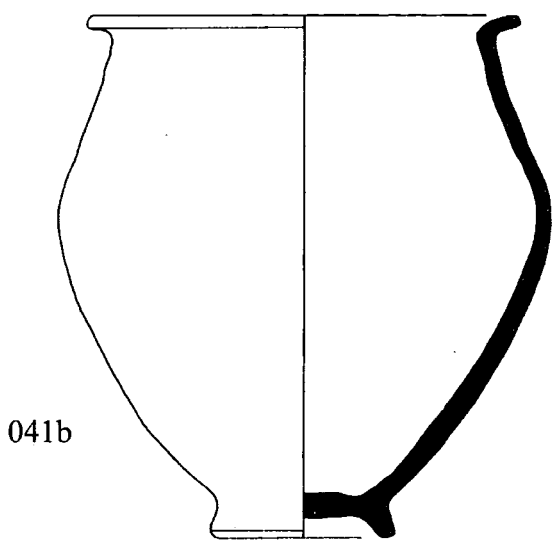
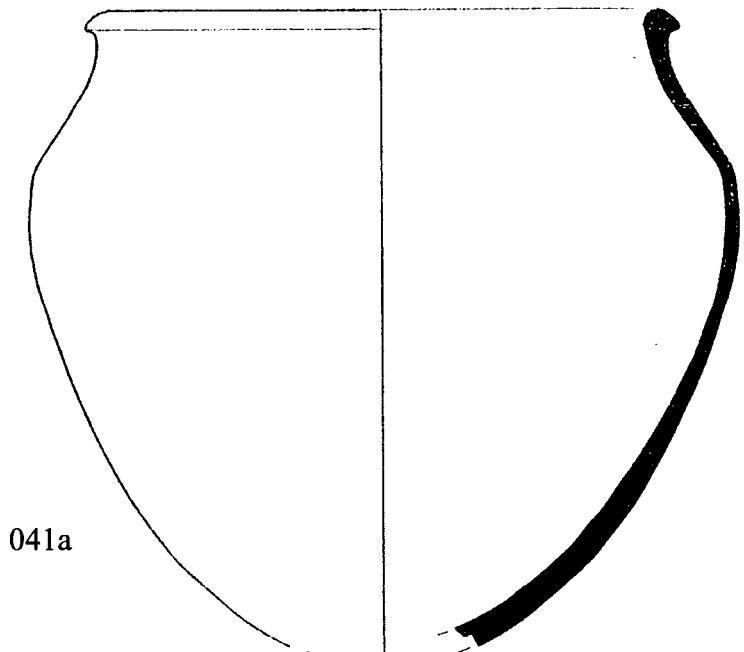


040b



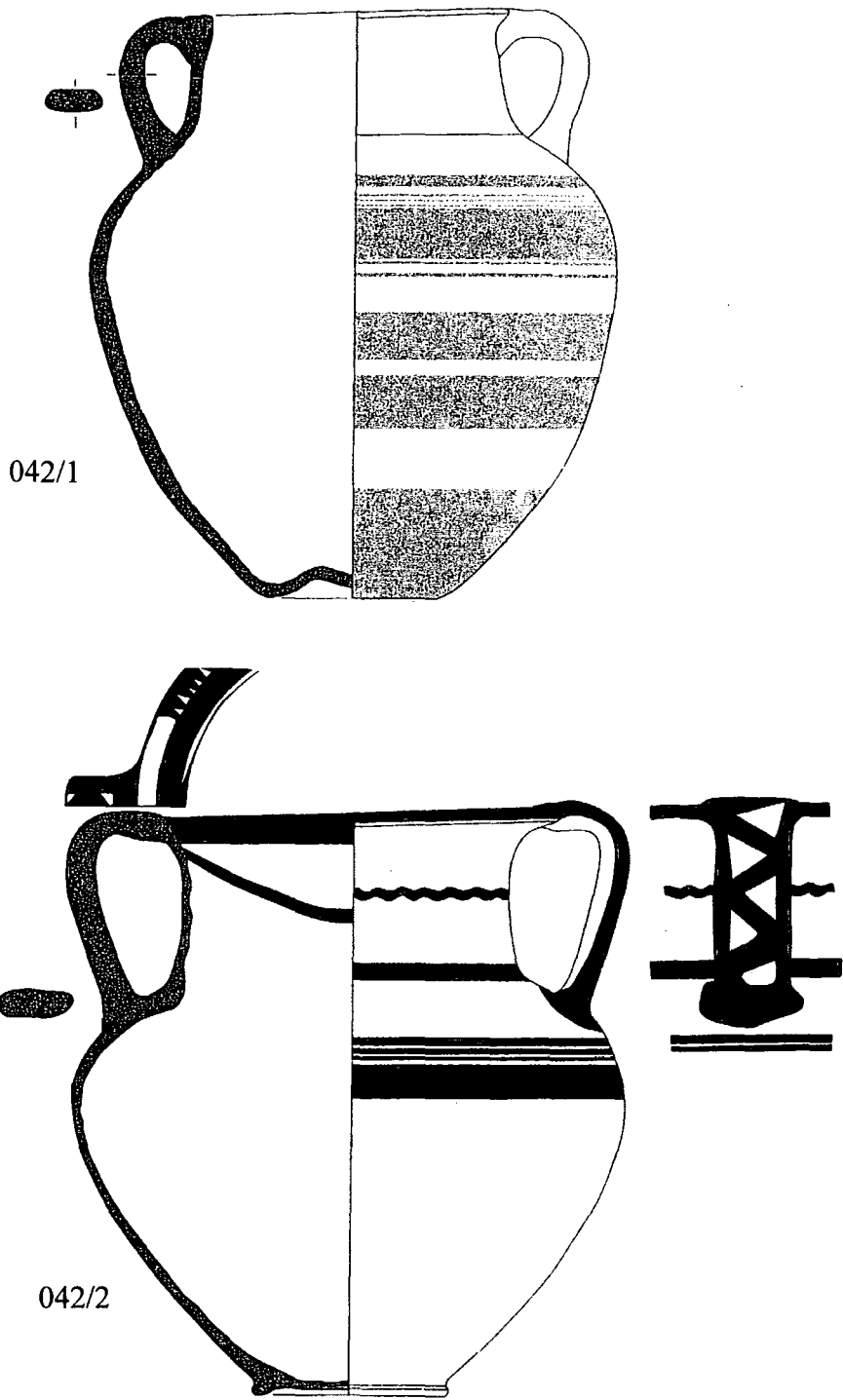
040c

**Fig. 15 Krater CLASSES Used in This Study**

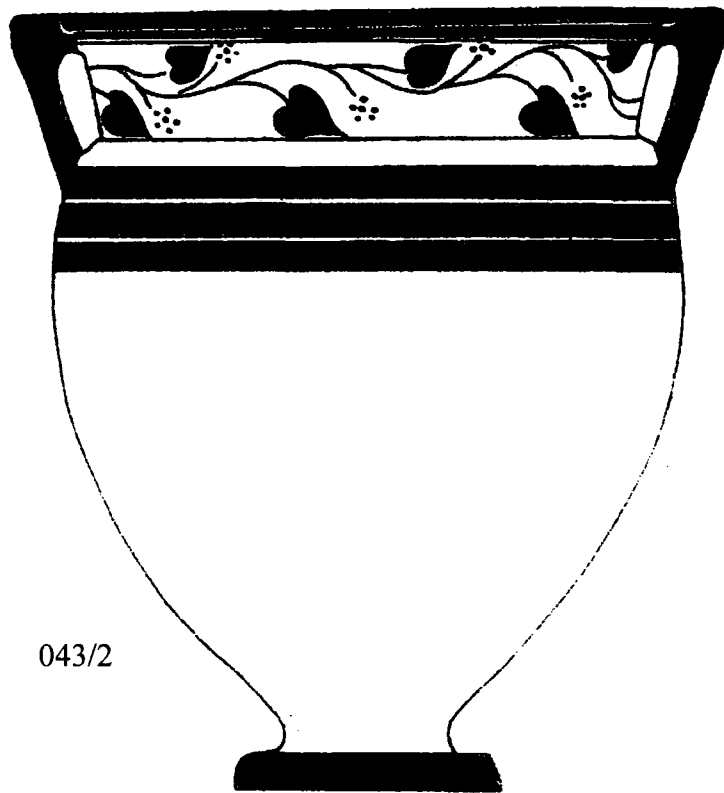
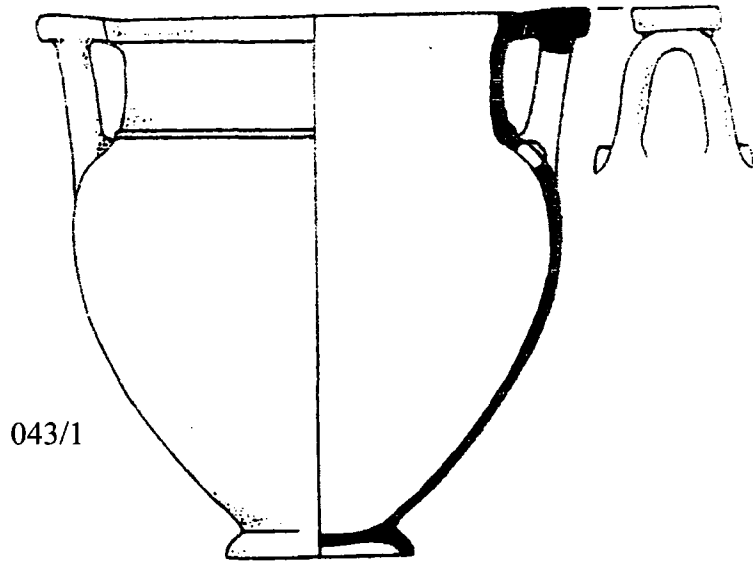


**Fig. 16 Krater CLASSES Used in This Study**

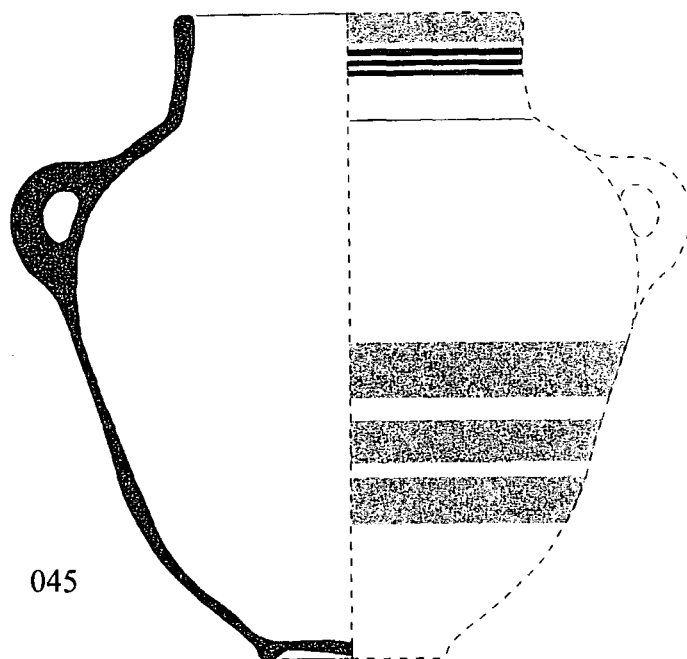
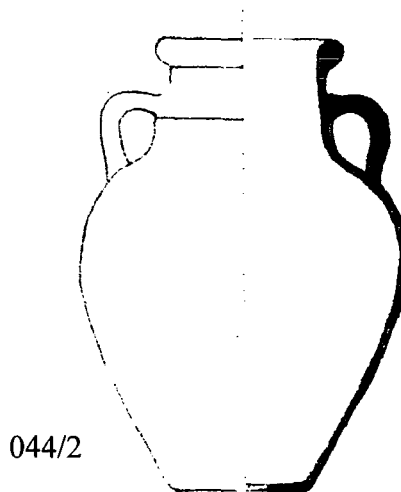
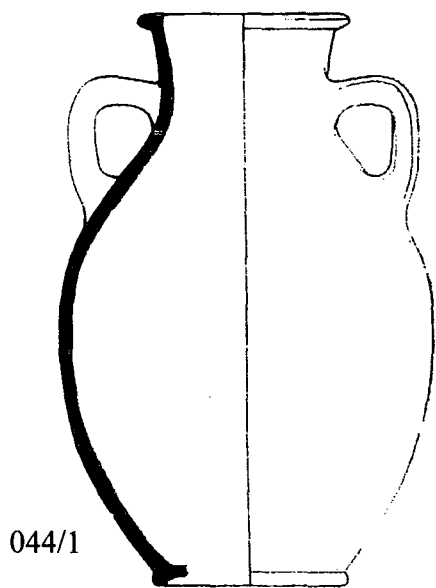




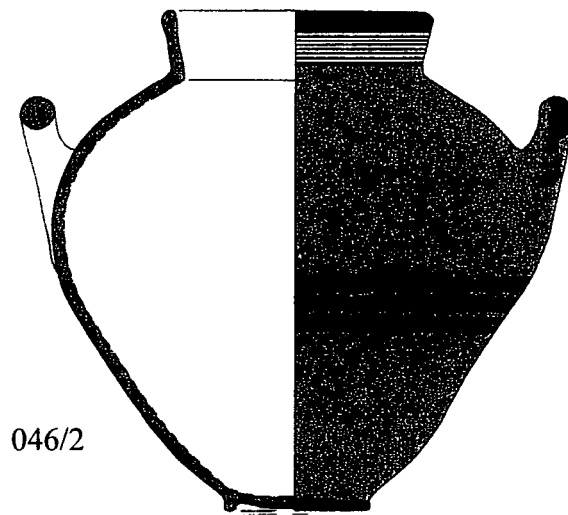
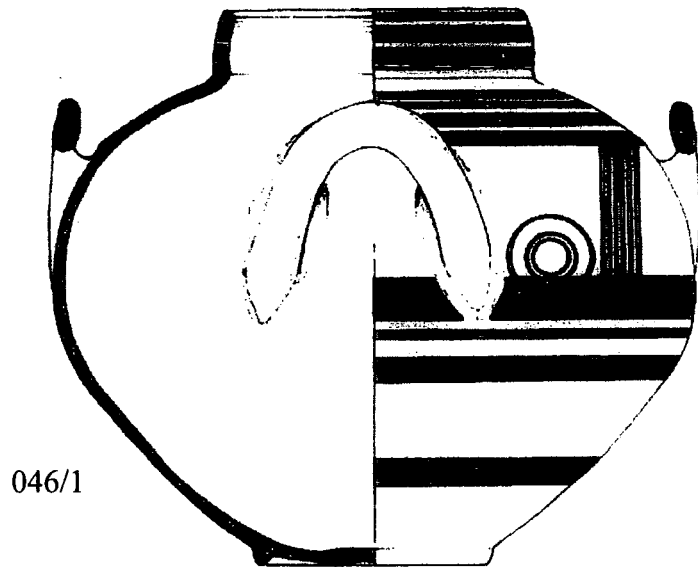
**Fig. 17 Krater CLASSES Used in This Study**



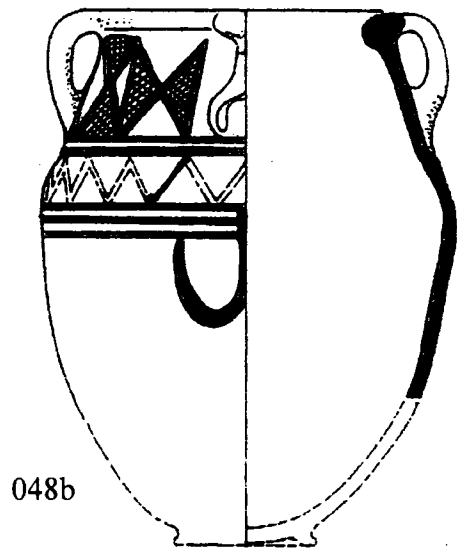
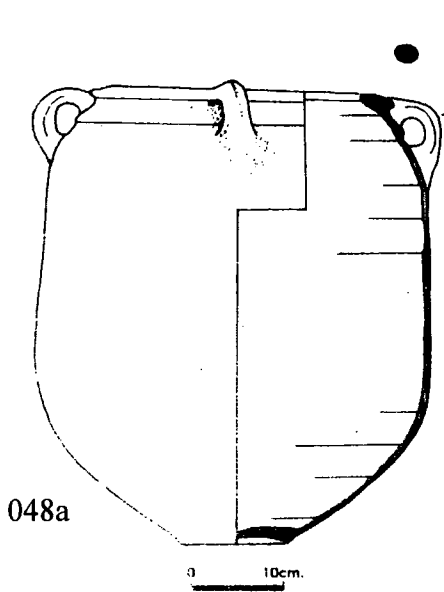
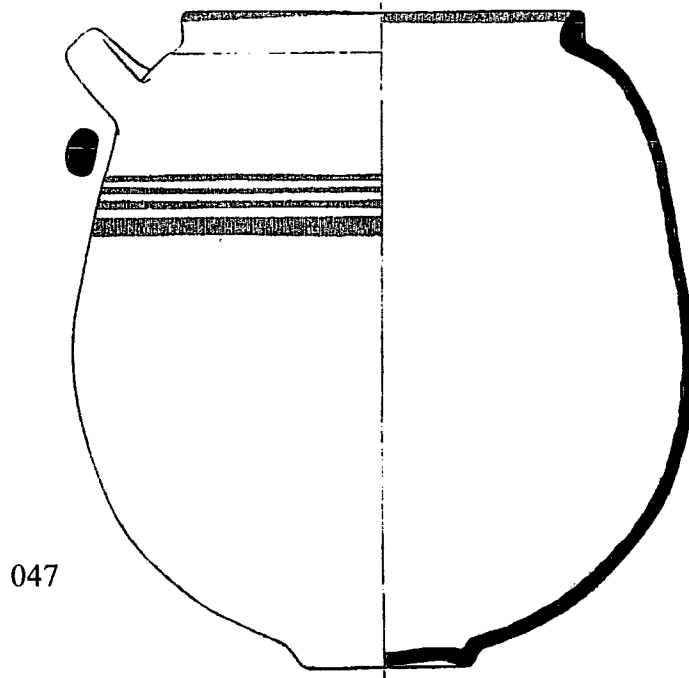
**Fig. 18 Krater CLASSES Used in This Study**



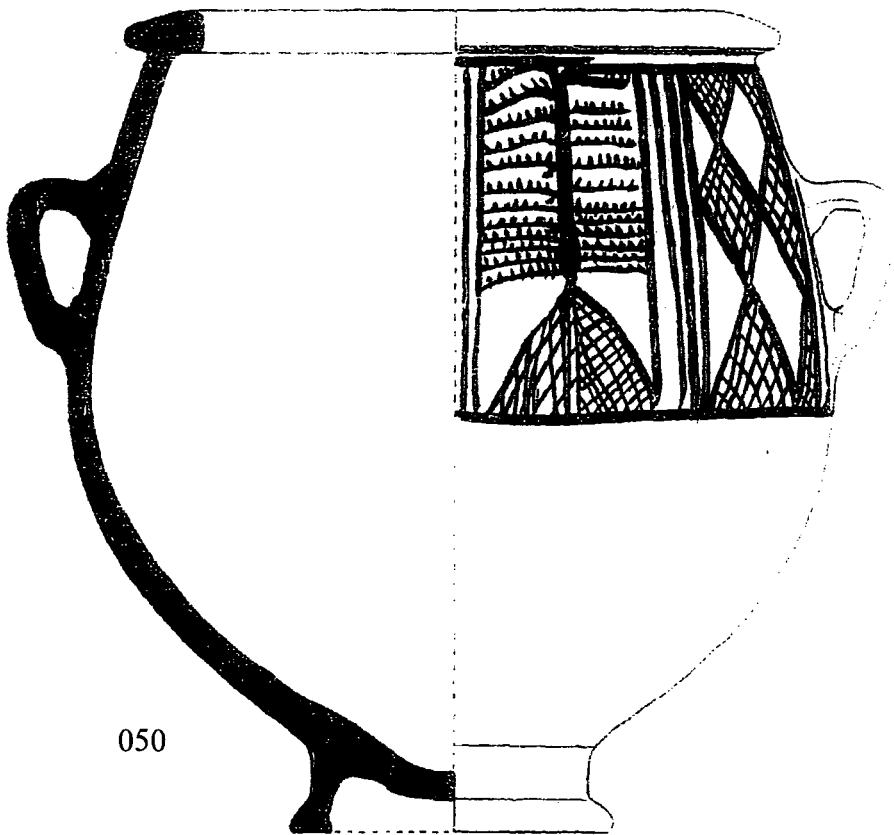
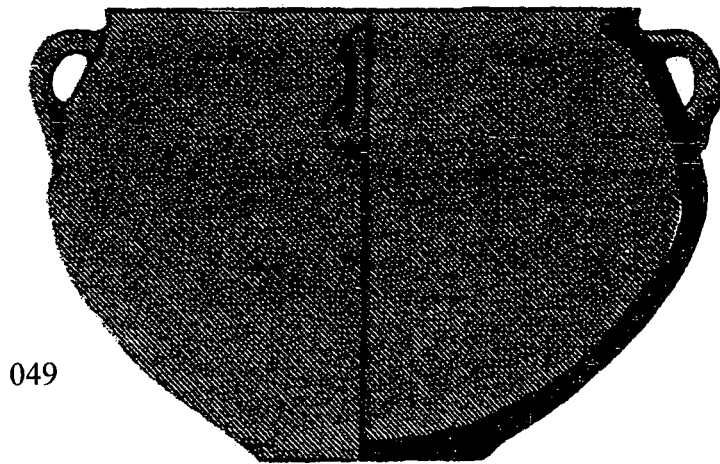
**Fig. 19 Krater CLASSES Used in This Study**



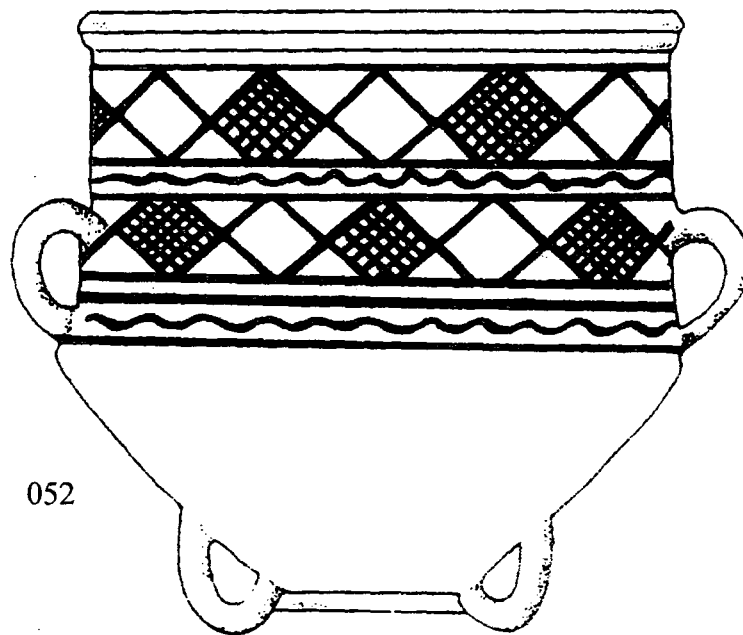
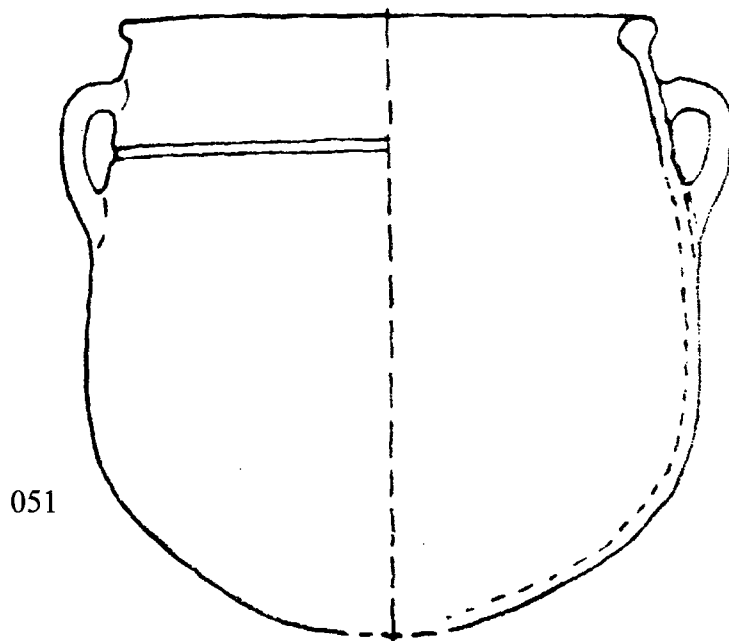
**Fig. 20 Krater CLASSES Used in This Study**



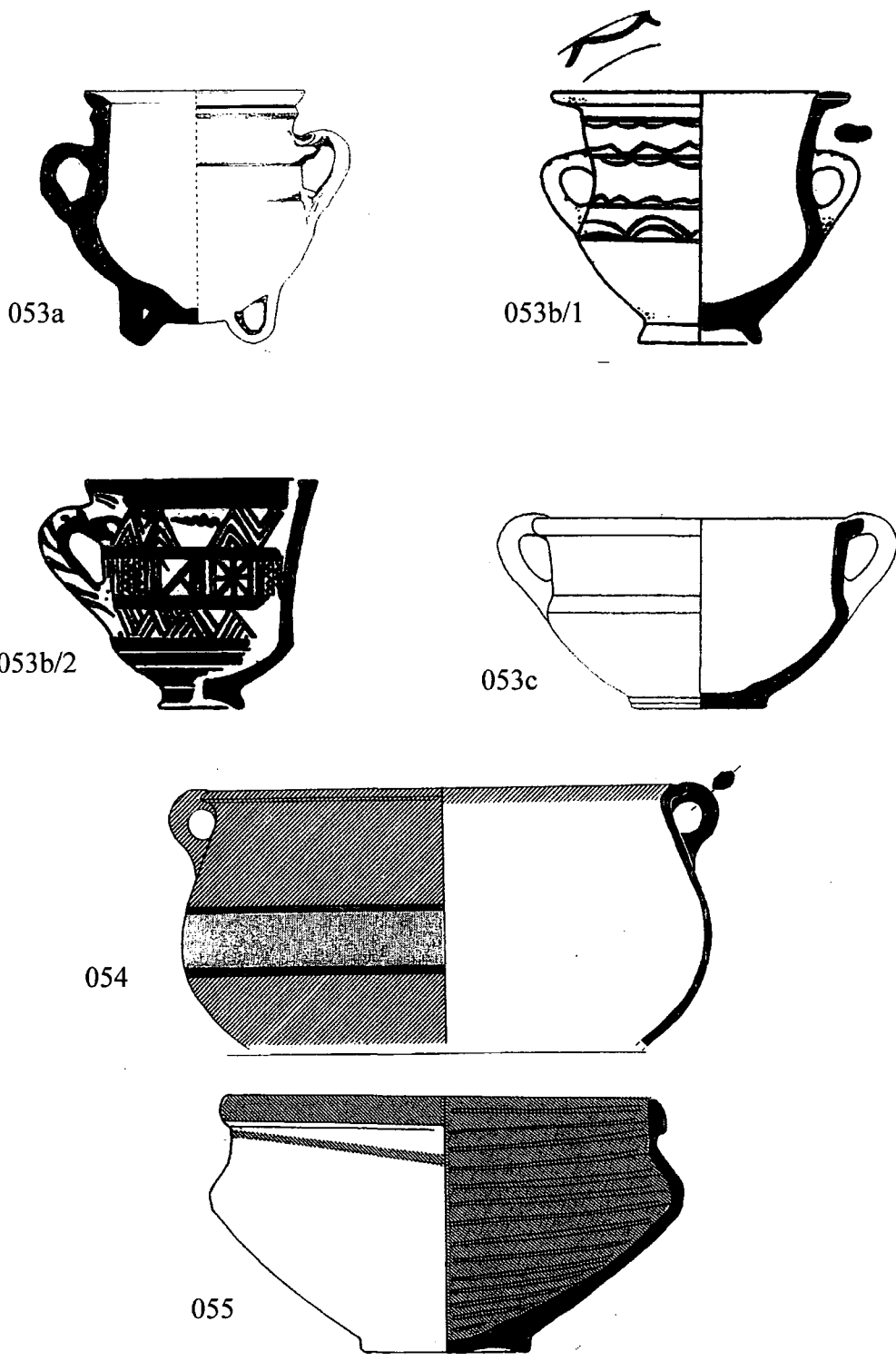
**Fig. 21 Krater CLASSES Used in This Study**



**Fig. 22 Krater CLASSES Used in This Study**

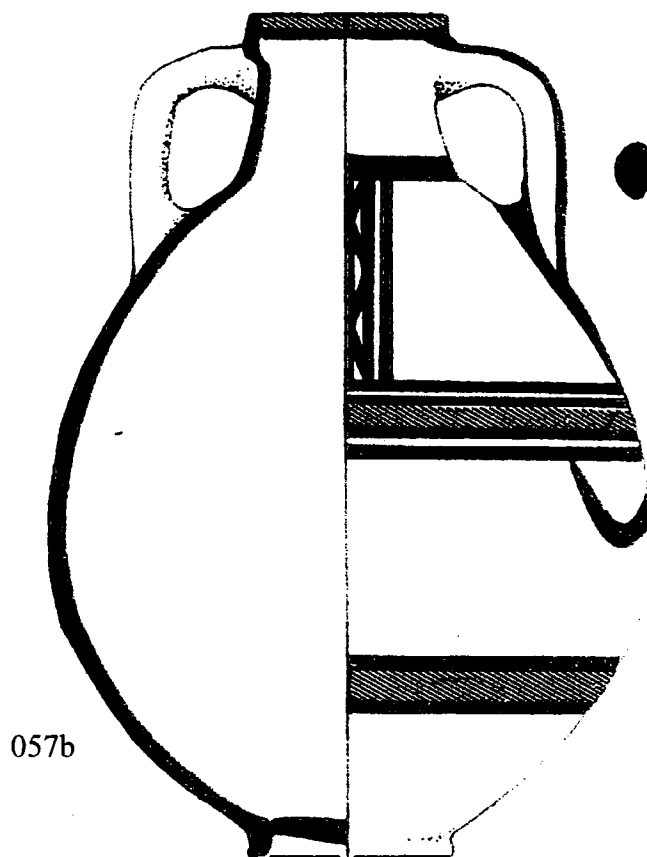
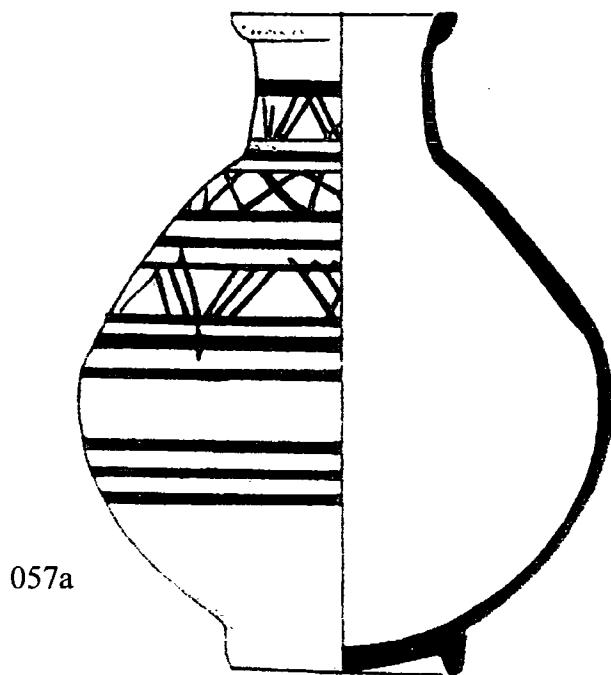


**Fig. 23 Krater CLASSES Used in This Study**

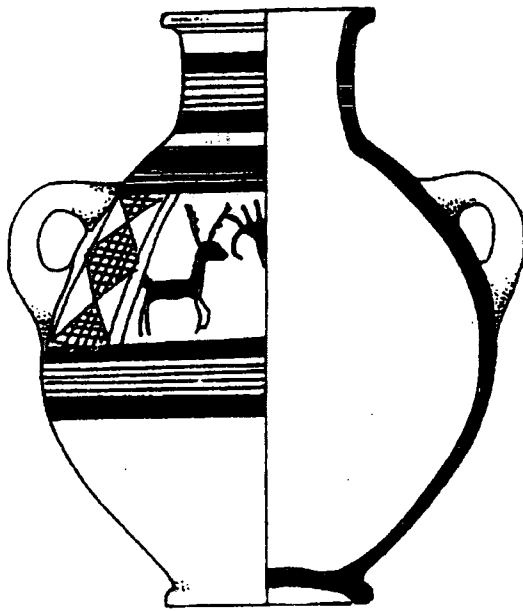


**Fig. 24 Krater CLASSES Used in This Study**





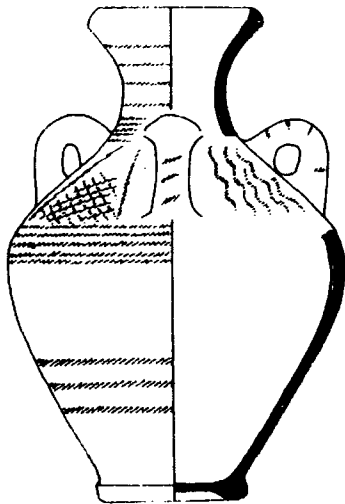
**Fig. 25** Urn (Storage Amphora) CLASSES Used in This Study



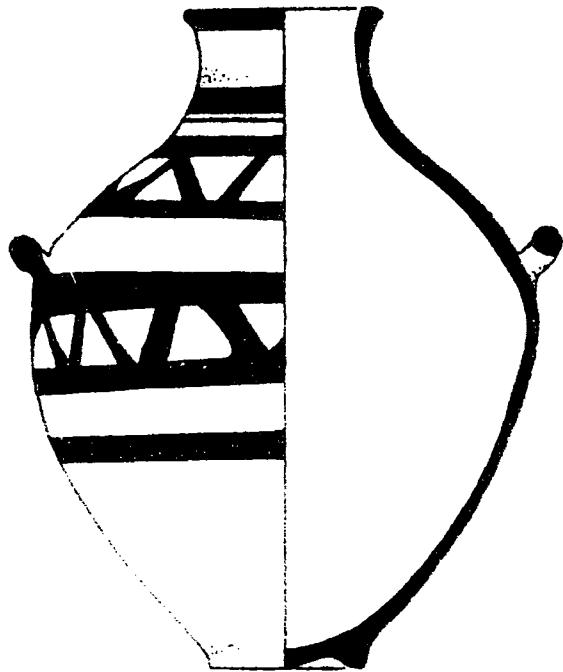
057c/1



057c/2

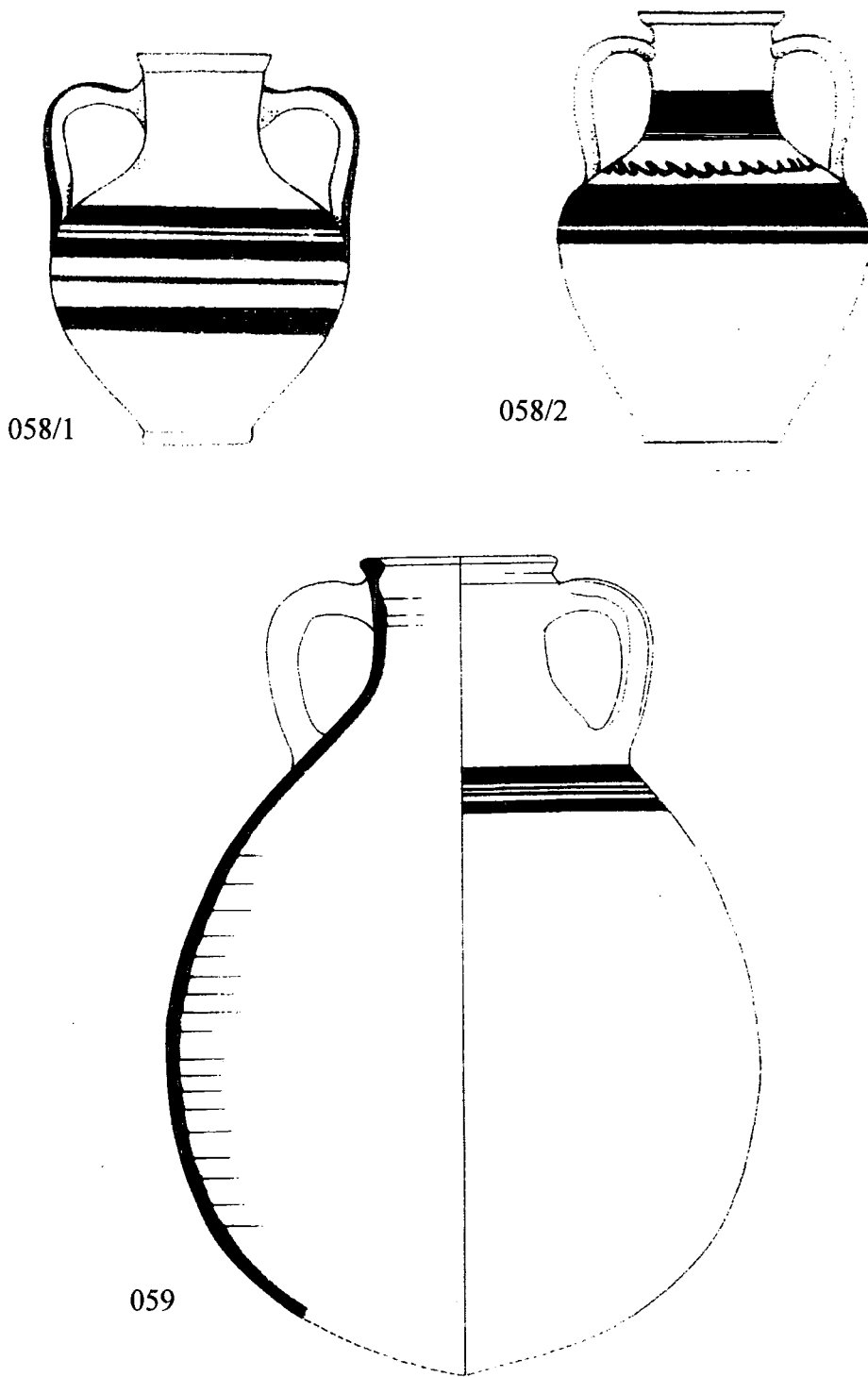


057d

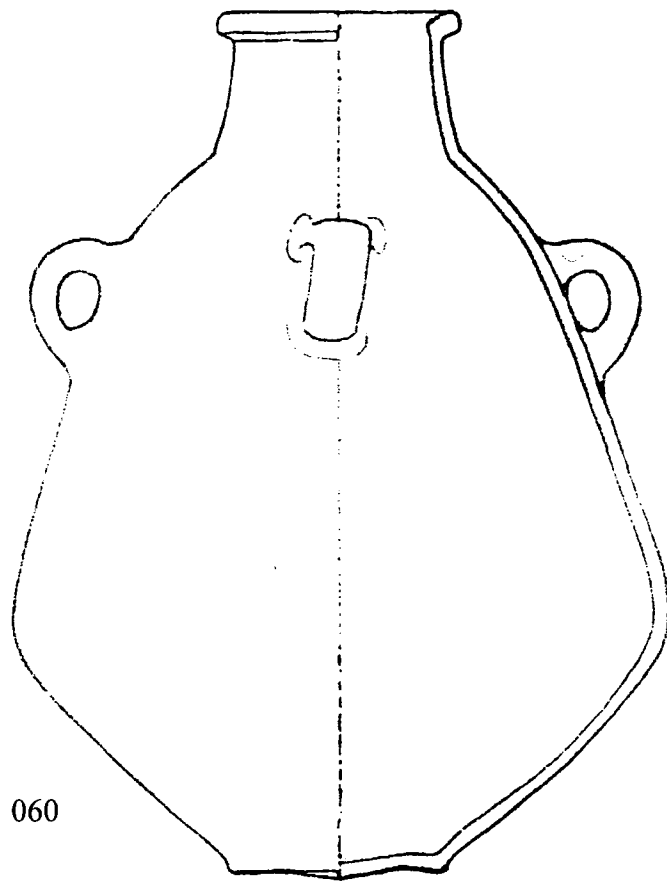


057e

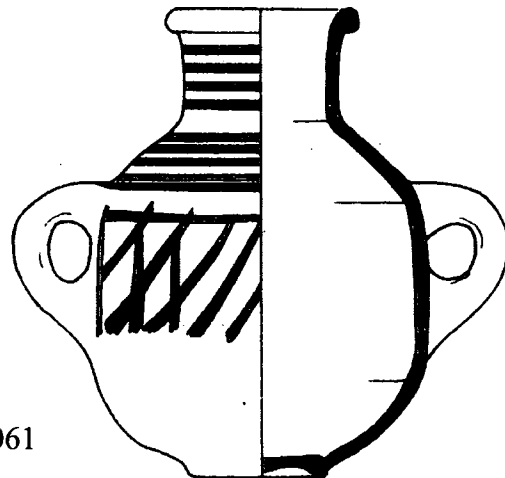
**Fig. 26** Urn (Storage Amphora) CLASSES Used in This Study



**Fig. 27 Urn (Storage Amphora) CLASSES Used in This Study**

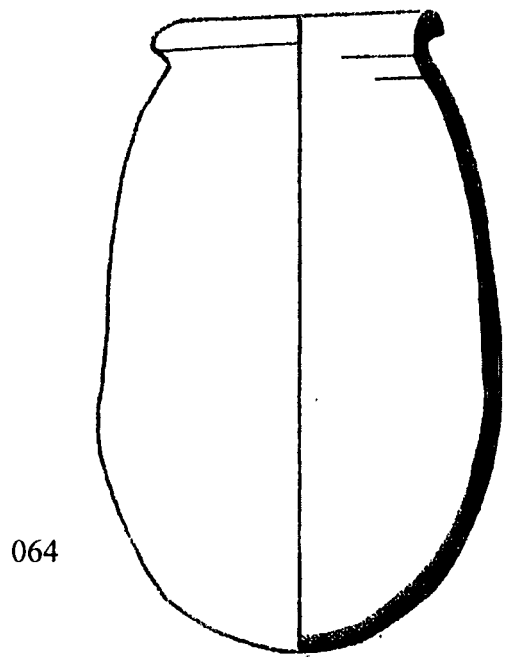
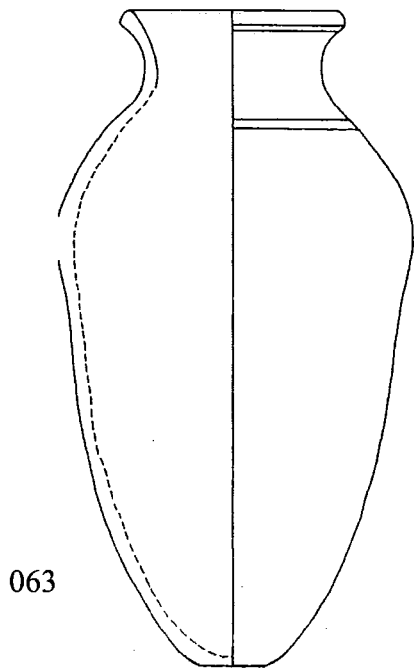
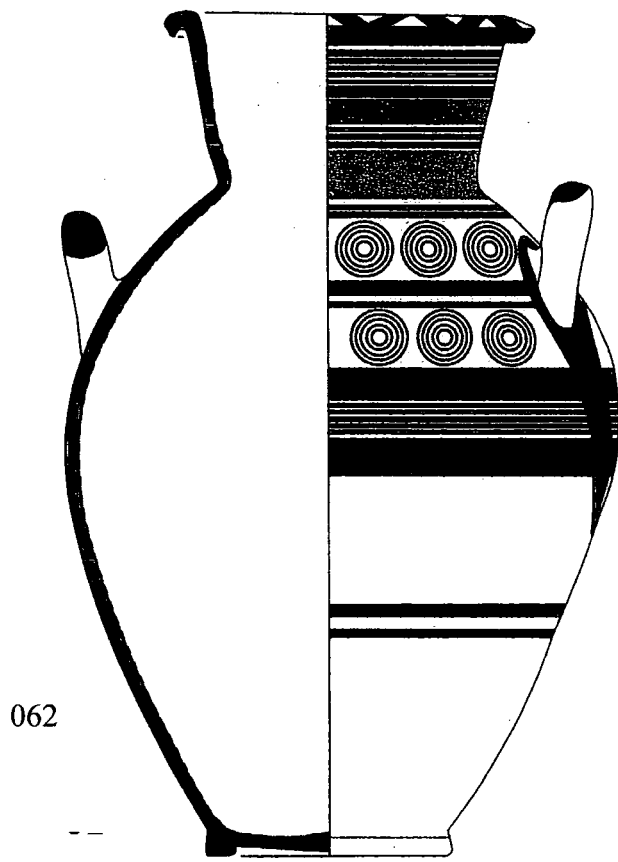


060

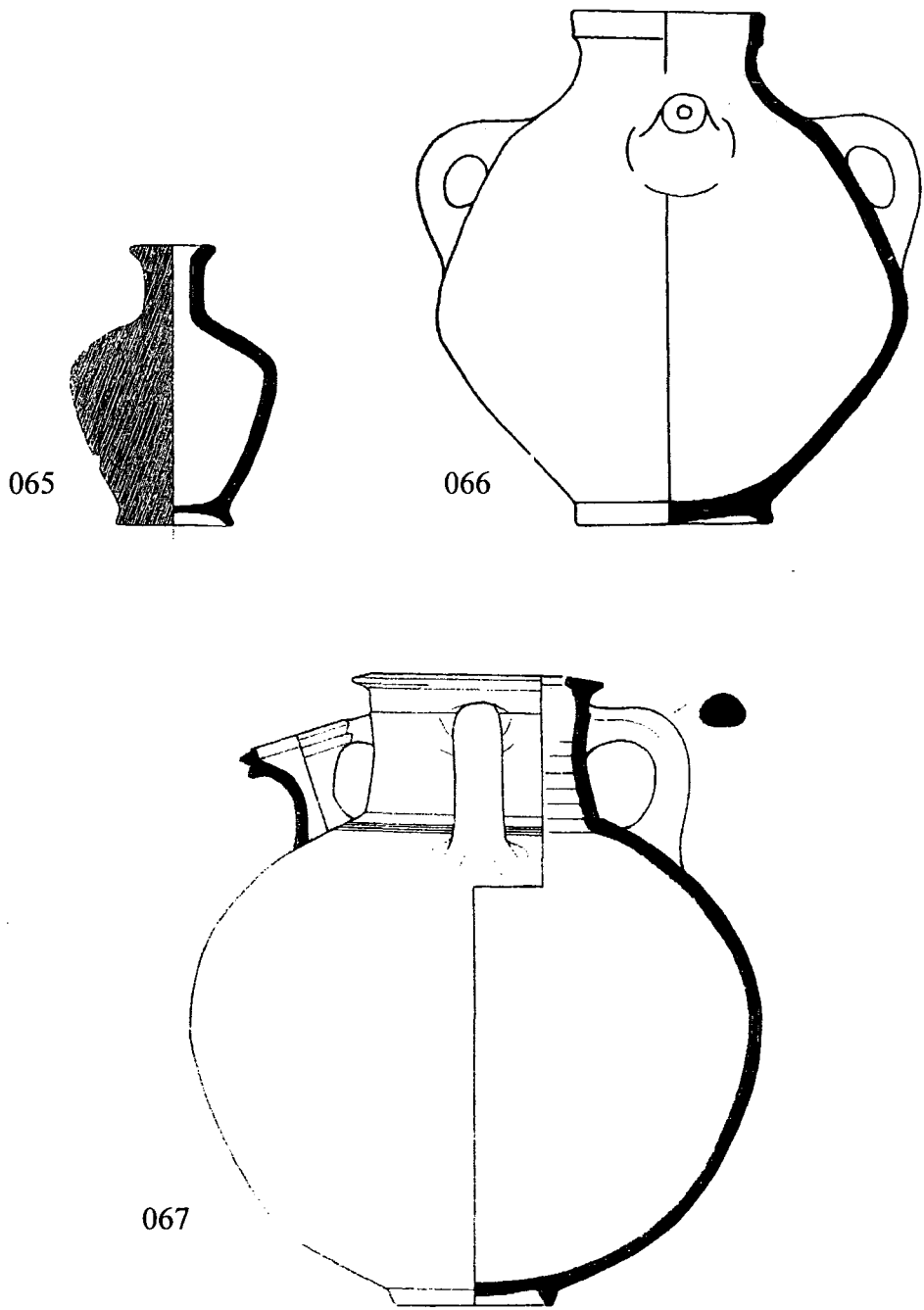


061

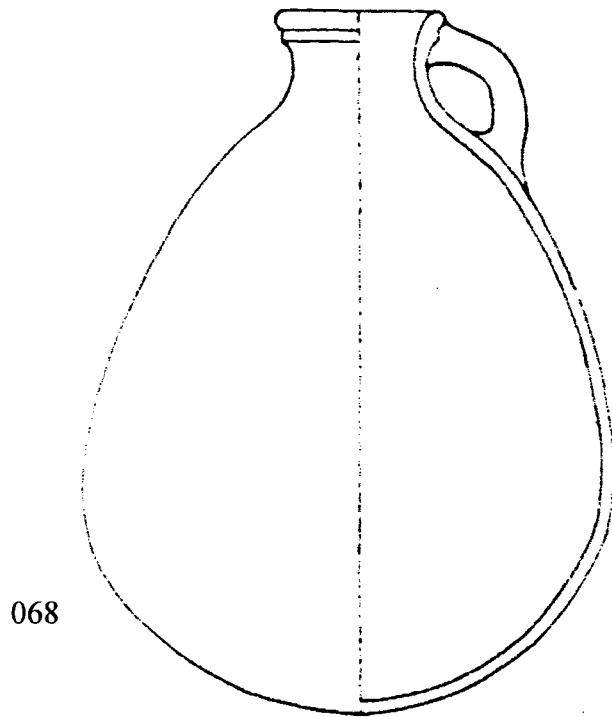
**Fig. 28** Urn (Storage Amphora) CLASSES Used in This Study



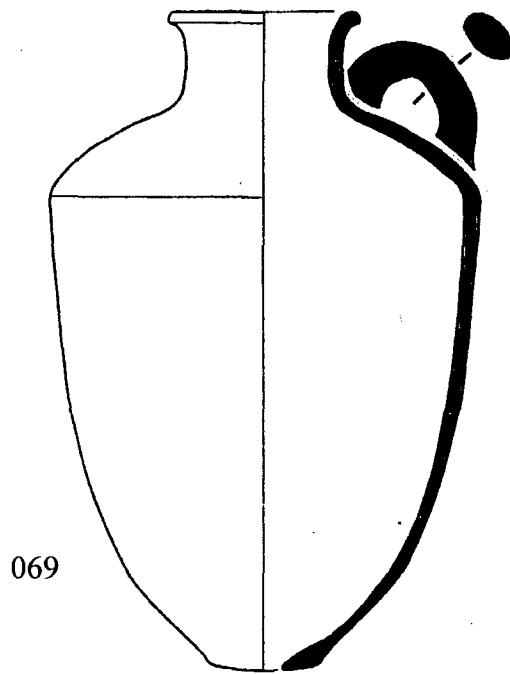
**Fig. 29** Urn (Storage Amphora) CLASSES Used in This Study



**Fig. 30 Urn (Storage Amphora) CLASSES Used in This Study**

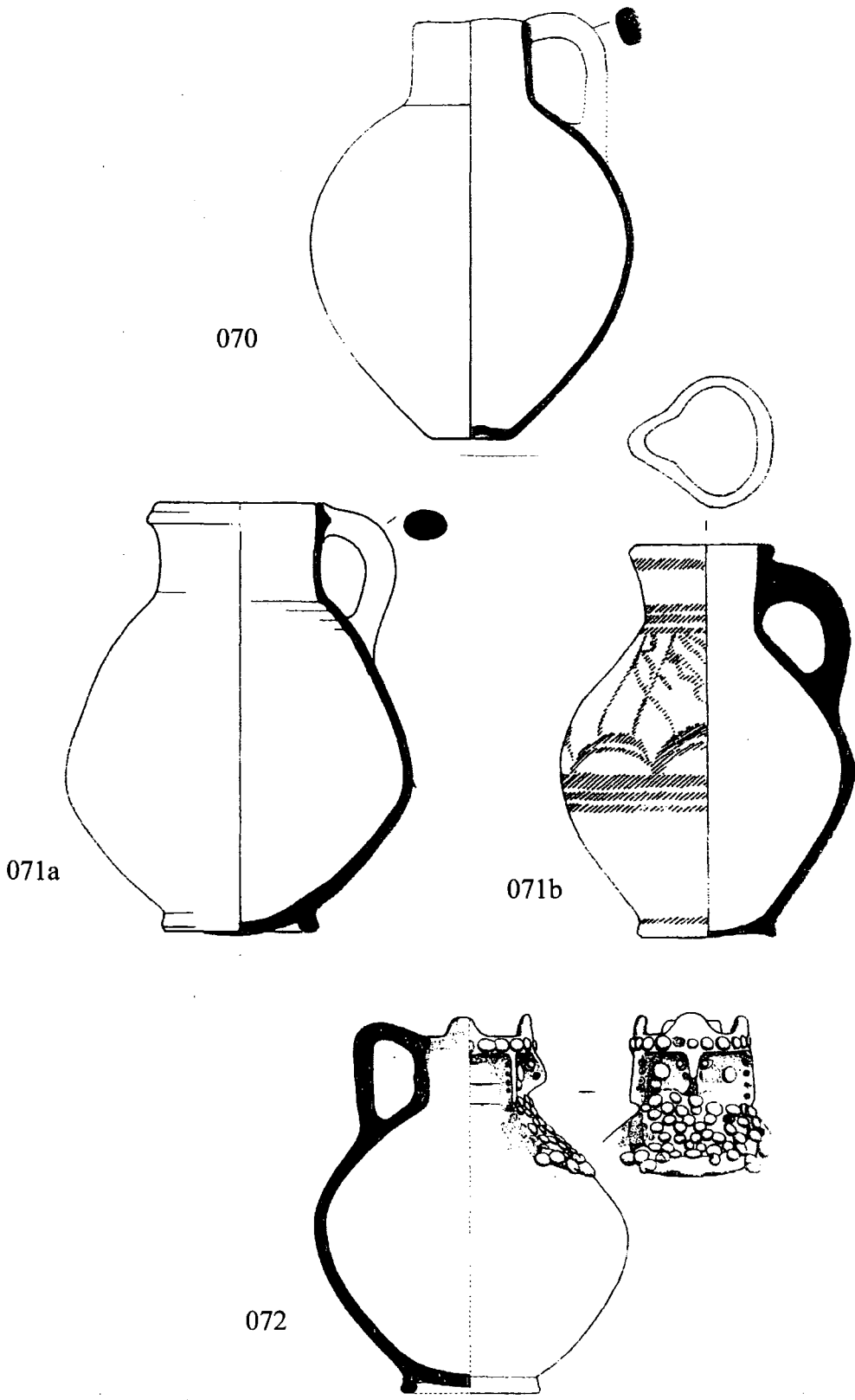


068



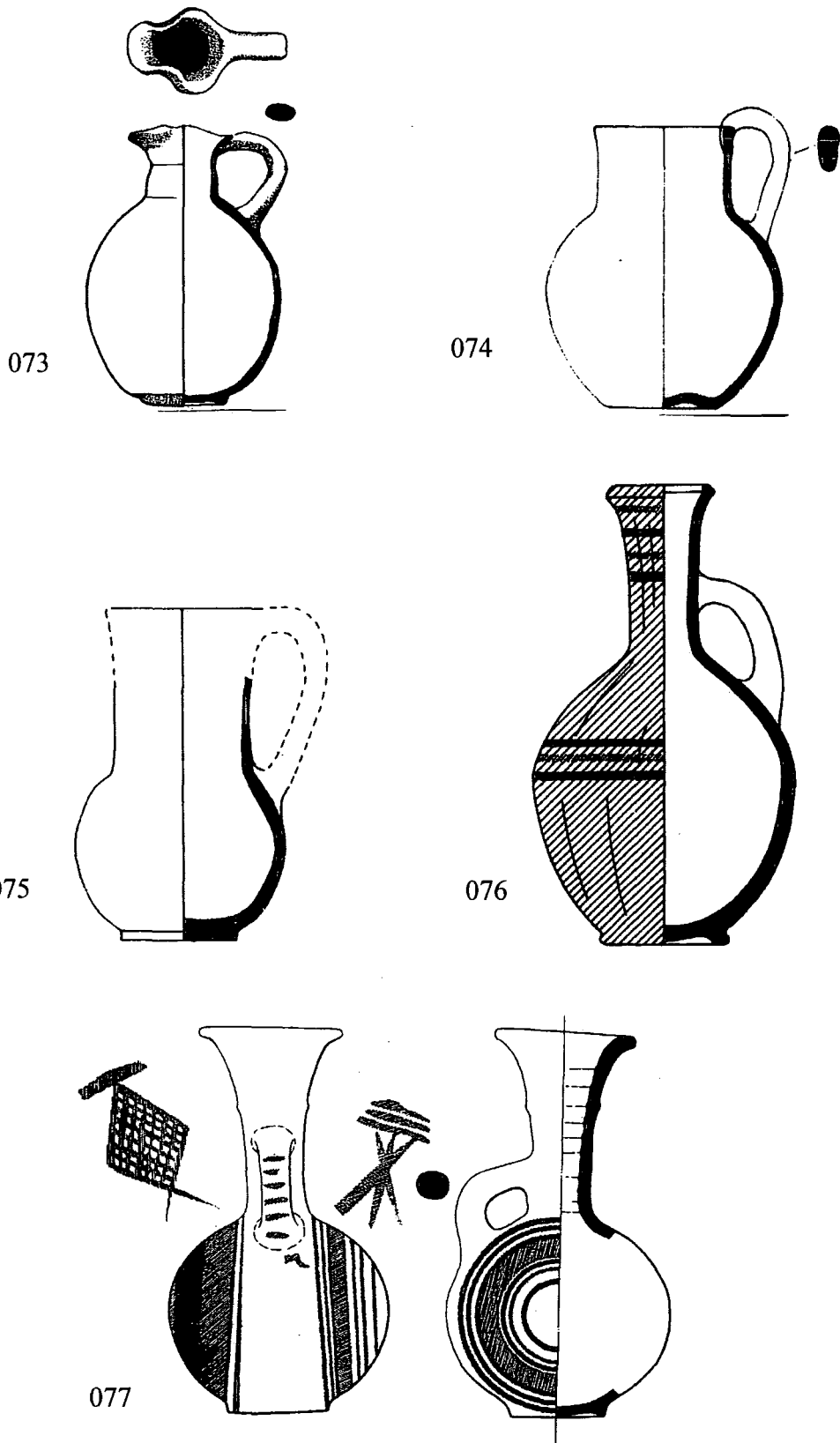
069

**Fig. 31 Jug CLASSES Used in This Study**

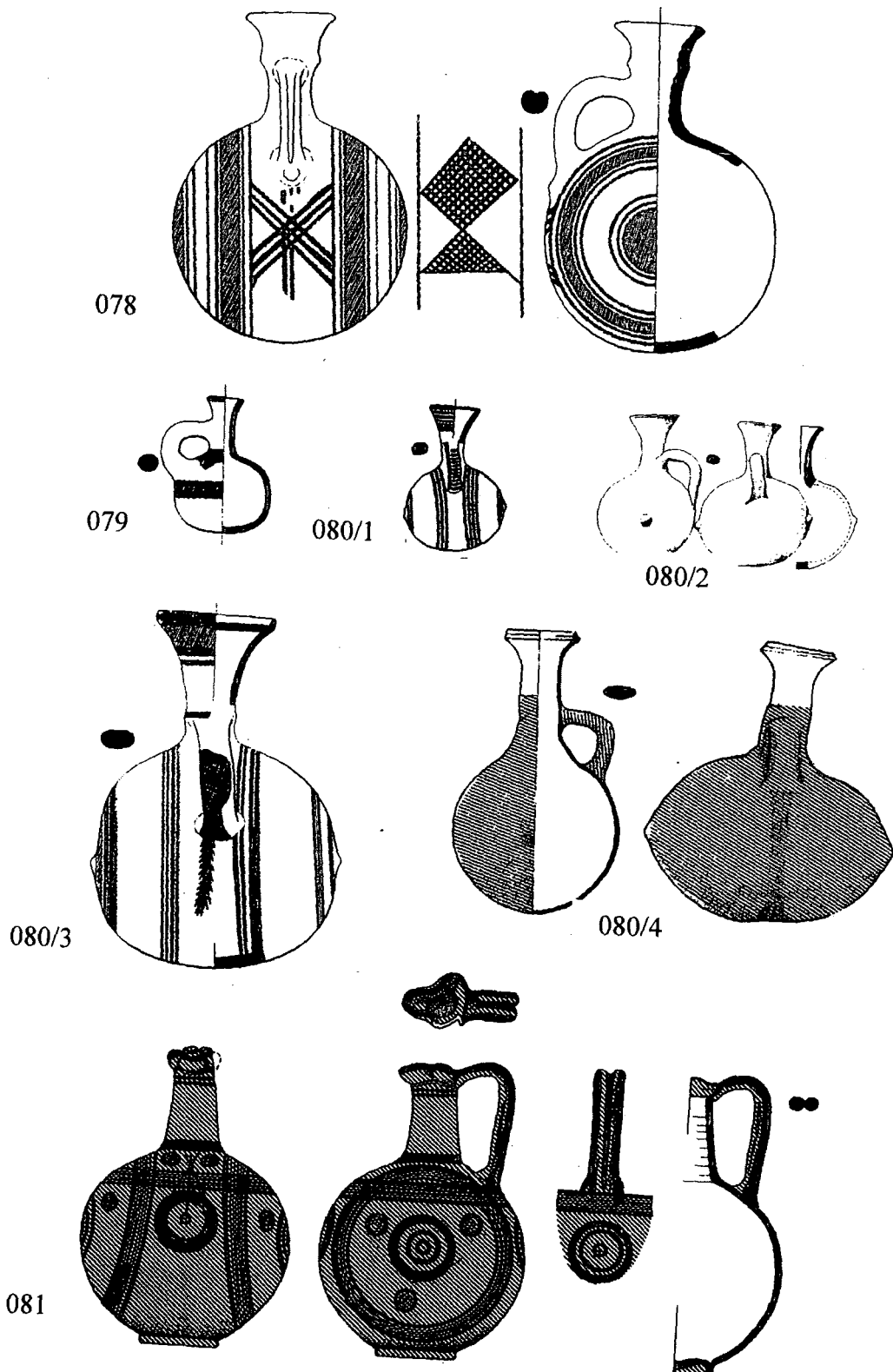


**Fig. 32 Jug CLASSES Used in This Study**

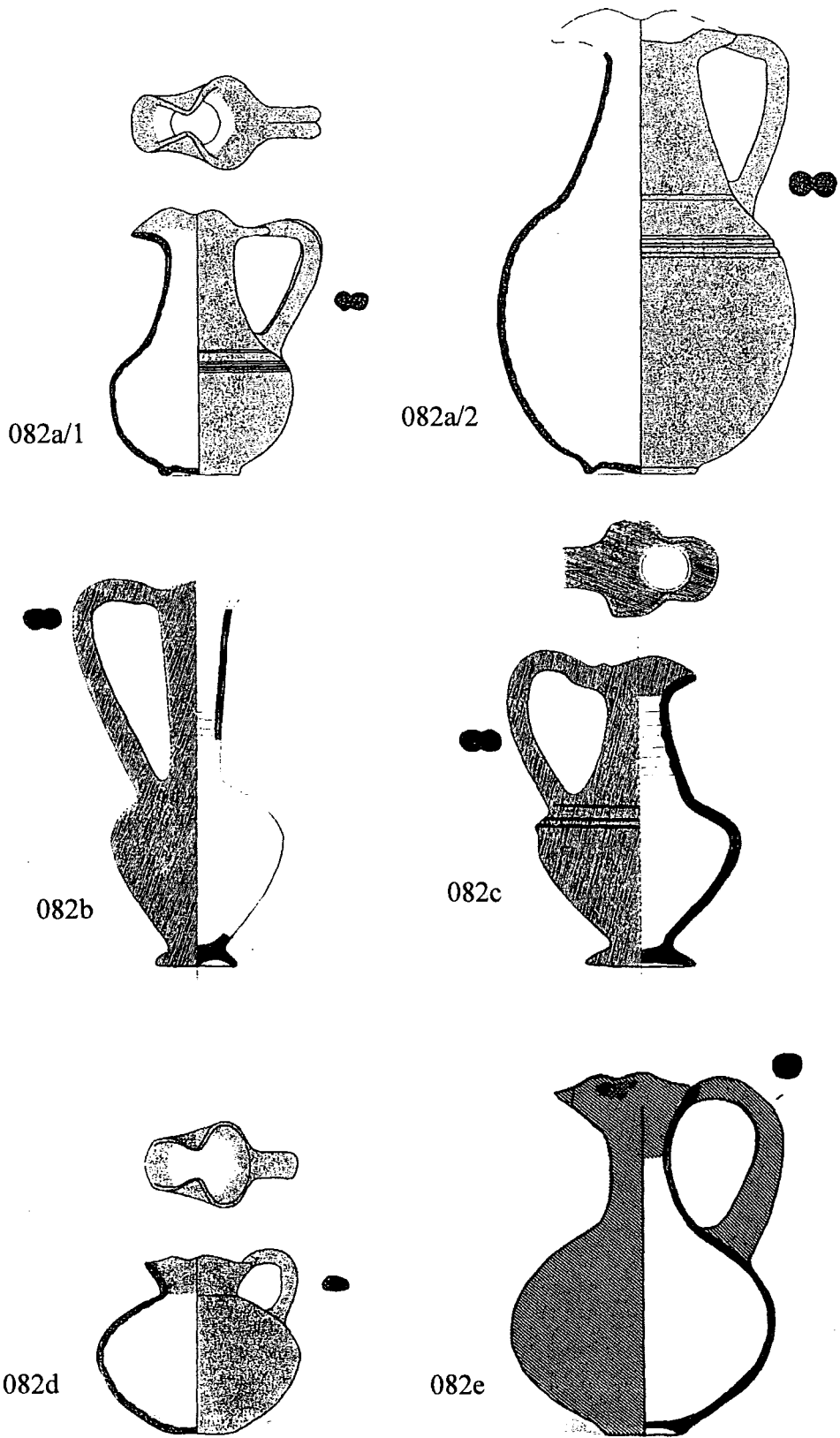




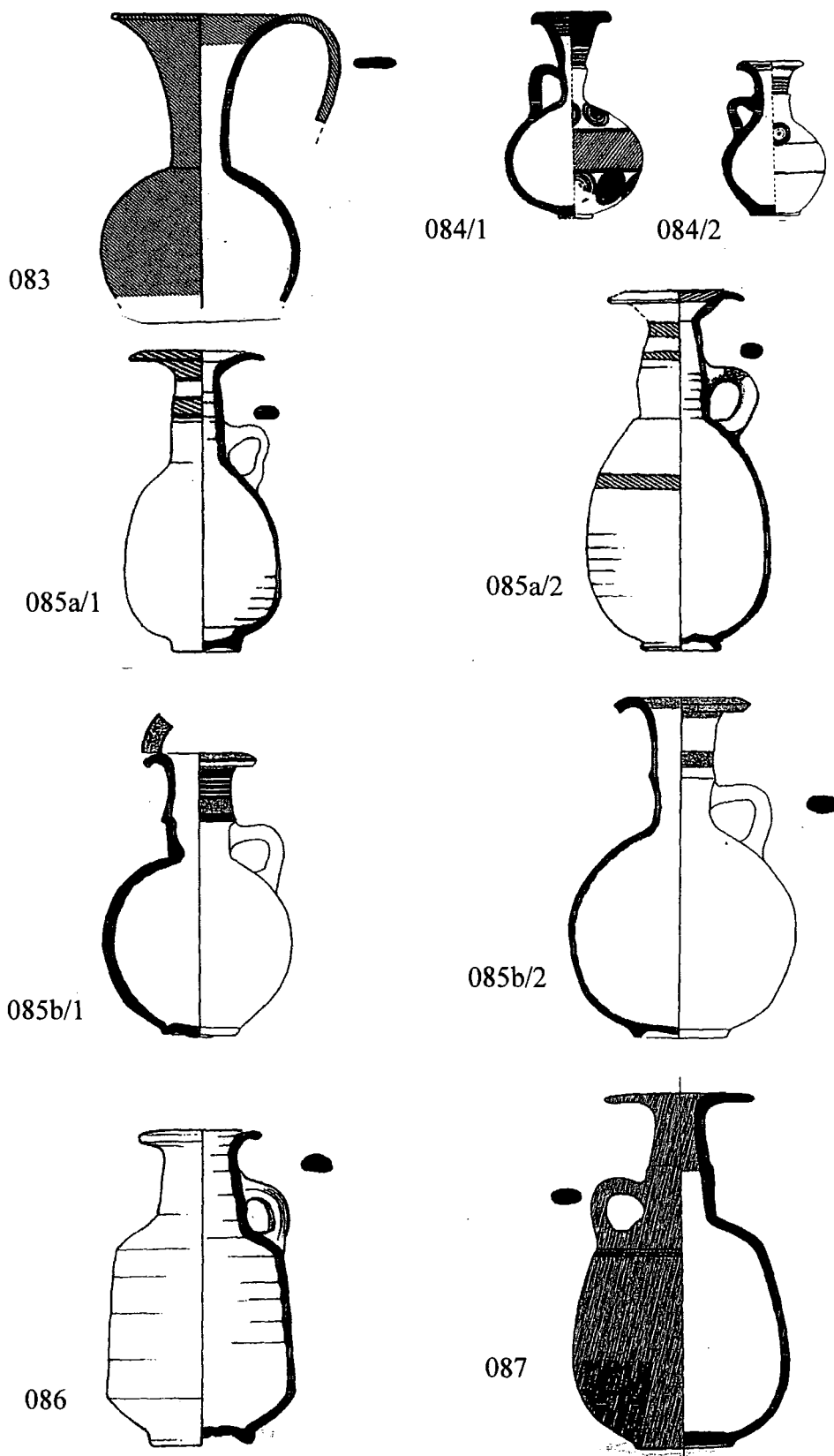
**Fig. 33 Jug CLASSES Used in This Study**



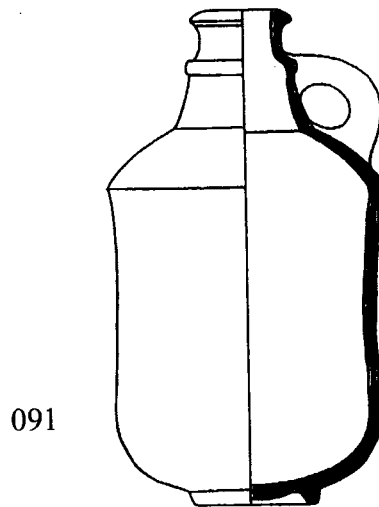
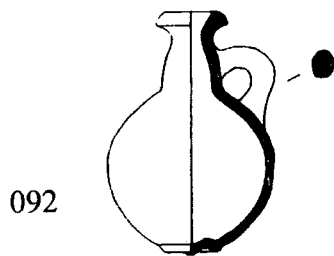
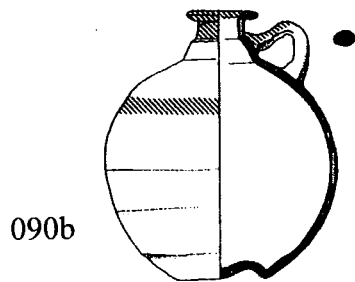
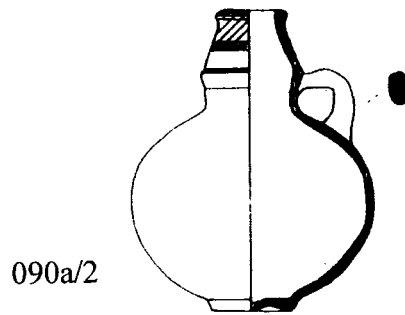
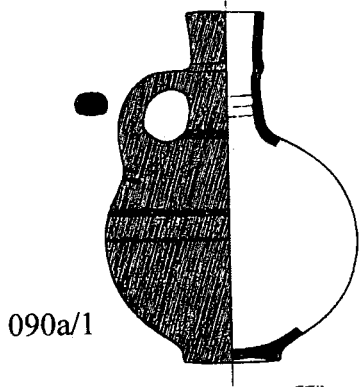
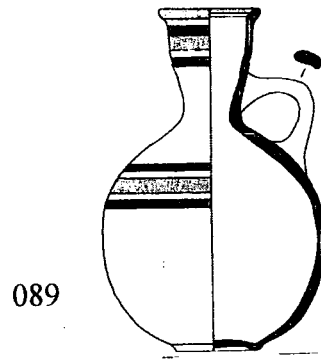
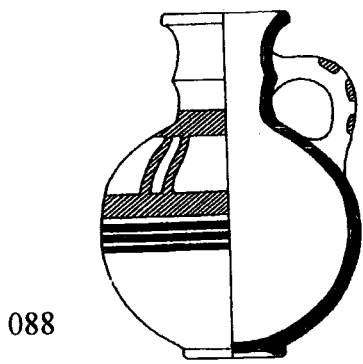
**Fig. 34 Jug CLASSES Used in This Study**



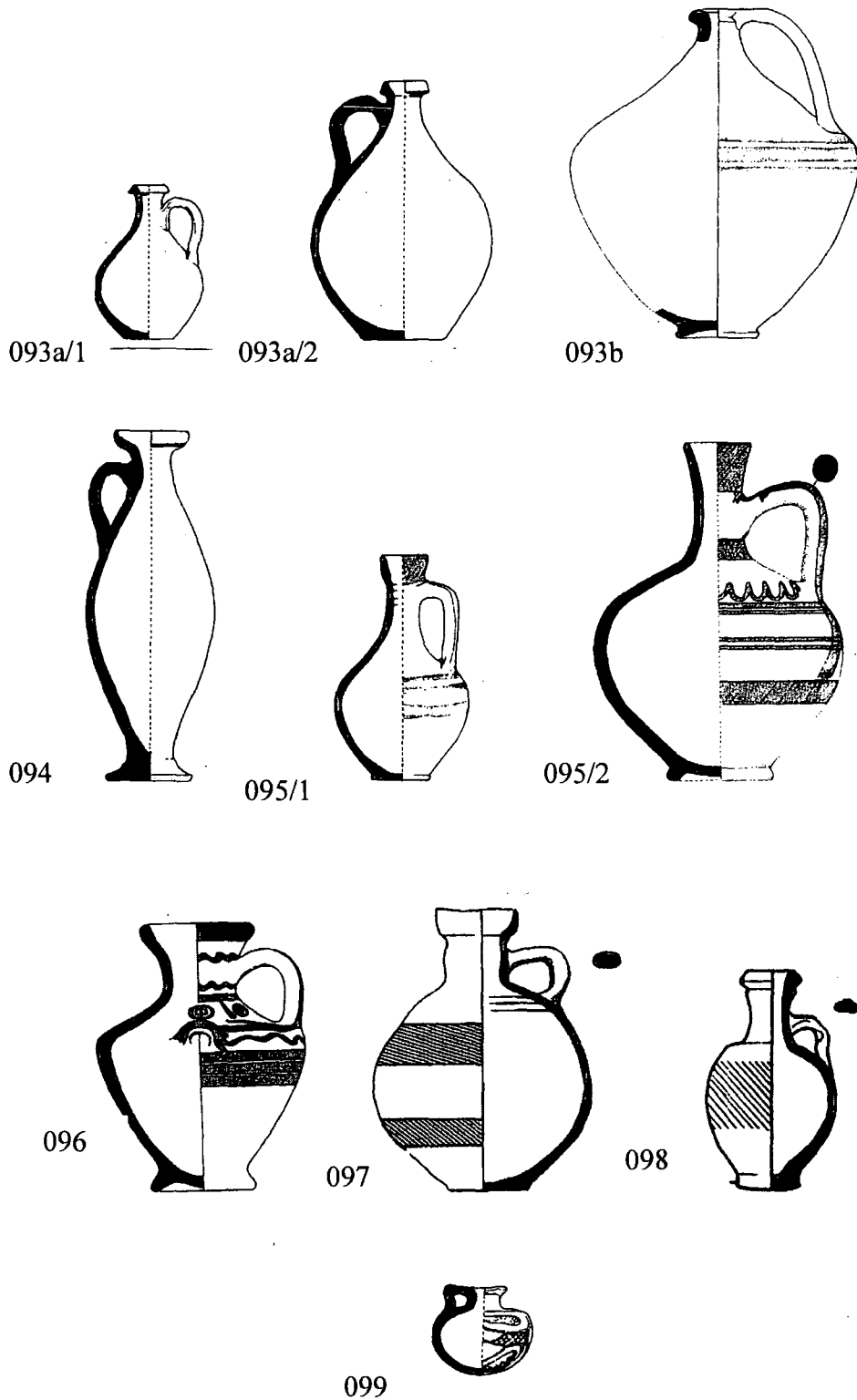
**Fig. 35 Jug CLASSES Used in This Study**



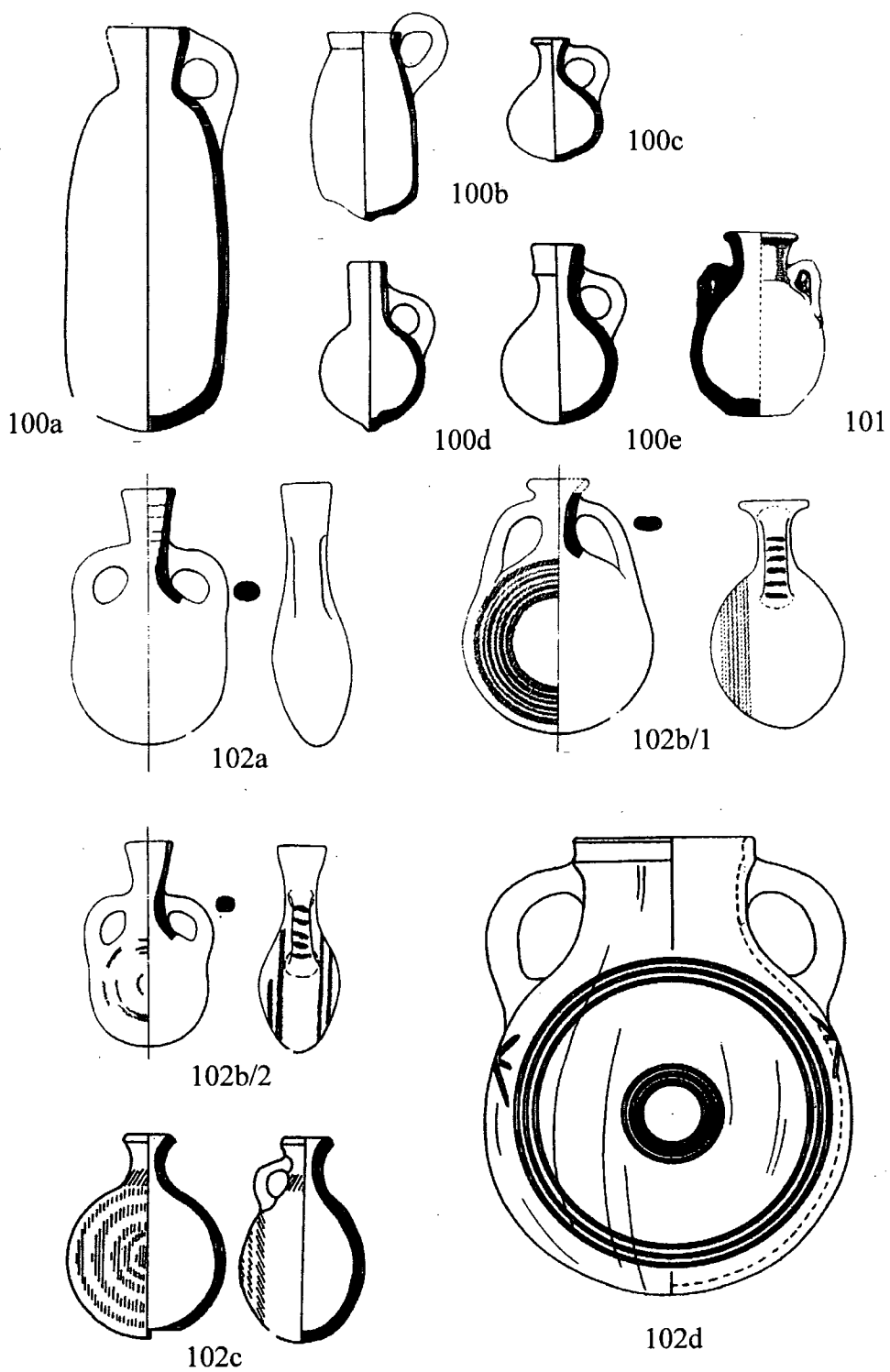
**Fig. 36 Jug CLASSES Used in This Study**



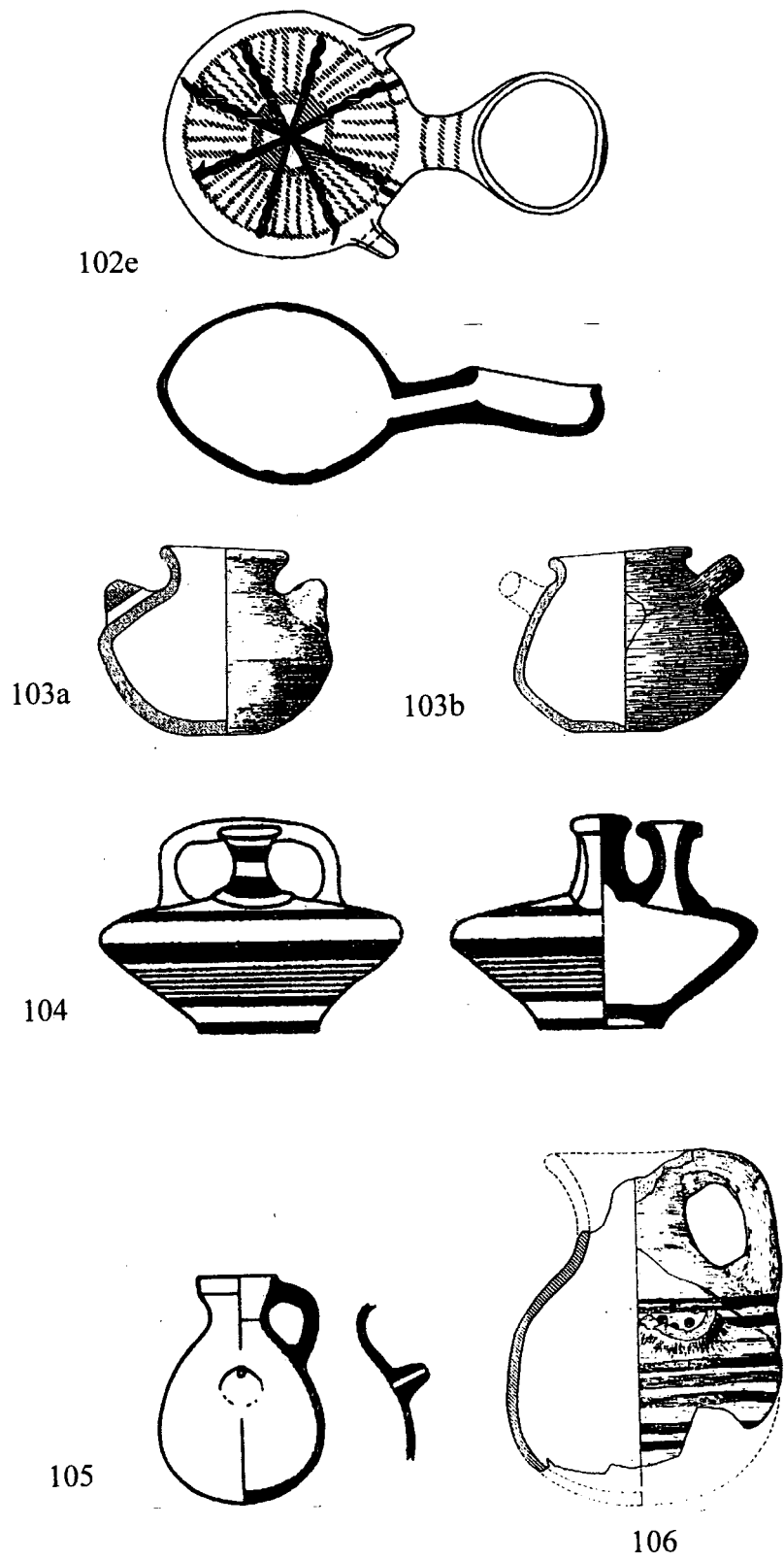
**Fig. 37 Jug CLASSES Used in This Study**



**Fig. 38 Jug CLASSES Used in This Study**

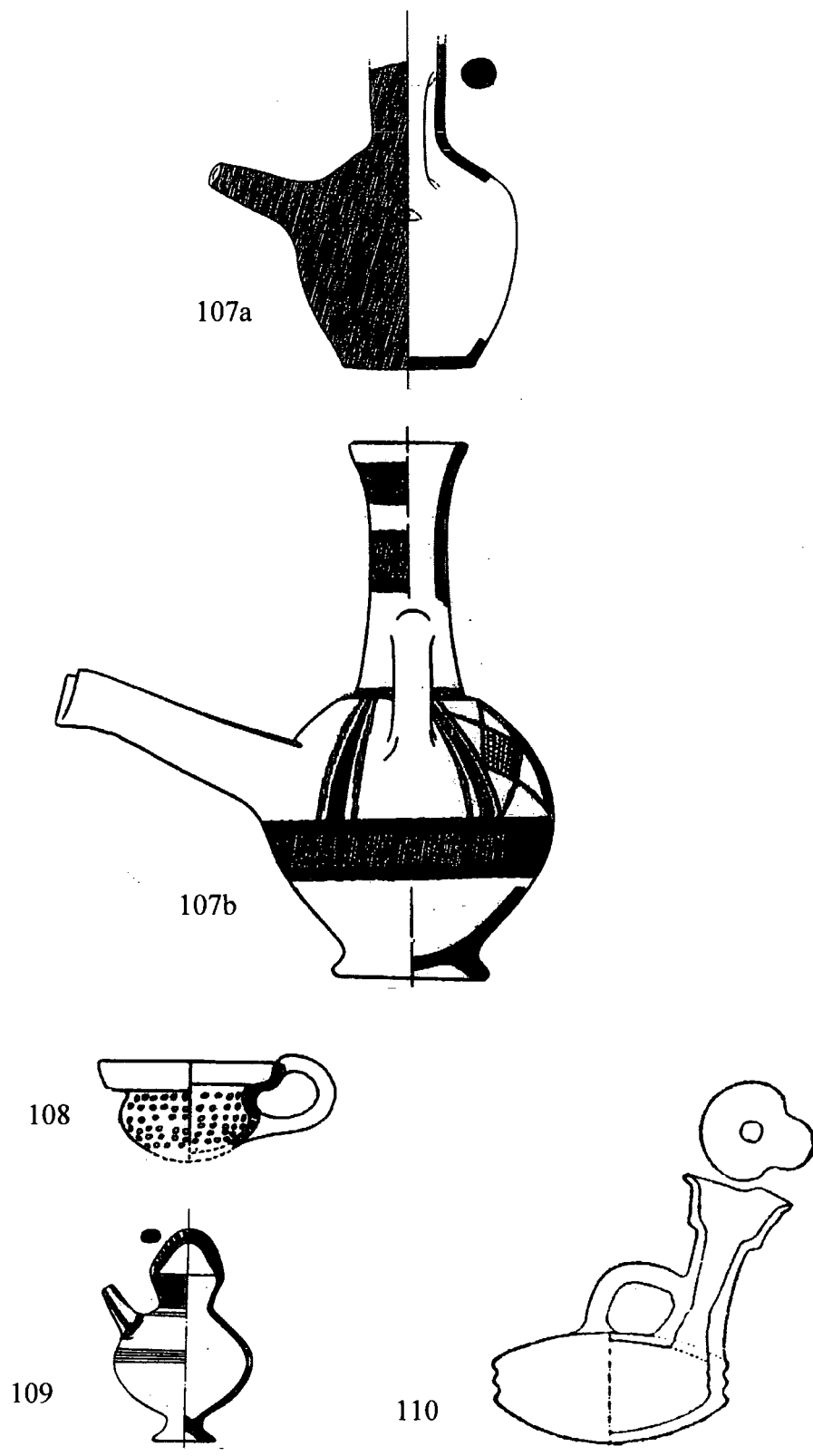


**Fig. 39 Juglet and Flask CLASSES Used in This Study**

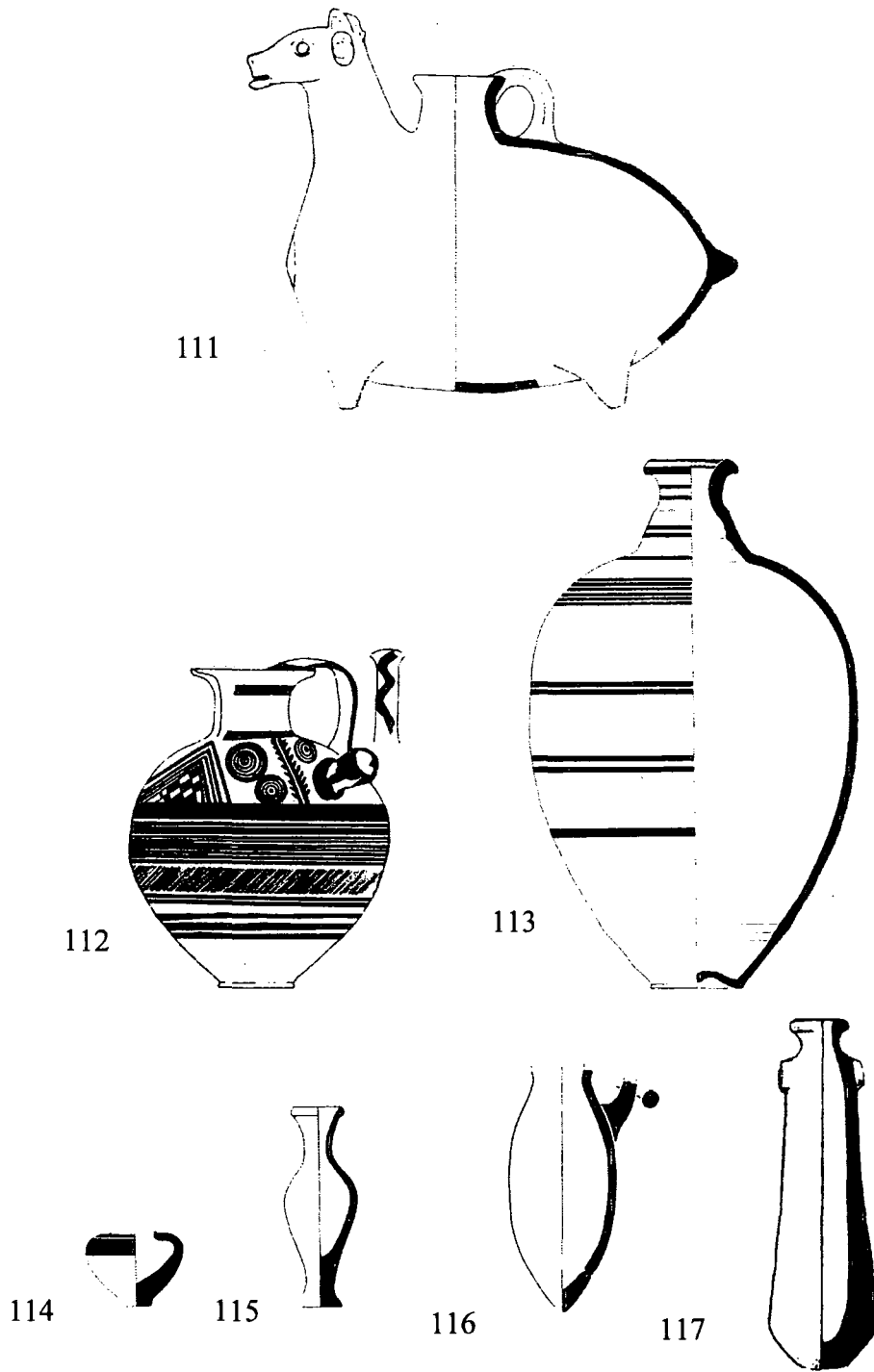


**Fig. 40 Spouted Vessel CLASSES Used in This Study**

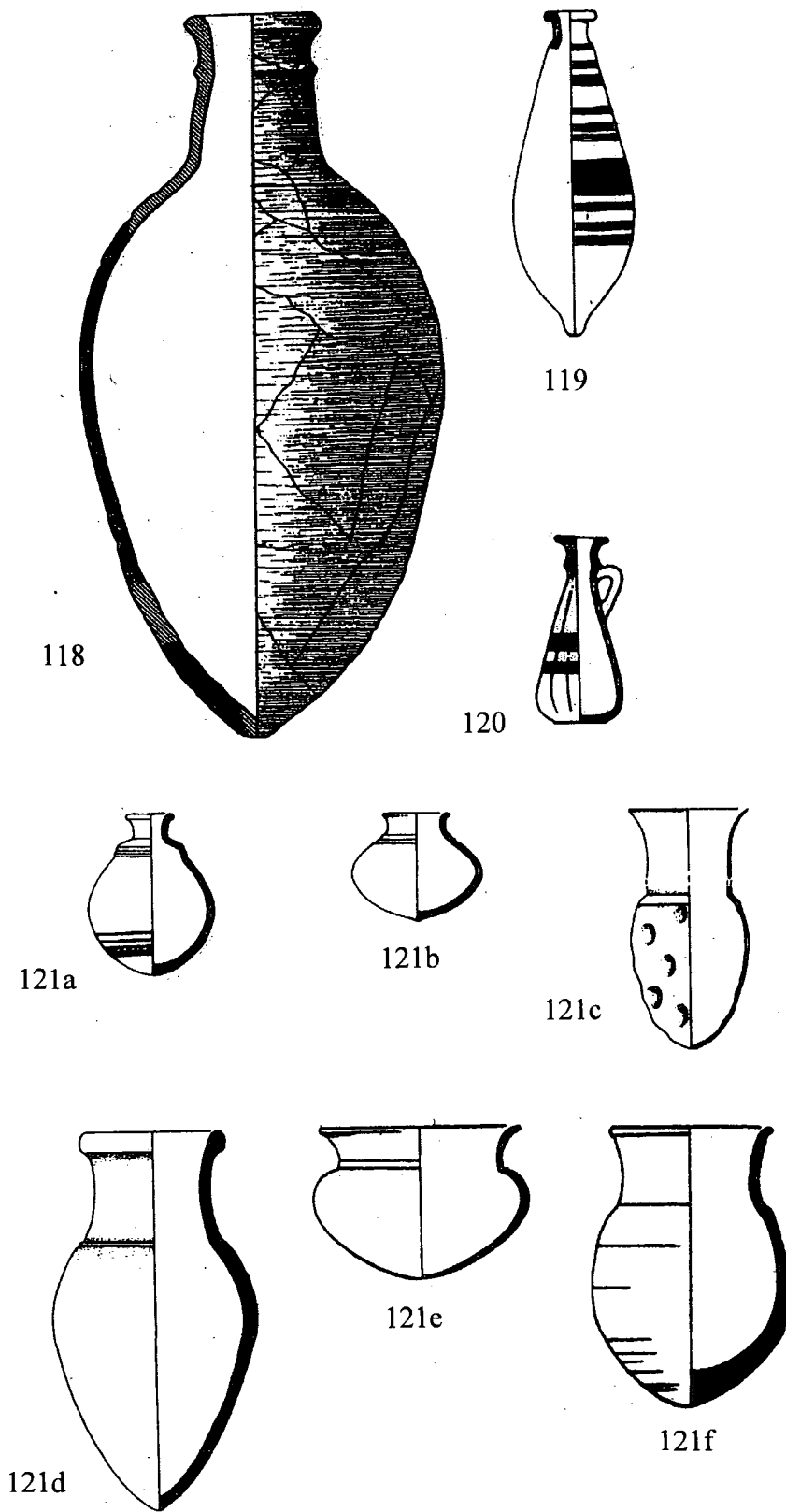




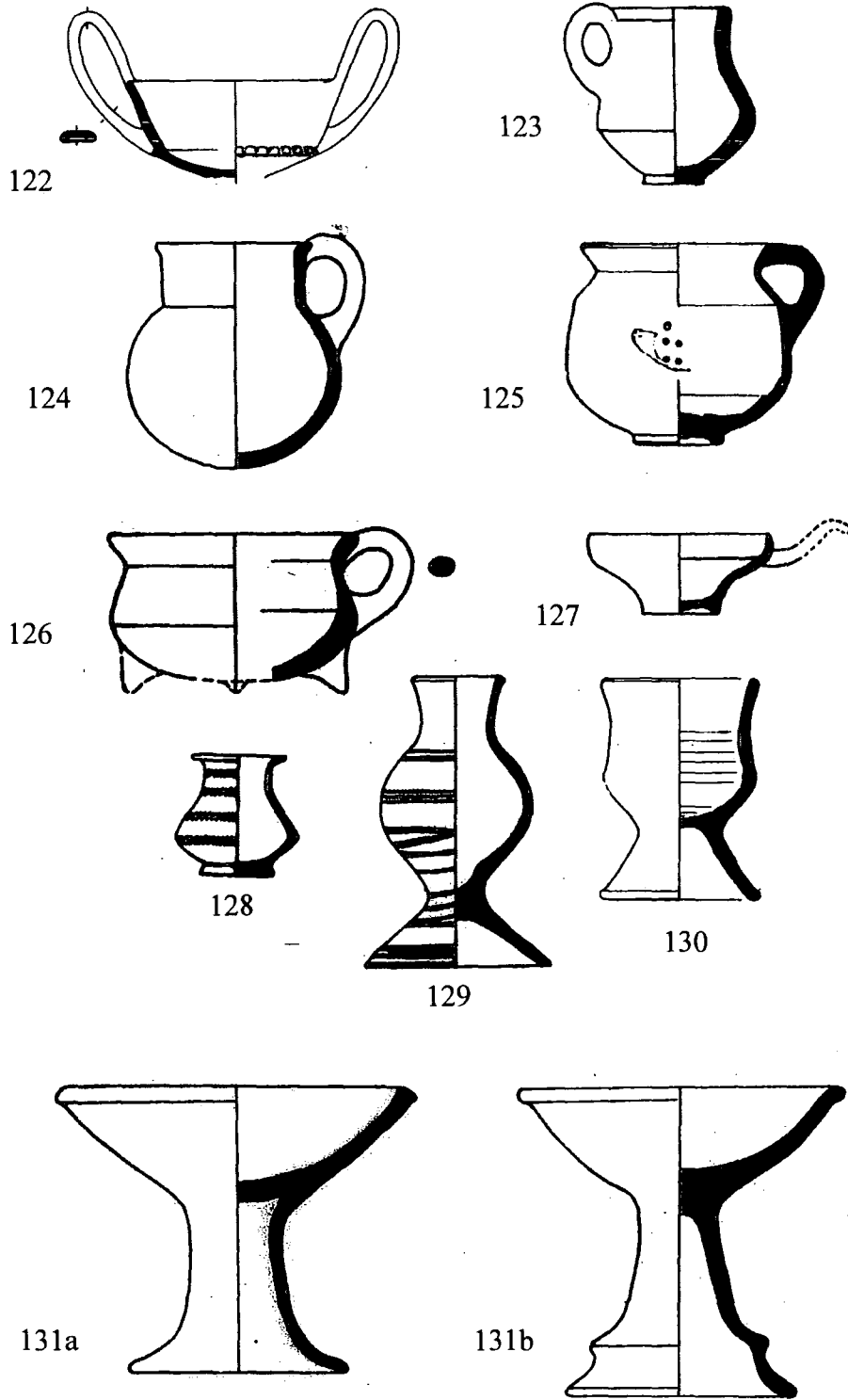
**Fig. 41 Spouted Vessel CLASSES Used in This Study**



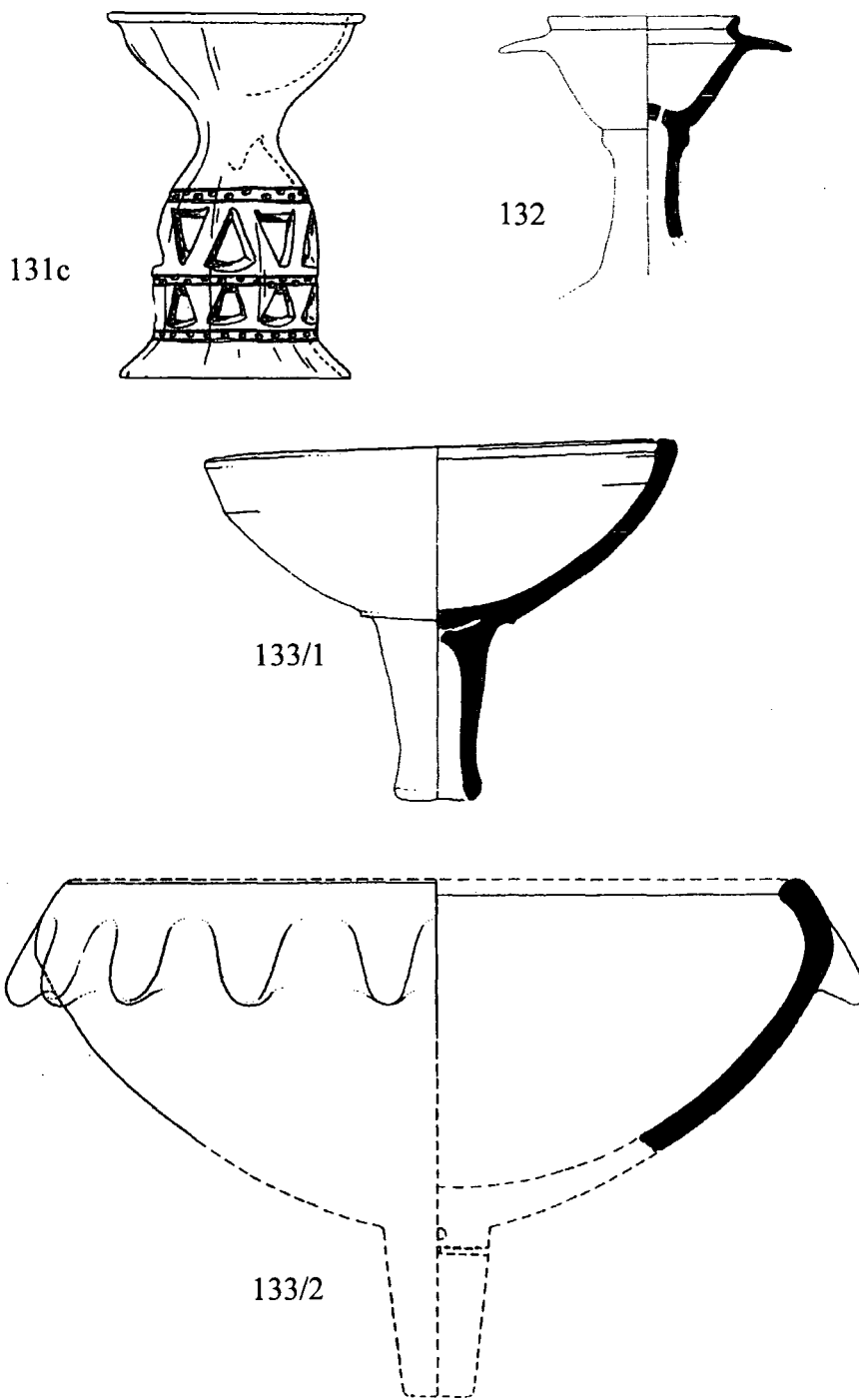
**Fig. 42 Spouted Vessel and Bottle CLASSES Used in This Study**



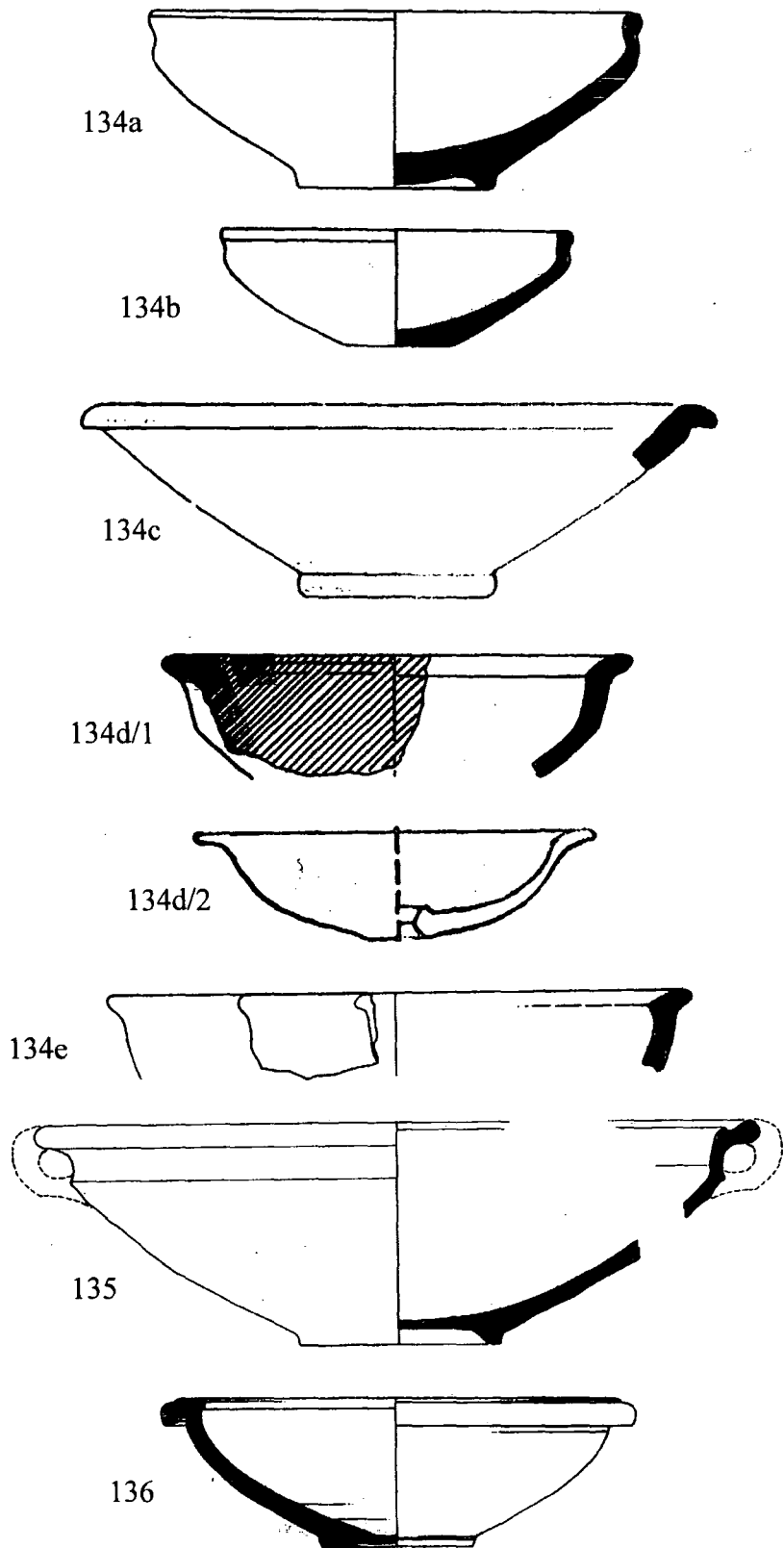
**Fig. 43 Bottle CLASSES Used in This Study**



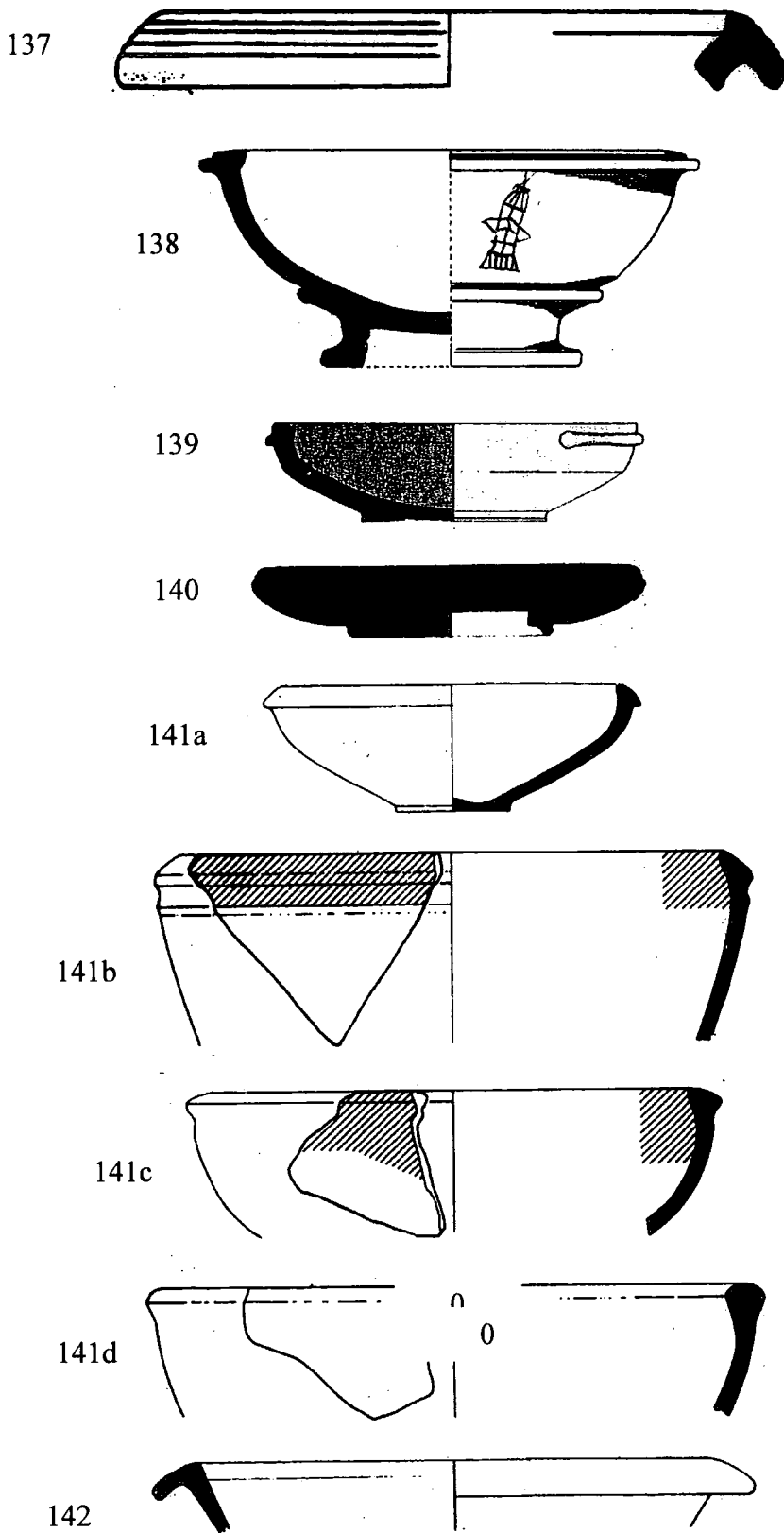
**Fig. 44 Cup and Chalice CLASSES Used in This Study**



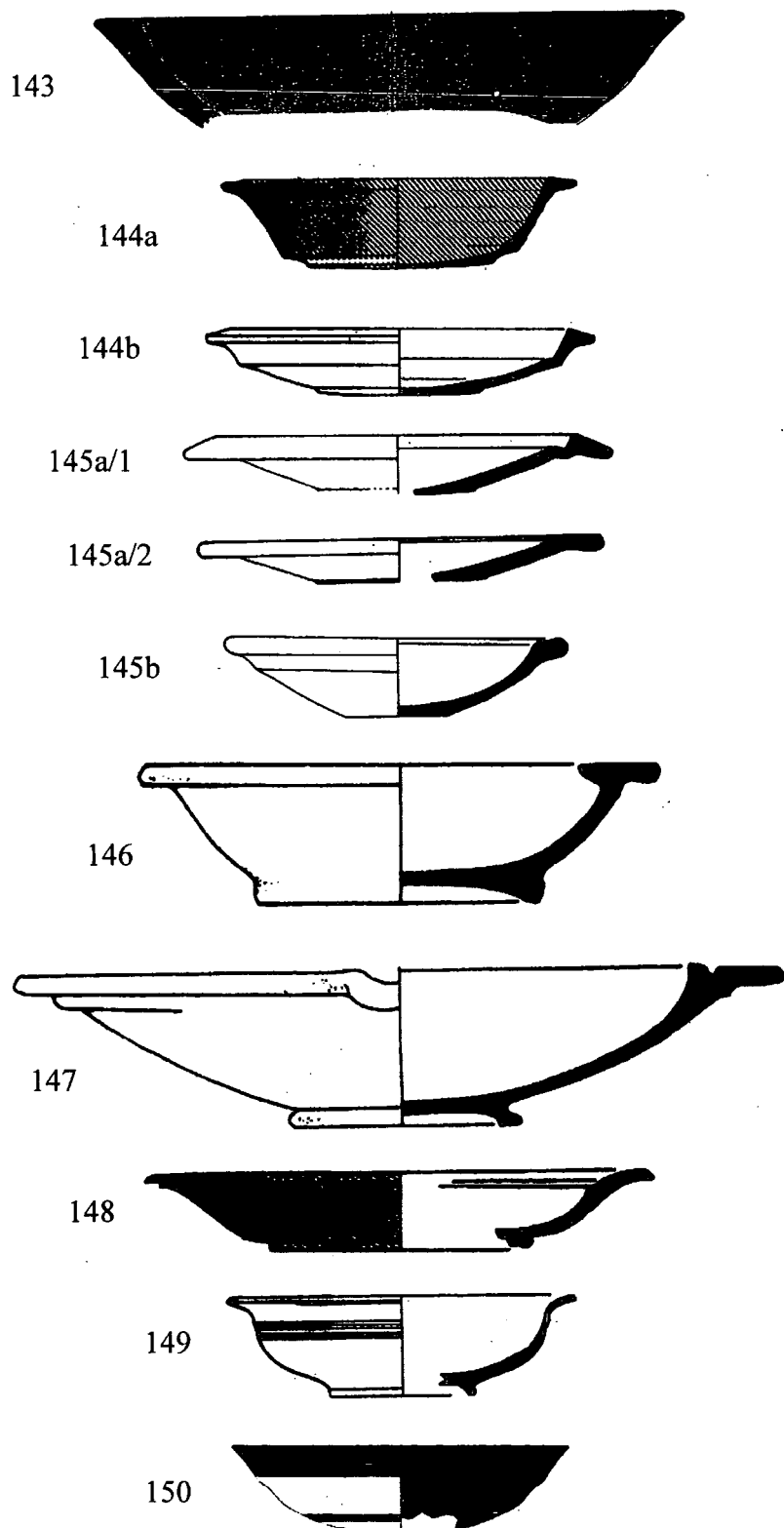
**Fig. 45 Chalice CLASSES Used in This Study**



**Fig. 46 Bowl CLASSES Used in This Study**

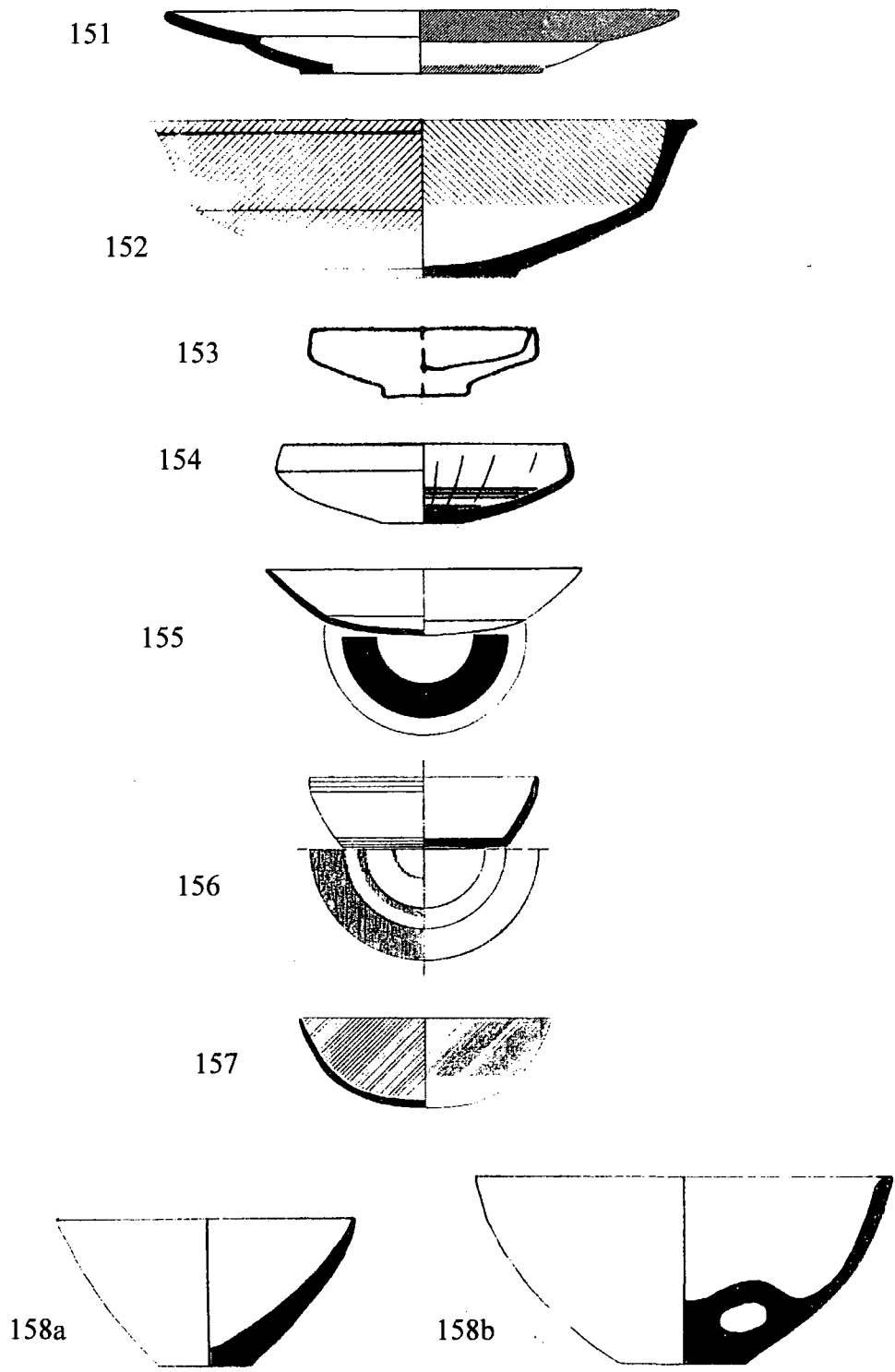


**Fig. 47 Bowl CLASSES Used in This Study**

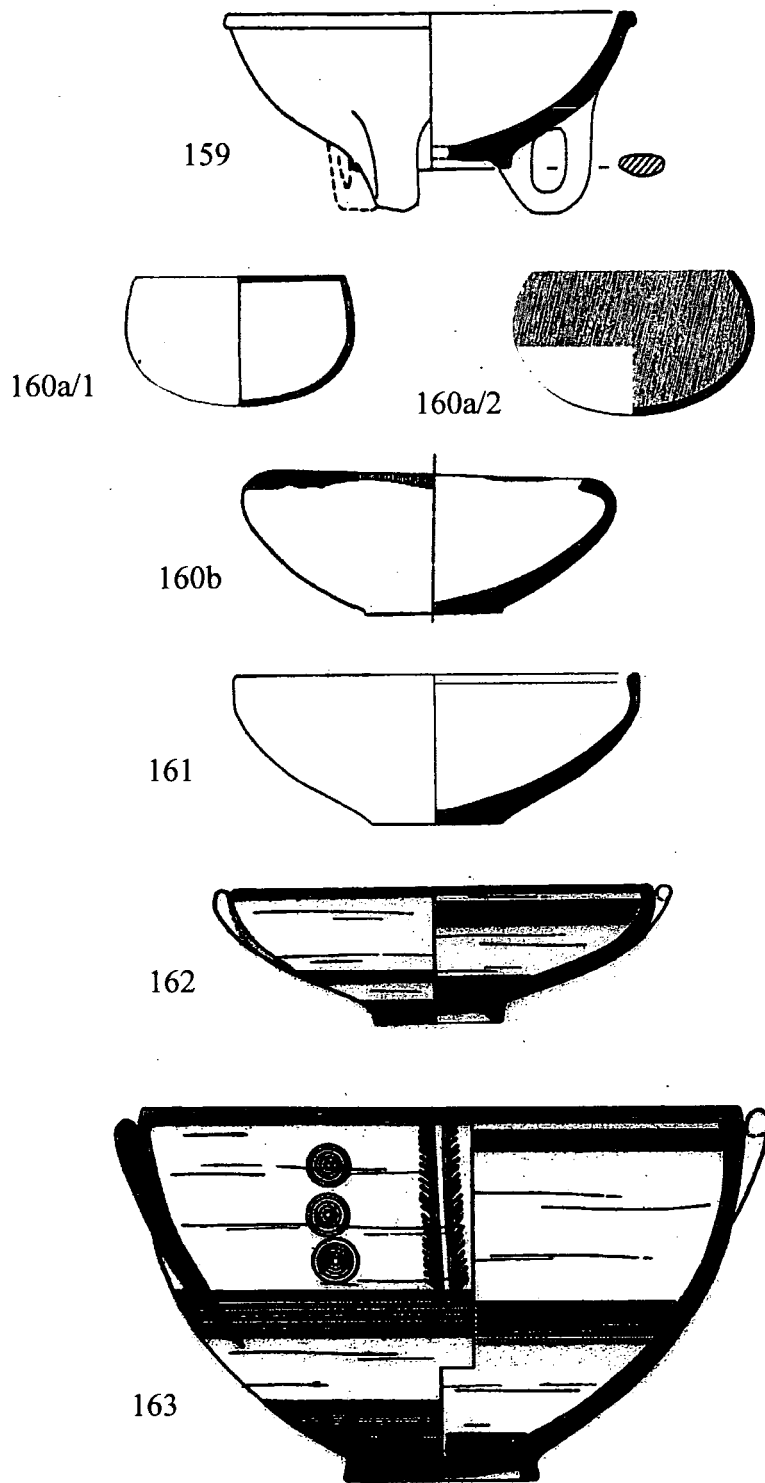


**Fig. 48 Bowl CLASSES Used in This Study**

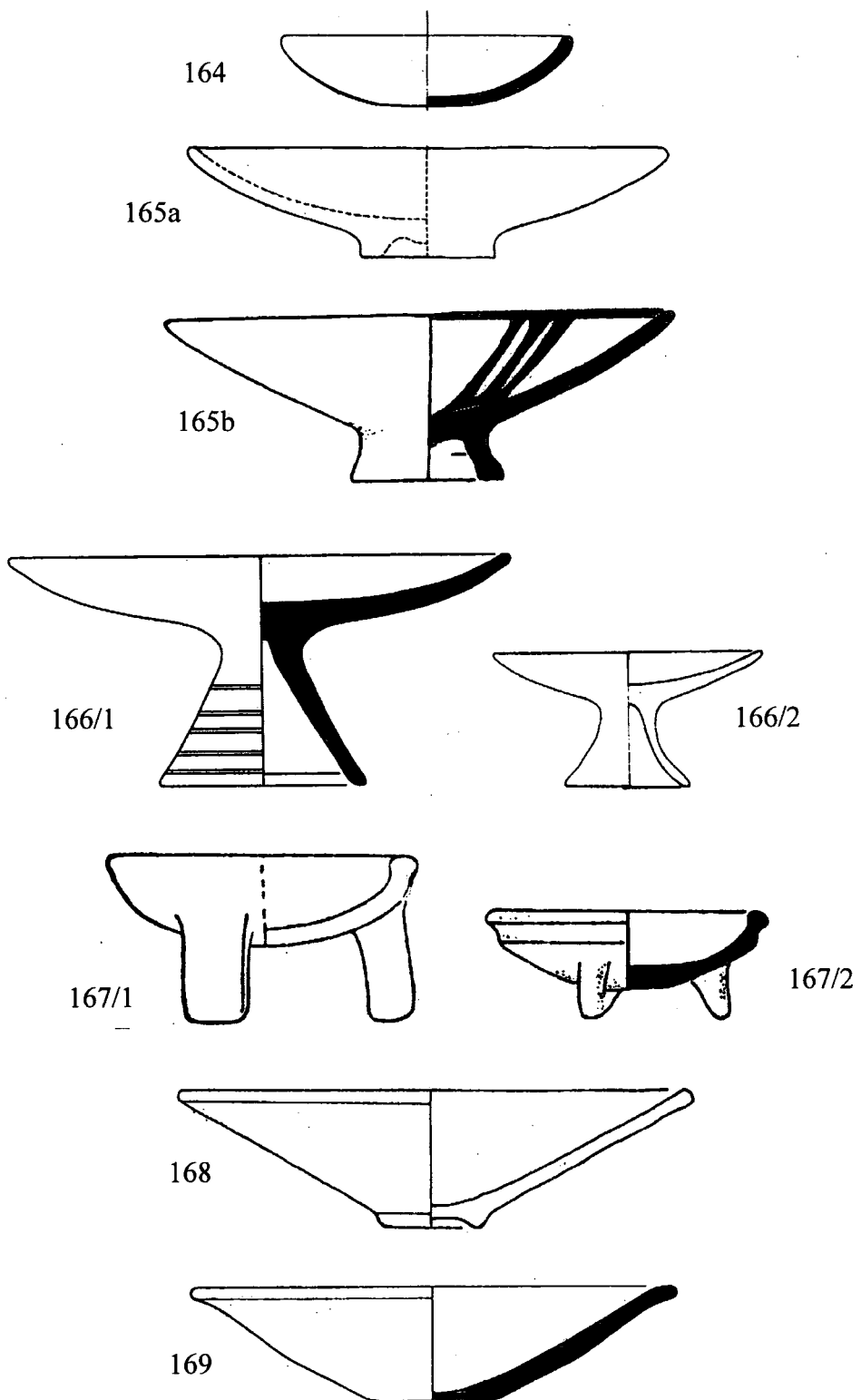




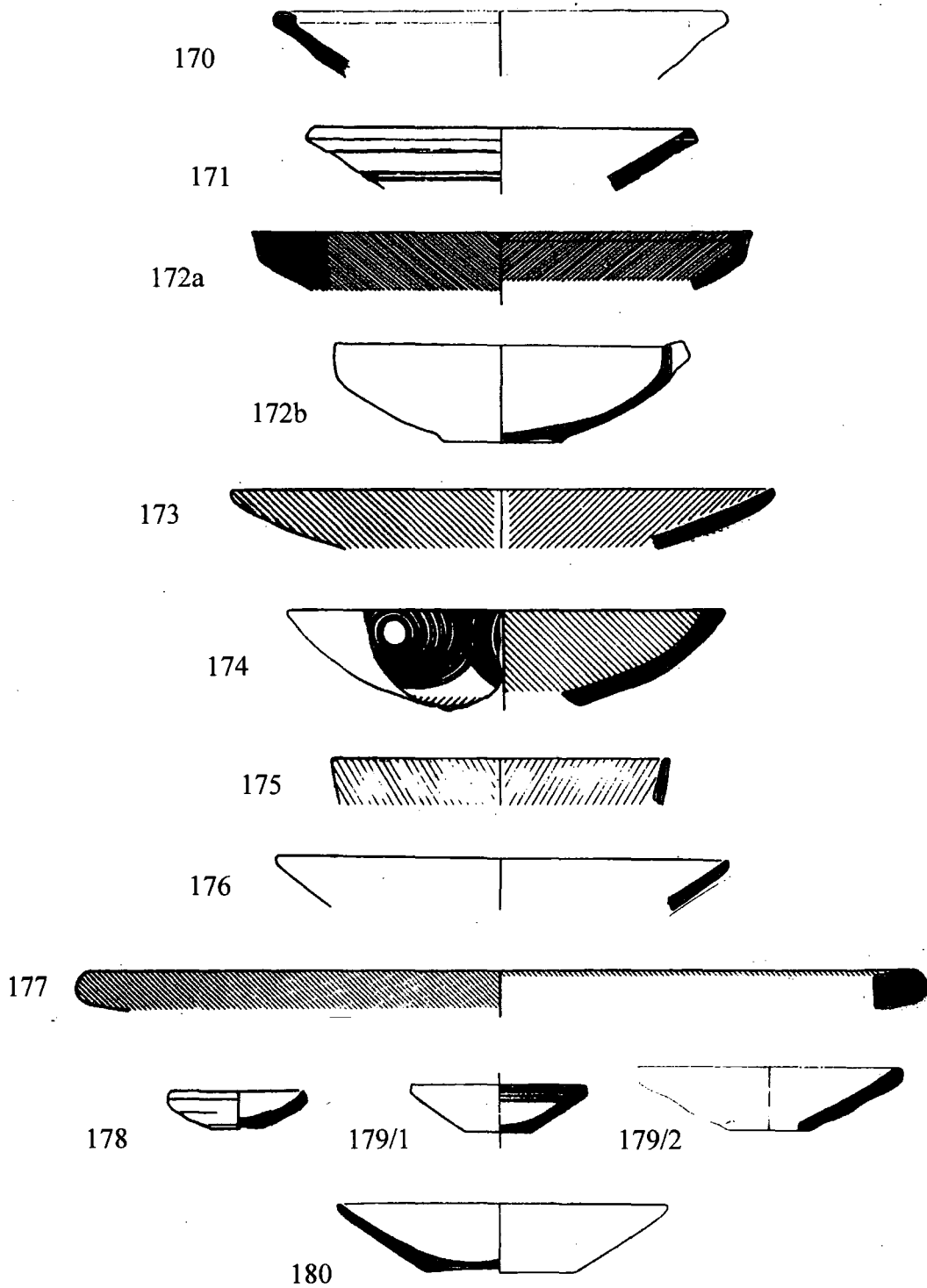
**Fig. 49 Bowl CLASSES Used in This Study**



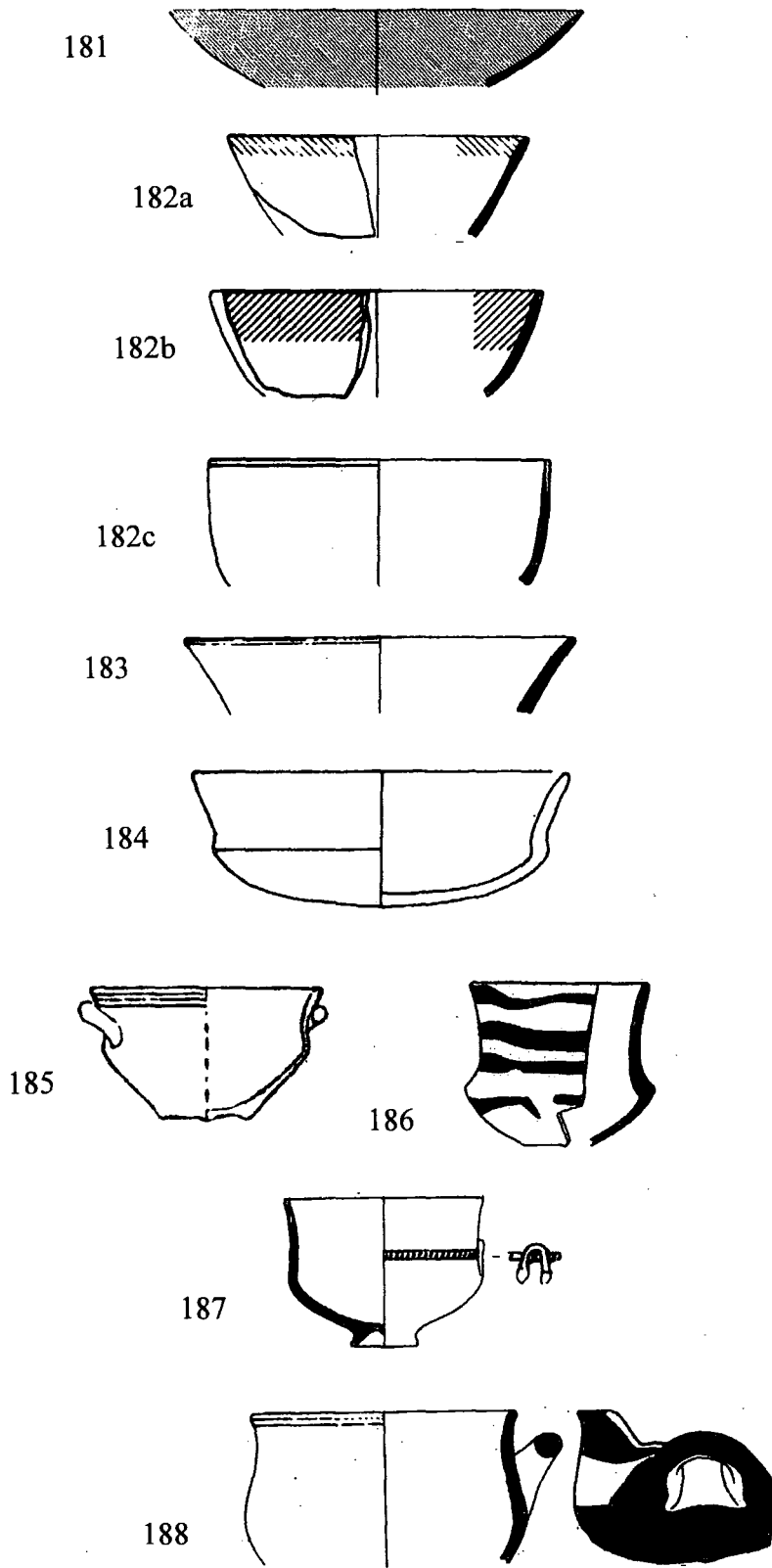
**Fig. 50 Bowl CLASSES Used in This Study**



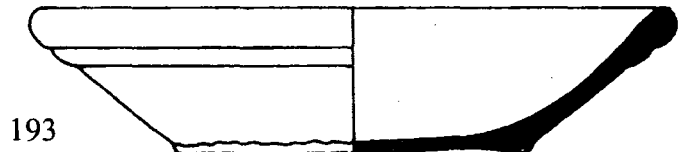
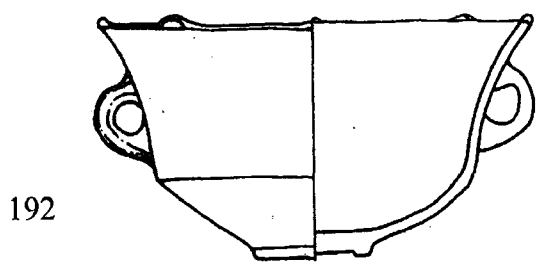
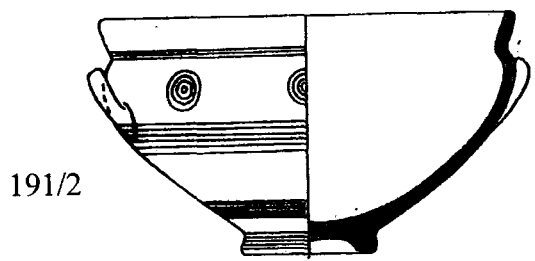
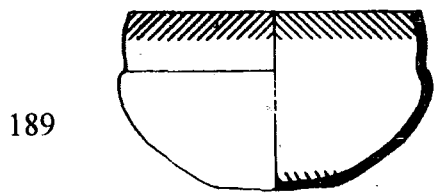
**Fig. 51 Bowl CLASSES Used in This Study**



**Fig. 52 Bowl CLASSES Used in This Study**



**Fig. 53 Bowl CLASSES Used in This Study**



**Fig. 54 Bowl CLASSES Used in This Study**



Fig. 55 Funerary Stela - Nayrab



Fig. 56 a) Funerary Stela - Zincirli; b) Transport of Pithos - Balawat Gates

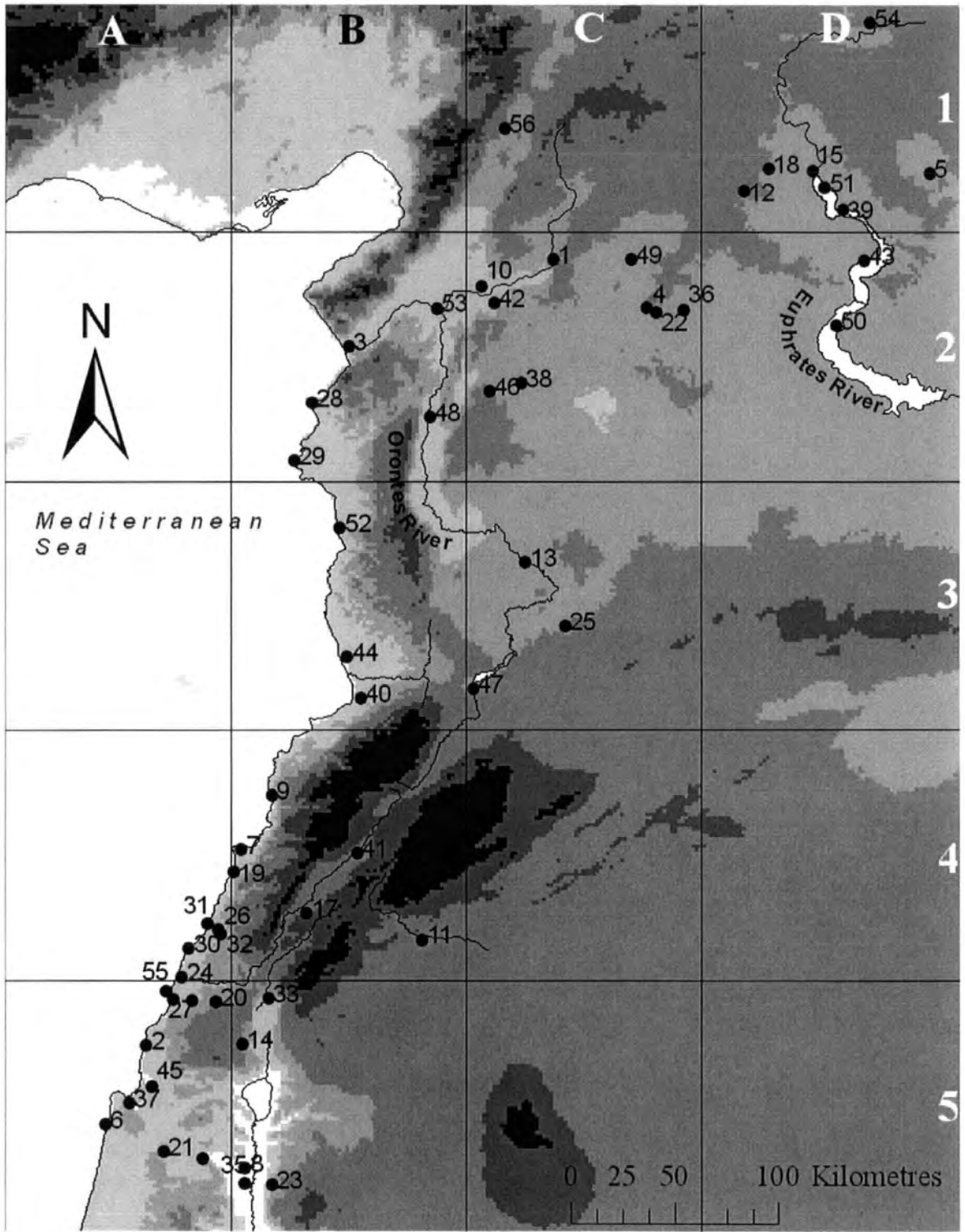


# MAPS





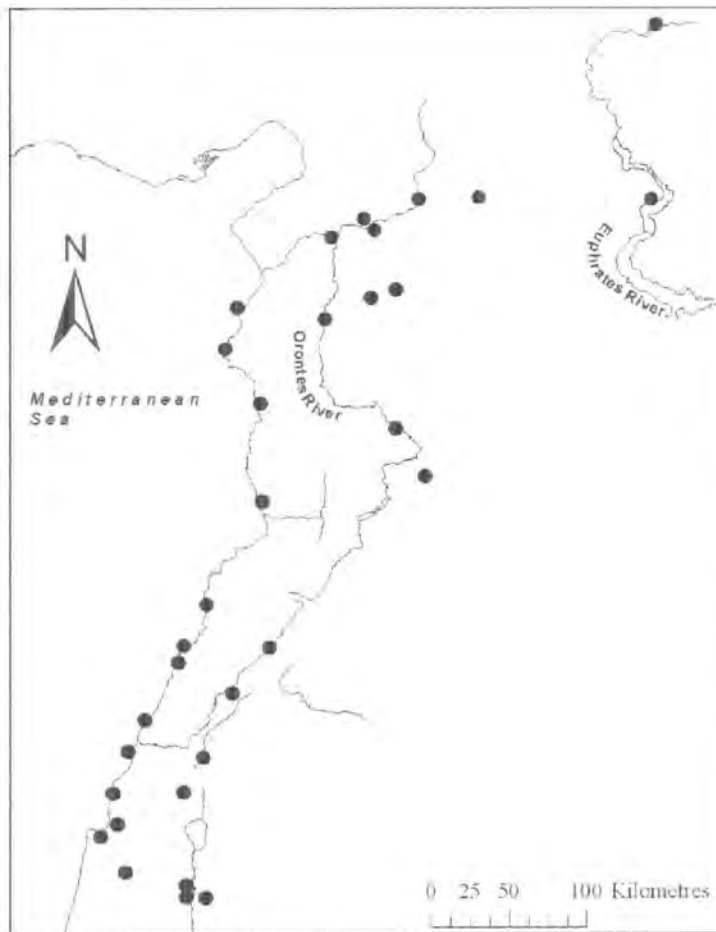
**Map 1. Northern Levant with modern national boundaries**



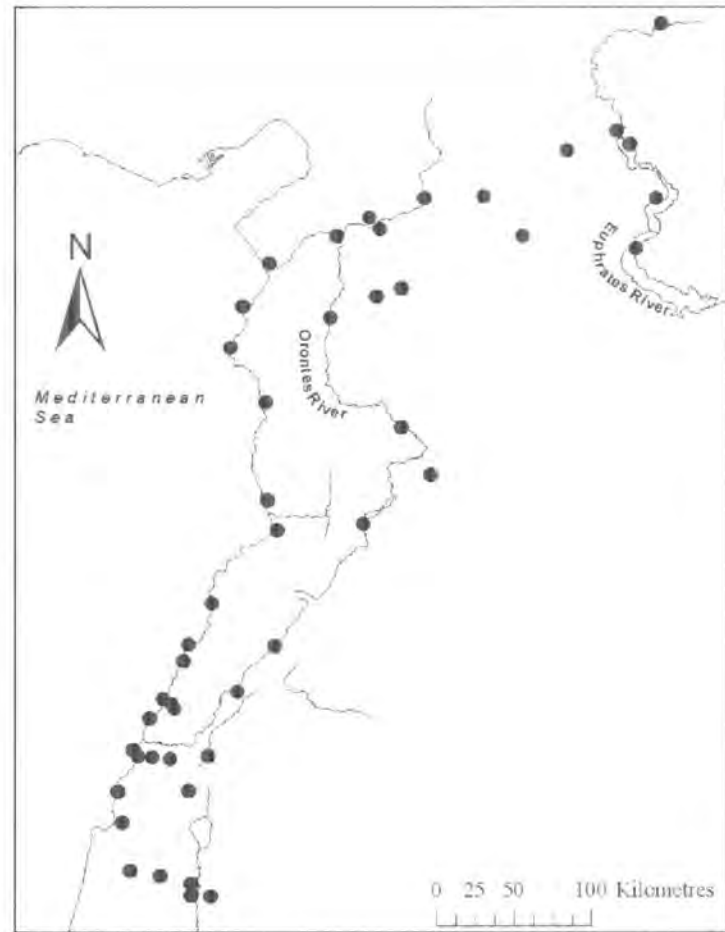
Map 2. Northern Levant with sites used in present study (key overleaf)

## Key to Sites in Map 2 (grid reference in parentheses)

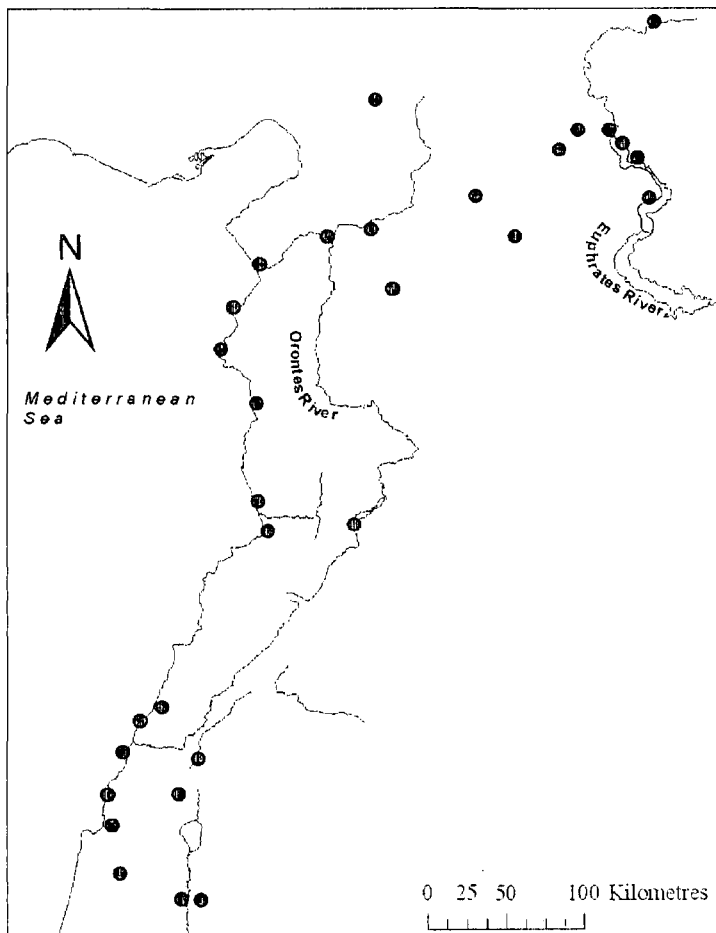
1	Ain Dara (C2)	29	Ras Ibn Hani (B2)
2	Akhziv (A5)	30	Sarepta (A4)
3	Al Mina (B2)	31	Sidon (A4)
4	Aleppo (C2)	32	Tambourit (A4)
5	Arslan Tash (D1)	33	Tel Dan (B5)
6	'Athlit (A5)	34	Tel Jezreel (A5)
7	Beirut (B4)	35	Tel Rehov (B5)
8	Beth Shan (B5)	36	Tell Abou Danne (C2)
9	Byblos (B4)	37	Tell Abu Hawam (A5)
10	Chatal Höyük (C2)	38	Tell Afis (C2)
11	Damascus (B4)	39	Tell Ahmar (D1)
12	Deve Höyük (D1)	40	Tell Arqa (B3)
13	Hama (C3)	41	Tell el Ghassil (B4)
14	Hazor (B5)	42	Tell Judeideh (C2)
15	Jerablus (D1)	43	Tell Jurn Kabir (D2)
16	Joya (A5)	44	Tell Kazel (B3)
17	Kamid el Loz (B4)	45	Tell Keisan (A5)
18	Kefrik (D1)	46	Tell Mastuma (C2)
19	Khalde (B4)	47	Tell Nebi Mend (C3)
20	Khirbet Silm (A5)	48	Tell Qarqur (B2)
21	Megiddo (A5)	49	Tell Rifa'at (C2)
22	Nayrab (C2)	50	Tell Sheikh Hassan (D2)
23	Pella (B5)	51	Tell Shiyukh Fawqani (D1)
24	Qasmieh (A4)	52	Tell Sukas (B3)
25	Qatna/Tell Mishrifeh (C3)	53	Tell Ta'yinat (B2)
26	Qraye (A4)	54	Tille Höyük (D1)
27	Rachidieh (A5)	55	Tyre (A5)
28	Ras al Bassit (B2)	56	Zincirli (C1)



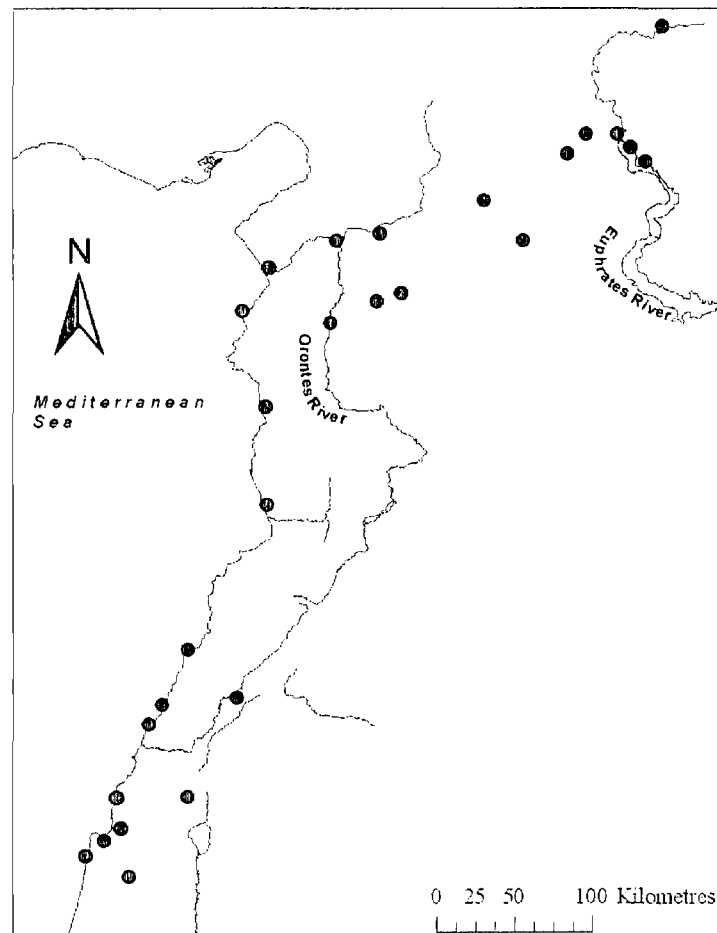
**Map 3. Sites from study area with Iron I contexts**



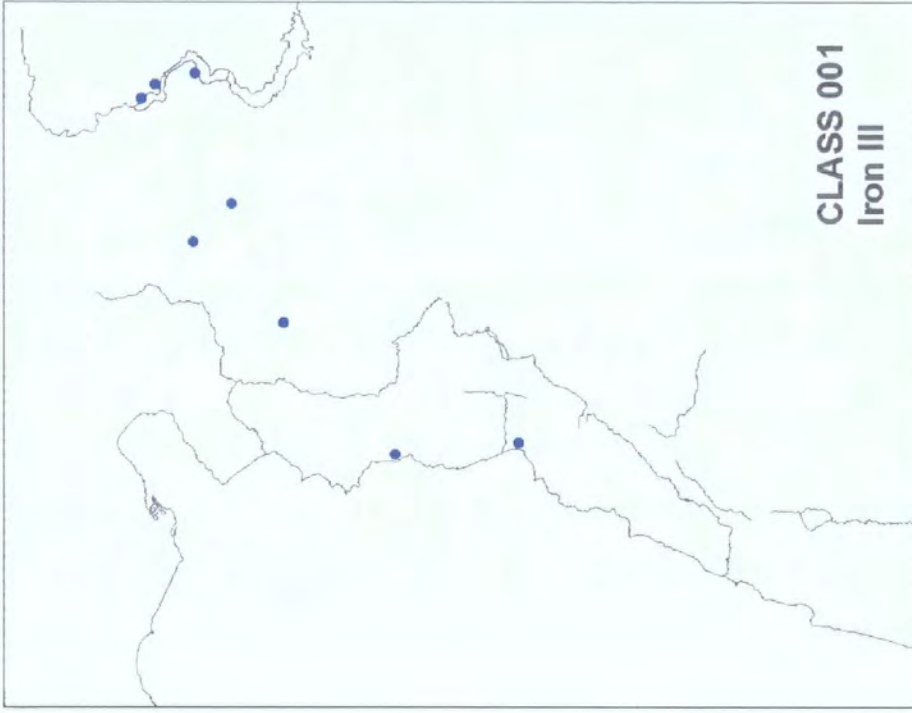
**Map 4. Sites from study area with Iron II contexts**



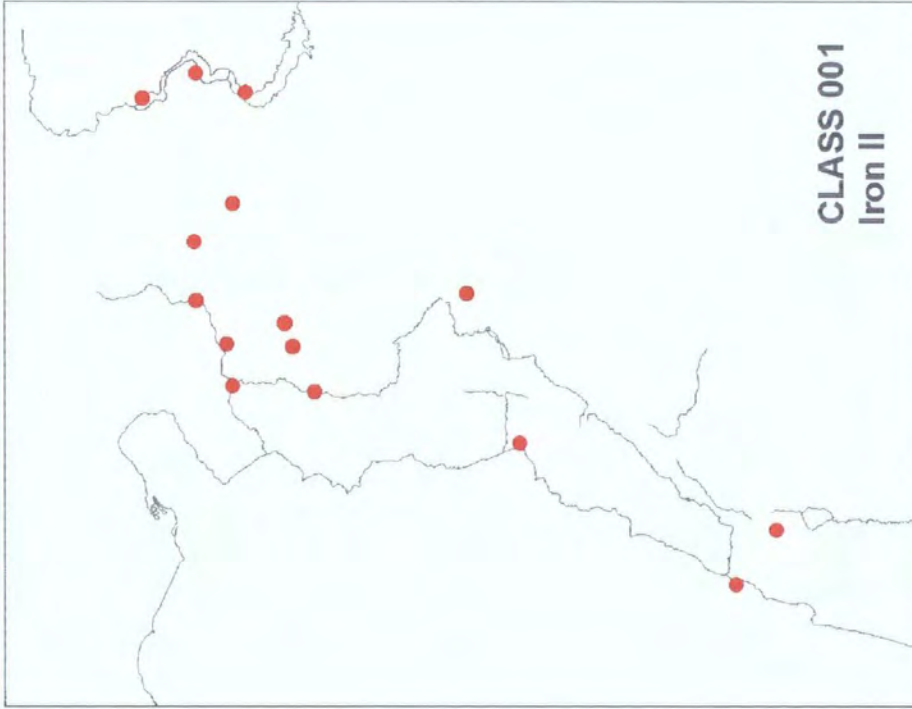
**Map 5. Sites from study area with Iron III contexts**



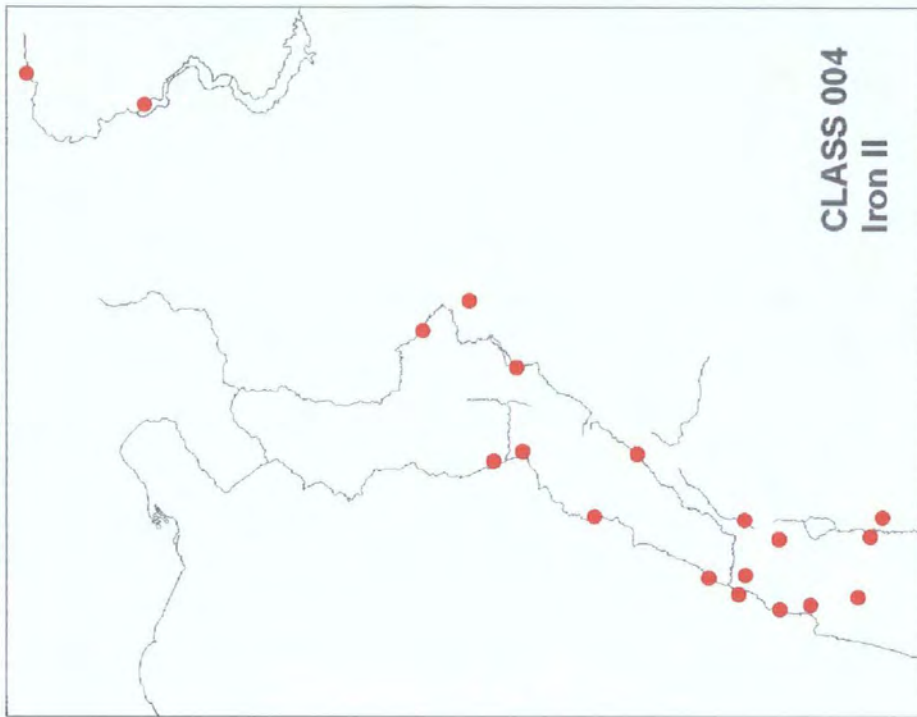
**Map 6. Sites from study area with Persian period contexts**



Map 8



Map 7



Map 10



Map 9

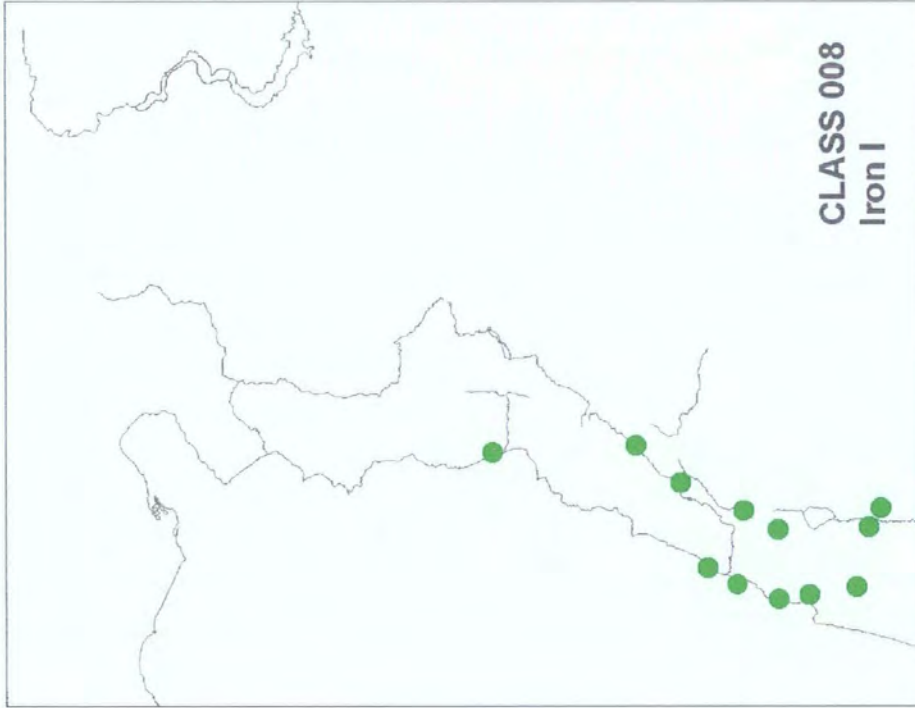




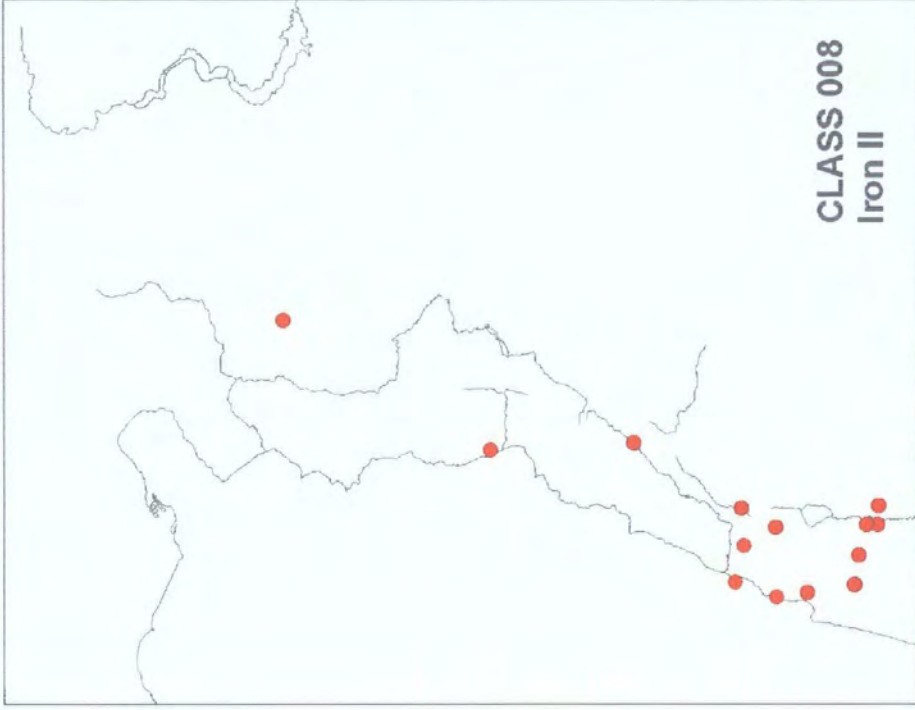
**Map 12**



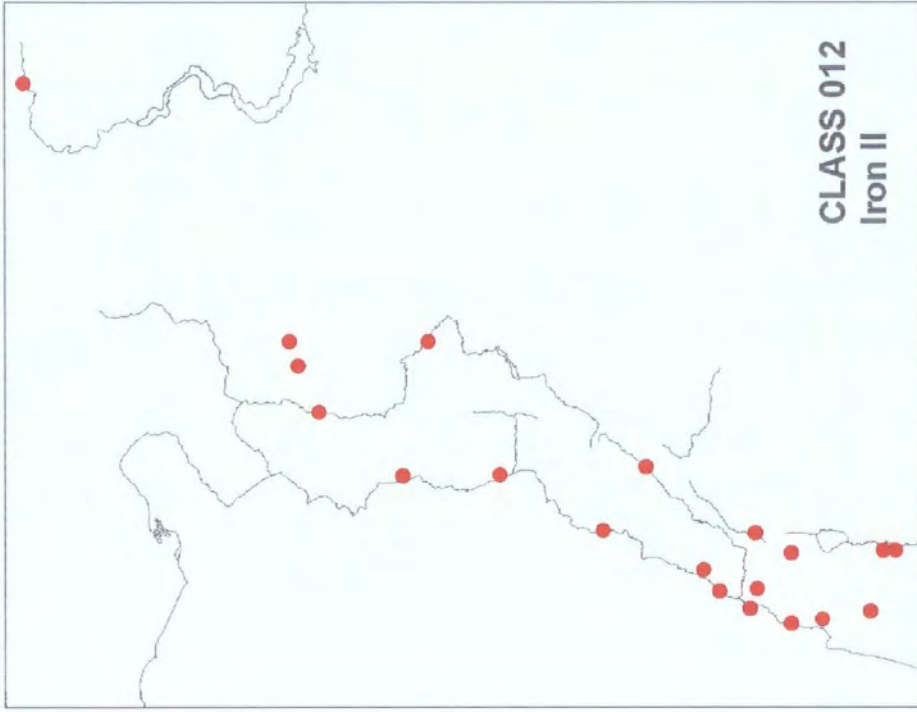
**Map 11**



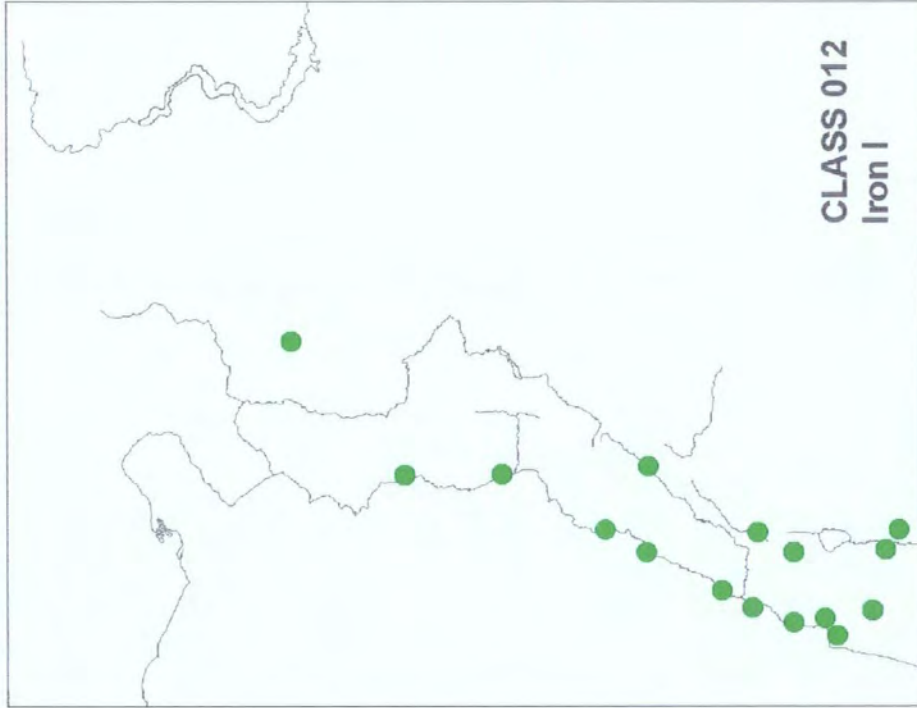
Map 13



Map 14



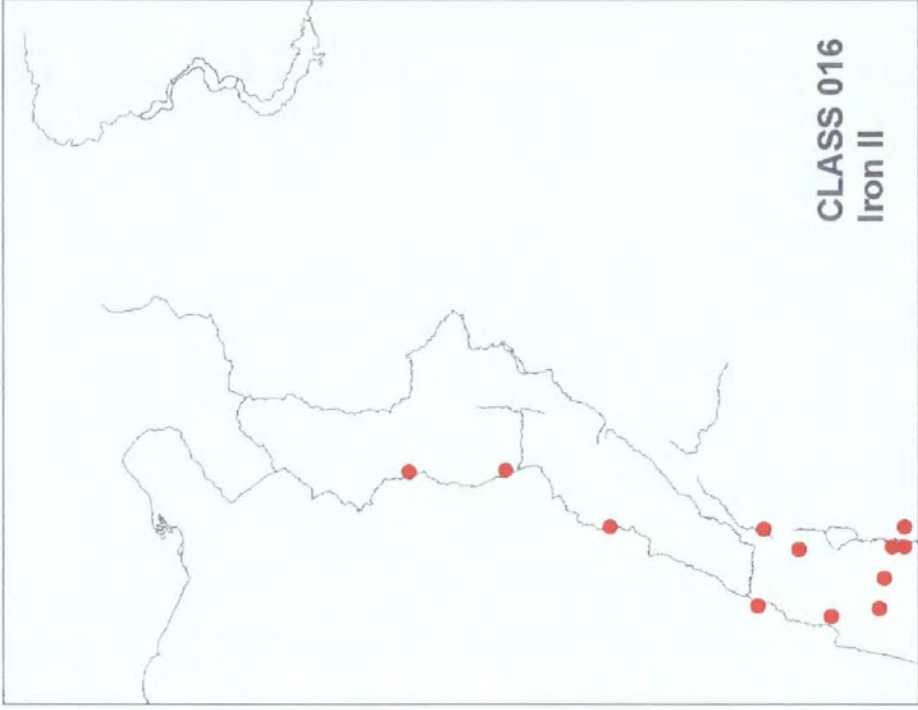
Map 16



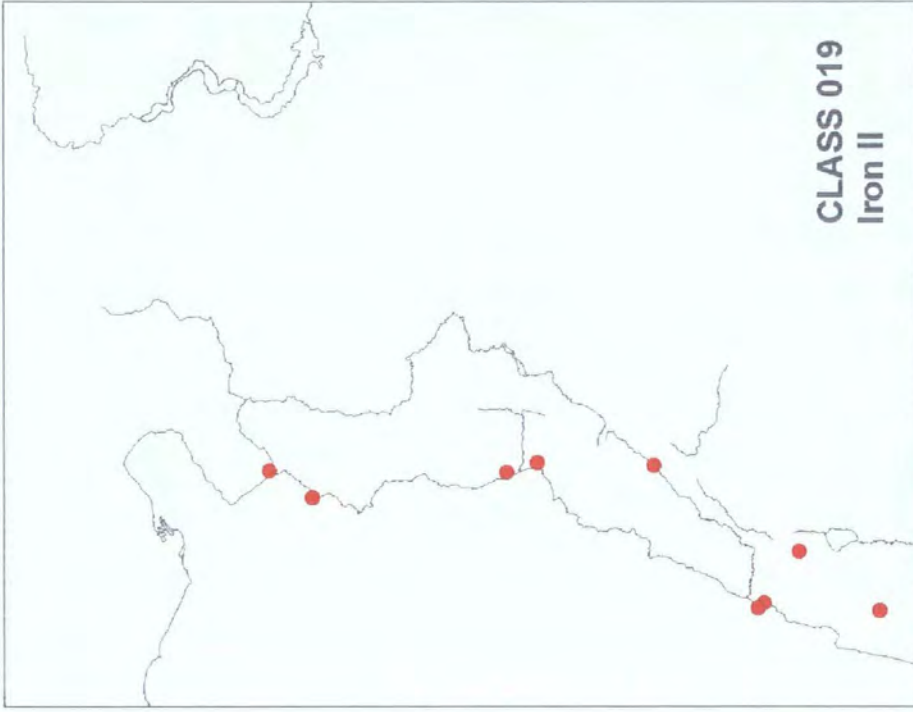
Map 15



Map 17



Map 18



Map 20



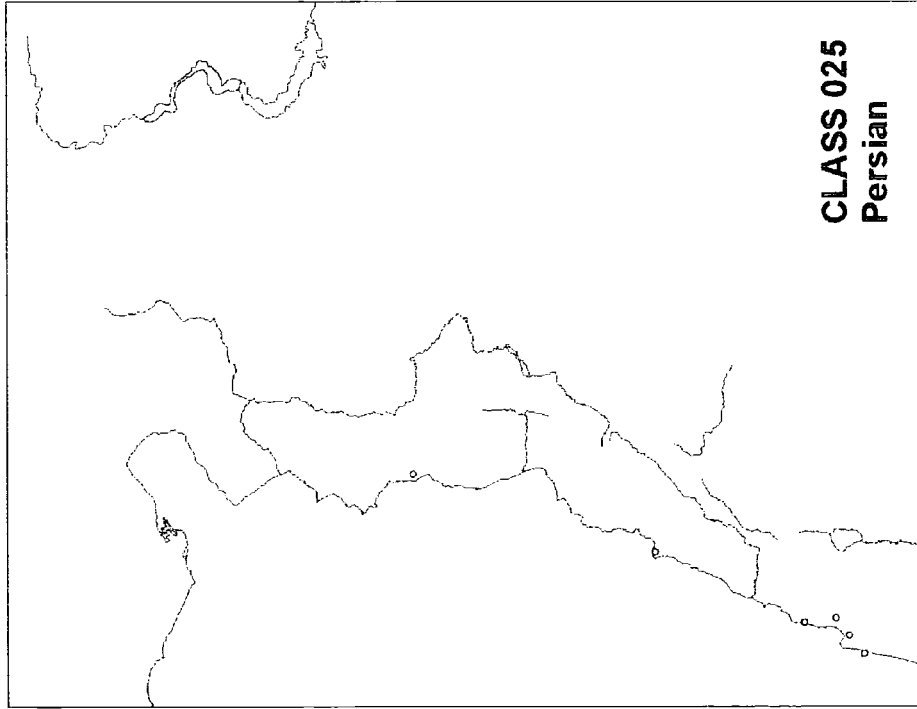
Map 19



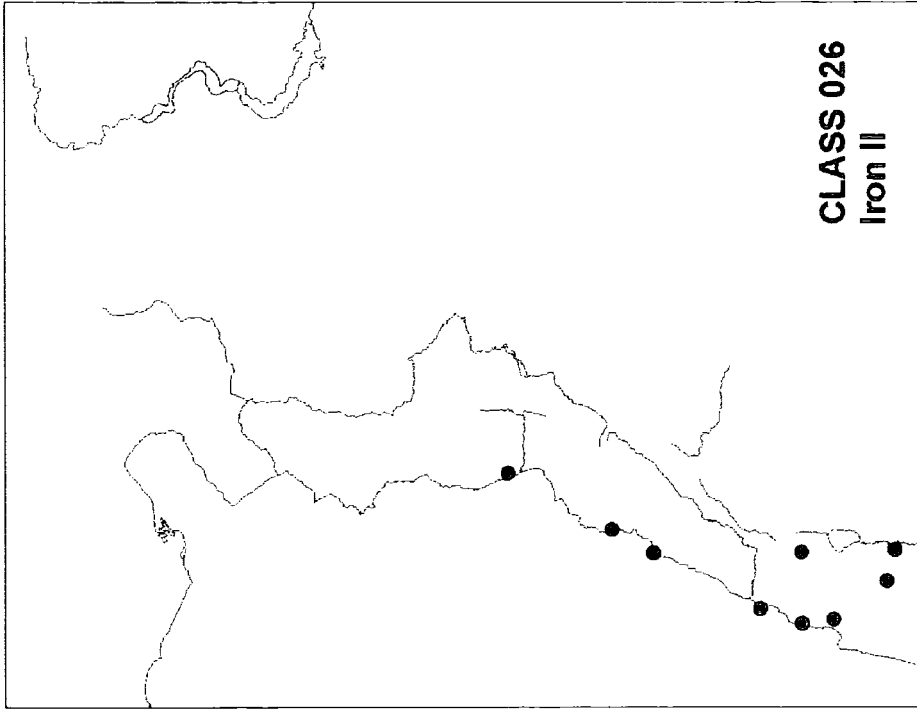
Map 22



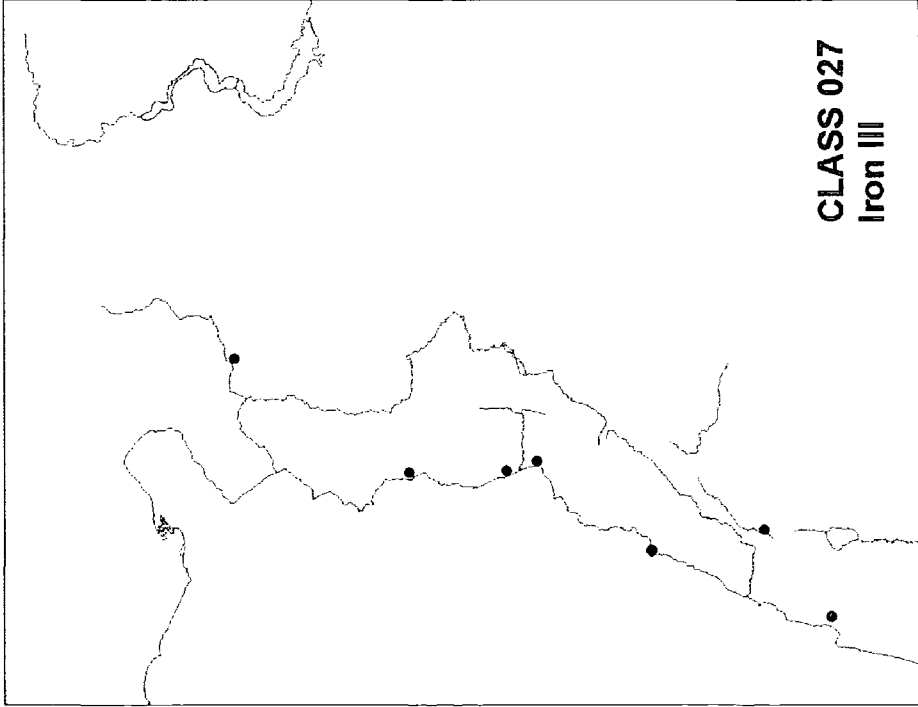
Map 21



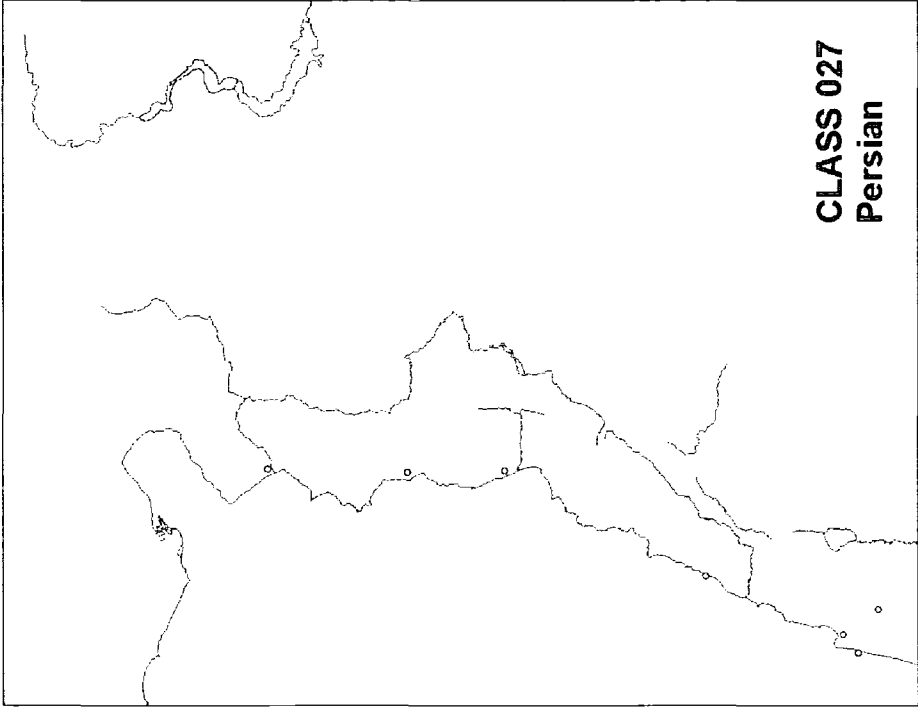
Map 23



Map 24

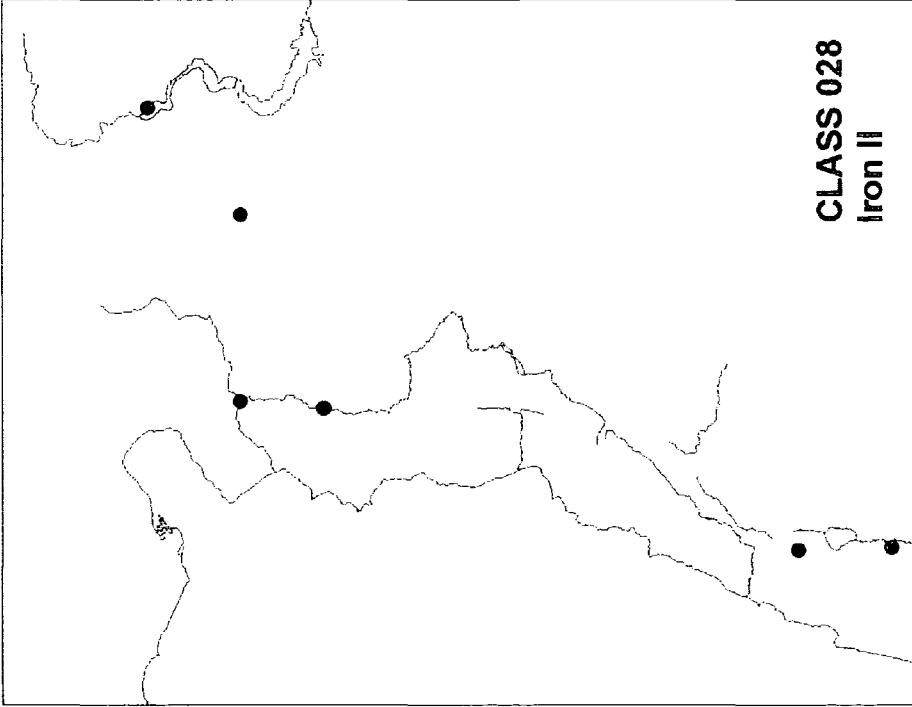


Map 25

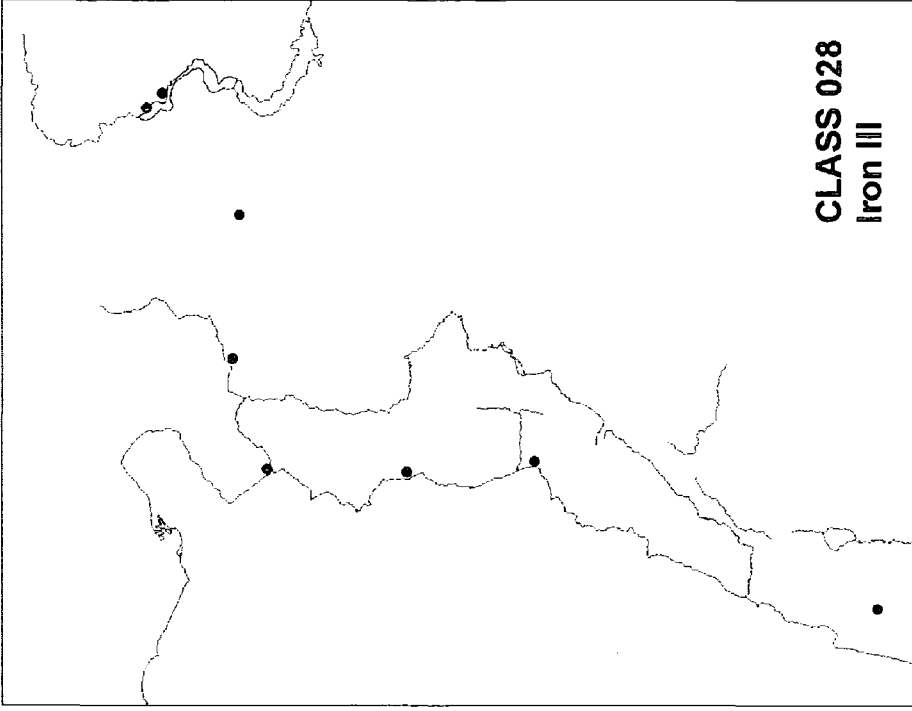


Map 26

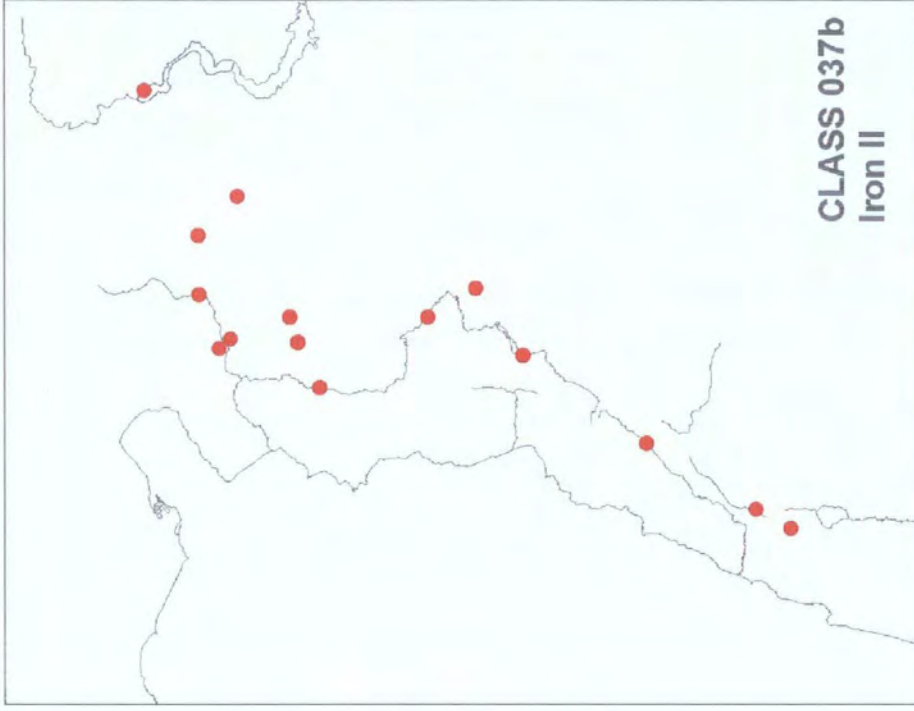




Map 27



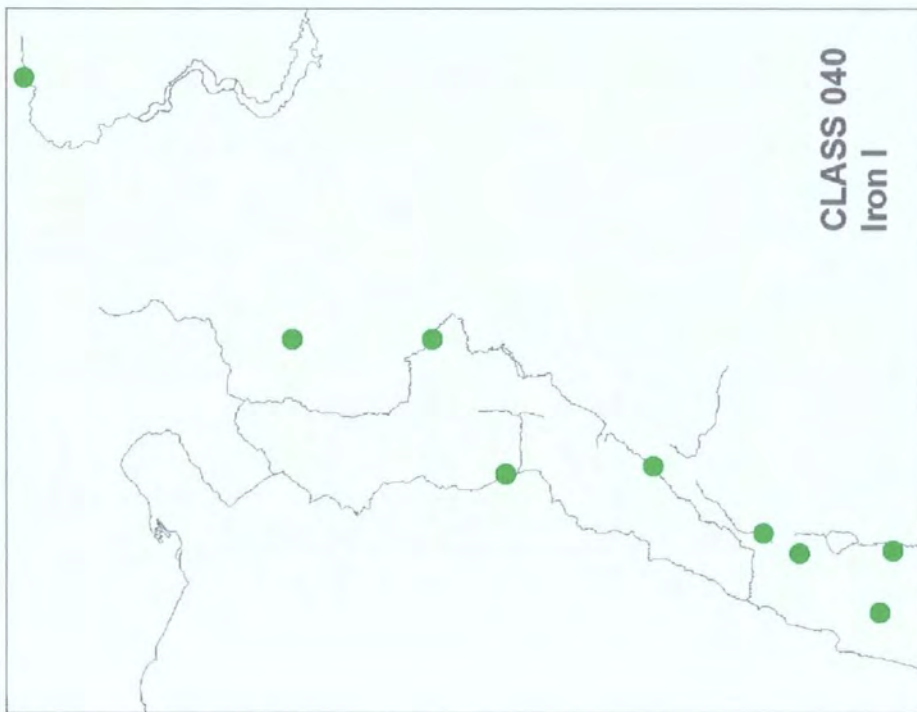
Map 28



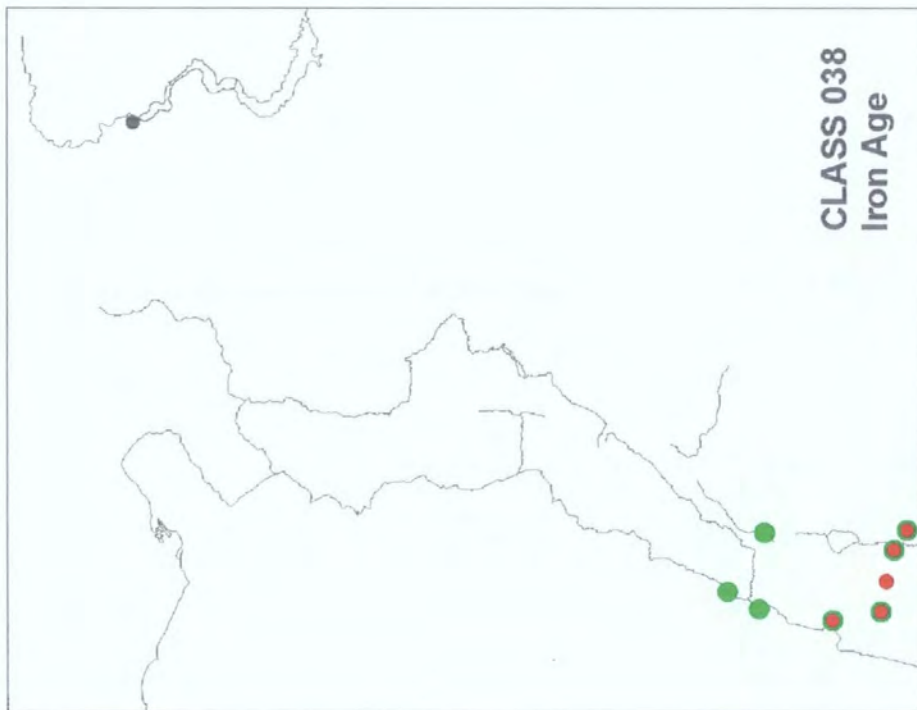
Map 30



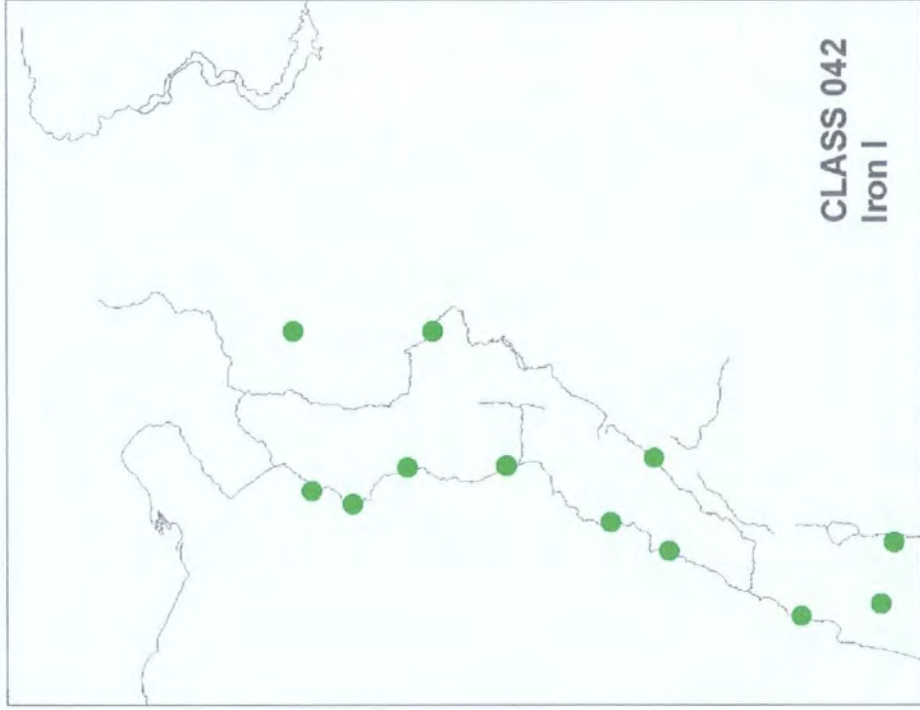
Map 29



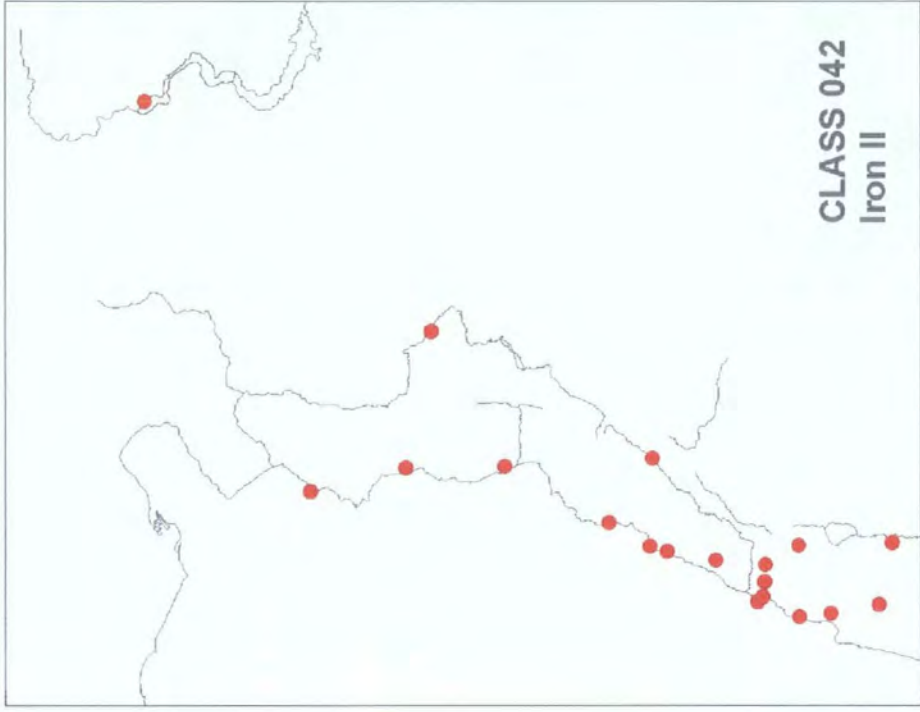
Map 32



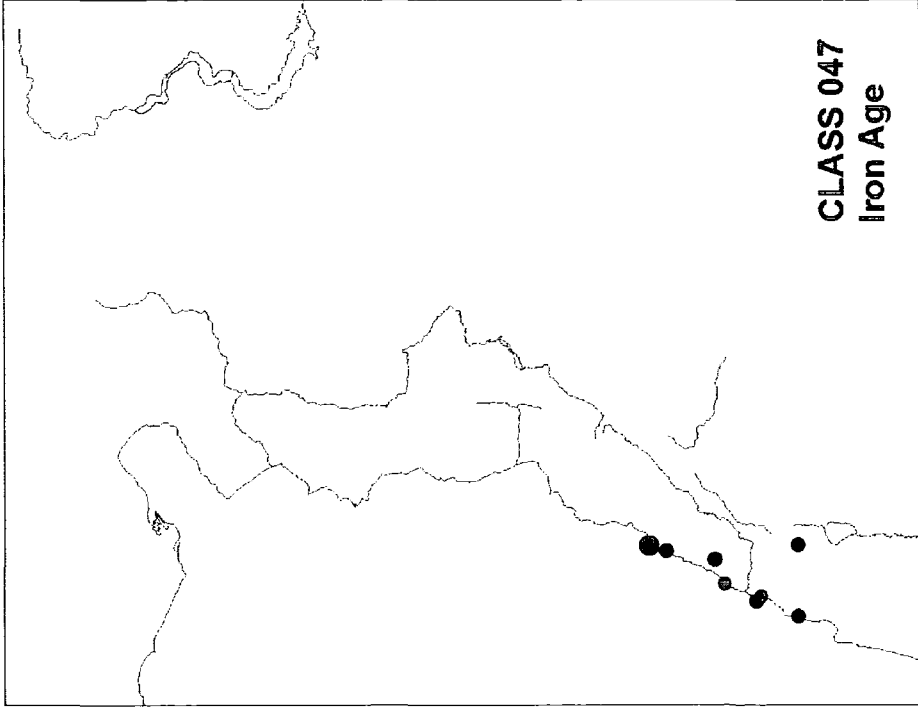
Map 31



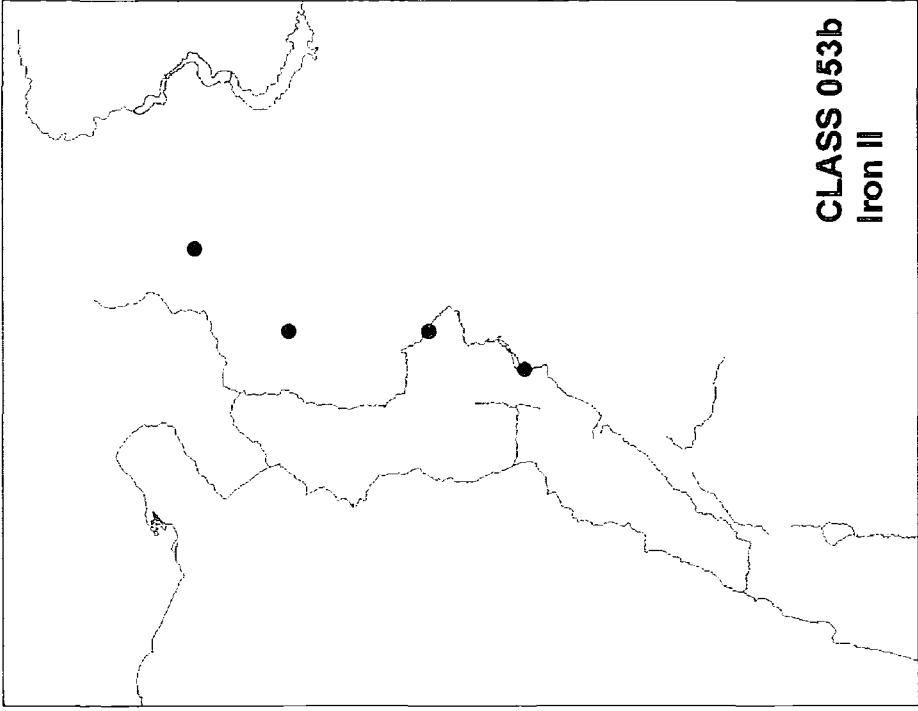
Map 33



Map 34



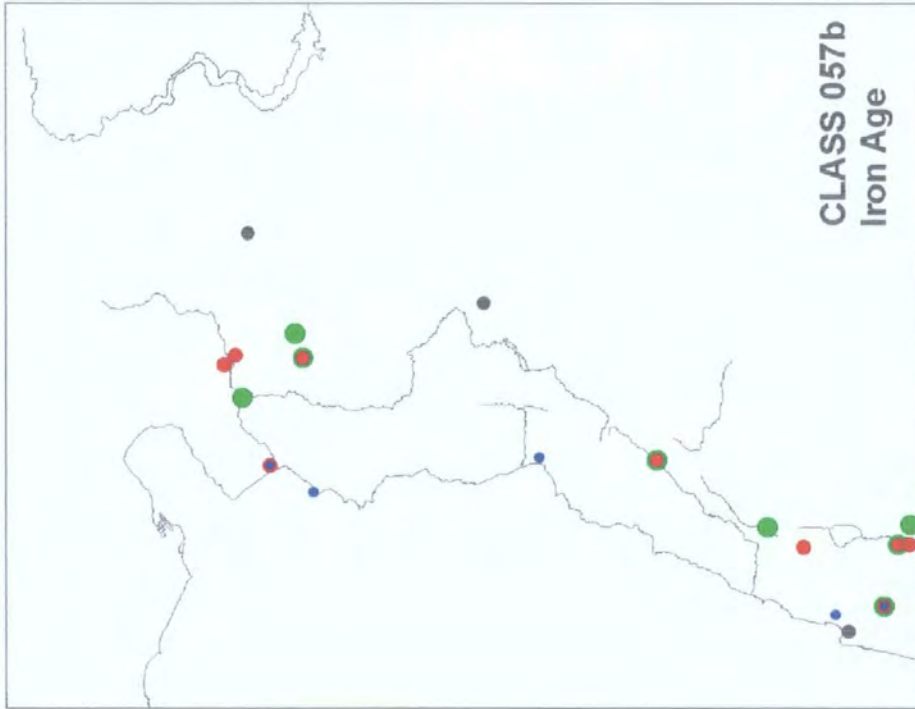
Map 35



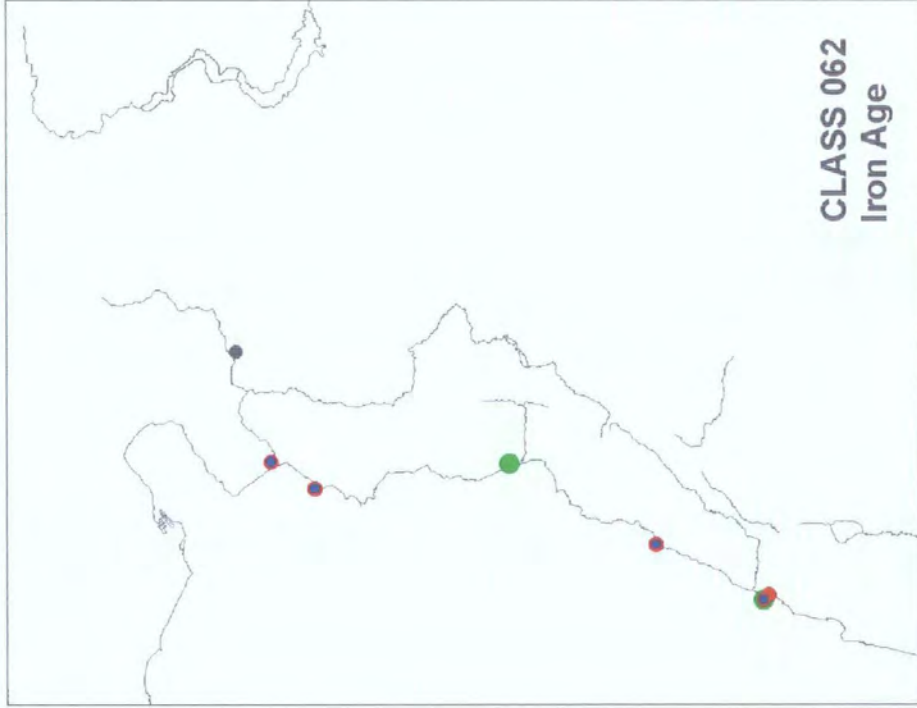
Map 36



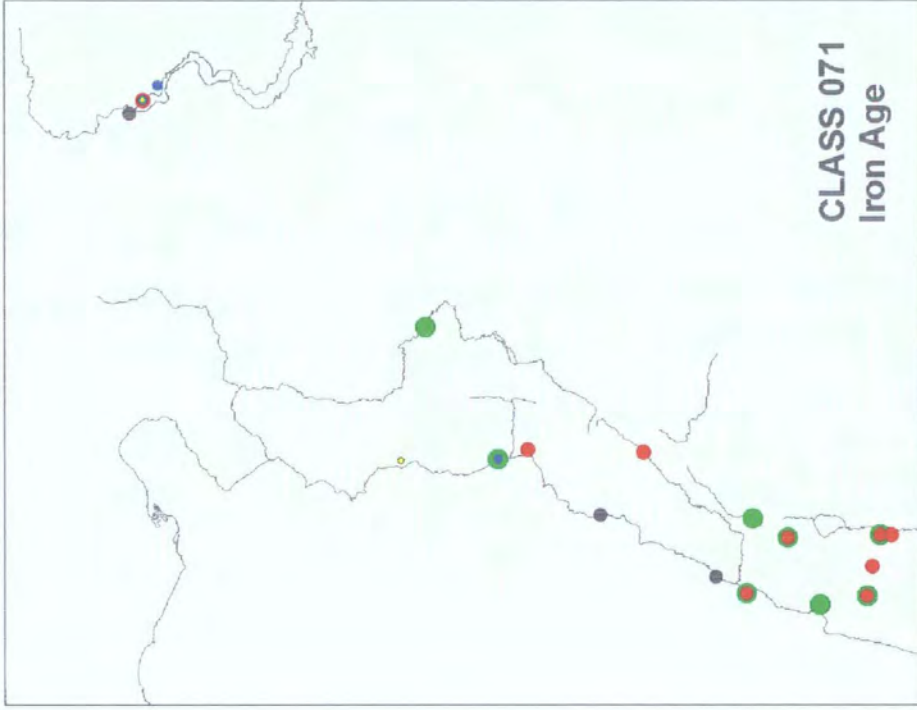
Map 38



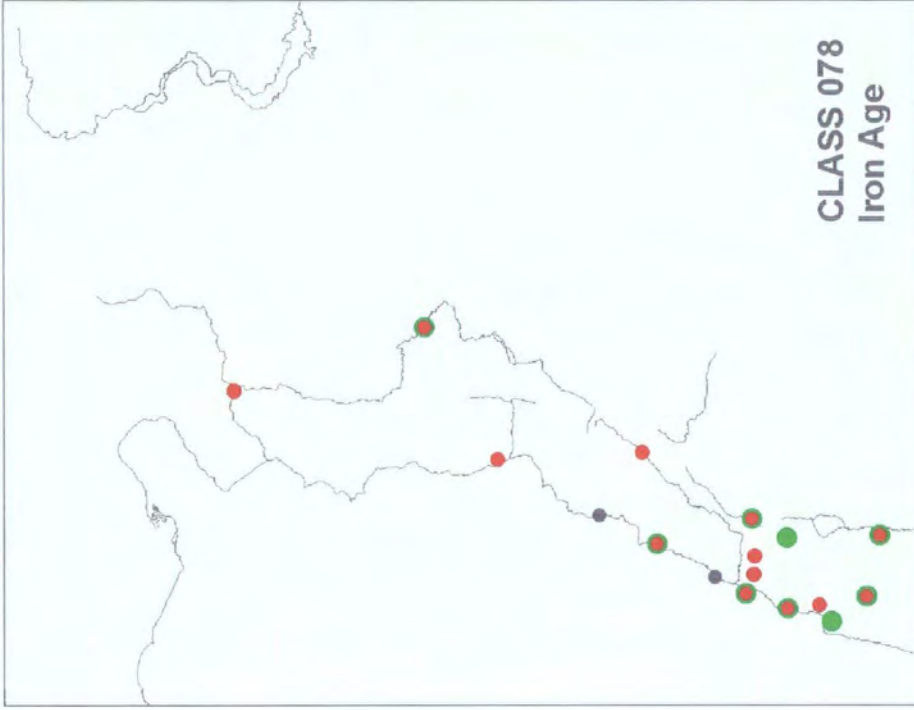
Map 37



Map 39



Map 40

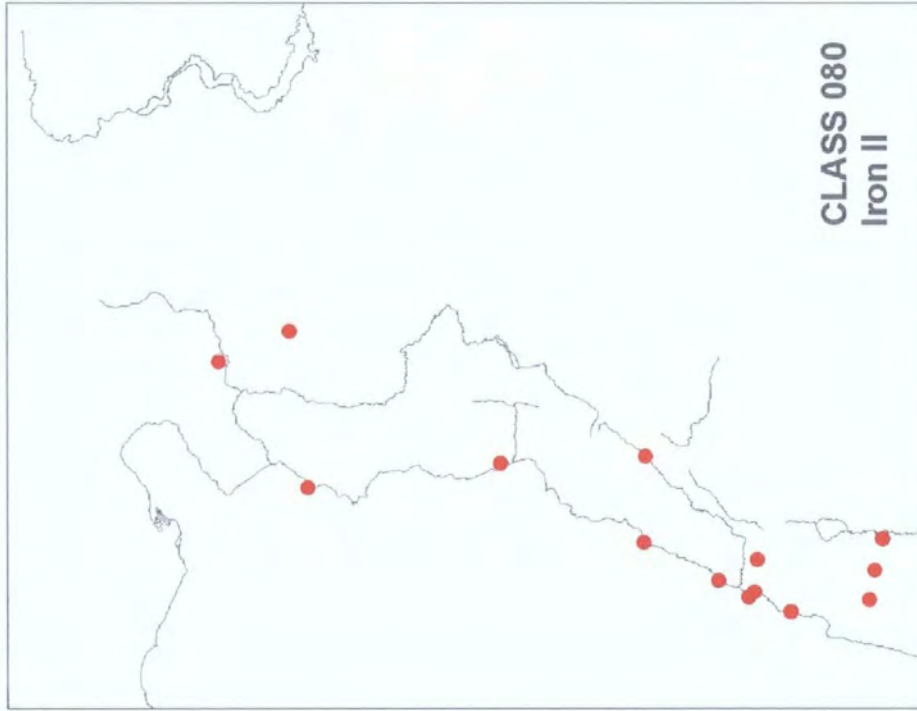


Map 42

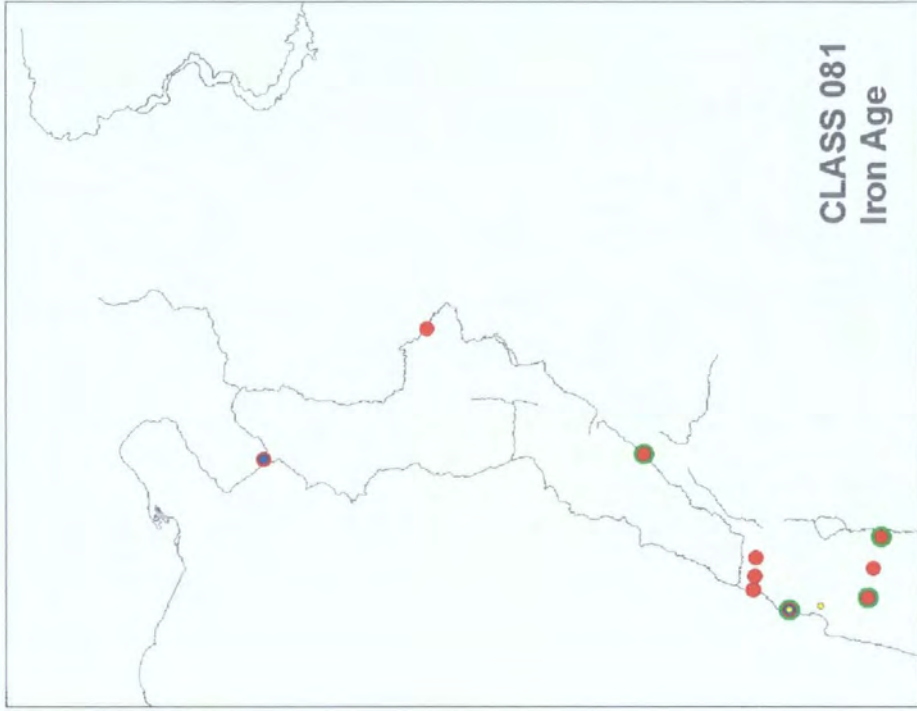


Map 41





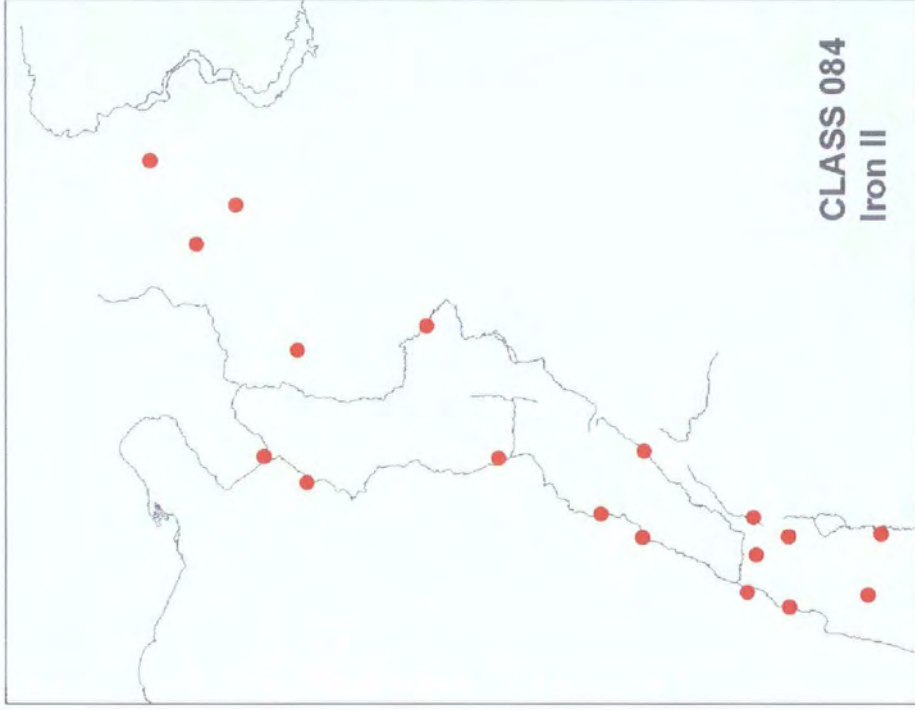
Map 43



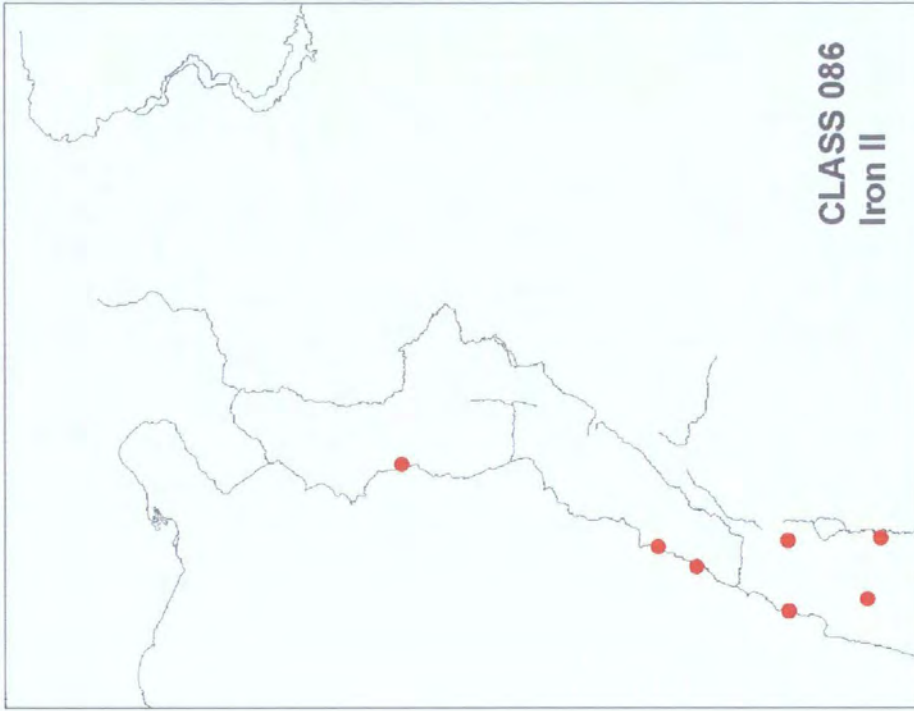
Map 44



Map 45



Map 46



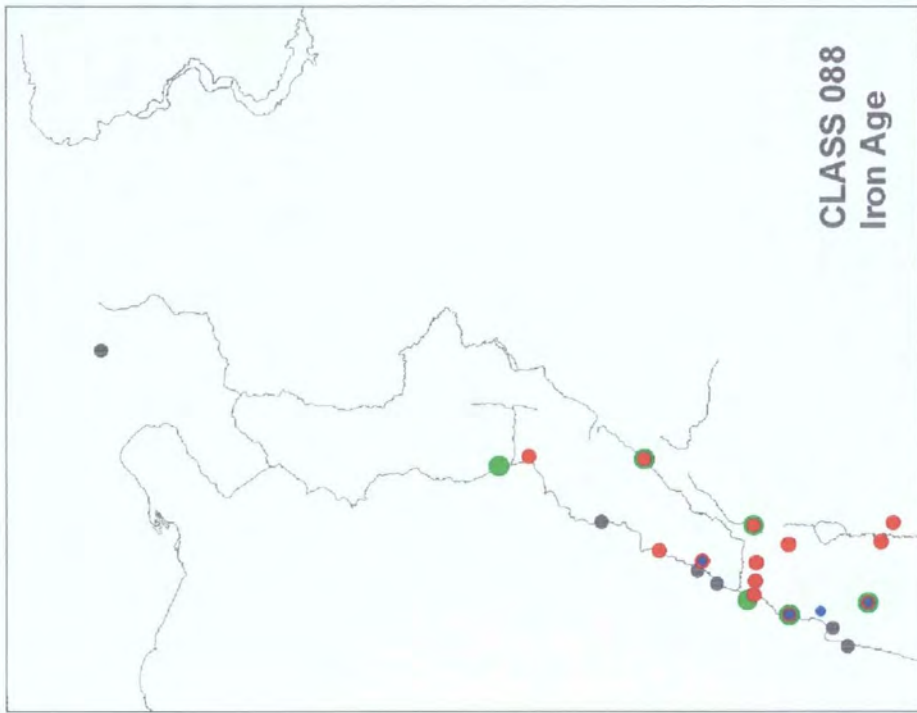
Map 48



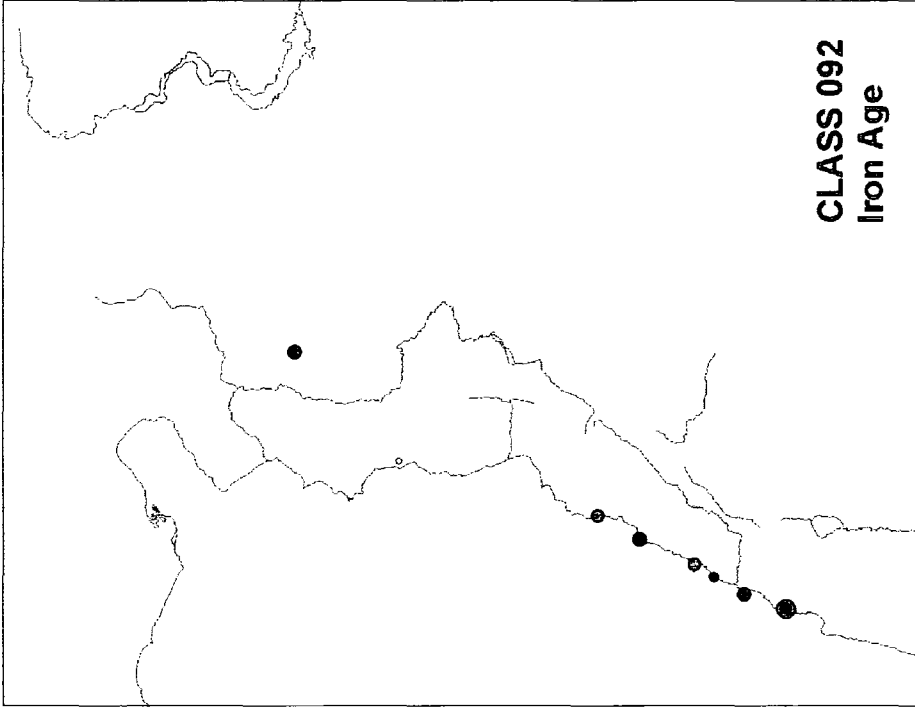
Map 47



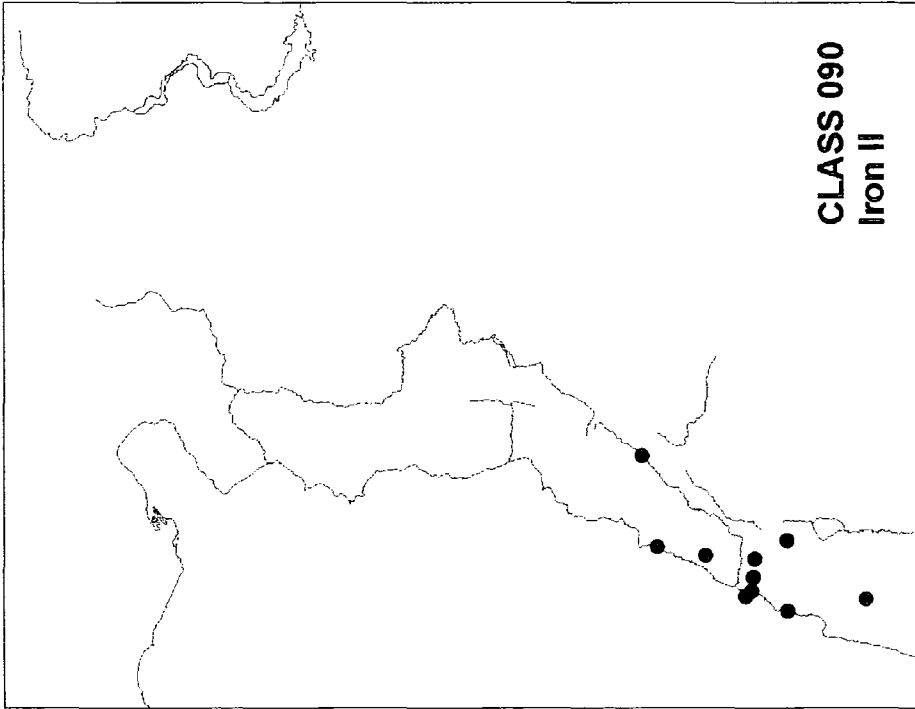
Map 49



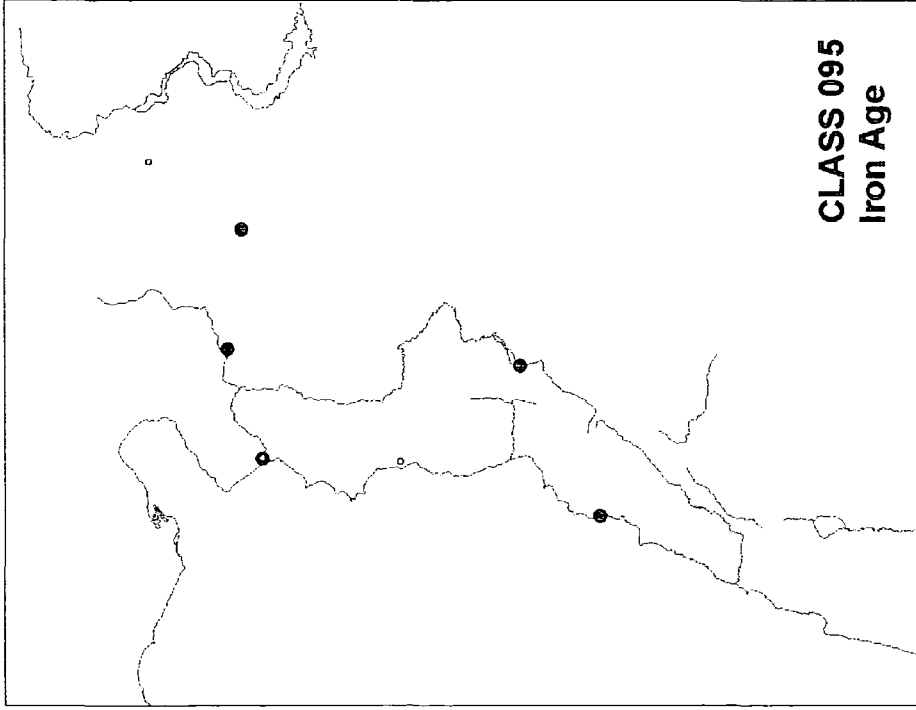
Map 50



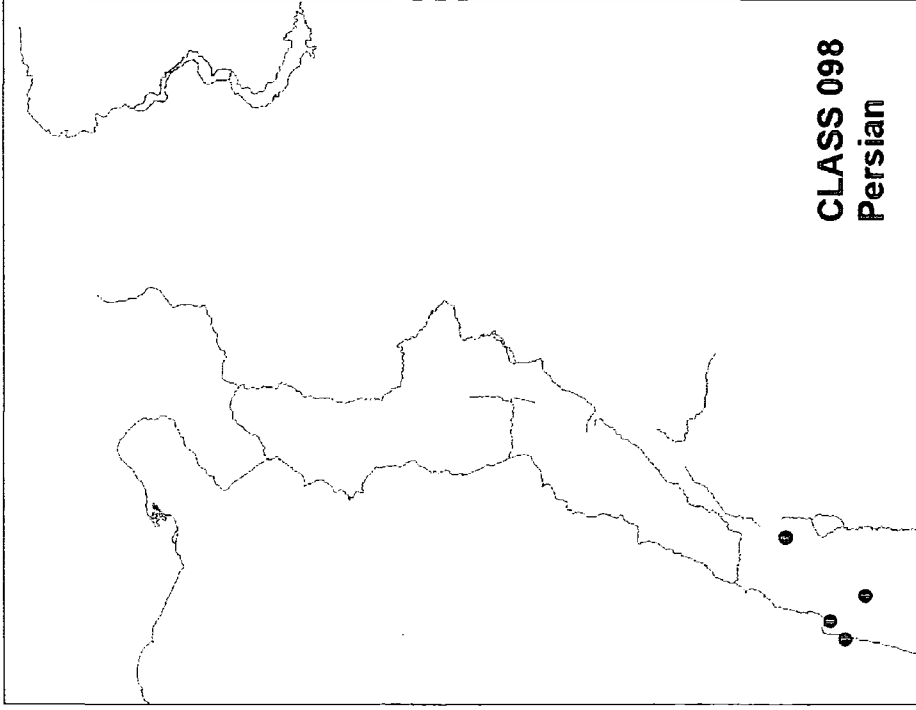
Map 52



Map 51



Map 53



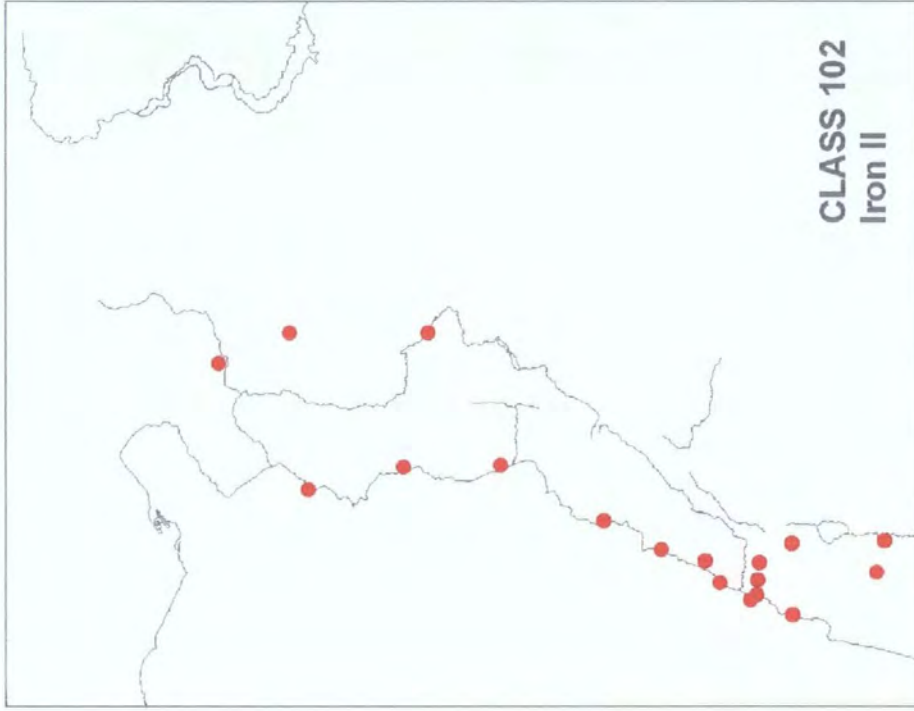
Map 54



Map 56



Map 55

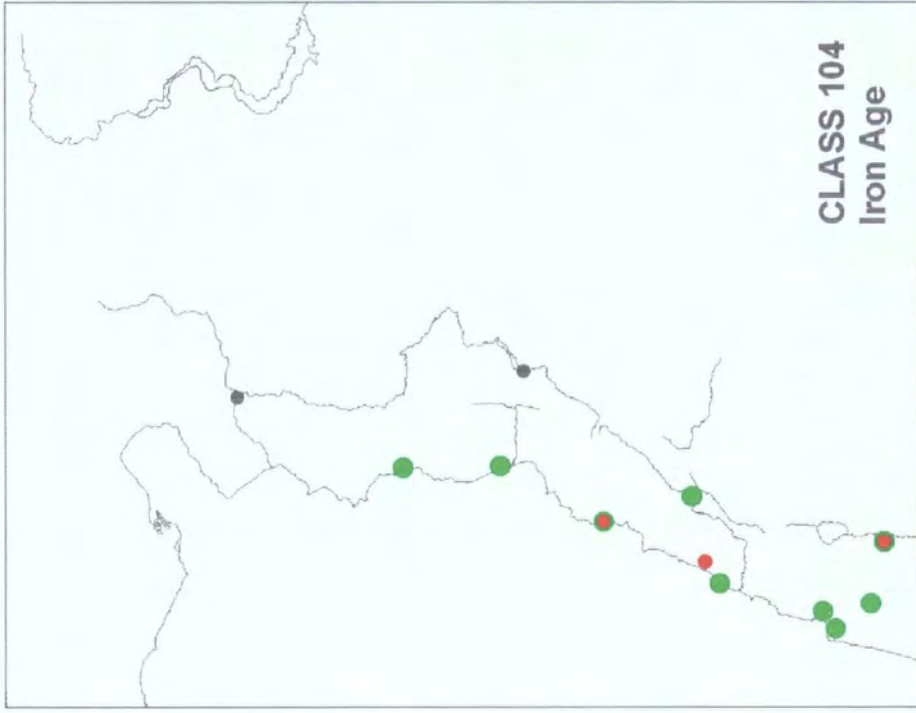


Map 58

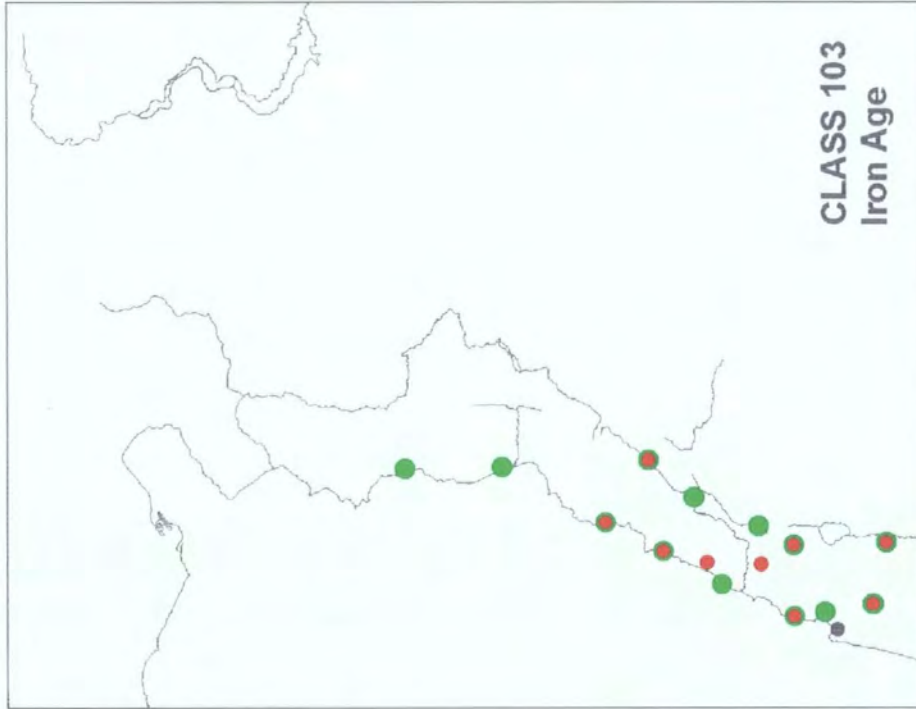


Map 57

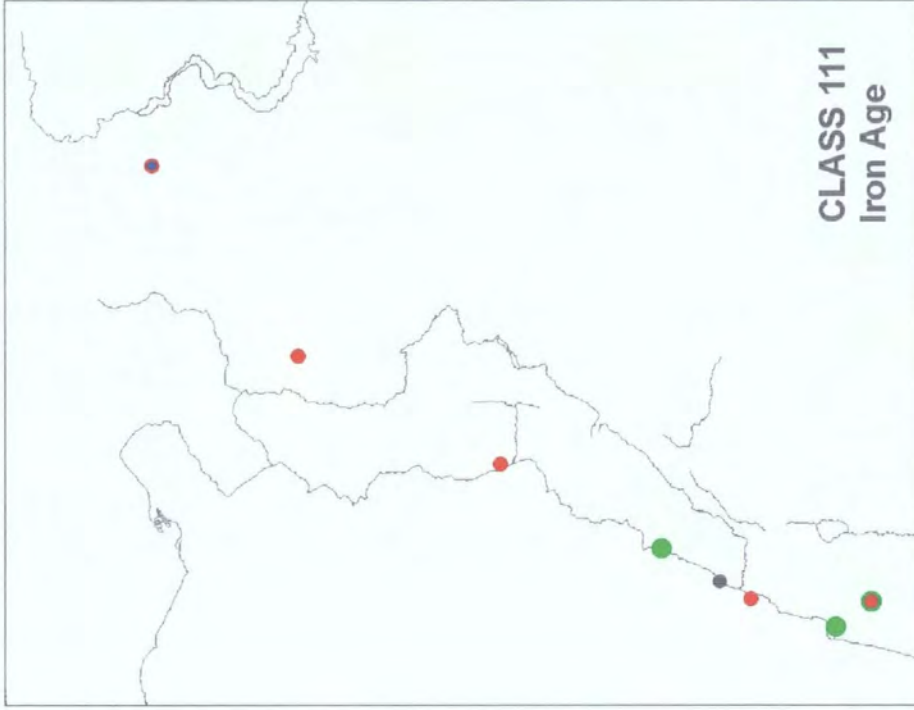




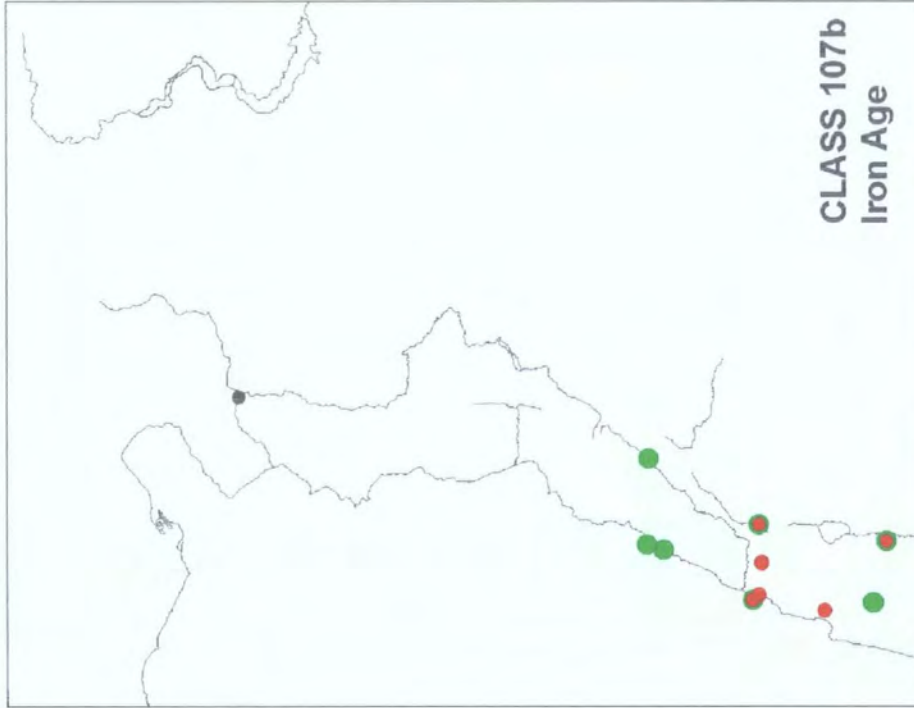
Map 60



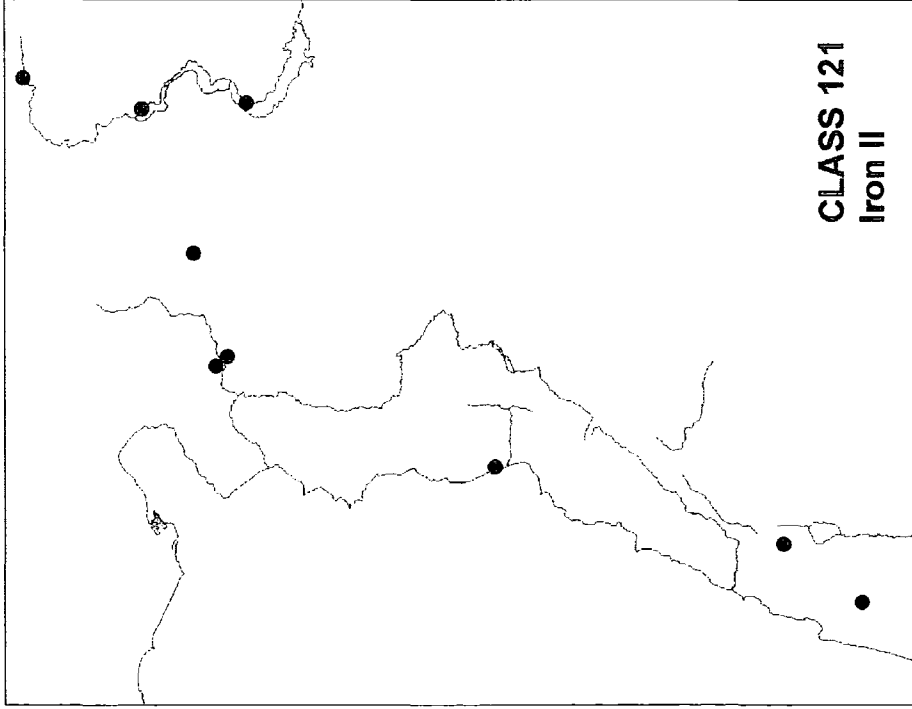
Map 59



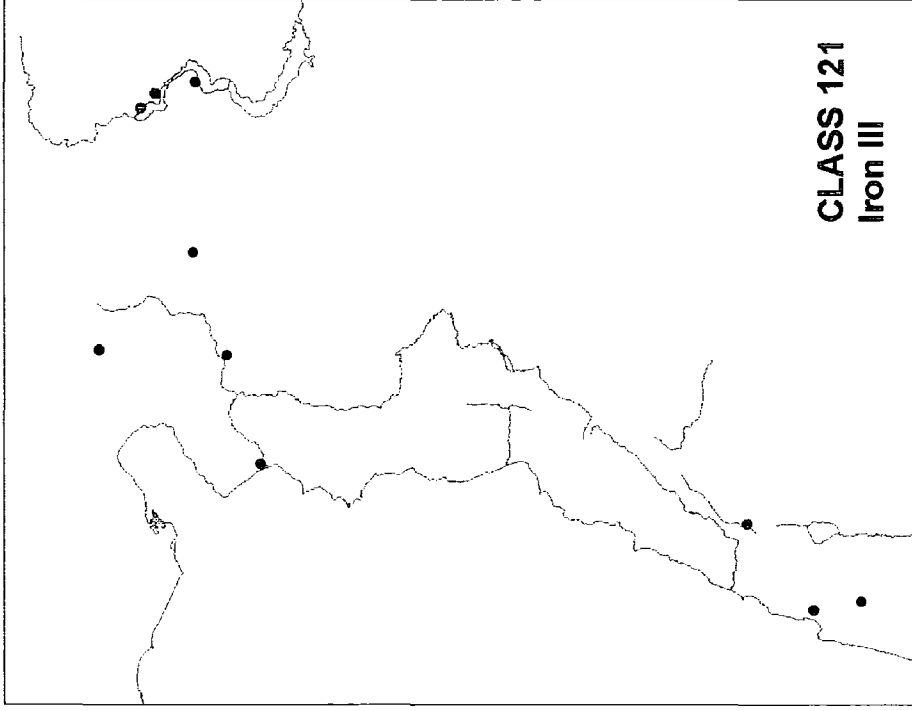
Map 62



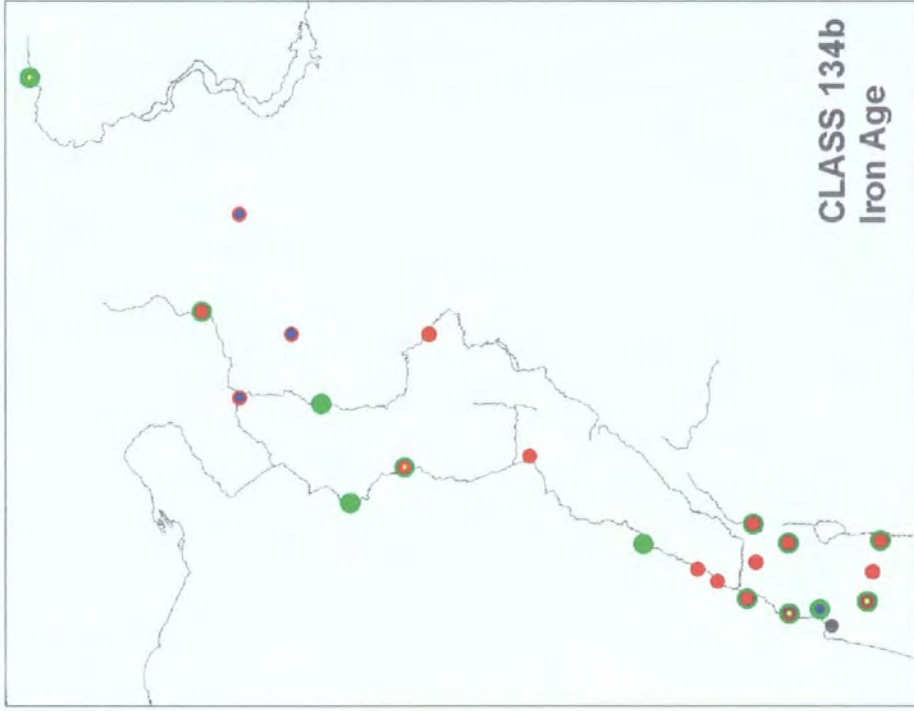
Map 61



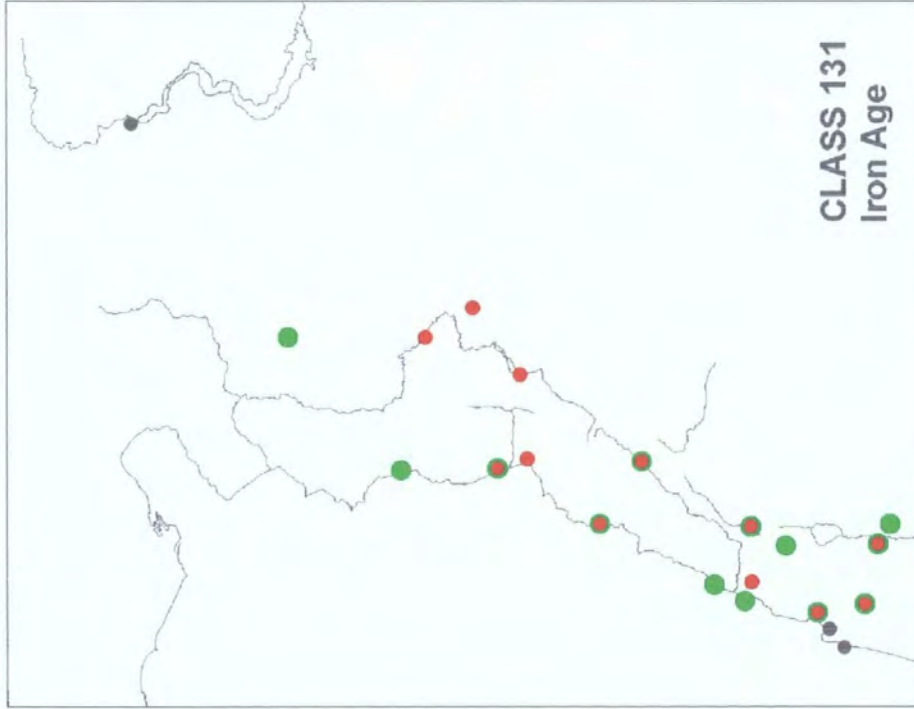
Map 63



Map 64



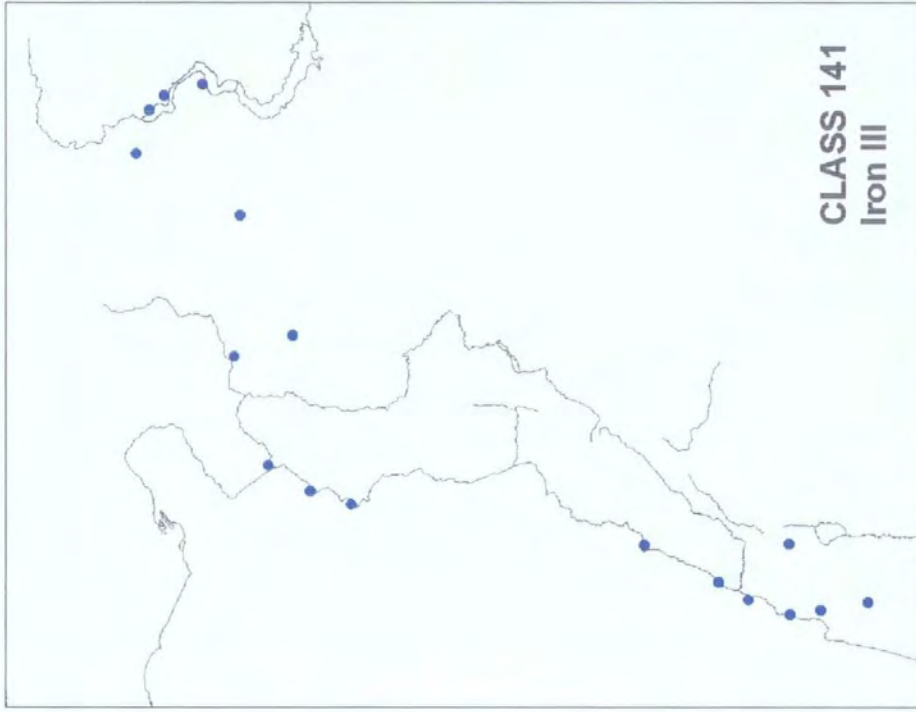
Map 66



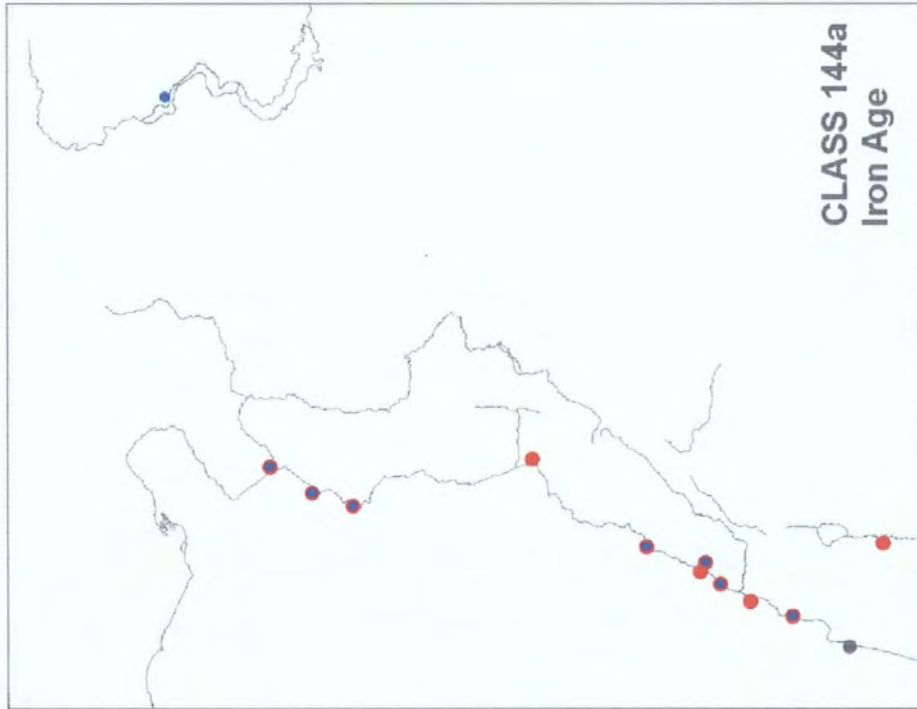
Map 65



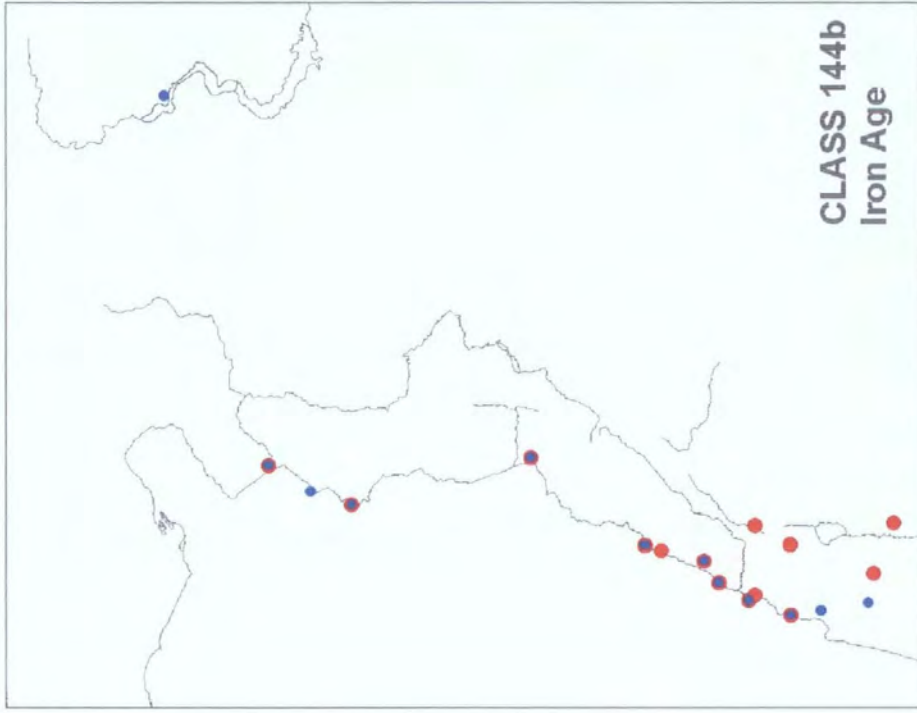
Map 67



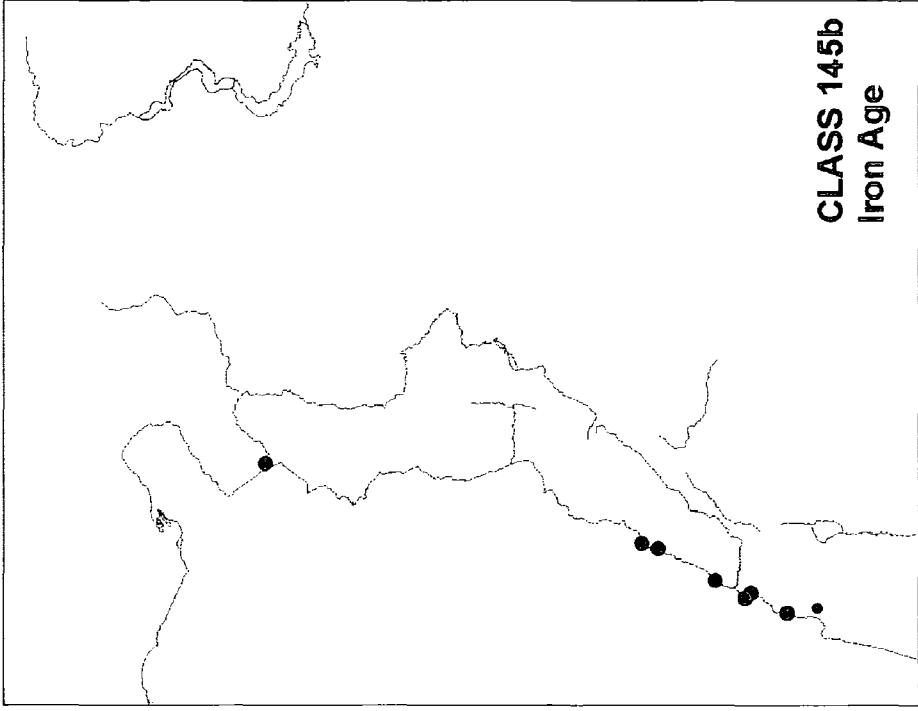
Map 68



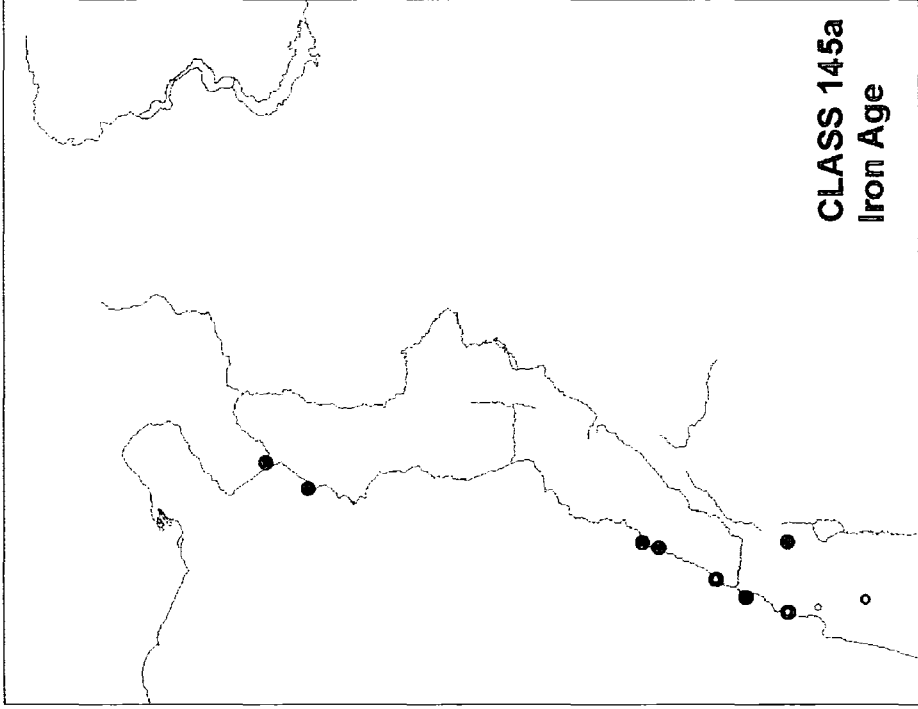
Map 69



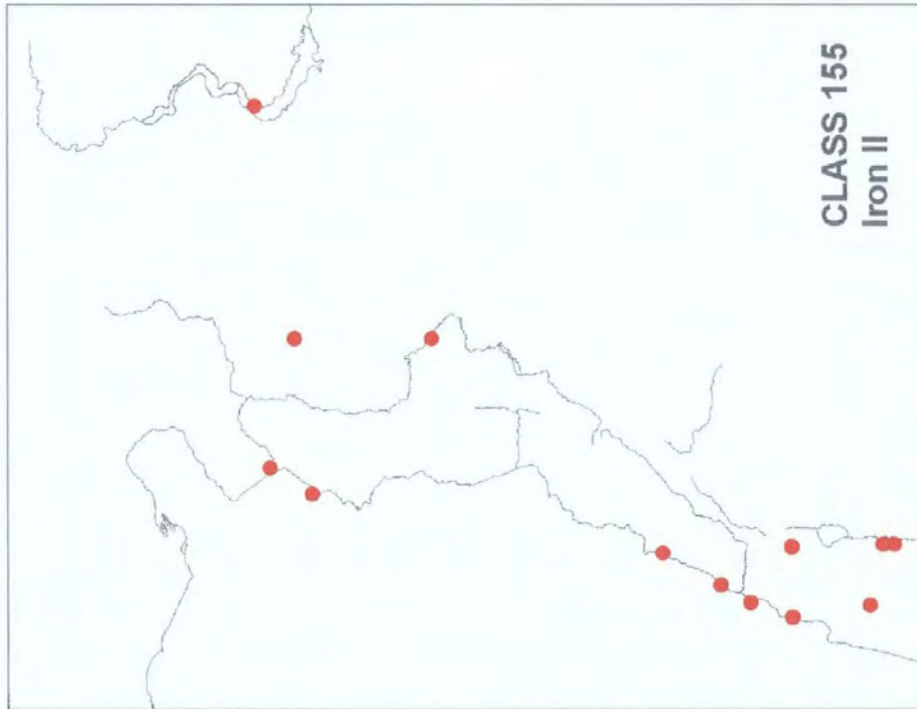
Map 70



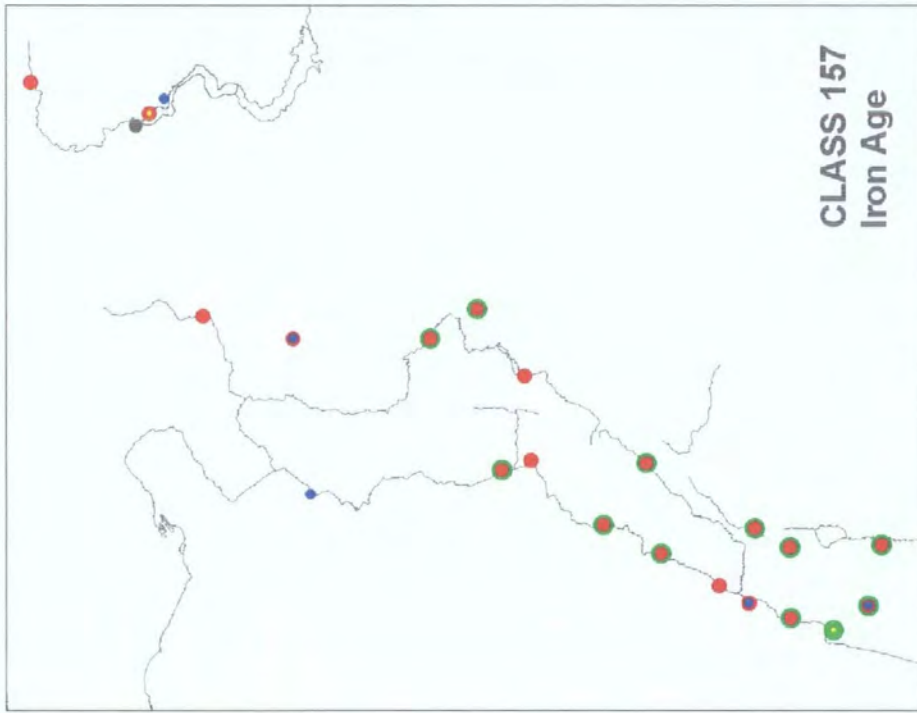
Map 72



Map 71

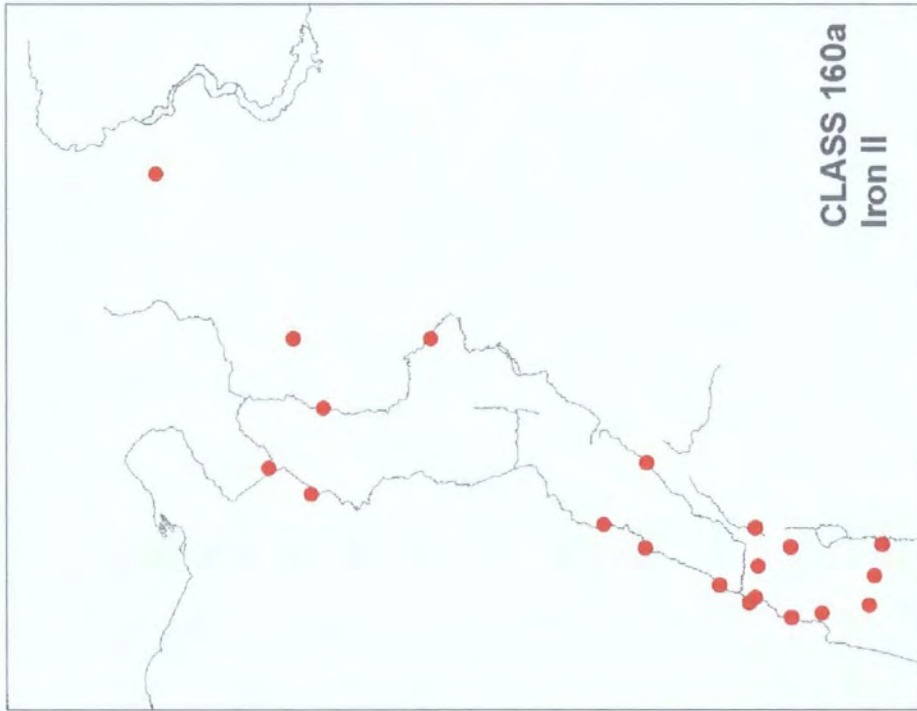


Map 73

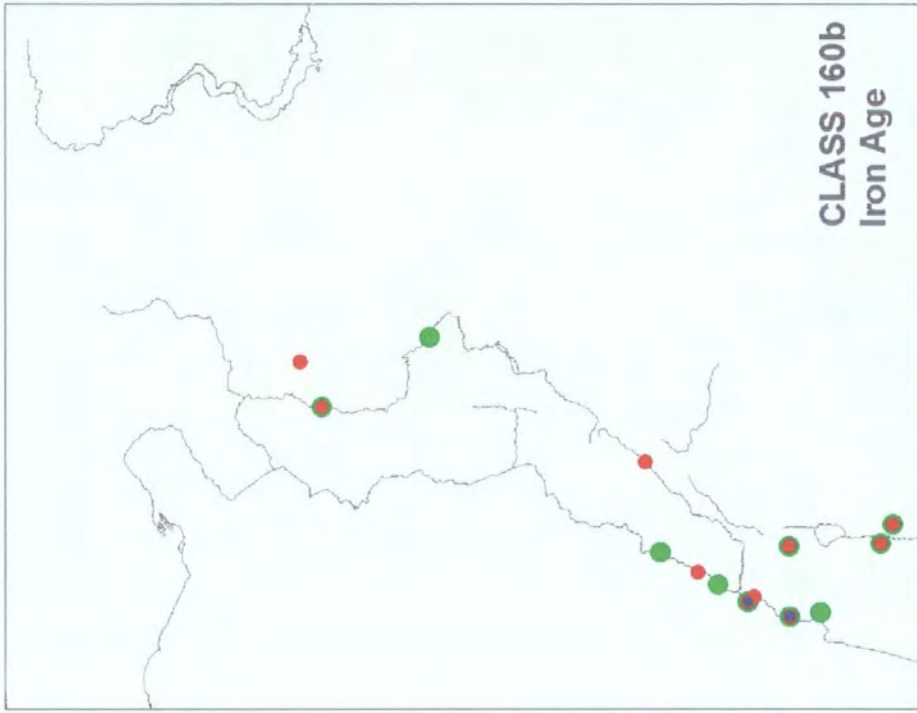


Map 74

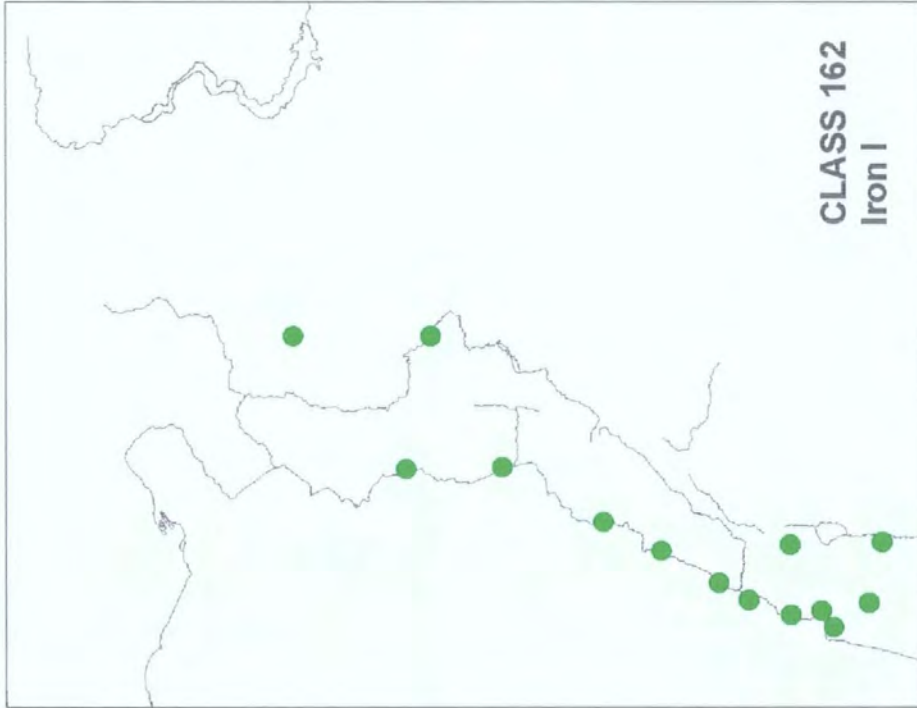




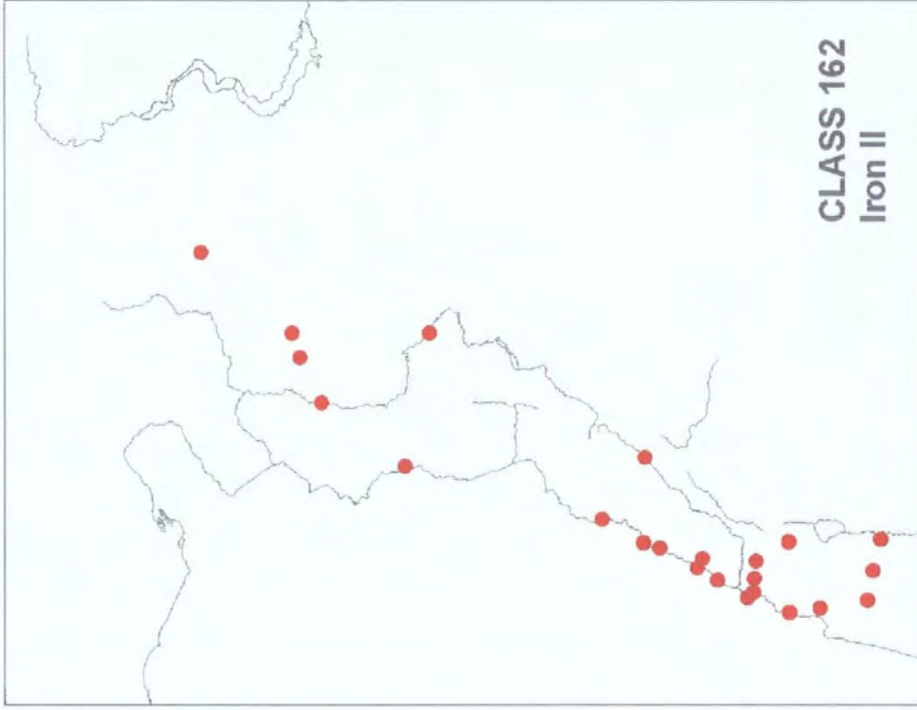
Map 75



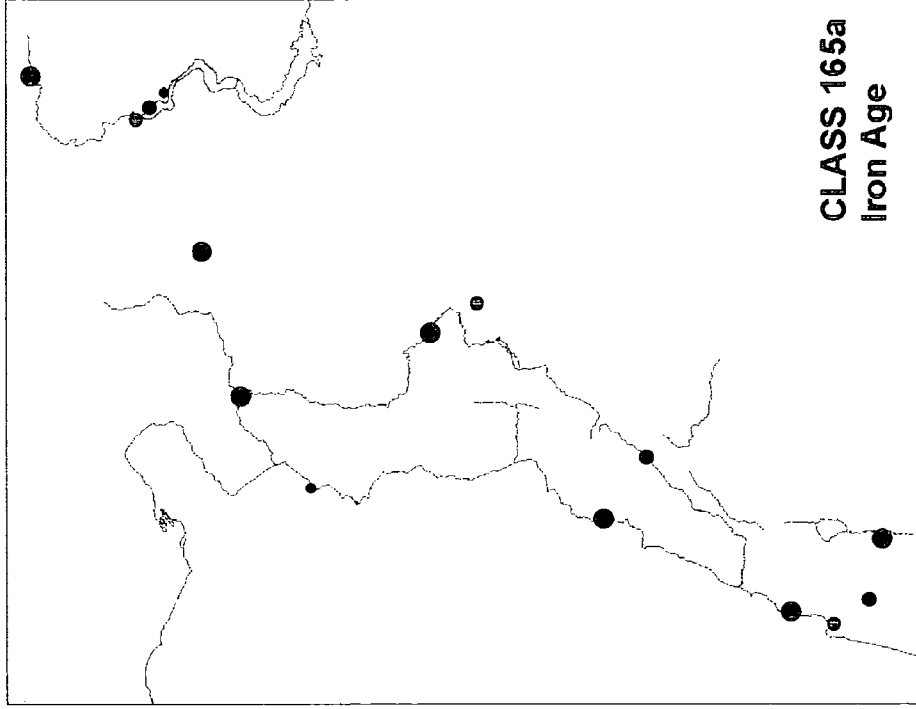
Map 76



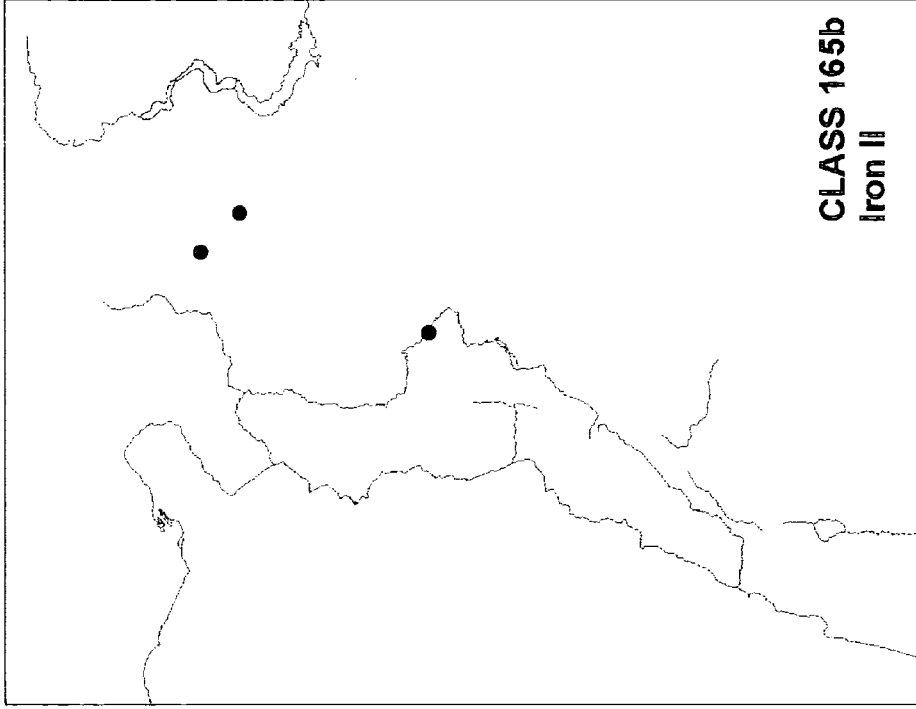
Map 77



Map 78



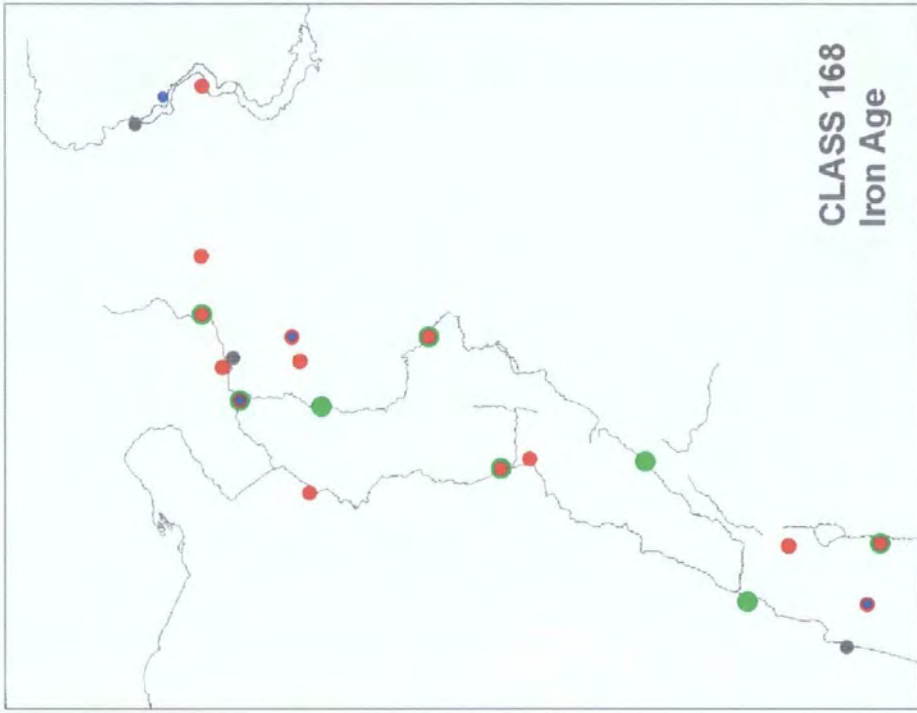
Map 79



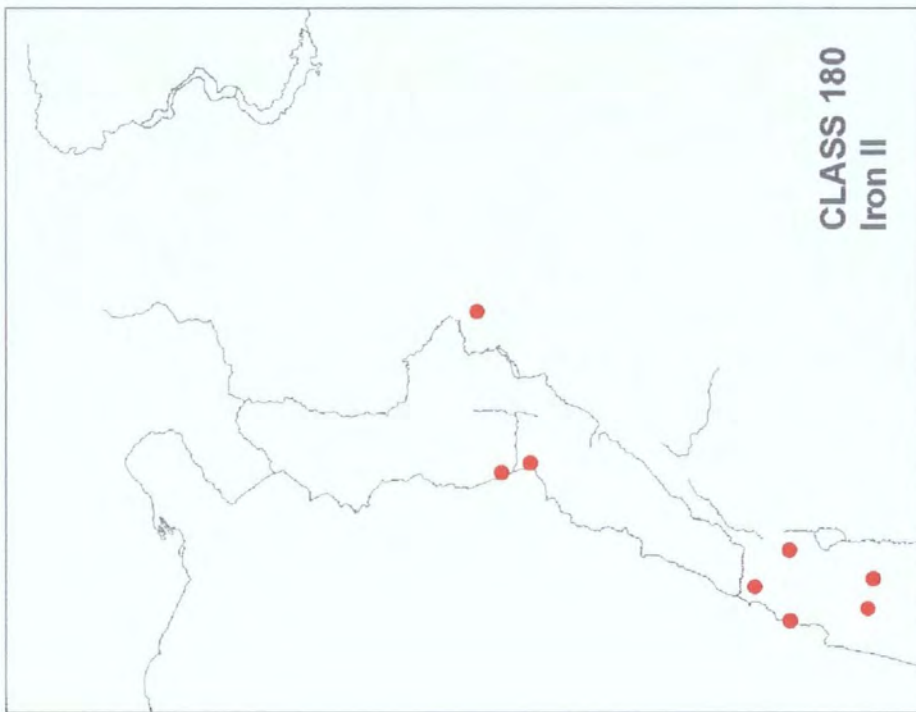
Map 80



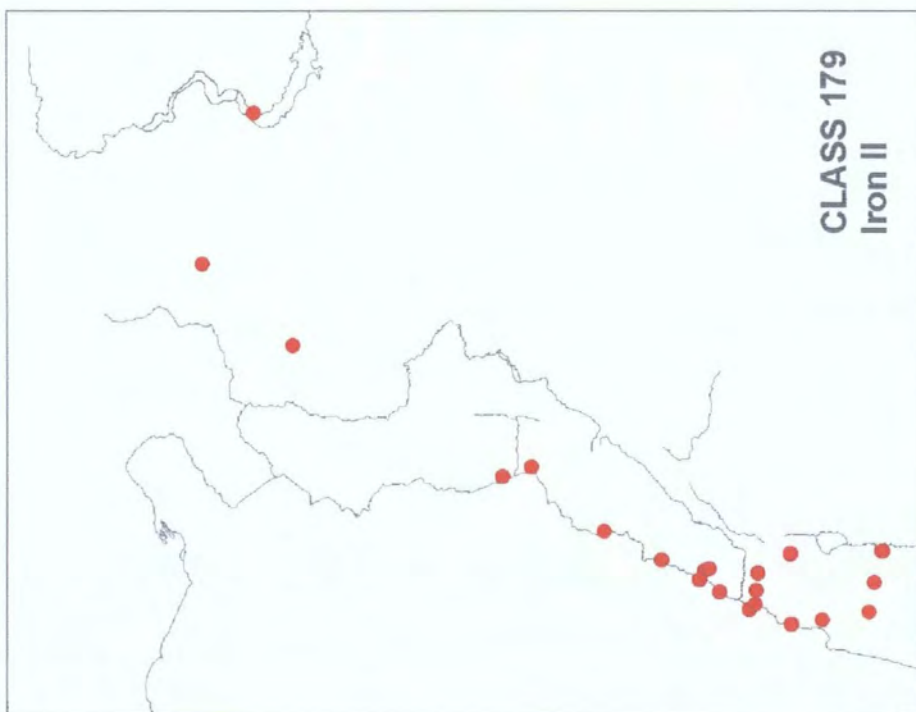
Map 81



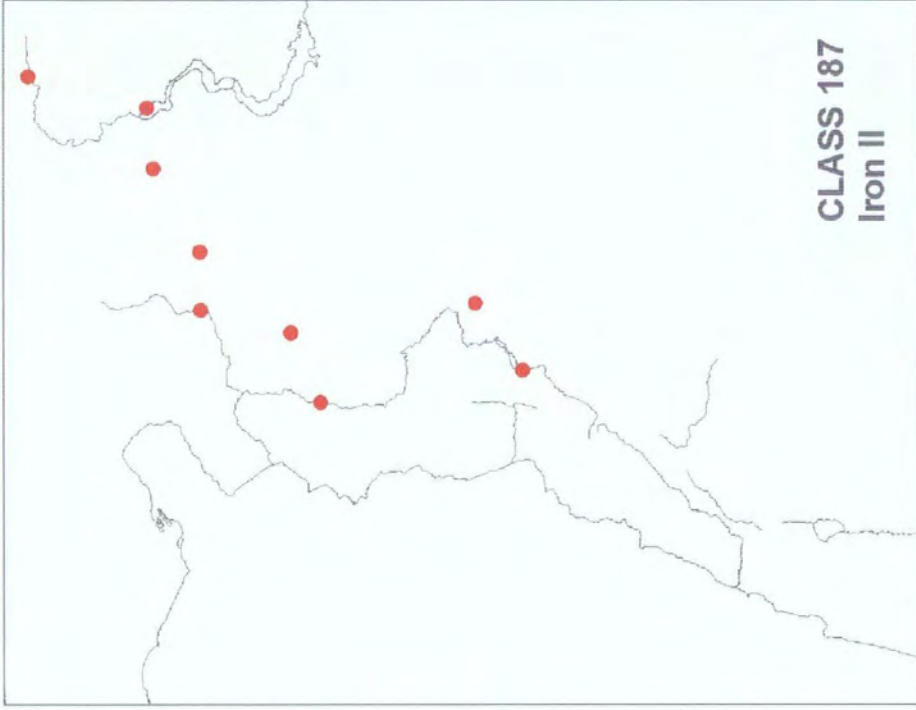
Map 82



Map 84



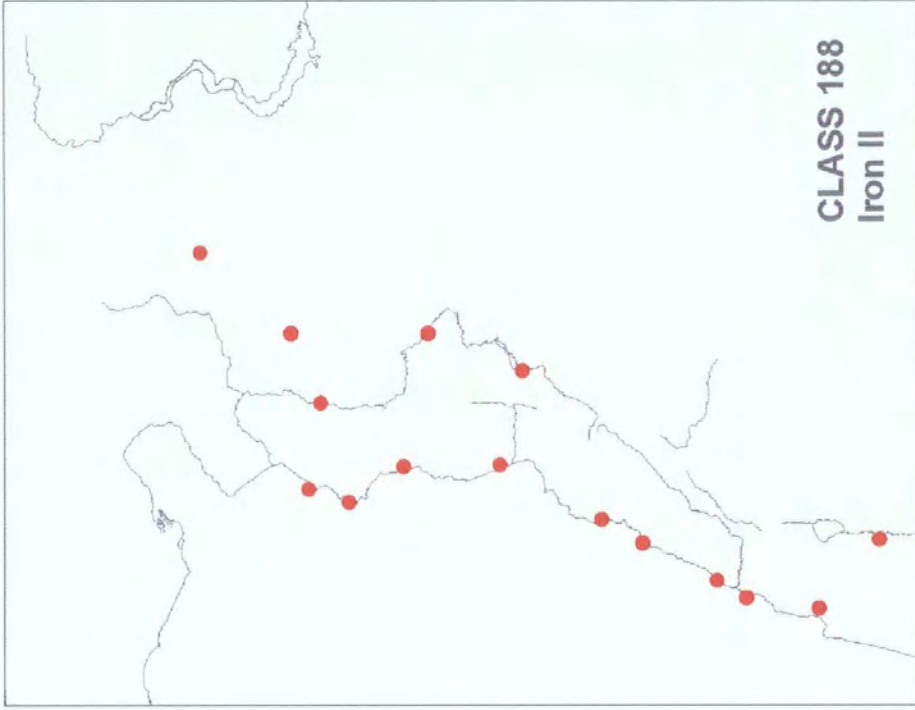
Map 83



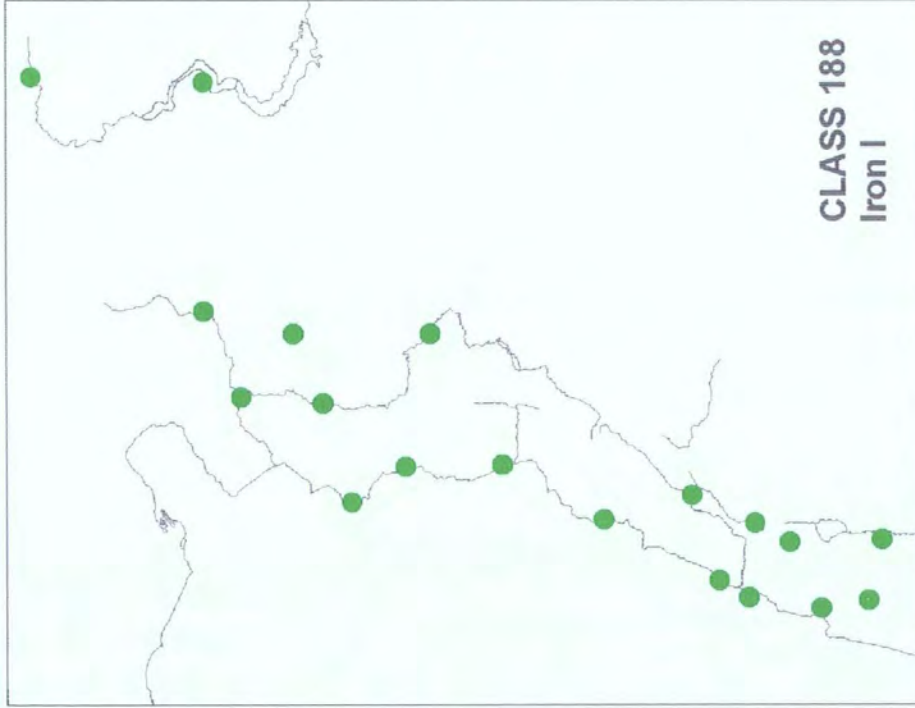
Map 86



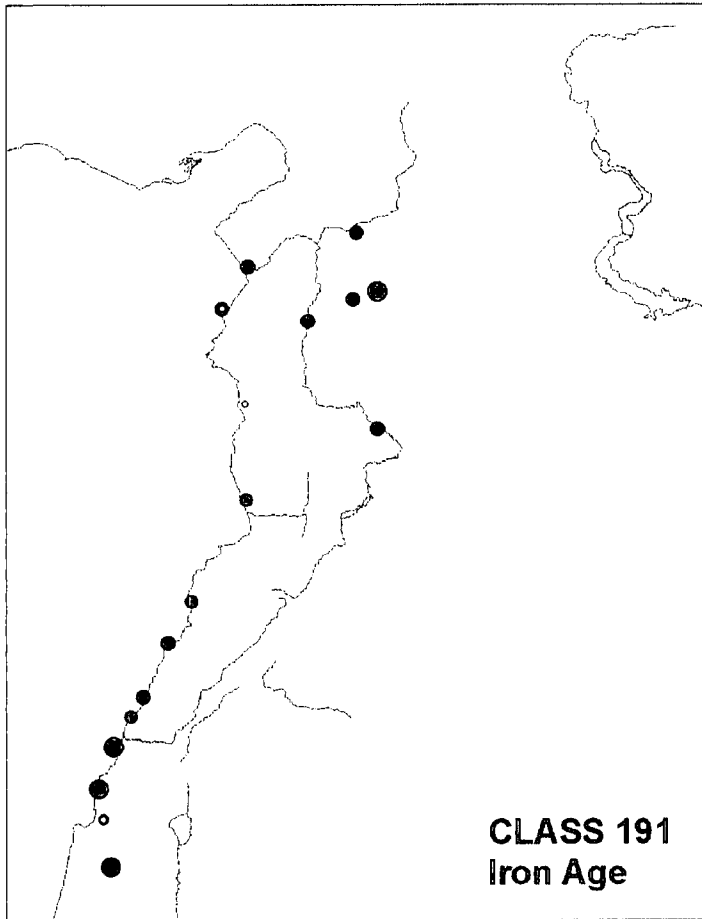
Map 85



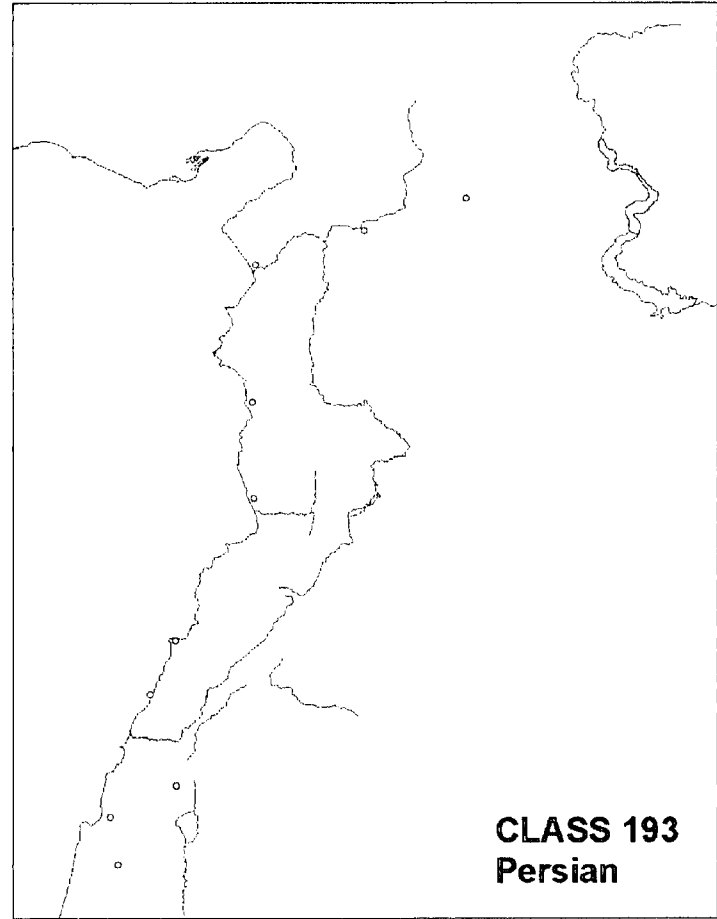
Map 88



Map 87

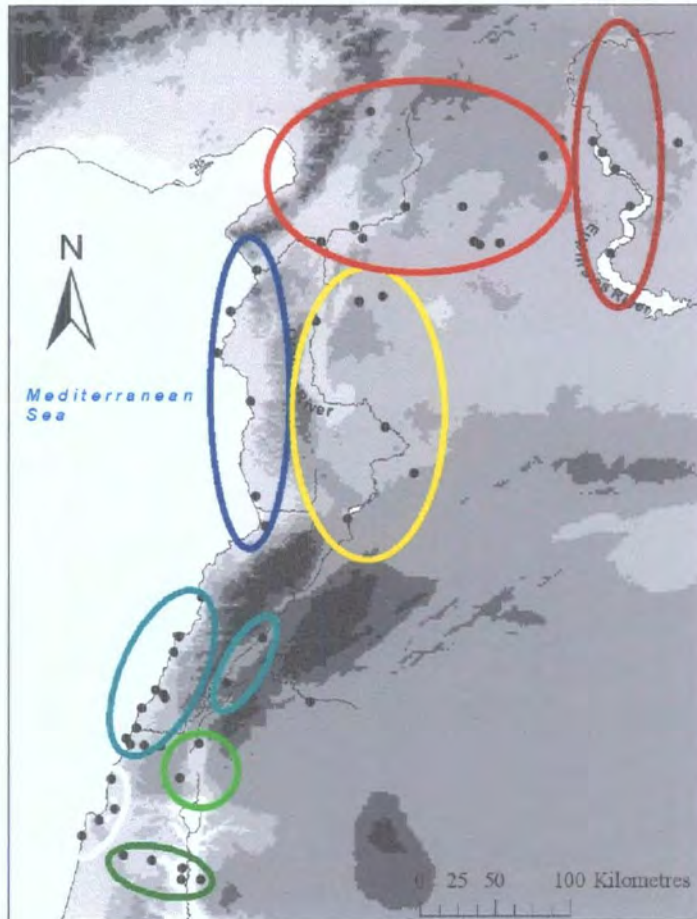


Map 89



Map 90





**Map 91. Geographic Zones used within present study**

Key to Map 91		
Colour	Zone	Approx. Modern Equiv.
Blue	1	Syrian Coast
Teal	2	Lebanese Coast
Turquoise	3	Beqa' Valley
Dark Green	4	Jezreel Valley
Green	5	Northern Palestine
White	6	Palestinian Coast
Yellow	7	Orontes Syria
Red	8	North-west Syria (Amuq)
Burgundy	9	Euphrates Syria

See **Table 7.3** for sites within each Zone

## BIBLIOGRAPHY

---

- Abdi, K. 2001. Nationalism, Politics, and the Development of Archaeology in Iran. *American Journal of Archaeology* 105(1):51-76.
- Abel, F. M., and A. Barrois. 1928. Fouilles de l'École archéologique française de Jérusalem, effectuées à Neirab du 12 septembre au 6 novembre 1927. *Syria* 9:187-206, 303-319.
- Abou Assaf, 1978-1979. Tall Ain Dara. *Archiv fur Orientforschung* 26:147-148.
- Abou Assaf, A. 1985. "Ain Dara," in *Ebla to Damascus: Art and Archaeology of Ancient Syria: An Exhibition from the Director-General of Antiquities and Museums, Syrian Arab Republic*. Edited by H. Weiss, pp. 347-350. Washington DC: Smithsonian Institution Travelling Exhibition Service.
- Abou Assaf, A. 1989/1990. Tall Ain Dara. *Archiv fur Orientforschung* 36/37:203-207.
- Abou Assaf, A. 1990. *Der Temple von 'Ain Dara. Damaszener Forschungen Band 3*. Mainz am Rhein: Philipp von Zabern.
- Abou Assaf, A. 1996. Die Kleinfunde aus 'Ain Dara. *Damaszener Mitteilungen* 9:47-111.
- Abou Assaf, A. 1997 "Ain Dara" in *The Oxford Encyclopedia of Archaeology in the Near East. Vol. 1*. Edited by E. M. Meyers, pp. 33-35. Oxford: Oxford University Press.
- Adachi, T. 1997. The Fine Carinated Bowl in the Iron Age. *Bulletin of the Ancient Orient Museum* 18:41-55.
- Adams, W. Y. 1968. Invasion, Diffusion, Evolution? *Antiquity* 42:194-215
- Adams, W. Y. 1979. On the Arguments from Ceramics to History: A Challenge Based on Evidence from Medieval Nubia. *Current Anthropology* 20:727-734.
- Aharoni, Y. 1972. The Stratification of Israelite Megiddo. *Journal of Near Eastern Studies* 31:302-311.
- Aharoni, Y. 1978. *The Archaeology of the Land of Israel*. Philadelphia: Westminster Press.
- Aharoni, Y., and R. Amiran. 1958. A New Scheme for the Sub-Division of the Iron Age in Palestine. *Israel Exploration Journal* 8:171-184.
- Aharoni, Y., Y. Yadin, and Y. Shiloh. 1993. "Megiddo," in *The New Encyclopaedia of Archaeological Excavations in the Holy Land*. Edited by E. Stern, pp. 1003-1023. New York: Simon and Schuster.
- Ahituv, S. 1984. *Canaanite Toponyms in Ancient Egyptian Documents*. Jerusalem: Magnus Press, Hebrew University.
- Åhlström, G. W. 1993. "Pharaoh Shoshenq's Campaign to Palestine," in *History and Traditions of Early Israel*. Edited by A. Lemaire and B. Otzen, pp. 1-16. Leiden.
- Akkermans, P. M. M. G., and G. M. Schwartz. 2003. *The Archaeology of Syria: From Complex Hunter-Gatherers to Early Urban Societies (ca. 16,000-300 BC)*. *Cambridge World Archaeology*. Cambridge: Cambridge University Press.
- Akurgal, E. 1955. *Phrygische Kunst*. Ankara: Türk Tarih Kurumu Basimevi.
- Akurgal, E. 1962. *The Art of the Hittites*. London: Thames and Hudson.

- Albright, W. F. 1922. The Excavations at Ascalon. *Bulletin of the American Schools of Oriental Research* 6:11-18.
- Albright, W. F. 1932. The Chalcolithic Age in Palestine. *Bulletin of the American Schools of Oriental Research* 48:10-13
- Albright, W. F. 1933. The Excavations at Tell Beit Mirsim IA: The Bronze Age Pottery of the Fourth Campaign. *Annual of the American Schools of Oriental Research* 13.
- Albright, W. F. 1934. Excavations in 1933 in Palestine, Transjordan, and Syria. *American Journal of Archaeology* 38(2):191-199.
- Albright, W. F. 1935. A Summary of Archaeological Research during 1934 in Palestine, Transjordan, and Syria. *American Journal of Archaeology* 39(1):137-148.
- Albright, W. F. 1936. Archaeological Exploration and Excavation in Palestine and Syria, 1935. *American Journal of Archaeology* 40(1):154-167.
- Albright, W. F. 1937. Further Light on the History of Israel from Lachish and Megiddo. *Bulletin of the American Schools of Oriental Research* 68:22-26.
- Albright, W. F. 1938. The Excavations at Tell Beit Mirsim II: The Bronze Age. *Annual of the American Schools of Oriental Research* 17.
- Albright, W. F. 1941-43. The Excavations at Tell Beit Mirsim III: The Iron Age. *Annual of the American Schools of Oriental Research* 21-22.
- Albright, W. F. 1949. *The Archaeology of Palestine*: Penguin Books.
- Albright, W. F. 1950. Some Oriental Glosses on the Homeric Problem. *American Journal of Archaeology* 54(1):162-176.
- Albright, W. F. 1953. Correspondence with Professor Einar Gjerstad on the Chronology of 'Cypriote' Pottery from Early Iron Levels in Palestine. *Bulletin of the American Schools of Oriental Research* 130:22.
- Albright, W. F. 1957. *From the Stone Age to Christianity: Monotheism and the Historical Process*. Baltimore.
- Albright, W. F. 1964a. *History, Archaeology and Christian Humanism*. New York: McGraw Hill.
- Albright, W. F. 1964b. The Beth Shemesh Tablet in Alphabetic Cuneiform. *Bulletin of the American Schools of Oriental Research* 173:51-53.
- Albright, W. F. 1975. "Syria, the Philistines, and Phoenicia," in *History of the Middle East and the Aegean Region c. 1380-1000 B.C.*, *Cambridge Ancient History II.2 (First Edition)*. Edited by I. E. S. Edwards, C. J. Gadd, N. G. L. Hammond, and E. Sollberger, pp. 507-536. Cambridge: Cambridge University Press.
- Albright, W. F., and N. Glueck. 1937. Archaeological Exploration and Excavation in Palestine, Transjordan, and Syria during 1936. *American Journal of Archaeology* 41(1):146-153.
- Alt, A. 1944. "Der Rhythmus des Geschichte Syriens und Palästinas im Altertum," in *Beiträge zur Arabistik, Semitistik und Islamwissenschaft*. Edited by R. Hartmann and H. Scheel, pp. 284-306. Leipzig.
- Amadasi Guzzo, M. G. 2001. Une empreinte de sceau de Tell Afis. *Orientalia* 70/3:318-324.
- Amadasi Guzzo, M. G. 2005. il frammento di stele in basalto con iscrizione. *Egitto e Vicino Oriente* 28:21-23.
- Amiran, R. 1969. *Ancient Pottery of the Holy Land: From its Beginnings in the Neolithic Period to the End of the Iron Age*. Jerusalem: MASada Press LTD.

- Anastasio, S., M. Lebeau, and M. Sauvage. 2004. *Atlas of Preclassical Upper Mesopotamia. Subartu XIII*: Brepols.
- Anderson, B. 1991. *Imagined Communities: Reflections on the Origin and Spread of Nationalism*. London: Verso.
- Anderson, W. P. 1988. *Sarepta I, The Late Bronze and Iron Age Strata of Area II*, Y. Beirut.
- Anderson, W. P. 1990. The Beginnings of Phoenician Pottery: Shape, Style, and Ceramic Technology Early Phases of the Phoenician Iron Age. *Bulletin of the American Schools of Oriental Research* 279:35-54.
- Andrae, W. 1943. *Ausgrabungen in Sendschirli V. Die Kleinfunde von Sendschirli. Mittheilungen aus den Orientalischen Sammlungen Heft 15*. Berlin: Verlag von Walter de Gruyter & Co.
- Andren, A. 1998. *Between Artifacts and Texts: Historical Archaeology in Global Perspective*. New York.
- Arie, 2006. "The Iron Age I Pottery: Levels K-5 and K-4 and an Intra-Site Spatial Analysis of the Pottery from Stratum VIA," in *Megiddo IV. The 1998-2002 Seasons, Tel Aviv University Sonia and Marco Nadler Institute of Archaeology Monograph Series Number 24*. Edited by I. Finkelstein, D. Ussishkin, and B. Halpern, pp. 191-298. Jerusalem: Institute of Archaeology, Tel Aviv University.
- Arnaud, P., E. Llopis, and M. Bonifay. 1996. Bey 027 Rapport préliminaire. *Baal* 1:98-134.
- Aro, S. 2003. "Art and Architecture," in *The Luwians, Handbuch der Orientalistik* 68. Edited by H. C. Melchert, pp. 281-337. Leiden: Brill.
- Artzy, M. 1994. Incense, Camels and Collared Rim Jars: Desert Trade Routes and Maritime Outlets in the Second Millennium. *Oxford Journal of Archaeology* 13(2):121-147.
- Artzy, M. 2007. "Tell Abu Hawam: News from the Late Bronze Age," in *The Synchronisation of Civilisations in the Eastern Mediterranean in the Second Millennium B.C. III*. Edited by M. Bietak and E. Czerny, pp. 357-366. Vienna: Verlag der Österreichischen Akademie der Wissenschaften.
- Åström, P. 1972. *The Late Cypriote Bronze Age. The Swedish Cyprus Expedition IV.1C*. Stockholm: The Swedish Cyprus Expedition.
- Aubet, M. E. 1993. *Phoenicians and the West. Politics, Colonies and Trade*. Cambridge.
- Aubet, C. 1996. Bey 002 Rapport préliminaire. *Baal* 1:60-84.
- Aubet, M. E. 2004a. "The Tyre-Al Bass Necropolis," in *Decade: A Decade of Archaeology and History in the Lebanon*. Edited by C. Doumet-Serhal, pp. 16-27. Beirut: The Lebanese British Friends of the National Museum.
- Aubet, M. E. 2004b. "Discussion and Conclusions," in *The Phoenician Cemetery at Tyre El-Bass, Excavations 1997-1999, Baal, Hors Serie 1*. Edited by M. E. Aubet, pp. 449-466. Beirut: Ministère de la Culture Direction Générale des Antiquités.
- Aubet, M. E., F. J. Nunez, and L. Trellisó. 1998-1999. The Phoenician Cemetery of Tyre-Al Bass. *Baal* 3:267-294.
- Aurenche, O. 1986. Chronique Archeologique. *Syria* 63:385-415.
- Bachelot, L. 1996. Burmarina, découverte d'une cité araméene. *Archéologia* 323:34-39.

- Bachelot, L. 1999. "Tell Shioukh Faouqani (1994-1998)," in *Archaeology of the Upper Syrian Euphrates: The Tishrin Dam Area*. Edited by G. del Olmo Lete and J.-L. Montero Fenollos, pp. 143-162. Barcelona.
- Bachelot, L., and F. M. Fales. 2005. "Introduction," in *Tell Shiyukh Fawqani 1994-1998*. Edited by L. Bachelot and F. M. Fales, pp. I-LI. Padova: Sargon Editrice e Libreria.
- Bachelot, L., F. M. Fales, M. Luciani, M. Makinson, and D. Morandi. 1995. Tell Shioukh Faouqâni, la deuxième campagne de fouille. *Orient-Express* 95/3:81-84.
- Bachelot, L., F. M. Fales, M. Luciani, M. Makinson, and D. Morandi. 1996. Mission Archéologique de Tell Shioukh Faouqâni. La troisième campagne de fouille. *Orient-Express* 96/3:80-84.
- Bachelot, L., F. M. Fales, M. Luciani, M. Makinson, and D. Morandi. 1997. La quatrième campagne de fouilles à Tell Shioukh Faouqâni (Syria). *Orient-Express* 97:79-85.
- Badre, L. 1982. "Tell el Ghassil: Tomb 1," in *Archeologie au Levant. Recueil R Saidah, Collection de la Maison de l'Orient Mediterranéen No. 12*. Edited by M. Yon, pp. 123-132. Paris: Maison de l'Orient Mediterranéen.
- Badre, L. 1983. "Les Peuples de la Mer à Ibn Hani?," in *Atti del I Congresso Internazionale di Studi Fenici e Punici, Roma, 5-10 Novembre 1979, Volume Primo*. Edited by S. Moscati, pp. 203-210. Roma: Consiglio Nazionale Delle Ricerche.
- Badre, L. 1990a. Tell Kazel, Syria: Excavations of the AUB Museum, 1985-1987, Preliminary Reports, Introduction. *Berytus* 38:10-15.
- Badre, L. 1990b. Tell Kazel, Syria: Excavations of the AUB Museum, 1985-1987, Preliminary Reports: Area II. *Berytus* 38:55-86.
- Badre, L. 1991. "Recent Phoenician Discoveries at Tell Kazel," in *Atti del 2 Congresso Internazionale di Studi Fenici e Punici, Roma, 9-14 Novembre 1987*. Edited by E. Acquaro, pp. 627-639. Roma: Consiglio Nazionale Delle Ricerche.
- Badre, L. 1992. Tel Kazel 1992. *Chronique Archeologique en Syrie* 1:127-129.
- Badre, L. 1997a. "Khaldeh" in *The Oxford Encyclopedia of Archaeology in the Near East. Vol. 3*. Edited by E. M. Meyers, pp. 290-291. Oxford: Oxford University Press.
- Badre, L. 1997b. Bey 003 Preliminary Report; Excavations of the American University of Beirut Museum 1993-1996. *Baal* 2:6-94.
- Badre, L. 1998. "Late Bronze and Iron Age Imported Pottery from the Archaeological Excavations of Urban Beirut," in *Eastern Mediterranean: Cyprus-Dodecanese-Crete, 16th-6th Cent. B.C.: Proceedings of the International Symposium, Organized by the University of Crete, Rethymnon and the Anastasios G. Leventis Foundation, Nicosia, Rethymnon, 13-16 May 1997*. Edited by V. Karageorghis and N. Stampolidis, pp. 73-83. Athens: University of Crete.
- Badre, L. 2000a. "Recently Discovered Bronze Age Temples: Middle Bronze Beirut and Late Bronze Tell Kazel," in *Proceedings of the First International Congress on the Archaeology of the Ancient Near East, Rome, May 18-23, 1998. Volume I*. Edited by P. Matthiae, A. Enea, L. Peyronel, and F. Pinnock, pp. 35-54. Rome: Università degli Studi di Roma 'La Sapienza'.
- Badre, L. 2000b. "Les Premières découvertes Phéniciennes à Beyrouth," in *Actas del IV Congreso Internacional de Estudios Fenicios Y Punicos: Cadiz, 2 al 6 de*

- Octubre de 1995 vol. III*. Edited by M. E. Aubet and M. Barthelemy, pp. 941-961. Cadiz: Servicio de Publicaciones Universidad de Cádiz.
- Badre, L. 2001-2002. The Bronze Age of Beirut: Major Results. *Aram* 13-14:1-26.
- Badre, L. 2003. "The Handmade Burnished Ware and the Contemporary Local Pottery from Tell Kazel," in *Sea Routes... Interconnections in the Mediterranean 16th-6th c. BC: Proceedings of the International Symposium Held at Rethymnon, Crete, September 29th-October 2nd, 2002*. Edited by N. Stampolidis and V. Karageorghis, pp. 83-99. Athens: University of Crete and Leventis Foundation.
- Badre, L. 2006. Tell Kazel-Simyra: A Contribution to a Relative Chronological History in the Eastern Mediterranean during the Late Bronze Age. *Bulletin of the American Schools of Oriental Research* 343:65-95.
- Badre, L., and E. Gubel. 1999-2000. Tell Kazel (Syria): Excavations of the AUB Museum, 1993-1998, Third Preliminary Report. *Berytus* 44:123-204.
- Badre, L., E. Gubel, E. Capet, and N. Panayot. 1994. Tell Kazel (Syrie): Rapport Preliminaire sur les 4eme-8eme Campagnes de Fouilles (1988-1992). *Syria* 71:259-359.
- Badre, L., M.-C. Boileau, R. Jung, and H. Mommsen. 2005. The Provenance of Aegean and Syrian-Type Pottery Found at Tell Kazel (Syria). *Ägypten und Levante* 15:15-47.
- al-Bahloul, K., A. Barro, and L. d'Alfonso. 2005. "Area H: The Iron Age Cremation Cemetery," in *Tell Shiyukh Fawqani 1994-1998*. Edited by L. Bachelot and F. M. Fales, pp. 997-1048. Padova: Sargon Editrice e Libreria.
- Bahn, P. G. Editor. 1996. *The Cambridge Illustrated History of Archaeology*. Cambridge: Cambridge University Press.
- Bahrani, Z. 1998. "Conjuring Mesopotamia: Imaginative Geography and a World Past," in *Archaeology Under Fire: Nationalism, Politics and Heritage in the Eastern Mediterranean and Middle East*. Edited by L. Meskell, pp. 159-174. London.
- Bahrani, Z. 2000. "The Extraterrestrial Orient: Colonizing Mesopotamia in Space and Time," in *Landscapes: Territories, Frontiers and Horizons in the Ancient Near East: Papers Presented to the XLIV Rencontre Assyriologique Internationale, Venezia, 7-11 July 1997; Part III Landscape in Ideology, Religion, Literature and Art, History of the Ancient Near East/ Monographs - III/3*. Edited by L. Milano, S. de Martino, F. M. Fales, and G. B. Lanfranchi, pp. 5-10. Padova.
- Baines, J. 1996. "Contextualizing Egyptian Representations of Society and Ethnicity," in *The Study of the Ancient Near East in the Twenty-First Century*. Edited by J. S. Cooper and G. M. Schwartz, pp. 339-384. Winona Lake, Indiana: Eisenbrauns.
- Baker, J. L. 2006. The Funeral Kit: A Newly Defined Canaanite Mortuary Practice Based on the Middle and Late Bronze Age Tomb Complex at Ashkelon. *Levant* 38:1-32.
- Balensi, J. 1985. Revising Tell Abu Hawam. *Bulletin of the American Schools of Oriental Research* 257:65-74.
- Balensi, J., M. D. Herrera, and M. Artzy. 1993. "Abu Hawam, Tell," in *The New Encyclopedia of Archaeological Excavations in the Holy Land*. Edited by E. Stern, pp. 7-14. New York: Simon & Schuster.

- Baram, A. 1994. A Case of Imported Identity: the Modernizing Secular Ruling Elites of Iraq and the Concept of Mesopotamian Inspired Territorial Nationalism. *Poetics Today* 15:279-319.
- Baramki, D. C. 1958. A Late Bronze Age Tomb at Sarafend, Ancient Sarepta. *Berytus* 12:129-142.
- Baramki, D. C. 1961. Preliminary Report on the Excavations at Tell el Ghassil. *Bulletin du Musée de Beyrouth* 16:87-102.
- Baramki, D. C. 1964. Second Preliminary Report on the Excavations at Tell el Ghassil. *Bulletin du Musée de Beyrouth* 17:47-103.
- Baramki, D. C. 1966. Third Preliminary Report on the Excavations at Tell el Ghassil. *Bulletin du Musée de Beyrouth* 19:29-49.
- Barkay, G. 1992. "The Iron Age II-III," in *The Archaeology of Ancient Israel*. Edited by A. Ben-Tor, pp. 302-373. London.
- Barnett, R. D. 1963. Hamath and Nimrud: Shell Fragments from Hamath and the Provenance of the Nimrud Ivories. *Iraq* 25:81-85.
- Barnett, R. D. 1975. "The Sea Peoples," in *History of the Middle East and the Aegean Region c. 1380-1000 B.C., Cambridge Ancient History II.2 (First Edition)*. Edited by I. E. S. Edwards, C. J. Gadd, N. G. L. Hammond, and E. Sollberger, pp. 359-378. Cambridge: Cambridge University Press.
- Barnett, R. D. 1987. "Layard's Influence on British Orientalism in the 19th Century," in *Austen Henry Layard Tra l'Oriente e Venezia*. Edited by F. M. Fales and B. J. Hickey, pp. 177-182. Roma.
- Barrett, J. C. 1988. Fields of Discourse: Reconstituting a Social Archaeology. *Critique of Anthropology* 7:5-16.
- Barrett, J. C. 1994. *Fragments from Antiquity: An Archaeology of Social Life in Britain, 2900-1200 BC*. Oxford: Blackwell.
- Barro, A. 2002. "Excavations in the Eastern Part of the Palace (Operation H)," in *Excavating Qatna, I. Preliminary Report on the 1999 and 2000 Campaigns of the Joint Syrian-Italian-German Archaeological Research Project at Tell Mishrifeh, Documents d'Archeologie Syrienne IV*. Edited by M. al-Maqdissi, M. Luciani, D. Morandi Bonacossi, M. Novák, and P. Pfälzner, pp. 111-122. Damascus.
- Barth, F. 1969. *Ethnic Groups and Boundaries: The Social Organisation of Culture Difference*. Boston: Little, Brown and Company.
- Bartl, K. 1995a. Some Remarks on Early Iron Age in Eastern Anatolia. *Anatolica* 21:205-212.
- Bartl, K. 1995b. "Das Ende der Spätbronzezeit und das "dunkle Zeitalter" im westlichen Vorderasien," in *Zwischen Euphrat und Indus. Aktuelle Forschungsprobleme in der Vorderasiatischen Archäologie*. Edited by K. Bartl, R. Bernbeck, and M. Heinz, pp. 193-208. Hildesheim: Georg Olms Verlag.
- Bass, G. F. 1987. Oldest Known Shipwreck Reveals Splendors of the Bronze Age. *National Geographic Magazine* 172/6:693-733.
- Bass, G. F., C. Pulak, D. Collon, and J. Weinstein. 1989. The Bronze Age Shipwreck at Ulu Burun (Kas): 1986 Campaign. *American Journal of Archaeology* 93(1):1-29.
- Batiuk, S., T. P. Harrison, and L. Pavlish. 2005. "The Ta'yinat Survey, 1999-2002," in *The Amuq Valley Regional Projects Volume 1: Surveys in the Plain of Antioch and Orontes Delta, Turkey, 1995-2002, Oriental Institute*

- Publications 131*. Edited by K. A. Yener, pp. 171-192. Chicago: The Oriental Institute of the University of Chicago.
- Bauer, A. A. 1998. Cities of the Sea: Maritime Trade and the Origin of Philistine Settlement in the Early Iron Age Southern Levant. *Oxford Journal of Archaeology* 17(2):149-168.
- Baurin, M. P. 1923. La Citadelle d'Alep. *Syria* 4:180.
- Baxter, M. J. 1992. "Archaeological uses of the biplot - a neglected technique?," in *Computer Applications and Quantitative Methods in Archaeology 1991*, BAR International Series S577. Edited by G. Lock and J. Moffett, pp. 141-148. Oxford: Tempus Reparatum.
- Baxter, M. J. 1994. *Exploratory Multivariate Analysis in Archaeology*. Edinburgh: Edinburgh University Press.
- Baxter, M. J. 2003. *Statistics in Archaeology*. Arnold Publications in Statistics. London: Arnold.
- Beazley, J. D. 1963. *Attic Red-Figure Vase Painters*. Oxford: Clarendon Press.
- Bell, C. 2006. *The Evolution of Long Distance Trading Relationships across the LBA/Iron Age Transition on the Northern Levantine Coast. Crisis, Continuity and Change - a study based on imported ceramics, bronze and its constituent metals*. BAR International Series 1574. Oxford: Archaeopress.
- Ben Ami, D. 2001. The Iron Age I at Tel Hazor in Light of the Renewed Excavations. *Israel Exploration Journal* 51:148-170.
- Ben Ami, D. 2006. Early Iron Age Cult Places - New Evidence from Tel Hazor. *Tel Aviv* 33(2):121-133.
- Ben Dov, R. 2002. "The Late Bronze Age 'Mycenaean' Tomb," in *Dan II. A Chronicle of the Excavations and the Late Bronze Age 'Mycenaean' Tomb, Annual of the Nelson Glueck School of Biblical Archaeology*. Edited by A. Biran and R. Ben-Dov, pp. 33-208. Jerusalem: Hebrew Union College.
- Ben Tor, A. 1993a. "Hazor," in *The New Encyclopaedia of Archaeological Excavations in the Holy Land*. Edited by E. Stern, A. Lewinson-Gilboa, and J. Aviram, pp. 594-606. New York: Simon and Schuster.
- Ben Tor, A. 1993b. "Qiri, Tel," in *The New Encyclopaedia of Archaeological Excavations in the Holy Land*. Edited by E. Stern, pp. 1228-1229. New York: Simon and Schuster.
- Ben Tor, A. 1997. "The Yigael Yadin Memorial Excavations at Hazor, 1990-1993: Aims and Preliminary Results," in *The Archaeology of Israel: Constructing the Past, Interpreting the Present, Journal for the Study of the Old Testament Supplement Series 237*. Edited by N. A. Silberman and D. Small, pp. 62-81. Sheffield: Sheffield Academic Press.
- Ben Tor, A. 2000. Hazor and Chronology of Northern Israel: A Reply to Israel Finkelstein. *Bulletin of the American Schools of Oriental Research* 317:9-15.
- Ben Tor, A. 2003. Notes and News - Excavations and Surveys: Tel Hazor, 2003. *Israel Exploration Journal* 53:218-223.
- Ben Tor, A. 2004. Notes and News. Excavations and Surveys. Tel Hazor, 2004. *Israel Exploration Journal* 54:230-235.
- Ben Tor, A., R. Bonfil, Y. Garfinkel, R. Greenberg, A. M. Maeir, and A. Mazar. 1997. *Hazor V: An Account of the Fifth Season of Excavation, 1968*. Jerusalem: Hebrew University of Jerusalem: Israel Exploration Society.
- Ben Tor, A., and D. Ben-Ami. 1998. Hazor and the Archaeology of the Tenth Century B.C.E. *Israel Exploration Journal* 48:1-37.



- Ben Yehuda, N. 1995. *The Masada Myth: Collective Memory and Mythmaking in Israel*. Madison, WI: University of Wisconsin.
- Ben Yehuda, N. 2002. *Sacrificing Truth: Archaeology and the Myth of Masada*. Amherst, NY: Humanity Books.
- Bentley, M. 1999. *Modern Historiography. An Introduction*. London: Routledge.
- Bernhardsson, M. T. 2005. *Reclaiming a Plundered Past. Archaeology and Nation Building in Modern Iraq*. Austin, TX: University of Texas Press.
- Betancourt, P. 2000. "The Aegean and the Origin of the Sea Peoples," in *The Sea Peoples and Their World: A Reassessment*. Edited by E. D. Oren, pp. 297-304. Philadelphia: University of Pennsylvania.
- Bettles, E. 2003a. Carinated-Shoulder Amphorae from Sarepta, Lebanon: A Phoenician Commodity and its Intra-Regional Distribution. *Archaeology and History in the Lebanon* 17:60-79.
- Bettles, E. 2003b. *Phoenician Amphora Production and Distribution in the Southern Levant: a multi-disciplinary investigation into carinated-shoulder amphorae of the Persian period (539-332 BC)*. BAR International Series 1183. Oxford: Archaeopress.
- Bieber, A. M., D. W. Brooks, G. Harbottle, and E. V. Sayre. 1976. Application of Multivariate Techniques to Analytical Data on Aegean Ceramics. *Archaeometry* 18(1):59-74.
- Bienkowski, P. 1982. Some Remarks on the Practice of Cremation in the Levant. *Levant* 14:80-89.
- Bigazzi, C. 2002. Afis 2000-2001. Area E: le strutture conservative del Ferro I. *Egitto e Vicino Oriente* 25:38-41.
- Bikai, Patricia M. 1978a. The Late Phoenician Pottery Complex and Chronology. *Bulletin of the American Schools of Oriental Research* 229:47-56.
- Bikai, Patricia M. 1978b. *The Pottery of Tyre*. Warminster: Aris and Phillips.
- Bikai, Patricia M. 1983. "The Imports from the East," in *Palaeopahos-Skales: an Iron Age Cemetery in Cyprus*. Edited by V. Karageorghis, pp. 396-406. Konstanz: Universitätsverlag Konstanz.
- Bikai, Patricia M. 1987. *The Phoenician Pottery of Cyprus*. Nicosia: Levantis Foundation.
- Bikai, Patricia M. 1992. "Phoenician Tyre," in *The Heritage of Tyre. Essays on the History, Archaeology, and Preservation of Tyre*. Edited by M. S. Joukowsky, pp. 45-54. Dubuque, Iowa: Kendall Hunt Publishing Company.
- Bikai, Patricia M. 1994. "The Phoenicians and Cyprus," in *Proceedings of the International Symposium, Cyprus in the Eleventh Century B.C*. Edited by V. Karageorghis, pp. 31-37. Nicosia.
- Bikai, Patricia M., and Pierre M. Bikai. 1987. Tyre at the End of the Twentieth Century. *Berytus* 35:67-96.
- Bikai, Pierre M. 1992a. "The Land of Tyre," in *The Heritage of Tyre. Essays on the History, Archaeology, and Preservation of Tyre*. Edited by M. S. Joukowsky, pp. 13-24. Dubuque, Iowa: Kendall Hunt Publishing Company.
- Bikai, Pierre M. 1992b. "History of Excavations," in *The Heritage of Tyre. Essays on the History, Archaeology, and Preservation of Tyre*. Edited by M. S. Joukowsky, pp. 25-36. Dubuque, Iowa: Kendall Hunt Publishing Company.
- Binford, L. 1962. Archaeology as Anthropology. *American Antiquity* 28:217-225.
- Binford, L. 1965. Archaeological Systematics and the Study of Cultural Process. *American Antiquity* 31(2.1):203-210.
- Binford, L. 1972. *An Archaeological Perspective*. New York: Seminar Press.

- Biran, A. 1982. The Temenos at Dan. *Eretz Israel* 16:15-43.
- Biran, A. 1989a. "The Collared-rim Jars and the Settlement of the Tribe of Dan," in *Recent Excavations in Israel: Studies in Iron Age Archaeology, Annual of the American Schools of Oriental Research* 49. Edited by S. Gitin and W. G. Dever, pp. 71-96. Indiana: American Schools of Oriental Research.
- Biran, A. 1989b. The Evidence for Metal Industry at Dan. *Eretz Israel* 20:120-134 (Hebrew).
- Biran, A. 1993. "Dan," in *The New Encyclopaedia of Archaeological Excavations in the Holy Land*. Edited by E. Stern, pp. 323 New York: Simon and Schuster.
- Biran, A. 1994. *Biblical Dan*. Jerusalem: Israel Exploration Society.
- Biran, A. 1996a. "A Chronicle of the Excavations 1966-1992," in *Dan I, Annual of the Nelson Glueck School of Biblical Archaeology*. Edited by A. Biran, D. Ilan, and R. Greenberg, pp. 7-63. Jerusalem: Nelson Glueck School of Biblical Archaeology.
- Biran, A. 1996b. High Places at the Gates of Dan? *Eretz Israel* 25:55-58 (Hebrew).
- Biran, A. 1996c. "Introduction," in *Dan I, Annual of the Nelson Glueck School of Biblical Archaeology*. Edited by A. Biran, D. Ilan, and R. Greenberg, pp. 1-5. Jerusalem: Nelson Glueck School of Biblical Archaeology.
- Biran, A. 1999. Two Bronze Plaques and the Hussot of Dan. *Israel Exploration Journal* 49:43-54.
- Biran, A. 2001. "The High Places of Biblical Dan," in *Studies in the Archaeology of the Iron Age in Israel and Jordan, Journal for the Study of the Old Testament Supplement Series 331*. Edited by A. Mazar and V. T. Mathias, pp. 148-155. Sheffield: Sheffield Academic Press.
- Biran, A. 2002. "A Chronicle of the Excavations," in *Dan II. A Chronicle of the Excavations and the Late Bronze Age 'Mycenaean' Tomb, Annual of the Nelson Glueck School of Biblical Archaeology*. Edited by A. Biran and R. Ben-Dov, pp. 3-32. Jerusalem: Hebrew Union College.
- Birmingham, J. 1963. The Chronology of Some Early and Middle Iron Age Cypriot Sites. *American Journal of Archaeology* 67(1):15-42.
- Blaylock, S. R. 1999. "Iron Age Pottery from Tille Hoyuk, South-Eastern Turkey," in *Iron Age Pottery in Northern Mesopotamia, Northern Syria and South-Eastern Anatolia*. Edited by A. Hausleiter and A. Reiche, pp. 263-286. Munster.
- Boardman, J. 1959. Greek Potters at al Mina? *Anatolian Studies* 9:163-169.
- Boardman, J. 1965. Tarsus, Al Mina and Greek Chronology. *Journal of Hellenic Studies* 85:5-15.
- Boardman, J. 1980. *The Greeks Overseas, Their Early Colonies and Trade*. London: Thames and Hudson.
- Boardman, J. 1990. Al Mina and History. *Oxford Journal of Archaeology* 9:169-190.
- Boardman, J. 2002. "Greeks and Syria; Pots and People," in *Greek Settlements in the Eastern Mediterranean and the Black Sea*. Edited by G. R. Tsetskhladze and A. M. Snodgrass, pp. 1-16. Oxford: BAR International Series 1062.
- Boese, J. 1986-1987. Excavations at Tell Sheikh Hassan, Preliminary Report on the Year 1987 Campaign in the Euphrates Valley. *Les Annales Archeologiques Arabes Syriennes* 36/37:67-101.
- Boese, J. 1988-1989. Excavations at Tell Sheikh Hassan. A Preliminary Report on the 1988 Campaign in the Euphrates Valley. *Les Annales Archeologiques Arabes Syriennes* 38/39:158-189.

- Boese, J. 1992. Ausgrabungen in Tell Sheikh Hassan 1992. *Chronique Archeologique en Syrie* 1:40-42.
- Boese, J. 1995. *Ausgrabungen in Tell Sheikh Hassan I. Vorläufige Berichte über die Grabungskampagnen 1984-1990 und 1992-1994. Schriften zur vorderasiatischen Archäologie; Bd. 5.* Saarbrücken: Saarbrücker Druckerei und Verlag.
- Bonatz, D. 1993. Some Considerations on the Material Culture of Coastal Syria in the Iron Age. *Egitto e Vicino Oriente* 16:123-157.
- Bonatz, D. 1998. "Imported Pottery (Area E1)," in *Tell Afis, Siria : scavi sull'acropoli 1988-1992 = The 1988-1992 excavations on the Acropolis, Ricerche di archeologia del Vicino Oriente; 1.* Edited by S. M. Cecchini and S. Mazzoni, pp. 211-229. Pisa: Edizioni ETS.
- Bonatz, D. 2000. "Syro-Hittite Funerary Monuments: A Phenomenon of Tradition or Innovation?" in *Essays on Syria in the Iron Age., Ancient Near Eastern studies. Supplement 7.* Edited by G. Bunnens, pp. 189-210. Louvain: Peeters Press.
- Bordreuil, P. 1982. Deux Epigraphes Pheniciennes Provenant des Fouilles de Tell Rachidieh. *Annales d'Histoire et d'Archéologie* 1:137-140.
- Bordreuil, P. 1993. *Les Royaumes Araméens de Syrie. Syrie: Mémoire et civilisation.* Paris.
- Bordreuil, P. 2003. A Propos des Jarres Inscrites de Tell Rachidieh. *Archaeology and History in the Lebanon* 17:52-57.
- Bordreuil, P. 2004. "A Propos des Jarres Inscrites de Tell Rachidieh," in *Decade: A Decade of Archaeology and History in the Lebanon.* Edited by C. Doumet-Serhal, pp. 80-87. Beirut: The Lebanese British Friends of the National Museum.
- Bordreuil, P., and A. Caquot. 1979. Les textes en cunéiformes alphabétiques découverts en 1977 à Ibn Hani. *Syria* 56:295-315.
- Bordreuil, P., and D. Pardee. 1989. *Ras Shamra-Ougarit V. La Trouvaille Épigraphique de l'Ougarit 1. Concordance.* Paris: Editions Recherche sur les Civilisations.
- Bordreuil, P., and D. Pardee. 1995. "L'épigraphie ougaritique: 1973-1993," in *Les Pays d'Ougarit autour de 1200 av. J.-C. Histoire et archéologie. Actes du Colloque International Paris, 28 juin - 1er juillet 1993, Ras Shamra-Ougarit XI.* Edited by M. Yon, M. Szyner, and P. Bordreuil, pp. 37-32. Paris: Éditions Recherche sur les Civilisations.
- Bounni, A. 1991. "La Syrie, Chypre et l'Égée d'après les fouilles de Ras Ibn Hani," in *Proceedings of an International Symposium "The Civilizations of the Aegean and their Diffusion in Cyprus and the Eastern Mediterranean, 2000-600 B.C." 18-24 September 1989.* Edited by V. Karageorghis, pp. 105-110. Larnaca: Pierides Foundation.
- Bounni, A. 1997. "Kazel, Tell," in *The Oxford Encyclopedia of Archaeology in the Near East. Vol. 3.* Edited by E. M. Meyers, pp. 275-276. Oxford: Oxford University Press.
- Bounni, A., E. Lagarce, J. Lagarce, and N. Saliby. 1976a. Rapport préliminaire sur la première campagne de fouilles (1975) à Ibn Hani (Syrie). *Syria* 53:233-279.
- Bounni, A., E. Lagarce, and N. Saliby. 1976b. La Première campagne de fouille à Ras Ibn Hani. *Les Annales Archeologiques Arabes Syriennes* 26:27-64 (Arabic).

- Bounni, A., E. Lagarce, J. Lagarce, and N. Saliby. 1978. Rapport préliminaire sur la deuxième campagne de fouilles (1976) à Ibn Hani (Syrie). *Syria* 55:233-301.
- Bounni, A., J. Lagarce, E. Lagarce, N. Saliby, and L. Badre. 1979. Rapport préliminaire sur la troisième campagne de fouilles (1977) à Ibn Hani (Syrie). *Syria* 56:217-291.
- Bounni, A., J. Lagarce, E. Lagarce, N. Saliby, L. Badre, P. Leriche, and M. Touma. 1981. Rapport préliminaire sur la quatrième campagne de fouilles (1978) à Ibn Hani (Syrie). *Syria* 58:215-299.
- Bounni, A., E. Lagarce, and J. Lagarce. 1998. *Ras Ibn Hani, I. Le palais nord du Bronze récent. Fouilles 1979-1995, synthèse préliminaire. Bibliothèque Archéologique et Historique: 151*. Beirut: Institut Français d'Archéologie du Proche-Orient.
- Bourdieu, P. 1977. *Outline of a Theory of Practice*. Cambridge: Cambridge University Press.
- Bourdieu, P. 1984. *Distinction: A Social Critique of the Judgement of Taste* (trans. R. Nice). Cambridge, MA.
- Bourke, S. J. 1993. The Transition from the Middle to the Late Bronze Age in Syria: The Evidence from Tell Nebi Mend. *Levant* 25:155-195.
- Bourke, S. J. 1997. Pre-Classical Pella in Jordan: A Conspectus of Ten Years' Work (1985-1995). *Palestine Exploration Quarterly* 129(2):94-115.
- Bourke, S. J., R. T. Sparks, K. N. Sowada, and L. D. Mairs. 1994. Preliminary Report on the University of Sydney's Fourteenth Season of Excavations at Pella (Tabaqat Fahl) in 1992. *Annual of the Department of Antiquities of Jordan* 38:81-126.
- Bourke, S. J., R. T. Sparks, K. N. Sowada, P. McLaren, and L. D. Mairs. 1998. Preliminary Report on the University of Sydney's Sixteenth and Seventeenth Seasons of Excavations at Pella (Tabaqat Fahl) in 1994/1995. *Annual of the Department of Antiquities of Jordan* 42:179-211.
- Bourke, S. J., R. T. Sparks, P. McLaren, K. N. Sowada, L. D. Mairs, J. Meadows, T. Hikade, and W. Reade. 2003. Preliminary Report on the University of Sydney's Eighteenth and Nineteenth Seasons of Excavations at Pella (Tabaqat Fahl) in 1996/1997. *Annual of the Department of Antiquities of Jordan* 47:335-388.
- Bouzek, J. 1996. Bey 069 Sondage A. *Baal* 1:135-147.
- Bowser, B. J. 2000. From Pottery to Politics: An Ethnoarchaeological Study of Political Factionalism, Ethnicity, and Domestic Pottery Style in the Ecuadorian Amazon. *Journal of Archaeological Method and Theory* 7/3:219-248.
- Braemer, F. 1982. *L'Architecture Domestique du Levant à l'Âge du Fer*. Paris: éditions Recherches sur les Civilisations.
- Braemer, F. 1986. La ceramique a engobe rouge de l'âge du Fer à Bassit. *Syria* 63:221-246.
- Braemer, F. 1997. "Architecture domestique de l'âge du fer en Syrie du Nord," in *Les Maisons dans la Syrie antique du IIIe millenaire aux debuts de l'Islam*. Edited by C. Castel, pp. 61-71. Beirut: IFAPO.
- Braidwood, R. J. 1937. *Mounds in the Plain of Antioch: An Archaeological Survey*. University of Chicago. *Oriental Institute publications, 48*. Chicago: The University of Chicago Press.
- Braidwood, R. J. 1940. Report on Two Sondages on the Coast of Syria, South of Tartous. *Syria* 21:183-226.

- Braidwood, R. J., and L. S. Braidwood. 1960. *Excavations in the Plain of Antioch, Vol. 1. University of Chicago Oriental Institute Publications, 61*. Chicago: University of Chicago.
- Braudel, F. 1972. *The Mediterranean and the Mediterranean World in the Age of Philip II*. Glasgow.
- Braudel, F. 1980. *On History*. Chicago: University of Chicago Press.
- Breasted, J. H. 1906a. *Ancient Records of Egypt v. 3 The Nineteenth Dynasty*. Chicago: University of Chicago Press.
- Breasted, J. H. 1906b. *Ancient Records of Egypt v. 4 The Twentieth through the Twenty-Sixth Dynasties*. Chicago: University of Chicago Press.
- Breasted, J. H. 1933. "The Anatolian Hittite Expedition," in *The Oriental Institute, The University of Chicago Survey 12*. Edited by J. H. Breasted, pp. 265-309. Chicago: University of Chicago Press.
- Breisach, E. 1983. *Historiography: Ancient, Medieval, & Modern*. Chicago: University of Chicago Press.
- Briend, J. and J.-B. Humbert. 1980. *Tell Keisan, 1971-1976: Une cite phenicienne en Galilee*, Paris: J Gabalda.
- Bruins, H. J., J. van der Plicht, and A. Mazar. 2003a. C14 Dates from Tel Rehov: Iron Age Chronology, Pharaohs, and Hebrew Kings. *Science* 300:315-318.
- Bruins, H. J., J. van der Plicht, and A. Mazar. 2003b. Response to Comment on "C14 Dates from Tel Rehov: Iron Age Chronology, Pharaohs, and Hebrew Kings". *Science* 302: 568c.
- Bruins, H. J., J. van der Plicht, D. Ilan, and E. Werker. 2005. "Iron-Age 14C Dates from Tel Dan: A High Chronology," in *The Bible and Radiocarbon Dating: Archaeology, Text and Science*. Edited by T. E. Levy and T. Higham, pp. 323-336. London: Equinox.
- Brumfiel, E. M. 2000. "On the Archaeology of Choice. Agency Studies as a Research Stratagem," in *Agency in Archaeology*. Edited by M.-A. Dobres and J. E. Robb, pp. 249-255. London: Routledge.
- Bryce, T. R. 1992. Lukka Revisited. *Journal of Near Eastern Studies* 51:121-130.
- Bryce, T. R. 2003. "History," in *The Luwians, Handbuch der Orientalistik 68*. Edited by H. C. Melchert, pp. 27-127. Leiden: Brill.
- Buccellati, G. 1967. *Cities and Nations of Ancient Syria: An Essay on Political Institutions with Special Reference to the Israelite Kingdoms*. Rome: Istituto di Studi Del Vicino Oriente Università di Roma.
- Budge, E. A. W. 1914. *Assyrian Sculptures in the British Museum: Reign of Ashurnasir-pal, B.C. 885-860*. London: British Museum.
- Buhl, M.-L. 1983. *Sukas VII: The Near Eastern Pottery and Objects of Other Materials from the Upper Strata. Publications of the Carlsberg Expedition to Phoenicia 9*. Copenhagen: Munksgaard.
- Buhl, M.-L. 1992. "Hamath," in *The Anchor Bible Dictionary. Vol. III*. Edited by D. N. Freedman, pp. 33-36. New York: Doubleday.
- Buhl, M.-L. 1996. "The Objects of Pottery and Other Materials," in *Sukas X: The Bronze and Early Iron Age Remains at the Southern Harbour, Publications of the Carlsberg Expedition to Phoenicia 12. Historisk-filosofiske skrifter (Kongelige Danske Videnskabernes Selskab) 17*. Edited by P. J. Riis, J. Jensen, M.-L. Buhl, and B. Otzen, pp. 25-61. Copenhagen: Munksgaard.
- Bulliet, R. W. 1990. *The Camel and the Wheel*. New York: Columbia University Press.

- Bunimovitz, S. 1990. Problems in the Ethnic Identification of the Philistine Culture. *Tel Aviv* 17:210-222.
- Bunimovitz, Š., and A. Faust. 2001. Chronological Separation, Geographical Segregation, or Ethnic Demarcation? Ethnography and the Iron Age Low Chronology. *Bulletin of the American Schools of Oriental Research* 322:1-10.
- Bunnens, G. 1979. *L'expansion phénicienne en Méditerranée*. Bruxelles.
- Bunnens, G. 1983. "La Distinction Entre Phéniciens et Puniques Chez Les Auteurs Classiques," in *Atti del I Congresso Internazionale di Studi Fenici e Punici, Roma, 5-10 Novembre 1979, Volume Primo*. Edited by S. Moscati, pp. 233-238. Roma: Consiglio Nazionale Delle Ricerche.
- Bunnens, G. 1985. "Le luxe phénicien d'après les inscriptions royales assyriennes," in *Phoenicia and Its Neighbours, Studia Phoenicia* 3. Edited by E. Gubel and E. Lipinski, pp. 121-133. Leuven: Uitgeverij Peeters.
- Bunnens, G. 1990a. "Tell Ahmar After Fifty Years," in *Tell Ahmar: 1988 Season, Abr-Nahrain Supplement Series 2*. Edited by G. Bunnens, pp. 1-10. Leuven: Orientaliste.
- Bunnens, G. 1990b. "Area A. Excavations on the Acropolis," in *Tell Ahmar: 1988 Season, Abr-Nahrain Supplement Series 2*. Edited by G. Bunnens, pp. 11-24. Leuven: Orientaliste.
- Bunnens, G. 1995. "Hittites and Aramaeans at Til Barsip: A Reappraisal," in *Immigration and Emigration within the Ancient Near East, Orientalia Lovaniensia Analecta* 65. Edited by K. van Lerberghe and A. Schoors, pp. 19-27. Leuven: Peeters.
- Bunnens, G. 1997a. Carved Ivories from Til-Barsip. *American Journal of Archaeology* 101(3):435-450.
- Bunnens, G. 1997b. "Til Barsip under Assyrian Domination," in *Assyria 1995: Proceedings of the 10th Anniversary Symposium of the Neo-Assyrian Text Corpus Project Helsinki, September 7-11, 1995*. Edited by S. Parpola and R. M. Whiting, pp. 17-28. Helsinki: The Neo-Assyrian Text Corpus Project.
- Bunnens, G. 1998. Tell Ahmar/Til Barsip, the ninth and tenth seasons (1996-1997). *Orient-Express* 1998:27-30.
- Bunnens, G. 1999. "Aramaean, Hittite and Assyrian in the Upper Euphrates Valley," in *Archaeology of the Upper Syrian Euphrates, The Tishrin Dam Area: Proceedings of the International Symposium Held at Barcelona, January 28th-30th 1998*. Edited by G. del Olmo Lete and J.-L. Montero Fenollos, pp. 605-624. Barcelona: Editorial AUSA.
- Bunnens, G. 2000a. "Syria in the Iron Age: Problems and Definition," in *Essays on Syria in the Iron Age., Ancient Near Eastern studies. Supplement* 7. Edited by G. Bunnens, pp. 3-19. Louvain: Peeters Press.
- Bunnens, G. 2000b. "Géographie historique de la région du barrage de Tishrin," in *La Djéziré et l'Euphrate Syriens de la Protohistoire à la fin du IIe Millénaire av. J.-C. Tendances dans l'Interprétation Historique des Données Nouvelles, Subartu VII*. Edited by O. Rouault and M. Wäfer, pp. 299-308: Brepols.
- Bunnens, G. 2001. Tell Ahmar/Til Barsip, the eleventh, twelfth and thirteenth seasons (1998-2000). *Orient-Express* 2001:65-68.
- Bunnens, G. 2006. *A New Luwian Stele and the Cult of the Storm-God at Til Barsip - Masuwari. Publications de la Mission archéologique de l'Université de Liège en Syrie. Tell Ahmar II*. Louvain: Peeters.

- Burdajewicz, M. 1990. *The Aegean Sea Peoples and Religious Architecture in the Eastern Mediterranean at the Close of the Late Bronze Age*. BAR International Series 558. Oxford: BAR.
- Busink, T. A. 1970. *Der Tempel von Jerusalem*. Leiden.
- Butcher, K. 2003. *Roman Syria and the Near East*: The J. Paul Getty Museum.
- Campbell, S. 1995. "Death for the Living in the late Neolithic in north Mesopotamia," in *The Archaeology of Death in the Ancient Near East, Oxbow Monographs 51*. Edited by S. Campbell and A. Green, pp. 29-34. Oxford: Oxbow Books.
- Canby, J. V. 1985. "Guzana (Tell Halaf)," in *Ebla to Damascus: Art and Archaeology of Ancient Syria: An Exhibition from the Director-General of Antiquities and Museums, Syrian Arab Republic*. Edited by H. Weiss, pp. 332-338. Washington DC: Smithsonian Institution Travelling Exhibition Service.
- Capet, E. 2003. Tell Kazel (Syrie), Rapport Preliminaire sur les 9e - 17e Campagnes de Fouilles (1993-2001) du Musée de l'Universite Americaine de Beyrouth, Chantier II. *Berytus* 47:63-121.
- Capet, E., and E. Gubel. 2000. "Tell Kazel: Six Centuries of Iron Age Occupation (c. 1200-612 B.C.)," in *Essays on Syria in the Iron Age., Ancient Near Eastern studies. Supplement 7*. Edited by G. Bunnens, pp. 425-457. Louvain: Peeters Press.
- Carrière, B., and A. Barrois. 1927. Fouilles de l'École archéologique française de Jérusalem, effectuées à Neirab du 24 septembre au 5 novembre 1926. *Syria* 8:126-142, 201-212.
- Carter, E., and A. Parker. 1995. "Pots, People and The Archaeology of Death in Northern Syria and Southern Anatolia in the latter half of the Third Millennium BC," in *The Archaeology of Death in the Ancient Near East, Oxbow Monographs 51*. Edited by S. Campbell and A. Green, pp. 96-116. Oxford: Oxbow Books.
- Carter, J. B. 1995. "Ancestor Cult and the Occasion of Homeric Performance," in *The Age of Homer: A Tribute to Emily Townsend Vermeule*. Edited by J. B. Carter and S. P. Morris, pp. 285-312. Austin: University of Texas Press.
- Casana, J., and T. J. Wilkinson. 2005. "Appendix A: Gazetteer of Sites," in *The Amuq Valley Regional Projects Volume 1: Surveys in the Plain of Antioch and Orontes Delta, Turkey, 1995-2002, Oriental Institute Publications 131*. Edited by K. A. Yener, pp. 203-280. Chicago: The Oriental Institute of the University of Chicago.
- Caubet, A. 1992. "Reoccupation of the Syrian Coast after the Destruction of the 'Crisis Years'," in *The Crisis Years: The 12th Century B.C. From Beyond the Danube to the Tigris*. Edited by W. A. Ward and M. S. Joukowsky, pp. 123-131. Dubuque: Kendall/Hunt.
- Caubet, A. 2002. "Le Travail de l'ivoire au Levant, de la fin de l'Âge du Bronze au début de l'âge du Fer: Continuité et rupture," in *Die Nahöstlichen Kulturen und Griechenland an der Wende vom 2. zum 1. Jarhtausend v. Chr.* Edited by E. A. Braun-Holzinger and H. Matthaus, pp. 109-122. Mohnesee-Wamel: Bibliopolis.
- Caubet, A. 2003. "The Case of Ugarit and Carchemish: A Contrast," in *Symbiosis, Symbolism, and the Power of the Past. Canaan, Ancient Israel, and Their Neighbours from the Late Bronze Age through Roman Palaestina*. Edited by W. G. Dever and S. Gitin, pp. 17-22. Winona Lake, IN: Eisenbrauns.

- Cauvin, J. 1968. *Les outillages néolithiques de Byblos et du littoral libanais*. Paris.
- Cecchini, S. M. 1988. Il sondaggio stratigrafico. *Egitto e Vicino Oriente* 10/2:85-91.
- Cecchini, S. M. 1993. Tell Afis (Siria). *Orient-Express* 1993:10-11.
- Cecchini, S. M. 1994. Tell Afis (Syrie): Travaux de la mission archeologique italienne en 1994. *Orient-Express* 1994:84-86.
- Cecchini, S. M. 1998. "Architecture, Pottery and Finds (Area G)," in *Tell Afis, Siria : scavi sull'acropoli 1988-1992 = The 1988-1992 excavations on the Acropolis, Ricerche di archeologia del Vicino Oriente ; 1*. Edited by S. M. Cecchini and S. Mazzoni, pp. 273-365. Pisa: Edizioni ETS.
- Cecchini, S. M. 2000a. "Un batiment mysterieux sur l'acropole de Tell Afis," in *Proceedings of the First International Congress on the Archaeology of the Ancient Near East, Rome, May 18-23, 1998. Volume I*. Edited by P. Matthiae, A. Enea, L. Peyronel, and F. Pinnock, pp. 199-212. Rome: Universita degli Studi di Roma 'La Sapienza'.
- Cecchini, S. M. 2000b. "The Textile Industry in Northern Syria During the Iron Age According to the Evidence of the Tell Afis Excavations," in *Essays on Syria in the Iron Age., Ancient Near Eastern studies. Supplement 7*. Edited by G. Bunnens, pp. 211-233. Louvain: Peeters Press.
- Cecchini, S. M. 2002. Afis 2000-2001. Area N: presentazione e cronologia. *Egitto e Vicino Oriente* 25:47-53.
- Cecchini, S. M. 2005. Tell Afis, Siria (2002-2004) Area N: presentazione e cronologia. *Egitto e Vicino Oriente* 28:77-82.
- Cecchini, S. M., and S. Mazzoni. 1998. "Preface," in *Tell Afis, Siria : scavi sull'acropoli 1988-1992 = The 1988-1992 excavations on the Acropolis, Ricerche di archeologia del Vicino Oriente ; 1*. Edited by S. M. Cecchini and S. Mazzoni, pp. 1-9. Pisa: Edizioni ETS.
- Chaaya, A. 2000. "L'evolution et le changement cultural a Tell 'Arqa apres l'invasion de Tiglath-Pileser III (Niveaux 10-9)," in *Proceedings of the First International Congress on the Archaeology of the Ancient Near East, Rome, May 18-23, 1998. Volume I*. Edited by P. Matthiae, A. Enea, L. Peyronel, and F. Pinnock, pp. 213-222. Rome: Universita degli Studi di Roma 'La Sapienza'.
- Chapman, S. V. 1972. A Catalogue of Iron Age Pottery from the Cemeteries of Khirbet Silm, Joya, Qraye and Qasmieh of South Lebanon. *Berytus* 21:55-194.
- Chapman, W. 1989. "Toward an Institutional History of Archaeology: British Archaeologists and Allied Interests in the 1860s," in *Tracing Archaeology's Past: The Historiography of Archaeology, Publications in Archaeology*. Edited by A. L. Christensen, pp. 151-162. Carbondale, IL.
- Chartier, R. 1988. *Culture History: Between Practices and Representations*. Ithaca, New York.
- Chavalas, M. W. 1992. "Ancient Syria: A Historical Sketch," in *New Horizons in the Study of Ancient Syria*. Edited by M. W. Chavalas and J. L. Hayes, pp. 1-21. Malibu: Undena Publications.
- Chesson, M. S. 2007. "Remembering and Forgetting in Early Bronze Age Mortuary Practices on the Southeastern Dead Sea Plain, Jordan," in *Performing Death. Social Analyses of Funerary Traditions in the Ancient Near East and Mediterranean, Oriental Institute Seminars 3*. Edited by N. Laneri, pp. 109-140. Chicago: Chicago University Press.



- Chevalier, N. 2002. *La Recherche Archéologique Française au Moyen-Orient 1842-1947*. Paris: Éditions Recherche sur les Civilisations.
- Childe, V. G. 1929. *The Danube in Prehistory*. Oxford.
- Chiti, B. 2005. Tell Afis, Siria (2002-2004) Area E4b nord: Bronzo Tardo II - Ferro I. *Egitto e Vicino Oriente* 28:62-69.
- Christakis, K. S. 1999. Pithoi and Food Storage in Neopalatial Crete: A Domestic Perspective. *World Archaeology* 31(1):1-20.
- Christensen, A. L. 1989. "The Past Is Still Alive: The Immediacy Problem and Writing the History of Archaeology," in *Tracing Archaeology's Past: The Historiography of Archaeology, Publications in Archaeology*. Edited by A. L. Christensen, pp. 163-168. Carbondale and Edwardsville, IL.
- Ciafardini, P. 1988. Tell Afis: un insediamento del ferro nella Regione di Idlib. *Egitto e Vicino Oriente* 10/2:5-23.
- Cichoński, O. 2000. "Methods and Aims of Dendrochronology; Dating Wooden Objects from the Eastern Mediterranean in the Second Millennium B.C. (Absolute Chronology IV)," in *The Synchronisation of Civilisations in the Eastern Mediterranean in the Second Millennium B.C.* Edited by M. Bietak, pp. 62-67. Vienna: Verlag der Österreichischen Akademie der Wissenschaften.
- Clairmont, C. 1955. Greek Pottery from the Near East. *Berytus* 11:85-141.
- Clairmont, C. 1956-1957. Greek Pottery from the Near East. *Berytus* 12:1-34.
- Clark, E. A. 2004. *History, Theory, Text: Historians and the Linguistics Turn*. Harvard University Press: Cambridge, MA.
- Cline, E. H. 2003. "Trade and Exchange in the Levant," in *Near Eastern Archaeology: A Reader*. Edited by S. Richard, pp. 360-366. Winona Lake, Indian: Eisenbrauns.
- Coldstream, N. 1968. *Greek Geometric Pottery: A Survey of Ten Local Styles and their Chronology*. London: Methuen & Co Ltd.
- Coldstream, N. 1989. "Early Greek Visitors to Cyprus and the Eastern Mediterranean," in *Cyprus and the East Mediterranean in the Iron Age. Proceedings of the Seventh British Museum Classical Colloquium, London, April 1988*. Edited by V. Tatton-Brown, pp. 90-96. London: Trustees of the British Museum.
- Coldstream, N. 1998. "The First Exchanges between Euboeans and Phoenicians: Who took the initiative?," in *Mediterranean Peoples in Transition: Thirteenth to Early Tenth Centuries BCE, in Honour of Trude Dothan*. Edited by S. Gitin, A. Mazar, and E. Stern, pp. 353-360. Jerusalem: Israel Exploration Society.
- Coldstream, N. 2003. Some Aegean Reactions to the Chronological Debate in the Southern Levant. *Tel Aviv* 30:247-258.
- Coldstream, N., and P. M. Bikai. 1988. Early Greek Pottery in Tyre and Cyprus: Some preliminary comparisons. *Report of the Department of Antiquities Cyprus* 1988(2):35-43.
- Coldstream, N., and A. Mazar. 2003. Greek Pottery from Tel Rehov and Iron Age Chronology. *Israel Exploration Journal* 53:29-48.
- Collombier, A.-M. 1987. "Céramique grecque et échanges en Méditerranée orientale: Chypre et la côte Syro-Phénicienne (fin VIIIe - fin IVe siècles av. J.-C.)," in *Phoenicia and the East Mediterranean in the First Millennium B.C., Studia Phoenicia* 5. Edited by E. Lipinski, pp. 239-248. Leuven: Uitgeverij Peeters.

- Conder, C. R. 1881. Kadesh. *Quarterly Statement: Palestine Exploration Fund* 1881:163-175.
- Conder, C. R. 1882. Notes: Kadesh on Orontes. *Quarterly Statement: Palestine Exploration Fund* 1882:155-157.
- Conder, C. R. 1883. Notes: Kadesh on Orontes. *Quarterly Statement: Palestine Exploration Fund* 1883:100.
- Contenau, G. 1920. Mission archéologique à Sidon (1914). *Syria* 1:108-154.
- Contenau, G. 1923. Deuxième mission archéologique à Sidon (1920). *Syria* 4:261-281.
- Contenau, G. 1924. Deuxième mission archéologique à Sidon (1920). *Syria* 5:123-134.
- Cool, H. E. M., and M. J. Baxter. 1999. Peeling the Onion: an approach to comparing vessel glass assemblages. *Journal of Roman Archaeology* 12:72-100.
- Cook, R. M. 1972. *Greek Painted Pottery*. London.
- Courbin, P. 1972. Rapport sur la Fouille de Ras el Bassit. *Les Annales Archeologiques Arabes Syriennes* 22:45-61.
- Courbin, P. 1973. Ras el Bassit Rapport sur la Campagne de 1972. *Les Annales Archeologiques Arabes Syriennes* 23:25-38.
- Courbin, P. 1974. Ras el Bassit, Al Mina & Tell Sukas. *Revue Archeologique* 1974:174-178.
- Courbin, P. 1974-1975. Rapport sur la 4eme Campagne de Fouille (1974) a Ras el Bassit. *Les Annales Archeologiques Arabes Syriennes* 24-25:59-71.
- Courbin, P. 1976. Rapport sur la 5 eme Campagne de Fouille a Ras el Bassit. *Les Annales Archeologiques Arabes Syriennes* 26:63-69.
- Courbin, P. 1977-1978. Rapport sur la Sixieme Campagne de Fouille (1976) a Ras el Bassit (Syrie). *Les Annales Archeologiques Arabes Syriennes* 27-28:29-40.
- Courbin, P. 1978. Une nouvelle fouille francaise sur la cote syrienne. *Archeologia* 116:48-62.
- Courbin, P. 1981-1982. Ras al-Bassit. *Archiv fur Orientforschung* 28:231-232.
- Courbin, P. 1982a. "Une Assiette Cycladique a Ras el Bassit," in *Archeologie au Levant. Recueil R Saidah, Collection de la Maison de l'Orient Meditteraneen No. 12*. Edited by M. Yon, pp. 193-204. Paris: Maison de l'Orient Meditteraneen.
- Courbin, P. 1982b. Gourdes. *Revue Archeologique* 1982:9-25.
- Courbin, P. 1983. Bassit. *Les Annales Archeologiques Arabes Syriennes* 33(2):119-127.
- Courbin, P. 1986. Bassit. *Syria* 63:175-220.
- Courbin, P. 1986-1987. Rapport sur la Xeme et Derniere Campagne a Ras el Bassit. *Les Annales Archeologiques Arabes Syriennes* 36-37:107-120.
- Courbin, P. 1990a. "Fragments d'amphores protogeometriques grecques a Bassit," in *Resurrecting the Past: A Joint Tribute to Adnan Bounni*. Edited by P. Matthiae, M. Van Loon, and H. Weiss, pp. 49-64. Istanbul: Nederlands Historisch-Archaeologisch Instituut te Istanbul.
- Courbin, P. 1990b. "Bassit-Posidaion in the Early Iron Age," in *Greek Colonists and Native Populations. Proceedings of the First Australian Congress of Classical Archaeology held in honour of Emeritus Professor A. D. Trendall, Sydney 9-14 July 1985*. Edited by J.-P. Descoeudres, pp. 503-509. Oxford: Clarendon Press.
- Courbin, P. 1993a. *Fouilles de Bassit. Tombes du Fer*. Paris.

- Courbin, P. 1993b. Fragments d'amphores protogeometriques grecques á Bassit. *Hesperia* 62:95-113.
- Crielaard, J. P. 1999a. "Production, Circulation and Consumption of Early Iron Age Greek Pottery (eleventh to seventh centuries BC)," in *The Complex Past of Pottery. Production, Circulation and Consumption of Mycenaean and Greek Pottery (Sixteenth to Early Fifteenth Centuries B.C.)*. Edited by J. P. Crielaard, V. Stissi, and G. J. van Wijngaarden, pp. 49-81. Amsterdam: J. C. Gieben.
- Crielaard, J. P. 1999b. "Early Iron Age Greek Pottery in Cyprus and North Syria: a consumption-oriented approach," in *The Complex Past of Pottery. Production, Circulation and Consumption of Mycenaean and Greek Pottery (Sixteenth to Early Fifteenth Centuries B.C.)*. Edited by J. P. Crielaard, V. Stissi, and G. J. van Wijngaarden, pp. 261-290. Amsterdam: J. C. Gieben.
- Cross, F. M., and T. O. Lambdin. 1960. A Ugaritic Abecedary and the Origins of the Proto-Canaanite Alphabet. *Bulletin of the American Schools of Oriental Research* 160:21-26.
- Culican, W. 1959. Aspects of Phoenician Settlement in the West Mediterranean. *Abr Nahrain* 1:36-55.
- Culican, W. 1970. Phoenician Oil Bottles and Tripod Bowls. *Berytus* 19:5-18.
- Culican, W. 1973. The Graves at Tell er-Reqeish. *Australian Journal of Biblical Archaeology* 2:66-106.
- Culican, W. 1975. Sidonian Bottles. *Levant* 7:145-150.
- Culican, W. 1975-1976. Some Phoenician Masks and other Terracottas. *Berytus* 24:47-88.
- Culican, W. 1982. "The Repertoire of Phoenician Pottery," in *Phönizier im Westen: die Beiträge des Internationalen Symposiums über "Die Phönizische Expansion im Westlichen Mittelmeerraum" in Köln vom 24. bis 27. April, 1979, Madrider Beiträge ; Bd. 8*. Edited by H. G. Niemeyer, pp. 45-82. Mainz am Rhein: P. von Zabern.
- Culican, W. 1991. "Phoenicia and Phoenician Colonization," in *The Assyrian and Babylonian Empires and other States of the Near East, from the Eighth to the Sixth Centuries B.C., Cambridge Ancient History III.2 (Second Edition)*. Edited by J. Boardman, I. E. S. Edwards, N. G. L. Hammond, E. Sollberger, and C. B. F. Walker, pp. 461-546. Cambridge: Cambridge University Press.
- Curvers, H. H. 2001-2002. The Lower Town of Beirut (1200-300 BC). A Preliminary Synthesis. *Aram* 13-14:51-72.
- Curvers, H. H., and B. Stuart. 1996. Bey 008 The 1994 Results. *Baal* 1:228-234.
- Curvers, H. H., and B. Stuart. 1997. The BCD Infrastructure Archaeology Project, 1995. *Baal* 2:167-205.
- Curvers, H. H., and B. Stuart. 1998-1999. The BCD Archaeology Project, 1996-1999. *Baal* 3:13-30.
- Curvers, H. H., and B. Stuart. 2004. "Beirut Central District Archaeology Project 1994 - 2003," in *Decade: A Decade of Archaeology and History in the Lebanon*. Edited by C. Doumet-Serhal, pp. 248-265. Beirut: The Lebanese British Friends of the National Museum.
- Dalley, S. 2000. "Shamshi-ilu, Language and Power in the Western Assyrian Empire," in *Essays on Syria in the Iron Age., Ancient Near Eastern studies. Supplement 7*. Edited by G. Bünnens, pp. 79-88. Louvain: Peeters Press.
- D'Amore, P. 1998a. "Architecture, Pottery and Finds (Area L)," in *Tell Afis, Siria: scavi sull'acropoli 1988-1992 = The 1988-1992 excavations on the Acropolis,*

- Ricerche di archeologia del Vicino Oriente; 1.* Edited by S. M. Cecchini and S. Mazzoni, pp. 371-381. Pisa: Edizioni ETS.
- D'Amore, P. 1998b. "The Iron Age Clay Figurines," in *Tell Afis, Siria: scavi sull'acropoli 1988-1992 = The 1988-1992 excavations on the Acropolis, Ricerche di archeologia del Vicino Oriente ; 1.* Edited by S. M. Cecchini and S. Mazzoni, pp. 415-425. Pisa: Edizioni ETS.
- D'Amore, P. 2002. Afis 2000-2001. Area A. *Egitto e Vicino Oriente* 25:9-12.
- D'Amore, P. 2005. Tell Afis, Siria (2002-2004) Area A1: il settore centrale. *Egitto e Vicino Oriente* 28:17-21.
- Daniel, G. 1967. *The Origins and Growth of Archaeology*: Penguin Books.
- Darnton, R. 1984. *The Great Cat Massacre and Other Episodes in French Cultural History*. London: Allen Lane.
- Daviau, P. M. M. 2001. "Family Religion: Evidence for the Paraphernalia of the Domestic Cult," in *The World of the Aramaeans II: Studies in History and Archaeology in Honour of Paul-Eugene Dion, Journal for the Study of the Old Testament Supplement Series 325*. Edited by P. M. M. Daviau, J. W. Wevers, and M. Weigl, pp. 199-229. Sheffield: Sheffield Academic Press.
- Davies, P. 1992. *In Search of Ancient Israel*. Sheffield: Sheffield Academic Press.
- Day, P., and D. Wilson. 2004. "Ceramic Change and the Practice of Eating and Drinking in Early Bronze Age Crete," in *Food, Cuisine and Society in Prehistoric Greece, Sheffield Studies in Aegean Archaeology 5*. Edited by P. Halstead and J. Barrett, pp. 45-62. Oxford: Oxbow Books.
- Dayagi-Mendels, M. 1993. *Perfumes and Cosmetics in the Ancient World*. Jerusalem: The Israel Museum.
- Dayagi-Mendels, M. 1999. *Drink and Be Merry: Wine and Beer in Ancient Times*. Jerusalem: The Israel Museum.
- Dayagi-Mendels, M. 2002. *The Akhziv Cemeteries: The Ben Dor Excavations, 1941-1944. Israel Antiquities Authority Reports 15*. Jerusalem: Israel Antiquities Authority.
- Degli Esposti, M. 1998. "I livelli del Ferro I-II. Architettura e materiali (Area E2)," in *Tell Afis, Siria : scavi sull'acropoli 1988-1992 = The 1988-1992 excavations on the Acropolis, Ricerche di archeologia del Vicino Oriente ; 1.* Edited by S. M. Cecchini and S. Mazzoni, pp. 231-269. Pisa: Edizioni ETS.
- Del Vesco, P. 2002. Afis 2000-2001. Area M. *Egitto e Vicino Oriente* 25:45-47.
- Del Vesco, P., V. Melchiorri, and I. Oggiano. 2005. Tell Afis, Siria (2002-2004) Area J. *Egitto e Vicino Oriente* 28:76-77.
- Desborough, V. 1952. *Protogeometric Pottery*. Oxford: Clarendon Press.
- Desborough, V. 1957. A Group of Vases from Amathus. *Journal of Hellenic Studies* 77(2):212-219.
- Descœudres, J.-P., and R. A. Kearsley. 1983. Greek Pottery at Veii: Another Look. *Annual of the British School at Athens* 78:9-54.
- Dever, W. G. 1980. The Impact of the 'New Archaeology' on Syro-Palestinian Archaeology. *Bulletin of the American Schools of Oriental Research* 242:15-29.
- Dever, W. G. 1992. "The Late Bronze-Early Iron I Horizon in Syria-Palestine: Egyptians, Canaanites, "Sea Peoples" and Proto-Israelites," in *The Crisis Years: The 12th Century B.C. From Beyond the Danube to the Tigris*. Edited by W. A. Ward and M. S. Joukowsky, pp. 99-110. Iowa: Kendall Hunt.
- Dever, W. G. 1993. What Remains of the House that Albright Built? *Biblical Archaeologist* 56:25-35.

- Dever, W. G. 1995a. The Death of a Discipline. *Biblical Archaeology Review* 21:50-55.
- Dever, W. G. 1995b. Ceramics, Ethnicity, and the Question of Israel's Origins. *Biblical Archaeologist* 58:200-213.
- Dever, W. G. 1997a. "Keisan, Tell" in *The Oxford Encyclopedia of Archaeology in the Near East. Vol. 3*. Edited by E. M. Meyers, pp. 278-279. Oxford: Oxford University Press.
- Dever, W. G. 1997b. "Philology, Theology, and Archaeology: What Kind of History Do We Want, and What is Possible?" in *The Archaeology of Israel: Constructing the Past, Interpreting the Present, Journal for the Study of the Old Testament Supplement Series 237*. Edited by N. A. Silberman and D. Small, pp. 290-310. Sheffield: Sheffield Academic Press.
- Dever, W. G. 1997c. "Abu Hawam, Tell," in *The Oxford Encyclopedia of Archaeology in the Near East. Vol. 1*. Edited by E. M. Meyers, pp. 9. Oxford: Oxford University Press.
- Dever, W. G. 2000. "Imaging Ancient Israel: Archaeology, Social History, and the Sociology of Knowledge," in *Proceedings of the First International Congress on the Archaeology of the Ancient Near East, Rome, May 18-23, 1998. Volume I*. Edited by P. Matthiae, A. Enea, L. Peyronel, and F. Pinnock, pp. 323-332. Rome: Universita degli Studi di Roma 'La Sapienza'.
- Dever, W. G. 2003. Visiting the Real Gezer: A Reply to Israel Finkelstein. *Tel Aviv* 30:259-282.
- Dhorme, E. 1938. Les Fouilles Francaises a Till Barsip. *Journal des Savants* 36:109-120, 155-164.
- Dhorme, P. 1927. Note sur les tablettes de Neirab. *Syria* 8:213-215.
- Diaz-Andreu, M. 1995. "Archaeology and Nationalism in Spain," in *Nationalism, Politics, and the Practice of Archaeology*. Edited by P. L. Kohl and C. Fawcett, pp. 39-56. Cambridge: Cambridge University Press.
- Dickinson, O. 2006. *The Aegean from Bronze Age to Iron Age. Continuity and change between the twelfth and eighth centuries BC*. London: Routledge.
- Dietler, M., and I. Herbich. 1998. "Habitus, Techniques, Style: An Integrated Approach to the Social Understanding of Material Culture and Boundaries," in *The Archaeology of Social Boundaries*. Edited by M. T. Stark, pp. 232-263. Washington and London: Smithsonian Institution Press.
- Dikaios, P. 1969. *Enkomi, Excavations 1948-1958, vol. 1: The Architectural Remains, the Tombs*. Mainz am Rhein: Verlag Philipp von Zabern.
- Dion, P.-E. 1997. *Les Arameens de l'Age du Fer: Histoire Politique et Structures Sociales*. Paris: Librairie Lecoffre.
- Dobres, M.-A. 1999. "Technology's Links and Chaines: The Processual Unfolding of Technique and Technician," in *The Social Dynamics of Technology: Practice, Politics and World Views*. Edited by M.-A. Dobres and C. R. Hoffman, pp. 124-146. Washington and London: Smithsonian Institution Press.
- Dobres, M.-A. 2000. *Technology and Social Agency: Outlining a Practice Framework for Archaeology*. Oxford: Blackwell.
- Dobres, M.-A., and C. R. Hoffman. Editors. 1999a. *The Social Dynamics of Technology: Practice, Politics and World Views*. Washington and London: Smithsonian Institution Press.
- Dobres, M.-A., and C. R. Hoffman. 1999b. "Introduction: A Context for the Present and Future of Technology Studies," in *The Social Dynamics of Technology:*

- Practice, Politics and World Views*. Edited by M.-A. Dobres and C. R. Hoffman, pp. 1-22. Washington and London: Smithsonian Institution Press.
- Dobres, M.-A., and C. R. Hoffman. 1999c. "Conclusion: Making Material Culture, Making Culture Material," in *The Social Dynamics of Technology: Practice, Politics and World Views*. Edited by M.-A. Dobres and C. R. Hoffman, pp. 209-222. Washington and London: Smithsonian Institution Press.
- Dobres, M.-A., and J. E. Robb. Editors. 2000a. *Agency in Archaeology*. London: Routledge.
- Dobres, M.-A., and J. E. Robb. 2000b. "Introduction," in *Agency in Archaeology*. Edited by M.-A. Dobres and J. E. Robb, pp. 3-17. London: Routledge.
- Dornemann, R. H. 1997. "Hama," in *The Oxford Encyclopedia of Archaeology in the Near East. Vol. 2*. Edited by E. M. Meyers, pp. 466-468. Oxford: Oxford University Press.
- Dornemann, R. H. 1998a. Tell Qarqur 1996. *Chronique Archeologique en Syrie* 2:81-87.
- Dornemann, R. H. 1998b. Tell Qarqur 1997. *Chronique Archeologique en Syrie* 2:153-159.
- Dornemann, R. H. 1999. Comparisons in the Bronze and Iron Age Inventories between Orontes Valley sites, Ugarit and Ebla, from the point of view from Tell Qarqur. *Les Annales Archeologiques Arabes Syriennes* 43:137-148.
- Dornemann, R. H. 2000. "Iron Age Remains at Tell Qarqur in the Orontes Valley," in *Essays on Syria in the Iron Age., Ancient Near Eastern studies. Supplement 7*. Edited by G. Bunnens, pp. 459-492. Louvain: Peeters Press.
- Dornemann, R. H. 2003a. "Seven Seasons of American Schools of Oriental Research Excavations at Tell Qarqur, Syria, 1993-1999," in *Preliminary Excavation Reports and Other Archaeological Investigations: Tell Qarqur, Iron I Sites in the North-Central Highlands of Palestine, Annual of the American Schools of Oriental Research; v. 56*. Edited by N. L. Lapp, pp. 1-141. Boston, Mass.: American Schools of Oriental Research.
- Dornemann, R. H. 2003b. "State Formation in Syria at the Beginning of the Iron Age," in *One Hundred Years of American Archaeology in the Middle East*. Edited by D. R. Clark and V. H. Matthews, pp. 199-214. Boston: American Schools of Oriental Research.
- Dothan, M. 1985. "Terminology for the Archaeology of the Biblical Periods," in *Biblical Archaeology Today*. Edited by J. Amitai, pp. 136-141. Jerusalem: Israel Exploration Society.
- Dothan, T. 1982. *The Philistines and their Material Culture*. Jerusalem: Israel Exploration Society.
- Dothan, T. 1998. "Initial Philistine Settlement: From Migration to Coexistence," in *Mediterranean Peoples in Transition: Thirteenth to Early Tenth Centuries BCE-In Honour of Professor Trude Dothan*. Edited by S. Gitin, A. Mazar, and E. Stern, pp. 148-161. Jerusalem: Israel Exploration Society.
- Dothan, T., and M. Dothan. 1992. *People of the Sea: The Search for the Philistines*. New York: Macmillan Publishing Company.
- Douglas, M. 1975. "Deciphering a Meal," in *Implicit Meanings*. Edited by M. Douglas, pp. 249-275. London: Routledge.
- Douglas, M. 1987. "A distinctive anthropological perspective," in *Constructive Drinking: Perspectives on Drink from Anthropology, Editions de la Maison des Sciences de l'Homme*. Edited by M. Douglas, pp. 3-15. Cambridge: Cambridge University Press.

- Doumet, C. 1982. Les tombes IV et V de Rachidieh. *Annales d'Histoire et d'Archéologie* 1:89-135.
- Doumet, C., and I. Kawkabani. 1995. "Les Tombes de Rachidieh: Remarques sur les Contacts Internationaux et le Commerce Phénicien au VIIIe Siècle Av. J.-C.," in *Actes du IIIe Congrès International des Études Phéniciennes et Puniqes. Tunis, 11-16 Novembre 1991*, pp. 379-395. Tunis: Institut National du Patrimoine.
- Doumet-Serhal, C. 1993-1994. La Cruche a 'Arete sur le Col' un Fossile Directeur de l'Expansion Phenicienne en Mediterranee. *Berytus* 41:99-136.
- Doumet-Serhal, C. 1995-1996. Le Bronze Moyen II B/C et le Bronze Recent I au Liban: l'evidence de Tell el Ghassil. *Berytus* 42:37-70.
- Doumet-Serhal, C. 1996. *Les Fouilles de Tell el-Ghassil de 1972 a 1974. Etude du Materiel. Bibliotheque Archeologique et Historique T. 146*. Beyrouth: IFAPO.
- Doumet-Serhal, C. 1998-1999. First Season of Excavation at Sidon Preliminary Report. *Baal* 3:181-224.
- Doumet-Serhal, C. 2000. Second Season of Excavation at Sidon Preliminary Report. *Baal* 4:75-122.
- Doumet-Serhal, C. 2001. Third Season of Excavation at Sidon Preliminary Report. *Baal* 5:153-172.
- Doumet-Serhal, C. 2002. Fourth Season of Excavation at Sidon Preliminary Report. *Baal* 6:179-210.
- Doumet-Serhal, C. 2003a. Jars from the First Millennium BCE at Tell el Rachidieh (south of Tyre): Phoenician Cinerary Urns and Grave Goods. *Archaeology and History in the Lebanon* 17:42-51.
- Doumet-Serhal, C. 2003b. Jars from the Second Millennium BC at Tell el Ghassil (Beka'a Valley): Child Burials or Finds in Domestic Installations. *Archaeology and History in the Lebanon* 17:22-24.
- Doumet-Serhal, C. 2003c. Fifth Season of Excavation at Sidon Preliminary Report. *Baal* 7:175-208.
- Doumet-Serhal, C. 2003d. Jars from the Third Millennium BC at Sidon (south Lebanon): A Standardised Production in the Emergence of an Urban Culture. *Archaeology and History in the Lebanon* 17:2-6.
- Doumet-Serhal, C. 2004a. "The Location and Ancient Names of Mainland Tyre and the Role of Rachidieh in this Context," in *Decade: A Decade of Archaeology and History in the Lebanon*. Edited by C. Doumet-Serhal, pp. 60-69. Beirut: The Lebanese British Friends of the National Museum.
- Doumet-Serhal, C. 2004b. "Jars from the First Millennium BC at Tell Rachidieh: Phoenician Cinerary Urns and Grave Goods," in *Decade: A Decade of Archaeology and History in the Lebanon*. Edited by C. Doumet-Serhal, pp. 70-79. Beirut: The Lebanese British Friends of the National Museum.
- Doumet-Serhal, C. 2004c. "Tell Rachidieh: Foreign Relations," in *Decade: A Decade of Archaeology and History in the Lebanon*. Edited by C. Doumet-Serhal, pp. 88-99. Beirut: The Lebanese British Friends of the National Museum.
- Doumet-Serhal, C. 2004d. "Sidon British Museum Excavations 1998-2003," in *Decade: A Decade of Archaeology and History in the Lebanon*. Edited by C. Doumet-Serhal, pp. 102-123. Beirut: The Lebanese British Friends of the National Museum.
- Doumet-Serhal, C. 2004e. "Jars from the Second Millennium BC at Sidon: Child Burials or Deposited Goods in Graves," in *Decade: A Decade of Archaeology*

- and History in the Lebanon*. Edited by C. Doumet-Serhal, pp. 132-145. Beirut: The Lebanese British Friends of the National Museum.
- Doumet-Serhal, C. 2004f. Sidon (Lebanon): Twenty Middle Bronze Age Burials from the 2001 Season of Excavation. *Levant* 36:89-154.
- Doumet-Serhal, C. 2004g. Sixth and Seventh Seasons of Excavation at Sidon Preliminary Report. *Baal* 8:47-82.
- Doumet-Serhal, C. 2004h. The Palm Tree Motif in the Late Bronze and Early Iron Age: Evidence from Sidon and Tell Rachidieh. *Archaeology and History in the Lebanon* 19:34-43.
- Doumet-Serhal, C. 2006. Preliminary Report on the Iron Age at Sidon: British Museum Excavations 2003-2004. *Archaeology and History in the Lebanon* 23:2-29.
- Doumet-Serhal, C., and H. Sayegh. 1998. "La Ceramique du Locus 130," in *Un Quartier du Port Phénicien de Beyrouth au Fer III/Perse. Les Objets, Supplement no. 6 a Transeuphraténe*. Edited by J. Elayi and H. Sayegh, pp. 11-24. Paris: Gabalda.
- Drews, R. 1993. *The End of the Bronze Age. Changes in Warfare and the Catastrophe ca. 1200 B.C.* New Jersey: Princeton University Press.
- Drower, M. S. 1995. *Flinders Petrie: A Life in Archaeology. Wisconsin Studies in Classics*. Madison, WI: University of Wisconsin Press.
- Dunand, M. 1926. Sondages archéologiques effectués à Bostan Ech-Cheikh près Saida. *Syria* 7:1-8; Pls 1-VI.
- Dunand, M. 1928. La Sixième Campagne de Fouilles de Byblos. *Syria* 9:1-5; 173-186.
- Dunand, M. 1929. La Septième Campagne des Fouilles de Byblos. *Syria* 10:206-216.
- Dunand, M. 1939a. *Fouilles De Byblos. Tome I 1926-1932 (Texte). Etudes et Documents d'Archeologie I*. Paris: Librairie Orientaliste Paul Geuthner.
- Dunand, M. 1939b. *Fouilles De Byblos. Tome I 1926-1932 (Atlas). Etudes et Documents d'Archeologie I*. Paris: Librairie Orientaliste Paul Geuthner.
- Dunand, M. 1940. Chronique. III. La Vie du Musée. *Bulletin du Musée de Beyrouth* 4:123-125.
- Dunand, M. 1950. *Fouilles De Byblos. Tome II 1933-1938 (Atlas). Etudes et Documents d'Archeologie III*. Paris: Librairie d'Amérique et d'Orient Adrien Maisonneuve.
- Dunand, M. 1954. *Fouilles De Byblos. Tome II 1933-1938 (Texte). Etudes et Documents d'Archeologie III*. Paris: Librairie d'Amérique et d'Orient Adrien Maisonneuve.
- Dunand, 1955. Rapport Préliminaire sur les Fouilles de Byblos en 1950, 51, 52. *Bulletin du Musée de Beyrouth* 12:7-23.
- Dunand, M. 1956. Rapport Préliminaire sur les Fouilles de Byblos en 1954, 55. *Bulletin du Musée de Beyrouth* 13:73-86.
- Dunand, M. 1961. Rapport Préliminaire sur les Fouilles de Byblos en 1957, 58, 59. *Bulletin du Musée de Beyrouth* 16:69-85.
- Dunand, M. 1964. Rapport Préliminaire sur les Fouilles de Byblos en 1960, 61, 62. *Bulletin du Musée de Beyrouth* 17:21-36.
- Dunand, M. 1965. Nouvelles inscriptions phéniciennes du temple d'Echmoun à Bostan ech-Cheikh près de Sidon. *Bulletin du Musée de Beyrouth* 18:105-110.
- Dunand, M. 1966a. Rapport Préliminaire sur les Fouilles de Byblos en 1964. *Bulletin du Musée de Beyrouth* 19:95-102.



- Dunand, M. 1966b. Rapport Préliminaire sur les Fouilles de Sidon en 1963-1964. *Bulletin du Musée de Beyrouth* 19:103-106.
- Dunand, M. 1967a. Rapport Préliminaire sur les Fouilles de Byblos en 1965. *Bulletin du Musée de Beyrouth* 20:21-26.
- Dunand, M. 1967b. Rapport Préliminaire sur les Fouilles de Sidon en 1964-1965. *Bulletin du Musée de Beyrouth* 20:27-44.
- Dunand, M. 1973. *Byblos: Its History, Ruins and Legends*. Paris.
- Dunand, M. 1983. "L'iconographie d'Echmoun dans son temple sidonien," in *Atti del I Congresso Internazionale di Studi Fenici e Punici, Roma, 5-10 Novembre 1979, Volume Secondo*. Edited by S. Moscati, pp. 515-520. Roma: Consiglio Nazionale Delle Ricerche.
- Dunand, M., A. Bounni, and N. Saliby. 1964. Fouilles de Tell Kazel: Rapport Préliminaire. *Les Annales Archeologiques Arabes Syriennes* 14:3-14.
- Dunand, M., and N. Saliby. 1957. A la recherche de Simyra. *Les Annales Archeologiques Arabes Syriennes* 7:3-16.
- Dussaud, R. 1928. Observations sur la ceramique du IIe millenaire avant notre ere. *Syria* 9:131-150.
- Dussaud, M. 1931. Fouilles de M. Ploix de Rotrou dans la Citadelle d'Alep. *Syria* 12:95-96.
- Dussaud, M. 1934. L'enciente fortifiée d'Alep. *Syria* 15:300-301.
- Dussaud, M. 1937. La date des grandes tombes de Til-Barsib. *Syria* 18:410.
- Echt, R. 1984. *Kamid el-Loz 5: Die Stratigraphie*. Saarbrucker Beitrage zur Alterumskunde 34. Bonn: Rudolph Habelt Verlag GMBH.
- Edgerton, W. F., and J. Wilson. 1936. *Historical Records of Rameses III: the Texts in 'Medinet Habu'*. Chicago: University of Chicago Press.
- Edwards, I. E. S. 1992. "Clays and Clay Use at Pella," in *Pella in Jordan 2: The Second Interim Report of the Joint University of Sydney and College of Wooster Excavations at Pella 1982-1985, Mediterranean Archaeology Supplement 2*. Edited by A. W. McNicoll, P. C. Edwards, J. Hanbury-Tenison, J. B. Hennessy, T. F. Potts, R. H. Smith, A. Walmsley, and P. Watson, pp. 281-298. Sydney: MEDITARCH.
- Egami, N. 1983. The Archaeological Researches in Idlib Prefecture. *Les Annales Archeologiques Arabes Syriennes* 33:75-82.
- Egami, N. 1988. *Tell Mastuma: Excavations in Idlib District, Syria, 1986. Preliminary report of archaeological researches in Syria; v. IV*. Tokyo: Ancient Orient Museum.
- Egami, N., and S. Masuda. 1982. *Tell Mastuma: Excavations in Idlib District, Syria, 1980. Preliminary report of archaeological researches in Syria; v. II*. Tokyo: Ancient Orient Museum.
- Egami, N., and S. Masuda. 1984. *Tell Mastuma: Excavations in Idlib District, Syria, 1982. Preliminary Report of Archaeological Researches in Syria III*. Tokyo: Ancient Orient Museum.
- Eidem, J. 1999a. Across the Euphrates The Region of Qal'at Najm and Reflections on Some Trans-Euphrates Routes. *Les Annales Archeologiques Arabes Syriennes* 43:149-157.
- Eidem, J. 1999b. "The 'Tishrin Project' and Salvage Archaeology," in *Archaeology of the Upper Syrian Euphrates, The Tishrin Dam Area: Proceedings of the International Symposium Held at Barcelona, January 28th-30th 1998*. Edited by G. del Olmo Lete and J.-L. Montero Fenollos, pp. 19-23. Barcelona: Editorial AUSA.

- Eidem, J., and R. Ackermann. 1999. "The Iron Age Ceramics from Tell Jurn Kabir," in *Iron Age Pottery in Northern Mesopotamia, Northern Syria and South-Eastern Anatolia : papers presented at the meetings of the international "table ronde" at Heidelberg (1995) and Nieborów (1997) and other contributions, Altertumskunde des vorderen Orients ; Bd. 10*. Edited by A. Hausleiter and A. Reiche, pp. 309-324. Münster: Ugarit-Verlag.
- Eidem, J., and K. Putt. 1994. An Iron Age Site on the Euphrates: The First Season of Excavations at Tell Jurn Kabir (Syria). *Orient-Express* 1994:8-9.
- Eidem, J., and K. Putt. 1995. Tell Jurn Kabir (Syria), 1994. *Orient-Express* 1995:39-40.
- Eidem, J., and K. Putt. 1999. "Tell Jurn Kabir and Tell Qadahiye: Danish Excavations in the Tishrin Dam Area," in *Archaeology of the Upper Syrian Euphrates, The Tishrin Dam Area: Proceedings of the International Symposium Held at Barcelona, January 28th-30th 1998*. Edited by G. del Olmo Lete and J.-L. Montero Fenollos, pp. 193-204. Barcelona: Editorial AUSA.
- Eidem, J., and K. Putt. 2001. Iron Age Sites on the Upper Euphrates. *Les Annales Archeologiques Arabes Syriennes* 44:83-96.
- Einwag, B. 2000. "Die West-Gazira in der Eisenzeit," in *Essays on Syria in the Iron Age., Ancient Near Eastern studies. Supplement 7*. Edited by G. Bunnens, pp. 307-325. Louvain: Peeters Press.
- Elayi, J. 1982. Studies in Phoenician Geography during the Persian Period. *Journal of Near Eastern Studies* 41:83-110.
- Elayi, J. 1986-1987. Les Importations Grecques a Tell Kazel (Simyra) a l'Epoque Perse. *Les Annales Archeologiques Arabes Syriennes* 36/37:132-135.
- Elayi, J. 1987. "Al-Mina sur l'Oronte a l'epoque perse," in *Phoenicia and the East Mediterranean in the First Millennium B.C., Studia Phoenicia 5*. Edited by E. Lipinski, pp. 249-265. Leuven: Uitgeverij Peeters.
- Elayi, J., and H. Sayegh. 2000. *Un Quartier du Port Phénicien de Beyrouth au Fer III/Perse. Archeologie et Histoire. Supplement no. 7 à Transeuphraténe*. Paris: Gabalda.
- Elon, A. 1971. *The Israelis: Founder and Sons*. New York: Holt, Rinehart and Winston.
- Elon, A. 1997. "Politics and Archaeology," in *The Archaeology of Israel: Constructing the Past, Interpreting the Present, Journal for the Study of the Old Testament Supplement Series 237*. Edited by N. A. Silberman and D. Small, pp. 34-48. Sheffield: Sheffield Academic Press.
- Emberling, G., and N. Yoffee. 1999. "Thinking About Ethnicity in Mesopotamian Archaeology and History," in *Fluchtpunkt Uruk. Archäologische Einheit aus Methodischer Vielfalt. Schriften für Hans Jorg Nissen, Internationale Archäologie Studia Honoria 6*. Edited by H. Kuhne, R. Bernbeck, and K. Bartl, pp. 272-281. Rahden.
- Engberg, R. M. 1940. Historical Analysis of Archaeological Evidence: Megiddo and the Song of Deborah. *Bulletin of the American Schools of Oriental Research* 78:4-9.
- Esse, D. L. 1992. The Collared Pithos at Megiddo: Ceramic Distribution and Ethnicity. *Journal of Near Eastern Studies* 51:81-104.
- Esse, D. L., and T. P. Harrison. 2004. "History of Excavations," in *Megiddo 3. Final Report on the Stratum VI Excavations, Oriental Institute Publications*

- Volume 127. Edited by T. P. Harrison, pp. 1-6. Chicago: University of Chicago.
- Evans, J. 1949. The Royal Archaeological Institute: A Retrospect. *Archaeological Journal* 106:1-11.
- Evans, J. 1956. *The History of the Society of Antiquaries*. Oxford: Oxford University Press.
- Fales, F. M. 1990. *The Rural Landscape of the Neo-Assyrian Empire: A Survey*. *State Archives of Assyria Bulletin IV (2)*. Padova: Sargon.
- Fales, F. M. 1995. "Rivers in Neo-Assyrian Geography," in *Neo-Assyrian Geography: Papers Presented at the International Conference Held in the University of Rome 'La Sapienza', November 10th to 12th, 1993.*, *Quaderni di geografia storica* ; 5. Edited by M. Liverani, pp. 203-215. Roma: Università di Roma 'La Sapienza' Dipartimento di Scienze storiche archeologiche e antropologiche dell'Antichità.
- Fales, F. M. 1999. "The Tablets from Tell Shioukh Fawqani/Burmarina in the Context of Assyro-Aramaic Studies," in *Archaeology of the Upper Syrian Euphrates, The Tishrin Dam Area: Proceedings of the International Symposium Held at Barcelona, January 28th-30th 1998*. Edited by G. del Olmo Lete and J.-L. Montero Fenollos, pp. 625-636. Barcelona: Editorial AUSA.
- Fales, F. M., K. Radner, C. Pappi, and E. Attardo. 2005. "The Assyrian and Aramaic Texts from Tell Shioukh Fawqani," in *Tell Shiyukh Fawqani 1994-1998*. Edited by L. Bachelot and F. M. Fales, pp. 595-701. Padova: Sargon Editrice e Libreria.
- Falsone, G. 1988. "Phoenicia as a bronzeworking centre in the Iron Age," in *Bronzeworking centres of Western Asia c. 1000-539 BC*. Edited by J. Curtis, pp. 227-252. London: Keegan Paul International.
- Falsone, G. 1995. Salvage excavations at Tell Shiyukh Tahtani. *Akkadica* 92:37-38.
- Falsone, G. 1998. Tell Shiyukh Tahtani on the Euphrates. The University of Palermo rescue excavations in North Syria (1993-1994). *Akkadica* 109-110:22-64.
- Falsone, G. 1999. "Tell Shiyukh Tahtani," in *Archaeology of the Upper Syrian Euphrates: The Tishrin Dam Area*. Edited by G. del Olmo Lete and J.-L. Montero Fenollos, pp. 137-142. Barcelona.
- Fantalkin, A. 2001. Low Chronology and Greek Protogeometric and Geometric Pottery in the Southern Levant. *Levant* 33:117-125.
- Fantalkin, A., and I. Finkelstein. 2006. The Sheshonq I Campaign and the 8th-Century-BCE Earthquake-More on the Archaeology and History of the South in the Iron I-IIA. *Tel Aviv* 33(1):18-42.
- Faust, A. 2000. Ethnic Complexity in Northern Israel During Iron Age II. *Palestine Exploration Quarterly* 132:1ff.
- Faust, A. 2002. Burnished Pottery and Gender Hierarchy in Iron Age Israelite Society. *Journal of Mediterranean Archaeology* 15(1):53-73.
- Faust, A. 2004. Mortuary Practices, Society and Ideology; The Lack of Iron Age I Burials in the Highlands in Context. *Israel Exploration Journal* 54:174-190.
- Faust, A. 2006. *Israel's Ethnogenesis: Settlement, Interaction, Expansion and Resistance*. London: Equinox.
- Fay, B. 1998. "Introduction: The Linguistic Turn and Beyond in Contemporary Theory of History," in *History and Theory: Contemporary Readings*. Edited by B. Fay, P. Pomper, and R. T. Vann, pp. 1-12. Malden, MA: Blackwell Publishers.

- Felli, C., and E. Merluzzi. 2002. Afis 2000-2001. Area E: l'occupazione del Bronzo Medio. *Egitto e Vicino Oriente* 25:24-29.
- Ferguson, L. 1977. "Historical archaeology and the importance of material things," in *Historical Archaeology and the Importance of Material Things, Society for Historical Archaeology, Special Publication 2*. Edited by L. Ferguson, pp. 5-8.
- Finkbeiner, U. 2001-2002. BEY 020 - The Iron Age Fortification. *Aram* 13-14:27-36.
- Finkbeiner, U., and H. Sader. 1997. Bey 020 Preliminary report of the excavations 1995. *Baal*:114-166.
- Finkelstein, I. 1988a. *The Archaeology of the Israelite Settlement*. Jerusalem.
- Finkelstein, I. 1988b. Arabian Trade and Socio-Political Conditions in the Negev in the Twelfth-Eleventh Centuries BCE. *Journal of Near Eastern Studies* 47(4):241-252.
- Finkelstein, I. 1990. On Archaeological Methods and Historical Considerations: Iron Age II Gezer and Samaria. *Bulletin of the American Schools of Oriental Research* 277/278:109-119.
- Finkelstein, I. I. 1994. "The Emergence of Israel: A Phase in the Cyclic History of Canaan in the Third and Second Millennia BCE," in *From Nomadism to Monarchy: Archaeological and Historical Aspects of Early Israel*. Edited by I. Finkelstein and N. Na'aman, pp. 150-178. Jerusalem: Israel Exploration Society.
- Finkelstein, I. 1995a. The Date of the Settlement of the Philistines in Canaan. *Tel Aviv* 22:213-239.
- Finkelstein, I. 1995b. *Living on the Fringe: The Archaeology and History of the Negev, Sinai and Neighbouring Regions in the Bronze and Iron Ages. Monographs in Mediterranean Archaeology*. Sheffield: Sheffield Academic Press.
- Finkelstein, I. 1996a. The Archaeology of the United Monarchy: An Alternative View. *Levant* 28:177-188.
- Finkelstein, I. 1996b. The Stratigraphy and Chronology of Megiddo and Beth Shean in the 12th-11th Centuries BCE. *Tel Aviv* 23:170-184.
- Finkelstein, I. 1996c. "Toward a New Periodization and Nomenclature of the Archaeology of the Southern Levant," in *The Study of the Ancient Near East in the Twenty-First Century*. Edited by J. S. Cooper and G. M. Schwartz, pp. 103-123. Winona Lake, Indiana: Eisenbrauns.
- Finkelstein, I. 1997. "Pots and People Revisited: Ethnic Boundaries in the Iron Age I," in *The Archaeology of Israel: Constructing the Past, Interpreting the Present, Journal for the Study of the Old Testament Supplement Series 237*. Edited by N. A. Silberman and D. Small, pp. 216-237. Sheffield: Sheffield Academic Press.
- Finkelstein, I. 1998a. Notes on the Stratigraphy and Chronology of Iron Age Ta'anach. *Tel Aviv* 25:208-218.
- Finkelstein, I. 1998b. "Philistine Chronology: High, Middle or Low?," in *Mediterranean Peoples in Transition: Thirteenth to Early Tenth Centuries BCE-In Honour of Professor Trude Dothan*. Edited by S. Gitin, A. Mazar, and E. Stern, pp. 140-147. Jerusalem: Israel Exploration Society.
- Finkelstein, I. 1998c. Bible Archaeology or Archaeology of Palestine in the Iron Age? A Rejoinder. *Levant* 30:167-174.

- Finkelstein, I. 1999a. Hazor and the North in the Iron Age: A Low Chronology Perspective. *Bulletin of the American Schools of Oriental Research* 314:55-70.
- Finkelstein, I. 1999b. State Formation in Israel and Judah: A Contrast in Context, A Contrast in Trajectory. *Near Eastern Archaeology* 62:35-52.
- Finkelstein, I. 2000. Hazor XII-XI with an Addendum on Ben-Tor's Dating of Hazor X-VII. *Tel Aviv* 27:231-247.
- Finkelstein, I. 2002. The Campaign of Shoshenq I to Palestine: A Guide to the 10th Century BCE Polity. *Zeitschrift des Deutschen Palästina-Vereins* 118:109-135.
- Finkelstein, I. 2003. "City States and States: Polity Dynamics in the 10th-9th centuries BCE," in *Symbiosis, Symbolism, and the Power of the Past. Canaan, Ancient Israel, and Their Neighbours from the Late Bronze Age through Roman Palaestina*. Edited by W. G. Dever and S. Gitin, pp. 75-83. Winona Lake, IN: Eisenbrauns.
- Finkelstein, I. 2004. Tel Rehov and Iron Age Chronology. *Levant* 36:181-188.
- Finkelstein, I. 2005. "A Low Chronology Update: Archaeology, history and bible," in *The Bible and Radiocarbon Dating: Archaeology, Text and Science*. Edited by T. E. Levy and T. Higham, pp. 31-42. London: Equinox.
- Finkelstein, I. 2006. "The Iron Age Pottery: Levels L-5, L-3, H-5 and H-4," in *Megiddo IV. The 1998-2002 Seasons, Tel Aviv University Sonia and Marco Nadler Institute of Archaeology Monograph Series Number 24*. Edited by I. Finkelstein, D. Ussishkin, and B. Halpern, pp. 303-314. Jerusalem: Institute of Archaeology, Tel Aviv University.
- Finkelstein, I. 2007. "Is the Philistine Paradigm Still Viable?," in *The Synchronisation of Civilisations in the Eastern Mediterranean in the Second Millennium B.C. III*. Edited by M. Bietak and E. Czerny, pp. 517-523. Vienna: Verlag der Österreichischen Akademie der Wissenschaften.
- Finkelstein, I., D. Ussishkin, and B. Halpern. 2000. "Introduction," in *Megiddo III. The 1992-1996 Seasons*. Edited by I. Finkelstein, D. Ussishkin, and B. Halpern, pp. 1-13. Jerusalem: Institute of Archaeology, Tel Aviv University.
- Finkelstein, I., O. Zimhoni, and A. Kafri. 2000. "The Iron Age Pottery Assemblages from Areas F, K and H and their Stratigraphic and Chronological Implications," in *Megiddo III. The 1992-1996 Seasons, Tel Aviv University Sonia and Marco Nadler Institute of Archaeology Monograph Series Number 18*. Edited by I. Finkelstein, D. Ussishkin, and B. Halpern, pp. 244-324. Jerusalem: Institute of Archaeology, Tel Aviv University.
- Finkelstein, I., and E. Piasezky. 2003a. Recent Radiocarbon Results and Biblical History. *Antiquity* 77:771-779.
- Finkelstein, I., and E. Piasezky. 2003b. Wrong and Right; High and Low C14 Dates from Tel Rehov and Iron Age Chronology. *Tel Aviv* 30:283-295.
- Finkelstein, I., and E. Piasezky. 2003c. Comment on "C14 Dates from Tel Rehov: Iron Age Chronology, Pharaohs, and Hebrew Kings". *Science* 302: 568b.
- Finkelstein, I., and E. Piasezky. 2006. The Iron I-IIA in the Highland and Beyond: 14C Anchors, Pottery Phases and The Shoshenq I Campaign. *Levant* 38:45-62.
- Finkelstein, I., D. Ussishkin, and B. Halpern. 2006. "Archaeological and Historical Conclusions," in *Megiddo IV. The 1998-2002 Seasons, Tel Aviv University Sonia and Marco Nadler Institute of Archaeology Monograph Series Number*

24. Edited by I. Finkelstein, D. Ussishkin, and B. Halpern, pp. 843-859. Jerusalem: Institute of Archaeology, Tel Aviv University.
- Forsberg, S. 1995. *Near Eastern Destruction Datings as Sources for Greek and Near Eastern Iron Age Chronology. Archaeological and historical studies. The cases of Samaria (722 B.C.) and Tarsus (696 B.C.). Uppsala Studies in Ancient Mediterranean and Near Eastern Civilisations 19.* Uppsala: Acta Universitatis Upsaliensis.
- Fortin, M. 1999. *Syria: Land of Civilizations.* Montreal.
- Fortin, M. 2006a. "Tell 'Acharneh: rapport préliminaire sur la campagne exploratoire de 1998," in *Tell 'Acharneh 1998-2004. Preliminary Reports on Excavation Campaigns and Study Season, Subartu XVIII.* Edited by M. Fortin, pp. 83-106. Turnhout: BREPOLs Publishers.
- Fortin, M. 2006b. "Tell 'Acharneh: rapport préliminaire sur la campagne de fouilles de 2001," in *Tell 'Acharneh 1998-2004. Preliminary Reports on Excavation Campaigns and Study Season, Subartu XVIII.* Edited by M. Fortin, pp. 107-120. Turnhout: BREPOLs Publishers.
- Fortin, M. 2006c. "Tell 'Acharneh: rapport préliminaire sur la campagne de fouilles 2002," in *Tell 'Acharneh 1998-2004. Preliminary Reports on Excavation Campaigns and Study Season, Subartu XVIII.* Edited by M. Fortin, pp. 121-140. Turnhout: BREPOLs Publishers.
- Frame, G. 2006. "The Tell Acharneh Stela of Sargon II of Assyria," in *Tell 'Acharneh 1998-2004. Preliminary Reports on Excavation Campaigns and Study Season, Subartu XVIII.* Edited by M. Fortin, pp. 49-68. Turnhout: BREPOLs Publishers.
- Francis, E. D., and M. Vickers. 1985. Greek Geometric Pottery at Hama and its Implications for Near Eastern Chronology. *Levant* 17:131-138.
- Frankenstein, S. 1979. "The Phoenicians in the Far West: A Function of Neo-Assyrian Imperialism," in *Power and Propaganda A Symposium on Ancient Empires, Copenhagen Studies in Assyriology 7.* Edited by M. T. Larsen, pp. 263-298. Copenhagen: Akademisk Forlag.
- Frankfort, H. 1952. The Origin of the Bit-Hilani. *Iraq* 14:120-131.
- Franklin, N. 2006. Revealing Stratum V at Megiddo. *Bulletin of the American Schools of Oriental Research* 342:95-111.
- Frantzen, A. J. 1990. *Desire for Origins. New Language, Old English, and Teaching the Tradition.* New Brunswick: Rutgers University Press.
- Freeth, Z., and H. V. F. Winstone. 1978. *Explorers of Arabia: From the Renaissance to the End of the Victorian Era.* London.
- French, D. H., J. Moore, and H. F. Russell. 1982. Excavations at Tille 1979-1982. An Interim Report. *Anatolian Studies* 32:161-187.
- Frenkel, Y. a. 2001. "Muslim Travellers to *Bilad al-Sham* (Syria and Palestine) from the thirteenth to the sixteenth centuries: Maghribi travel accounts," in *Travellers in the Levant: Voyagers and Visionaries.* Edited by S. Searight and M. Wagstaff, pp. 109-120. Durham: Astene.
- Fritz, V. 2000. "Bronze Age Features in Cities of the Early Iron Age in the Southern Levant," in *Proceedings of the First International Congress on the Archaeology of the Ancient Near East, Rome, May 18-23, 1998. Volume I.* Edited by P. Matthiae, A. Enea, L. Peyronel, and F. Pinnock, pp. 507-512. Rome: Università degli Studi di Roma 'La Sapienza'.

- Frost, H. 2004. "Byblos and the Sea," in *Decade: A Decade of Archaeology and History in the Lebanon*. Edited by C. Doumet-Serhal, pp. 316-347. Beirut: The Lebanese British Friends of the National Museum.
- Frye, R. N. 1992. Assyria and Syria: synonyms. *Journal of Near Eastern Studies* 51:281-285.
- Fuchs, A. 1994. *Die Inschriften Sargons II aus Khorsabad*. Göttingen: Cuvillier Verlag
- Fugmann, E. 1958. *Hama: fouilles et recherches, 1931-1938: L'architecture des périodes pré-hellénistiques*. Vol. 2.1. Copenhagen: NationalMuséet.
- Funk, R. W., and H. N. Richardson. 1958. The 1958 Sounding at Pella. *Biblical Archaeologist* 21:82-96.
- Gaal, E. 1976. "The King Parrattarna died and was cremated?," in *Wirtschaft und Gesellschaft im Alten Vorderasien*. Edited by J. Harmatta and G. Komorocy, pp. 281-286. Budapest.
- Gadd, C. J. 1954. Inscribed Prisms of Sargon II from Nimrud. *Iraq* 16:173-201.
- Gal, Z. 1988. The Late Bronze Age in Galilee: A Reassessment. *Bulletin of the American Schools of Oriental Research* 272:79-84.
- Gal, Z. 1992a. Hurbat Rosh Zayit and the Early Phoenician Pottery. *Levant* 24:173-186.
- Gal, Z. 1992b. *Lower Galilee During the Iron Age. Dissertation series (American Schools of Oriental Research) ; no. 9*. Winona Lake, IN: Eisenbrauns.
- Gal, Z. 2003. The Iron Age 'Low Chronology' in Light of the Excavations at Horvat Rosh Zayit. *Israel Exploration Journal* 53:147-150.
- Galaty, M. L. 1999. *Nestor's Wine Cups. Investigating Ceramic Manufacture and Exchange in a Late Bronze Age "Mycenaean" State. BAR International Series 766*. Oxford: John and Erica Hedges.
- Gallagher, W. R. 1999. *Sennacherib's Campaign to Judah. New Studies. Studies in the History and Culture of the Ancient Near East XVIII*. Leiden: Brill.
- Garnsey, P. 1999. *Food and Society in Classical Antiquity*. Cambridge: Cambridge University Press.
- Garstang, J. 1931. *Joshua-Judges: The Foundations of Bible History*. London.
- Geertz, C. 1973. *The Interpretation of Cultures*. New York.
- Gelb, I. J. 1939. *Hittite Hieroglyphic Monuments. Oriental Institute Publications 45*. Chicago: University of Chicago Press.
- Gelin, M. 2004. *l'Archéologie en Syrie et au Liban à l'Époque du Mandat (1919-1946): Histoire & Organisation*. Paris: Geuthner.
- George, A. R. 1997. "Assyria and the Western World," in *Assyria 1995: Proceedings of the 10th Anniversary Symposium of the Neo-Assyrian Text Corpus Project Helsinki, September 7-11, 1995*. Edited by S. Parpola and R. M. Whiting, pp. 69-76. Helsinki.
- Gershuny, L. 1985. *Bronze Vessels from Israel and Jordan. Prähistorische Bronzefunde II.6*. München: C.H. Beck'sche Verlagsbuchhandlung.
- Geva, S. 1971. A Reassessment of the Chronology of Beth Shean Strata V and IV. *Israel Exploration Journal* 29:6-10.
- Geva, S. 1982. Archaeological Evidence for the Trade Between Israel and Tyre? *Bulletin of the American Schools of Oriental Research* 248:69-72.
- Giddens, A. 1984. *The Constitution of Society: Outline of the Theory of Structuration*. Berkeley and Los Angeles: University of California Press.
- Gilboa, A. 1989. New Finds at Tell Dor and the Beginning of Cypro-Geometric Pottery Import to Palestine. *Israel Exploration Journal* 39:204-218.

- Gilboa, A. 1996. Assyrian Type Pottery at Dor and the Status of the Town during the Assyrian Occupation Period. *Eretz Israel* 25:122-135 (Hebrew).
- Gilboa, A. 1999. The Dynamics of Phoenician Bichrome Pottery: A View from Tel Dor. *Bulletin of the American Schools of Oriental Research* 316:1-22.
- Gilboa, A., and I. Sharon. 2001. Early Iron Age Radiometric Dates from Tel Dor: Preliminary Implications for Phoenicia and Beyond. *Radiocarbon* 43:1343-1351.
- Gilboa, A., and I. Sharon. 2003. An Archaeological Contribution to the Early Iron Age Chronological Debate: Alternative Chronologies for Phoenicia and Their Effects on the Levant, Cyprus and Greece. *Bulletin of the American Schools of Oriental Research* 332:7-80.
- Gilmour, G. 1995. "Aegean Influence in Late Bronze Age Funerary Practices in the Southern Levant," in *The Archaeology of Death in the Ancient Near East, Oxbow Monographs 51*. Edited by S. Campbell and A. Green, pp. 155-170. Oxford: Oxbow Books.
- Ginsberg, H. L. 1969a. "The Legend of King Keret," in *Ancient Near Eastern Texts Relating to the Old Testament*, Third Edition with Supplement edition. Edited by J. B. Pritchard, pp. 142-149. Princeton, New Jersey: Princeton University Press.
- Ginsberg, H. L. 1969b. "The Tale of Aqhat," in *Ancient Near Eastern Texts Relating to the Old Testament*, Third Edition with Supplement edition. Edited by J. B. Pritchard, pp. 149-155. Princeton, New Jersey: Princeton University Press.
- Gitin, S. 2002. The House That Albright Built. *Near Eastern Archaeology* 65:5-10.
- Gitin, S. 2003. "The Philistines: Neighbours of the Canaanites, Phoenicians and Israelites," in *One Hundred Years of American Archaeology in the Middle East*. Edited by D. R. Clark and V. H. Matthews, pp. 57-86. Boston: American Schools of Oriental Research.
- Gjerstad, E. 1944. The Initial Date of the Cypriote Iron Age. *Opuscula Archaeologica* 3:73-106.
- Gjerstad, E. 1948. *The Swedish Cyprus Expedition IV.2: The Cypro-Geometric, Cypro-Achaic and Cypro-Classical Periods*. Stockholm: The Swedish Cyprus Expedition.
- Gjerstad, E. 1953. Reply to Albright's "Correspondence with Professor Einar Gjerstad on the Chronology of 'Cypriote' Pottery from Early Iron Levels in Palestine". *Bulletin of the American Schools of Oriental Research* 130:22-26.
- Glatz, C., and R. Matthews. 2005. Anthropology of a Frontier Zone: Hittite-Kaska Relations in Late Bronze Age North-Central Anatolia. *Bulletin of the American Schools of Oriental Research* 339:47-65.
- Glueck, N. 1938. Archaeological Exploration and Excavation in Palestine, Transjordan, and Syria during 1937. *American Journal of Archaeology* 42(1):165-176.
- Gonnella, J., W. Khayyata, and K. Kohlmeyer. 2005. *Die Zitadelle Von Aleppo und der Tempel des Wettergottes: Neue Forschungen und Entdeckungen*. Munster: Rhema.
- Goodby, R. G. 1998. "Technological Patterning and Social Boundaries: Ceramic Variability in Southern New England, A.D. 1000-1675," in *The Archaeology of Social Boundaries*. Edited by M. T. Stark, pp. 161-182. Washington and London: Smithsonian Institution Press.
- Grabois, A. 1988. "Medieval Pilgrims, the Holy Land and its Image in European Civilisation," in *The Holy Land in History and Thought: Papers Submitted to*



- the International Conference on the Relations Between the Holy Land and the World Outside it, Johannesburg 1986*. Edited by M. Sharon, pp. 65-79. Leiden.
- Gras, M., Rouillard, P. and J. Teixidor. 1991. The Phoenicians and Death. *Berytus* 39: 127-176.
- Grayson, A. K. 1991a. *Assyrian Rulers of the Early First Millennia BC I (1114-859 BC)*. *The Royal Inscriptions of Mesopotamia Assyrian Periods 2*. Toronto: University of Toronto Press.
- Grayson, A. K. 1991b. "Assyria: Tiglath-pileser III to Sargon II (744-705 B.C.)," in *The Assyrian and Babylonian Empires and other States of the Near East, from the Eighth to the Sixth Centuries B.C., Cambridge Ancient History III.2 (Second Edition)*. Edited by J. Boardman, I. E. S. Edwards, N. G. L. Hammond, E. Sollberger, and C. B. F. Walker, pp. 71-102. Cambridge: Cambridge University Press.
- Grayson, A. K. 1996. *Assyrian Rulers of the Early First Millennia BC II (858-745 BC)*. *The Royal Inscriptions of Mesopotamia Assyrian Periods 3*. Toronto: University of Toronto Press.
- Green, A., and A. Hausleiter. 2000. Tell Ahmar Survey. Preliminary Report on the Work of the British-German Team in 1999. *Orient-Express* 2000:79-81.
- Greenacre, M. J. 1984. *Theory and Applications of Correspondence Analysis*. London: Academic Press, Inc.
- Griffiths, D. 2003. Petrographic Analysis on Pottery from Tomb IV at Tell el Rachidieh. *Archaeology and History in the Lebanon* 17:58-59.
- Gröndahl, F. 1967. *Die Personennamen der Texte aus Ugarit*. Rome: Päpstliches Bibelinstitut.
- Gubel, E. 1990a. Tell Kazel, Syria: Excavations of the AUB Museum, 1985-1987, Preliminary Reports: Area I. *Berytus* 38:23-54.
- Gubel, E. 1990b. Tell Kazel (Sumur/Simyra) a l'epoque perse. *Transeuphratène* 2:37-49.
- Gubel, E. 1994. "Phoenician Foundations in Archaeological Perspective," in *Nuove fondazioni nel Vicino Oriente Antico: realta e ideologia*. Edited by S. Mazzoni, pp. 341-355. Pisa.
- Gubel, E. 1995. "The AUB Excavations at Tell Kazel, Syria: the Oriental Material from Area I," in *Actes du IIIe Congrès International des Études Phéniciennes et Puniques. Tunis, 11-16 Novembre 1991*, pp. 118-127. Tunis: Institut National du Patrimoine.
- Gubel, E. 2000. "Amurru, Sumur (Tell Kazel) and the Mitanni. New Perspectives," in *Proceedings of the First International Congress on the Archaeology of the Ancient Near East, Rome, May 18-23, 1998. Volume I*. Edited by P. Matthiae, A. Enea, L. Peyronel, and F. Pinnock, pp. 573-586. Rome: Universita degli Studi di Roma 'La Sapienza'.
- Gubel, E., and E. Lipinski. Editors. 1985. *Phoenicia and Its Neighbours. Studia Phoenicia III*. Leuven: Peeters.
- Guigues, P. E. 1937. Lébé'a, Kafer-Ġarra, Qrayé, Nécropoles de la Région Sidonienne. *Bulletin du Musée de Beyrouth* 1:35-76.
- Guigues, P. E. 1938. Lébé'a, Kafer-Ġarra, Qrayé, Nécropoles de la Région Sidonienne. *Bulletin du Musée de Beyrouth* 2:27-72.
- Guigues, P. E. 1939. Lébé'a, Kafer-Ġarra, Qrayé, Nécropoles de la Région Sidonienne. *Bulletin du Musée de Beyrouth* 3:53-63.

- Guy, P. L. O. 1931. *New Light from Armageddon: Second Provisional Report (1927-29) on the Excavations at Megiddo in Palestine*. *Oriental Institute Publications* 9. Chicago: University of Chicago Press.
- Guy, P. L. O. 1938. *Megiddo Tombs*. *Oriental Institute Publications* 33. Chicago: University of Chicago Press.
- Haarer, P. 2001. "Problematising the Transition from Bronze to Iron," in *The Social Context of Technological Change. Egypt and the Near East, 1650-1550 B.C.* Edited by A. J. Shortland, pp. 255-273. Oxford: Oxbow Books.
- Hachmann, R. 1966. "Verlauf und Ergebnisse der Grabung des Jahres 1964," in *Bericht über die Ergebnisse der Ausgrabungen in Kamid el-Loz (Libanon) in den Jahren 1963 und 1964, Saarbrucker Beiträge zur Altertumskunde Band 3*. Edited by R. Hachmann and A. Kuschke, pp. 43-68. Bonn: Rudolf Habelt Verlag.
- Hachmann, R. 1969a. Rapport Preliminaires sur les Fouilles au Tell de Kamid el-Loz de 1966 a 1968: I. Introduction. *Bulletin du Musée de Beyrouth* 22:49-51.
- Hachmann, R. 1969b. Rapport Preliminaires sur les Fouilles au Tell de Kamid el-Loz de 1966 a 1968: II. Historique des Quatre Campagnes de Fouilles. *Bulletin du Musée de Beyrouth* 22:53-60.
- Hachmann, R. 1969c. Rapport Preliminaires sur les Fouilles au Tell de Kamid el-Loz de 1966 a 1968: III. Nouvelles decouvertes provenant du cimetiere de l'epoque Perse. *Bulletin du Musée de Beyrouth* 22:61-65.
- Hachmann, R. 1969d. Rapport Preliminaires sur les Fouilles au Tell de Kamid el-Loz de 1966 a 1968: V. Le cemetiere de l'age du Bronze Moyen sur la Pente Nord du Tell. *Bulletin du Musée de Beyrouth* 22:77-84.
- Hachmann, R. (ed.) 1970a. *Bericht über die Ergebnisse der Ausgrabungen in Kamid el-Loz (Libanon) in den Jahren 1966 und 1967. Saarbrucker Beiträge zur Altertumskunde Band 4*. Bonn: Rudolf Habelt Verlag.
- Hachmann, R. 1970b. Grabungen auf dem Tell Kamid el-Loz (Libanon). *Archiv für Orientforschung* 23:135-140.
- Hachmann, R. 1978a. Rapport preliminaire sur les fouilles au Tell de Kamid el-Loz de 1969 a 1972, avec un appendice concernant des decouvertes epigraphiques par G. Wilhelm. *Bulletin du Musée de Beyrouth* 30:7-26.
- Hachmann, R. 1978b. Rapport preliminaire sur les fouilles au Tell de Kamid el-Loz en 1973. *Bulletin du Musée de Beyrouth* 30:27-41.
- Hachmann, R. (ed.) 1983. *Fruhe Phoniker im Libanon: 20 Jahre deutsche Ausgrabungen in Kamid el-Loz*. Mainz am Rhein: Verlag Philipp von Zabern.
- Hachmann, R. 1989. Kamid el-Loz 1963-1981. German Excavations in Lebanon (Part 1). *Berytus* 37:5-187.
- Hachmann, R., and A. Kuschke. 1966. Rapport Preliminaires sur les travaux au Tell Kamid el-Loz durant les annees 1963 et 1964. *Bulletin du Musée de Beyrouth* 19:107-134.
- Hachmann, R., and M. Metzger. 1973. Arbeiten auf dem Tell Kamid el-Loz (Libanon) 1970 und 1971. *Archiv für Orientforschung* 24:176-180.
- Haggi, A. 2006. Phoenician Atlit and its Newly-Excavated Harbour: A Reassessment. *Tel Aviv* 33(1):43-60.
- Haines, R. C. 1971. *Excavations in the Plain of Antioch. vol. 2. The Structural Remains of the Later Phases*. *Oriental Institute Publications* 95. Chicago: University of Chicago.
- Hakker-Orion, D. 1984. "The Role of the Camel in Israel's Early History," in *Animals and Archaeology: 3. Early Herders and their Flocks, BAR*

- International Series 202*. Edited by J. Clutton-Brock and C. Grigson, pp. 207-212. Oxford: BAR.
- Hall, J. M. 1997. *Ethnic Identity in Greek Antiquity*. Cambridge: Cambridge University Press.
- Hallo, W. W. 1992. "From Bronze Age to Iron Age in Western Asia: Defining the Problem," in *The Crisis Years: The 12th Century B.C. From Beyond the Danube to the Tigris*. Edited by W. A. Ward and M. S. Joukowsky, pp. 1-9. Iowa: Kendall Hunt.
- Hamilakis, Y. 1996. Wine, Oil and the Dialectics of Power in Bronze Age Crete: A Review of the Evidence. *Oxford Journal of Archaeology* 15(1):1-32.
- Hamilakis, Y. 1999. Food Technologies/Technologies of the Body: The Social Context of Wine and Oil Production and Consumption in Bronze Age Crete. *World Archaeology* 31(1):38-54.
- Hamilton, R. W. 1934. Tell Abu Hawam; Interim Report. *Quarterly of the Department of Antiquities in Palestine* 3:74-80.
- Hamilton, R. W. 1935. Excavations at Tell Abu Hawam. *Quarterly of the Department of Antiquities in Palestine* 4:1-69.
- Hammade, H. 1999. The Cuneiform Inscription from Aleppo Citadel. *Les Annales Archeologiques Arabes Syriennes* 43: 251-252.
- Hanfmann, G. M. A. 1951. Review: The Swedish Cyprus Expedition, Vol. IV, Part 2; The Cypro-Geometric, Cypro-Achaic and Cypro-Classical Periods by Einar Gjerstad. *American Journal of Archaeology* 55(4):424-428.
- Hankey, V. 1967. Mycenaean Pottery in the Middle East: Notes on Finds Since 1951. *Annual of the British School at Athens* 62:107-147.
- Hankey, V. 1993. "Pottery as Evidence of Trade: the Levant from the Mouth of the River Orontes to the Egyptian Border," in *Wace and Blegen: Pottery as Evidence for Trade in the Aegean Bronze Age. 1939-1989*. Edited by C. Zerner, P. Zerner, and J. Winder, pp. 101-108. Amsterdam: J C Gieben.
- Hannestad, L. 1996. "Absolute Chronology: Greece and the Near East c. 1000-500 BCE," in *Absolute Chronology: Archaeological Europe 2500-500 BC, Acta Archaeologica Vol. 67*. Edited by K. Randsborg, pp. 39-49. Kobenhavn: Munksgaard.
- Harrison, T. P. 2001a. "Tell Ta'yinat and the Kingdom of Unqi," in *The World of the Aramaeans II: Studies in History and Archaeology in Honour of Paul-Eugene Dion, Journal for the Study of the Old Testament Supplement Series 325*. Edited by P. M. M. Daviau, J. W. Wevers, and M. Weigl, pp. 115-132. Sheffield: Sheffield Academic Press.
- Harrison, T. P. 2001b. The Evidence for Aramaean Cultural Expansion in the Amuq Plain. *Canadian Society for Mesopotamian Studies Bulletin* 36:135-144.
- Harrison, T. P. 2004a. "Stratigraphy and Chronology," in *Megiddo 3. Final Report on the Stratum VI Excavations, Oriental Insititute Publications Volume 127*. Edited by T. P. Harrison, pp. 8-14. Chicago: University of Chicago.
- Harrison, T. P. 2004b. "The Pottery," in *Megiddo 3. Final Report on the Stratum VI Excavations, Oriental Insititute Publications Volume 127*. Edited by T. P. Harrison, pp. 23-42. Chicago: University of Chicago.
- Harrison, T. P. 2004c. "Cultural and Historical Synthesis The Stratum VI Settlement," in *Megiddo 3. Final Report on the Stratum VI Excavations, Oriental Insititute Publications Volume 127*. Edited by T. P. Harrison, pp. 105-108. Chicago: University of Chicago.

- Harrison, T. P., S. Batiuk, and L. Pavlish. 2004. The 2002 Ta'yinat Archaeological Project Geomagnetic Survey. *Arkeometri Sonuclari Toplantisi* 19:121-130.
- Harrison, T. P., S. Batiuk, and L. Pavlish. 2005. 2003 Yili Tayinat Jeomanyetik Arastirmasi. *Arkeometri Sonuclari Toplantisi* 20:153-158.
- Harrison, T. P., S. Batiuk, and H. Snow. 2006. 2004 Yili Tayinat Hoyuk Kazilari. *Kazi Sonuclari Toplantisi* 27:353-362.
- Harvey, F. D. 1976. Sostratos of Aegina. *Parola del Popolo* 31:206-214.
- Hawkins, J. D. 1972. Building Inscriptions of Carchemish. The Long Wall of Sculpture and Great Staircase. *Anatolian Studies* 22:87-114.
- Hawkins, J. D. 1972-1975. "Hamath," in *Reallexikon der Assyriologie und Vorderasiatischen Archäologie*. Edited by E. Ebeling and B. Meissner, pp. 67-70. Berlin: Walter de Gruyter.
- Hawkins, J. D. 1974. Assyrians and Hittites. *Iraq* 36:67-83.
- Hawkins, J. D. 1976-1980. "Karkamiş," in *Reallexikon der Assyriologie und Vorderasiatischen Archäologie*. Edited by E. Ebeling and B. Meissner, pp. 426-446. Berlin: Walter de Gruyter.
- Hawkins, J. D. 1980. The 'Autobiography of Ariyahina's Son': An Edition of the Hieroglyphic Luwian Stelae Tell Ahmar 1 and Aleppo 2. *Anatolian Studies* 30:139-156.
- Hawkins, J. D. 1982. "The Neo-Hittite States in Syria and Anatolia," in *The Prehistory of the Balkans; and the Middle East and the Aegean World, Tenth to Eighth Centuries B.C., Cambridge Ancient History III.1 (Second Edition)*. Edited by J. Boardman, I. E. S. Edwards, N. G. L. Hammond, and E. Sollberger, pp. 372-442. Cambridge: Cambridge University Press.
- Hawkins, J. D. 1983. The Hittite Name of Til Barsip: Evidence From a New Hieroglyphic Fragment from Tell Ahmar. *Anatolian Studies* 33:131-136.
- Hawkins, J. D. 1988. Kuzi-Teshub and the 'Great Kings' of Karkamish. *Anatolian Studies* 38:99-108.
- Hawkins, J. D. 2002. "Anatolia: The End of the Hittite Empire and After," in *Die Nahöstlichen Kulturen und Griechenland an der Wende vom 2. zum 1. Jarhtausend v. Chr.* Edited by E. A. Braun-Holzinger and H. Matthaus, pp. 143-152. Mohnesee-Wamel: Bibliopolis.
- Hawkins, J. D. 2003. "Scripts and Texts," in *The Luwians, Handbuch der Orientalistik* 68. Edited by H. C. Melchert, pp. 128-169. Leiden: Brill.
- Healey, J. F. 1983. "Phoenician and the Spread of Aramaic," in *Atti del I Congresso Internazionale di Studi Fenici e Punici, Roma, 5-10 Novembre 1979, Volume Terzo*. Edited by S. Moscati, pp. 663-666. Roma: Consiglio Nazionale Delle Ricerche.
- Healey, J. F. 1995. "Death in West Semitic Texts: Ugarit and Nabataea," in *The Archaeology of Death in the Ancient Near East, Oxbow Monographs* 51. Edited by S. Campbell and A. Green, pp. 188-191. Oxford: Oxbow Books.
- Heffner, E. H., E. P. Blegen, and M. Burrows. 1932. Archaeological News. *American Journal of Archaeology* 36(1):43-73.
- Heinz, M. 2004. "Kamid el-Loz: From Village to City and Back to Village. 3000 Years of Settlement History in the Beqa'a Plain," in *Decade: A Decade of Archaeology and History in the Lebanon*. Edited by C. Doumet-Serhal, pp. 562-581. Beirut: The Lebanese British Friends of the National Museum.
- Heinz, M., and K. Bartl. 1997. Bey 024 'Place Debbas' Preliminary Report. *Baal* 2:236-257.

- Heinz, M., D. Bonatz, A. Gilibert, H. Heckmann, I. Holzer, C. Jauss, J. Kirchhofer, P. Knötzele, L. Petersen, M. Sommer, and T. Zaven. 2001. Kamid el-Loz in the Beqa'a plain, Lebanon: Continuity and Change in the Settlement of a Region. *Baal* 5:5-92.
- Heinz, M., A. Gross, E. John, L. Kirsch, S. Kulemann-Ossen, L. von Lengerich, C. Leschke, J. Nieling, C. von Rüden, and E. Wagner. 2004. Kamid el-Loz in the Beqa'a plain, Lebanon: Excavations in 2001, 2002 and 2004. *Baal* 8:83-118.
- Heltzer, M. 1969. "Problems of the Social History of Syria in the Late Bronze Age," in *Syria nel Tardo Bronzo*. Edited by M. Liverani, pp. 31-46. Rome: Centro per le antichità e la storia dell'arte del Vicino Oriente.
- Heltzer, M. 1976. *The Rural Community in Ancient Ugarit*. Wiesbaden: Dr Ludwig Reichert.
- Heltzer, M. 1978. *Goods, Prices and the Organisation of Trade in Ugarit (Marketing and Transportation in the Eastern Mediterranean in the Second Half of the Second Millennium BCE)*. Wiesbaden: Dr Ludwig Reichert Verlag.
- Heltzer, M. 1982. *The Internal Organisation of the Kingdom of Ugarit*. Wiesbaden: Dr Ludwig Reichert Verlag.
- Heltzer, M. 1995. "Phoenician Trade and Phoenicians in Hamath," in *Immigration and Emigration within the Ancient Near East, Orientalia Lovaniensia Analecta 65*. Edited by K. van Lerberghe and A. Schoors, pp. 101-105. Leuven: Peeters.
- Heltzer, M. 1996. "The Symbiosis of the Public and Private Sectors in Ugarit, Phoenicia, and Palestine," in *Privatization in the Ancient Near East and Classical World: a Colloquium held at New York University, November 17-18, 1994*. Edited by M. Hudson and B. Levine, pp. 177-196. Cambridge, Mass.: Peabody Museum of Archaeology and Ethnology.
- Heltzer, M. 2001. "A New Weight from Hamath and Trade Relations with the South in the Ninth-Eighth Centuries BCE," in *The World of the Aramaeans II*. Edited by P. M. M. Daviau, J. W. Wevers, and M. Weigl, pp. 133-135. Sheffield.
- Herodotus. 2003 edition. *The Histories*. London: Penguin.
- Herbert, S. 2003. "Excavating Ethnic Strata: The Search for Hellenistic Phoenicians in the Upper Galilee of Israel," in *The Politics of Archaeology and Identity in a Global Context*. Edited by S. Kane, pp. 101-113. Boston, MA: Archaeological Institute of America.
- Herzog, Z. 1992. "Settlement and Fortification Planning in the Iron Age," in *The Architecture of Ancient Israel*. Edited by A. Kempinski and R. Reich, pp. 231-274. Jerusalem: Israel Exploration Society.
- Herzog, Z., and L. Singer-Avitz. 2004. Redefining the Centre: The Emergence of State in Judah. *Tel Aviv* 31(2):209-244.
- Herzog, Z., and L. Singer-Avitz. 2006. Sub-Dividing the Iron Age IIA in Northern Israel: A Suggested Solution to the Chronological Debate. *Tel Aviv* 33(2):163-195.
- Hesiod. *Works and Days: 2006 translation by C. M. Schlegel and H. Weinfield*. Ann Arbor: University of Michigan Press.
- Hestrin, R., and E. Stern. 1973. Two "Assyrian" Bowls from Israel. *Israel Exploration Journal* 23:152-155.
- Hillers, D. R. 1964. An Alphabetic Cuneiform Tablet from Taanach. *Bulletin of the American Schools of Oriental Research* 173:45-50.

- Hitti, P. K. 1951. *History of Syria, Including Lebanon and Palestine*. London.
- Hodder, I. 1982. *Symbols in Action*. New York: Cambridge University Press.
- Hodder, I. 1986. *Reading the Past*, Cambridge.
- Hodder, I. 1987. *Archaeology as Long-Term History*. Cambridge: Cambridge University Press.
- Hodder, I. 1992. *Theory and Practice in Archaeology*. London.
- Hogarth, D. G. 1909. Carcemish and its Neighbourhood. *Liverpool Annals of Archaeology and Anthropology* 2:165-184.
- Hogarth, D. G. 1911-1912. Hittite Problems and the Excavation of Carchemish. *Proceedings of the British Academy* 1911-1912:361-374.
- Hogarth, D. G. 1914a. *Carchemish: Report on the Excavations at Djerabis on Behalf of the British Museum (conducted by C. L. Woolley and T. E. Lawrence); Part I - Introductory*. London: British Museum.
- Hogarth, D. G. 1914b. Revealing the Civilisation of the Hittites of Syria: Excavations at Carchemish. *Illustrated London News*:132-135.
- Holladay, J. S. 1990. Red Slip, Burnish, and the Solomonic Gateway at Gezer. *Bulletin of the American Schools of Oriental Research* 277/278:23-70.
- Holladay, J. S. 2001. "Toward a New Paradigmatic Understanding of Long-Distance Trade in the Ancient Near East: From the Middle Bronze II to Early Iron II - A Sketch," in *The World of the Aramaeans II: Studies in History and Archaeology in Honour of Paul-Eugene Dion, Journal for the Study of the Old Testament Supplement Series* 325. Edited by P. M. M. Daviau, J. W. Wevers, and M. Weigl, pp. 136-198. Sheffield: Sheffield Academic Press.
- Homsy, G. 2003. Des céramiques de l'Âge du Fer provenant de Byblos-Jbeil. *Baal* 7:245-279.
- Horden, P., and N. Purcell. 2000. *The Corrupting Sea: A Study of Mediterranean History*. Oxford: Blackwell.
- Hornung, E. 1964. *Untersuchungen zur Chronologie und Geschichte des Neuen Reiches*. Wiesbaden: Otto Harrassowitz.
- Horowitz, D. 1992. "Ethnic Identity," in *Ethnicity: Theory and Experience*. Edited by N. Gazer and D. Moynihan, pp. 111-140. Cambridge, MA.
- Howes, D. 1996. "Introduction: commodities and cultural borders," in *Cross-Cultural Consumption: Global Markets, Local Realities*. Edited by D. Howes, pp. 1-16. London: Routledge.
- Hourani, A. 1991. *A History of the Arab Peoples*. London: Faber and Faber.
- Hrouda, B. 1962. *Tell Halaf IV. Die Kleinfunde aus Historischer Zeit*. Berlin: Walter de Gruyter & Co.
- Hrouda, B. 1967. Forschungs- und Ausgrabungsergebnisse in Syrien seit 1960. *Mitteilungen der Deutschen Orient-Gesellschaft zu Berlin* 98:46-55.
- Hughes, J. 1990. *Secrets of the Times. Journal for the Study of the Old Testament Supplement Series*. Sheffield: JSOT Press.
- Humann, C. 1898. "Bericht über die erste Ausgrabungen von Sindjirli 1888," in *Ausgrabungen in Sendschirli II: Ausgrabungsbericht und Architektur, Mittheilungen aus den Orientalischen Sammlungen Heft 12*. Edited by F. von Luschan, pp. 88-102. Berlin: W. Spemann.
- Humbert, J.-B. 1993. "Keisan, Tell," in *The New Encyclopaedia of Archaeological Excavations in the Holy Land*. Edited by E. Stern, pp. 862-867. New York: Simon and Schuster.
- Hunt, L. 1989. "Introduction: history, culture, and text," in *The New Cultural History*. Edited by L. Hunt, pp. 1-22. Berkeley.

- Iggers, G. G. 1995. Historicism: The History and Meaning of the Term. *Journal of the History of Ideas* 56:129-152.
- Ingholt, H. 1934. *Rapport Preliminaire sur la Premiere Campagne de Hama*. Kobenhavn: Ejnar Munksgaard.
- Ingholt, H. 1940. *Rapport Preliminaire sur Sept Campagnes de Fouilles a Hama en Syrie*. Kobenhavn: Ejnar Munksgaard.
- Ingholt, H. 1942. The Danish Excavations at Hama on the Orontes. *American Journal of Archaeology* 46(4):469-476.
- Isajiw, W. W. 1974. Definition of Ethnicity. *Ethnicity* 1:111-124.
- Isserlin, B. S. J. 1982. "The Earliest Alphabetic Writing," in *The Prehistory of the Balkans; and the Middle East and the Aegean World, Tenth to Eighth Centuries B.C., Cambridge Ancient History III.1 (Second Edition)*. Edited by J. Boardman, I. E. S. Edwards, N. G. L. Hammond, and E. Sollberger, pp. 794-833. Cambridge: Cambridge University Press.
- Isserlin, B. S. J. 1983. "Phoenician and Punic Rural Settlement and Agriculture: Some Archaeological Considerations," in *Atti del I Congresso Internazionale di Studi Fenici e Punici, Roma, 5-10 Novembre 1979, Volume Primo*. Edited by S. Moscati, pp. 157-164. Roma: Consiglio Nazionale Delle Ricerche.
- Jabak, S., J. Sapin, J. Elayi, and H. Sayegh. 1998. "Les Jarres et Amphores du Locus 130," in *Un Quartier du Port Phenicien de Beyrouth au Fer III/Perse. Les Objets, Supplement no. 6 a Transeuphratene*. Edited by J. Elayi and H. Sayegh, pp. 25-43. Paris: Gabalda.
- James, P. 1987. Southeastern Anatolia and Northern Syria: Dating Neo-Hittite Art and Architecture. *Journal of the Ancient Chronology Forum* 1:36-40.
- James, P., I. J. Thorpe, N. Kokkinos, R. Morkot, and J. A. Frankish. 1991. *Centuries of Darkness. A Challenge to the Conventional Chronology of Old World Archaeology*. London: Jonathan Cape.
- James, W. F. 1966. *The Iron Age at Beth Shean: A Study of Levels VI - IV*. Philadelphia: University Museum.
- Jamieson, A. S. 1990. "Area A - Pottery," in *Tell Ahmar: 1988 Season, Abr-Nahrain Supplement Series 2*. Edited by G. Bunnens, pp. 25-105. Leuven: Orientaliste.
- Jamieson, A. S. 1999. "Neo-Assyrian Pottery from Tell Ahmar," in *Iron Age Pottery in Northern Mesopotamia, Northern Syria and South-Eastern Anatolia : papers presented at the meetings of the international "table ronde" at Heidelberg (1995) and Nieborów (1997) and other contributions, Altertumskunde des vorderen Orients ; Bd. 10*. Edited by A. Hausleiter and A. Reiche, pp. 287-308. Münster: Ugarit-Verlag.
- Jamieson, A. S. 2000. "Identifying Room Use and Vessel Function: A Case Study of Iron Age Pottery from Building C2 at Tell Ahmar, North Syria," in *Essays on Syria in the Iron Age, Ancient Near Eastern studies. Supplement 7*. Edited by G. Bunnens, pp. 259-303. Louvain: Peeters Press.
- Jamieson, A. S. 2005. PhD Thesis, University of Melbourne.
- Jenkins, I. 1992. *Archaeologists and Aesthetes*. London.
- Jensen, J. 1996. "Report of the Excavation at the Southern Harbour of Sukas August 27th - November 9th 1960," in *Sukas X: The Bronze and Early Iron Age Remains at the Southern Harbour, Publications of the Carlsberg Expedition to Phoenicia 12. Historisk-filosofiske skrifter (Kongelige Danske Videnskabernes Selskab) 17*. Edited by P. J. Riis, J. Jensen, M.-L. Buhl, and B. Otzen, pp. 11-24. Copenhagen: Munksgaard.
- Jidejian, N. 1971. *Byblos Through the Ages*. Beirut: Dar el-Marcheq Publishers.

- Jidejian, N. 1992. "An Introduction to Tyre," in *The Heritage of Tyre. Essays on the History, Archaeology, and Preservation of Tyre*. Edited by M. S. Joukowsky, pp. 7-12. Dubuque, Iowa: Kendall Hunt Publishing Company.
- Johansen, K. F. 1923. *Les vases sicyoniens: étude archéologie*. Paris: E. Champion.
- Johns, C. N. 1931. Excavations at Pilgrim's Castle ('Atlit). *Quarterly of the Department of Antiquities in Palestine* 1:111-129.
- Johns, C. N. 1932. Excavations at 'Atlit (1930-1931): The South-Eastern Cemetery. *Quarterly of the Department of Antiquities in Palestine* 2:41-104, Pls XIV-XXXVII.
- Johns, C. N. 1934. Excavations at Pilgrim's Castle, 'Atlit, (1932); The Ancient Tell and the Outer Defences of the Castle. *Quarterly of the Department of Antiquities in Palestine* 3:145-164, Pls LVIII-LXV.
- Johns, C. N. 1935. Excavations at Pilgrim's Castle, 'Atlit, (1931-2); An Unfinished Church in the Suburb. *Quarterly of the Department of Antiquities in Palestine* 4:122-137; Pls LXXI-LXXV.
- Johns, C. N. 1938. Excavations at Pilgrims' Castle, 'Atlit (1933): Cremated Burials of Phoenician Origin. *Quarterly of the Department of Antiquities in Palestine* 6:121-152.
- Johns, C. N. 1993. "Athlit," in *The New Encyclopedia of Archaeological Excavations in the Holy Land*. Edited by E. Stern, pp. 112-117. New York: Simon & Schuster.
- Jones, A. 1999. The World on a Plate: Ceramics, Food Technology and Cosmology in Neolithic Orkney. *World Archaeology* 31(1):55-77.
- Jones, S. 1997. *The Archaeology of Ethnicity: Constructing Identities in the Past and Present*. London.
- Joukowsky, M. S. 1972. The Pottery of Tell el Ghassil in the Beqa'a: A comparative study and analysis of the Iron Age and Bronze Age wares (Unpublished Masters Thesis), American University of Beirut.
- Joukowsky, M. S. 1997. "Byblos," in *The Oxford Encyclopedia of Archaeology in the Near East. Vol. 1*. Edited by E. M. Meyers, pp. 390-394. Oxford: Oxford University Press.
- Kadioğlu, A. 1996. The Paradox of Turkish Nationalism and the Construction of Official Identity. *Middle Eastern Studies* 32:177-193.
- Kamp, K., and N. Yoffee. 1980. Ethnicity in Ancient Western Asia During the Early Second Millennium BC: Archaeological Assessments and Ethnoarchaeological Prospectives. *Bulletin of the American Schools of Oriental Research* 237:85-104.
- Karageorghis, V., N. Coldstream, P. M. Bikai, A. W. Johnston, M. Robertson, and L. Jehasse. 1981. *Excavations at Kition, 4. The Non-Cypriote Pottery*. Nicosia: Department of Antiquities.
- Karageorghis, V., and M. Demas. 1985. *Excavations at Kition, 5. The Pre-Phoenician Levels: areas I and II*. Nicosia: Department of Antiquities.
- Karam, N. 1997. Bey 013 Rapport préliminaire. *Baal* 2:95-113.
- Kenyon, K. M. 1964. Megiddo, Hazor, Samaria and Chronology. *Bulletin of the Institute of Archaeology, The University of London* 4:143-156.
- Kepecs, S. 1997a. Introduction to New Approaches to Combining the Archaeological and Historical Records. *Journal of Archaeological Method and Theory* 4(3/4):193-198.



- Kestemont, G. 1985. "Les Phéniciens en Syrie du Nord," in *Phoenicia and Its Neighbours, Studia Phoenicia* 3. Edited by E. Gubel and E. Lipinski, pp. 135-161. Leuven: Uitgeverij Peeters.
- Keswani, P. 1989. Dimensions of Social Hierarchy in Late Bronze Age Cyprus: An Analysis of the Mortuary Data from Enkomi. *Journal of Mediterranean Archaeology* 2:49-86.
- Keswani, P. 2004. *Mortuary Ritual and Society in Bronze Age Cyprus. Monographs in Mediterranean Archaeology*. London: Equinox.
- Khalifeh, I. A. 1988. *Sarepta II. The Late Bronze and Iron Age Periods of Area II, X*. Beirut.
- Khalifeh, I. A. 1997a. "Sarepta," in *The Oxford Encyclopedia of Archaeology in the Near East. Vol. 4*. Edited by E. M. Meyers, pp. 488-491. Oxford: Oxford University Press.
- Khalifeh, I. A. 1997b. "Beirut," in *The Oxford Encyclopedia of Archaeology in the Near East. Vol. 1*. Edited by E. M. Meyers, pp. 292-295. Oxford: Oxford University Press.
- Khayyata, W., and K. Kohlmeyer. 1998. Die Zitadelle von Aleppo. *Damaszener Mitteilungen* 10:69-96.
- Khayyata, W., and K. Kohlmeyer. 2000. "Syro-German Excavations on the Citadel of Aleppo, 1996 and 1997," in *Proceedings of the First International Congress on the Archaeology of the Ancient Near East, Rome, May 18-23, 1998. Volume I*. Edited by P. Matthiae, A. Enea, L. Peyronel, and F. Pinnock, pp. 733-742. Rome: Università degli Studi di Roma 'La Sapienza'.
- Killebrew, A. E. 2005. *Biblical Peoples and Ethnicity; An Archaeological Study of Egyptians, Canaanites, Philistines, and Early Israel 1300-1100 B.C.E.* Atlanta: Society of Biblical Literature.
- Kinet, D. 1981. *Ugarit - Geschichte und Kultur einer Stadt in der Umwelt des Alten Testaments. Stuttgarter Bibelstudien 104*. Stuttgart: Verlag Katholisches Bibelwerk GmbH.
- King, L. W. 1909. Note on the Inscription upon the Eastern Lion at Tell-Ahmar. *Liverpool Annals of Archaeology and Anthropology* 2:185-186.
- King, L. W. 1915. *Bronze Reliefs from The Gates of Shalmaneser, King of Assyria B.C. 860-825*. London: British Museum.
- Kirk, G. S. 1975. "The Homeric Poems as History," in *History of the Middle East and the Aegean Region c. 1380-1000 B.C., Cambridge Ancient History II.2 (First Edition)*. Edited by I. E. S. Edwards, C. J. Gadd, N. G. L. Hammond, and E. Sollberger, pp. 820-850. Cambridge: Cambridge University Press.
- Kitchen, K. A. 1986. *The Third Intermediate Period in Egypt*. Warminster: Aris & Philips.
- Kitchen, K. A. 1991. The Chronology of Ancient Egypt. *World Archaeology* 23:201-208.
- Kitchen, K.A. 2003. "Egyptian Interventions in the Levant in Iron Age II" in *Symbiosis, Symbolism, and the Power of the Past. Canaan, Ancient Israel, and Their Neighbours from the Late Bronze Age through Roman Palaestina*. Edited by W. G. Dever and S. Gitin, pp. 113-132. Winona Lake, IN: Eisenbrauns.
- Kitchen, K. A. 2007. "Egyptian and Related Chronologies - Look, no Science, no Pots!," in *The Synchronisation of Civilisations in the Eastern Mediterranean in the Second Millennium B.C. III*. Edited by M. Bietak and E. Czerny, pp. 163-171. Vienna: Verlag der Österreichischen Akademie der Wissenschaften.

- Klengel, H. 1984. Sumur/Simyra und die Eleutheros Ebene in der Geschichte Syriens. *Klio* 66:5-18.
- Klengel, H. 1992. *Syria 3000 to 300 B.C.: A Handbook of Political History*. Berlin: Akademie Verlag.
- Klengel, H. 2000a. "The 'Crisis Years' and the New Political System in Early Iron Age Syria: Some Introductory Remarks," in *Essays on Syria in the Iron Age., Ancient Near Eastern studies. Supplement 7*. Edited by G. Bunnens, pp. 21-30. Louvain: Peeters Press.
- Klengel, H. 2000b. Qatna 1999-Ein historischer Überblick. *Mitteilungen der Deutschen Orient-Gesellschaft zu Berlin* 132:239-252.
- Klengel-Brandt, E. 1990. "Kleinfunde aus Deve Hoyuk bei Karkamisch im Vorderasiatischen Museum Berlin," in *Resurrecting the Past: A Joint Tribute to Adnan Bounni*. Edited by P. Matthiae, M. Van Loon, and H. Weiss, pp. 133-151. Istanbul: Nederlands Historisch-Archaeologisch Instituut te Istanbul.
- Kletter, R. 2006. *Just Past? The Making of Israeli Archaeology*. London: Equinox.
- Knapp, A. B. 1992a. "Archaeology and *Annales*: time, space, and change," in *Archaeology, Annales, and Ethnohistory*. Edited by A. B. Knapp, pp. 1-21. Cambridge: Cambridge University Press.
- Knapp, A. B. 1992b. "Independence and Imperialism: Politico-Economic Structures in the Bronze Age Levant," in *Archaeology, Annales, and Ethnohistory*. Edited by A. B. Knapp, pp. 83-98. Cambridge: Cambridge University Press.
- Knapp, A. B. 1996. Archaeology Without Gravity: Postmodernism and the Past. *Journal of Archaeological Method and Theory* 3:127-158.
- Knapp, A. B. 1998. "Mediterranean Bronze Age trade: distance, power and place," in *The Aegean and the Orient in the Second Millennium. Proceedings of the 50th Anniversary Symposium, Cincinnati, 18-20 April 1997*. Edited by E. H. Cline and D. Harris-Cline, pp. 193-205. Liege: Annales d'archéologie égéenne de l'Université de Liège et UT-PASP.
- Koehl, R. B. 1985. *Sarepta III: The Imported Bronze and Iron Age Wares from Area II, X*. Beirut.
- Kohl, P. L. 1989. "The Material Culture of the Modern Era in the Ancient Orient: Suggestions for Future Work," in *Domination and Resistance, One World Archaeology 3*. Edited by D. Miller, M. J. Rowlands, and C. Tilley, pp. 240-245. London: Unwin Hyman Ltd.
- Kohl, P. L., and C. Fawcett. Editors. 1995a. *Nationalism, Politics, and the Practice of Archaeology*. Cambridge: Cambridge University Press.
- Kohl, P. L., and C. Fawcett. 1995b. "Archaeology in the service of the state: theoretical considerations," in *Nationalism, Politics, and the Practice of Archaeology*. Edited by P. L. Kohl and C. Fawcett, pp. 3-18. Cambridge: Cambridge University Press.
- Kohl, P. L., and G. R. Tsetschkladze. 1995. "Nationalism, politics, and the practice of archaeology in the Caucasus," in *Nationalism, Politics, and the Practice of Archaeology*. Edited by P. L. Kohl and C. Fawcett, pp. 149-174. Cambridge: Cambridge University Press.
- Kohlmeyer, K. 2000. *Der Tempel des Wettergottes von Aleppo*. Munster: Rhema-Verlag.
- Koldewey, R. 1898. "Die Architektur von Sendschirli," in *Ausgrabungen in Sendschirli II: Ausgrabungsbericht und Architektur, Mittheilungen aus den*

- Orientalischen Sammlungen Heft 12*. Edited by F. von Luschan, pp. 103-199. Berlin: W. Spemann.
- Koşay, H. Z. 1951. *Alaca Höyük Kazisi = Les Fouilles d'Alaca Höyük: Entreprises par la Societe d'Histoire Turque. Rapport Preliminaire sur les Travaux en 1937-1939*. Ankara: Türk Tarih Kurumu Basimevi.
- Kraeling, E. G. H. 1918. *Aram and Israel*. New York.
- Kramer, C. 1977. "Pots and People," in *Mountains and Lowlands*. Edited by L. Levine and T. C. Young, pp. 91-112. Malibu: Undena.
- Krogman, W. M. 1949. Ancient Cranial Types at Chatal Hüyük and Tell al-Judaidah, Syria, from the Late Fifth Millennium B. C. to the mid-Seventh Century A. D. *Belleten* 13:407-478.
- Kuhne, H. 2002. "Thoughts About Assyria After 612 BC," in *Of Pots and Plans: Papers on the Archaeology and History of Mesopotamia and Syria Presented to David Oates in Honour of His 75th Birthday*. Edited by L. al-Galiani Werr, J. Curtis, H. Martin, A. McMahon, J. Oates, and J. Reade, pp. 171-175: Nabu Publications.
- Kuhrt, A. 1995. *The Ancient Near East c. 3000-330 BC*. Vol. II London and New York: Routledge.
- Kuniholm, P. I., S. L. Tarter, and C. B. Griggs. 1993. "Appendix 2: Dendrochronological Report," in *Tille Höyük 4. The Late Bronze Age and the Iron Age Transition, British Institute of Archaeology at Ankara Monograph 15*. Edited by G. D. Summers, pp. 179-190. London: The British Institute of Archaeology at Ankara.
- Kuschke, A. 1966. "Die Biqa', ihre altorientalischen Siedlungen und Verkherwege," in *Bericht über die Ergebnisse der Ausgrabungen in Kamid el-Loz (Libanon) in den Jahren 1963 und 1964, Saarbrucker Beiträge zur Altertumskunde Band 3*. Edited by R. Hachmann and A. Kuschke, pp. 15-30. Bonn: Rudolf Habelt Verlag.
- Kuschke, A. 1978. Preliminary Remarks on an Archaeological Survey in the Northern Biqa'. *Bulletin du Musée de Beyrouth* 30:43-45.
- Lagarce, J. 1983. "Rapports de Ras Ibn Hani avec la Phénicie et la Méditerranée Orientale à l'Âge du Fer," in *Atti del I Congresso Internazionale di Studi Fenici e Punici, Roma, 5-10 Novembre 1979, Volume Primo*. Edited by S. Moscati, pp. 223-226. Roma: Consiglio Nazionale Delle Ricerche.
- Lagarce, E., and J. Lagarce. 2000. "Coastal Syria and Lebanon," in *The Synchronisation of Civilisations in the Eastern Mediterranean in the Second Millennium B.C.* Edited by M. Bietak, pp. 140-146. Vienna: Verlag der Österreichischen Akademie der Wissenschaften.
- Lagarce, J., and E. Lagarce. 1992. Ras Ibn Hani. *Chronique Archeologique en Syrie* 1:117-120.
- Lagarce, J., and E. Lagarce. 1995. "Ras Ibn Hani au Bronze Recent," in *Les Pays d'Ougarit autour de 1200 av. J.-C. Histoire et archéologie. Actes du Colloque International Paris, 28 juin - 1er juillet 1993, Ras Shamra-Ougarit XI*. Edited by M. Yon, M. Szyner, and P. Bordreuil, pp. 141-154. Paris: Éditions Recherche sur les Civilisations.
- Lamon, R. S. 1948. "The City Gate," in *Megiddo II. Seasons of 1935-1939*. Edited by G. Loud, pp. 46-57. Chicago: University of Chicago.
- Lamon, R. S., and G. M. Shipton. 1939. *Megiddo I. Seasons of 1925-1934 Strata I-IV*. Chicago: University of Chicago.

- Landsberger, B. 1948. *Sam'al: Studien zur Entdeckung der Ruinenstaette Karatepe. Veroffentlichungen der Turkischen Historischen Gesellschaft VII Serie Nr. 16.* Ankara: Druckerei der Turkischen Historischen Gesellschaft.
- Lanfranchi, G. B., and S. Parpola. 1990. *The Correspondence of Sargon II. Part II Letters from the Northern and Northeastern Provinces. State Archives of Assyria V.* Helsinki: Helsinki University Press
- Lapointe, R. 1970. Etymologie sémitique de Syrie. *Vetus Testamentus* 20(2):233-236.
- Lapp, P. 1970. "The Pottery of Palestine in the Persian Period," in *Archäologie und Altres Testament, Festschrift für Kurt Galling zum 8 Jan 1970.* Edited by A. Kuschke and E. Kutsch, pp. 179-198. Tübingen: Mohr.
- Larsen, M. T. 1987a. Orientalism and the Ancient Near East. *Culture and History* 2:96-115.
- Larsen, M. T. 1987b. "Commercial Networks in the Ancient Near East," in *Centre and Periphery in the Ancient World, New directions in archaeology.* Edited by M. J. Rowlands, M. T. Larsen, and K. Kristiansen, pp. 47-56. Cambridge.
- Larsen, M. T. 1989. "Orientalism and Near Eastern Archaeology," in *Domination and Resistance, One World Archaeology 3.* Edited by D. Miller, M. J. Rowlands, and C. Tilley, pp. 229-239. London.
- Larsen, M. T. 1996. *The Conquest of Assyria: Excavations in an Antique Land 1840-1860.* London.
- Lebeau, M. 1983. *La Ceramique de l'Age du Fer II-III a Tell Abou Danne: et ses rapports avec la ceramique contemporaine en Syrie.* Paris.
- Lehmann, G. 1996. *Untersuchungen zur späten Eisenzeit in Syrien und Libanon : Stratigraphie und Keramikformen zwischen ca. 720 bis 300 v. Chr. Altertumskunde des vorderen Orients ; Bd. 5.* Münster: Ugarit-Verlag.
- Lehmann, G. 1998. Trends in the Local Pottery Development of the Late Iron Age and Persian Period in Syria and Lebanon, ca. 700 to 300 B.C. *Bulletin of the American Schools of Oriental Research* 311:35-54.
- Lehmann, G. 2001. "Phoenicians in Western Galilee: First Results of an Archaeological Survey in the Hinterland of Akko," in *Studies in the Archaeology of the Iron Age in Israel and Jordan, Journal for the Study of the Old Testament Supplement Series 331.* Edited by A. Mazar and V. T. Mathias, pp. 65-112. Sheffield: Sheffield Academic Press.
- Lehmann, G. 2002a. *Bibliographie der archäologischen Fundstellen und Surveys in Syrien und Libanon. Orient-Archäologie ; Bd. 9.* Rahden/Westf.: M. Leidorf.
- Lehmann, G. 2002b. "Zur Siedlungsgeschichte des Hinterlandes von Akko (Israel) in der Eisenzeit. Erste Ergebnisse einer archaologischen Landesaufnahme.," in *Ausgrabungen und Surveys im Vorderen Orient I, Orient-Archäologie 5.* Edited by R. Eichmann, pp. 49-78. Rahden/Westf.: Verlag Marie Leidorf GmbH.
- Levi-Strauss, C. 1966. The Culinary Triangle. *Partisan Review* 33:586-595.
- Levi-Strauss, C. 1968. *Structural Anthropology vol. I:* Penguin Press.
- Levi-Strauss, C. 1970. *The Raw and the Cooked.* New York: Harper Torchbooks.
- Levine, P. 1986. *The Amateur and the Professional: Antiquarians, Historians and Archaeologists in Victorian England, 1838-1886.* Cambridge.
- Levy, T. E., and T. Higham. 2005. "Introduction: Radiocarbon Dating and the Iron Age of the Southern Levant: Problems and potentials for the Oxford conference," in *The Bible and Radiocarbon Dating: Archaeology, Text and Science.* Edited by T. E. Levy and T. Higham, pp. 3-14. London: Equinox.

- Lie, A. G. 1929. *The Inscriptions of Sargon II, King of Assyria, Part 1. The Annals*. Paris.
- Lillios, K. T. 1995. "Nationalism and Copper Age Research in Portugal During the Salazar Regime (1932-1974)," in *Nationalism, Politics, and the Practice of Archaeology*. Edited by P. L. Kohl and C. Fawcett, pp. 57-69. Cambridge: Cambridge University Press.
- Lipinski, E. 1991. "The Territory of Tyre and the Tribe of Asher," in *Phoenicia and the Bible: Proceedings of the Conference held at the University of Leuven on the 15th and 16th of March 1990, Studi Phoenicia 9*. Edited by E. Lipinski, pp. 153-166. Leuven: Uitgeverij Peeters.
- Lipinski, E. 2000a. *The Aramaeans Their Ancient History, Culture, Religion*. Leuven: Peeters Press.
- Lipinski, E. 2000b. "The Linguistic Geography of Syria in Iron Age II (c. 1000-600 B.C.)," in *Essays on Syria in the Iron Age, Ancient Near Eastern studies. Supplement 7*. Edited by G. Bunnens, pp. 125-142. Louvain: Peeters Press.
- Liverani, M. 1983. "Dall'acculturazione alla deculturazione: considerazioni sul ruolo dei contatti politici ed economici nella storia siro-palestinese pre-ellenistica," in *Modes de contact et processus de transformation dans les sociétés anciennes*, pp. 503-522. Pisa and Rome.
- Liverani, M. 1987. "The Collapse of the Near Eastern Regional System at the End of the Bronze Age: The Case of Syria," in *Centre and Periphery in the Ancient World, New directions in archaeology*. Edited by M. J. Rowlands, M. T. Larsen, and K. Kristiansen, pp. 66-73. Cambridge: Cambridge University Press.
- Liverani, M. 1988. The Growth of the Assyrian Empire in the Habur/Middle Euphrates Area: A New Paradigm. *State Archives of Assyria Bulletin* 2:81-98.
- Liverani, M. Editor. 1990. *Prestige and Interest: International Relations in the Near East ca. 1600-1000 B.C.* Padova: Sargon Press.
- Liverani, M. 1994. History as a War Game. *Journal of Mediterranean Archaeology* 7:241-248.
- Liverani, M. 1996. "Ancient Propaganda and Historical Criticism," in *The Study of the Ancient Near East in the Twenty-First Century*. Edited by J. S. Cooper and G. M. Schwartz, pp. 283-289. Winona Lake, Indiana: Eisenbrauns.
- Liverani, M. 1997a. "Ancient Near Eastern Cities and Modern Ideologies," in *Die Orientalische Stadt: Kontinuität, Wandel, Bruch*. Edited by G. Wilhelm, pp. 85-107. Saarbrücken.
- Liverani, M. 1997b. "Beyond Deserts, Beyond Oceans," in *Profumi d'Arabia, Saggi di Storia Antica 11*. Edited by A. Avanzini, pp. 557-564. Rome: L'Erma di Bretschneider.
- Liverani, M. 1999. "History and Archaeology in the Ancient Near East: 150 Years of a Difficult Relationship," in *Fluchtpunkt Uruk. Archäologische Einheit aus Methodischer Vielfalt. Schriften für Hans Jorg Nissen, Internationale Archäologie Studia Honoria 6*. Edited by H. Kuhne, R. Bernbeck, and K. Bartl, pp. 1-11. Rahden.
- Liverani, M. 2003. "The Influence of Political Institutions on Trade in the Ancient Near East (Late Bronze to Early Iron Age)," in *Mercanti e Politica Nel Mondo Antico, Saggi di Storia Antica 21*. Edited by C. Zaccagnini, pp. 119-137. Roma: L'Erma di Bretschneider.
- Liverani, M. 2004. *Myth and Politics in Ancient Near Eastern Historiography*. Ithaca, New York: Cornell University Press.

- Liverani, M. 2005a. "Imperialism," in *Archaeologies of the Middle East: Critical Perspectives*. Edited by S. Pollock and R. Bernbeck, pp. 223-243. Oxford: Blackwell.
- Liverani, M. 2005b. *Israel's History and the History of Israel*. London: Equinox.
- Lloyd, S. 1947. *Foundations in the Dust: A Story of Mesopotamian Exploration*. London.
- London, G. A. 1989. A Comparison of Two Contemporaneous Lifestyles of the Late Second Millennium BC. *Bulletin of the American Schools of Oriental Research* 273:37-55.
- London, G. A. 2003. "Ethnicity and Material Culture," in *Near Eastern Archaeology: A Reader*. Edited by S. Richard, pp. 146-149. Winona Lake, Indian: Eisenbrauns.
- Long, B. O. 1993. Mythic Trope in the Autobiography of William Foxwell Albright. *Biblical Archaeologist* 56:36-45.
- Long, B. O. 1997. "Historical Imaginings, Ideological Gestures: W.F. Albright and the 'Reasoning Faculties of Man'," in *The Archaeology of Israel: Constructing the Past, Interpreting the Present, Journal for the Study of the Old Testament Supplement Series 237*. Edited by N. A. Silberman and D. Small, pp. 82-94. Sheffield: Sheffield Academic Press.
- Loud, G. 1948. *Megiddo II. Seasons of 1935-1939*. Chicago: University of Chicago.
- Lowenthal, D. 1985. *The Past is a Foreign Country*. Cambridge: Cambridge University Press.
- Luciani, M. 2000. "Iron Age Graves in Northern Syria: The Tell Shiukh Fawqani Evidence," in *Proceedings of the First International Congress on the Archaeology of the Ancient Near East, Rome, May 18-23, 1998. Volume I*. Edited by P. Matthiae, A. Enea, L. Peyronel, and F. Pinnock, pp. 803-814. Rome: Universita degli Studi di Roma 'La Sapienza'.
- Luciani, M. 2002. "Operation K," in *Excavating Qatna, I. Preliminary Report on the 1999 and 2000 Campaigns of the Joint Syrian-Italian-German Archaeological Research Project at Tell Mishrifeh, Documents d'Archeologie Syrienne IV*. Edited by M. al-Maqdissi, M. Luciani, D. Morandi Bonacossi, M. Novák, and P. Pfälzner, pp. 145-168. Damascus.
- Luciani, M. 2005. "Area G: The Iron Age Productive Area (Period IX) and the Inhumation Cemetery (Period X)," in *Tell Shiyukh Fawqani 1994-1998*. Edited by L. Bachelot and F. M. Fales, pp. 719-993. Padova: Sargon Editrice e Libreria.
- Luckenbill, D. D. 1926. *Ancient Records of Assyria and Babylonia, Vol. I*. Chicago.
- Luckenbill, D. D. 1927. *Ancient Records of Assyria and Babylonia, Vol. II: From Sargon to the End*. Chicago.
- Luke, J. 2003. *Ports of Trade, Al Mina and Geometric Greek Pottery in the Levant. BAR International Series 1100*. Oxford: Archeopress.
- Lund, J. 1986. *Sukas VIII: The Habitation Quarters. Publications of the Carlsberg Expedition to Phoenicia 10. Historisk-filosofiske skrifter (Kongelige Danske Videnskabernes Selskab) 12*. Copenhagen: Munksgaard.
- Lundquist, J. M. 1983. Tell Qarqur. The 1983 Season. *Les Annales Archeologiques Arabes Syriennes* 33:272-288.
- MacClancy, J. 1992. *Consuming Culture*. London: Chapmans.
- MacGilivray, J. A. 2004. "A Middle Minoan Cup from Sidon," in *Decade: A Decade of Archaeology and History in the Lebanon*. Edited by C. Doumet-Serhal, pp. 124-131. Beirut: The Lebanese British Friends of the National Museum.

- Macridi-Bey, T. 1904a. A travers les nécropoles sidoniennes. *Revue Biblique* 1:547-572.
- Macridi-Bey, T. 1904b. Le temple d'Echmoun à Sidon, fouilles exécutées par le Musée impérial ottoman. *Revue Biblique* 1:390-403.
- Magazzù, G. 2002. Afis 2000-2001. Area N: le fortificazioni orientali dell acropoli. *Egitto e Vicino Oriente* 25:54-58.
- Maggioli, A. 2002. Afis 2000-2001. Area B: indagini sulla porta urbica del Ferro II-III. *Egitto e Vicino Oriente* 25:23-24.
- Mahdi, M. 1964. *Ibn Khaldun's Philosophy of History*. Chicago: University of Chicago Press.
- Maisels, C. K. 1993. *The Near East: Archaeology in the 'Cradle of Civilization'. The Experience of Archaeology*. London.
- Maisels, C. K. 1999. *Early civilisations of the Old World: The Formative Histories of Egypt, the Levant, Mesopotamia, India and China*. London.
- Makinson, M. 1999. "La culture matérielle du moyen Euphrate au premier millénaire avant J.C.," in *Archaeology of the Upper Syrian Euphrates, The Tishrin Dam Area: Proceedings of the International Symposium Held at Barcelona, January 28th-30th 1998*. Edited by G. del Olmo Lete and J.-L. Montero Fenollos, pp. 363-391. Barcelona: Editorial AUSA.
- Makinson, M. 2005. "La stratigraphie générale et l'occupation de l'Âge du Fer (architecture et matériel)," in *Tell Shiyukh Fawqani 1994-1998*. Edited by L. Bachelot and F. M. Fales, pp. 411-580. Padova: Sargon Editrice e Libreria.
- Malamat, A. 1973. "The Aramaeans," in *Peoples of Old Testament Times*. Edited by D. J. Wiseman, pp. 134-155. Oxford: Clarendon Press.
- Mallowan, M. E. L. 1937. The Syrian City of Til Barsip. *Antiquity* 11:328-339.
- Mallowan, M. E. L. 1972. Carchemish: Reflections on the Chronology of the Sculpture. *Anatolian Studies* 22:63-85.
- al-Maqdissi, M. 1990. Tell Kazel, Syria: Excavations of the AUB Museum, 1985-1987, Preliminary Reports: Area III. *Berytus* 38:87-93.
- al-Maqdissi, M. 1993. Chronique des Activités Archeologiques en Syrie (I). *Syria* 70:443-560.
- al-Maqdissi, M. 2001. Kurzbericht über die syrischen Ausgrabungen in Misrife-Qatna. *Mitteilungen der Deutschen Orient-Gesellschaft zu Berlin* 133:141-155.
- al-Maqdissi, M. 2003. Ergebnisse der siebten und achten syrischen Grabungskampagne 2001 und 2002 in Mišrife - Qatna. *Mitteilungen der Deutschen Orient-Gesellschaft zu Berlin* 135:219-245.
- al-Maqdissi, M. and M. Badawi. 2002. "Rapport Préliminaire sur la sixième campagne des fouilles syriennes à Mishrifeh/Qatna," in *Excavating Qatna, I. Preliminary Report on the 1999 and 2000 Campaigns of the Joint Syrian-Italian-German Archaeological Research Project at Tell Mishrifeh, Documents d'Archeologie Syrienne IV*. Edited by M. al-Maqdissi, M. Luciani, D. Morandi Bonacossi, M. Novák, and P. Pfälzner, pp. 25-62. Damascus.
- al-Maqdissi, M., M. Luciani, D. Morandi Bonacossi, M. Novák, and P. Pfälzner. 2002a. "Introduction," in *Excavating Qatna, I. Preliminary Report on the 1999 and 2000 Campaigns of the Joint Syrian-Italian-German Archaeological Research Project at Tell Mishrifeh, Documents d'Archeologie Syrienne IV*. Edited by M. al-Maqdissi, M. Luciani, D. Morandi Bonacossi, M. Novák, and P. Pfälzner, pp. 7-16. Damascus.

- al Maqdissi, M., M. Luciani, D. Morandi Bonacossi, M. Novák, and P. Pfälzner. Editors. 2002b. *Excavating Qatna, I. Preliminary Report on the 1999 and 2000 Campaigns of the Joint Syrian-Italian-German Archaeological Research Project at Tell Mishrifeh*. Damascus.
- Marchand, S. 1996. "Orientalism as *Kulturpolitik*: German Archaeology and Cultural Imperialism in Asia Minor," in *Volksgeist as Method and Ethic: Essays on Boasian Ethnography and the German Anthropological Tradition, History of Anthropology* 8. Edited by G. W. Stocking, pp. 298-336. Madison, WI: University of Wisconsin Press.
- Marfoe, L. 1995. *Kamid el-Loz 13: The Prehistoric and Early Historic Context of the Site. Saarbrucker Beiträge zur Alterumskunde Bd. 41*. Bonn.
- Marfoe, L. 1998. *Kamid el-Loz 14: Settlement History of the Biq'a up to the Iron Age. Saarbrücker Beiträge zur Altertumskunde Bd. 53*. Bonn: Rudolph Habelt Verlag GMBH.
- Margueron, J. 1979. "Un <hilani> á Emar," in *Archaeological Reports From the Tabqa Dam Project - Euphrates Valley, Syria*. Edited by D. N. Freedman, pp. 153-176. Cambridge, MA: American Schools of Oriental Research.
- Margueron, J. 1985. "Les palais syriens à l'Âge du Bronze," in *Le système palatial en Orient, en Grèce et à Rome, Travaux du Centre de Recherche sur le Proche-Orient et la Grèce Antiques*. Edited by E. Levy, pp. 127-158. Strasbourg: Université des Sciences Humaines.
- Marquis, P. 2004. "Les fouilles du Centre-Ville de Beyrouth. Dix ans après," in *Decade: A Decade of Archaeology and History in the Lebanon*. Edited by C. Doumet-Serhal, pp. 266-279. Beirut: The Lebanese British Friends of the National Museum.
- Marquis, P., and R. Ortali-Tarazi. 1996. Bey 009 L'immeuble de la Banco di Roma; Nouveaux éléments pour l'étude du forum de Béryte. *Baal* 1:148-175.
- Maspero, G. 1896. *The Struggle of the Nations. Translated from the French by M. L. McClure*. New York: Appleton.
- Masry, A. H. 1981. Traditions of Archaeological Research in the Near East. *World Archaeology* 13:222-239.
- Matermawi, M. 2005. Tell Afis, Siria (2002-2004) Area A3. *Egitto e Vicino Oriente* 28:30-31.
- Mathias, V. T., and P. J. Parr. 1989. The Early Phases at Tell Nebi Mend: A Preliminary Account. *Levant* 21:13-32.
- Matthäus, H. 1980. *Die Bronzegefäße der kretisch-mykenischen Kultur. Prähistorische Bronzefunde II.1*. München: C.H. Beck'sche Verlagsbuchhandlung.
- Matthäus, H. 1985. *Metallgefäße und Gefäßuntersätze der Bronzezeit, der geometrischen und archaischen Periode auf Cypern, mit einem Anhang der bronzzeitlichen Schwertfunde auf Cypern. Prähistorische Bronzefunde II.8*. München: C.H. Beck'sche Verlagsbuchhandlung.
- Matthers, J. 1978. Tell Rifa'at 1977: Preliminary Report of an Archaeological Survey. *Iraq* 40:119-162.
- Matthers, J. 1981a. "Introduction," in *The River Qoueiq, Northern Syria, and its Catchment: Studies arising from the Tell Rifa'at Survey 1977-79. Part i, B.A.R. International Series 98 (i)*. Edited by J. Matthers, pp. 1-10. Oxford: Archaeopress.
- Matthers, J. 1981b. "The Iron Age (c. 1200-700 B.C.)," in *The River Qoueiq, Northern Syria, and its Catchment: Studies arising from the Tell Rifa'at*



- Survey 1977-79. Part ii, B.A.R. International Series 98 (ii)*. Edited by J. Matthers, pp. 415-437. Oxford: Archaeopress.
- Matthiae, G. S. 2002. Afis 2000-2001. Area B: la coroplastica del Bronzo Antico IV A-B e del bronzo Medio II. *Egitto e Vicino Oriente* 25:16-18.
- Matthiae, P. 1979. Sondages a Tell Afis (Syrie), 1978. *Akkadica* 14:2-5.
- Matthiae, P. 1981. *Ebla: An Empire Rediscovered*. Garden City, NY: Doubleday.
- Matthiae, P. 1985. "Ricerche della Missione Archeologia in Siria dell'Universita di Roma: Tell Mardikh, Tell Tuqan, Tell Afis," in *Scavi e ricerche archeologiche degli anne 1976-1979*, pp. 163-219. Roma.
- Matthiae, P. 2000. "Studies in the Relative and Absolute Chronology of Syria in the IInd Millennium B.C. An Integrated Parallel Project," in *The Synchronisation of Civilisations in the Eastern Mediterranean in the Second Millennium B.C.* Edited by M. Bietak, pp. 136-139. Vienna: Verlag der Österreichischen Akademie der Wissenschaften.
- Mazar, A. 1988. "Some Aspects of the "Sea Peoples" Settlement," in *Society and Economy in the Eastern Mediterranean (c. 1500-1000 B.C.)*. Edited by M. Heltzer and E. Lipinski, pp. 251-260. Leuven.
- Mazar, A. 1985. Emergence of the Philistine Material Culture. *Israel Exploration Journal* 35(2): 95-107.
- Mazar, A. 1992. *Archaeology of the Land of the Bible 10 000-586 B.C.E.* New York: Doubleday.
- Mazar, A. 1993a. "Beth Shan," in *The New Encyclopaedia of Archaeological Excavations in the Holy Land*. Edited by E. Stern, pp. 214-223. New York: Simon and Schuster.
- Mazar, A. 1993b. Beth Shean in the Iron Age: Preliminary Report and Conclusions of the 1990-1991 Excavations. *Israel Exploration Journal* 43:201-229.
- Mazar, A. 1997a. "The Excavations at Tel Beth Shean during the Years 1989-1994," in *The Archaeology of Israel: Constructing the Past, Interpreting the Present, Journal for the Study of the Old Testament Supplement Series 237*. Edited by N. A. Silberman and D. Small, pp. 144-164. Sheffield: Sheffield Academic Press.
- Mazar, A. 1997b. Iron Age Chronology - A Reply to Israel Finkelstein. *Levant* 29:155-165.
- Mazar, A. 1998. "On the Appearance of Red Slip in the Iron Age I Period in Israel," in *Mediterranean Peoples in Transition: Thirteenth to Early Tenth Centuries BCE-In Honour of Professor Trude Dothan*. Edited by S. Gitin, A. Mazar, and E. Stern, pp. 368-378. Jerusalem: Israel Exploration Society.
- Mazar, A. 1999a. The 1997-1998 Excavations at Tel Rehov: Preliminary Report. *Israel Exploration Journal* 49:1-42.
- Mazar, A. 1999b. Beth Shean During the Iron Age II: Stratigraphy, Chronology and Hebrew Ostraca. *Eretz Israel* 26 (Frank M. Cross Volume):91-100 (Hebrew).
- Mazar, A. 2000. Will Tel Rehov Save the United Monarchy? *Biblical Archaeology Review* 26:38-48, 50-51, 75.
- Mazar, A. 2001. "Beth Shean During the Iron Age II: Stratigraphy, Chronology and Hebrew Ostraca," in *Studies in the Archaeology of the Iron Age in Israel and Jordan, Journal for the Study of the Old Testament Supplement Series 331*. Edited by A. Mazar and V. T. Mathias, pp. 289-309. Sheffield: Sheffield Academic Press.
- Mazar, A. 2004. Greek and Levantine Iron Age Chronology; A Rejoinder. *Israel Exploration Journal* 54:24-36.

- Mazar, A. 2005. "The Debate over the Chronology of the Iron Age in the Southern Levant: Its history, the current situation, and a suggested resolution," in *The Bible and Radiocarbon Dating: Archaeology, Text and Science*. Edited by T. E. Levy and T. Higham, pp. 15-30. London: Equinox.
- Mazar, A. 2006. "Beth-Shean from the Late Bronze Age IIB to the Medieval Period: A Summary," in *Excavations at Tel Beth-Shean 1989-1996. Volume I From the Late Bronze Age IIB to the Medieval Period*. Edited by A. Mazar, pp. 26-47. Jerusalem: Israel Exploration Society.
- Mazar, A., H. J. Bruins, N. Panitz-Cohen, and J. van der Plicht. 2005. "Ladder of Time at Tel Rehov: Stratigraphy, archaeological context, pottery and radiocarbon dates," in *The Bible and Radiocarbon Dating: Archaeology, Text and Science*. Edited by T. E. Levy and T. Higham, pp. 193-255. London: Equinox.
- Mazar, A., and I. Carmi. 2001. Radiocarbon Dates from Iron Age Strata at Tel Beth Shean and Tel Rehov. *Radiocarbon* 43:1333-1342.
- Mazar, A., and R. A. Mullins. 2006. "Introduction: The Hebrew University Excavations at Tel Beth-Shean," in *Excavations at Tel Beth-Shean 1989-1996. Volume I From the Late Bronze Age IIB to the Medieval Period*. Edited by A. Mazar, pp. 3-25. Jerusalem: Israel Exploration Society.
- Mazar, A., and N. Panitz-Cohen. 2006. "Area S: The Stratigraphy and Architecture of the Iron Age IIA and Later Structures," in *Excavations at Tel Beth-Shean 1989-1996. Volume I From the Late Bronze Age IIB to the Medieval Period*. Edited by A. Mazar, pp. 173-201. Jerusalem: Israel Exploration Society.
- Mazar (Maisler), B. 1951. The Stratification of Tell Abu Hawam on the Bay of Acre. *Bulletin of the American Schools of Oriental Research* 124:21-25.
- Mazar (Maisler), B. 1957. The Campaign of Pharaoh Shishak to Palestine. *Vetus Testamentum* Sup. 4:57-66.
- Mazar, E. 1993. "Achziv," in *The New Encyclopaedia of Archaeological Excavations in the Holy Land*. Edited by E. Stern, pp. 32-36. New York: Simon and Schuster.
- Mazar, E. 2000. "Phoenician Family Tombs at Achziv: A Chronological Typology (1000-400)," in *Fenicios Y Territorio*. Edited by A. Gonzalez-Pratz, pp. 89-226. Alicante.
- Mazar, E. 2001. The Phoenicians in Achziv, The Southern Cemetery: Jerome L. Joss Expedition Final Report of the Excavations 1988-1990. *Cuadernos de Arqueologia Mediterranea* 7.
- Mazar, E. 2004. The Phoenician Family Tomb N. 1 at the Northern Cemetery of Achziv (10th-6th Centuries BCE): Sam Turner Expedition Final Report of the Excavations. *Cuadernos de Arqueologia Mediterranea* 10.
- Mazzoni, S. 1984. L' insediamento persiano-ellenistico di Tell Mardikh. *Studi Eblaiti* 7:87-132.
- Mazzoni, S. 1988a. Lo scavo dell'edificio del Settore D. *Egitto e Vicino Oriente* 10/2:25-83.
- Mazzoni, S. 1988b. Tell Afis: Seminario 1987: Passato e Presente. *Egitto e Vicino Oriente* 10/2:1-3.
- Mazzoni, 1990a. Tell Afis and the Chronology of Iron Age in Syria. *Les Annales Archeologiques Arabes Syriennes* 40:76-92.
- Mazzoni, S. 1990b. La periode perse a Tell Mardikh dans le cadre de l'evolution de l'age du fer en Syrie. *Transeuphratene* 2:187-199.

- Mazzoni, S. 1990c. "Observations about Iron Age Glyptics from Tell Afis and Tell Mardikh," in *Resurrecting the Past: A Joint Tribute to Adnan Bounni*. Edited by P. Matthiae, M. Van Loon, and H. Weiss, pp. 215-226. Istanbul: Nederlands Historisch-Archaeologisch Instituut te Istanbul.
- Mazzoni, S. 1990d. Tell Afis e L'eta del Ferro. *Seminari di Orientalistica* 2:157-196.
- Mazzoni, S. 1991-1992. Lo Sviluppo Degli Insediamenti in Siria in eta Persiana. *Egitto e Vicino Oriente* 14-15:55-72.
- Mazzoni, S. 1992a. "L'eta del Ferro a Tell Mardikh e nella sue regione," in *Tell Afis e l'età del ferro, Seminari di orientalistica* 2. Edited by S. Mazzoni, pp. 99-155. Pisa: Giardini editori e stampatori in Pisa.
- Mazzoni, S. 1992b. "Tell Afis e il Ferro I in Siria," in *Tell Afis e l'età del ferro, Seminari di orientalistica* 2. Edited by S. Mazzoni, pp. 157-196. Pisa: Giardini editori e stampatori in Pisa.
- Mazzoni, S. 1994a. "Aramaeian and Luwian New Foundations," in *Nuove fondazioni nel Vicino Oriente Antico: realta e ideologia*. Edited by S. Mazzoni, pp. 319-340. Pisa.
- Mazzoni, S. 1994b. "Drinking Vessels in Syria: Ebla and the Early Bronze Age," in *Drinking in Ancient Societies: History and Culture of Drinks in the Ancient Near East*. Edited by L. Milano, pp. 245-276. Padova: Sargon srl.
- Mazzoni, S. 1995. "Settlement Pattern and New Urbanisation in Syria at the Time of the Assyrian Conquest," in *Neo-Assyrian Geography: Papers Presented at the International Conference Held in the University of Rome 'La Sapienza', November 10th to 12th, 1993., Quaderni di geografia storica ; 5*. Edited by M. Liverani, pp. 181-191. Roma: Università di Roma 'La Sapienza' Dipartimento di Scienze storiche archeologiche e antropologiche dell'Antichità.
- Mazzoni, S. 1997a. "The Gate and the City: Change and Continuity in Syro-Hittite Urban Ideology," in *Die orientalische stadt: Kontinuitat, Wandel, Bruch*. Edited by G. Wilhelm, pp. 307-338. Saarbrücken: saarbrucker Druckerei und Verlag.
- Mazzoni, S. 1997b. L'arte siro-ittita nel suo contesto archeologico. *Contributi e Materiali di Archeologia Orientale* 7:287-327.
- Mazzoni, S. 1998a. "The Late Iron I and Early Iron II Levels (Area E1)," in *Tell Afis, Siria: scavi sull'acropoli 1988-1992 = The 1988-1992 excavations on the Acropolis, Ricerche di archeologia del Vicino Oriente ; 1*. Edited by S. M. Cecchini and S. Mazzoni, pp. 163-199. Pisa: Edizioni ETS.
- Mazzoni, S. 1998b. *The Italian Excavations of Tell Afis (Syria): From Chieftdom to an Aramaean state*. Pisa: Edizioni ETS.
- Mazzoni, S. 1998c. Une nouvelle stèle d'époque araméenne de Tell Afis (Syrie). *Transeuphratene* 16:9-18.
- Mazzoni, S. 2000a. "Syria and the Periodization of the Iron Age: A Cross-Cultural Perspective," in *Essays on Syria in the Iron Age., Ancient Near Eastern studies. Supplement 7*. Edited by G. Bunnens, pp. 31-59. Louvain: Peeters Press.
- Mazzoni, S. 2000b. Tell Afis Siria 1999, Summary. *Egitto e Vicino Oriente* 22:55-60.
- Mazzoni, S. 2000c. "Pots, People and Cultural Borders in Syria," in *Landscapes: Territories, Frontiers and Horizons in the Ancient Near East: Papers Presented to the XLIV Rencontre Assyriologique Internationale, Venezia, 7-11 July 1997; Part II Geography and Cultural Landscapes, History of the*

- Ancient Near East/ Monographs - III/2*. Edited by L. Milano, S. de Martino, F. M. Fales, and G. B. Lanfranchi, pp. 139-152. Padova: Sargon srl.
- Mazzoni, S. 2000d. "Crisis and Change: the beginning of Iron Age in Syria," in *Proceedings of the First International Congress on the Archaeology of the Ancient Near East, Rome, May 18-23, 1998. Volume II*. Edited by P. Matthiae, A. Enea, L. Peyronel, and F. Pinnock, pp. 1043-1060. Rome: Università degli Studi di Roma 'La Sapienza'.
- Mazzoni, S. 2001. "Tell Afis and the Lu'ash in the Aramaean Period," in *The World of the Aramaeans II: Studies in History and Archaeology in Honour of Paul-Eugene Dion, Journal for the Study of the Old Testament Supplement Series 325*. Edited by P. M. M. Daviau, J. W. Wevers, and M. Weigl, pp. 99-114. Sheffield: Sheffield Academic Press.
- Mazzoni, S. 2002a. Afis 2000-2001. Summary (English). *Egitto e Vicino Oriente* 25:68-72.
- Mazzoni, S. 2002b. Afis 2000-2001. Area B: l'occupazione dell'Eta del Ferro. *Egitto e Vicino Oriente* 25:18-19.
- Mazzoni, S. 2002c. Afis 2000-2001. Campagne XVIII-XIX: Bilancio e Prospettive. *Egitto e Vicino Oriente* 25:5-7.
- Mazzoni, S. 2002d. Afis 2000-2001. Area B: la ceramica del Bronzo Medio. *Egitto e Vicino Oriente* 25:14-16.
- Mazzoni, S. 2002e. "Late Bronze Age Pottery Production in Northwestern Central Syria," in *Céramique de l'Âge du Bronze en Syrie, I. La Syrie du Sud et la Vallée l'Oronte, BAH 161*. Edited by M. al Maqdissi, V. Matoïan, and C. Nicolle, pp. 129-151. Damas: IFAPO.
- Mazzoni, S. 2005a. Tell Afis, Siria, 2002-2004: Summary. *Egitto e Vicino Oriente* 28:113-122.
- Mazzoni, S. 2005b. Tell Afis, the Survey and the Regional Sequence. *Egitto e Vicino Oriente* 28:5-13.
- Mazzoni, S., and S. M. Cecchini. 1995. Tell Afis (Siria) 1994: Rapporto preliminare. *Egitto e Vicino Oriente* 18:243-306.
- McCall, H. 1998. "Rediscovery and Aftermath," in *The Legacy of Mesopotamia*. Edited by S. Dalley, pp. 183-213. Oxford.
- McClellan, T. L. 1992. "Twelfth Century B.C. Syria: Comments on H. Sader's paper: The 12th century B.C. in Syria: The Problem of the Rise of the Aramaeans," in *The Crisis Years: The 12th Century B.C. From Beyond the Danube to the Tigris*. Edited by W. A. Ward and M. S. Joukowsky, pp. 164-173. Iowa: Kendall Hunt.
- McEwan, C. W. 1937. The Syrian Expedition of the Oriental Institute of the University of Chicago. *American Journal of Archaeology* 41(1):8-16.
- McFadden, G. H. 1954. A Late Cypriote III Tomb from Kourion Kaloriziki No. 40. *American Journal of Archaeology* 58(2):131-142.
- McNicoll, A. W., R. H. Smith, and J. B. Hennessy. 1982a. *Pella in Jordan I: An interim report on the joint University of Sydney and the College of Wooster Excavations at Pella 1979-1981 (Text)*. Canberra: Australian National Gallery.
- McNicoll, A. W., R. H. Smith, and J. B. Hennessy. 1982b. *Pella in Jordan I: An interim report on the joint University of Sydney and the College of Wooster Excavations at Pella 1979-1981 (Plates and Illustrations)*. Canberra: Australian National Gallery.

- McNicoll, A. W., P. C. Edwards, J. Hanbury-Tenison, J. B. Hennessy, T. F. Potts, R. H. Smith, A. Walmsley, and P. Watson. Editors. 1992. *Pella in Jordan 2: The second interim report of the joint University of Sydney and College of Wooster Excavations at Pella 1982-1985. Mediterranean Archaeology Supplement 2*. Sydney: MEDITARCH.
- Melchert, H. C. 2003a. "Introduction," in *The Luwians, Handbuch der Orientalistik 68*. Edited by H. C. Melchert, pp. 1-7. Leiden: Brill.
- Melchert, H. C. 2003b. "Prehistory," in *The Luwians, Handbuch der Orientalistik 68*. Edited by H. C. Melchert, pp. 8-26. Leiden: Brill.
- Mellink, M. J. 1974. "Hittite friezes and gate sculptures," in *Anatolian Studies Presented to H.G. Güterbock on the Occasion of his 65th Birthday*. Edited by K. Bittel, P. H. J. Houwink ten Cate, and E. Reiner, pp. 201-214. Istanbul.
- Merrillees, R. S. 2003. "The Greek Emergence in the Eastern Mediterranean - Cyprus and Phoenicia," in *One Hundred Years of American Archaeology in the Middle East*. Edited by D. R. Clark and V. H. Matthews, pp. 87-96. Boston: American Schools of Oriental Research.
- Meskell, L. 1996. The Somatization of Archaeology. *Norwegian Archaeological Review* 29:1-16.
- Metcalf, P., and R. Huntington. 1995. *Celebrations of Death: The Anthropology of Mortuary Ritual*. Cambridge: Cambridge University Press.
- du Mesnil du Buisson, R. 1926. Les Ruines d'el-Mishrife au NORD-EST de Homs (Emese). *Syria* 7:289-325.
- du Mesnil du Buisson, L. C. 1927a. Les Ruines d'el-Mishrifé au Nord-East de Homs (Émèse). *Syria* 8:13-33.
- du Mesnil du Buisson, R. 1927b. L'Ancienne Qatna: ou les ruines d'el-Mishrife au N.-E. de Homs (Emese), Deuxieme Campagne de Fouilles, 1927. *Syria* 8: 13-33, 277-301.
- du Mesnil du Buisson, R. 1928. L'Ancienne Qatna: ou les ruines d'el-Mishrife au N.-E. de Homs (Emese), Deuxieme Campagne de Fouilles, 1927. *Syria* 9:6-24, 81-89.
- du Mesnil du Buisson, R. 1930. Compte rendu de la quatrième campagne de fouilles a Mishrifé-Qatna. *Syria* 11:146-163.
- du Mesnil du Buisson, L. C. 1934. Le Site de Qadesh (Tell Nebi Mend). *Melanges Maspero: Memoires de l'Institut Francais d'Archeologie Orientale, Cairo*:909-927.
- du Mesnil du Buisson, R. 1935. *Le Site archeologique de Mishrife-Qatna*. Paris.
- Meurdrac, M., and L. Albanèse. 1938. A travers les nécropoles gréco-romaines de Sidon. *Bulletin du Musée de Beyrouth* 2:73-98.
- Meurdrac, M., and L. Albanèse. 1939. A travers les nécropoles gréco-romaines de Sidon. *Bulletin du Musée de Beyrouth* 3:37-51.
- Millard, A. R. 1976. A Text in Shorter Cuneiform Alphabet from Tell Nebi Mend. *Ugarit-Forschungen* 8:459-460.
- Miller, G. F. 1958. *Aleppo, Past and Present: Its history, its citadel, its museum and its antique monuments*. Archaeological Society of Aleppo.
- Miller, J. M. 1988. "Antecedents to Palestinian Archaeology," in *Benchmarks in Time and Culture. An Introduction to Palestinian Archaeology. Essays in honor of Joseph A. Callaway*. Edited by J. F. Drinkard, G. L. Mattingly, and J. M. Miller, pp. 3-14. Atlanta: Scholars Press.
- Mongne, P., F. Stephan, and S. Zarazir. 2003. Opération Bey 048-Nord; Rapport Préliminaire des fouilles de la Place des Martyrs à Beyrouth. *Baal* 7:49-82.

- Montet, P. 1928. *Byblos et l'Égypte. Quatre Campagnes de Fouilles a Gebeil 1921 - 1922 - 1923 - 1924 (Texte)*. Bibliothèque Archéologique et Historique XI. Paris: Librairie Orientaliste Paul Geuthner.
- Montet, P. 1929. *Byblos et l'Égypte. Quatre Campagnes de Fouilles a Gebeil 1921 - 1922 - 1923 - 1924 (Atlas)*. Bibliothèque Archéologique et Historique XI. Paris: Librairie Orientaliste Paul Geuthner.
- Moorey, P. R. S. 1975. Iranian Troops at Deve Hüyük in Syria in the Earlier Fifth Century B.C. *Levant* 7:108-117.
- Moorey, P. R. S. 1980. *Cemeteries of the First Millennium B.C. at Deve Hüyük, Near Carchemish, Salvaged by T. E. Lawrence and C. L. Woolley in 1913*. B.A.R. International. Oxford: B.A.R.
- Moorey, P. R. S. 1988. "Bronzeworking centres of Western Asia c. 1000-539 BC: problems and perspectives," in *Bronzeworking centres of Western Asia c. 1000-539 BC*. Edited by J. Curtis, pp. 23-32. London: Keegan Paul International.
- Moorey, P. R. S. 1991. *A Century of Biblical Archaeology*. Westminster: John Knox Press.
- Moorey, P. R. S. 1994. *Ancient Mesopotamian Materials and Industries: The Archeological Evidence*. Oxford: Clarendon Press.
- Morandi Bonacossi, D. 1999. "Die eisenzeitliche Keramik der TAVO-Geländebegehung des Unteren Habur-Gebiets," in *Iron Age Pottery in Northern Mesopotamia, Northern Syria and South-Eastern Anatolia : papers presented at the meetings of the international "table ronde" at Heidelberg (1995) and Nieborów (1997) and other contributions, Altertumskunde des vorderen Orients ; Bd. 10*. Edited by A. Hausleiter and A. Reiche, pp. 193-229. Münster: Ugarit-Verlag.
- Morandi Bonacossi, D. 2000a. "The Beginning of the Early Bronze Age at Tell Shiukh Fawqani (Tishrin Dam Area) and in the Upper Syrian Euphrates Valley," in *Proceedings of the First International Congress on the Archaeology of the Ancient Near East, Rome, May 18-23, 1998. Volume II*. Edited by P. Matthiae, A. Enea, L. Peyronel, and F. Pinnock, pp. 1105-1124. Rome: Università degli Studi di Roma 'La Sapienza'.
- Morandi Bonacossi, D. 2000b. "The Syrian Jezireh in the Late Assyrian Period: A View from the Countryside," in *Essays on Syria in the Iron Age., Ancient Near Eastern studies. Supplement 7*. Edited by G. Bunnens, pp. 349-396. Louvain: Peeters Press.
- Morandi Bonacossi, D. 2000c. "Marina sa sade, Marina, Burmarina: The Many Names of an Assyrian Town on the Euphrates," in *Patavina Orientalia Selecta, History of the Ancient Near East Monographs IV*. Edited by E. Rova, pp. 221-230. Padova: Sargon srl.
- Morandi Bonacossi, D. 2002. "Operation J," in *Excavating Qatna, I. Preliminary Report on the 1999 and 2000 Campaigns of the Joint Syrian-Italian-German Archaeological Research Project at Tell Mishrifeh, Documents d'Archeologie Syrienne IV*. Edited by M. al-Maqdissi, M. Luciani, D. Morandi Bonacossi, M. Novák, and P. Pfälzner, pp. 123-144. Damascus.
- Morris, E. L. 1994. Production and Distribution of Pottery and Salt in Iron Age Britain: a Review. *Proceedings of the Prehistoric Society* 60:371-393.
- Morris, I. 1987. *Burial and Ancient Society. The rise of the Greek city-state*. Cambridge: Cambridge University Press.

- Morris, I. 1992. *Death-Ritual and Social Structure in Classical Antiquity*. Cambridge.
- Morris, I. 1997. Archaeology as Cultural History. *Archaeological Review from Cambridge* 14:3-16.
- Morris, I. 2000. *Archaeology as Cultural History: Words and Things in Iron Age Greece*. Oxford.
- Morrison, K. D., and M. T. Lycett. 1997. Inscriptions as Artifacts: Precolonial South India and the Analysis of Texts. *Journal of Archaeological Method and Theory* 4:215-238.
- Moscatti, S. 1973. *The World of the Phoenicians*. London: Cardinal.
- Moscatti, S. 1988. *The Phoenicians*. New York: Abbeville Press Publishers.
- Moscrop, J. J. 2000. *Measuring Jerusalem. The Palestine Exploration Fund and British Interests in the Holy Land*. London: Leicester University Press.
- Mountjoy, P. A. 1993. *Mycenaean Pottery: An Introduction. Oxford University Committee for Archaeology Monograph 36*. Oxford: Oxbow.
- Muhsen, S. 1985. Chronique Archeologique. *Syria* 62.
- Muhsen, S. 1999. "Salvage Excavations at the Tishrin Dam Area," in *Archaeology of the Upper Syrian Euphrates, The Tishrin Dam Area: Proceedings of the International Symposium Held at Barcelona, January 28th-30th 1998*. Edited by G. del Olmo Lete and J.-L. Montero Fenollos, pp. 11-12. Barcelona: Editorial AUSA.
- Muhly, J. D. 1970. Homer and the Phoenicians; The Relations Between Greece and the Near East in the Late Bronze and Early Iron Ages. *Berytus* 19:19-64.
- Muhly, J. D. 1980. "The Bronze Age Setting," in *The Coming of the Age of Iron*. Edited by T. A. Wertime and J. D. Muhly, pp. 25-68. New Haven and London: Yale University Press.
- Muhly, J. D. 1984. "The Role of the Sea Peoples in Cyprus during the LC III Period," in *Cyprus at the Close of the Late Bronze Age*. Edited by V. Karageorghis and J. D. Muhly, pp. 39-56. Nicosia.
- Muhly, J. D. 1986. "The Role of Cyprus in the Economy of the Eastern Mediterranean During the Second Millennium B.C.," in *Acts of the International Archaeological Symposium 'Cyprus Between the Orient and the Occident'*. Edited by V. Karageorghis. Nicosia: Department of Antiquities, Cyprus.
- Muhly, J. D. 1992. "The Crisis Years in the Mediterranean World: Transition or Cultural Disintegration?," in *The Crisis Years: The 12th Century B.C. From Beyond the Danube to the Tigris*. Edited by W. A. Ward and M. S. Joukowsky, pp. 10-26. Dubuque: Kendall/ Hunt.
- Muhly, J. D. 2003. "Archaeology in the Eastern Mediterranean: Where We Went Wrong in the Twentieth Century and How We Can Do Better in the Twenty-first," in *One Hundred Years of American Archaeology in the Middle East*. Edited by D. R. Clark and V. H. Matthews, pp. 19-32. Boston: American Schools of Oriental Research.
- Na'aman, N. 1985. Arad in the Topographical List of Shishak. *Tel Aviv* 12:91-92.
- Na'aman, N. 1992. Israel, Edom and Egypt in the 10th Century BCE. *Tel Aviv* 19:71-93.
- Na'aman, N. 1995a. "Province System and Settlement Pattern in Southern Syria and Palestine in the Neo-Assyrian Period," in *Neo-Assyrian Geography: Papers Presented at the International Conference Held in the University of Rome 'La Sapienza', November 10th to 12th, 1993.*, *Quaderni di geografia storica* ; 5.

- Edited by M. Liverani, pp. 103-115. Roma: Università di Roma 'La Sapienza' Dipartimento di Scienze storiche archeologiche e antropologiche dell'Antichità.
- Na'aman, N. 1995b. Tiglath-pileser III's Campaigns Against Tyre and Israel (734-732 B.C.E.). *Tel Aviv* 22:268-278.
- Na'aman, N. 1997. Historical and Literary Notes on the Excavations of Tel Jezreel. *Tel Aviv* 24:122-166.
- Na'aman, N., and Y. Thareani-Sussely. 2006. Dating the Appearance of Imitations of Assyrian Ware in Southern Palestine. *Tel Aviv* 33(1):61-82.
- Naumann, R. 1971. *Architektur Kleinasiens*. Tübingen.
- Nibbi, A. 1975. *The Sea Peoples and Egypt*. New Jersey: Noyes Press.
- Niemann, H. M. 2000. Megiddo and Solomon: A Biblical Investigation in Relation to Archaeology. *Tel Aviv* 27:61-74.
- Niemeier, W.-D. 2001. Archaic Greeks in the Orient: Textual and Archaeological Evidence. *Bulletin of the American Schools of Oriental Research* 322:11-32.
- Novák, M., and P. Pfälzner. 2000. Ausgrabungen in Tall Mishrife-Qatna 1999; Vorbericht der deutschen Komponente des internationalen Kooperationsprojekts. *Mitteilungen der Deutschen Orient-Gesellschaft zu Berlin* 132:253-296.
- Novák, M., and P. Pfälzner. 2001. Ausgrabungen in Tall Mishrife-Qatna 2000; Vorbericht der deutschen Komponente des internationalen Kooperationsprojekts. *Mitteilungen der Deutschen Orient-Gesellschaft zu Berlin* 133:157-198.
- Novák, M., and P. Pfälzner. 2002. "Excavations in the Western Part of the Bronze Age Palace (Operation G)," in *Excavating Qatna, I. Preliminary Report on the 1999 and 2000 Campaigns of the Joint Syrian-Italian-German Archaeological Research Project at Tell Mishrifeh, Documents d'Archeologie Syrienne IV*. Edited by M. al-Maqdissi, M. Luciani, D. Morandi Bonacossi, M. Novak, and P. Pfälzner, pp. 63-110. Damascus.
- Núñez, F. J. 2001-2002. An Approach to Exchange Relations in Iron Age Beirut: The Ceramic Evidence. *Aram* 13-14:37-49.
- Núñez, F. J. 2004a. "Catalogue of Urns," in *The Phoenician Cemetery at Tyre El-Bass, Excavations 1997-1999, Baal, Hors Serie 1*. Edited by M. E. Aubet, pp. 63-203. Beirut: Ministère de la Culture Direction Générale des Antiquités.
- Núñez, F. J. 2004b. "Preliminary Report on Pottery," in *The Phoenician Cemetery at Tyre El-Bass, Excavations 1997-1999, Baal, Hors Serie 1*. Edited by M. E. Aubet, pp. 281-373. Beirut: Ministère de la Culture Direction Générale des Antiquités.
- Oates, D., and J. Oates. 2001. *Nimrud. An Assyrian Imperial City Revealed*. London: British School of Archaeology in Iraq.
- Oates, J. 1959. Late Assyrian Pottery from Fort Shalmaneser. *Iraq* 21:130-147.
- O'Callaghan, R. T. 1948. *Aram Naharaim. A contribution to the history of upper Mesopotamia in the second millennium B.C.* Roma: Pontificium Institutum Biblicum.
- Oded, B. 1974. The Phoenician Cities and the Assyrian Empire in the Time of Tiglath-Pileser III. *Zeitschrift des Deutschen Palästina-Vereins* 90:38-49.
- Oded, B. 1979. *Mass Deportations and Deportees in the Neo-Assyrian Empire*. Wiesbaden: Dr. Ludwig Reichert Verlag.
- Oelmann, F. 1921. Zur Baugeschichte von Sendschirli. *Jahrbuch des Deutschen Archäologischen Instituts* 36:85-98.



- Oggiano, I. 1997. The Pottery of Iron Age II from Tell Afis. *Contributi della Scuola di Specializzazione di Archeologia di Pisa* 1:185-211.
- Oggiano, I. 1999. "Cataloguistics: The Experience at Tell Afis, Syria," in *Iron Age pottery in Northern Mesopotamia, Northern Syria and South-Eastern Anatolia : papers presented at the meetings of the international "table ronde" at Heidelberg (1995) and Nieborów (1997) and other contributions, Altertumskunde des vorderen Orients ; Bd. 10*. Edited by A. Hausleiter and A. Reiche, pp. 377-402. Münster: Ugarit-Verlag.
- Oggiano, I. 2002. Afis 2000-2001. *Area J. Egitto e Vicino Oriente* 25:41-45.
- Olmstead, A. T. 1931. *History of Palestine and Syria to the Macedonian Conquest*. New York and London: Charles Scribner's Sons.
- Oppenheim, , A. L. 1964. *Ancient Mesopotamia*. Chicago: University of Chicago Press.
- Oren, E. D. 1973. *The Northern Cemetery of Beth Shan*. Leiden: E. J. Brill.
- Orthmann, W. 1964. Zu den Ausgrabungen in Tell Ain Dara. *Archäologischer Anzeiger* 1964:137-143.
- Orthmann, W. 1971. *Untersuchungen zur späthethitischen Kunst. Saarbrucker Beiträge zur Altertumskunde* 8. Bonn.
- Orton, C., P. Tyers, and A. Vince. 1993. *Pottery in Archaeology*. Cambridge: Cambridge University Press.
- Otto, A. 2006. *Alltag und Gesellschaft zur Spätbronzezeit: Eine Fallstudie aus Tall Bazi (Syrien). Subartu XIX*. Turnhout: BREPOLs Publishers.
- Otzen, B. 1979. "Israel Under the Assyrians," in *Power and Propaganda A Symposium on Ancient Empires, Copenhagen Studies in Assyriology* 7. Edited by M. T. Larsen, pp. 251-262. Copenhagen: Akademisk Forlag.
- Özdoğan, M. 1998. "Ideology and Archaeology in Turkey," in *Archaeology Under Fire: Nationalism, Politics and Heritage in the Eastern Mediterranean and Middle East*. Edited by L. Meskell, pp. 111-123. London: Routledge.
- Pakman, D. 1992. Late Iron Age Vessels at Tel Dan. *Eretz Israel* 23:230-240 (Hebrew).
- Pamir, H. 2005. "The Orontes Delta Survey," in *The Amuq Valley Regional Projects Volume 1: Surveys in the Plain of Antioch and Orontes Delta, Turkey, 1995-2002, Oriental Institute Publications* 131. Edited by K. A. Yener, pp. 67-98. Chicago: The Oriental Institute of the University of Chicago.
- Papasavvas, G. 2003. Writing on Cyprus: Some Silent Witnesses. *Report of the Department of Antiquities Cyprus*:79-94.
- Parker Pearson, M. 2000. *The Archaeology of Death and Burial*. College Station: Texas A & M University.
- Parker Pearson, M. 2003. "Food, Culture and Identity: An Approach and Overview," in *Food, Culture and Identity in the Neolithic and Early Bronze Age, BAR International Series* 1117. Edited by M. Parker Pearson, pp. 1-30. Oxford: Archaeopress.
- Parpola, S. 1987. *The Correspondence of Sargon II. Part I Letters from Assyria and the West. State Archives of Assyria I*. Helsinki: Helsinki University Press.
- Parr, P. J. 1983. The Tell Nebi Mend Project. *Les Annales Archeologiques Arabes Syriennes* 33:99-117.
- Parr, P. J. 1991. The Tell Nebi Mend Project: A Progress Report. *Journal of the Ancient Chronology Forum* 4:78-85.
- Peckham, B. 2001. "Phoenicians and Aramaeans: The Literary and Epigraphic Evidence," in *The World of the Aramaeans II: Studies in History and*

- Archaeology in Honour of Paul-Eugene Dion, Journal for the Study of the Old Testament Supplement Series 325*. Edited by P. M. M. Daviau, J. W. Wevers, and M. Weigl, pp. 19-44. Sheffield: Sheffield Academic Press.
- Pedrazzi, T. 2002. Afis 2000-2001. Area E: l'occupazione del Bronzo Tardo II - Ferro I. Il settore Nord. *Egitto e Vicino Oriente* 25:33-38.
- Perreault, J. Y. 1986. Ceramique et echanges: les importations Attiques au Proche-Orient du VIe au Milieu du Ve Siecle Avant J.-C. les Donnees Archeologiques. *Bulletin de Correspondence Hellenitique* 110:145-175.
- Perring, D., H. Seeden, P. Sheehan, and T. Williams. 1996. Bey 006, 1994-1995 The Souks Area; Interim Report of the AUB Project. *Baal* 1:176-206.
- Perrot, J. 1979. *Syria-Palestine I. From the Origins to the Bronze Age*. Geneva: Nagel Publishers.
- Petrie, W. M. F. 1891. *Tell el Hesy (Lachish)*. London: Committee of the Palestine Exploration Fund.
- Petrie, W. M. F. 1904. *Methods and Aims in Archaeology*. London: MacMillan & Co.
- Petrie, W. M. F. 1930. *Beth Pelet I (Tell Fara)*. London.
- Petrie, W. M. F. 1932. *Seventy Years in Archaeology*. London.
- Pettinato, G. 1981. *The Archives of Ebla*. New York: Doubleday & Company, Inc.
- Pézar, M. 1922. Mission Archeologique a Tell Nebi Mend (1921) Rapport Sommaire. *Syria* 3:89-115.
- Pézar, M. 1931. *Qadesh: Mission Archeologique a Tell Nebi Mend 1921-1922. Bibliotheque Archeologique et Historique XV*. Paris: Geuthner.
- Philip, G. 1991. Cypriot Bronzework in the Levantine World: Conservatism, Innovation and Social Change. *Journal of Mediterranean Archaeology* 4:59-108.
- Philip, G., and B. S. Ottaway. 1983. Mixed Data Cluster Analysis: an Illustration Using Cypriot Hooked-Tang Weapons. *Archaeometry* 25(2):119-133.
- Philip, G., P. W. Clogg, and D. Dungworth. 2003. Copper Metallurgy in the Jordan Valley from the Third to the First Millennium BC: Chemical, Metallographic and Lead Isotope Analyses of Artefacts from Pella. *Levant* 35:71-100.
- Philip, G., M. Abdulkarim, P. G. Newson, D. Bridgland, M. Bshesh, A. D. Shaw, R. Westaway, and K. Wilkinson. 2005. Settlement and Landscape Development in the Homs Region, Syria. Report on Work Undertaken during 2001-2003. *Levant* 37:21-42.
- Phythian Adams, W. J. 1923. Report on the Stratification of Askalon. *Palestine Exploration Fund Quarterly Statement* April 1923:60-84.
- Pinnock, F. 1994. "Considerations on the <Banquet Theme> in the Figurative Art of Mesopotamia and Syria," in *Drinking in Ancient Societies: History and Culture of Drinks in the Ancient Near East*. Edited by L. Milano, pp. 15-26. Padova: Sargon srl.
- Pitard, W. T. 1987. *Ancient Damascus: A Historical Study of the Syrian City-State from Earliest Times until its Fall to the Assyrians in 732 BCE*. Winona Lake, Indiana: Eisenbrauns.
- Pitard, W. T. 1997. "Aleppo" in *The Oxford Encyclopedia of Archaeology in the Near East. Vol. 1*. Edited by E. M. Meyers, pp. 63-65. Oxford: Oxford University Press.
- du Plat Taylor, J. 1959. The Cypriot and Syrian Pottery from Al Mina, Syria. *Iraq* 21:69-92.

- Ploix de Rotrou, G. 1931a. Les Fouilles de la Citadelle d'Alep. *Revue Archeologique Syrienne* 1:17-18, 43-44, 66, 102, 131.
- Ploix de Rotrou, G. 1931b. Le nouveau relief de la Citadelle d'Alep. *Revue Archeologique Syrienne* 1:8-10.
- Ploix de Rotrou, G. 1932a. Les orthostates a dessin geometrique de la Citadelle d'Alep. *Revue Archeologique Syrienne* 2:7-9.
- Ploix de Rotrou, G. 1932b. Fouilles de la Citadelle d'Alep. *Revue Archeologique Syrienne* 2:20, 111-112.
- Ploug, G. 1973. *Sukas II: The Aegean, Corinthian and Eastern Greek Pottery and Terracottas. Publications of the Carlsberg Expedition to Phoenicia 2.* Copenhagen: Munksgaard.
- Poidebard, A. 1939a. *Un Grand Port Disparu Tyr: Recherches Aeriennes et Sous-Marines 1934-1936 (Text). Bibliotheque Archeologique et Historique Tome XXIX.* Paris: Librairie Orientaliste Paul Geuthner.
- Poidebard, A. 1939b. *Un Grand Port Disparu Tyr: Recherches Aeriennes et Sous-Marines 1934-1936 (Atlas). Bibliotheque Archeologique et Historique Tome XXIX.* Paris: Librairie Orientaliste Paul Geuthner.
- Popham, M., A. M. Pollard, and H. Hatcher. 1983. Euboean Exports to Al Mina, Cyprus, and Crete: a Reassessment. *Annual of the British School at Athens* 78:281-290.
- Poppa, R. 1978. *Kamid el-Loz 2: Der Eisenzeitliche Friedhof Befunde unde Funde. Saarbrucker Beitrage zur Alterumskunde 18.* Bonn: Rudolph Habelt Verlag GMBH.
- Potts, T. F., S. M. Colledge, and P. C. Edwards. 1985. Preliminary Report on a Sixth Season of Excavation by the University of Sydney at Pella in Jordan 1983/1984. *Annual of the Department of Antiquities of Jordan* 29:181-210.
- Potts, T. F., S. J. Bourke, P. C. Edwards, F. Richards, and G. J. Wightman. 1988. Preliminary Report on the Eighth and Ninth Seasons of Excavation by the University of Sydney at Pella (Tabaqat Fahl) 1986 and 1987. *Annual of the Department of Antiquities of Jordan* 32:115-150.
- Poulsen, F. 1912. *Der Orient und die Frühgriechische Kunst.* Berlin: Teubner.
- Prausnitz, M. W. 1959. Akhziv, Notes and News. *Israel Exploration Journal* 9:271.
- Prausnitz, M. W. 1960a. Akhziv. *Revue Biblique* 67:398.
- Prausnitz, M. W. 1960b. Akhziv, Notes and News. *Israel Exploration Journal* 10:260-261.
- Prausnitz, M. W. 1962. Akhziv. *Revue Biblique* 69:404-405.
- Prausnitz, M. W. 1963. Akhziv, Notes and News. *Israel Exploration Journal* 13:337-338.
- Prausnitz, M. W. 1965. Akhziv, Notes and News. *Israel Exploration Journal* 15:256-258.
- Prausnitz, M. W. 1982. "Die Nekropolen von Akhziv und die Entwicklung der Keramik von 10. bis zum 7. Jahrhundert v. Chr. in Akhziv, Samaria und Ashdod," in *Phönizier im Westen : die Beiträge des Internationalen Symposiums über "Die Phönizische Expansion im Westlichen Mittelmeerraum" in Köln vom 24. bis 27. April, 1979, Madrider Beiträge ; Bd. 8.* Edited by H. G. Niemeyer, pp. 45-82. Mainz am Rhein: P. von Zabern.
- Pritchard, J. B. 1968. "New Evidence on the Role of the Sea Peoples in Canaan at the Beginning of the Iron Age," in *The Role of the Phoenicians in the Interaction of Mediterranean Civilisations.* Edited by W. A. Ward, pp. 99-112. Beirut: American University of Beirut.

- Pritchard, J. B. 1969. *The Ancient Near East in Pictures Relating to the Old Testament. Second Edition with Supplement*. Princeton, NJ: Princeton University Press.
- Pritchard, J. B. 1975. *Sarepta: A Preliminary Report on the Iron Age*. Philadelphia.
- Pritchard, J. B. 1978. *Recovering Sarepta, A Phoenician City: Excavations at Sarafand, Lebanon, 1969-1974, by the University Museum of the University of Pennsylvania*. Princeton: Princeton University Press.
- Pritchard, J. B. 1988. *Sarepta IV: The Objects from Area II, X*. Beirut: Librairie Orientale.
- Ranke, L. 1885. *Geschichten der Romanischen und Germanischen Völker von 1494 bis 1514*. Leipzig (originally published 1824).
- Rast, W. E. 1978. *Taanach I, Studies in the Iron Age Pottery*. Cambridge, MA: American Schools of Oriental Research.
- Reade, J. 1976. Sargon's Campaigns of 720, 716, and 715 B.C.: evidence from the sculptures. *Journal of Near Eastern Studies* 35:95-104.
- Reade, J. 1978. Studies in Assyrian Geography. *Revue D'Assyriologie* 72:47-72, 175-180.
- Reade, J. 1987. "Reflections on Layard's Archaeological Career," in *Austen Henry Layard Tra l'Oriente e Venezia*. Edited by F. M. Fales and B. J. Hickey, pp. 47-54. Roma.
- Reade, J. 1993. Hormuzd Rassam and His Discoveries. *Iraq* 55:39-62.
- Reisner, G. A., C. S. Fisher, and D. G. Lyon. 1924. *Harvard Excavations at Samaria, 1908-1910*. Cambridge, MA: Harvard University Press.
- Renan, E. 1864. *Mission to Phénicie*. Paris.
- Renfrew, C., and P. Bahn. 2004. *Archaeology: Theories, Methods and Practice*, Fourth edition. London: Thames and Hudson.
- Repiccioli, M., D. Giannessi, and G. Aletta. 2002. Afis 2000-2001. Area B: le fortificazioni del Bronzo Medio II. *Egitto e Vicino Oriente* 25:12-14.
- Restö, J. 1991. The Domestication of the Camel and the Establishment of the Frankincense Road from South Arabia. *Orientalia Suecana* 40:187-219.
- Rey-Coquais, J.-P. 1976. Inscription Greque Decouverte a Ras Ibn Hani. *Les Annales Archeologiques Arabes Syriennes* 26:51-61.
- Riis, P. J. 1948. *Hama: fouilles et recherches 1931-1938: Les cimetières a cremation*. NationalMuséets skrifter. Storre beretninger ; 1. Copenhagen: NationalMuséet.
- Riis, P. J. 1960. l'Activité de la Mission Archéologique Danoise sur la Côte Phénicienne en 1959. *Les Annales Archeologiques Arabes Syriennes* 10:111-132.
- Riis, P. J. 1961. l'Activité de la Mission Archéologique Danoise sur la Côte Phénicienne en 1960. *Les Annales Archeologiques Arabes Syriennes* 11:133-144.
- Riis, P. J. 1965. L'activité de la Mission Archéologique Danoise sur la Côte Phénicienne en 1963. *Les Annales Archeologiques Arabes Syriennes* 15(2):57-82.
- Riis, P. J. 1970. *Sukas I. The North-East Sanctuary and the First Settling of Greeks in Syria and Palestine*. Publications of the Carlsberg Expedition to Phoenicia I. Kobenhavn: Munksgaard.
- Riis, P. J. 1979. *Sukas VI: The Graeco-Phoenician Cemetery and Sanctuary at the Southern Harbour*. Publications of the Carlsberg Expedition to Phoenicia 7.

*Historisk-filosofiske skrifter (Kongelige Danske Videnskabernes Selskab)*  
10.2. Copenhagen: Munksgaard.

- Riis, P. J. 1983. "La ville phénicienne de Soukas de la fin de l'âge du bronze à la conquête romaine," in *Atti del I Congresso Internazionale di Studi Fenici e Punici, Roma, 5-10 Novembre 1979, Volume Secondo*. Edited by S. Moscati, pp. 509-514. Roma: Consiglio Nazionale Delle Ricerche.
- Riis, P. J. 1996. "Introduction," in *Sukas X: The Bronze and Early Iron Age Remains at the Southern Harbour, Publications of the Carlsberg Expedition to Phoenicia 12. Historisk-filosofiske skrifter (Kongelige Danske Videnskabernes Selskab) 17*. Edited by P. J. Riis, J. Jensen, M.-L. Buhl, and B. Otzen, pp. 5-10. Copenhagen: Munksgaard.
- Riis, P. J., and M.-L. Buhl. 1990. *Hama: fouilles et recherches, 1931-1938: Les objets de la période dite syro-hittite: (Age du Fer). NationalMuséets skrifter. Større Beretninger; 12*. Kobenhavn: NationalMuséet.
- Ripinsky, M. 1975. The Camel in Ancient Arabia. *Antiquity* 49:295-298.
- Robertson, M. 1940. The Excavations at Al Mina, Sueidia (Continued). *Journal of Hellenic Studies* 60:2-21.
- Robertson, M. 1946. The Excavations of Al Mina, Sueidia. IV. The Early Greek Vases. A Postscript. *Journal of Hellenic Studies* 66:125.
- Robinson, E. 1841. *Biblical Researches in Palestine, Mount Sinai, and Arabia Petraea*. Boston: Crocker and Brewster.
- Robinson, E., and E. Smith. 1867 (original 1841). *Biblical Researches in Palestine and Adjacent Regions: A Journal of Travels in the Years 1838 & 1852*, Third edition. London: John Murray.
- Roobaert, A. 1996. A Neo-Assyran Statue from Til Barsip. *Iraq* 59:79-87.
- Roobaert, A. 1990. "The City Gate Lions," in *Tell Ahmar: 1988 Season, Abri-Nahrain Supplement Series 2*. Edited by G. Bunnens, pp. 126-135. Leuven: Orientaliste.
- Roobaert, A., and G. Bunnens. 1999. "Excavations at Tell Ahmar - Til Barsib," in *Archaeology of the Upper Syrian Euphrates, The Tishrin Dam Area: Proceedings of the International Symposium Held at Barcelona, January 28th-30th 1998*. Edited by G. del Olmo Lete and J.-L. Montero Fenollos, pp. 163-178. Barcelona: Editorial AUSA.
- Rosenthal, F. 1968. *A History of Muslim Historiography*. Leiden: E. J. Brill.
- Sader, H. 1987. *Les Etats arameens de Syrie depuis leur fondation jusqu' a leur transformation en provinces assyriennes*. Beirut.
- Sader, H. 1990a. Tell Kazel and Ancient Simyra. *Berytus* 38:16-22.
- Sader, H. 1990b. Tell Kazel, Syria: Excavations of the AUB Museum, 1985-1987, Preliminary Reports: Appendix I An Epigraphic Note on a Phoenician Inscription from Tell Kazel. *Berytus* 38:94-97.
- Sader, H. 1991. Phoenician stelae from Tyre. *Berytus* 39:101-126.
- Sader, H. 1992. "The 12th Century B.C. in Syria: The Problem of the Rise of the Aramaeans," in *The Crisis Years: The 12th Century B.C. From Beyond the Danube to the Tigris*. Edited by W. A. Ward and M. S. Joukowsky, pp. 157-163. Iowa: Kendall Hunt.
- Sader, H. 2000. "The Aramaean Kingdoms of Syria: Origin and Formation Processes," in *Essays on Syria in the Iron Age*. Edited by G. Bunnens, pp. 61-76. Leuven: Peeters Press.
- Saggs, H. W. F. 1955a. The Nimrud Letters, 1952-I: The Ukin-Zer Rebellion and Related Texts. *Iraq* 17:21-56.

- Saggs, H. W. F. 1955b. The Nimrud Letters-II: Relations with the West. *Iraq* 17:126-160.
- Saghieh, M. S. 1983. *Byblos in the Third Millennium BC: A reconstruction of the stratigraphy and a study of the cultural connections*. Warminster: Aris & Phillips LTD.
- Saghieh, M. S. 1996. Bey 001 & 004 Preliminary Report. *Baal* 1:23-59.
- Sagona, A. G., and C. Haymes. 1992-1993. Excavations at Tell Nebi Mend, Syria. *Mediterranean Archaeology* 5/6:168-170.
- Sagona, A. G. 1982. Levantine Storage Jars of the 13th to 4th Century B.C. *Opuscula Atheniensia* 14:73-110.
- Said, E. 1978. *Orientalism: Western Conceptions of the Orient*. London: Routledge & Kegan Paul.
- Said, E. W. 1996. *Peace and its Discontents*. New York: Vintage Books.
- Saidah, R. 1966. Fouilles de Khaldé. Rapport Préliminaire sur la Première et Deuxième Campagnes (1961-1962). *Bulletin du Musée de Beyrouth* 19:51-90.
- Saidah, R. 1969. Archaeology in the Lebanon 1968-1969. *Berytus* 18:119-142.
- Saidah, R. 1971. Objets Grecs d'époque géométrique découverts récemment sur le littoral Libanais (à Khaldé près de Beyrouth). *Les Annales Archeologiques Arabes Syriennes* 21:193-198.
- Saidah, R. 1977. Une tombe de l'Age du Fer a Tambourit (Region de Sidon). *Berytus* 25:135-146.
- Saidah, R. 1983. "Nouveaux éléments de datation de la céramique de l'Âge du Fer au Levant," in *Atti del I Congresso Internazionale di Studi Fenici e Punici, Roma, 5-10 Novembre 1979, Volume Primo*. Edited by S. Moscati, pp. 213-216. Roma: Consiglio Nazionale Delle Ricerche.
- Saliège, J.-F., and H. Pessin. 2005. "Datation 14C de Tell Shiukh Fawqani: La Méthode et Ses Limites," in *Tell Shiyukh Fawqani 1994-1998*. Edited by L. Bachelot and F. M. Fales, pp. 1075-1079. Padova: Sargon Editrice e Libreria.
- Salles, J.-F. 1980. *La Necropole 'K' de Byblos. Recherche sur les grandes civilisations*. Boulogne: Maison de l'Orient.
- Salles, J.-F. 1995. "Rituel Mortuaire et Rituel Social à Ras Shamra/Ugarit," in *The Archaeology of Death in the Ancient Near East, Oxbow Monographs 51*. Edited by S. Campbell and A. Green, pp. 171-184. Oxford: Oxbow Books.
- Salvensen, A. 1998. "The Legacy of Babylon and Nineveh in Aramaic Sources," in *The Legacy of Mesopotamia*. Edited by S. Dalley, pp. 139-161. Oxford: Oxford University Press.
- Sapin, J., and H. Sayegh. 1998. "La Ceramique Commune," in *Un Quartier du Port Phénicien de Beyrouth au Fer III/Perse. Les Objets, Supplement no. 6 a Transeuphraténe*. Edited by J. Elayi and H. Sayegh, pp. 53-110. Paris: Gabalda.
- Sayegh, H. 1996. Bey 010 Les Souks, Secteur nord/est. *Baal* 1:235-269.
- Schachermeyr, F. 1982. *Die Levante im Zeitalter der Wanderungen: vom 13. bis zum 11. Jahrhundert v. Chr.* Vienna: Österreichische Akademie der Wissenschaft.
- Schaeffer, C. F.-A. 1938. Les Fouilles des Ras Shamra-Ugarit Neuvième Campagne (Printemps 1937). Rapport Sommaire. *Syria* 19:193-255.
- Schaeffer, C. F.-A. 1949. *Ugaritica II: Nouvelles études relatives aux découvertes de Ras Shamra. Mission de Ras Shamra Tome V. Bibliotheque Archeologique et Historique XLVII*. Paris: Librairie Orientaliste Paul Geuthner.
- Schiffer, S. 1930-1931. Tell Ahmar. *Archiv fur Orientforschung* 6:133-134.

- Schloen, J. D. 2001. *The House of the Father as Fact and Symbol Patrimonialism in Ugarit and the Ancient Near East. Studies in the Archaeology and History of the Levant 2*. Winona Lake, IN: Eisenbrauns.
- Schloen, J. D. 2002. W. F. Albright and the Origins of Israel. *Near Eastern Archaeology* 65:56-62.
- Schloen, D. 2003. "The Iron Age State as a State of Mind: A Response," in *One Hundred Years of American Archaeology in the Middle East*. Edited by D. R. Clark and V. H. Matthews, pp. 283-292. Boston: American Schools of Oriental Research.
- Schnapp, A. 1996. *The Discovery of the Past. The Origins of Archaeology*. London: British Museum Press.
- Schneider, E. 1999a. "Die eisenzeitliche Keramik von Tell Sheikh Hassan (Syrien)," in *Iron Age Pottery in Northern Mesopotamia, Northern Syria and South-Eastern Anatolia : papers presented at the meetings of the international "table ronde" at Heidelberg (1995) and Nieborów (1997) and other contributions, Altertumskunde des vorderen Orients ; Bd. 10*. Edited by A. Hausleiter and A. Reiche, pp. 325-346. Münster: Ugarit-Verlag.
- Schneider, E. 1999b. "'Assyrische' Schalen aus Tell Sheikh Hassan (Syrien) und ihre Stellung innerhalb der Keramik des assyrischen Einflussgebietes," in *Iron Age Pottery in Northern Mesopotamia, Northern Syria and South-Eastern Anatolia: papers presented at the meetings of the international "table ronde" at Heidelberg (1995) and Nieborów (1997) and other contributions, Altertumskunde des vorderen Orients ; Bd. 10*. Edited by A. Hausleiter and A. Reiche, pp. 347-375. Münster: Ugarit-Verlag.
- Schreiber, N. 2003. *The Cypro-Phoenician Pottery of the Iron Age. Culture and history of the ancient Near East; v. 13*. Leiden: Brill.
- Schumacher, G. 1908. *Tell el-Mutesellim I*. Leipzig.
- Schwartz, G. M. 1989. "The Origins of the Aramaeans in Syria and Northern Mesopotamia: Research Problems and Potential Strategies," in *To the Euphrates and Beyond: Archaeological Studies in Honour of Maurits N. van Loon*. Edited by O. M. C. Haex, H. H. Curvers, and P. M. M. G. Akkermans, pp. 275-291. Rotterdam: A. A. Balkema.
- Schwartz, S. 1995. Language, Power and Identity in Ancient Palestine. *Past and Present* 148:3-47.
- Scigliuzzo, E. 2002. Afis 2000-2001. Area B: la ceramica. *Egitto e Vicino Oriente* 25:20-22.
- Scigliuzzo, E. 2005. Tell Afis, Siria (2002-2004) Area B3: occupazione di Ferro II-III. *Egitto e Vicino Oriente* 28:41-45.
- Seeden, H. 1989. Bulldozers Destroy What Scientific Archaeology Exposed. *Berytus* 37:3-4.
- Seeden, H. 1990. Editorial. *Berytus* 38:3-5.
- Seeden, H. 1991. A *Tophet* in Tyre? *Berytus* 39:39-82.
- Seeden, H., and R. Thorpe. 1997-1998. Beirut from Ottoman Sea Walls and Landfill to a Twelfth Century BC Burial: Interim Report on the Archaeological Excavations of the Souks Northern Area (BEY 007). *Berytus* 43:221-254.
- Seirafi, F., A. Kirichian, and M. Dunand. 1965. Recherches archéologiques à Ayin Dara au nord-ouest d'Alep. *Les Annales Archeologiques Arabes Syriennes* 15(2):3-20.
- Seton-Williams, M. V. 1961. Preliminary Report on the Excavations at Tell Rifa'at. *Iraq* 23:68-87.

- Seton-Williams, M. V. 1967. The Excavations at Tell Rifa'at, 1964. Second Preliminary Report. *Iraq* 29:16-33.
- Seton-Williams, M. V. 1980. 'Tell Keisan, 1935-1936' in *Tell Keisan, 1971-1976: Une cite phenicienne en Galilee*. Edited by J. Briand and J.-B. Humbert, pp. 381-392; Pls 107-111. Paris: J Gabalda.
- Shaath, S. 1996. *Qal'at Halab*. Aleppo.
- Shanks, M., and C. Tilley. 1987a. *Re-Constructing Archaeology*. Cambridge.
- Shanks, M., and C. Tilley. 1987b. *Social Theory and Archaeology*. Cambridge: Polity Press.
- Sharon, I. 2001. "Philistine Bichrome Painted Pottery: Scholarly Ideology and Ceramic Typology," in *Studies in the Archaeology of Israel and Neighbouring Lands in Memory of Douglas L Esse, ASOR Books 5: Studies in Ancient Oriental Civilization 59*. Edited by S. R. Wolff, pp. 135-142. Chicago and Atlanta.
- Shefton, B. B., J. Elayi, H. Sayegh, and Z. Ghadar. 1998. "La Ceramique Grecque Importee," in *Un Quartier du Port Phénicien de Beyrouth au Fer III/Perse. Les Objets, Supplement no. 6 a Transeuphratène*. Edited by J. Elayi and H. Sayegh, pp. 111-149. Paris: Gabalda.
- Shennan, S. 1989. "Introduction: Archaeological Approaches to Cultural Identity," in *Archaeological Approaches to Cultural Identity*. Edited by S. Shennan, pp. 1-31. London: Unwin Hyman.
- Shennan, S. 1997. *Quantifying Archaeology*, Second edition. Edinburgh: Edinburgh University Press.
- Sherratt, A., and S. Sherratt. 1991. "From Luxuries to Commodities: The Nature of Mediterranean Bronze Age Trading Systems," in *Bronze Age Trade in the Mediterranean, Studies in Mediterranean Archaeology 90*. Edited by N. H. Gale, pp. 351-386. Jonsered: Aströms Förlag.
- Sherratt, A., and S. Sherratt. 1998. "Small Worlds: Interaction and Identity in the Ancient Mediterranean," in *The Aegean and the Orient in the Second Millennium. Proceedings of the 50th Anniversary Symposium, Cincinnati, 18-20 April 1997*. Edited by E. H. Cline and D. Harris-Cline, pp. 329-343. Liege: Annales d'archéologie égéenne de l'Université de Liège et UT-PASP.
- Sherratt, S. 1990. Reading the Texts: Archaeology and the Homeric Question. *Antiquity* 64:807-824.
- Sherratt, S. 1994a. "Commerce, Iron and Ideology: Metallurgical Innovation in 12th-11th Century Cyprus," in *Proceedings of the International Symposium, Cyprus in the Eleventh Century B.C*. Edited by V. Karageorghis, pp. 59-107. Nicosia.
- Sherratt, S. 1994b. Comment on Ora Negbi, 'The "Libyan Landscape" from Thera: A Review of Aegean Enterprises Overseas in the Late Minoan IA Period'. *Journal of Mediterranean Archaeology* 7:237-240.
- Sherratt, S. 1998. "'Sea Peoples' and the Economic Structure of the Late Second Millennium in the Eastern Mediterranean," in *Mediterranean Peoples in Transition: Thirteenth to Early Tenth Centuries BCE-In Honour of Professor Trude Dothan*. Edited by S. Gitin, A. Mazar, and E. Stern, pp. 292-313. Jerusalem: Israel Exploration Society.
- Sherratt, S. 2000. "Circulation of Metals and the End of the Bronze Age in the Eastern Mediterranean," in *Metals Make the World Go Round. The Supply and Circulation of Metals in Bronze Age Europe. Proceedings of a*



- conference held at the University of Birmingham in June 1997. Edited by C. F. E. Pare, pp. 82-98. Oxford: Oxbow Books.
- Sherratt, S. 2003a. Visible Writing: Questions of Script and Identity in Early Iron Age Greece and Cyprus. *Oxford Journal of Archaeology* 22(3):225-242.
- Sherratt, S. 2003b. "The Mediterranean Economy: 'Globalisation' at the End of the Second Millennium BCE," in *Symbiosis, Symbolism, and the Power of the Past. Canaan, Ancient Israel, and Their Neighbours from the Late Bronze Age through Roman Palaestina*. Edited by W. G. Dever and S. Gitin, pp. 37-61. Winona Lake, IN: Eisenbrauns.
- Sherratt, S. 2005a. "'Ethnicities', 'ethnonyms' and archaeological labels. Whose ideologies and whose identities?," in *Archaeological Perspectives on the Transmission and Transformation of Culture in the Eastern Mediterranean, Levant Supplementary Series 2*. Edited by J. Clarke, pp. 25-38. Oxford: Oxbow Books.
- Sherratt, S. 2005b. "High Precision Dating and Archaeological Chronologies: Revisiting an old problem," in *The Bible and Radiocarbon Dating: Archaeology, Text and Science*. Edited by T. E. Levy and T. Higham, pp. 114-128. London: Equinox.
- Sherratt, S., and A. Sherratt. 1993. The Growth of the Mediterranean Economy in the Early First Millennium B.C. *World Archaeology* 24:361-378.
- Shipton, G. M. 1939. *Notes on the Megiddo Pottery of Strata VI-XX. Studies in Ancient Oriental Civilisation 17*. Chicago: University of Chicago Press.
- Shortland, A. J. 2005. "Shishak, King of Egypt: The challenges of Egyptian calendrical chronology," in *The Bible and Radiocarbon Dating: Archaeology, Text and Science*. Edited by T. E. Levy and T. Higham, pp. 43-56. London: Equinox.
- Silberman, N. A. 1982. *Digging for God and Country. Exploration, Archaeology, and the Secret Struggle for the Holy Land*. New York: Alfred A. Knopf.
- Silberman, N. A. 1989. *Between Past and Present: Archaeology, Ideology and Nationalism in the Modern World*. New York: Henry Holt and Company.
- Silberman, N. A. 1991. Desolation and Restoration: The Impact of a Biblical Concept on Near Eastern Archaeology. *Biblical Archaeologist* 54:76-87.
- Silberman, N. A. 1993a. 'A Prophet From Amongst You' - *The Life of Yigael Yadin: Soldier, Scholar and Mythmaker of Modern Israel*. Reading, MA: Addison-Wesley.
- Silberman, N. A. 1993b. Visions of the Future: Albright in Jerusalem, 1919-1929. *Biblical Archaeologist* 56:8-17.
- Silberman, N. A. 1993c. "Petrie and the Founding Fathers," in *Biblical Archaeology Today*. Edited by A. Biran and J. Aviram, pp. 545-554. Jerusalem: Israel Exploration Journal.
- Silberman, N. A. 1995. "Promised Lands and Chosen Peoples: The Politics and Poetics of Archaeological Narrative," in *Nationalism, Politics, and the Practice of Archaeology*. Edited by P. L. Kohl and C. Fawcett, pp. 249-262. Cambridge: Cambridge University Press.
- Silberman, N. A. 1997. "Structuring the Past: Israelis, Palestinians, and the Symbolic Authority of Archaeological Monuments," in *The Archaeology of Israel: Constructing the Past, Interpreting the Present, Journal for the Study of the Old Testament Supplement Series 237*. Edited by N. A. Silberman and D. Small, pp. 62-81. Sheffield.

- Silberman, N. A. 1998a. "Whose Game is it Anyway? The Political and Social Transformations of American Biblical Archaeology," in *Archaeology Under Fire: Nationalism, Politics and Heritage in the Eastern Mediterranean and Middle East*. Edited by L. Meskell, pp. 175-188. London: Routledge.
- Silberman, N. A. 1998b. "The Sea Peoples, the Victorians and Us: Modern Social Ideology and Changing Archaeological Interpretation of the Late Bronze Age Collapse," in *Mediterranean Peoples in Transition: Thirteenth to Early Tenth Centuries BCE-In Honour of Professor Trude Dothan*. Edited by S. Gitin, A. Mazar, and E. Stern, pp. 268-275. Jerusalem: Israel Exploration Society.
- Silberman, N. A. 2003. "A Century of American Archaeology in the Middle East: Looking Back and Looking Ahead," in *One Hundred Years of American Archaeology in the Middle East*. Edited by D. R. Clark and V. H. Matthews, pp. 7-18. Boston: American Schools of Oriental Research.
- Singer, I. 1985. The Beginning of Philistine Settlement in Canaan and the Northern Boundary of Philistia. *Tel Aviv* 12:109-122.
- Smith, A. T. 2001. Review: On Landscapes in the Ancient Near East. *Journal of the Economic and Social History of the Orient* 44(3):363-371.
- Smith, G. A. 1892. *The Historical Geography of the Holy Land, Especially in Relation to the History of Israel and of the Early Church*. London: Hodder and Stoughton.
- Smith, R. H. 1973. *Pella of the Decapolis, I: The 1967 Season of the Wooster Expedition to Pella*.
- Smith, R. H. 1993. "Pella," in *The New Encyclopaedia of Archaeological Excavations in the Holy Land*. Edited by E. Stern, pp. 1174-1180. New York: Simon and Schuster.
- Smith, R. H., and T. F. Potts. 1992. "The Iron Age," in *Pella in Jordan 2: The Second Interim Report of the Joint University of Sydney and College of Wooster Excavations at Pella 1982-1985, Mediterranean Archaeology Supplement 2*. Edited by A. W. McNicoll, P. C. Edwards, J. Hanbury-Tenison, J. B. Hennessy, T. F. Potts, R. H. Smith, A. Walmsley, and P. Watson, pp. 83-102. Sydney: MEDITARCH.
- Smith, S. 1938. *Assyrian Sculptures in the British Museum: From Shalmaneser III to Sennacherib*. London: The British Museum.
- Smith, S. 1942. The Greek Trade at al Mina: A Footnote to Oriental History. *The Antiquaries Journal* 22:87-112.
- Snodgrass, A. M. 1980a. "Iron and Early Metallurgy in the Mediterranean," in *The Coming of the Age of Iron*. Edited by T. A. Wertime and J. D. Muhly, pp. 335-374. New Haven and London: Yale University Press.
- Snodgrass, A. M. 1980b. *Archaic Greece. The Age of Experiment*. London: Dent.
- Soldi, S. 2005. Tell Afis, Siria (2002-2004) Area A1: il settore occidentale. *Egitto e Vicino Oriente* 28:24-29.
- Sørensen, M. L. S. 1997. Material Culture and Typology. *Current Swedish Archaeology* 5:179-192.
- Sørensen, M. L. S. 2000. *Gender Archaeology*. Cambridge: Blackwell Publishers.
- Stager, L. E. 1985. Merenptah, Israel and Sea Peoples: New Light on an Old Relief. *Eretz Israel* 18 (Nahman Avigad Volume):56-64.
- Stager, L. E. 1995. "The Impact of the Sea Peoples in Canaan (1185-1050 BCE)," in *The Archaeology of Society in the Holy Land*. Edited by T. E. Levy, pp. 332-348. London.

- Stager, L. E. 2001. "Port Power in the Early and the Middle Bronze Age: The Organization of Maritime Trade and Hinterland Production," in *Studies in the Archaeology of Israel and Neighboring Lands in Memory of Douglas L. Esse*. Edited by S. R. Wolff, pp. 625-638. Chicago.
- Stark, M. T. 1998. "Technical Choices and Social Boundaries in Material Culture Patterning: An Introduction," in *The Archaeology of Social Boundaries*. Edited by M. T. Stark, pp. 1-11. Washington and London: Smithsonian Institution Press.
- Stark, M. T., R. L. Bishop, and E. Miksa. 2000. Ceramic Technology and Social Boundaries: Cultural Practices in Kalinga Clay Selection and Use. *Journal of Archaeological Method and Theory* 7:295-331.
- Stegman, J. S. 1986. *The Rule of Taste from George I to George IV*. London.
- Steel, L. 1998. The Social Impact of Mycenaean Imported Pottery in Cyprus. *Annual of the British School at Athens* 93:285-296.
- Steel, L. 2002. Consuming Passions: A Contextual Study of the Local Consumption of Mycenaean Pottery at Tell el'Ajjul. *Journal of Mediterranean Archaeology* 15(1):25-51.
- Steel, L. 2004. "A reappraisal of the distribution, context and function of Mycenaean pottery in Cyprus," in *La Ceramique Mycenienne de l'Egee au Levant. Hommage a Vronwy Hankey, Travaux de la Maison de l'Orient et de la Mediterranee*. Edited by J. Balensi, J.-Y. Monchambert, and S. Muller Celka, pp. 69-86. Lyon: Jean Pouilloux.
- Steiner, M. 2001-2002. The Hellenistic to Byzantine Souk; Results of the Excavations at Bey 011. *Aram* 13-14:113-127.
- Stern, E. 1982. *Material Culture of the Land of the Bible in the Persian Period 538-332 B.C.* Jerusalem.
- Stern, E. 1990a. New Evidence from Dor for the First Appearance of the Phoenicians Along the Northern Coast of Israel. *Bulletin of the American Schools of Oriental Research* 279:27-34.
- Stern, E. 1990b. Hazor, Dor and Megiddo in the Time of Ahab and Under Assyrian Rule. *Israel Exploration Journal* 40:12-30.
- Stern, E. 1991. "Phoenicians, Sikils, and Israelites in the Light of Recent Excavations at Tel Dor," in *Phoenicia and the Bible: Proceedings of the Conference held at the University of Leuven on the 15th and 16th of March 1990, Studi Phoenicia* 9. Edited by E. Lipinski, pp. 85-94. Leuven: Uitgeverij Peeters.
- Stieglitz, R. R. 1990. The Geopolitics of the Phoenician Littoral in the Early Iron Age. *Bulletin of the American Schools of Oriental Research* 279:9-12.
- Stieglitz, R. R. 1991. The City of Amurru. *Journal of Near Eastern Studies* 50:45-48.
- Stone, B. J. 1995. The Philistines and Acculturation: Culture Change and Ethnic Continuity in the Iron Age. *Bulletin of the American Schools of Oriental Research* 298:7-32.
- Stone, E. C., and P. E. Zimansky. 1999. *The Iron Age Settlement at 'Ain Dara, Syria. Survey and Soundings. BAR International Series 786*. Oxford: Archaeopress.
- Strange, J. 2000. "A Proposal for a New Periodization for the Bronze and Iron Ages in the Southern Levant (Jordan, Palestine and Israel)," in *Proceedings of the First International Congress on the Archaeology of the Ancient Near East, Rome, May 18-23, 1998. Volume II*. Edited by P. Matthiae, A. Enea, L. Peyronel, and F. Pinnock, pp. 1571-1577. Rome: Universita degli Studi di Roma 'La Sapienza'.

- Strika, V. 2000. "The Perception of the Past in the Near East. Two Case-Studies: Iraq and Saudi Arabia," in *Proceedings of the First International Congress on the Archaeology of the Ancient Near East, Rome, May 18th-23rd 1998*. Edited by P. Matthiae, A. Enea, L. Peyronel, and F. Pinnock, pp. 1579-1586. Rome.
- Strommenger, E. 1985a. "Hadatu (Arslantash)," in *Ebla to Damascus: Art and Archaeology of Ancient Syria: An Exhibition from the Director-General of Antiquities and Museums, Syrian Arab Republic*. Edited by H. Weiss, pp. 330-332. Washington DC: Smithsonian Institution Travelling Exhibition Service.
- Strommenger, E. 1985b. "Til Barsip/Kar Shalmaneser (Tell Ahmar)," in *Ebla to Damascus: Art and Archaeology of Ancient Syria: An Exhibition from the Director-General of Antiquities and Museums, Syrian Arab Republic*. Edited by H. Weiss, pp. 330. Washington DC: Smithsonian Institution Travelling Exhibition Service.
- Stronach, D. 1997. "Notes on the Fall of Nineveh," in *Assyria 1995: Proceedings of the 10th Anniversary Symposium of the Neo-Assyrian Text Corpus Project Helsinki, September 7-11, 1995*. Edited by S. Parpola and R. M. Whiting, pp. 307-324. Helsinki: The Neo-Assyrian Text Corpus Project.
- Stuart, B. 2001-2002. Cemeteries in Beirut. *Aram* 13-14:37-49.
- Stubblings, F. H. 1951. *Mycenaean Pottery from the Levant*. Cambridge.
- Stucky, R. 2000. Le Sanctuaire Sidonien d'Echmoun Aperçu historique du site, des fouilles et des découvertes faites à Bostan ech-Cheikh. *Baal* 4:123-148.
- Stucky, R. 2004. "Eléments de construction en marbre à décor animalier de Sidon et la culture phénicienne aux époques perse et hellénistique ancienne," in *Decade: A Decade of Archaeology and History in the Lebanon*. Edited by C. Doumet-Serhal, pp. 214-223. Beirut: The Lebanese British Friends of the National Museum.
- Suleiman, A. 1984. Excavations at Ansari-Aleppo for the Seasons 1973-1980. Early and Middle Bronze Ages. *Akkadica* 40:1-16.
- Suleiman, A. 1999. Excavations at Ansari Near Aleppo. *Les Annales Archéologiques Arabes Syriennes* 43:247-248.
- Summers, G. D. 1993. *Tille Höyük 4. The Late Bronze Age and the Iron Age Transition. British Institute of Archaeology at Ankara Monograph 15*. London: The British Institute of Archaeology at Ankara.
- Swift, G. F. Jr 1958. The Pottery of the 'Amuq Phase K to O, and its Historical Relationship, Unpublished Dissertation, University of Chicago.
- Szzyrmer, M. 1975. Quelques remarques à propos de la formation de l'alphabet phénicien. *Semitica* 24:4-12.
- Tadmor, H. 1958. The Campaigns of Sargon II of Assur: A Chronological-Historical Study. *Journal of Cuneiform Studies* 12(1):22-40.
- Tadmor, H. 1975. "Assyria and the West: the Ninth Century and its Aftermath," in *Unity and Diversity. Essays in the History, Literature, and Religion of the Ancient Near East*. Edited by H. Goedicke and J. J. M. Roberts, pp. 36-48. London: The Johns Hopkins University Press.
- Tadmor, H. 1981. "History and Ideology in the Assyrian Royal Inscriptions," in *Assyrian Royal Inscriptions: New Horizons in literary, ideological, and historical analysis. Papers of a Symposium held in Cetona (Siena) June 26-28, 1980*. Edited by F. M. Fales, pp. 13-34. Roma: Istituto per l'Oriente.
- Tadmor, H. 1997. "Propaganda, Literature, Historiography: Cracking the Code of the Assyrian Royal Inscriptions," in *Assyria 1995: Proceedings of the 10th*

- Anniversary Symposium of the Neo-Assyrian Text Corpus Project Helsinki, September 7-11, 1995.* Edited by S. Parpola and R. M. Whiting, pp. 325-338. Helsinki: The Neo-Assyrian Text Corpus Project.
- Tainter, J. 1988. *The Collapse of Complex Societies*. Cambridge: Cambridge University Press.
- Taylor, W. 1948. *A Study of Archaeology*. Menasha, WI.
- Taylor, M. B. 1984. The Pottery from the Iron Age Gate at Tell Qarqur, Brigham Young University.
- Tefnin, R. 1976. Le Tell Abou Danne: Mission belge en Mesopotamie (Syrie du Nord). *Archeologia* 95:62-63.
- Tefnin, R. 1978-1979. Tall Abu Danna. *Archiv fur Orientforschung* 26:145-147.
- Tefnin, R. 1980a. "Deux campagnes de fouilles au Tell Abou Danne (1975-1976)," in *Le Moyen Euphrate: Actes du Colloque de Strasbourg 10-12 mars 1977*. Edited by J.-C. Margueron, pp. 179-199. Strasbourg.
- Tefnin, R. 1980b. Les niveaux supérieurs du Tell Abou Danne: Chantier A 1977-78. *Syro-Mesopotamian Studies* 3(3):110-168.
- Tefnin, R. 1981-1982. Tall Abu Danna. *Archiv fur Orientforschung* 28:201-202.
- Tefnin, R. 1983. Aperçu sur Neuf Campagnes de Fouilles Belges aux Tells Abou Danne et Oumm el-Marra (1975-1983). *Les Annales Archeologiques Arabes Syriennes* 33:141-151.
- Tenu, A., and L. Bachelot. 2005. Tell Shiukh Fawqani (Syrie): la campagne de sondages 2003 dans la nécropole à incinération. *Akkadica* 126:159-168.
- Thalmann, J.-P. 1978a. Tell 'Arqa 1978-1979 Rapport Provisoire. *Bulletin du Musée de Beyrouth* 30:61-75.
- Thalmann, J.-P. 1978b. Tell 'Arqa (Liban Nord): Campagnes I-III (1972-1974): Chantier I: Rapport Preliminaire. *Syria* 55:1-151.
- Thalmann, J.-P. 1981-1982. Tall 'Arqa. *Archiv fur Orientforschung* 28:206-208.
- Thalmann, J.-P. 1983. "Les Niveaux de l'Age de Bronze et de l'Age du Fer a Tell 'Arqa (Liban)," in *Atti del I Congresso Internazionale di Studi Fenici e Punici, Roma, 5-10 Novembre 1979, Volume Primo*. Edited by S. Moscati, pp. 217-222. Roma: Consiglio Nazionale Delle Ricerche.
- Thalmann, J.-P. 1989-1990. Prospection de la plaine du Akkar syrien, 1986-7. *Archiv fur Orientforschung* 36/37:344-346.
- Thalmann, J.-P. 1990. Tell 'Arqa, de la conquête assyrienne à l'époque perse. *Transeuphratène* 2:51-56.
- Thalmann, J.-P. 1991a. L'age du Bronze a Tell Arqa (Liban-Nord). *Orient-Express* 1991:20-21.
- Thalmann, J.-P. 1991b. L'age du Bronze a Tell 'Arqa: Bilan et Perspectives (1981-1991). *Berytus* 39:21-38.
- Thalmann, J.-P. 2000a. "Le peuplement de la Plaine du Akkar a l'age du Bronze," in *Proceedings of the First International Congress on the Archaeology of the Ancient Near East, Rome, May 18-23, 1998. Volume II*. Edited by P. Matthiae, A. Enea, L. Peyronel, and F. Pinnock, pp. 1615-1636. Rome: Universita degli Studi di Roma 'La Sapienza'.
- Thalmann, J.-P. 2000b. Tell Arqa. *Baal* 4:5-74.
- Thalmann, J.-P. 2003. Transporter et Conserver: Jarres de l'age du Bronze a Tell Arqa. *Archaeology and History in the Lebanon* 17:25-37.
- Thalmann, J.-P. 2006a. *Tell Arqa I. Les niveaux de l'âge du Bronze Volume I: Texte*. BAH 177. Beyrouth: IFAPO.

- Thalmann, J.-P. 2006b. *Tell Arqa I. Les niveaux de l'âge du Bronze Volume II: Planches. BAH 177*. Beyrouth: IFAPO.
- Thalmann, J.-P., and M. al-Maqdissi. 1989. "Prospection de la trouée de Homs," in *Contribution française à l'archéologie syrienne*, pp. 98-101. Damascus: Institut français d'archéologie du Proche-Orient, Centre de Damas.
- Thomas, H. L. 1967. *Near Eastern, Mediterranean and European Chronology. The historical, archaeological, radiocarbon, pollen-analytical and geochronological evidence*. Lund: Studies in Mediterranean Archaeology XVII.
- Thomsen, P. 1935-1936. Hamath. *Archiv fur Orientforschung* 10:302.
- Thomsen, P. 1936-1937a. Hamath. *Archiv fur Orientforschung* 11:267-268.
- Thomsen, P. 1936-1937b. Byblos. *Archiv fur Orientforschung* 11:268.
- Thomsen, P. 1937-1939. Hamath. *Archiv fur Orientforschung* 12:298.
- Thorpe, R. 1998-1999a. Bey 007 The Souks Area, Preliminary Report of the AUB/ACRE Project. *Baal* 3:31-56.
- Thorpe, R. 1998-1999b. Bey 045, Preliminary Report on the Excavations. *Baal* 3:57-83.
- Thuesen, I. 1988. *Hama: fouilles et recherches, 1931-1938: I. The Pre- and Protohistoric Periods*. Vol. 1. Copenhagen: Nationalmuseet.
- Thureau-Dangin, F. 1929. Tell Ahmar. *Syria* 10:185-205.
- Thureau-Dangin, F. 1930a. L'inscription des lions de Til-Barsip. *Revue D'Assyriologie* 27:11-21.
- Thureau-Dangin, F. 1930b. Un specimen des peintures assyriennes de Til Barsip. *Syria* 11:113-132.
- Thureau-Dangin, F., Barrois, A., Dossin, G. and M. Dunand. 1931a. *Arslan-Tash (Texte)*. Paris: Librairie Orientaliste Paul Geuthner.
- Thureau-Dangin, F., Barrois, A., Dossin, G. and M. Dunand. 1931b. *Arslan-Tash (Atlas)*. Paris: Librairie Orientaliste Paul Geuthner.
- Thureau-Dangin, F., and M. Dunand. 1936a. *Til-Barsib (Texte)*. *Bibliothèque archéologique et historique (Haut-Commissariat de la République Française en Syrie et au Liban, Service des antiquités)* 23. Paris: Geuthner.
- Thureau-Dangin, F., and M. Dunand. 1936b. *Til-Barsib (Album)*. *Bibliothèque archéologique et historique (Haut-Commissariat de la République Française en Syrie et au Liban, Service des antiquités)* 23. Paris: Geuthner.
- Thurston, T. L. 1997. Historians, Prehistorians, and the Tyranny of the Historical Record: Danish State Formation Through Documents and Archaeological Data. *Journal of Archaeological Method and Theory* 4:239-264.
- Trigger, B. G. 1980. *Gordon Childe: Revolutions in Archaeology*. New York: Columbia University Press.
- Trigger, B. G. 1984. Alternative Archaeologies: Nationalist, Colonialist, Imperialist. *Man* 19:355-370.
- Trigger, B. G. 1989. *A History of Archaeological Thought*. Cambridge.
- Trigger, B. G. 1995. "Romanticism, Nationalism and Archaeology," in *Nationalism, Politics, and the Practice of Archaeology*. Edited by P. L. Kohl and C. Fawcett, pp. 263-279. Cambridge: Cambridge University Press.
- Trigger, B. G., and I. Glover. 1981. Editorial. *World Archaeology* 13:133-137.
- Tubb, J. N. 1988. "The Role of the Sea Peoples in the bronze industry of Palestine/Transjordan in the Late Bronze Age - Early Iron transition," in *Bronzeworking centres of Western Asia c. 1000-539 BC*. Edited by J. Curtis, pp. 251-270. London: Keegan Paul International.

- Turner, G. 1968. The Palace and *Batiment aux Ivoires* at Arslan Tash: A Reappraisal. *Iraq* 30:62-68.
- Tvedtnes, J. A. 1981. The Origin of the Name 'Syria'. *Journal of Near Eastern Studies* 40(2):139-140.
- Tylecote, R. F. 1980. "Furnaces, Crucibles, and Slags," in *The Coming of the Age of Iron*. Edited by T. A. Wertime and J. D. Muhly, pp. 183-228. New Haven and London: Yale University Press.
- Ussishkin, D. 1966. Building IV in Hamath and the Temples of Solomon and Tell Tayanat. *Israel Exploration Journal* 16:104-110.
- Ussishkin, D. 1968. 'Der Alt Bau' in Zincirli. *Bulletin of the American Schools of Oriental Research* 189:50-53.
- Ussishkin, D. 1967a. On the Dating of Some Groups of Reliefs from Carchemish and Til Barsip. *Anatolian Studies* 17:181-192.
- Ussishkin, D. 1971. Was Bit-Adani a Neo-Hittite or Aramaean State? *Orientalia* 40:431-437.
- Ussishkin, D. 1976. The Monuments of the Lower Palace Area in Carchemish: A Rejoinder. *Anatolian Studies* 26:105-112.
- Ussishkin, D. 1982. *The Conquest of Lachish by Sennacherib*. Tel Aviv: Tel Aviv University.
- Ussishkin, D. 1990a. Notes on Megiddo, Gezer, Ashdod and Tel Batash in the Tenth to Ninth Centuries B.C. *Bulletin of the American Schools of Oriental Research* 277/278:71-91.
- Ussishkin, D. 1990b. The Assyrian Attack on Lachish: The Archaeological Evidence from the Southwest Corner of the Site. *Tel Aviv* 17:53-86.
- Ussishkin, D. 1997. "Megiddo," in *The Oxford Encyclopedia of Archaeology in the Near East*. Vol. 3. Edited by E. M. Meyers, pp. 460-469. Oxford: Oxford University Press.
- Ussishkin, D., and J. Woodhead. 1992. Excavations at Tel Jezreel 1990-1991: Preliminary Report. *Tel Aviv* 19:3-56.
- Ussishkin, D., and J. Woodhead. 1994. Excavations at Tel Jezreel 1992-1993: Second Preliminary Report. *Levant* 26:1-48.
- Ussishkin, D., and J. Woodhead. 1997. Excavations at Tel Jezreel 1994-1996: Third Preliminary Report. *Tel Aviv* 24:6-72.
- van Beek, G. W. 1951. Cypriote Chronology and the Dating of Iron I Sites in Palestine. *Bulletin of the American Schools of Oriental Research* 124:26-29.
- van Beek, G. W. 1955. The Date of Tell Abu Hawam Stratum III. *Bulletin of the American Schools of Oriental Research* 138:34-38.
- van Beek, G. W. 1987. Digging up Tell Jemmeh. *Archaeology* 36:12-19.
- van Loon, M. 1995. "A Neo-Hittite Relief in Aleppo," in *Studio historiae ardens: Ancient Near Eastern Studies Presented to Philo H. J. Houwink ten Cate on the Occasion of his 65th birthday*. Edited by T. P. J. van den Hout and J. De Roos, pp. 181-186. Leiden: Uitgaven van het nederlands historisch-archaeologisch instituut te Istanbul 74.
- van Seters, J. 1997. *In Search of History: Historiography in the Ancient World and the Origins of Biblical History*. Winona Lake: Eisenbrauns.
- van Wijngaarden, G. J. 1999. "Production, Circulation and Consumption of Mycenaean Pottery (Sixteenth to Twelfth Centuries BC)," in *The Complex Past of Pottery. Production, Circulation and Consumption of Mycenaean and Greek Pottery (Sixteenth to Early Fifteenth Centuries B.C.)*. Edited by J. P.

- Crielaard, V. Stissi, and G. J. van Wijngaarden, pp. 21-47. Amsterdam: J. C. Gieben.
- van Wijngaarden, G. J. 2002. *Use and Appreciation of Mycenaean Pottery in the Levant, Cyprus and Italy (1600-1200 BC)*. Amsterdam: Amsterdam University Press.
- Veit, U. 1989. "Ethnic Concepts in German Prehistory: a case study on the relationship between identity and objectivity," in *Archaeological Approaches to Cultural Identity*. Edited by S. Shennan, pp. 35-56. London: Unwin Hyman.
- Venturi, F. 1997. Mission archeologique de Tell Afis (Syrie), campagne 1996. *Orient-Express* 1997:11-13.
- Venturi, F. 1998a. "The Late Bronze II and Early Iron I Levels (Area E1)," in *Tell Afis, Siria : scavi sull'acropoli 1988-1992 = The 1988-1992 excavations on the Acropolis, Ricerche di archeologia del Vicino Oriente ; 1*. Edited by S. M. Cecchini and S. Mazzoni, pp. 123-162. Pisa: Edizioni ETS.
- Venturi, F. 1998b. Mission archeologique de Tell Afis (Siria). Campagne 1997. *Orient-Express* 1998/1:13-16.
- Venturi, F. 2000a. "Le Premier Age du Fer a Tell Afis et in Syrie Septentrionale," in *Essays on Syria in the Iron Age, Ancient Near Eastern studies. Supplement 7*. Edited by G. Bunnens, pp. 505-536. Louvain: Peeters Press.
- Venturi, F. 2000b. Il Bronzo Tardo II ed il Ferro I (livelli 10-5). *Egitto e Vicino Oriente* 22.
- Venturi, F. 2000c. "Tell Afis et la 'Dark Age' (les niveaux de la fin du Bronze recent II et de l'age du Fer I)," in *Proceedings of the First International Congress on the Archaeology of the Ancient Near East, Rome, May 18-23, 1998. Volume II*. Edited by P. Matthiae, A. Enea, L. Peyronel, and F. Pinnock, pp. 1715-1730. Rome: Universita degli Studi di Roma 'La Sapienza'.
- Venturi, F. 2002. Afis 2000-2001. Area E: l'occupazione del Bronzo Tardo II - Ferro I. Il settore Sud. *Egitto e Vicino Oriente* 25:29-33.
- Venturi, F. 2005. Tell Afis, Siria (2002-2004) Area E4b sud: Bronzo Tardo II - Ferro I. *Egitto e Vicino Oriente* 28:69-76.
- Vesco, D., and S. Soldi. 2002. L'informatizzazione della documentazione grafica. *Egitto e Vicino Oriente* 25:7-9.
- Virgilio, F. 2002. Afis 2000-2001. Area B: le mura del Ferro II-III. *Egitto e Vicino Oriente* 25:19-20.
- Virgilio, F. 2005. Tell Afis, Siria (2002-2004) Area B2: fortificazione e zona abitativa del Ferro II-III. *Egitto e Vicino Oriente* 28:37-41.
- Volney, M. C.-F. 1772 (original 1787). *Travels through Syria and Egypt, in the Years 1783, 1784, and 1785*. London: G G J and J Robinson.
- von Luschan, F. 1902. *Ausgrabungen in Sendschirli III, Thorsculpturen*. Berlin: W. Spemann.
- von Oppenheim, M. 1933. *Tell Halaf: A New Culture in Oldest Mesopotamia*. London and New York: G P Putnam's Sons.
- von Oppenheim, M. 1962. *Tell Halaf. Vierter Band: Die Kleinfunde aus Historischer Zeit*. Berlin: Walter de Gruyter & Co.
- Wachsmuth, F. 1923-1924. Die Baugeschichte von Sendschirli (Samal). *Jahrbuch des Deutschen Archäologischen Instituts* 38-39:158-169.
- Wada, H. 1994. Pottery Vessels in the Iron Age II in the South Area of Tell Mastuma in 1993 Season. *Bulletin of the Ancient Orient Museum* 15:51-76.



- Wailes, B., and A. L. Zoll. 1995. "Civilization, barbarism, and nationalism in European archaeology," in *Nationalism, Politics, and the Practice of Archaeology*. Edited by P. L. Kohl and C. Fawcett, pp. 21-38. Cambridge: Cambridge University Press.
- Wainwright, G. A. 1936. The Coming of Iron. *Antiquity* 10:5-24.
- Wakita, S., I. Asano, H. Wada, A. Tsuneki, and T. Nakamura. 1994. Tell Mastuma. A Preliminary Report of the Excavations in Idlib, Syria 1993. *Bulletin of the Ancient Orient Museum* 15:23-50.
- Wakita, S., I. Asano, H. Wada, T. Adachi, S. Nishiyama, Y. Okada, and Y. Ikeda. 1995. Tell Mastuma. A Preliminary Report of the Excavations in Idlib, Syria 1994 and 1995. *Bulletin of the Ancient Orient Museum* 16:1-73.
- Wakita, S., H. Wada, and S. Nishiyama. 2000. "Tell Mastuma: Change in Settlement Plans and Historical Context During the First Quarter of the First Millennium B.C.," in *Essays on Syria in the Iron Age, Ancient Near Eastern studies. Supplement 7*. Edited by G. Bunnens, pp. 537-557. Louvain: Peeters Press.
- Waldbaum, J. C. 1978. *From Bronze to Iron. The Transition from the Bronze Age to the Iron Age in the Eastern Mediterranean. Studies in Mediterranean Archaeology 54*. Göteborg: Paul Åströms Förlag.
- Waldbaum, J. C. 1980. "The First Archaeological Appearance of Iron and the Transition to the Iron Age," in *The Coming of the Age of Iron*. Edited by T. A. Wertime and J. D. Muhly, pp. 69-98. New Haven and London: Yale University Press.
- Waldbaum, J. C. 1994. Early Greek Contacts with the Southern Levant, ca. 1000-600 B.C.: The Eastern Perspective. *Bulletin of the American Schools of Oriental Research* 293:53-66.
- Waldbaum, J. C. 1997. Greeks in the East or Greek and the East? Problems in the Definition and Recognition of Presence. *Bulletin of the American Schools of Oriental Research* 305:1-18.
- Waldbaum, J. C. 1999. "The Coming of Iron in the Eastern Mediterranean: Thirty Years of Archaeological and Technological Research," in *The Archaeometallurgy of the Asian Old World*. Edited by V. Pigott, pp. 27-58. Philadelphia: University Museum.
- Waldbaum, J. C., and J. Magness. 1997. The Chronology of Early Greek Pottery: New Evidence from Seventh Century B.C. Destruction Levels in Israel. *American Journal of Archaeology* 101(1):23-40.
- Walmsley, A., P. G. Macumber, P. C. Edwards, S. J. Bourke, and P. M. Watson. 1993. The Eleventh and Twelfth Seasons of Excavation at Pella (Tabaqat Fahl) 1989-1990. *Annual of the Department of Antiquities of Jordan* 37:165-240.
- Wapnish, P. 1984. "The Dromedary and Bactrian Camel in Levantine Historical Settings: The Evidence from Tell Jemmeh," in *Animals and Archaeology: 3. Early Herders and their Flocks, BAR International Series 202*. Edited by J. Clutton-Brock and C. Grigson, pp. 171-200. Oxford: BAR.
- Ward, W. A., and M. S. Joukowsky. Editors. 1992. *The Crisis Years: The 12th Century B.C. From Beyond the Danube to the Tigris*. Dubuque, Iowa: Kendall/Hunt.
- Ward, W. H. 1888. Unpublished or Imperfectly Published Hittite Monuments III: Reliefs at Carchemish=Jerablus. *The American Journal of Archaeology and of the History of the Fine Arts* 4:172-174.

- Ward, W. H., and A. L. Frothingham. 1887. Unpublished or Imperfectly Published Hittite Monuments II: Sculptures Near Sindjirli. *The American Journal of Archaeology and of the History of the Fine Arts* 3:62-69.
- Wartke, R.-B. 2005. *Sam'al: Ein aramäischer Stadtstaat des 10. bis 8. Jhs v. Chr. Und die Geschichte seiner Erforschung*. Mainz am Rhein: Verlag Philipp von Zabern.
- Waterfield, G. 1963. *Layard of Nineveh*. London: John Murray.
- Waterfield, G. 1987. "Reflections on A.H. Layard's Character and Early Career," in *Austen Henry Layard Tra l'Oriente e Venezia*. Edited by F. M. Fales and B. J. Hickey, pp. 7-18. Roma.
- Watson, P., and J. Tidmarsh. 1996. Pella/Tall al-Husn Excavations 1993: The University of Sydney's 15th Season. *Annual of the Department of Antiquities of Jordan* 40:293-314.
- Watzinger, C. 1929. *Tell el-Mutesellim: Bericht über die 1903 bis 1905 mit Unterstützung Sr. Majestät des Deutschen Kaisers und der Orient-Gesellschaft vom Deutschen Verein zur Erforschung Palästinas veranstalteten Ausgrabungen, Band 2. Die Funde*. Leipzig: J. C. Hinrichs.
- Webb, J. M., and D. Frankel. 1994. Making an Impression: Storage and Surplus Finance in Late Bronze Age Cyprus. *Journal of Mediterranean Archaeology* 7(1):5-26.
- Weiss, H. Editor. 1985. *Ebla to Damascus: Art and Archaeology of Ancient Syria: An Exhibition from the Director-General of Antiquities and Museums, Syrian Arab Republic*. Washington DC: Smithsonian Institution Travelling Exhibition Service.
- Weiss, H. 1991. Archaeology in Syria. *American Journal of Archaeology* 95(4):683-740.
- Weiss, H. 1994. Archaeology in Syria. *American Journal of Archaeology* 98(1):101-158.
- Weiss, H. 1997. Archaeology in Syria. *American Journal of Archaeology* 101(1):97-148.
- Wengrow, D. 2006. "The Idea of Prehistory in the Middle East," in *A Future for Archaeology: The Past in the Present*. Edited by R. Layton, S. Shennan, and P. Stone, pp. 187-197. London: UCL Press.
- Wertime, T. A. 1980. "The Pyrotechnologic Background," in *The Coming of the Age of Iron*. Edited by T. A. Wertime and J. D. Muhly, pp. 1-24. New Haven and London: Yale University Press.
- West, M. L. 1988. The Rise of the Greek Epic. *Journal of Hellenic Studies* 108:151-172.
- Whincop, M. R. 2007. The Iron Age II at Tell Nebi Mend: Towards an Explanation of Ceramic Regions. *Levant* 39:185-212.
- Whitelam, K. 1996. *The Invention of Ancient Israel, the silencing of Palestinian history*. London: Routledge.
- Whiting, C. 2002. Complexity and Diversity in the Late Iron Age Southern Levant: The Investigation of 'Edomite' Archaeology and Scholarly Discourse. Unpublished PhD Thesis, Durham University.
- Whiting, C. 2007a. *Complexity and Diversity in the Late Iron Age Southern Levant: The investigation of 'Edomite' archaeology and scholarly discourse*. BAR International Series 1672. Oxford: Archeopress.
- Whiting, C. 2007b. Telling it as it was in the southern Levant: a task of biblical proportions? *Antiquity* 81:210-213.

- Wightman, G. J. 1985. Megiddo VIA-III: Associated Structures and Chronology. *Levant* 17:117-129.
- Wightman, G. J. 1990a. The Myth of Solomon. *Bulletin of the American Schools of Oriental Research* 277/278:5-22.
- Wightman, G. J. 1990b. "Area B - Sounding in the Middle City," in *Tell Ahmar: 1988 Season, Abr-Nahrain Supplement Series 2*. Edited by G. Bunnens, pp. 106-120. Leuven: Orientaliste.
- Wilhelm, G. 1973. Eine Krughenkelschrift in Alphabetischer Keilschrift aus Kamid el-Loz. *Ugarit-Forschungen* 5:284-285.
- Wilken, R. L. 1992. *The Land Called Holy: Palestine in Christian History and Thought*. New Haven and London.
- Wilkens, B. 1998. "The Faunal Remains," in *Tell Afis, Siria: scavi sull'acropoli 1988-1992 = The 1988-1992 excavations on the Acropolis, Ricerche di archeologia del Vicino Oriente ; 1*. Edited by S. M. Cecchini and S. Mazzoni, pp. 433-450. Pisa: Edizioni ETS.
- Wilkens, B. 2002. Afis 2000-2001. I resti faunistici. *Egitto e Vicino Oriente* 25:58-67.
- Wilkinson, T. J. 2003. *Archaeological Landscapes of the Near East*. Tucson: University of Arizona Press.
- Will, E., J. M. Dentzer, and J.-P. Thalmann. 1973. La Première Campagne de Fouilles à Tell Arqa (Liban Nord). *Bulletin du Musée de Beyrouth* 26:61-79.
- Williamson, H. G. M. 1991. Jezreel in the Biblical Texts. *Tel Aviv* 18:72-92.
- Wilson, J. A. 1968. "A Century of Near Eastern Archaeology and the Future," in *The Role of the Phoenicians in the Interaction of Mediterranean Civilisations*. Edited by W. A. Ward, pp. 113-122. Beirut: American University of Beirut.
- Wilson, J. A. 1969a. "The War Against the Peoples of the Sea," in *Ancient Near Eastern Texts Relating to the Old Testament*, Third Edition with Supplement edition. Edited by J. B. Pritchard, pp. 262-263. Princeton, New Jersey: Princeton University Press.
- Wilson, J. A. 1969b. "The Campaign of Sheshonk I," in *Ancient Near Eastern Texts Relating to the Old Testament*, Third Edition with Supplement edition. Edited by J. B. Pritchard, pp. 263-264. Princeton, New Jersey: Princeton University Press.
- Wilson, J. A. 1969c. "Tiglath-Pileser III (744-727): Campaigns Against Syria and Palestine," in *Ancient Near Eastern Texts Relating to the Old Testament*, Third Edition with Supplement edition. Edited by J. B. Pritchard, pp. 282-284. Princeton, New Jersey: Princeton University Press.
- Wilson, J. A. 1969d. "Sargon II (721-705): The Fall of Samaria," in *Ancient Near Eastern Texts Relating to the Old Testament*, Third Edition with Supplement edition. Edited by J. B. Pritchard, pp. 284-287. Princeton, New Jersey: Princeton University Press.
- Wilson, J. A. 1969e. "The Journey of Wen-Amun to Phoenicia," in *Ancient Near Eastern Texts Relating to the Old Testament*, Third Edition with Supplement edition. Edited by J. B. Pritchard, pp. 25-29. Princeton, New Jersey: Princeton University Press.
- Wilson, J. A. 1969f. "Papyrus Harris I," in *Ancient Near Eastern Texts Relating to the Old Testament*, Third Edition with Supplement edition. Edited by J. B. Pritchard, pp. 262. Princeton, New Jersey: Princeton University Press.
- Wilson, K. A. 2005. *The Campaign of Pharaoh Shoshenq I into Palestine. Forschungen zum Alten Testament 2 Reihe 9*. Tübingen: Mohr Siebeck.

- Winstone, H. V. F. 1982. *The Illicit Adventure: The Story of Political and Military Intelligence in the Middle East from 1898 to 1926*. London: Jonathan Cape.
- Winstone, H. V. F. 1990. *Woolley of Ur: The Life of Sir Leonard Woolley*. London: Secker & Warburg.
- Winter, I. J. 1976. Phoenician and North Syrian Ivory Carving in Historical Context: Questions of style and distribution. *Iraq* 38:1-22.
- Winter, I. J. 1988. "North Syria as a bronzeworking centre in the early first millennium BC: luxury commodities at home and abroad," in *Bronzeworking centres of Western Asia c. 1000-539 BC*. Edited by J. Curtis, pp. 193-226. London: Keegan Paul International.
- Winter, I. J. 1995. "Homer's Phoenicians: History, ethnography, or literary trope? A perspective on early orientalism," in *The Age of Homer: A Tribute to Emily Townsend Vermeule*. Edited by J. B. Carter and S. P. Morris, pp. 247-271. Austin: University of Texas Press.
- Wiwjorra, I. 1996. "German Archaeology and its relation to nationalism and racism," in *Nationalism and Archaeology in Europe*. Edited by M. Diaz-Andreu and T. C. Champion, pp. 164-188. London: University College London Press.
- Woolley, C. L. 1914. Hittite Burial Customs. *Liverpool Annals of Archaeology and Anthropology* 6:87-98.
- Woolley, C. L. 1914-1916. A North Syrian Cemetery of the Persian Period. *Liverpool Annals of Archaeology and Anthropology* 7:115-129.
- Woolley, C. L. 1921a. *Carchemish: Report on the Excavations at Jerablus on Behalf of the British Museum (conducted by C. L. Woolley, T. E. Lawrence and P. L. O. Guy); Part II - The Town Defences*. London: British Museum.
- Woolley, C. L. 1921b. La Phénicie et les peuples égyptiens. *Syria* 2:177-194.
- Woolley, C. L. 1927. Classification of the Pottery of Central and Northern Syria. *Classifications des Céramiques Antiques* 2:1-6.
- Woolley, C. L. 1934. The Prehistoric Pottery of Carchemish. *Iraq* 1:146-162.
- Woolley, C. L. 1937. Excavations near Antioch in 1936. *The Antiquaries Journal* 17:1-15.
- Woolley, C. L. 1938a. Excavations at Al Mina, Sueidia: The Archaeological Report. *Journal of Hellenic Studies* 58:1-30.
- Woolley, C. L. 1938b. Excavations at Al Mina, Sueidia II. *Journal of Hellenic Studies* 58:133-170.
- Woolley, C. L. 1939a. Excavations at Atchana-Alalakh, 1938. *The Antiquaries Journal* 19:1-37, 133-170.
- Woolley, C. L. 1939b. The Iron-Age Graves of Carchemish. *Liverpool Annals of Archaeology and Anthropology* 26:11-37.
- Woolley, C. L. 1948. The Date of al Mina. *Journal of Hellenic Studies* 68:148.
- Woolley, C. L. 1952. *Carchemish: Report on the Excavations at Jerablus on Behalf of the British Museum (conducted by D G Hogarth, R Campbell Thompson and Sir Leonard Woolley, with T E Lawrence, P L O Guy and H Reitlinger); Part III - The Excavations in the Inner Town*. London: Trustees of the British Museum.
- Woolley, C. L. 1955. *Alalakh: An Account of the Excavations at Tell Atchana in the Hatay, 1937-1949. Reports of the Research Committee of the Society of Antiquaries of London, 18*. London: The Society of Antiquaries.
- Wriedt Sørensen, L. 1997. "Travelling Pottery Connections Between Cyprus, the Levant, and the Greek World in the Iron Age," in *Res Maritimae. Cyprus and the Eastern Mediterranean from Prehistory to Late Antiquity. Proceedings of*

- the Second International Symposium 'Cities on the Sea', Nicosia, Cyprus, October 18-22, 1994.* Edited by S. Swiny, R. L. Hohlfelder, and H. Wylde Swiny, pp. 285-298. Atlanta, GA: Scholars Press.
- Wright, G. E. 1937. *The Pottery of Palestine From the Earliest Times to the End of the Early Bronze Age.* American Schools of Oriental Research Publications of the Jerusalem School I. New Haven: American Schools of Oriental Research.
- Wright, G. E. 1939. Iron: The Date of its Introduction into Common Use in Palestine. *American Journal of Archaeology* 43:458-463.
- Wright, G. E. 1950. The Discoveries at Megiddo 1935-39. *Biblical Archaeologist* 13:28-46.
- Wright, G. E. 1959. Philistine Coffins and Mercenaries. *Biblical Archaeologist* 22:54-67.
- Wright, G. E. 1961. "The Archaeology of Palestine," in *The Bible and the Ancient Near East. Essays in honor of William Foxwell Albright.* Edited by G. E. Wright, pp. 73-112. London: Routledge and Kegan Paul.
- Wright, G. R. H. 1966. A Method of Excavation Common in Palestine. *Zeitschrift des Deutschen Palästina-Vereins* 82:113-124.
- Wright, W. 1882. Kadesh on the Orontes. *Quarterly Statement: Palestine Exploration Fund* 1882:132.
- Wylie, M. A. 1982. "Epistemological Issues Raised by a Structuralist Archaeology," in *Symbolic and Structural Archaeology.* Edited by I. Hodder, pp. 39-46. Cambridge.
- Yadin, Y. 1960. New Light on Solomon's Megiddo. *Biblical Archaeologist* 23:62-68.
- Yadin, Y. 1966. *Masada. Herod's Fortress and the Zealot's Last Stand.* London: Weidenfeld & Nicolson.
- Yadin, Y. 1970. Megiddo of the Kings of Israel. *Biblical Archaeologist* 33:66-96.
- Yadin, Y. 1972. *Hazor. The Head of all these Kingdoms.* London: Oxford University Press.
- Yadin, Y. 1975. *Hazor: The Rediscovery of a Great Citadel of the Bible.* London: Weidenfeld and Nicolson.
- Yadin, Y., Y. Aharoni, R. Amiran, T. Dothan, I. Dunayevski, and J. Perrot. 1958. *Hazor I: An Account of the First Season of Excavations, 1955.* Jerusalem: Magnes Press Hebrew University
- Yadin, Y., Y. Aharoni, R. Amiran, T. Dothan, M. Dothan, and J. Perrot. 1961. *Hazor III-IV: An Account of the Third and Fourth Seasons of Excavation, 1957-1958 (Plates).* Jerusalem: Magnes Press Hebrew University of Jerusalem : Israel Exploration Society.
- Yadin, Y., Y. Aharoni, R. Amiran, T. Dothan, M. Dothan, and J. Perrot. 1989. *Hazor III-IV: An Account of the Third and Fourth Seasons of Excavation, 1957-1958 (Text).* Jerusalem: Magnes Press Hebrew University of Jerusalem : Israel Exploration Society.
- Yadin, Y., Y. Aharoni, R. Amiran, T. Dothan, I. Dunayevski, and J. Perrot. 1960. *Hazor II: An Account of the Second Season of Excavations, 1956.* Jerusalem: Magnes Press Hebrew University.
- Yadin, Y., and S. Geva. 1986. *Investigations at Beth Shean: The Early Iron Age Strata. Qedem 23.* Jerusalem: Hebrew University.
- Yahya, A. H. 2005. "Archaeology and Nationalism in the Holy Land," in *Archaeologies of the Middle East: Critical Perspectives, Blackwell Studies in*

- Global Archaeology*. Edited by S. Pollock and R. Bernbeck, pp. 66-77. Oxford: Blackwell Publishing.
- Yamada, S. 2000. *The Construction of the Assyrian Empire. A Historical Study of the Inscriptions of Shalmeneser III (859-824 B.C.) Relating to His Campaigns to the West. Culture & History of the Ancient Near East 3*. Leiden: Brill.
- Yasur-Landau, A. 2003. "The Absolute Chronology of the Late Helladic III C Period: A View from the Levant," in *LH III C Chronology and Synchronisms: Proceedings of the International Workshop held at the Austrian Academy of Sciences at Vienna, May 7th and 8th, 2001*. Edited by S. Deger-Jalkotzy and M. Zavadil, pp. 235-244. Wien: Österreichischen Akademie der Wissenschaften.
- Yasur-Landau, A. 2004. The Chronological Use of Imported Mycenaean Pottery in the Levant: Towards a Methodological Common Ground. *Ägypten und Levante* 14:339-346.
- Yener, K. A. 2000a. "Between the Tigris-Euphrates and the Mediterranean Sea: The Oriental Institute Amuq Valley Regional Projects, Turkey," in *Proceedings of the First International Congress on the Archaeology of the Ancient Near East, Rome, May 18-23, 1998. Volume II*. Edited by P. Matthiae, A. Enea, L. Peyronel, and F. Pinnock, pp. 1801-1812. Rome: Università degli Studi di Roma 'La Sapienza'.
- Yener, K. A. 2000b. *The Domestication of Metals. The Rise of Complex Metal Industries in Anatolia. Culture and History of the Ancient Near East 4*. Leiden: Brill.
- Yener, K. A. 2005. "Introduction," in *The Amuq Valley Regional Projects Volume 1: Surveys in the Plain of Antioch and Orontes Delta, Turkey, 1995-2002, Oriental Institute Publications 131*. Edited by K. A. Yener, pp. 1-23. Chicago: The Oriental Institute of the University of Chicago.
- Yener, K. A., C. Edens, T. P. Harrison, J. Verstraete, and T. J. Wilkinson. 2000a. The Amuq Valley Regional Projects 1995-1998. *American Journal of Archaeology* 104(2):163-220.
- Yener, K. A., C. Edens, J. Casana, B. Diebold, H. Ekstrom, M. Loyet, and R. Özbal. 2000b. Tell Kurdu Excavations 1999. *Anatolica* 26:31-117.
- Yogev, O. 1988-1989. Tel Yizre'el - October 1987-January 1988. *Excavations and Surveys in Israel* 7-8:191-195.
- Yon, M. 1987. "Les rhytons du sanctuaire," in *Ras Shamra-Ougarit 3. Le Centre de la Ville. 38e-44e campagnes 1978-1984*, pp. 343-350. Lyon: Editions Recherche sur les Civilisations.
- Yon, M. 1992. "The End of the Kingdom of Ugarit," in *The Crisis Years: The 12th Century B.C. From Beyond the Danube to the Tigris*. Edited by W. A. Ward and M. S. Joukowsky, pp. 111-122. Iowa: Kendall Hunt.
- Yon, M., and A. Caubet. 1990. Tell Kazel, Syria: Excavations of the AUB Museum, 1985-1987, Preliminary Reports: Appendix II Les Ceramiques Importees de l'Ouest. *Berytus* 38:98-118.
- Yon, M., V. Karageorghis, and N. Hirschfeld. 2000. *Céramiques Mycéniennes d'Ougarit. Ras Shamra-Ougarit 13*. Nicosia: Leventis Foundation.
- Zarins, J. 1978. The Camel in Ancient Arabia: A Further Note. *Antiquity* 52:44-46.
- Zarzeki-Peleg, A. 1997. Hazor, Jokneam and Megiddo in the 10th Century BCE. *Tel Aviv* 24:258-288.
- Zettler, R. L. 1996. "Written Documents as Excavated Artifacts and the Holistic Interpretation of the Mesopotamian Archaeological Record," in *The Study of*

- the Ancient Near East in the Twenty-First Century*. Edited by J. S. Cooper and G. M. Schwartz, pp. 81-101. Winona Lake, Indiana: Eisenbrauns.
- Zimhoni, O. 1992. The Iron Age Pottery from Tel Jezreel: An Interim Report. *Tel Aviv* 19:57-71.
- Zimhoni, O. 1997a. "The Iron Age Pottery from Tel Jezreel: An Interim Report," in *Studies in the Iron Age Pottery of Israel: Typological, Archaeological, and Chronological Aspects, Tel Aviv Occasional publications no. 2*, pp. 13-28. Tel Aviv: Tel Aviv University, Institute of Archaeology.
- Zimhoni, O. 1997b. "Clues from the Enclosure Fills: Pre-Omridd Settlement at Tel Jezreel," in *Studies in the Iron Age Pottery of Israel: Typological, Archaeological, and Chronological Aspects, Tel Aviv Occasional publications no. 2*, pp. 29-56. Tel Aviv: Tel Aviv University, Institute of Archaeology.
- Zimhoni, O. 1997c. Clues from the Enclosure Fills: Pre-Omridd Settlement at Tel Jezreel. *Tel Aviv* 24:83-109.
- Zuckerman, S. 2007a. Anatomy of a Destruction: Crisis Architecture, Termination Ritual and the Fall of Canaanite Hazor. *Journal of Mediterranean Archaeology* 20(1):3-32.
- Zuckerman, S. 2007b. "Dating the Destruction of Canaanite Hazor without Mycenaean Pottery?," in *The Synchronisation of Civilisations in the Eastern Mediterranean in the Second Millennium B.C. III*. Edited by M. Bietak and E. Czerny, pp. 621-627. Vienna: Verlag der Österreichischen Akademie der Wissenschaften.

#### **Internet resources**

- <http://www.pef.org.uk> (accessed 03/2006)
- <http://www.pef.org.uk/EarlySyriaPages/Carchemish.htm> (accessed 13/04/2007)
- <http://www.syriatourism.org> (accessed 10/08/2006)
- <http://www.uni-freiburg.de/aorient/aohome.html> (accessed 05/05/2006)
- <http://www.utoronto.ca/tap/2005.htm> (accessed 15/03/2007)
- [www.reshafim.org.il/ad/egypt/shoshenqi.htm](http://www.reshafim.org.il/ad/egypt/shoshenqi.htm) (accessed 04/04/2007)
- <http://www.qatna.org/en-index.html> (accessed 07/05/2006)
- <http://www.sidonexcavation.org> (accessed 16/03/2006)

