

MODELLING THE PROCESS OF READING :

A SOCIAL PSYCHOLOGICAL STUDY OF THE USE CHILDREN MAKE
OF FAIRY TALES

BY : JEFFREY ADAMS

DEPARTMENT OF PSYCHOLOGY
BRUNEL UNIVERSITY
UXBRIDGE, MIDDX.
ENGLAND

TABLE OF CONTENTS

INTRODUCTION AND OVERVIEW

| | Page | |
|-------|---------------------------|----|
| 0.0 | Introduction and Overview | 1 |
| 0.1 | Aims | 1 |
| 0.2 | Methods | 4 |
| 0.2.1 | Structuralism | 5 |
| 0.3 | Semiotics | 7 |
| 0.4 | Affect | 15 |
| 0.5 | Socialisation | 18 |
| 0.6 | The Research Practice | 19 |

TABLE OF CONTENTS

CHAPTER 1.0

| | Page |
|--|------|
| 1.0 Background to the Research Overview | 21 |
| 1.1 The Structure of the Stimulus | 21 |
| 1.2.0 Cognitive Psychology and the Linguistic Revolution | 24 |
| 1.3.0 The Semiological Analysis of Myths | 43 |
| 1.3.1 Phonology and Semiology | 44 |
| 1.3.2 Phonology and Myths : the Rationale | 50 |
| 1.3.3 The Analysis of Myths | 54 |
| 1.3.4 Critique of Levi-Strauss | 67 |

TABLE OF CONTENTS

CHAPTER 2.0

| | Page | |
|---------|---|-----|
| 2.0 | Fear, Security and the American Way : The Wizard of Oz and its Representation - Overview | 72 |
| 2.1 | Introduction | 72 |
| 2.1.2 | Myths and Fairy Tales | 73 |
| 2.1.3 | Bruno Bettelheim : Tales of Enchantment | 74 |
| 2.1.4 | Identification and Projection | 80 |
| 2.2. | The Text and Reading | 82 |
| 2.2.1 | General Methods | 82 |
| 2.2.2 | The Informant | 85 |
| 2.2.3 | The Text | 85 |
| 2.2.4 | The Text and Reading : Starting to Define the Process | 87 |
| 2.2.5 | Textual Analysis : A Beginning | 95 |
| 2.2.5.1 | Victoria's Reconstruction | 98 |
| 2.2.6 | Structure, Content and Context : The Representation | 101 |
| 2.2.7 | Discussion | 104 |
| 2.2.7.1 | In Linguistics | 104 |
| 2.2.7.2 | Affect | 108 |
| 2.2.7.3 | Reading | 108 |
| 2.2.7.4 | Primary Signifiers | 110 |
| 2.3 | Cognitive Theories of Emotion | 112 |
| 2.4 | Text Analysis | 118 |
| 2.4.1 | Vladmir Propp's Contribution | 118 |
| 2.4.1.2 | Greimas' Development of Propp's Structure | 121 |
| 2.4.2 | Case Grammar | 123 |
| 2.4.3 | Cases and Propositions | 123 |

| | Page | |
|---------|--|-----|
| 2.4.4 | The Work of the Proportional Representationalists (PR's) | 127 |
| 2.5 | Case Analysis of the Text of The Wizard of Oz | 136 |
| 2.5.1 | How to Read a Case-Gram | 136 |
| 2.5.2 | Conventions : The Verb and Its Adverb | 137 |
| 2.5.3 | The Cases : The Top Section of the Verb Circle | 140 |
| 2.5.3.1 | The Cases : Bottom Section of the Verb Circle | 141 |
| 2.6 | The High Order Stimulus : A Grammar of the Text | 146 |
| 2.6.1 | Grammatical Units : Transition | 146 |
| 2.6.2 | The Introduction | 150 |
| 2.6.3 | Results | 150 |
| 2.6.4 | The Episode | 152 |
| 2.6.5 | The Ending | 157 |
| 2.6.6 | Summary | 158 |
| 2.7 | Affectemes | 158 |
| 2.7.1 | Victoria's Version | 159 |
| 2.7.2 | The Version's Grammar | 159 |
| 2.7.3 | The Introduction | 160 |
| 2.7.4 | The Transitions | 162 |
| 2.7.5 | The Episodes | 162 |
| 2.7.6 | Ending | 163 |
| 2.7.7 | Results | 164 |
| 2.7.8 | The Illustrations | 164 |
| 2.8 | Discussion : Summary and Overview | 168 |
| 2.8.1 | In Linguistics | 169 |
| 2.8.2 | On Affect | 172 |
| 2.8.3 | On Reading | 173 |

TABLE OF CONTENTS

CHAPTER 3

| | Page | |
|---------|---|-----------|
| 3.0 | Overview | 178 |
| 3.1 | The Text and Informant | 179 |
| 3.1.2 | The Analysis of the Text : Introduction | 179 |
| 3.1.3 | A Description of the Vertical Dimension | 180 |
| 3.1.3.1 | Semiotics : the sign, message, code and signification | 188 |
| 3.1.3.2 | Connotation and Denotation | 193 |
| 3.1.3.3 | Constraints on Infinite Regression | 199 |
| 3.1.3.4 | Some Definition in Summary | 200 |
| 3.1.3.5 | Restatement of Process of Reading | 201 |
| 3.2 | B & B : The Text and Its Structure | 204 |
| 3.2.1 | The Lure | 204 |
| 3.2.2 | The Lesson | 239 |
| 3.3 | Melissa's Reconstruction | 265 |
| 3.3.1 | Melissa's Story | 268 |
| 3.4 | Discussion, Conclusion - Overview | 303 |
| 3.4.1 | On Reading | 303 |
| 3.4.2 | On the Text | 306 |
| 3.4.3 | Psychology & Semiotics | 306 |
| 3.4.4 | Method | 308 |
| | TABLES | 310 & 326 |
| | APPENDICES | |
| | REFERENCES | |

TABLE OF CONTENTS

Chapter 4

Summary of the Thesis and its Conclusions

| | | Page |
|--------|--|------|
| 4.0 | Overview | 310 |
| 4.1. | Re-statement of the Aims of the thesis | 310 |
| 4.2.0 | The Aims and the Text and the Reader | 313 |
| 4.2.1 | The Text | 313 |
| 4.2.2. | Reading and the Reader | 316 |
| 4.3.0 | The Thesis in Academic Perspective | 319 |
| 4.3.1 | Cognitive Psychology | 319 |
| 4.3.2 | Cognition plus Affect is Thought | 320 |
| 4.4.0 | Conclusion | 322 |

PREFACE

This thesis tries to answer the question "what does it mean to read?". I have tried to write it from the standpoint of how the work developed; the problems encountered and the solutions that were found form the stylistic theme.

Consequently, it is not a neat piece of work delineated into chapters on particular academic areas of the disciplines used, rather topics are discussed as they are relevant to the problems that I had to face.

If the thesis is about comprehension, then it is in itself a good example of the processes involved - it is as it were my 'reading' of the question mentioned above.

Although it is entirely my reading and responsibility, other readers have played important parts in its completion.

My supervisor, Patrick Humphreys, gave many hours of his time for discussion about vital ideas and questions of composition and I appreciate that very much.

My wife and son I thank for giving me the motivation to complete and Dr. Lucas for similar reasons.

0 .0 INTRODUCTION AND OVERVIEW

This chapter outlines the main concepts and methods that will be used in the thesis.

The first section sets out the aims and general problem that is being looked at. The second section deals with the methodological principles used. The third introduces the important discipline of Semiotics and describes how it relates to the goals of the research. The fourth and fifth sections are concerned with clarifying the concept of "affect" and its relationship to the concept of "socialization". The sixth section previews the plan of the thesis and offers a rationale for its design.

0.1 AIMS

The general aim of this work is to provide an answer to the question: "What does it mean to read?" The particular context is a child reading a favourite fairy tale. By reading I mean that process whereby an individual grasps a meaning from a text. The research can be placed in the area of a Cognitive Psychology that postulates an active subject with the ability to represent his or her social world; it also postulates a highly structured social world that is represented.

One aspect of this social world is literature and, as a consequence, this thesis is interested in the analysis of the structure of texts. Texts are considered to be "high ordered" stimuli the analysis of which is found, not in psychology (for I will show below that the analysis of the stimulus is relatively new), but Poetics; that branch of literary criticism that attempts to lay bare the conditions of meaning of a text.

Reading is conceived as a 'clash' of structures in which the subject brings to the text a representation of the social world that is both public and idiosyncratic. This representation is confronted by the structure of the text being read; the outcome of this confrontation is a particular 'reading' of the text, what will be called the reader's representation of the text (1).

In particular the thesis aims to show what happens when a child reads his or her favourite fairy tale. I am not interested here in adult interpretations of fairy tales, rather I want to show exactly what the child is faced with. It is a fundamental axiom of the thesis that any understanding of the representation of a particular text is only possible if the text is analysed in order to discover how a meaning is possible in the first place. Two constant questions will be: "what are the conditions of meaning in this text?" and "how have they structured the reader's reading?" This conditioning, however, is not unidirectional; the reader brings structures to the text which are conditioned by the needs of the reader. It is this dialectical relationship between structures that constitutes the subject matter of the research.

When this is put in terms of a child's growth, it is possible to see the socializing nature of reading. It is not the aim of the thesis to

(1) Representation is used here to distinguish between 'recall' and 'reconstruction'. Recall is associated with experimental work that attempts, for the most part, to measure various dependent variables such as retention of words. Representation means that the reader is presenting the text again after his or her involvement with it; reconstruction will be used to signify the reader's version of the original text whereas representation deals with the total reading.

show that fairy tales socialize for this would be a truism⁽²⁾ but rather to show exactly how the structured text effects the socializing; and, more critically, how a tale, which is the favourite story of a child, structures, for the child, particular emotions. So in the case of the child we have a certain need or lack being brought to the structured text and it is this interaction that will concern us.

Many current ideas about the activity of fairy tales come from a recent book by Bruno Bettelheim - "The Uses of Enchantment : the meaning and importance of fairy tales" (1978). The two most important that should be mentioned here are that fairy tales offer a solution to an emotional problem that a child has at a particular moment and that fairy tales are structured around affect. It is unclear though whether the solution is "in the text" or whether the solution is constructed by the reader from the text. This thesis argues that the conditions for a solution are offered by the text in the meanings or range of meanings that it allows. A child's favourite fairy tale is assumed here to be special just because it does offer meanings that enable the child to reduce uncertainty in its present emotional state. The text can only do it if it is structured around affect and if the child can identify with this structure. Having stated this we can see that the interaction of structures is going to result in the production of the child in meaning; the child is going to find words to interpret emotions and the meanings of these words will be public; they belong to certain codes that are acceptable to society.

(2) Although it must be pointed out that the opinion that these tales are simply 'a good read' is also prevalent.

But it is the phrase "the meanings of words" which will occupy a large part of the present work and it is to the general methodology used here that I want to turn my attention.

0.2 METHODS

Most research that concerns "meaning" in psychology refers back to Bartlett's Remembering (1932). The main reason for this is not only that it is an outstanding contribution to qualitative research in an era of obsessive quantification, but also that very little follow-up work has been done since 1932 on the recall of meaningful material and as a consequence Bartlett remains seminal in this type of research⁽³⁾. It seems evident that quantification and the methods (especially the bivariate experiment) helped to retard this type of work. (One must also consider the dominant schools of psychology that educated several generations of psychologists - Behaviourism and Individual Differences.) There are, however, certain key moments in psychology that support the type of research carried out in this project and section 1.0 is given over to this topic.

It is not only as a legitimization exercise that the historical review is necessary. Cognitive psychology erupted in the 1960's due in large part to the revolution started by Chomsky (1957) in American structural linguistics. I want to argue, however, that the revolution, while allowing psychologists to study cognition, left them centred around concepts such as the sentence and syntax that militated against

(3) The Jubilee Edition of the British Journal of Psychology in its editorial comments that it was during this time that the journal started to emphasize in its choice of articles experiments that were mostly concerned with statistics, see pages 1-2, Feb. 1979.

fruitful research into semantics⁽⁴⁾. This emphasis on syntax of the sentence is opposed here with an emphasis on the word, considered as a sign, and meaning, considered as the relationship among words within the language (and not simply within the sentence). It is the study of the structure of this language which constitutes the theoretical basis for the thesis.

0.2.1 Structuralism

A major aim of the thesis is to demonstrate what happens in the meeting of cognitive and social structures. In order to do this we must have a method by which we can analyse these structures. In particular, I am interested in the bond between reader and text, and to develop a general method which allows this to be understood.

Structuralism states that any activity, including reading and psychological research, functions first by decomposing the stimulus or object of perception according to some rule and then building a model or simulacrum, in effect recomposing another object that makes the first intelligible. The goal of all structuralist activity is to render the world intelligible and this is accomplished by the creation by the person of another object which "manifests the rules of functioning (the "functions")...." (Barthes 1972, p.149), of the original object.

As Barthes points out:

"between the two objects..... of structuralist activity, there occurs something new, and what is new is nothing less than the generally intelligible : the simulacrum is intellect added to object, and this addition has anthropological value, in that it is man himself, his history, his situation, his freedom.... (p.150)."

(4) The best example of this is Katz and Fodor (1963) where syntax is held to be primary to semantics, chapter one has a much fuller discussion of this.

The reflexivity of this method is extremely important to the present research. The reader of the fairy tale is active in the same manner as the researcher; both are creating other texts to render the original text intelligible. Hence, the investigation of the bond between reader and text is functionally equivalent to the bond between researcher and text and also to the bond between researcher and representation of the text by the subject (the child's simulacrum). It follows that there is no 'real' or 'definitive' reading of a text, and the aim of the activity is to investigate the internal coherence of the model presented.

The difference between the reader's model and that of the psychologist is related to the above statement by Barthes concerning man's history and situation; the child's simulacrum is the result of his or her situation and development and the particular needs brought to the original text and it rests upon the active identification with characters and situations within the text; the researcher's simulacrum is also the result of situation and history, but it is a situation and history based in the structuralist notion of science and his identification is with those who do this type of research. In this sense one can say that the structuralist has 'distanced' himself from the original object (and the child's simulacrum) but this does not imply an idea of objectivity in the sense of 'facts' discovered outside history and ideology and it is best to quote the structuralist, Umberto Eco, on the 'scientific' aspects of this type of research:

"In the human sciences one often finds an 'ideological fallacy' common to many scientific approaches which consists in believing that one's own approach is not ideological because it succeeds in being 'objective' and 'neutral'. For my own part, I share the same sceptical opinion that all enquiry is motivated. Theoretical research is a form of social practice. Everyone who wants to know something wants to know it in order to do something. If he claims that he wants to know it only in order 'to know' and not in order 'to do' it means he wants to know it in order to do nothing, which is in fact a surreptitious way of doing something i.e. leaving the world just as it is (or as his approach assumes it ought to be)." (Eco. 1976, p.29)

The thesis attempts to offer research which allows a 'motivated' intervention in Social Cognitive psychology generally. One of its aims is to change the way psychologists have been looking at not only cognitive structures but also stimulus structures and to do this, as was mentioned above, a different linguistic orientation will be introduced which allows structuralists' notions, about model, intelligibility, situation and history to be elaborated.

0.3 SEMIOTICS

The general method of structuralism results from ideas that were formulated by Ferdinand de Saussure whose lectures were collated by his students and published as, Course in General Linguistics (1974). As J. Culler points out in his introduction to the book, Saussure is part of a radical intellectual triumvirate with Freud and Durkheim which changed our way of looking at society. The essence of this change was simply that emphasis was removed from

the subject or person and placed in social systems; that the human was no longer the unique generator of ideas but rather 'culture', as it had been interiorised, determined action. As Culler says:

"It is as though they had asked : 'what makes individual experience possible, What enables men to perceive not just physical objects but objects with a meaning? What enables men to communicate and act meaningfully?' And the answer which they postulated was social institutions which, though formed by human activities, are the conditions of experience." (1974, p. xii)

For Saussure the institution that he was most interested in was language which he conceptualised as a system of signs, each of whose meaning stemmed from its position within the system. This system existed as '.... a well defined object' (p.14) whose structure it was the task of the linguist to uncover. Language (called langue) was distinguished from speech according to the following principles:

"In separating language (langue) from speaking (parole) we are at the same time separating : (1) what is social from what is individual; and (2) what is essential from what is accessory and more or less accidental." (p.14)

For Saussure, langue is a concrete object that has to be interiorised for speech to occur; the child must come to terms with the 'symbolic' or 'semiotic' function - the ability to represent himself and others - that the acquisition of language allows:

"it (langue) is the social side of speech, outside the individual who can never create nor modify it himself; it exists only by virtue of a sort of contract signed by members of a community. Moreover, the individual must always serve an apprenticeship in order to learn the functioning of language; a child assimilates it only gradually." (p.14).

The study of Langue is the 'proper' object for linguistics for it provides the possibility for communication; as soon as an act of speech is perceived as a communication, 'it is already part of the langue' (Barthes, 1970, p.16). The meaning of this is that to communicate is to combine signs in speech but that these signs are drawn from the system of signs, that social institution built on conventions called langue. Langue exists as a pattern over and above the individual and must be referred to if individual actualisations are to be understood. It is in this sense that the subject has been displaced. No longer is the subject 'the source' and even though he produces events, such speech acts, writings etc., he does so from within a system that is conventional and rule-bound⁽⁵⁾.

Of what does langue consist? Langue is a system of signs⁽⁶⁾. A sign is the result of a correlation between its expressive part (for Saussure the signifier) and its content (for Saussure the signified). This correlation was said to be arbitrary or unmotivated and, as has been pointed out by Culler (1976), it was Saussure's elaboration of this principle of arbitrariness that provides the logical basis for Langue.

(5) This is an important point. The thesis could be read as 'a search for the subject' and although I will argue for 'de-centring' the subject, we must at the same time remember Culler's cautionary statement in Structuralist Poetics (1975).

'But although structuralism may always seek the system behind the event... it cannot for all that dispense with the individual subject. He may no longer be the origin of meaning, but meaning must move through him.' (p.30)

The problem I have set is : what part does the individual, developing, historical subject play in this interaction?

(6) The signs 'system' and 'structure' are considered to be synonymous in this thesis. He who says system, says structure. The fundamental point is that the activity of uncovering langue from parole is that activity called Structuralism.

Take the sign 'cow' - its expressive part is the sound-image; its content part is the idea or concept cow; the relationship between these two terms is arbitrary. There is no intrinsic relationship; the concept could have had another expressive part. If there is no essential relationship, then the meaning of 'cow' must be the other signs around it - 'calf', 'pig' etc. and we see it is defined by its position; i.e. in its difference. 'Cow' is related to the concept 'cow' by convention, social agreement; to utter the sign 'cow' is to have interiorised this convention; to string together signs is to realise that meaning is constituted by difference - it is to have interiorised these differences. Moreover, because the relationship is arbitrary, there is no need for two people communicating to know the historical derivations of the signs that they are using in their utterances, it is enough to have interiorised the langue as it is at a particular moment to understand what is being said. From this follows the important distinction between synchronic and diachronic. It is possible, according to Saussure, to study langue in its synchronic aspects and, the thesis will argue, in order to study signification⁽⁷⁾ it is an essential aspect.

(7) 'Signification' is an important word in my terminology. Following Eco; processes of communication are permitted by an underlying system of significations. A code is a system of signification which exists, like langue, independently of the subject and is constituted on the basis of rules;

"when on the basis of an underlying rule, something actually presented to the perception of the addressee stands for something else, there is "signification"." (1977, p.18)

I will have more to say on 'codes' and 'systems of signification' in Chapter 3, but for the moment it is enough to insert here a tentative identification between langue/parole and system of signification/process of communication (see Barthes, 1977). This allows, as we shall see later, a much better elaboration of Saussure's ideas. It follows that any synchronic approach will have to come to terms with the current system of signification.

The development of these ideas Saussure foresaw in the following celebrated statement:

"A science that studies the life of signs in society is conceivable; it would be part of social psychology and consequently of general psychology; I shall call it semiology... Semiology would show what constitutes signs and what governs them... Linguistics is only a part of the general science of semiology; the laws discovered by semiology will be applicable to linguistics, and the latter will circumscribe a well-defined area within the mass of anthropological facts." (1974, p.16).

Linguistics then was to be the source of illumination for considering other social objects and actions as if they were signs. Linguistics was to be 'le patron général de toute sémiologie' which, through its unique constitution in arbitrariness, would give to other disciplines not only a method for analysing their particular objects, but also caution them from considering the relationship between signifier and signified (expression and content) as natural, essential and therefore not cultural. Once customs are meaningful they become like a linguistic system in that the social psychologist or social anthropologist can uncover the system of constitutive rules which are the conditions of meaning:

"the cultural meaning⁽⁸⁾ of any particular act or object is determined by a whole system of constitutive rules : rules which do not regulate behaviour so much as create the possibility of particular forms of behaviour". (Culler, 1976, p.5)

All this is based upon a single axiom : anything can have meaning. That is to say any event, physical or social-psychological, can

(8) The phrase 'cultural meaning' used by Culler seems somewhat redundant. One could ask 'what other meaning could there be?' The fact that it is used shows, I think, the difficulty that even one of the major writers in this field has in convincing readers of the meaningfulness of anything.

articulate a meaning - it can signify something to someone. But the necessary corollary is that this signification is always based upon a system of signification, that called langue above. The semiologist considers this system to be outside the subject, existing as an object of study, and even though, logically, it is only realised through communication (parole) the system exists 'as an autonomous semiotic construct that has an abstract mode of existence independent of any possible communicative act it makes possible'. (Eco. 1977, p.9)

At about the same time as Saussure was working, C.S. Peirce said:

"I am, as far as I know, a pioneer, or rather a backwoodsman, in the work of clearing and opening up of what I call semiotic, that is the doctrine of the essential nature and fundamental varieties of possible semiosis.... By semiosis I mean an action, an influence, which is, or involves, a cooperation of three subjects, such as a sign, its object, and its interpretant, this tri-relative influence not being resolvable into actions between pairs'. (in Eco. p.15)

In simple terms what Peirce is saying here is that the meaning of a word is other words. The meaning of a word is not the referent or the pair, sign-referent; these are always mediated by the interpretant which is another sign translating the explaining the first one. It follows from this that this translating and explaining could go on and on - we could have, in fact, a process of unlimited semiosis. The meaning of a word is the connections it has with other words. But we can ask a similar question of Peirce that Saussure attempted to answer through his notion of langue : "where in fact do these connections exist, in the mind of the addressee or in an autonomous semiotic construct?"

For Morris the answer seems to be quite clear:

"... something is a sign only because it is interpreted as a sign of something by some interpreter..... Semiotics, then, is not concerned with the study of particular kinds of objects, but with ordinary objects insofar (and only insofar) as they participate in semiosis." (Eco. 1977, p.16)

Semiosis is that action or cooperation of three terms which logically is a process of infinite regression. But for the semiotician Eco:

"The only modification that I would introduce into Morris's definition is that the interpretation by an interpreter, which would seem to characterise the sign, must be understood as the possible interpretation by a possible interpreter..... it suffices to say that the human addressee is the methodological (and not the empirical) guarantee of the existence of a signification." (p.16)

We come here face to face with one of the main 'problematics' of semiotics and the thesis - the dialectic between object and subject. As stated earlier, the conditioning is not unidirectional; text-to-subject. The subject's representation is considered here to be an intermediate entity between speech and language, a kind of idiolect which Martinent has called, quoted in Barthes (1977) "... the language inasmuch as it is spoken by a single individual", or according to Ebeling (in Barthes, 1977) "the whole set of habits of a single individual at a given moment" (p.21). This is an important notion as it allows the subject to creep back, if not into a central position, then certainly as more than 'a simple fold in our knowledge, ... who will disappear as soon as that knowledge has found a new form.' (Foucault, 1970). The thesis would like to re-introduce the subject as someone with a style; positing that the 'reading' of cultural artefacts is accomplished by individuals with style generating from the idiosyncratic struggling in the morass of socialised language or

systems of signification. In order for the child to enter into 'the symbolic' (at about 18 months) he must learn to use someone else's language; "private property in the sphere of language does not exist." (R. Jakobson in Barthes, 1977, p.21).

From a developmental perspective the interiorisation of systems of signification must be seen against the background of the child's situation and the needs that it brings to the influences around it. The subject chooses to say particular things at particular times and it is the understanding of that fact that should occupy a psychology of cognitive processing. The subject is not only (and undoubtedly) the medium through which meaning passes but also the transformer of meaning for his or her own purpose - to match his or her own needs..

Turning for the moment to American Structural Linguistics, it is clear that the distinction competence/performance is very much like that of langue/parole but it is also clear (and has been to psychologists for some time) that the conception of competence as one's knowledge of the language in terms of grammatical rules for producing correct sentences renders one totally unable to handle those problems within the psychologist's main area of concern; that of performance. The thesis will point out that cognitive psychologists have been hemmed in by their stress on the centrality of this notion 'grammar' which they inherited from the American Structural Linguists.

In addition, the methods traditionally adopted within cognitive psychology itself were not particularly helpful in analysing performance in the sense of 'style of representation' as outlined above. The goal of the thesis is to present another tradition (that of semiotics) which I will hope to show permits much more clarity when it comes to problematic notions of performance like need, choice, situation or context.

0.4 AFFECT

One of the major areas that cognitive psychologists⁽⁹⁾ seem to have ignored is the area of emotion or affect. It seems to me that any model of performance has come to terms with affect and its contribution to meaningful behaviour both as it is performed and as it is interpreted. Why has so little attention been paid to affect?

Theories of emotion exist outside cognitive psychology largely for historical reasons; emotional factors do not fit neatly into formulations that are embedded within a conceptual framework which directs researchers to experimenting with such notions as speed of inferences given more or less complicated syntactical sentence/paragraph construction.⁽¹⁰⁾ What would happen if the subjects of these experiments were presented with texts which were actually allowed to mean something to them?

(9) There are 'Cognitive theories of emotion' and they will appear later in the thesis. But the phrase 'Cognitive Psychologist' has been used so far as one who researches cognitive processing and with special emphasis on language. It is this group that I am referring to here.

(10) Examples of this quantification of representation are not hard to find : perhaps the two most influential are Kintch (1974) and Anderson (1976). See Section 2.4 for a thorough discussion of this work.

This is the question for which the thesis will try to find an answer. What is happening when a child reads his or her favourite fairy tale? The notion that the child is attached to the text in some way is extremely important here : reading is always reading for some purpose. The children who served as subjects in this thesis were not asked to read texts in order to investigate their syntactic structures, but because the text they chose to read fulfilled a certain need in their present situation. It is the articulation of their desire⁽¹¹⁾ in which I am interested and this must have some affect on their representation of the fairy tale.

I mentioned above (0.1) the idea that a tale offers the possibility of a solution to a problem is taken from Bettelheim (1978) who considers the child to be trapped in an 'inescapable cauldron of emotions' or 'inner conflict' which the child is unable to understand. Hence, the major function of the fairy tale is to externalise these confused feelings, '.....internal processes are externalised and become comprehensible as represented by the figures of the story and its events.' (p.25). The thesis will make the inference that in order for the tale to offer the possibility of the comprehension of inner emotional turmoil, the text itself must have a structure which allows this comprehension. In the language of 0.3 there must exist behind the text conditions of meaning : systems of signification. Furthermore, given the

(11) The notions of need and desire will occur throughout the thesis and they are based in the work of Lacan (1966) who postulates the idea that desires arise because of the impossibility of the child's demands (i.e. his use of language once he has entered into the 'symbolic') to fulfil his biological needs. Desire is a type of gap or lack that comes about with the acquisition of language.

affective nature of the reading, this system of signification must also be affective and hence the postulation that the text is structured around affect.

If Saussure is right when he states that the child must serve an apprenticeship in learning the Langue, then the reading of children's literature is one of the ways by which the child progresses to some sort of a qualification. It is a multifaceted qualification where the child interiorises not only possible solutions to inner conflict but along with this, and in fact because of this, the child interiorises ways of behaving that society approves. Put another way : the attachment that a child has to a story allows the text to put across cultural lessons.

In order to be able to conceptualise affect which actively structures the reader's emotions, the thesis must encompass a theory of emotion that proposes cognition as a determinant of the type of emotional behaviour that will be seen. Cognitive theories of emotion propose that emotion is ideational following work done by Schachter (1971) which showed that 'the cognitions arising from the immediate situation as interpreted by past experience provide the framework within which one understands and labels one's emotions'. (p.5). When we put this in terms of the child's 'apprenticeship' then we can see that any framework the child has must be a 'received' framework; that is to say one that has been introduced to the child by society.

0.5 SOCIALISATION

This brings me to a traditional area in both psychology and sociology; that of socialisation. From a developmental perspective the problem arises as to the nature of the relationship between the developing human subject and the objects of his or her cognition.

Traditionally, as M.P.M. Richards (1974) points out, the term socialisation has been associated with neo-behaviourism in that it is conceived as only a passive psychological process of learning and of training the individual. Against this tradition, Richards⁽¹²⁾ proposes a more active conception of the child's part in becoming a self-conscious member of society. In order to do this he proposes that: "we must also learn to see the world a little more from the child's point of view". (p.5)

The work that I am presenting here should be seen as a practical development of these ideas in that there is a dialectical interaction between the subject (reader) and object (text); there is no question of a simple filling up of an empty organism based upon 'universal' mechanisms of learning which reduce both the essence of cultural artefacts and the complexity of cognitive/affective development.

On the other hand, it must be said that developing subjects are produced as 'citizens' and this revised notion of socialisation must in some way account for this fact. It seems clear that one can no longer hold onto the idea that the human subject is a 'source' or is at the centre of his thoughts and feelings. Yet because of the process of development, indeed,

[12] There is, of course, another tradition, that of Piaget (1971), who proposes an active subject acting on his or her material world. Although the work here is also in this tradition it diverges from it in its emphasis of the role of affect in the developmental process.

because of change generally, there must be some intermediary term that links the developing subject to society's institutions. I propose to fill the gap left by the necessary de-centring of the subject with the idea of 'style', which I mentioned above. It is conceived of as a particular speech or performance that, although it is institutionalised ('there is no private property in the sphere of language'- R. Jakobson), it is 'not yet radically open to formalisation as the langue is'. (in Barthes, 1977, p.21). 'Style' is not simply a cry from some Cartesian past where the subject was the source, but a concept that tries to account for the transformation of systems of signification by the specific needs and context of the individual performer. It accounts for creativity, the particular style of a writer and, indeed, the movement of langue itself in its diachronic aspects. These seem to be undeniable facts and well within the scope of a dialectical interaction - that is the langue conditions but it is in turn conditioned.

0.6 THE RESEARCH PRACTICE

The child grows up in certain material contexts facing certain situations and solving problems that its being in the world throws up. One of the ways it handles these problems is to read fairy tales. The work reported below considers the activities of two eight year old girls from the standpoint of their favourite fairy tales. The rationale for such intensive research is that large-scale surveys in the field of social developmental psychology tell us, according to Richards (1974), 'nothing about process' (p.2). Above all, the thesis is concerned with

the process of reading and the system that underlies it. The intensive design allows the depth needed to model the process; correlations and percentages cannot help here even though data like these from extensive designs clarify where process analysis is possible and desirable.

The ideas for the model grew out of the research practice and it is my intention to follow these in the writing. The next chapter deals with the background to the research. Chapter 2 deals with textual analysis and an attempt at understanding a text and its reading is presented. Chapter 3 deals with a further analysis of a text and its reading. The final chapter tries to place the work of the thesis in relation to psychology and semiotics.

1.0 BACKGROUND TO THE RESEARCH - OVERVIEW

This chapter is split into two major sections.

It is my intention in the first section to organise some developments from the history of psychology relating to the thesis in two ways: In the first place my analysis will attempt to show that the present research has some, but muted, support. In the second place the work that has gone on in psychology that is related to the question of comprehension is contradictory in many places and I hope to show that the point of view that I have adopted in the thesis offers the possibility of solving some of the problems.

The second section examines the use of semiotics in the study of Myths. After an explanation and analysis of this work I will propose the use of these techniques as a fruitful starting point for the research.

1.1 THE STRUCTURE OF THE STIMULUS

The organisation of past research is carried out from the point of view of current problems and ideas. It is hoped that by doing this these ideas and problems will become clearer and more manageable. In this sense, the 'reading' of psychology's history that follows is not 'neutral' but is motivated by present concerns. The present concerns that will organise past research are the two major themes stated in the introduction :

- (i) the concept of the stimulus as structured and functioning, and
- (ii) the concept of the active 'grasping' nature of a structured consciousness.

The first idea, that of an effective stimulus, receives its most powerful support from the work of Gibson (1966). Specifically, it is his work on perceptual learning as a learning of the invariances in the stimulus pattern or structure that is relevant to the theme stated in (i) above.

Gibson attacks the notion of a stimulus as something that is 'punctate and instantaneous' by showing that even in the simplest situations a stimulus contains a structure with the following three characteristics:

- (i) a stimulus always has some degree of adjacent order : 'even the sharp stick on the skin or the narrow beam of light on the retina yields a border or transition, not a mathematical point'. (p.40). Gibson captured these notions in saying that the stimulus had form or pattern.
- (ii) a stimulus always has some successive order : 'it has some structure in time' (p.40). It has both a sequential structure as well as a simultaneous structure.
- (iii) 'consequently a stimulus always has some component of non-change and change'. (p.40). Change is part of the stimulus.

The value in this critique of the stimulus is that it allows for the possibility that the environment holds information about its structure in itself; and, furthermore, this information can be obtained by 'perceptual systems' or 'active senses'. This leads to the fundamental distinction between stimuli that are available and those that are effective which in turn depends on active perceptual systems that

obtain information from the environment. It is this concept of the interaction of structured environmental stimulation with an active perceptual system that Gibson says '... promises to be the clue to an understanding of how the perceptual systems work'. (p.33)

In order to be able to do this the organism has to be able to detect invariants within the stimulus information under conditions of changing sensation, a perceptual system, '...hunts for clarity' (p.271); perceptual learning is an increase of discernment where one learns what to attend to, distinguish features and detect variation. Each object or event in the world is specified by stimulus information which contains patterns of information that the perceptual systems detect and, therefore, discriminate objects in the environment as well as events:

"The child learns how things work as well as how they differ. He begins to perceive falling, rolling, colliding, breaking, pouring, tracing, and he ends by apprehending inertia, the lever, the train of gears, the chemical change, the electric current and perhaps the concept of energy. The cause-and-effect relation in these observations becomes increasingly subtle. The simple perception of motion..... gives way more and more to what we call inference. Nevertheless, there remains an element of perception in the appreciation of even the most abstract law. The physical scientist visualises atoms of particles; the savage or the child see spirits or magical rules behind a complex sequence of events....., but everyone perceives some kind of invariant over time and change. The information for the understanding of the law in such a case may be of a staggeringly high order, but it is theoretically open to observation." (p.286).

Gibson is really a structuralist in the sense described in 0.2.1.

From the perception of the simplest stimulus to those of a 'high order' what is operating is the detection of invariances that allow the

environment to be understood; the conditions of this understanding are to be found in the stimulus information. Perception thus is a 'structuralist activity' and it is this notion that what is important is not the superficial aspects of experience but, rather, what lies at a deeper level behind this experience that constitutes the structuralist position. Gibson makes this distinction by separating variant sensation from invariant perception; what reaches the receptors is variable and changing in the extreme what is perceived is constant, what I would call, intelligible⁽¹⁾. Furthermore, the conditions for this intelligibility are to be found in the stimulus structure or pattern.

1.2.0 COGNITIVE PSYCHOLOGY AND THE LINGUISTIC REVOLUTION

While Gibson was emphasising the structured nature of information in the environment, other workers were attempting to formulate ideas concerning the structured nature of consciousness or cognition.

The study of consciousness had been vetoed by J.B. Watson (1913) in the early part of the century and had continued to remain taboo until the late fifties and early sixties. The reasons for this are well known : the failure of the Introspectionist school to replicate their work and, indeed, even talk about it; the need to copy 'natural' sciences and, as a consequence, rely solely on positive data and the use of animals such

(1) Gibson quite rightly makes this the central concern of any theory of perception : he re-defines the field like this:

"The unanswered question of sense perception is how the observer, animal or human, can obtain constant perceptions in everyday life on the basis of these changing sensations. For the fact is that animals and men do perceive and respond to the permanent properties of the environment as well as to change in it." (p.3)

as rats and pigeons all militated against speculative notions about non-positive, unempirical, metaphysical phenomena such as mind, will, desire and thinking.

The generations of psychologists that were educated in this tradition produced work that was more or less a variation on Watsonian themes in that any reference to conscious or hidden processes was totally omitted or indicated by mathematical formulae such as Hull's (1943) theory of habit strength. What was needed was what Kuhn (1972) called a revolution. In psychology this revolution was heralded by Plans and the Structure of Behaviour, Miller et al (1960) which brought to psychologists' attention new ideas from various disciplines such as physiology, computer science, cybernetics and, most notably, linguistics; a field of enquiry that proved to be decisive because it was here that the dominant psychology that Plans was struggling against was most vulnerable.

The authors of Plans want to insist on what, in different intellectual conditions is an 'obvious' phenomenon; that is that the human has an Image of the world:

"The Image is all the accumulated, organised knowledge that the organism has about itself and world...it includes everything that the organism has learned - his values as well as his facts - organised by whatever concepts, images or relations he has been able to master." (p.17-18)

Together with the possibility of representing the world the human has, according to Miller et al, the ability to act on this representation - he can plan his actions in the future and these plans structure behaviour in the sense that they order the sequence of operations to be performed.

Psychology for the most part had been oblivious to the ideas put forward by Miller et al, and although the authors considered human representative processes to be 'obvious' they remained, in the intellectual climate of the times, 'hidden' simply because they could not be talked about.

The task of bringing these concepts within the scientific discourse fell to linguistics, a discipline that theoretically should have been able to effect the revolution mentioned above. However, linguistics itself in America had been dominated by Behaviouristic principles by the fact that they had been adopted by L. Bloomfield (1933), the person responsible for the establishment of linguistics as an autonomous discipline. The two most important ideas that motivated his research were:

- (i) only data that were observable and measurable were admissible, and
- (ii) responses had to be explained by external variables.

These two principles led to a standpoint on semantics that was to direct research to the more manageable area of syntax. As Lyons (1971) says:

"It was Bloomfield's view that the analysis of meaning was the 'weak point in the study of language'..... the reason for his pessimism lay in his conviction that a precise definition of the meaning of words presupposed a complete scientific description of the objects, states, processes etc., to which they refer (i.e. for which they are substitutes)."
(p.33)

Given his pessimism then the study of syntax came naturally to the foreground. There was, however, another reason that linguistics was to focus on syntax. There was an urgency to record and discover the

nature of moribund American Indian languages. This led linguistics to develop discovery procedures which were formal methods used by the linguist to describe these languages. They would allow the linguist a kind of 'objective observation' freed from theoretical prejudice. As Bloomfield (1933) said:

"In the stress of recording utterly strange forms of speech one soon learned that philosophical presuppositions were only a hindrance." (p.9)

Bloomfield's ideas met a partial antithesis with the publication of Chomsky's Syntactic Structures in 1957. The most important rejection was in the area of methodology into which 'presuppositions' were now admitted as part of the linguistic enterprise and the reliance on 'discovery procedures' discarded as not what happens in 'practice'.

Although Bloomfield's interest in syntax was kept, the important link between Chomsky's work and the 'new' psychology was this radical rethinking of what happens in practice, the common denominator being the rejection of Behaviourist methodological principles; something both disciplines had shared.

The effect of this on linguists was that they started to move away from an emphasis on rigid methodological procedures for describing languages from scratch. Linguists admitted that their actual method includes guesswork, imagination, reliance on past experience and, when considered from this perspective, formal procedures appeared artificial.

Given this admission of 'presuppositions' in the practical sphere, it

followed that they could now legitimately be used in the theoretical sphere and it was an extremely important point for both linguistics and psychology that their data could be accounted for by an underlying theoretical reality. For Chomsky this was a 'grammar' and he proposed that it was the task of the linguist to formulate grammars which could then be compared with one another so that their adequacy could be judged.

The rejection by Chomsky of Bloomfieldian theoretical and methodological principles set the conditions for the study of cognitive structures; images and plans share with grammar an underlying or hidden nature and, because of this, strict methodological procedures would be inadequate.

The relationship between grammar, images, plans and human representative processes generally (what I will call from now on cognitive structures) can be clarified by introducing the analogy of the computer which was vital for the development of this work. It is stated quite clearly by the authors of Plans that the notion of a plan itself is based upon the idea of a computer program. In the same way, the idea of a grammar as a system of rules that generates sentences is identical to the functioning of a computer program. In both cases it can be seen that what is 'underlying' about them is that they are 'inside' a computer and that they are also represented in a language. This analogy between computer structure, cognitive structure and grammar will be important below when it will be seen that certain problems arise when this way of thinking is applied to the specific problem of signification.

In any case, after 1957, it was possible to discuss cognitive structure

because of the historical point that the new linguistics owed its existence in part to its negation of Behaviouristic principles and, as a consequence, psychology was able to admit 'cognition' into its discourse through its association with Behaviouristic principles.

But this is only part of the story of how the new linguistics contributed to the new psychology. Chomsky tied his linguistic theories to psychology by emphasising the usefulness of them in accounting for human creativity and the child's acquisition of language.

With the introduction of the problem of the acquisition of language into this work, the important question about the processes of interiorisation and just what was interiorised could now be asked by Cognitive psychologists. For the linguist what was thought to be interiorised were the rules of the language; a speaker's competence was his knowledge of these rules or grammar. On the other hand, although 'interiorisation' could be posed, psychologists felt they had to investigate the individual's performance and its relationship to competence and other variables. They asked the question: 'is the speaker's performance based on the 'grammar' that the linguist proposes as a theory of the speaker's competence?' If the answer to this was 'yes' then the psychologist must take heed for the linguist was saying something important about a major part of human cognitive functioning. But if the answer was 'no' then the use of linguistics as a model of cognitive processes was questionable.

The linguistic answer to this has proved to be ambiguous. In one sense it is quite correct to say that the only task of the linguist, as redefined

by Chomsky in 1957, was to develop grammars that adequately described the data, like any scientist would develop a theory or model of his object. But then to call this competence is to introduce the subject (justified in terms of the child's acquisition of these rules) and all that that entails : motivation, emotion, situation and choice of utterance. The point is : can you separate performance factors like these from the competence to generate, as the linguists say, all sentences and no non-sentences of a natural language? In Aspects of the Theory of Syntax (1965), Chomsky, the linguist, says:

"When we say that a sentence has a certain derivation with respect to a particular generative grammar, we say nothing about how the speaker or hearer might proceed, in some practical or efficient way, to construct such a derivation."
(p.9)

With this statement we are a long way from any implications for cognition; speakers and hearers disappear and so does any context. For psychologists to take this statement and infer cognitive processes is to make, what has been called a 'creative misunderstanding'. But this is not a misunderstanding; it stems from a contradiction within generative grammar itself:

"(the aim of generative grammar is) to characterise in the most neutral possible terms the knowledge of the language that provides the basis for actual use of language by a speaker-hearer." (p.9)

The subject is re-introduced and once again underlying his performance is the linguists grammar and, in Chomsky (1968), the grammar at a more profound level is the innate capacity to acquire competence in a

natural language:

"Suppose that we assign to the mind, as an innate property, the general theory of language that we have called "universal grammar". This theory.....specifies a certain sub-system of rules that provides a skeletal structure for any language and a variety of conditions, formal and substantive, that any further elaboration of the grammar must meet. The theory of universal grammar, then, provides a schema to which any particular grammar must conform.....What faces the language learner is not the impossible task of inventing a highly abstract.....theory on the basis of degenerate data, but rather the much more manageable task of determining whether these data belong to one or another of a fairly restricted set of potential languages." (p.76)

The entire handling of the question of the human speaker in the work of Chomsky produces, not misunderstandings, but mediations to what are stated contradictions. These mediations can result in being someone else's contradictions and where these contradictions lie depends, as Eco (1977) says, on what one is using one's science for.

Contradictions start to arise when the theories that Chomsky offer come face to face with the specific problem of the meaning of a sentence to an individual.

1.2.1 Transformational Generative Grammar and Meaning

This section reviews briefly the theories of Chomsky as they relate to meaning. It will prove useful from time to time to apply the computer analogy in that it will clarify some of the problems that arise and make the whole project of Generative Grammar intelligible.

In 1957 the notion of a grammar was equated with syntactical rules. These rules generated grammatical sentences and at the same time provided structural descriptions of the sentences and thereby showed how the sentence was derived from the rules. Once the string had been generated then certain transformations were applied. For example, in order for sentences to be grammatical there has to be agreement between subject and verb - such a transformation is said to be obligatory. Transformations that produce negatives and questions from the original sentence produced by phrase structure rules (the first rules of the grammar) are said to be optional. The carrying out of obligatory transformations produces a set of sentences in the language which is called the kernel whose members are simple, active and affirmative. Now, as far as semantics is concerned, Chomsky accepts the notion that syntax is primary in the sense that the understanding of an utterance requires a previous analysis of the grammatical relationship between words in order to explain the meaning relationship between these words. This is illustrated in two ways:

In the first instance Chomsky shows that there are no one-to-one relationships between grammatical rules and semantic concepts. For example, in sentence (I)

(I) Charles got a pay rise.

The agent of the action is 'elsewhere' but the subject of the sentence is Charles and, therefore, there is no one-to-one relationship between

the case 'agent'⁽²⁾ and the grammatical unit, subject of a sentence. So grammar can be shown to be independent of semantic considerations.

The second illustration of a grammar's primacy comes in the handling of sentences that are ambiguous to native speakers, the most famous example being (II)

(II) The shooting of the hunters was awful.

This ambiguous sentence (are the hunters the object or subject of the sentence?) is only ambiguous at its surface level of articulation. Underlying it we can envisage two simple kernel strings : the hunters shoot or someone shoots the hunters. So it can be seen that two meanings can be obtained simply by postulating two different kernel strings that have undergone an optional transformation that results in sentence (II).

It is interesting now to ask : 'who does this?' In the pure sense Chomsky is talking about a machine that can generate grammatical sentences of a particular language using the grammar that he has devised. This is an obvious analogy to the program of a computer. But often the computer metaphor is reified and even before very strong cognitive claims were being made the idea of where all this is taking place - in the computer or in the mind - is unclear.

One of the reasons for this is that although it is easy to speak of syntax and computers, it is impossible to speak of meaning, even if it

(2) Case comes to play an important role in the thesis later on but for now it is worth pointing out that although this example is intended to show syntax's independence from semantics, it implies that syntax can tell us very little about semantics!

is tied down rigorously to syntax, without human processing. By this I mean that the meaning of a sentence is based outside a formal system of rules that could be implemented on a computer. The most important factors involved are such things as : context, the history of the person using or hearing sentences, a general knowledge word usage and social knowledge. Given this, it can be seen that sentence (II) can have a third meaning : for a person being against blood sports (history) the shooting of (perpetuated by) the hunters was awful (a terrible thing). Here we have the person interpreting the sentence using his past in many ways; he is using his knowledge of current social topics and importantly, feeling something about it. Not only this but the meaning that is presented is more like a 'gist' than a series of simple propositions. The very idea of simple, kernel sentences and the fact that they allow speakers and hearers to disambiguate surface sentences was facilitated by the computer. The notion of a gist on the other hand does not fit into the neat pattern of simple propositions.

Chomsky's next version (1965) tries to come to terms with the question of meaning but it will be seen that the problems of meaning that he tries to solve stem not from the above points but from questions asked in 1963 by Katz and Fodor which are equally limited by the computer metaphor. The main problem is that a sentence with one syntactic structure could have two meanings. For example,

(III) The bill is large

This is a pun that rests for its intelligibility, according to Katz

and Fodor, on the fact that a dictionary would give two meanings for the word 'bill'. An adequate model of a human's competence to disambiguate this sentence would have to include, the authors say, a lexicon or dictionary that lists the meanings of the word 'bill'. Two points can be made about this:

- (i) the idea that the meaning of a word is its dictionary listing has been contradicted by Wittgenstein when he points out that if one looks up a word with which one is already familiar then what we are doing is checking to see if the lexicographer has compiled the correct usage of the word. The point is that what Katz and Fodor are offering is a meaning abstracted from social usage.

The computer analogy, though, makes the Katz and Fodor proposal intelligible. The computer has, as one of its main functions, the ability to store items that can be looked up given the proper instructions. The problem comes when one realises that the computer, like the dictionary, needs to be filled up with words by a human, social agent.

- (ii) in practice, words are learned in a context and, therefore, mean something to the user. Although words have a public meaning (in terms of usage, not lexicons, they also have an idiosyncratic meaning.

The linguists' answer to this is that they are only dealing with 'ideal' competence; the psychologist's reply is simply that competence, as an abstraction, is meaningless, "...meanings are common social beliefs...rather than undated and theoretically fixed constructs." (Eco, 1977, p.99)

That Katz and Fodor make a mistake by restricting meaning to a lexicon listing the public meanings of words can be seen by looking again at sentence (III). 'Bill' may have two meanings but that does not exhaust the meanings of the utterance. Sentence (III) is also meaningful in the context of an example that confounds Chomsky's (1957) theory of transformational grammar and its treatment of semantics. The disregard of setting and history is a major failing in any theory that would attempt to account for an ability to understand. Katz and Fodor consider that it is impossible to include a speaker's or hearer's knowledge of the world and, if this is true, then any adequate theory of competence must be restricted in the way they indicate.

But this restriction has (according to Eco, 1977) the following consequence:

"Thus, the theory of the ideal competence of an ideal speaker, carefully defended against the disturbances of historical or social intercourse, has a good chance of being a perfect formal construct, but has very poor chances of being useful to anyone, not even a dictionary publisher, who is equally concerned with the continuous revision of his product." (p.99)

The 1965 version of Chomsky's theory incorporated the idea of a lexicon along with the primacy of syntax. The surface structure of sentences was generated by a syntactic component as was the deep structure of the sentence. The notion of kernel strings was retained as deep structure propositions which were fed into a semantic component. Kernel strings were said to represent the basic grammatical relations among the words and once this had been established then the semantic component interpreted the deep structure (an ambiguous sentence had two deep structure representations).

The lexicon, which was part of the syntactic component, contained, after Katz and Fodor, lexical features of words, called bundles of features. These features were all related to a syntactical semantics which tied meaning down to permissible relationships given the grammar; called selection restrictions. So example (IV)

(IV) John frightens sincerity

is an ungrammatical sentence because frightens occurs with an inanimate object. To prevent this one includes the lexicon, which is part of the syntactic component, features which would rule out the combination in the first place; in the above example 'frightens' has features such as the fact that it is a transitive verb taking objects which must be animate, its subjects are either abstract or animate; the context here is the sentence structure (deep structure). It is, therefore, easy to add to the lexicon the dictionary meanings of words and call them semantic features which would act in the same way by restricting certain uses of a word given the syntactical context of the other words.

There is the obvious similarity between the syntactic component and the computer's program. In the theory there are two programs : one generates the surface structure using rules that are called transformational and the other generates, simultaneously, deep structure strings which, because of their basicness, contain all the lexical information necessary for a semantic interpretation. The manifest output is the surface structure which, as we have seen in Transformational grammar, can be ambiguous and complex. It follows that, in order to understand a sentence, the surface has to be de-transformed into the existing deep strings.

On the more general question of innate cognitive capacity to learn a language this can be seen as well in terms of the computer, for any program has to be translated into machine language before the computer can operate on any data. It seems to me that machine language is analogous to those 'sub-system of rules' that Chomsky considers to be universal and only some of which are realised given the language 'niche' into which a person is born.

The analysis brings to light an important point about this whole enterprise : that it is a translation system from program to machine language and from surface to deep structures. Now, although the notion of translation could be a basis for understanding, it seems to me that its implication in Transformational grammar is to shift the problem from a more complex level (i.e. the surface level) to a more simple level (i.e. the deep structure) a type of reductionism. But, as Putnam (1971) has pointed out, reduction to a simpler, atomic level means that you stand a very good chance of missing what was graspable only on the more complex level⁽³⁾.

Empson (1965) has shown that, in poetry, one often finds a meaning being communicated by a grammatical construction which, if syntax were primary,

(3) This also recalls Vygotsky's (1962) maxim which says that one should not reduce past that level where you stand to lose meaningful elements:

"... which might be called analysis into units. By unit we mean a product of analysis which, unlike elements, retains all the basic properties of the whole and which cannot be further divided without losing them. Not the chemical composition of water but its molecules and their behaviour are the key to understanding the properties of water." (p.4)

should reveal an opposite meaning.

Examples abound of the human's capacity to ignore the uses and abuses of syntax. The newspaper headline is not very often a grammatical masterpiece yet it seems a very good way of allowing a meaning. Is it at all possible that, in this example, the reader is de-transforming a complicated surface structure to a grammatically simple and therefore univocal deep structure? The more likely answer is that the reader constructs a gist as opposed to translating from a level of complexity to one of atomic sentences. The assumption made by those working in "ambiguity" is that the receiver of ambiguity will disambiguate it. It never occurs to them that reception could result in yet more ambiguity.

A final example of the lack of anxiety about the result of ungrammaticalness is the ability people have to understand 'broken' English. Quite often meaning gets through given the most appalling syntax, where for example, expectations generated by a key word in context allow a meaning to be grasped. Faced with this, the linguist would claim that he is only dealing in ideal competence to disambiguate but, as I have tried to show, this makes his work irrelevant to an adequate theory of meaning.

Given all this, it can be seen that sentence (III) is much more complicated than its simple syntax would have us believe. It can have (at least) three meanings given context; in a restaurant, in a bird reserve, in a book as an example of linguistic theory. It can have (at least) three meanings given the roles of the humans involved in speaking and hearing the utterance; restaurant staff and customers; bird reserve staff and bird watchers; and teachers and students of semantic theory.

When utterances are considered in context and with regard to the human actors, the notion that what is happening is a syntactic translation and then a semantic interpretation is untenable. What seems more likely is that words are for various reasons selected and gists built up around them. As Empson (1965) says : "... one is much more prepared to be wrong about grammar than about the word." (p.239).

One could say that a certain irony marks the emergence of cognitive psychology. Using the ideas of Chomsky, it was able to shake off the shackles of Behaviourism that controlled both linguistics and psychology. But the very ideas that they borrowed forced them into seeing cognitive processes and structure as the grammar that the linguist proposes. When the important question of the meaning of sentences to people was raised, the psychological concepts of context - motivation and development - were submerged under the intricacies of passive affirmative transformations and the speed with which experimental subjects can carry them out.

It was not until 1972 that a very old idea in psychology, accredited to Wundt and probably much longer to common knowledge, was brought back by Bransford and Franks. This is the fact that understanding is in some way the constructing of a semantic whole which cuts across syntax or sentence boundaries. People exhibit an ability to derive representations in memory based on the relationships expressed rather than on particular lexical or syntactic features. What is stored in memory, according to Bransford and Franks (1972) is a semantic amalgamation of sentences, enriched by past structures, called 'Knowledge Enriched Structures'. They show in a series of experiments that the

more complex the syntax of a sentence the better the comprehension because complex syntax such as embedding of clauses provides an easily encodable semantic integration of ideas at the surface level. Transformational Grammar in its strong (and therefore relevant) form, would require difficult operations of de-transformation to get at the simple, deep structure propositions. A number of points can be made about the old idea of semantic integration as re-surfaces in Bransford and Franks.

In the first place their ideas are strongly reminiscent of Bartlett (1932). He also talks about integration in memory as an active process where past experience constructs the form of present comprehension:

"To speak as if what is accepted and given a place in mental life is always simply a question of what fits into already formed apperception systems is to miss the obvious point that the process of fitting is an active process, depending directly upon the preformed tendencies and bias which the subject brings to the task". (p.85) (my emphasis)

Secondly, Bartlett gives a name to the semantic whole : schemata, by which he means a non-static arrangement of relationships of meaning which actively construct or reconstruct in both receiving information from external stimuli and the retrieval of information from these schemata.

A third point that can be made is that the actual nature of these externally presented or surface structure semantic relations is missing from both works. In other words, both lack an adequate analysis of the semantic structure of the text; Bartlett's work is concerned with recall as a function of the person's schemata rather than the recall being a function of both an active structuring cognition and the stimulus. Similarly, in Bransford and Franks, the

reporting of gists as they cut across syntax is not linked together with an adequate notion of the structure of the meaning relations in the stimulus and, indeed, the whole question of how 'gists' are affected by semantic relations remains unanswered.

But this old idea of the semantic whole organises my present concerns very well. It shows that active cognitive processes are at work in comprehension but at the same time this is not the total picture for, as Gibson (1966) has demonstrated, the stimulus also has a function. It took forty years for the idea of a 'gist' and a subsequent need for an adequate way of looking at semantics to re-surface in psychology.

Transformational Grammar and the use that psychology made of it led to a shifting of the burden of explanation from the external world to the internal; from the traditional stimulus response ideas of psychologists to the hidden structure of Images and Plans. I have tried to show that two consequences followed.

In the first place cognitive structure and representational processes extend into the discourse of psychology and yet the work that followed was imprisoned by the once-liberating ideas of the linguists.

I also tried to show that the answers to the specific question of meaning that transformational grammar and psychology offered were inadequate and that it was only relatively recently that the old ideas of Bartlett and Wundt re-surfaced. These ideas confounded the syntactically based psycho-linguist and, at the same time, showed the need

for research into the structure of 'high-order' stimuli such as texts and stories which must play an important role in comprehension.

When this analysis of the historical trends is inserted back into the problematic of the thesis it is possible to see that the problems that exist can best be handled by the two themes with which I started the chapter. Psychology solved little by shifting the burden of explanation 'inside' and, on the other hand, very little was solved from a totally 'external' point of view. It must be seen rather as an interaction between both; an active cognition and an 'active' high-order stimulus.

The idea of two interacting structures, that of the text being read and that of the cognitive structure of the reader, necessarily involves trying to find an adequate way of talking about both.

As a necessary precursor to doing this, the next section considers a method of analysing high-order stimuli which, in the context of the thesis, are called texts and which is derived from a different type of linguistics from that discussed above.

1.3.0 THE SEMIOLOGICAL ANALYSIS OF MYTHS

The last section showed the need for a more thorough understanding of texts together with the need for a more adequate framework within which to conceptualise how these high-order stimuli are comprehended. The main point is that both the semantic structure of the text and its comprehension must be understood in a way that does not fall victim to that type of linguistics that puts syntax and the sentence into a primary place.

It is to the work of C. Levi-Strauss that I shall turn in this section of the chapter. This is because he has produced a textual analysis and a theory of reading derived from his analyses of myths which is theoretically and methodologically based in an alternative model of linguistics which, I hope to show, provides a much better starting point for answering the problems of the thesis than the type of linguistic analysis usually offered to cognitive psychology.

His model of linguistics is based upon Saussure's Course in General Linguistics (1974) and its development by succeeding linguists, notably Roman Jakobson (1978) into Semiology, the comprehensive study of signs in society. It was a fortunate occurrence for both Levi-Strauss and Jakobson that they found themselves to be teaching during the Second World War in New York at the Ecole Libre des hautes études, where Levi-Strauss attended Jakobson's lectures on 'Sound and Meaning' (1978). It was Jakobson's clear and concise explanation of what Levi-Strauss was to call the 'immense phonological revolution' that led the latter to consider mythic discourse as a special form of speech that was susceptible to the ideas elaborated by Jakobson.

1.3.1 Phonology and Semiology

The alternative model starts with Saussure's notion that there is a difference between the physical sound of a word and the linguistic function of this sound.

The first is studied by phonetics which attempts to study the production

of sounds by analysing the physical apparatus that allows the sounds to be made. The second is studied by phonology which deals with sounds as they function in a language, i.e. how they differentiate meanings.

According to Jakobson (1979):

"In order to be able to interpret and classify the diverse actions of our phonatory organs it is essential that we take into account the acoustic phenomena that these actions aim at producing, for we speak in order to be heard; and in order to be able to interpret, classify and define the diverse sounds of our language we must take into account the meaning which they carry, for it is in order to be understood that we seek to be heard." (p.25)

The unit of sound that distinguishes words as to meaning in a language is called the phoneme; it is in this sense that it is called functional.

If we take the word 'cat' we can represent its sound as k-a-t which has a different meaning to the words 'fat', 'sat', 'bat', thanks to the differences which exist in our language between the phonemes, /k/, /f/, /s/, /b/. Therefore, it can be seen that a phoneme's function is not somehow in-itself, for in-itself it is meaningless, but rather in its opposition to other phonemes-phonemic analysis is relational.

If one were to concentrate instead upon the 'sensation' of the sound then the relational and hence functional aspect of the phoneme would be lost. For example, a /b/ shouted at me from across a room and whispered in my ear sometime later remains a /b/. The reason for this, as Jakobson points out in Fundamentals of Language (1971), is that the phoneme itself is composed of distinctive features which are related to the means of producing the sounds by the vocal apparatus. A distinctive

feature is one term of a binary pair used in the production of a sound; so /b/ depends for its existence on the fact that it is produced without vibrating the vocal chords (it is non-vocalic) and by interrupting the flow of air for a short time (it is a plosive or stop as well).

Now in order for a child to learn its language it must pick up the invariances i.e. the distinctive features, which are in the stimulus information. This is the perceptual learning of Gibson (1966):

"...phonemes are transposable over pitch, loudness and duration and the stimulus information for detecting them is invariant under transformations of frequency, intensity and time. The perception of a phoneme is, therefore, not reducible to sensations of pitch, loudness and duration. Likewise, the relational stimulus for a phoneme is not analysable as magnitudes of frequency, amplitude and time." (p.93)

The acquisition of meaningful sounds is a process of detecting this invariant information that is, and this is important for linguistics, contained in the stimulus structure itself. As Gibson (1966) says, "phonemes are in the air" (p.94).

The question about whether phonemes exist in reality has dominated linguistics for a long time. Gibson's solution seems to be to be an elegant way out of the controversy. But in his New York lectures Jakobson (1978) argues within the context of linguistic history and debate rather than within the psychology of perception as does Gibson. What Jakobson is against is the notion that the phoneme's

existence relies for verification on the subjectivity of the receiver as he introspects. He says:

"It is true that we are much more consciously aware of those elements of a language which have an independent differentiating role than those which lack this function. But the primary fact is precisely this differentiating value of any particular element; conscious awareness of it is a consequence of this value. It is, therefore, logical to take as the analytical criterion this primary fact, i.e. the differentiating value of the elements to be analysed, rather than the secondary fact, i.e. our more or less conscious awareness of these elements." (p.38)

He goes on to argue that even if we were to take psychological introspection as a criterion, it remains very problematic because most linguistic performance is carried out without awareness. We say that a child can speak when he or she says something beyond syntax and morpheme which are in fact means to an end, i.e. to be understood.

The argument against conscious subjective criteria and for the autonomous linguistic object to be analysed is very important because it is the logical foundation for the important distinction that Saussure (1974) makes between langue and parole which is in turn the basis for the proposed "Study of Signs in Society" or "Semiology".

It is axiomatic to this enterprise that the langue exists over and above the individual as an object that is possible to study just as the possibility exists to study any other institutions in society.

What is important about the phoneme is its differentiating value; in a sense its negative value /k/ has a function in the langue because it is not /b/ etc.; yet /k/ has no meaning in itself only a differentiating function.

At this 'base level' of language (linguists call this the second articulation) Saussure's conception of the sign as the arbitrary relationship between two parts, the signifier (sound, expression) and the signified (concept, content) becomes more than 'intuitively' intelligible. For the signifier can now be seen as a concatenation of meaningless elements (phonemes) which, because they have no meaning must be arbitrarily related to a signified. But we have seen above how the sounds function in the language; so the meaning of a sign (the totality that results from the union of signifier and signified; its first articulation) must be its difference to other signs in the total system of signs simply because the sound's value is negative; positive values do not exist in the langue.

The meaning then of a sign is its place in the system of signs, the langue. Meaning is not, therefore, substantially anything; it is rather relational. One cannot speak of a single sign for it is only meaningful in the system.

So, although this tradition is based upon the sign rather than the sentence, it is really more precise to say that its foundation is the theory of the sign but its reality is the system of signs.

'Semiology' is a system of ideas in its own right and it is thus possible to enter into it at various points to understand it. For example, the notion that meaning is relational as opposed to substantial can be understood from the initial proposition that the relationship between sound and meaning is unmotivated or arbitrary. On the other hand, it has been possible to enter into the system on the other level of articulation, that of the phoneme, to see the systematic, relational nature of language.

It suits my purpose much better to explain the systematic nature of language in the 'microscopic' area of the phoneme because it is here that Levi-Strauss' analysis of myth, and my subsequent use of this work in the fairy tale, becomes important.

Before starting this, though, it is important to situate the study of myths in the practice of semiology generally. This is because Saussure's original separation of the sign leads to three distinct types of Semiological research, all of which will be referenced in the thesis. These are:

- (i) the study of the organisation of signifiers
- (ii) the study of the organisation of the signifieds
- (iii) the study of the process whereby signification is carried out.

Levi-Strauss' work falls into the first category. It concentrates on how the signifier cuts out or articulates the signified by the relationships entered into with other signifiers.

The second and third⁽⁴⁾ points will be discussed below in Chapter 3. First Section 1.2.2 considers how the lessons of phonology can be applied to the structural analysis of myths.

1.2.2 Phonology and Myths : The Rationale

As mentioned in the Introduction, the Saussurean concept of language and its extension to Semiology came at a time in the life of the Social Sciences when social institutions and customs were being conceived of as communicating meanings which conditioned the behaviour of society's members. For example, marriage and the events surrounding marriage constituted a phenomenon which was meaningful to individuals in the community. The alternative to seeing customs as systems that communicated ideas or held messages for people was to see behaviour as the result, for example, of individual actors acting in their own self interest.

We can now ask an important question : if society is to be conceived of as meaningful in all its manifestations from kinship relations, stories, myths and football games etc., then how do we understand these meanings, and what are the structures of the particular phenomena which communicate these meanings?

Levi-Strauss' answer to this question is to conceive of ethnographic data as semiotic systems. A semiotic system is any system

(4) It is worth pointing out here that this division creates tremendous problems in semiology. How can you study the signified, for example, without a signifier with which to communicate with about it or think about it? Conversely, the isolation of the signifier is from the start meaningless - the sound, in itself, has no meaning at all. It seems that the only alternative left is the third choice - the actual production of signs.

of conventions for communication i.e. any system that contains signs. Once the analogy is made between cultural phenomena and semiotic systems, in that they both have a communicative function, then the 'patron general' can be used as the guiding model i.e. language itself, the supreme semiotic system.

Levi-Strauss (in Jakobson 1978) put it this way when he realised the potential of Saussure's ideas in New York during the war:

"What I was to learn from structural linguistics was,.... that instead of losing one's way among the multitude of different terms, the important thing is to consider the simpler and more intelligible relations by which they are interconnected..... listening to Jakobson I discovered that 19th century and even early 20th century ethnology had been content, like the linguistics of the neo-grammarians, to substitute 'strictly casual questions for questions concerning means and ends'. They were content, without having even properly described a phenomenon, to go back to its origins. The two disciplines, therefore, found themselves confronted by 'a stunning multitude of variations' whereas explanation ought always to aim at the invariants behind all this variety." (p. XII)

It is useful to 'flesh out' some of the key phrases from the above quotation, which is a good summary of Levi-Strauss' position, because by doing so I will be able to introduce important terms of the semiological enterprise and, at the same time, be in a better position to explain and analyse its use in the structure of texts:

(i) by 'simple and more intelligible relations', he has in mind here the phoneme and its functional nature. But, as we will see, it is not only the theory of the phoneme that is useful in

organising a 'multitude of different terms' but also the type of relational quality that constitutes its action, i.e. its binary nature. In this he is supported by Saussure (1974):

"...there is room for a completely different science that uses combinations and sequences of phonemes as a point of departure... To give an account of what takes place within groups, there should be a science of sound that would treat articulatory movements like an algebraic equation: a binary combination implies a certain number of mechanical and acoustical elements that mutually condition each other.... combinatory phonology limits the possibilities and defines the constant relations of interdependent phonemes."
(pp. 50-I)

It is the binary nature of the phonological system that will serve his methodological principal in the study of myths.

(ii) by 'strictly casual questions', Levi-Strauss is referring to the tradition of linguistics that prevailed before Saussure. Like a lot of work in the 19th century, the question of the origin of phenomena was very important. The idea that the proper study of language was a historical exercise was current in both linguistics and ethnography. What Saussure does through the concept of 'properly described phenomena' is to introduce another fundamental opposition into linguistics that of synchronic/diachronic.

For Saussure, the possibility exists for two types of linguistics: one that studies a language as a system of signs, as it is at a particular moment, and the other which traces the succession of synchronic systems, which he termed the diachronic.

The synchronic idea is that a language as a total system is complete at every moment and it has nothing to do with what state the system was in at a particular point in its history.

Saussure's point is that at a particular moment, a word has a current single signified for a speaker. For example, my use of the word 'silly' today has nothing to do with the 16th century signified happy, blessed. So Saussure (1974) could say : "to the degree that something is meaningful it will be found to be synchronic." (p.5)

Now 'meaningful' here must be taken as part of a communication circuit for it is its status as an interpreter of messages that langue (the synchronic system of signs) becomes an object of study. In fact, as Fredric Jameson points out (1972), Saussure's idea was to break the circuit of discourse in an unusual place; not in the individual consciousness of interiorized linguistic forms and not the individual utterance:"this is the originality of Saussure, who separates the parole of the speaker from the langue of the person who understands him". (Jameson, 1972, p.26). There is here no tension between langue and parole, "langue is not a function of the speaker; it is a product that is passively assimilated by the individual". (Saussure, 1974, p.14).

This idea of the synchronic study of signs has for Levi-Strauss tremendous importance; the meaning of a myth is not its progression to a particular stage, rather it is its synchronic structure at the present.

(iii) the third key phrase from Levi-Strauss : 'invariants behind the variety' recalls once again the work of Gibson. The whole structuralist position can be summed up as the application of the linguistic model, especially those features of it that account for the surface data by underlying invariants; parole by langue, signifier by phoneme, and finally, at language's second level of articulation, phonemes themselves are considered to be bundles of distinctive features.

Phonemes belong to the langue - they are part of the social institution to which we must all conform if we wish to be understood. Also, the production of a phoneme itself involves actualised terms of binary oppositions : voiced as opposed to not voiced; a stop whose opposite term is a continuant; all phonemes are bundles of relations.

They are also, it should be clear by now, that invariance that Gibson, Jakobson and Levi-Strauss talk about as the very stuff of perception, language and mythology.

1.3.3 The Analysis of Myths

Levi-Strauss (1972) came to the body of work done by ethnographers on myths armed with structural linguistics and in great distress at the current explanations in the field:

"From a theoretical point of view, the situation remains the same as it was 50 years ago, namely, a picture of chaos. Myths are still widely interpreted in conflicting ways : ... whatever the hypothesis, the choice amounts to reducing mythology either to idle play or coarse speculation." (p.70)

The first point to be made about myths is that they are a form of speech. Using the linguistic model, myths falls into that category called parole. If this is the case then their comprehension must be through a langue.

Levi-Strauss (1972) points out that a peculiar fact about myths is that they are not just ordinary speech. What distinguishes myth from language is that the former is timeless. A myth survives as a myth to a hearer even through the worst translation; so although it is spoken in time:

"what gives myth an operative value is that the specific pattern described is everlasting; it explains the present and the past as well as the future." (p.173)

A myth has to be told (parole); to be understood it must be interpreted by the langue and yet to be felt it must refer to a third level; one where everything is explained. He says:

"Whatever our ignorance of the language and the culture of the people where it originated, a myth is still felt as a myth by any reader throughout the world." (p.174).

Levi-Strauss proceeds as follows to articulate the third level of myth:

(i) An element in a myth has no meaning in itself; the sorcerer, the jaguar, the snake, the hut, the wife etc. are meaningful as they are organised; just like signifiers they have no intrinsic meaning.

(ii) The Constituent Units of myths are not to be found in linguistic terms like phoneme and sign - this would be to forget that myths are a 'special' form of speech. He proposes to locate what he calls Gross Constituent Units (GCU's) on the level of the sentence.

(ii) The story is then broken down to the shortest possible sentences and these are placed on index cards, ordered to the diachrony of the story. But these GCU's, if the linguistic model is to be applied correctly, are themselves part of a bundle of relations, just as the phoneme itself is a bundle of relations. So GCU's can be arranged into a vertical dimension and, at the same time, they have an oppositive value, i.e. their relationship with other bundles.

This vertical/horizontal structure is also to be found in Saussure's (1974) paradigmatic/syntagmatic distinction :

"In the syntagm a term acquires its value only because it stands in opposition to everything that precedes or follows it, or to both. Outside discourse.... words acquire relations of a different kind. Those that have something in common are associated in memory resulting in groups marked by diverse relations.... From the associative and syntagmatic point of view a linguistic unit is like a fixed part of a building, for example, a column. On the one hand the column has a certain relation to the architrave that it supports; the arrangement of the two units in space suggests the syntagmatic relation. On the other hand, if the column is Doric, it suggests a mental comparison of this style with others (Ionic etc.)." (pp 123-4)

When this idea is transferred to mythology, the conclusion drawn is that the GCU's have two dimensions; the first is the vertical,

they can be grouped together as they are associated; in this case they are said to belong to the same paradigm. The second is horizontal, the columns are related to each other vis à vis other columns, they are part of a syntagm. So the columns are made up of GCU's and these columns are in a certain relationship with each other.

The analogy with the phoneme is quite explicit here. Levi-Strauss considers the columns to be like phonemes; they are made up of relations and receive their value from their opposite relationship to other columns. The column is now called a mytheme; in itself it is meaningless, but in its binary structure, by being what other mythemes are not, it is functional in the myth. Myth is, therefore, a concatenation of mythemes - just as the signifier is a concatenation of phonemes. Myth in fact is being treated as a sign, rather than a series of signs.

With this method the mythographer creates a new object, one that he hopes will render the original object intelligible. But, like all structuralist activity, the object that is created is that which underlies the surface phenomenon. This can be seen in the myth in that it is the progression of a story as told, it is a narrative and yet this is, in this analysis, only a means to an end. The goal is that of revealing the myth's synchronic structure which eventually accounts for the myth's intelligibility - understanding is here a synchronic process. Furthermore, even though the myth is told through and in time, because its underlying structure of intelligibility is synchronic, it negates time itself, and as Levi-Strauss says, myths are machines for the suppression of time.

Schematically Levi-Strauss considers the myth as parole to be represented by a series of numbers, say:

1,2,4,7,8,2,3,4,6,8,1,4,5,7,8,1,2,5,7,3,4,5,6,8,.,.,.,.

where each number is a gross constituent unit which will fit into a bundle like the distinctive features of the phoneme. The mythographer then recomposes the myth arranging the units paradigmatically and syntagmatically:

| | | | | | |
|---|---|---|---|---|---|
| 1 | 2 | 4 | 7 | 8 | |
| | 2 | 3 | 4 | 6 | 8 |
| 1 | | 4 | 5 | 7 | 8 |
| 1 | 2 | | 5 | 7 | |
| | | 3 | 4 | 5 | |
| | | | | 6 | 8 |

The numbers are the GCU's; the bundles of numbers, the columns, are mythemes, based not upon similarity, like a usual categorisation, but upon difference, their binary relations. His celebrated analysis of the Oedipus myth demonstrates the binary heuristic at work. By looking at it some idea of the purpose of mythical discourse will emerge and hence the function of the third level should become evident.

This story receives its first methodological decomposition and hence is organised as a set of sentences:

1. Kadmos seeks his sister Europa, ravished by Zeus
2. Kadmos kills the dragon
3. The Spartoi kill one another
4. Oedipus kills his father Laios
5. Oedipus kills the sphynx
6. Oedipus marries his mother Jokaste
7. Eteocles kills his brother Polynices
8. Antigone buries her brother, Polynices, despite prohibition.

Added to this is the fact that the surnames of Oedipus' father-line have "a remarkable connotation.....all names have a common feature : namely, they refer to difficulties to walk and behave straight." (Levi-Strauss, 1972, p.179). So using phonological principles, we can reconstruct the object as follows:

| I | II | III | IV |
|---------------------------|------------------------------|------------------------|-------------------------|
| (i) Kadmos-Europa | | (ii) Kadmos-Dragon | |
| | (iii) Spartoi | | (ix) Lame Labadacos |
| | (iv) Oedipus-Laios | (v) Oedipus- Sphynx | (x) Left-sided Laios |
| (vi) Oedipus-Jokaste | | | |
| | (vii) Eteocles- Polynices | | |
| (viii) Antigone-Polynices | | | |

Table 1.1 : The myth reconstructed

Levi-Strauss (1972) says that all the relations belonging to the same column 'exhibit one common feature' (p.178), but it would be a mistake to see in this a categorisation built around similarity or commonality for I gets its common feature just because it can be opposed to II, so we have in I the "Overrating of Blood Relationships". He then makes it quite clear that these so-called common features are the meanings of the columns - what we could call the signified; as it has been articulated.

When he comes to IV we see him take to task other ethnographers who look for the meaning of proper names in the context in which they are used. What they should do is look for their 'common feature' in the myth, not the sociological context. When this is done, the signified of IV is obvious as I mentioned above. But it might be appropriate here to ask : how does he know this?

"Here Levi-Strauss introjects a general proposition based on grand scale ethnography of the Frazerian kind : 'in mythology it is a universal characteristic of men born from the earth that at the moment they emerge from the depths they either cannot walk or they walk clumsily. This is the case of the chthonian beings in the Mythology of the Pueblo.... (Leach, 1970, p.64)."

The common feature here turns out to be the autochthonous origin of man which is, it will be noticed, a common feature at a higher level of abstraction than that given earlier, i.e. difficulty in walking or behaving straight. Why? This further abstraction is the only way to make sense out of the third column which has as a common feature the destruction of monsters who would try to

prevent people from living; these monsters are chthonian and their destruction, therefore, signifies the denial of the autochthonous origin of mankind.

So III is the denial of the autochthonous origin of mankind and IV is its affirmation. At a still higher level of abstraction III becomes a signifier of 'born of two, man and woman', while IV becomes a signifier of 'born of one, the earth'.

The myth in fact has its *raison d'être* right here between III & IV and the mediation of this contradiction constitutes the function of the myth because, as we are told, the Greeks who heard this myth faced a real contradiction in that they believed in the autochthonous origin of mankind yet at the same time were fully aware of the facts of life - that children are born from the union of two. The myth, like all myths, sets out to resolve this contradiction. How?

The first point to be made is that a real contradiction of this type cannot be solved; it can only be mediated by which I mean, contained. And this is done by a third term that holds both terms of the opposition.

In this myth this mediation is carried out by I and II because I is to II as III is to IV or:

"The Oedipus myth provides a logical tool which relates the original problem - born from one or born from two - to the derivative problem : born from different or born from the same. By a correlation of this type, the overrating of blood relations is to the underrating of blood relations as the attempt to escape autochony is to the impossibility to succeed in it. Although experience contradicts theory, social life verifies cosmology by its similarity of structure. Hence, cosmology is true." (Levi-Strauss, 1972, p.180).

IV is the converse of III just as II is the converse of I and what really matters is the abstract relation of these super mythemes to each other and it is here where the ultimate signified is found. It is quite clear that what is important is not the content or the substance of the myth but the relationships which hold among the mythemes, its form or structure.

But this analysis is of just one version of the myth. Levi-Strauss' goal is to relate this version to all other known versions of the myth such as, for example, the Freudian version which is, he claims, essentially about the same things; born of one (mother) or born of two, the presence in the child's life of two parents and the emotional contradictions that this throws up. Other versions would then be put into the original structure and some would be seen to fit and others would be seen to be related by transformations, such as inversion⁽⁵⁾. In this way a myth is all its versions constantly sending the same message only in different, transformed ways and the reasoning for this seems highly plausible : to ensure a message, the best way to go about it is to repeat it in as many different ways as possible : the well-known principle of redundancy.

(5) Levi-Strauss (1972) 'solves' an old problem in ethnology posed by a 'rogue' Winnebago myth which did not fit into a pattern set by three others. Other mythologists wanted to explain its divergence because of historical context; for example, the myth was generated in Winnebago history where the material and spiritual conditions were different. Levi-Strauss shows that by simply assuming that this myth is but an 'inversion' of the others, its place in the system of these other myths can be understood, in the sense that they belong to the same group and no previous material conditions need be brought into account for the fourth myth. Furthermore, by showing this he can point to a communality of meaning that they all share. It is in this way that the meaning of a myth is its versions.

When all the versions are collected, one has a three-dimensional matrix which can be read, top to bottom; left to right; and front to back until the myth ends up as a formal system of sub-systems.

The analysis of the Oedipus Myth has been used as the paradigmatic example for the structural analysis of myth. This is unfortunate in that the important notion of mediation is obscured. In the example the mediation is effected by the structure of the so-called mythemes which become a 'kind of logical tool'. In the same article, however, he provides a much better illustration of his important idea that the myth is a progression of mythic thought that starts with an unmediated contradiction and progresses to its mediation on an imaginary plane. In the example which follows, the neat columnarity seen in the analysis of the Oedipus Myth is confused. Here, the elements of the myth become mythemes with which the hearer thinks about the problem presented.

Take, for example, the apparently problematic role of the "Trickster" in Amerindian mythology. According to Levi-Strauss (1972) the trickster is always either a coyote or a raven:

"If we keep in mind that mythical thought always works from the awareness of oppositions towards their progressive mediation..... We need only assume that two opposite terms with no intermediary always tend to be replaced by two equivalent terms which allow a third one as mediator." (p.188)

In the Pueblo myths concerning life and death the basic problem is finding a mediation between 2 terms - the trickster, as coyote or raven, is the mytheme that mediates these two terms:

| Initial pair | 1st triad | 2nd triad |
|--------------|-------------|---|
| Life | Agriculture | Herbivorous animals Carrion-eating animals (coyote-raven) |
| | Hunt | |
| Death | War | Prey animals |

Table 1.2 : Schematic reconstruction of Pueblo Myth (from
Levi-Strauss, 1972)

The Pueblo share with the ancient Greeks the belief in the autochony of man. The highest form of life for the Pueblo is vegetal life - agriculture. Hunting is also a form of food gathering, yet it is also like war in that it contains death. From this triad a third is generated which is mediated by the coyote who is like both terms of the opposition, he eats carrion (like animals of prey) and, because he does not kill, is like the herbivorous animal.

According to Levi-Strauss (1972) then the coyote is a trickster because 'his position is half way between two polar terms (and) he must retain something of that duality, namely an ambiguous and

and equivocal character." (p.190).⁽⁶⁾ It is its function in the myth that allows the Pueblo to contemplate life and death.

The point seems to be that this animal, part of the Pueblo's daily life, is given over in the myth, not as an animal, but as someone who tricks, a deceiver. His meaning then is his function in the progressive mediation of other terms that are contradictory. It is his place in the system that gives him meaning not he himself. And although the contradiction is one of cosmic proportions, the Pueblo thinks them through with mythemes with which they are familiar in real life.

The opposition, of course, remains (Life/Death) and this is the reason that the myth is told and retold - a mediation is not a final solution.

As far as the psychological question of how a hearer receives a myth is concerned, Levi-Strauss produces a reductionist argument which is quite simple. We can accept the fact that in order to speak and understand the human must learn to distinguish phonemes by perceiving their binary structure. It is not too farfetched to assume that the reason we can do this is because of our brain. He has shown that his analyses of myths reveal an underlying invariant structure homologous to that of the phoneme and that, therefore, the comprehension of a myth is

(6) A variation in our times on this theme can be seen in the film 'The Roadrunner' where a herbivorous animal, the Roadrunner, is always being craftily pursued by a Coyote. The inversion that happens in the strip is that the coyote is a failed Trickster; more of a clown. It may be that vestiges of the Pueblo mythology remain, however, because it seems obvious that the coyote is never going to kill his prey and, of course, being a carrion-eating animal, this is as should be. The 'joke' in the strip is the coyote's elaborate and continual tricks to trap and kill the roadrunner and the fact that they always turn against him. The coyote is the container of both oppositions life and death even in the cartoon.

carried out by the same unconscious brain mechanisms that allow us to understand language. The difference between language and myth, the third level, is that myth, like music, plays ".....upon the physiological characters of the human brain to produce emotional as well as purely intellectual effects." (Leach, 1970, p.116) and, furthermore, it is these two cultural artefacts, myth and music, which will help us to understand the structure of the unconscious mind (which is the brain now) because they trigger off both natural (emotional) and intellectual effects, so, "....Myth and music thus appear as conductors of an orchestra of the which the listeners are the silent performers." (Leach, 1970, p.116).

It seems quite clear that the word 'listeners' quoted above does not mean human agents trying to make sense out of a particular myth rather the active subject has disappeared and two formal systems remain : the myth and the brain, or unconscious: (7)

"We do not pretend to demonstrate how men think in the myths but rather how these myths think themselves in men without them being aware of it." (in Culler, 1975, p.50) (my emphasis)

(7) This use of the unconscious is made because of Levi-Strauss' awareness of the Freudian principle of primary process thought. But unlike Freud's (1900) ideas of displacement and condensation, Levi-Strauss, true to his linguistic tradition, uses Jakobson's (1971) idea that language's two poles, metaphor and metonymy, are similar to Freud's processes of unconscious thought. Levi-Strauss' addition here is to infer that these two 'poles' or 'processes' are biological and must be the two dimensions of thought that are used in understanding.

These two poles of language become very important in the thesis in Chapter 3 where they receive a non-reductionist use.

Although there is some disagreement about the meaning of this statement (see Leach 1970) it seems clear to me that a thinking, interpretive subject is dissolved and the effect of the myth on the hearer is like Verdi on the ears - we reach another dimension where time itself is suppressed not because of the content, but because of its form and, he would want to argue, its binary form.

1.3.4 Critique of Levi-Strauss

What use is this analysis of the text to an understanding of stories and their effect on readers?

The problem with the analysis in general from the point of view of the subject is simply that he is not included at all. Instead, what is offered is a formal system of texts each related to the other without regard to sociological context or the material circumstances in which a particular hearer would receive the myth.

The justification for this comes from the postulation of a universal decoding mechanism inherent in the brain itself, which it turns out is derived from the method of analysis in the first place.

Although it seems justified to use the binary distinction as a method, the postulation of an 'ultimate' signified as some sort of human 'nature' or essence is only necessary when you have made up your mind to exclude the person (as constructed) in the first instance. "The goal of the human sciences is not to constitute man but to dissolve him." (Levi-Strauss, 1970, p.28). This dissolution is inherent as

well as in the model that is used. As I pointed out above, most linguistic activity goes on without awareness and, for Levi-Strauss, the important lesson of the Phonological revolution is the passage from the study of conscious phenomena to that of their 'unconscious infrastructure', i.e., the brain.

The point is that once the system is anchored in this way any talk of Semiology is misplaced. There seems to be no need either logically or empirically to exclude the subject by replacing him with this universal decoding facility. If a myth is felt to be a myth it is just as reasonable to assume that its structure and its themes are relevant to the listener, not because of its universality but because of its conventionality. When the ultimate signified is used to 'anchor' the sign then the semiological project, based as it is on the conventionality (arbitrariness) of the sign, is lost.

When we come to the analysis of the Oedipus myth it is easy to see some double standards at work. In the first place, Levi-Strauss (1972) uses a strict linguistic method; he organises his data paradigmatically and understands these paradigms in their syntagmatic relationships. But if we look at the fourth column, of Table 1.1 it becomes evident that the connotation of the name is not of a conventional, arbitrary nature but rather of a universal nature - when it suits him then the sphere of language can be left and that of an 'essentialism' can be brought in.

When the question of the meaning of the myth is posed it can be seen from the Oedipus example that its meaning is its form or structure;

that is the intersection of the two homologous pairs. The myth is about a contradiction between belief and experience but its meaning is the formal mediation of this contradiction. But this means that the ultimate meaning of myth is mythic thought itself and this is, as we have seen, based upon the biological fact of the binary structure of man's brain. This is a long way from the binary structure of phonemes and it must be said that a fruitful heuristic has been arbitrarily elevated to a principle on which through itself is based.

The radical formalism proposed is that the 'content' of a myth is its form or the structure it takes. All this follows by the removal of the subject from the process of the structure. This is the logical extension of the seeds planted by Saussure (1974); specifically, the insistence on the reality of the Langue over and above the individual and 'passively' assimilated by him. By doing this Levi-Strauss avoids the function of the context within which a myth is told and heard and, therefore, the need for an intermediate entity between parole and langue is not felt.

But this bypasses the point that language itself changes and, like other institutions, this is the result of human activity; it misses the point that, although conditioned by institutions, individuals also condition them.

This problem of the subject is avoided in the structural analysis of myths because Levi-Strauss starts with a heuristic and promotes it to a biological principle. The contradiction that results is that,

ironically, the linguistic/Semiological foundation, based as it is on the relational and arbitrary nature of signs, is lost by the fact that an intrinsic (i.e. biological) signified is admitted. By so doing we also lose, necessarily, the notion of the person being structured and structuring within the context of his or her culture's institutions.

If the above arguments are accepted, then the subject is no longer dissolved, as Levi-Strauss would like to believe, but rather readmitted as de-centred. While no longer the source, he or she is nevertheless a force in the structure of social institutions. Hence, by turning Levi-Strauss upside down, we can lose the biological anchorage and admit the subject. Once this is done, then we must consider the subject's development and context - his or her Social Psychology.

By keeping the idea that a myth is a semiotic system in a context that includes readers and hearers and by dropping the 'ultimate' signified I can begin my analysis of the fairy tale within the problematic of the thesis using the methods of Levi-Strauss without the theoretical extension that he makes. In this way I can start in the next chapter to develop a theory of reading which is free from the unnecessary constraint of a brain-based model.

FEAR, SECURITY AND THE AMERICAN WAY:

THE WIZARD OF OZ AND ITS RE-PRESENTATION

2.0 OVERVIEW

It is the general intention of this chapter to take up the ideas of previous chapters and develop them as the research itself developed. One fairy tale and its representation by a reader will be used, The Wizard of Oz : Dorothy Kills the Witch, from which I hope to trace and explain how the research grew in its practice.

The first section deals with the relationship between myth and fairy tale. This lays the foundation for the second section which discusses various aspects of the reading process the result of which is a preliminary textual analysis. The third section presents a theory of emotion which unites it with cognition in the light of certain consequences of the previous two sections. The fourth section concerns itself with two types of textual analyses the discussion of which leads to the fifth section which proposes another textual analysis which is a considerable improvement on the previous attempt. Sections 6 and 7 develop a 'text grammar' as it relates to the text under consideration. The last section discusses the results and implications of the work that is presented here and points to problems that the final part of the thesis will attempt to solve.

2.1 INTRODUCTION

It is a necessary illusion to believe that this thesis can be written as if it had a definitive point of origin based in some unique idea; in fact, there are no true beginnings, only certain types of discourse which seem to need a starting point.

This illusion exists not only in writing but in reading as well; there is a belief that the meaning of what is being read is simple and unique, that there is a definitive, original meaning in the text.

I will argue in this chapter that this is wrong and I will propose and try to show that a text communicates a set of meanings some of whose members are relevant to particular readers.

In what follows I want to show that the illusion of origins can take certain forms and that a careful consideration of them will prove fruitful to the thesis.

2.1.2 Myths and Fairy Tales

The illusion of 'originality' finds a concrete manifestation in Myths, whose central concern has been the creation of the world and man's place in it.

From Levi-Strauss' point of view a myth solves real contradictions on the imaginary plane. These contradictions being lived remain; their mediation, in terms of the story, is accomplished by the binary structuration of the things with which the culture thinks and ultimately by the biological endowment common to all humans. In the last chapter, this idea was turned upside down with a two-fold effect:

- (i) a universalistic model of man who transcends his context is removed and, as a consequence,
- (ii) this leaves the specificity of the content, its structure and the context in which it is heard as the three most important factors in understanding the text.

Fairy tales are a similar type of discourse. They deal also in a sort of 'originality'. They happen long ago, in a time before time and yet they are also relevant to the present. Fairy tales, like myths, persist even through translation and contemporary means of reproduction. Finally, they 'feel' like fairy tales just like a myth 'feels' like a myth. The question is : can one say that a fairy tale 'feels' like a fairy tale in the same way that a myth feels like a myth?

2.1.3 Bruno Bettelheim : Tales of Enchantment

In his book, The Uses of Enchantment : The Meaning and Importance of Fairy Tales (1978), Bettelheim proposes that fairy tales function by reducing the emotional conflict of a reader by providing a structure which exteriorises the reader's problem for him; furthermore, he proposes that not only are 'conflicting inner tendencies' given a tangible form by the tale, but that they also contribute to the solution of them.

The parallel with Levi-Strauss and the mediatory function of myths is quite close : what the fairy tale does is to offer, in some way, a solution to an emotional problem that a child is currently going through and it follows from this that a child will select that tale which does this for him or her. One could say that just as the myth is a 'progression of mythic thought' then the fairy tale is a progression of 'affective thought'; a concept which tries to capture the idea that the reader will be thinking through an emotional problem⁽¹⁾.

(1) One could ask here : what other kind of thought is there? I try to give an answer to this question in Section 2.3 where the traditional distinction between affect and cognition is analysed.

This emotional conflict results, according to Bettelheim, from particular 'existential predicaments' that face the child and so the affective or emotional contradictions that arise because of the child's particular situation are given, by the chosen text, another venue : they take place in another place.

But Bettelheim (1978) seems to say two different things about its status:

- (i) it is the place where the child finds his or her own solutions, 'through contemplating what the story seems to imply about him and his inner conflict at this moment in his life (p.25), and yet
- (ii) he also suggests that the fairy tale gives the solution as if it were a 'key' to understanding about where the reader is at a particular moment in his or her life; for example, 'the figures and events of fairy tales suggest ever so subtly how these conflicts may be solved.' (p.26)

In the first case we are talking about an active reader and in the second a 'gift' seems to be passively accepted by the reader. The contradiction is slight but real and, although these two ideas are often kept separate in his book, it is clear from the following quote that Bettelheim recognises that they cannot be kept separate when the full function of the fairy tale is considered:

"...the fairy tale is suggestive; its messages may imply solutions, but never spells them out. Fairy Tales leave to the child's fantasising whether and how to apply to himself what the story reveals about himself and human nature." (p.45)

This oscillation between the separation and union of these ideas has certain implication for the general problematic of the research : on the one hand there is a child developing in a context which presents situations that result in affective contradictions but it also presents fairy tales which are structured in such a way that it allows the child to use them for his or her own purposes. In the terminology of Chapter 1 : the stimulus, called the text, is structured; the subject, called the reader, structures or re-constructs the stimulus within the demands of his or her situation. But the third term that follows from this is not explicit in Bettelheim; this is that the stimulus also structures. The solution actively found by the reader in the text is actually conditioned by the text, i.e. it is not totally a question of the fairy tale '[leaving]' to the child's fantasising etc. but partly a question of an active tale conditioning the fantasising. That this is minimalised in Bettelheim can be seen from the following quotation:

"The paramount important of Fairy Tales for the growing individual resides in something other than teachings about correct ways of behaving in this world.... fairy tales do not pretend to describe the world as it is, nor do they advise what one ought to do." (p.25)

The contradiction here is that, although they can help the child caught in 'a cauldron of emotions' they do not refer to the world that has caused this affective state. How is it possible to hold this?

In Bettelheim one is seeing the same results that were apparent in Levi-Strauss for what he does is to abstract the affective foundation from the context and call it 'human nature'. Emotions are

here 'naturalised' and a consequence is that the fairy tale necessarily has to operate on a level that is universal:

".... the content of the chosen tale usually has nothing to do with the reader's external life, but much to do with his inner problems, which seem incomprehensible and hence unsolvable." (p.25)

There is no reason why anything should be tagged as universal unless it has been accepted a priori that this is the case or, which is more probable, the discourse within which one works forces a postulation of origination; for Levi-Strauss this is a brain-based origin and, for Bettelheim, the psychoanalyst, an 'ultimate repression' which, it turns out, is equally biological. Both are trapped in the illusion of origins.

It follows from this that, if one accepts the biological foundations of emotional of emotional turmoil (i.e. human nature) combined with psychoanalytic meta-theory then one has a powerful hermeneutic. Thus, Bettelheim's interpretations of particular fairy tales are definitive given the frame of reference he brings to the text.

But in terms of the thesis it seems more important to ask : is this what the child brings to the text? and similarly, is the child faced with Bettelheim's account of what is going on in the story? What, in fact, is the child faced with? If it is not assumed that a story is based or anchored in any theory, be it libido or binary brain structures, then it can be taken for what it appears to be : a narrative system of

signs which is relevant to a particular child at a particular time in his or her psycho-social development. The question can be formulated as : why is this text, called text 1, the child's favourite and, furthermore, how can this be demonstrated?

Figure 2.1 depicts the basic problem:

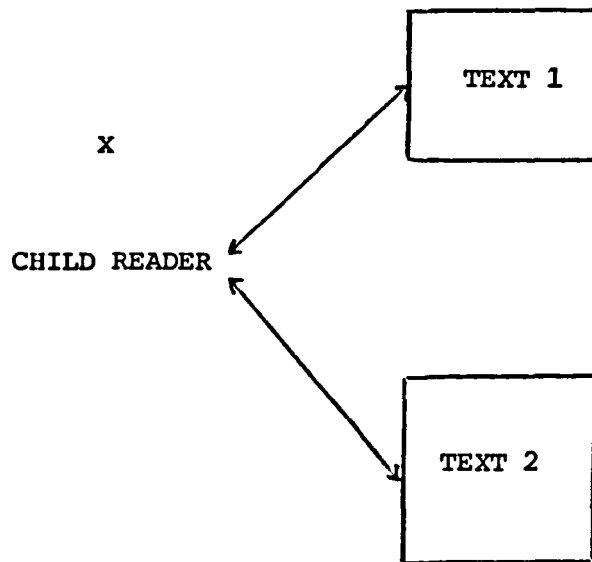

Figure 2.1 : The Basic Problem

Where Text 1 is the child's favourite; Text 2 is the reader's reconstruction of Text 1 and X is the situation of the reader, his or her 'meaningful world'.

What follows from Figure 2.1 is:

- (i) our knowledge of what the child 'gets' from Text 1 must be seen, partly, in its relationship to Text 2; the significance of a text is other texts.

- (ii) X is relevant to both texts.
- (iii) text 2 is a function of; the reader; text 1, X and, so,
- (iv) variation in text 2 vis a vis text 1 will be a function of the reader, X and text 1.

Two questions immediately arise : of what is text 1 a function? And: of what is the reader a function? The answer is that they both have as their functions 'affect'. By twisting Bettelheim's grounding away from the biological basis, what results is that affect is now relevant to the child's context and ways of behaving. By 'naturalising' affect it was possible to ignore the content of the story and the particular external life of the reader. By 'de-naturalising' it we come face to face with its relevance for a particular child. So, the affective structure of the story is relevant to the affective structure of the child and, moreover, the actual 'content' is as important as the form it takes.

In the same way, the hearer or reader of a myth 'understands' the story not only because of its form but also because of the relevance of its content to his context. This is the necessary conclusion once we remove the anchor with which Levi-Strauss stabilised his theory. Mythic thought, as it progresses through the narrative, presents mediations of contradictions that are now 'socially' meaningful to someone. In the same way affective thought, as it progresses through its narration, presents mediations that are socially meaningful to someone.

The conclusion is that the fairy tale has a necessary emotional (affective) structure. This structure progresses to a resolution and it is the ability of this organised affect to structure a particular reading that must concern any adequate model of the fairy tale; that is, text 1 has, as part of its structure, an affective component whose organisation plays an active role in a reading.

2.1.4 Identification and Projection (2)

If this is the case for text 1 then it is a reasonable question to ask : how does the child contact this structure to be affected by it?

Bettelheim (1978) points out that fairy tales are marked by the fact that the characters in them are, usually, unnamed. This is no accident. In his section on the comparison of myths and fairy tales, he shows that the function of namelessness in the fairy tale is part of their ability to 'subtly suggest solutions to inner conflict' by allowing the reader into the story via the mechanisms of identification and projection.

By presenting the child with 'generic' characters the tale does not run the risk of isolating the reader's emotional tie:

(2) The term 'projective identification' could be used here meaning an attribution to the other person or that person's situation of certain traits of the self, or even an overall resemblance of one's self but it has been too closely associated with Klein's use of the term which emphasises its importance as 'a particular form of identification which establishes the prototype of an aggressive object-relation.' (Laplanche, J. and Pontalis, J.-B., 1973, p.356)

"Even when the hero is given a name, as in the Jack stories, or in 'Hansel and Gretel', the use of very common names makes them generic terms, standing for any boy or girl." (p.40)

Mythical heroes, he points out, are named and, being named, are felt by the reader to be alien to them. Their literary function is to maintain the myth on epic and heroic dimensions - something no child could identify with or project his emotions into; the point is that naming is a device that permits superhuman action that is carried out by an impossible other. The use of 'boy' or 'girl', however, is a device that permits 'ordinary' problems to be presented and worked out by anyone.

The general proposition seems correct; that is that one of the devices that allows the fairy tale genre to exist is the generic naming. 'Girl' could be the reader and this depends on the character's place in the story and that story's relevance to the reader. Identification and projection are considered to be axioms underpinning the active nature of reading. From my point of view, however, projection and identification do not take place with just 'any' girl character in any story, but with that girl character who has specific attributes in a situation whose structure and content are relevant to the reader.

In summary, what remains after removing the 'origins' of both myths and fairy tales is a need for a textual analysis that incorporates as necessary factors structure, content and context. Next, it seems clear that the story must be considered for what it is : a narrative

system of signs which we believe to be affectively structured and 'accessible'. With these points in mind, the next section attempts to use the linguistic methods of Levi-Strauss as a first attempt at a textual analysis.

2.2 THE TEXT AND READING

In order to keep the heuristic as such and not a statement about the nature of the brain it is best to keep Jameson's (1972) description of it in mind:

"We would ourselves be tempted to describe it [the binary opposition] as a technique for stimulating perception when faced with a mass of apparently homogenous data to which the mind and eyes are numb : a way of forcing ourselves to perceive difference and identity in a wholly new language the very sounds of which we cannot yet distinguish from each other. It is a decoding or deciphering device, or alternatively, a technique of language learning." (p.113)

In addition, this heuristic must be seen in context and Section 2 will try to show how this can be achieved. If Figure 2.1 is considered to be a basic paradigm of the problem that confronts the thesis at this stage, then an elaboration of its terms will provide some ideas on how to begin.

2.2.1 General Methods

Traditionally the object of psychological research has been termed the subject. Because much of the present research gets its impetus from ethnology I shall adopt the term 'informant' for the child reader. This word has a constellation of associations around it

that provides a way into the general methodology. 'Informant' means, for example, that the researcher listens to what the child says. The data, therefore, come out of the interaction with the child and is (mostly) verbal.

The second implication of calling the subject an informant is that the interactional nature of the research means that the researcher must necessarily become part of the situation, so we have:

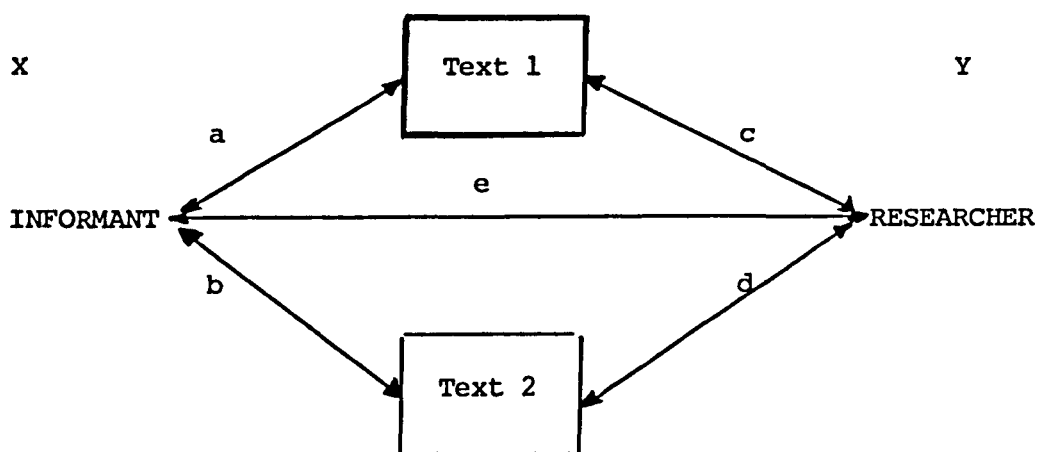

Figure 2.2: Implications of Adding the Researcher to Figure 2.1

From Figure 2.2 it can be seen that vectors c, e and d are added to complicate the situation of Figure 2.1. Also, a new set of conditions that have a meaning for the researcher are introduced, i.e. Y. It would be a delusion to pretend that the interaction of X and Y was not significant - few informants would be totally accepting of the introjection of a stranger into their world and literature.

Vector c is based upon the linguistic model mentioned above. Vector d represents the same heuristic applied to the informant's version of text 1. This means that text 2 is not a 'recall' in the sense that the informant is being measured for memory capacity in terms of speed or accuracy ⁽³⁾; rather, text 2 is treated as another story which is a version of the first text, in the same way that a myth has versions. Both c and d presuppose the existence of a theory and practice of story analysis.

Vector e is the channel of communication that carries the burden of messages designed to 'elicit' text 2. It is also in a very intangible sense the pathway through which the child feels reassured enough to want to talk to you. This sounds very messy but, when it is admitted that the traditional subject of psychological experiments is is subject, then one is imprisoned by 'inter-subjectivity'. But it is only by operating within this prison that fruitful research will be carried out; by not admitting the closure of inter-subjectivity and by basing one's theory and methods in 'origins' the freedom gained will be illusory.

If this is taken into consideration, Figure 2.2 generates another methodological prerequisite. This is that text 2 is embedded in X along with the informant and text 1; but now the value of inter-subjectivity becomes apparent simply because the researcher is also embedded in X and, using e, can now access those conditions within

(3) These types of studies are important in cognitive psychology in that traditional variables like speed and accuracy are tied to semantic memory models. As such they are also important for the thesis and I discuss them in Section 2.4.3.

which the child lives and which have meaning for her. In order to find out about this larger 'text' (the context) it can be seen that the use of vector e is extremely important. It cannot be used for the passage of a rigid schedule of questions; rather the schedule is derived 'in situ' from listening to the informant. All this is, of course, complicated even more by 'Y' which also demands a great deal of flexibility on the part of the researcher.

2.2.2 The Informant

The first informant is a 7½ year old girl, named Victoria, whose favourite fairy tale is, The Wizard of Oz : Dorothy Kills the Witch, (from now on The Wizard). It will be recalled that it is assumed that the favourite tale is the momentarily relevant one to the child. The reality of actually finding out which story it is is complicated. Victoria in fact has several books that she considers important to her. After an initial hesitation about talking about her literature she produces several 'favourite' books but it soon becomes clear that only one book is her favourite at this time.

2.2.3 The Text

The story is printed in an anthology of 'classic' fairy tales (see Appendix A) and it runs briefly like this:

A young girl, named Dorothy, is transported with her Dog, Toto, to a magic land called Oz. Her house lands on the wicked witch of the East and she is met by the good witch of the North who thanks her

for killing the wicked witch. Dorothy acts surprised at the death and says she wants to go home. She gets the silver shoes from the dead witch and a protective kiss from the good witch in order to find her way to the Emerald City to find the Wizard of Oz who has all the answers; the road is said to be very dangerous. She meets three people along the way. A lion who needs courage; a woodman made of tin who needs a heart to feel like other people; and a scarecrow who needs brains to think. They join up with D to find the Wizard and to afford protection on the way. The Wizard refuses their requests until they have killed the Wicked Witch of the West. After an initial disappointment, they resolve to do this to get their wishes granted. They meet strong and very brutal opposition from the Witch of the West. She tries several methods of destroying the intruders. First of all she calls up her wolves but the woodman axes their heads off. Second she calls up her crows but the scarecrow snaps their necks. Thirds she calls up her black bees who break their stings on the tin woodman. Fourth she calls up her guards, the winkies, who are frightened away by the lion. Her fifth and most powerful force is the flying monkeys. They succeed by destroying the woodman and the scarecrow and enslaving the lion. They stop short of killing D because she has the protective kiss given by the good witch. Instead, they take her and the lion to the wicked witch. The monkeys say : the power of good is mroe powerful than the power of evil. The witch is also afraid of the kiss and turns her attention to D's shoes because they are magic. She is put into service cleaning the castle and the witch works out a plan to get her shoes for then she would be invincible. She manages to trick D and gets one of the shoes. The witch who hates the dark

and water (she always carries an umbrella) must use these tricks because of her fears. A furious D throws a bucket of water she was using to clean the kitchen floor over the witch because she deprived D of her shoe. The witch melts away into a brown puddle. D puts her lost shoe on and liberates the lion after she has apologised to the witch for killing her. The story ends with all the friends suddenly reunited and the reader is told to get another book for more adventures concerning D's struggle to get home to Kansas.

2.2.4 The Text and Reading : Starting to Define the Process

What does this story mean?

There seems to be one obvious meaning : 'the power of good is more powerful than the power of evil' and, moreover, struggling and suffering will ensure that good will triumphs. It is not only the explicitness of the moral 'punch line' that legitimises this reading; for example, the deaths of the two witches are curiously unintentional and Dorothy apologises for them. It is as if she were not the agent of the killings but something supernaturally good was on her side. It is clear Dorothy will succeed (heroines do not die in fairy tales) and even though she will meet with disappointment and often be up against tremendous odds, she will be rewarded by success; yet the ultimate means of it - the death of the witch by melting - is accidental; the association of effort and reward is contiguous but non-causal revealing the moral that blind struggling will one day win through.

But here is another meaning:

Historically the place from whence Dorothy comes is a deprived area. The illustrations in the text show Dorothy's home as a dirt farmer's shack and the child has very worn shoes - a classic sign of poverty.

We can then see the departure by way of tornado from the Kansas dirt farm as a kind of escape from the 'Grapes of Wrath'. A child, born to dust bowl farmers, is suddenly transported by a wind to a lush land, which has, an Emerald city. Her very first acquisition is a pair of shoes and she makes a comment on how shabby her own shoes are, admitting as she does that she will need the new ones to get home again. There is now a clear link between the Wicked Witch of the West and wealth because the witch wants the shoes.

If the witches are conceptualised as winds, then it is indeed the winds that take away the wealth of the farmers, and the wickedness of the winds can only be cured by water as, indeed, the death of the witch is accomplished in the story.

These two 'meanings' are in fact short, uni-thematic readings of the original text and an analysis of them should lead to a fuller understanding of the reading process.

To begin with, we can say that they depend upon two processes:

- (1) the use of metaphor, i.e. the substitution of witch for evilness and for winds, and

- (ii) the use of a frame of reference that in some way constrains or orders the reading around a theme; in the first case it is a 'moralistic' frame and in the second it is a 'socio-historic' frame.

The overall effect is one of a reduction of the potential plurality of meaning of the text to a definitive one. Furthermore, I would like to propose that these readings are not haphazard or simply chance occurrences but rather they are determined and coherent renderings of the possible meanings in the original story. The reason for this depends upon the two processes mentioned above and especially the use of metaphor not only in the process of reading but also of writing.

Metaphor is a linguistic device which occurs when one signifier stands in the place of another in a text and where they share a common attribute or set of attributes. In the case of the second reading, it seems clear that the substitution of wind for witch is based upon such key attributes (signifiers) as 'powerful', 'harmful' and a 'mysteriousness' that puts them beyond man - they are in a sense 'uncontrollable'. Furthermore, the witch and the wind are related contiguously (metonymically) in that the witch rides on the wind whereas the key attributes above are related in that they are common to both witch and wind - the association is one of similarity.

From the reader's point of view the exploration of these associations

constitutes the meaning that the metaphorical construction generates; from this perspective it is more apposite to call these association chains of signification, after Lacan (1972), in that it is by 'going down' these associations that the 'possible' meaning - the multitude of relationships that the signifiers can enter into - is explored or 'fleshed out'.

Empson (1965) makes a similar point when discussing the 'exploratory attention' demanded by metaphorical construction in poetry when he says that one must offer simultaneous translations in the various different directions that the chains of signification can take in order to dissolve the ambiguity of the poem and Lacan (1972) has pointed out, also in relation to poetry, that metaphor occurs at the precise point where sense comes out of nonsense, where the reader, recognising the metaphorical nature of the signifier in the text, can then explore its meaning or signification. It should be emphasised though that the necessary assumption behind this and also behind my two readings above is that the reader must, in the first instance, recognise the possibility of the metaphorical nature of a text; it is only after the recognition of this convention by the reader that the exploration can be carried out and a meaning be assigned to the poem.

This brings me on to the nature of the relationship between reading and writing. The chains of signification that I used to construct my readings i.e. 'powerful', 'harmful' etc. are not idiosyncratic to me but public associations that link wind to witch; they are conventional within the culture in which I grew up. In a sense then we can say that

the presence of witches within the fairy tales under consideration (supported by such events as the destructive tornado, which indicate that my fleshing out of the metaphor is the apposite one) has effected my reading(s) and, in addition, these are effects that the writer has put there in the first place. As Culler (1975) points out:

"Even if the author does not think of readers, he is himself a reader of his own work and will not be satisfied with it unless he can read it as producing effects." (p.116)

For the author of The Wizard, Frank Baum, to feel that he had written a fairy tale he had to read and experience it as such and this necessarily involves producing effects for others. Obviously one of the ways in which these effects are created is through metaphorical construction and the greater the disparity of the images signified then the greater the 'creative spark' and the greater the effect on both the reader and the author.

It is now possible to point to the vital link between reading and writing in that both are based upon the structure of language that allows, in a more or less constraining way, possible readings. On this account reading can be termed a re-writing and indeed, the readings I proposed above are re-written from the original text and, because both texts depend upon the structure of language, then reading and writing can be identified.

One must, however, distinguish between the reading(s) and the text. The first is the meaning made out of the latter. I have shown that one of the ways that this can be done is for the writer to construct metaphors and for the reader to recognise them as such and explore the chains of signification. But there is also the problem of the other constraint, that of the frame of reference and its relationship to the relatively⁽⁴⁾ ordered meanings of the metaphorical construction allows. It is with this larger question, that of the structure of the text and how it allows readings that a structuralist poetics is concerned; it tries to make intelligible the underlying system that makes the text effective and this must include all the possible meanings or the range of meanings of the text. Barthes puts it this way:

"What interests it will be the variation of meaning generated, and, as it were, capable of being generated by works; it will not interpret symbols but describe their polyvancy. In short, its object will not be the full meanings of the work but on the contrary the empty meaning which supports them all."
(in Culler, 1975, p.118).

This 'empty meaning' is important for what constitutes its emptiness is the fact that it generates a set of meanings but is not itself open to hermeneusis. This means that the possibility of a uni-thematic

(4) The phrases 'relatively ordered' and 'more or less constrained' refer to the fact that authors can direct very precisely a reader's path down a particular chain of signification or not direct at all; compare for example Donne's 'A Valediction Forbidding Mourning' in which his and his lover's 'soules'; 'If they be two, they are two so/ As stiffe twin compasses are two/Thy soule the fix foot, makes no show/To move, but, doth if the 'other do' (here the reader is directed to certain attributes of the compass and not others) with Shakespeare's notion of what happens on the Day of Judgement: 'we ourselves compelled/ Even to the teeth and forehead of our faults'. one can go a long way in many directions with this (see Culler, 1975, pp. 182-3).

reading, for example, the moralistic or the sociological reading above, is based upon the much larger problematic of the structure of the language that the writer must necessarily use because the writer is also a reader he, therefore, has to write in the language of the other.

The study of the underlying system that allows this to happen creates a science that goes beyond the individual and his relationship to his product (i.e. the text), as if a definitive ('full') meaning resided in that relationship, and opens up the possibility that the text is part of a system whose elements are other texts.⁽⁵⁾

The underlying and organising concept that best characterises this idea of reading as writing is the notion of coherence. It should be possible to ask : what makes a reading coherent? But this is now the same as asking : what makes the text coherent? This is because the notion of coherence refers to coherence for a reader and, as pointed out, a writer is a reader.

The intuitive answer to the questions is that it is the form of the reading or text that gives coherence. Within Structuralist Poetics this idea of reading as coherence has various labels and connotations:

- (i) Recuperation: the association is of reviving a failing patient; one that was almost lost.

(5) This is more than a simple taxonomy that is usually called a classification into 'genres'; rather it seeks to establish functional categories based on the features that govern how certain texts are read and written.

- (ii) Naturalisation: what seems strange in the text is made habitual and hence 'natural'.
- (iii) Motivation : the process of reading whereby items that seem random and incoherent gain coherence when seen in terms of their functions and roles in the story as a whole.
- (iv) Vraiemblablisation: reading by using cultural models as sources with which coherence is made out of the story. All these words refer to 'ways of reading'. Their common denominator is that reading is an activity in which the reader makes use of frameworks with which to neutralise or simplify the text. When this is combined with the multi-directional possibilities of the metaphorical construction then we can see the tension that exists between what seem to be two different modes of reading process.

In my two readings of The Wizard it is clear what 'frameworks' are being used. It is, however, very unsafe to assume that my informant is working with either of them. Both seem to be readings that are at an abstract level of coherence; they are rational interpretations. The second framework for coherence, that of the socio-historic, requires a knowledge of the world and especially Kansas and its agriculture that the reader does not have. Even an identification on this level of coherence is impossible because the heroine of the story is poor and my informant is 'well-heeled'.

The second framework, that of the religious, has more of a chance of being used by virtue of its stability within my informant's culture, but once again it requires (as it is presented) the ability to formulate abstract interpretations. It is difficult to credit the child with the ability to make such abstract, coherent readings.

What the Structuralist Poetic argument misses about reading is that the particular reader is going to produce a particular reading and this is certainly so when we consider children reading fairy tales. The discussion on Bettelheim shows that the 'framework' that will be used is affective but it is also true to say, along with the Structuralists, that the use of this framework depends as much upon the 'underlying system' of the text as it does upon the context of the reader.

The next section is based upon the notion that both the underlying systems of the text and its reading are open to analysis by the use of the linguistic heuristic that I have taken from the study of myths; it is hoped that it will reveal the affective structure of the text.

2.2.5 Textual Analysis : A Beginning

The analysis proceeds as Levi-Strauss would suggest; the narrative is broken down into short sentences and the affective content of these sentences is then organised into binary oppositions. If the fairy tale is considered to be a progression of affective thought then each sentence can be considered as an AFFECTEME, in the same way that the myth hearer thinks with mythemes.

When the story is decomposed into affectemes (i.e. events of a story that signify affect) it is possible to organise it into a simple binary system within the generalised affect - Fear v. Security. (See Table 2.1).

It is true that there are many emotions signified in the story. It is not so much that the two affects chosen predominate in the story as they represent a final level of abstraction which generalises the particular affects signified by the affectemes. This use of the binary method is, of course, quite legitimate and true to the way it is used in the analysis of myths; its ultimate value will be found in its ability to 'stimulate perception'. Given this, a few preliminary remarks can be made about this perception that the binary method has generated.

Security on the part of the witch, calling the monkeys for example, is put on the Fear side of the opposition because the affect signified by the affecteme is related to the reader and, unless the reader is the daughter of a witch, it is assumed that affectemes affect the reader. So although the monkeys are security for the witch, their arrival does not generate that in the child reader.

The last affecteme is placed on both sides because, even though, being free with her friends allows Dorothy a certain relief and security from the wicked witch, the reader is also told in another book (which the reader is presumed to know about), that after more adventures Dorothy finds her way home. However, if that is the case, her adventures are anything like the ones just read then it is cause for Fear.

2. The sky grew dark and a tornado lifts Dorothy and Toto in her house into Oz, killing the bad witch of the East.
4. The road to Emerald City is dangerous.
7. The Wizard denies their desires, he wants them to kill the wicked witch of the West and then he will grant their wishes.
9. They set off towards the West; an angry witch decides to punish the strangers for not asking permission to enter the West. She sends for her wolves, bees, crows and winkies.
11. The determined witch then calls the winged monkeys for the last time; the lion is enslaved and the other two are destroyed.
13. She is returned to the castle and the witch wants Dorothy's shoes, to become all powerful. She is afraid of water and the dark and tricks a shoe from Dorothy.
15. Dorothy is re-united with her friends; how she gets home can be found in another book.

1. Once Dorothy and Toto lived on a farm in Kansas.
3. She meets the good witch of the North, who gives her the silver shoes and tells her that only the Wizard of Oz in the Emerald City knows the way to her home.
5. The good witch gives her a protective kiss on the forehead.
6. She sets off and meets three friends on the road : a lion who wants courage, a woodman who wants a heart, a scarecrow who wants brains. They go together to Oz to get what they want.
8. The lion resolves to go and kill the witch.
10. The woodman axes the wolves; the scarecrow kills the bees and the lion frightens the winkies.
12. Dorothy, however, is protected by the kiss because 'good is more powerful than the power of evil'.
14. Dorothy becomes angry and throws a bucket of water over the witch and she melts into a brown puddle.
15. Dorothy is re-united with her friends; how she gets home can be found in another book.

TABLE 2.1 : THE AFFECT STRUCTURE OF THE WIZARD OF OZ

So, affecteme 15 brings the opposition to a type of mediation; by being both about fear and security it contains the two terms. But this mediation has another meaning outside the affect structure of the text; it has a commercial sense in that the original problem - how can Dorothy get back to the security of her family - is perpetuated by the mediation. Dorothy's escape from Oz is deferred until the reader has bought another book and, instead of the mediation being a progression onto something else, it leads back again to the same thing, whereas a real mediation should go beyond the terms.

Rather than this being an argument against the idea of a text being a progression of affective thought, it can be seen as an argument that the publishers are using this device of splitting up the story as a way of selling children's literature by simply not allowing the affective structure to be passed over within a single volume. For them this structure sells and it will be interesting to see what use the reader makes of it.

2.2.5.1 Victoria's Reconstruction

Victoria's version of the story is treated in exactly the same way as text 1. It is decomposed into sentences and organised around affect signified by these sentences.

(See Table 2.2)

FEAR

v.

SECURITY

1. Suddenly the ground went all funny.

3. She didn't have time to go down to the larder, and she went up into the air and it (the house) landed on the bad witch of the West.

5. Winkies and they (monkeys) go and get her : 'that's the bad witch' (pointing to illustration)

2. And the girl hides in her bedroom.

4. And she (witch of the North) kisses her and she goes to visit Oz and to get back to her home.

6. And then she soaks water over her and then he joins them (lion).

7. She finds her way back home and lives the rest of her life.

TABLE 2.2 : THE AFFECT STRUCTURE OF TEXT 2

The reconstruction is a very 'lean' narrative that was delivered in a rapid way. There are some noticeable additions such as the girl's bedroom, the larder in the (one assumes) basement and the happy ending. Although there are numerous omissions the story reads like a narrative. Those phrases in parenthesis represent times when Victoria points to the illustrations in the book and it is quite clear that her reconstruction owes a lot to visual cues and, although the use of illustrations in modern re-productions of fairy tales is deplored by Bettelheim, it is nevertheless a fact of life and their significance will be discussed below. (See Section 2.7.8)

The first thing we can say about the progression of Victoria's narrative is that it is given a definitive ending, the opposition is resolved firmly on the side of Security. The fact that this is an addition to text 1 demonstrates that text 2 is a variation on text 1 (where the opposition was left totally unresolved) of some significance for the reader. But it is clear that, from the narrative, we can say (at this moment) very little about how the first text was used and, indeed, why it was used. The main hypothesis is that the structure and content of text 1 affects the reader in some way; it will be recalled that structure is not enough, there has to be something about the content, no matter how bizarre, out of which the child makes sense. Thus, the child will be active in her reading to find a solution to a contradiction that the text structures for her and at the same time, it is proposed that this solution will be made at the level of content.

From the point of view the linguistic method used it seems clear that it only answers half the question, i.e. the nature of the affective

structure, and not the other half, which is the use to which the content is put. It is, therefore, necessary to probe, using vector e of diagram 2-2, the reader's associations to the affectively structured content. The above-mentioned diagram also indicates that by doing this we will be necessarily involved with the reader's context. It is the combination of the result of the use of vector e plus the informant's re-construction that is the re-representation of the text.

2.2.6 Structure, Content and Context - the Re-representation

As mentioned above, the channel of communication represented by e is used in an intuitive way. When the informant was asked : who is your favourite character in the story? The answer is Toto, the dog. As the dog plays no role at all in the story, I asked her why she found the dog so important. The answer was that she has always wanted a dog.

I then asked her about what I considered to be a major addition to text 1 - the larder. She told me that her friend has a larder in the basement of her house in which is hidden buried treasure and into which they enter only with the protection of the friend's dog, Flora. It seems to me that going down into the larder is not unlike going to Oz, where a strange and dangerous territory (larder/Oz), is entered with a dog (Flora/Toto).

Her description of the main character, Dorothy, included pointing to her own blond hair and saying : "she has yellow hair". This identification is further corroborated by the fact that Dorothy has what the reader

can now be asked is : 'what is the meaning of a pet for any child?'

The answer is its function in the emotional life of the child; possessing a pet 'contains' the oppositions, Fear/Security. Fear, in that possessing a pet is a responsibility, it needs looking after and it could die or get lost. Security, in the sense that the pet holds out the possibility of, what could be called, 'canine unconditional positive regard'. The child is loved entirely and continually and in these ways the pet provides both fear and security⁽⁶⁾.

On the particular level it becomes clear why this particular story is her favourite - this is the only way she can get a dog; by reading a story that has the affect structure and particular content that suits her. If the Wizard did not fill these conditions then the reader would be reading another book which offered her the right structure and content for her and her context.

Now the inescapable fact of her situation is that Victoria is not allowed to have a dog. In the first place there are sound material reasons : the house is too small, the family always goes away at weekends and the father works, seeing patients, in each domicile. Also a 'real' dog would be a solution to her affective contradiction but it could become a problem for her older sister - a solution of one person's contradiction can quite often become someone else's contradiction. The facts are that the existential predicament of the reader

(6) It is also interesting to note in the context of the Security term of the opposition that for about 12 years now there has existed a type of psychotherapy called 'pet therapy' based upon the effect of having a pet.

rules out having what she wants--a dog, and generally, a pet. Her answer is to read and re-read the Wizard for this is how she gets her pet and her subsequent emotional mediation which, although it can never be solved, can be mediated on the imaginary plane by reading the apposite book.

2.2.7 Discussion

In this section I would like to sort out some of the implications of the analysis of text and representation.

2.2.7.1 In Linguistics

From the linguistic perspective several points can be mentioned: The binary method creates another object and, although it is extremely simple, it manages to allow us to see an aspect of the structure which, from the reading of Bettelheim, is assumed to be 'privileged', i.e. the existence of the affect structure.

Now the main and perpetual question that arises is the validity of this structure. It can be asked : 'does it exist in the text(s) or only in the imagination of the researcher?' This is a serious question and it can be answered in two ways:

(i) Levi-Strauss' reply is to say that the structure is the result of the brain's structure. In a sense then the structure is pre-formative to use Piaget's (1969) categorization. But as I mentioned above, this theory of Levi-Strauss is the result,

inter alia, of a sleight of hand in the practice of analysing myths where the heuristic is elevated to a principle of thought.

- (ii) the second reply is the one favoured here which is that the structure is constructed so that its ultimate validity rests in its coherence. The construction presented above is the result of applying the linguistic heuristic and, given its premises, what follows must be coherent in terms of them. By adopting this approach to structure it is possible to admit those aspects of the social psychological subject that Levi-Strauss dissolved and which are a necessary part of the present research; these are what he would call 'pollutants', viz development, context and the wider social situation of the person.

Another aspect of the linguistic perspective is the implications that have arisen out of the use of the terms HORIZONTAL/VERTICAL dimensions. In linguistic terminology this is the syntagmatic/paradigmatic distinction made by Saussure (1974). The complication arises not out of the application of phonology to the story, for this is simple enough to do, but out of the re-insertion of the social psychological reader into the structure. The problem is nascent in Levi-Strauss in the confusion that exists as to what constitutes a mytheme. The ideal analysis is always given as the Oedipus myth where the mythemes are columnar and are said to get their meaning from their binary relationship to other columns and, yet, later the elements of myths

(e.g. coyote) get mytheme status as 'mediator' (the things with which the myth hearer thinks). This same problem exists in the textual analysis of The Wizard but it is only noticeable when the reader (analogous to the myth hearer) is given a status vis à vis the structure. It will be recalled that it is through the exploration of Victoria's associations to certain signifiers, one in the text, the other added to the text, that it was possible to understand what the text was being made into by her. But this paradigmatic, associative dimension is very unlike the columns that signify the affects, Fear/Security. The reader is 'thinking' with individual words (like the Pueblo thinks with the Coyote) rather than the columns and their relationships (like the Oedipus myth). The problem is this : the textual analysis is linguistic in that it 'sorts' the story out into two dimensions yet although this is a coherent, the use made of it is not the same as the use that humans are supposed to make to the phoneme, which is the unit upon which the method is based! It is as if instead of being able to distinguish words by a combination of distinctive features called phonemes we in fact do this with just one distinctive feature. In the Wizard this is the dog, TOTO, who is not so much a complex phoneme as a distinctive feature; not so much an affecteme as a distinctive part of it. By listening to the person 'in' the structure of the story it can be seen that the strictly binary model 'breaks down' at the important point of the 'use' to which it is put. Once again, in the study of myths, the only use to which it is put is that generated by the researcher himself and he is a biased informant.

However, out of this eruption, certain things follow that move the thesis on its way:

In the first place it corroborates some of the ideas concerning Levi-Strauss, i.e. his formalism and the dissolution of the subject cannot be based on the binary heuristic. The origins of the error lie in the model appropriated - the phoneme - based as it is on the fact that language is doubly articulated; it is first meaningful and secondly meaningless. In the first articulation language can 'make meaning' in the second its articulation is neutral; in the first, language deals with meaningful units called signs and, in the second, it deals with neutral sounds, called phonemes. By taking a neutral model and transporting it to a very 'un-neutral' field of enquiry (myths) you run the risk of constructing neutrality into your object of study - and the mythologue's formalism is the outcome.

Using the model as heuristic as opposed to algorithm leaves some space for social psychology. Thus, the analysis of The Wizard constructs for us a simple structure based around affect but, because no basic principle of thought or affective thought is assumed, one is not forced to say how the structure will be used.

The facts seem to be that there are certain 'Primary Signifiers' which are used whose meaning is a complicated patterning in the emotional life of the child. The further point is that the structure of affect in the story and of the signifiers in it 'suits' the child's needs at a particular moment in her life. So the child makes sense out of the story vis à vis her context but at the same time the story makes sense to her in her context. The affect structure of the story

is, in some way, the material externalisation of an ineffable affectivity in the child and the organisation of the signifiers in this structure can be used by the reader to 'mediate' this affectivity.

If this is so then the present analysis is inadequate in one fundamental way : it says nothing about how the signifiers in the story are structured; this is because the analysis begins at the level of the sentence and descends to the level of the phoneme. In the study of myths the myth was considered to be a signifier (signifying an ultimate signified) whereas, in the fairy tale, it would be better, as I pointed out above, to start with what it is; a narrative - a particular concatenation of signs. What is needed then is an analysis that works the other way; from the sentence to the structure of the narrative that also incorporates the concept of the primary signifier(s) rather than from the sign to its phonemic structure.

In summary, the reason that the binary heuristic is inadequate to the task is because of the use made of the text by the informant. By listening to her associations to the story it is possible to see that the bi-dimensional linguistic structure is used in a particular way and that the vertical dimension of the personal associations is based upon certain signifiers, not columnar affectemes. Thus, an analysis is needed that informs us how the signifiers are patterned in the structure.

simplifications. The reader has made over the story, has naturalised it and given it a personal type of ordering as was predicted in the section on reading. But as was also mentioned, this ordering was done with the use of frameworks and it can be seen that the framework that Victoria used was at a general and individual level; the general level was best captured in the meaning of a pet for any child; this could be called the public level because the desire for a pet touches most kids. But it was argued that at the particular level my informant had her own special problems and context : the sister, the size of the houses, her friend's larder and dog : this could be called the idiosyncratic level.

Thus, even though the affect structure of the story externalises a general affective contradiction, the reading that follows from it is 'filled in' and made natural in a personal way which I would argue is similar to the 'enriching structures' that Bransford and Franks (1971) postulated.

2.2.7.4 Primary Signifiers

One of the most important points that comes out of the first tentative textual analysis is the function of the text's signifiers, especially 'primary' signifiers and particularly their relationship to the affect-signifieds, née affectemes.

So far we can say that there are two primary signifiers⁽⁷⁾ that stand out : the dog Toto and the Larder. The signification of the larder is a very good example of the enriching or 'filling in' of text 1 from the personal experience of the reader in order to render the original text coherent. The signifier Toto is not an addition to the text but is already present in text 1; the strange thing is that it is left out of the re-construction and is only discovered as an important element in the interview; this can be seen as another way of filling in in that the dog seems to contain feelings that are otherwise not articulated in the child. Toto (and of course Dorothy) seem to be used as empty containers into which feelings can be projected. Once contained within a suitable affective structure they can be articulated in the story. Furthermore, the distinction between what is added and what is already there in the text is blurred by the fact that the larder, and the signification that Victoria gives to it, results from a contiguous association with Toto; these signifiers are linked in the reader's mind and seem to be the primary associations that give the story some sort of coherence.

All aspects of the preliminary analysis of the text and its reconstruction seem to point to the need for an understanding of what the child is faced with; a narrative system of signs some of which are more primary than others.

There are two problems that have arisen so far that must be considered before proceeding further. The first is the difficult problem of un-

(7) Of course there are others; Dorothy and the Wicked Witch of the West for example. The identification with the heroine remains axiomatic and the confusion about the death of the witch is very significant; the full significance of these signifiers is brought out later in a further textual analysis, see Section 2.6.

leashing the thesis from the idea that the text is a sign open to phonological analysis. This will be discussed in 2.4. This problem cannot be divorced from a second one, that of the status and nature of affect in the research, but for the sake of presentation they are separated for the moment and synthesised later on.

2.3 Cognitive Theories of Emotion

So far I have developed the idea that feelings that are ineffable or impossible for the child to interpret are given an externalisation by the more or less complicated affect structure of the story and the patterning of signifiers in it. These feelings get a form as it were and, thus, it can be said that ineffability is reduced by the story's structure and content.

But the corollary to this is that with the erasure of ineffability comes the imposition of articulation; an implication of this is that emotion cannot be separated from cognition according to the proposition that, as we grow up, the ineffable is articulated for us by the cultural artefacts with which we are presented. We learn how to feel or, in another way, our feelings are cognitive. As Bretch put it : "we feel thoughtfully and we think feelingly". Separating thought and emotion, is (to use Saussure's analogy) like trying to cut the back from the front of a piece of paper, or to use Bretch, like trying to take an adverb away from its verb. What support though, is there for the proposition that affect is an integral part of cognitive structure of the person?

Theories of emotion in psychology are divided into two main types: those that think that emotion is a direct physiological response to external stimuli and those that propose a mediating factor between stimulus and response.

The latter are known as Cognitive theories of Emotion and they rest upon a series of experiments by Schacter and Singer (in Schacter 1971) showing that the type of emotional response depends upon the structure and perception of the situation within which the emotional behaviour takes place.

From the perspective of the thesis this goes some way in justifying the stance that the meaning of a text is its affective impact on the reader : it is meaningful to a person as it is emotionally relevant. Put within Schacter's research the structure of the various situations the child finds herself in, for example her school life, home life and her literature allows the interpretation of the feeling states that she undergoes.

But throughout the work on cognitive theories of emotion it is noticeable that the separation of 'feeling-state' and cognition is kept. It is said to be an 'interactionist approach' and it seems clear that two distinct realms of reality are interacting. What this means is that implicit in the work is the separation of thought and affect.

However, the work of Hohmann (in Schacter 1971) whose subjects, injured

paraplegics, reported 'as if' emotions or acted emotional without being able to 'feel' due to lesions in the spinal cord points in the direction of the inseparability of thought and affect. The reason for this is that his subjects reported a memory of 'shaking madness' and, if this is true, then their pre-injury physiological arousal must have been part of cognition where any act of cognition can be conceived as a matter of retrieving structure from memory. Schacter (1971) agrees with this when he says:

"autonomic arousal greatly facilitates the acquisition of emotional behaviour but is not necessary for its maintenance if the behaviour is acquired prior to sympathectomy." (p.51)

It is perhaps better to look at this question from a developmental perspective. So we can now ask : what is the process by which a feeling-state becomes an inseparable part of representational (i.e. cognitive) capacities? The assumption behind this question is that the human starts with feeling states but must, at a certain stage of development, incorporate them into a cognitive system.

If the cognitive aspect of emotion is accepted then we can say that emotion is object-centred or 'intentional' (in the phenomenological sense); that we are always conscious of something. It follows from this that emotion has a purpose or a goal; emotion is a means to a particular end and, consequently, it must be explained contextually; in other words emotion is purposeful and meaningful.

One of the great cognitive tasks of the developing infant is to relate to the objects (including people) in his or her environment. Yet we could say that the neonate is faced with two primary objects right from the beginning of life; i.e. the two feeling states of well-being and discomfort. These two states of being are primary in that they precede the child's relationship with his external objects (notably the caretaking mother). It is when these objects affect these feeling states that the ineluctable bond between feeling state and representation develops. The most explicit and powerful explanation of this theory of affect comes in a paper by Sandler and Sandler (1978) who describe how the infant will try to maintain relations with those objects which lead to pleasure states (objects with whom interaction results in a positive feeling state) and avoid 'bad' objects (those which, during interaction, result in disturbing feelings).

Allied to this is the fact that the child will start to represent not only those objects with which he interacts but also himself in this interaction. Now the original goal of the interaction is to maintain the good state, a wish-fulfillment, that, thanks to human cognition, can now be carried out in fantasy, dreams, day dreams as well as in reality. The actual form of these relationships will depend upon the particular circumstances of the child as he or she develops, they will nevertheless become structured over the years as they are efficacious in maximizing the once good feeling-state:

"In the development of the object relationship (i.e. structured role relationships) the part played by affective experience is central. An experience only has or retains meaning for a child if it is linked with feeling. The assumption is made that ultimately all meaning is developmentally functionally related to states of feeling." (1978, p.292) (my emphasis)

It is with the development of representational processes and self and other, that the child attempts, through previously learnt role relationships with mother, to reinstate the constellation of pleasurable feelings which, because of the increasing boundary between self and other, the child can no longer assume to be forthcoming. The complications of human inter-subjectivity arise when one tries to reinstate good feelings through manipulating the other into a role relationship that is, and has always been, efficacious in doing this for us. So, as we develop, various strategies of relating arise which are ways of obtaining some sort of affirmation of security; a general term used by Sandler and Sandler (1978) for the constellation of good affect that adults try for:

"The urge to re-experience important subjective aspects of object relationships from the first years of life constantly recurs and persists.... particularly when our feelings of security or safety are threatened as they constantly are."
(p.287)

Here affect itself is incorporated into the child's representations of his objective world and thereby becomes a privileged, but not separate, part of his conscious and unconscious mental apparatus.

It also follows from this that affect is social. It may be particular to the family context but it nevertheless is an act of sociality in that the 'objects' of the child's life are as significant as the self : 'the object plays as important a role as the self in the mental representations which is part of the wish.' (p.291) The advantage of adopting this perspective is that it allows one to think about affect as not ontologically apart from thought but rather as part of thought.

Also, just as there is no 'private' language, there is no private emotion for emotion is always a relation. Emotions are possible because of other people in much the same way that language is possible and necessary because of other people.

In this thesis the theory of affect as relation clarifies a major part of the data. In the first place children's literature (when read) constitutes situations in the life of the child. As I show, the Wizard has a very simple affective structure which, together with the play of signifiers in it, creates for the reader a meaningful space wherein she can find a solution to maintain the good relationships with the objects of her situation; in this case through the dog Toto who acts as the mediator of the opposition.

However, this analysis of the role of affect is insufficient on its own. A glance at the informant's reconstruction of the Wizard is enough to indicate that we are dealing with a 'competence' to tell stories and this is very much caught up with the idea that reading

is a type of writing. Placing a purely affective structure on the story cannot be to account for this competence. It is also clear that this affective structure is not 'free-floating' in an ephemeral binary deep structure somewhere in the text but it is, on the contrary, tied down to a structure that we can assume should have a lot to do with its efficacy.

2.4 TEXTUAL ANALYSIS

We now have to deal with the problem of the concatenation of signifiers within the text; how are they structured and how do they fit in with the affect structure? This problem requires an improved analysis of sentence meaning which avoids the pitfalls of transformational grammar and at the same time can inform about the macro-structure of the text. This will be developed using ideas from the work of Vladimir Propp and A.J. Greimas discussed below.

2.4.1 Vladimir Propp's Contribution

As a Formalist, Propp subscribed to certain principles. The first and most vital is that the work of prose is literary, what is called "Literaturnost" - the specific quality of being literary - and it was the formalists' project to describe and explain this fact.

The second axiom is that art is the making strange of objects a renewal of perception, a defamiliarisation that shakes readers from habitual ways of seeing. The word 'ostranenie' was used to capture this notion.

Propp's major work, The Morphology of the Folk Tale (1958) shows that folk tales do not deviate according to the type of character found in particular stories. For example, an ogre in one tale could be replaced by a dragon or a troll in another tale; content is dependent upon the place or origin of the story; Russian, German etc. The plot, however, is dependent upon more abstract, formal relationships which refer to actions and functions rather than to type of character. Propp's (1958) point is that this is the feature that makes folk tales a literary fact; they remain constant with variable content:

"The characters' actions represent constants while everything else can vary. For example:

1. The king sends Ivan to find the princess. Ivan leaves.
2. The king sends Ivan to find a rare object, Ivan leaves etc.

... and so on. The sending on the search, and the departure, are constants. The sender and the leaver, the motivation for the sending are variables." (in Miranda, P., 1972, p.139).

Once again as with the structuralist analyses the emphasis is upon the invariants. For Propp these invariants are of essentially two types:

- (i) the role, that may take a variety of characters given the venue in which the tale originates, and
- (ii) the function, which is a particular action that is significant as it relates the whole story or plot.

But, being a Formalist, Propp (1958) did not stop at the original corpus upon which he developed these ideas (i.e. Russian fairy tales) trying, instead, to incorporate them into a universal grid of fairy tale roles and functions:

"The researcher can prove that different tales, such as the Egyptian tale of two brothers, the tale of the firebird, the tale of the Morozok, the tales of the fisherman and the fish as well as a number of myths, justify joint study." (p.140)

This was attempted by isolating a set of 150 roles and a set of 31 functions. So, for example, X gives Y a horse contains one function 'giving' and 3 elements or roles. X becomes the 'benefactor', Y is the 'receiver', 'horse' is the object given. By making a grid of roles and functions, all fairy tales can be put into it and those that cannot do not qualify as fairy tales:

".... conversely, every tale that could be entered on the chart is a fairy tale and every one that cannot belongs to another type of tale." (p.140)

This a good example of 'early' structuralism employing a deep structure 'generating machine' (the grid) that produces all fairy tales and no non-fairy tales. This analysis suffers like all such systems from the lack of an understanding of content vis a vis the important and related question of reading. Nevertheless, the analysis of underlying structure that Propp initiated was taken up by Greimas in a fruitful way.

2.4.1.2 Greimas development of Propp's structure

What Propp considers to be a function of plot Greimas considers to be a function of words themselves⁽⁸⁾. It is not in the individual word that Greimas becomes important but rather in the 'dramatic structure' that he points out exists and is common to ALL types of discourse. That is to say that words enter into relationships with each other, or play roles vis and vis each other. The failure of Levi-Strauss' method for the fairy tale was that it saw the tales as a single signifier rather than as a linear complex series of signs - the basic structure of which is dramatic:

"If we recall that functions in traditional syntax are but roles played by words - the subject being 'the one who performs the action', the object 'the one who suffers it etc.'" (in Culler, 1975, p.124)

then the spectacle or play the words act out is:

"unique in that it is permanent : the content of the actions changes all the time, the actors vary, but the enunciation spectacle, remains forever the same, for its permanence is guaranteed by the fixed distribution of the basic roles." (p.124)

The invariance (permanence) here is the sentence seen as a predicate with a constellation of roles; Greimas conceives of 6 different roles, subject, object, sender, receiver, opponent and helper; there are two types of predicate; the function, sometimes called the dynamic pre-

(8) One can see here the radical difference between Formalism and Structuralism. The former concentrated upon the 'literary fact' while the latter, because of Saussure, concentrated upon the work's linguistic nature.

dicator and qualifications called static predicates. In addition, a predicate may also include an adverbial element called an aspect.

Here, Greimas demonstrates that what Propp was talking about can be handled as well in linguistic terms. But Propp also has the advantage of allowing us to say how sentences are related to one another, i.e. how the text is structured, whereas Greimas' analysis leaves us at the sentence's dramatic structure. So, for Propp, functions are not simply actions or predicates in a sentence but they also get a meaning from their role in the story as a whole. As Culler (1975) points out, this is necessary and something that Greimas misses:

"he [Greimas] gives no indication as to how his model would deal with all the problems of the relationship between sentences....". (p.83)

so a combination of Propp's and Greimas' ideas might produce the foundation for an answer to the current problem of the thesis; viz. the need for an adequate sentential analysis that informs also about the macro structure of the text. What remains is a method for doing this.

The path from Propp to Greimas reveals that what is thought to be invariant is analogous to 'case grammar' which also talks about predicates and their roles but conceived as grammatical cases. Moreover case grammar, as it will be used and developed in this thesis, can provide both a method and notation that incorporates what is useful

in Propp and Greimas and, at the same time, advances the theoretical understanding of both text and reading with specific reference to The Wizard.

2.4.2 Case Grammar

This is the term given to the 'logical' relations that exist between nouns and between nouns and verbs in sentences. Although Fillmore (1968) claimed they:

"comprise a set of universal, presumably innate, concepts which identify certain types of judgement, human beings are capable of making about the events that are going on about them, judgements about such matters as who did it, who it happened to and what got changed." (p.1)

no such assumption about universality of concepts is made here, rather the assumption is made, along with Piaget (1971), that concepts, even that of object constancy, have to be learned through a process of activity or construction.

The use of case grammar here is to make the needed link between signs and sentential meaning and from there the problem of the higher order structure, the text, can be resolved.

2.4.3 Cases and Propositions

It is difficult to ascertain when the 'proposition' makes its appearance in psychology and especially in cognitive psycholinguistics. It could be said that it has its birth in the deep structure of T.G. and

Chomsky does talk about deep structure as a set of propositions in Language and Mind (1968). But the 'proposition' also plays an important role in Case Grammar and certainly it is important in the cognitive psycho-linguistic uses of it, for example, Kintsch (1974) and Anderson (1976).

The connotations, in psychology, around the word 'proposition' seems to be that they are essentially part of a deep structure; they are simple sentences which signify single, unambiguous meanings. The difference between Case and T.G. uses of the word is that in the latter syntactical terms are used, and in the former the categories that are used are considered to be functional semantic relationships. With this new formulation, cognitive psychologists are able to break away from the idea that what is stored in memory is a traditional grammar and adopt the idea that memory contains semantic relationships along the lines of case grammar's analysis of propositions. The implications of this are:

- (i) that psychologists could now model a person's 'knowledge of' such things as 'events' rather than the T.G. notion of 'knowledge of' language, and
- (ii) the concept of 'memory' is elevated to being identified with cognition as a whole where any act of cognition is the retrieval of structure from memory and this structure is assumed to be the logical ones postulated by Case Grammar;
- (iii) from this it follows that within 'memory/consciousness' there

is a particular structure and it was not until Anderson and Bower's Human Associative Memory (1973), proposing as it did a model based upon case grammatical propositions in long-term memory, that this structure could be talked about in terms 'representation', 'process' and 'system'.

Human Associative Memory (H.A.M.) established the proposition as a permanent feature of cognitive psychology and as the basic unit of semantic networks which were used to represent the interrelations among concepts, actions and events. It was from this basis that Anderson and Bower (1973) tried to answer the main problem faced by cognitive psychology:

"the most fundamental problem confronting cognitive psychology today is how to represent theoretically the knowledge that a person has : what are the primitive symbols or concepts, how are they related, how are they to be concatenated and constructed into larger knowledge structures and how is this 'information file' to be accessed, searched and utilised in solving the mundane problems of daily life?".
(p.151)

'Knowledge of' now became 'representation of' and it was possible to develop models of the form of this representation, its storage, the mechanisms for retrieval, recognition and connections with other representations. It became clear then that what is stored in memory/ consciousness is not so much a static structure but a system that changes, adapts and reacts given the problems facing it.

(iv) the difficult problem of the form of visual representation and its relations with linguistic representation is largely unsettled; Anderson and Bower (1973) consider that long term memory can

contain visual propositions or 'non-linguistic' information but, as Kintsch (1974) points out, the state of the art is such that little is known about the form of non-linguistic information while, because of the state of linguistics, a lot is known about linguistic information.

Kintsch (1974), therefore, defines the proposition as such:

"A proposition is a k-tuple of word concepts, one serving as a predicator and the other as arguments. Word concepts are abstract entities (and) words are used to express words concepts verbally.... propositions represent ideas.... thinking occurs at the propositional level; language is the expression of thought." (p.5)

It can be seen that the notion of the proposition includes the case grammar plus the assumption that this is where thought processes take place; ideas are best represented in propositional form. But it is also clear that Kintsch considers it possible that thought could be pre-language; 'language is the expression of thought'.

There is a clear avoidance of the alternative idea of identifying language and thought and he would rather, along with most other psychologists working in what I shall call the Propositional Representationalist tradition take the position that the debate about thought and language is not settled and that a two level approach is the most useful at the moment; that is thought is propositional and language a tool of expression.

2.4.4 The Work of the Propositional-Representationalists (P-R's)

In this section it will be argued that the P-R's hit upon what is essentially a fruitful linguistic heuristic but that the way they went about answering those questions concerning memory- thought left them blind to the social psychological implications of it.

What happened was that the P-R's used traditional data bases, that is data gathered within the Stimulus-Response school of non-cognitive psychology, in order to answer questions that were about cognition and representation of meaning.

Anderson (1976) is perhaps the best person to present the view for traditional behavioural data as necessary:

"Any theory which does not ultimately address temporal features has little hope for dealing with problems of intelligence ..." (p.19)

"... in free recall concern frequently is on what is recalled and the order of recall, but not on the time to recall or to how the amount of recall depends upon study time." (p.19)

So the representation of meaning, semantic studies that is, are investigated in terms of quantity; 'time' and 'amount'. There is an explicit identification between speed and intelligence and any question of the quality of what one says or does seems to be dominated by the time it takes to say or do it. To be faster is to be more intelligent and, therefore, time factors are essential to cognitive studies; any model of cognition must be empirically tested vis a vis time.

But is it speed that matters when cognitive processes are studied? If we change the criteria from quantity to quality then intelligence falls out of the equation (at last!) and intelligibility takes its place. After all, the central notion of cognitive studies is 'understanding' and the 'fact' that someone takes longer than another to understand has nothing to do with cognition rather, what has to do with cognition is the quality of this understanding : how to represent and locate it. Because Proust took a lifetime to write about memory and Anderson, a short time in comparison, is the latter more intelligent than the former? Is it not the case that Anderson has different materials to work with (computers) and a different social psychological context from which to work which, therefore, produces a different quality of understanding than that of Proust's?

In any case the notion of speed, manifested in reaction times, conceals (or reveals) the main problem with those workers who, armed with case grammar, wished to get 'into' meaning and away from T.G.'s syntactical conception of it. They remain fixed to two fundamental ideas:

- (i) that the human is an animal reacting to stimuli, and
- (ii) that 'true science' deals with 'facts'; measurable ones.

In fact, Anderson seems caught in a contradiction. On the one hand he puts forward the idea that any ultimate knowledge of cognitive processes is impossible simply because a particular model could be imitated by a completely different one (1976, p.5). On the other hand, he

prescribes data from sources falling within the quantitative behavioural tradition as the only material worth inferring from. It seems to me difficult to hold these two points of views as a cognitive psychologist and the only way out of the contradiction is to become a behaviourist.

When we turn to the question of 'understanding' the work of Kintsch (1974) who is 'squarely anti-behaviourist' (p.5) is an interesting example of what sticking to such traditional data means. One of his measures was the inference latency, where the syntactical complexity of a paragraph relating a simple story is related to speed of inference. Kintsch (1974) found that experimental subjects took the same time to make inferences (of a YES/NO type) independent of the syntactical complexity of the paragraph. The time to read the paragraphs in the experiment varied with prediction; i.e. it takes longer to read a syntactically complex paragraph. However, the inference times were practically the same, no matter what the complexity. The conclusion drawn by Kintsch is that information stored in memory is independent of its linguistic (syntactical) expression and dependent upon a proportional representation of ideas.

What this implies is that 'reading' is inputting information and storing it in some form so that it can be worked on for some task, e.g. making inferences. This completely misses the active nature of reading characterising cognition as 'recording' rather than rendering intelligible. Kintsch (1974) admits in the experiment that his subjects could produce different meanings within the experimental context but he says:

"It is not necessary to assume that all subjects represent information in the same form; certainly, the meanings that individual subjects extract from the input paragraph will not always be exactly the same. The experimental hypothesis is merely that the simple and complex versions of each paragraph share the same meaning and that what is stored in memory is a representation of that common meaning..."
(p.108) (my emphasis)

What does he mean here? He says that those meanings that the subjects get from the text (paragraph) will vary (quite correct) and then he says that the common meaning (put there by the experimenter) will be represented by all subjects.

This turns out to be incorrect if one looks at the percentage of correct inferences as a guide; there were some errors in the inferring process. Are these subjects bad at inferring? Or have they 'read' the paragraphs and the experimental situation badly? Two points can be made here:

- (i) the reading process is a process of imagination which takes place as the reading happens, during the encoding. By relying on temporal variables the experimenters confine themselves and their subjects to a paradigm which involves a decomposition beyond that which needs to be explained and this is the nature of the activity of reading or 'making sense'. This is never going to be rendered intelligible by measuring speed of inference and accuracy of what seems more like deduction than inference. What is happening in fact is an intelligence test and so we come back to Anderson where intelligence is defined as a function of speed.

But once again speed has little to do with that imaginative activity of reading, the making over of structured content, which

depends upon more complicated factors than speed of inference as I have tried to show above. In other words, the historical consciousness that a subject brings to an experiment of the above type is eliminated by the method as, in fact, it has always been eliminated in traditional psychological experimentation.

- (ii) there is within the above cited paragraph a fundamental contradiction. The experimenters do not assume common representation but they do assume common meaning. One is left to wonder about the usefulness of case-type propositions for representing ideas. The whole idea of a proposition is that it represents the univocal, semantic relationships that exist, in this instance, in the experimental paragraph; they are in this sense basic. To say that subjects will represent them in different ways is to lose this idea, in that, common meaning does not coincide with common representation⁽⁹⁾.

The conclusion that one must draw from the work of the P-R's is that they found themselves saddled with the belief in a form of data that belongs to a different type of psychology which answers different questions. They then took this methodological foundation and married it to a linguistic heuristic dealing with meaning. The outcome was that they were forced to adopt a 'passive image' of man and leave out any notion of a developing social cognition and imagination in context

(9) A way out of this would be to admit the polysemy of signs. But this is ruled out in two ways:

- (i) their method postulates a common meaning, and
- (ii) any linguistic notions like connotation and denotation seem to be outside their paradigm.

which, (to use Gibson) hunts for 'intelligibility' and which has nothing to do with 'intelligence', a concept that is necessary given the emphasis on temporal data.

A major theoretical point that can be made here is that there is a historical link between syntax and time studies; how fast can you transform from surface to deep structure is an implicit question that guides this work. It seems very clear now that what Kintsch means by 'language is the expression of thought' is that syntax is the expression of thought.

Once again the tradition of linguistics that sparked cognitive/semantic studies imprisons psychologists such as Kintsch and the rest of the P-R's while the alternative 'semiological' conception of language is simply not considered, a tradition in which language is identified with thought. Furthermore, the reliance on reaction times does not allow consideration of the points made about reading in Section 2.2. This is because this method does not allow one to stay at the level of meaning at all.

In the next section I will show that a decomposition to an 'intermediate' level produces results that are not only an improvement on the work in previous sections but are much more adequate than the work of the P-R's mentioned here.

2.4.5 The Use of Case Grammar in the Thesis

I have tried to show that the use of propositions as defined by the case grammar and taken over by the psychologists in studies of cognition and comprehension fail primarily because of the level of decomposition their data forces on them. I would like to argue that the case proposition (and especially the notation that will be used here) will lead to a fuller understanding of what the child reader is faced with and this will be accomplished through an analysis that reveals the 'dramatic' structure of the text (Greimas and Propp) by a decomposition that is not so deep in that it stays at the level of signification. Studies in comprehension will not succeed by a theoretical reduction to 'innate categories' (cf. Fillmore, 1968) or a methodological reduction to 'temporal features' (cf. Anderson (1976) and Kintsch (1974)).

In this thesis Case Propositions represent a language for systematizing the inter-relationships of words : it is another 'stimulant for perception' to understand a sentence and, as will be shown, large groups of connected sentences, i.e. a text. The 'intermediate' decomposition so effected has certain effects:

- (i) The text is made to 'slow down'. It is one of the most important methodological axioms of cognitive psychology that the object of study is cognised too quickly for adequate analysis; cognitive processes are fast. In the past the object of study was slowed down to assess the cognitive process by using relatively simple 'story paragraphs' which contained a rather

torpid logical structure to which inferences of a Yes/No type were made. The slowing down that the intermediate decomposition allows is one that will actually tell us about the action of the object of cognition as well as the act of cognition. It will allow the full complexity of a 'naturally' occurring cultural artefact (i.e. a fairy tale as opposed to an artificial paragraph in an experiment in cognitive psychology) written for reasons that must lie outside 'experimental' psychology.

- (ii) The decomposition proposed will provide a notation that, in a real sense, structures the text for the researcher.

In 1971 Norman and Lindsay published Human Information Processing: and Introduction to Psychology, in which they created a notation using case grammar to represent an event as a series of propositions inter-connected and held together by 'case' vectors. Thus, the simple proposition: "Dorothy loves Toto" is represented like this:

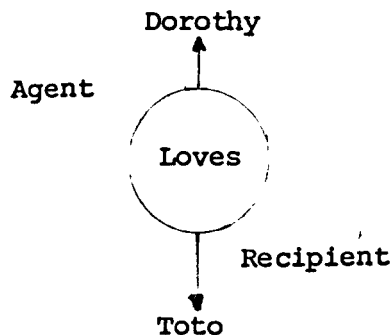

Figure 2.4 : Case Proposition

where the circle is the verb or predicator; Dorothy is the agent of the verb and Toto is the recipient of the action. The arrows are the vectors. Also the nouns in question can be elaborated if needed by attributes which are connected by lines, so:

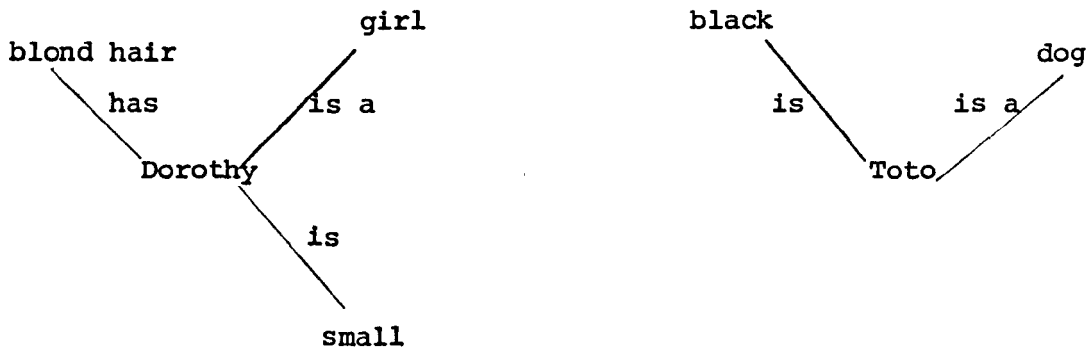

Figure 2.5 : Attributes

However, for an event a way is needed of expanding propositions. To this end the authors provide the 'purpose' case vector; so for the proposition : 'Dorothy went yesterday to the Emerald City to see the Wizard':

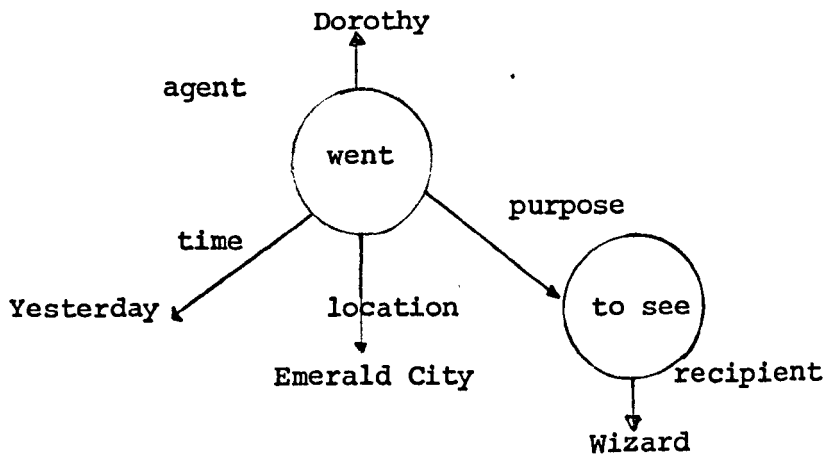

Figure 2.6 : A 'Case Event'

Figure 2.6 represents a more complicated proposition and in a sense it can be called an event where an action takes place at a certain time for a certain reason. But this is really where the use of case stops and the further problem of developing case diagrams so that they handle several complicated and interconnect events is left by the authors of Human Information Processing to another date. The next section of this thesis, however, presents a case analysis of the whole of The Wizard which is depicted in a diagram called the Case-Gram.

2.5 Case Analysis of the Text of the Wizard of Oz

Appendix C is the analysis of the whole story. It was felt at the time the diagram was constructed to draw the whole story so that a comparison could be made with the original 'affecteme-sentence' decomposition in order to see if it missed, because of its summary nature, important points.

This section presents a description of how the case-gram should be read, the conventions adopted and why the case-gram is considered to be an intermediate analysis. The subsequent sections discuss inferences that can be made from the analysis as it relates to the text and Victoria's reconstruction of it.

2.5.2 How to Read a Case-Gram

Generally, it can be seen from the case-gram (in Appendix C) that the text is a narrative system of signs is born out; all case-grams of narratives will be linear and this is not just because of the conventions adopted but also because of the text's nature. The case-gram

has an underlying grid which is used to refer to parts of it that will be discussed below, all references will, therefore, be indexed according to this grid.

2.5.2 Conventions : The Verb and Its Adverb

The verb in this analysis is written into the circle and its tense is kept as it is in the story. This decision is part of the rationale of an intermediate analysis; one could reduce each verb in the story to a 'tenseless' form and add a 'tense' vector, for example, the verb 'to go' could have the tense arrow, 'past', which would mean 'went'. Such a decomposition would be unnecessary and cumbersome. The use of 'went' is economical and its meaning is readily 'readable'; a further decomposition adds nothing to the analysis except a pedantic grammatical point.

Also in the circle is the adverb. Given the reasons against splitting affect and cognition presented in Section 2.3 the splitting of the adverb from the verb is no longer possible and as a result it cannot be done in the case-gram.

This solution also leads to some useful results for the case-gram. For example, the problem of negatives is handled by including within the verb-circle the adverb 'not'; this removes the cumbersome use of an 'absent' vector with a positive verb to convey a negative proposition. Also temporal adverbs such as 'when' or 'then' can be handled in the circle and this is considered a good solution for reasons of economy and ease of reading.

The verb circle is also useful for containing prepositions. So, for example, in B.16 in the case-gram the verb 'chops' contains the preposition 'off'. One alternative solution would be to leave 'off' out of the analysis and assume that it is understood given the other cases, the axe, the heads, etc. But the intermediate analysis considers 'off' to be significant and inseparable from the verb and so it is included in the circle. Sometimes, however, it is necessary to leave the preposition with the noun. Thus, for example, in C 16 'heads of' is the way the analysis conveys possession where, once again, a separate 'belongs to' vector would confuse rather than clarify the dramatic relationships among words. Sometimes, the preposition is included in the circle with the adverb so, for example, at B 22, 'turns purple with anger' is contained in the circle where 'purple' and 'with anger' both describe the verb 'turns'; a further breakdown of the 'verb-complex' would be to lose what is significant only as a whole expression. Generally, in the case-gram phrases of more than two words are not broken down if they are idiomatic or their decomposition would remove their dramatic significance with other words in the text (see, for example, C 25 and the dialogue in C 34).

It is also true that very often, in order to keep to the conventions of the case-gram, the original text has to be translated. This has happened for example in columns 10 and 11 where the conditional statement by the Wizard is translated into a form which is much more laborious than a simple conditional sentence. The outcome of this is that the dramatic relationships between the words seem to be enhanced

rather than passed over by a logical formula; the case-gram in this instance by its sheer density conveys to the reader the complexity of the problem that has been laid at the door of Dorothy and her friends.

There is a special verb circle that occurs over and over again in The Wizard's case-gram and this is the infinitive circle that is connected by the 'purpose' vector and sometimes by the 'object' vector. Infinitives are kept within the verb circle because they usually refer to intended actions and often take cases, especially, 'receiver'.

Compound sentences are handled by the 'and' sign (◇) and 'but' sign (□). Certain vectors, like 'agent' of action, are not repeated if the agent is the same in the second verb, see for example B 9 where the group agree to two things; 'to untie' and 'to visit', where 'visit' does not have an 'agency' vector.

Graphically, the verb circle is divided into a top, bottom and sides. The top and bottom are reserved for particular cases and the sides are reserved for vectors that connect propositions in the narrative. So the model verb is:

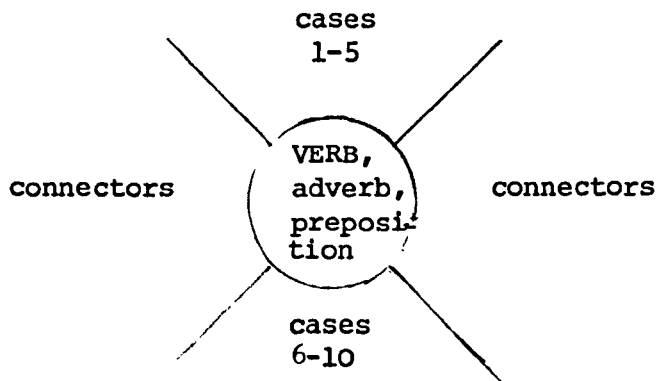

Fig. 2-7 : The Verb's Conventions

2.5.3 The Cases : The Top Section of the Verb Circle

The four cases reserved for the top section are generally human with the complicated exception of Instrument, they are as follows:

- (i) Agent : this case is self-explanatory, a verb usually has someone as its actor and this is especially true in the narrative form. There are, of course, verbs where ascribing agency to a noun demand some difficult reasoning. For example, it can be seen that at B 5 the verb 'meets' has an agency vector linking it to Dorothy. But it is not at all clear that Dorothy is the real agent of the verb; quite often meetings are accidental and we could easily say that the 'real' agent of the meeting in B 5 is the author, Frank Baum. But one assumes that for the reader it is Dorothy who is 'doing'. It is she who is the fundamental 'agent' of the story and, if this assumption is accepted, then she should be designated the agent of the verb.
- (ii) Recipient : this case designates the person upon whom the action has some effect. So, for example, in column 4 it can be seen that the Wicked Witch of the East is the recipient of the 'coming to rest' of the house. She is also the recipient of 'kills' at B 5. Being 'affected' by the verb is perhaps too weak in this example but it nevertheless gives the dramatic relationships that hold between the words.
- (iii) Donator : B 5 also contains the verb 'gives' and from Propp we

know that this is best handled as a special type of agent in fairy tales called the Donator.

- (iv) Instrument : actions are often carried out with instruments and these can be functional within the narrative. Sometimes, as in A 10, an argument can be made for characters being 'instruments' so the instruments of the Wizard's desires are the four characters that make up the group.

2.5.4.1 Cases : Bottom Section of the Verb Circle

There are 6 cases in this section:

- (1) Objects : this case refers to the object that is affected by the verb. This is simple enough but very often it is necessary to represent the fact that an object belongs to someone and this is done, as I mentioned above, with the use of the preposition 'of'. Another alternative to this would be to depict, for example, at A 15, the wolves as:

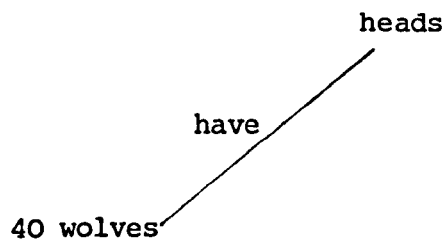

Figure 2.8 : An Alternative to A 15

but they also have claws, teeth, tails etc. The dramatic and,

therefore, significant thing about the wolves is their heads which are being chopped off and, as a consequence, the object plus the possessive preposition are given a primary place in the case-gram. It must always be remembered that the purpose of the case-gram is to dramatise in diagrammatic form what is there in front of the child; the fact that wolves have claws etc. is obviously important, as is their killer instinct, but this belongs to a much larger dramatic structure that is not presented in the story. This is another characteristic of the intermediate analysis of the text and that is to depict what is 'given' as opposed to what could be inferred, for example, about attributes of Wolves.

As mentioned above, an 'object' can also be an infinitive. Looking at 'to kill' in C 12 it seems clear that it is the object of the resolution at B 12. On the otherhand, it could be called the purpose of the resolution; but this would miss its function as something decided upon by the lion. An 'object' can sometimes be a phrase as at C 14 where 'permission to enter the West' is retained without case decomposition because a further decomposition would be confusing and it would also miss the didactic point about 'asking before entering'.

- (ii) Location : actions happen in space and thus it is essential to provide for this case in a narrative. Destination has been subsumed under Location for in all cases the verb and prepositions employed distinguish between the two.

- (iii) Time : actions also happen in time. Time, as a case, is handled in two ways. First, the tense of verbs is kept in the circle as was mentioned above. Secondly, time becomes dramatically important especially in the Fairy Tale genre; for example, 'once' and other fairy tale beginnings. For this a case vector is used for time because of its obvious dramatic function.
- (iv) Purpose : one of the most important logical relations of the verb is the purpose for which it was carried out. The purpose vector always links a verb to an infinitive. The assumption underlying this is that behaviour is goal directed and that this is reflected in our language. The implications for the case-gram are that the infinitive can take other cases like 'object' and 'recipient'.
- (v) Content : most of the dialogue in the story has been transposed into propositions suitable for analysis but some dialogue would suffer if it were changed to suit the method. For example, 'good is more powerful than the power of evil' seems intuitively wrong to decompose; its meaning is readily clear and its dramatic function as the 'content' of a speech act is adequately conveyed by its position vis a vis the verb 'says', B 34.

Sometimes dialogue is quite impossible to decompose and yet it has a dramatic function, for example, 'epe-epe' etc. at C 28. Therefore, for both these examples a 'content' vector seems the best solution.

(vi) Therefore : this is a vector that deals with part of the difficult question of simultaneity in the case-gram. If we consider for example B & C 35, the action of the winged monkeys simultaneously releases them from the witch's power over them. The reason for this is to be found well before (in C 27) and the case-gram indicates this by referencing the coordinate that justifies their freedom from the witch. The ending of the witch's power here is a logical consequence that is simultaneous with an action and this fact of the narrative is represented in the case-gram by the 'Therefore' (th) vector.

2.5.4.2 The Connectors of the Verb Circle

The side sections of each verb circle are reserved for vectors that link propositions. Linkages are effected from circle to circle. The implications of these connectors are important for the narrative as a whole.

Connectors are of two main types:

- (a) The first and least prominent are the 'because' connectors. There are very few examples of this vector in the fairy tale. C 34 provides an illustration of how it works; the catch phrase 'good is more powerful etc.' is the reason why the monkey dare not harm the little girl; it is the reason that the action of harming is not being carried out. 'Because' connectors work retrospectively; this can also be seen at C 13. These connectors differ from 'purpose' cases in the same way that explicit reasons for doing or not doing something differ from implicit intentions.

In the former, circles are connected linearly because of a reason in the past and in the latter circles are connected contemporaneously in that the intention of an action is assumed to coincide with the action. So, for example, at B & C 7 the kissing of Dorothy is intended to protect her from the contemporaneous dangers on the road to the Wizard.

- (b) The second type of connector is the 'result' vector. These 'move' the narrative from left to right. 'Results' that are the outcome of more than one proposition are depicted as emerging from a bracket that encloses these propositions, see for example column 28. The 'putting on' of the cap is a result of the series of propositions that precede the action and because it is not just one proposition but a complex proposition with no less than three circles then the case-gram signifies their relationship with the bracket. This convention shows that a series of propositions, sometimes but not always logically related, have one result.

However, most are the outcome of single propositions. The classification of these 'results' is an important part of the analysis of the text. This is because of their linking function and, as a consequence, we must consider the structure of the story as a whole with the integration of affect into what can be called a 'text grammar'.

2.6 The Higher Order Stimulus : A Grammar of the Text

This section shows what the analysis of the case-gram explained above says about the organisation of The Wizard. It will become clear though that a discussion of this 'text grammar' necessarily involves a discussion of the content of the story and, as a consequence, the functional relationship between structure and content will receive a new dimension.

2.6.1 Grammatical Units : Transitions

The case-gram reveals two major transitions within the narrative. The first comes right after the introduction (a special type of transition to be discussed below) and its general function seems to be to send the reader away on a trip along with the main character in order to get out of what are extraordinary circumstances and back to normal circumstances; in this particular case from a magical land to her home in Kansas.

The first transition is marked on the case-gram from the meeting of the good witch of the North to the verb circle 'sets off for' or from B 5 to B 8. The point is that the vectors actually show this section to be different from the preceding section and it is up to the reader of the case-gram to decide whether this difference makes a difference.

Looking specifically at the vectors it can be seen that there are more of them than in the first section. Their patterning is more complicated, the circles are stuck together; vectors are viscous. The section is also well delimited from B 5 where there is a complication with the witches

to B 8 where the verb complex has two Vectors leading back and in a sense 'containing' the transition and foreshadowing the next.

This relatively complex structure contains a content that can be summed up as 'informative' where quite a lot is taken for granted in the reader. In addition, several open-ended paths are started here which inevitably hold out the possibility of completion.

The transition depends in the first instance upon fairy tale conventions, i.e. the relative status of Wizards and Witches, the power of kisses and shoes. All this is taken for granted by the text. It is in this transition also that Dorothy is sent on her way but not without the surety of succeeding. It is the function of this transition to take the reader on the perilous journey and at the same time hold out the prospect of a good outcome.

It is here that the relationship between the affect signified in the text and linguistic structure becomes apparent. The case-gram shows that the transition makes the original affect model more intelligible. For this unit internally holds a tension between Fear, which is bound up with dangerous roads and the need for the protective kiss and the 'other side of fear' (that which I called 'Security') which is tied ultimately to the girl's safety-after all : could she possibly fail with that kiss on her forehead? The transition keeps both affects alive through its internal structure and the nature of the content that is

structured⁽¹⁰⁾.

But this transition is also structured externally vis a vis the next transition. For the second transition (B 8 to B 12) seems very much to be the anti-thesis of important ideas in the first. This is especially true of the denial of the group's and, importantly, Dorothy's wishes. But just like the first transition, the second is not all bad for she is allowed to have friends to help her on her way.

Structurally the second transition is more complicated than the first. This is because it contains the transposed conditional sentence and, as mentioned above, the case-gram reflects the problem to be solved.

Functionally, the second transition repeats the first by sending the heroine on a trip and once again the verb circle 'sets off' is the border of the transition.

A general function of both transitions is to get the characters from one situation to another. But, at the same time, they figure in the affect structure of the story and together both affect and transitions have a 'literary' function. Their integration plays a necessary role in the 'reading' of the story in that a delicate balance of opposing affect is sustained, both internally and externally, in order that the

(10) Of course, it is true that the importance to the child of the content is only obvious when we come to the reading or the tale's reception. For the formalist this content would be variable but for this analysis it is invariant in that it is relevant to the child's choice of story - something that is relevant cannot be variable and certainly the desire for the dog has always been her desire.

reader does not become too frightened to go on reading. So, although her second transition is weighted more towards Fear than the first, the blow to Dorothy of not going home and hence to Security is softened by the previous arrival of the friends and the ultimate plausibility of going to the West is proposed.

The overall impression given by the placement of these two transitions and their internal and external structure is that they act to seduce the reader into reading : Dorothy will not die (given the axiom of identification this would be a terrible trick to play on the reader) but then again she will have a perilous journey.... so we must read on to find out how she will survive.

Connected to this is a 'logical' function of the transitions given certain fairy tale premises; both leave little escape for the reader from the train of the story. Transition one forces the heroine to visit the Wizard - logically there is no other way to get home. Transition two with its conditional sentence also poses just one happy alternative. In summary, it is the intra and inter structure of these two units that allows them to be read by the reader who has made the necessary identification, and, indeed, who is led, by these very units, to follow the heroine on her trips. These units show very clearly the affect structure of this part of the tale but,, in addition, they are superior to the binary analysis in that they allow us to see how the binary affect is married to the higher order structure of this part of the story where these transitions balance the need for Security and Fear of uncertainty and at the same time fulfil the literary function of allowing the reader to go on.

2.6.2 The Introduction

This unit is introduced here after the transitions which follow it in the text because it is itself a transition. Using Fairy Tale conventions like 'once' the introduction transfers the reader from real life to magical life. There is an invitation to suspend the testing of reality.

It also sets the problem for which transitions one and two indicate the direction of the solution. Hence all three transitions are structurally related to one another. The progression between them is one of increasingly negative (but judiciously balanced) affect : just how this progression of the narrative is carried out will be tackled in the next section.

2.6.3 Results

'Results' are those parts of the text grammar that link the units together. Initially, there seemed to be three types of results:

- (i) logical results; given the premises of the preceding propositions.
- (ii) creative results; these are confusing in that they seem to come from the author for no preceding logical reasons.
- (iii) cultural results; these are dependent on cultural norms.

The supreme example of a cultural result is the Witch's attack on the group because she got angry that they did not ask permission to enter the West.

An example of a logical result is the already mentioned use of the cap to call the winged monkeys.

But the creative results present a great difficult. For example, at B 26 the result of the Witch's thinking is 'determination'. But she could just as easily have given up. Is this result a creative result, something that the author invents or is it a cultural result, where, given similar circumstances in real life, the particular cultural norm is to become determined? If the latter formulation is accepted, then the notion of creative results is redundant and is replaced by the values inherent in the language that the author must use. Consider, for example, column 29 where the air is suddenly filled with the winged monkeys and is black. Far from this being a creative stroke 'black air or skies' refers to the ominous in our culture; the blotting out of lights, or the sun which carries with it a rich heritage of eclipses and, finally, darkness. The point is very important at this stage of the thesis. The actual productive creativity of the author as it is revealed in the case-gram's slowing down of the text is displaced by the structure of the language itself. To be sure, this structure passes through the author, but only in so far as he has a vocabulary that is structured for him.

We can say then that there really are only two types of results: logical, given the premises, and cultural, which are results in the language anyway.

Results can also be contrasted in terms of Explicitness-Implicitness.

Most logical results are the outcome of an explicit type of reasoning, i.e. premises are stated and consequences follow. Cultural results are either explicit or implicit. An explicit Cultural result is the above-mentioned attack on the group for not asking permission which is a strong cultural norm in Western society and it should now be clear why it was left un-decomposed in the intermediate analysis. An implicit Cultural result is the above-mentioned 'black sky' example which depends on the 'hidden' structure of the language.

Explicit cultural results are the 'because' connectors mentioned above. It is interesting to note that the two 'because' vectors that occur at C 14 and 34 are solely concerned with moral dictums. The implicit cultural results are not stated didactic points at all but rather seem to be the result of language.

2.6.4 The Episode

Results are omnipresent; they link within and between units and as a consequence they are also found in episode units. There are three episodes in the story.

The major episode is the attempt to destroy the group of 4 who are now labelled 'strangers'. The case-gram reveals that this unit is structured in an almost circular way because of the repetitions and the consequent uniformity of direction of the vectors; the witch is almost always the primary agent while the group are the receivers. The case-gram shows the episode to be tied up with the witch's increasing anger but it also reveals, through its absence, a lack of

emotion on the part of the group; they go quickly and efficiently about dispatching the attackers. So, the episode can be seen, through the case-gram, to be clearly structured, in its action, around the attacking agency of the witch and the defensiveness of the group; the structure is one of Attack/Defence. But it is also clear that affectively the episode is structured around anger versus no emotion at all (at least until B 27 when it becomes clear that the witch has a powerful weapon in reserve) on the part of the group.

The image of this episode is of an increasingly red-necked witch countered by a sort of 'cool determination'. It is here that we can see a unique attribute of the episode; it is structured dialectically within itself; both at the affect and action levels. Moreover, these two levels are functionally related; the witch's anger is part and parcel of her attacking.

At a further level of abstraction this episode can be represented as Emotion(+) vs. Emotion(-). But Episode two, which starts with the calling of the Monkeys, is structured around determination versus fear, or: Emotion(-) vs. Emotion(+); that is Dorothy is afraid.

The message here seems to be : those who keep their heads will succeed as indeed the group does in the first episode and the witch does in the second where she suddenly takes the other side of the affective opposition i.e. Emotion(-). Struck by her failure she adopts the minus side and becomes determined, she thinks hard (no emotion here) and

plays her trump card. Her success depends upon the relationship of episode two to one; it is an inversion of the first. Hence, this structure generates a message whereas the structuring of the transitions was more concerned with getting the reader involved and taking a lot for granted.

But this first part of Episode two puts the author in somewhat of a predicament in that the witch has succeeded (as she in fact has to) and yet no harm can come to Dorothy. This contradiction is mediated supernaturally by the kiss which now becomes an extremely important signifier for the narrative.

By adopting the 'right' attitude, from the point of view of the last episode, the witch solves her problem. By adopting the other term of the opposition, i.e. emotion(+), Dorothy does not succeed, but then she could not in terms of the last episode. The only way out of this is to institute a fairy tale convention to resolve the problem and this is what the author does. This result has two functions:

- (i) it allows the pointed didactic message that good is more powerful than evil, and
- (ii) it allows the story to proceed in a literary sense. After all, without the kiss at this juncture the story would have to stop!

The third episode, to which the story now continues, is also structured

dialectically but this time around Dorothy's magic shows. On the one hand there is the witch's DESIRE to have them so that she can become all powerful. On the other hand there is the heroine's DESIRE to have them so that she can solve the original problem of how to get back to Kansas.

There is here then a simple opposition. Superficially, both desires are positive in the sense that, if realised they would rectify a lack for the desired, but culturally they receive opposite signs. The witch's lack of the shoes motivates her greed; Dorothy's lack of the shoes generates a desire which is good, so the opposition is, Desire(-) vs. Desire (+) and this is resolved by ANGER. It is Dorothy's anger at being tricked out of the shoes that kills the witch; she melts into a brown puddle. But earlier, episode one's message was that emotion (+) did not work. This episode says the opposite; that the desire of excess when opposed to the desire of the natural (to be free and go home) is mediated by a spontaneous, unthinking, fairly harmless action of throwing water at someone in anger. Here, excess and greed are defeated by righteous indignation.

In the first episode the witch is angry (righteously) because of a cultural faux-pas; the group did not ask permission to enter; in the third episode the faux-pas committed is much greater - greed and excess all manifested in trickery and theft is a far more serious cultural infringement than not asking permission to enter. So the result fits

the crime; death by melting. Dorothy is both the agent and the instrument; emotionally she is the agent but the real killer is the cultural code and in this sense Dorothy is but an instrument of the American way of life in such situations.

The point is that episodes are structured on two (at least) inter-related levels; the 'action' of the story and the 'affect' of the story. The case-gram shows that from the Introduction to the beginning of episode one a simple binary affect is in operation and its effect is primarily 'seductive' although problems are set and events foreshadowed (e.g. the importance of the shoes and the kiss). But the case-gram also shows that the episode is structured differently and has a different function; it is didactic; sometimes bluntly so ('good is more powerful' etc.,) but usually obliquely so, the instillation of the cultural code through the action of the heroine whom, the reader is seduced into 'travelling' with.

Schematically the episodic part of the story is:

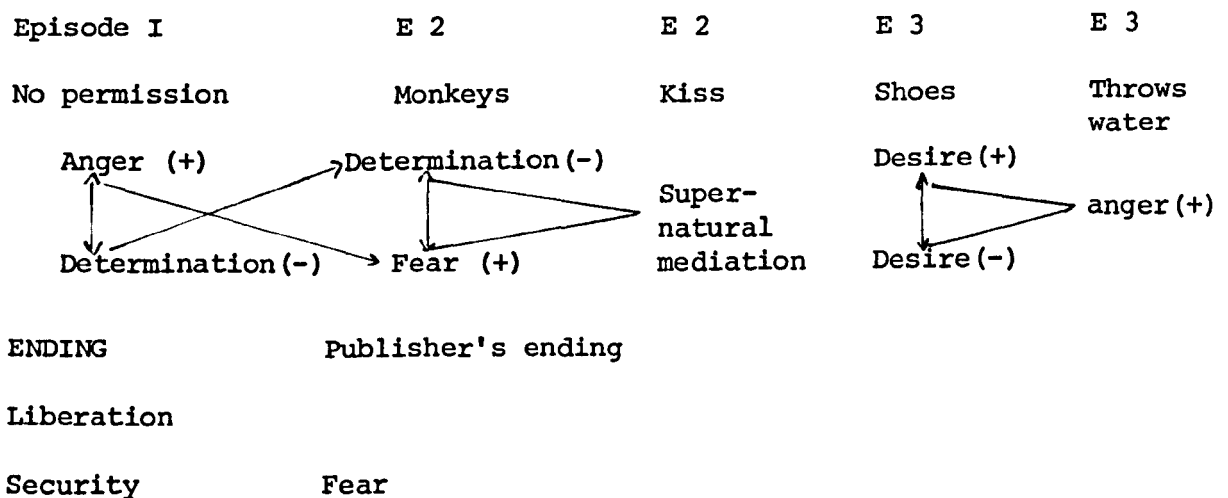

Figure 2.8 : Diagram of Episodes

This figure shows that the second half of the text is structured on various levels; the grammatical; the actional; the affective; in addition it shows that the episodes 'move' through the use of various devices; inversion (E 1 to E 2); the use of another part of the story (the return of the kiss and shoes); resolution on the affect level (E 3 - from desire to the throwing of water). From the case-gram we know that the basis for this movement are the results.

In summary it can be seen that this part of the text has both a vertical and a horizontal dimension and that through various devices the text facilitates progression to an ending. At the same time we have seen that because of its structure of particular content the text creates the possibility of meaning - conveys a message; and in fact depending upon the areas in which the story is relevant to the reader, more than one message is possible.

2.6.5 The Ending

The last grammatical unit is the ending which the case-gram shows to be linear, a lot like the introduction, but is marked with a logical result, the reuniting of the friends. But whereas one would expect the logical result of getting back to Kansas (the original problem after all) this particular version contains a publisher's ending, already discussed above, where the possibility of yet more adventures is kept open and, even though the reuniting is logical, its effect, in terms of the case-gram, is to situate the characters and the reader back at the end of the transitions and at the beginning of the episodes.

In fact where the 'real' story begins; the seduction to read already having taken place.

2.6.6 Summary

The technique and notation of case grammar has produced a model of the structure of the text which reveals the dramatic organisation of signifiers and their integration into a text grammar.

It has also shown that the structure is vertical, containing 4 levels including an affect level, and horizontal including various ways that the story progresses.

It has shown that the original binary heuristic was right in its estimation of the affect structure of the first part of the tale but not really powerful enough for the second. Also the binary heuristic did not indicate the functional relationship between 'transitions' and affect and the subsequent literary effect of this relationship.

The second part of the tale when submitted to the case-gram is seen to be didactic with a message potential made possible by a multi-layered and dialectical structure.

2.7 AFFECTEMES, THE CASE-GRAM AND THE TEXT'S RECEPTION

There is the question of the original decomposition of the story into sentences and their respective affect and whether or not this summarising of the story adequately covers the points brought out

by the fuller case analysis. In Appendix D the case-gram of the affecteme sentences is presented and, although it is a reduced and slimmed-down version of the fuller case-gram, it has the same structural and contentual organisation as the full version, because the sentence decomposition outlined the basic action of the story; a fairy tale is about dramatic action and, given no significant actions are omitted in the summary, then the case-gram should reveal a similar dramatic structure, which it does.

2.7.1 Victoria's Version

We can now return to the problem of reading that was started above. What does the case analysis reveal about the process of reading, given what is already known about the informant's solution?

Appendix E presents the case-gram of the informant's version of the story. This contains a new case which is called 'elaboration' and it is used in order to capture the fact that during her version the informant comments on the action. The elaboration happens in A 5. Additions are given their appropriate case in the proposition in which they occur.

2.7.2 The Version's Grammar

From the paradigm Figure 2.2 it should be possible to proceed to analyse the version as the text was analysed.

2.7.3 The Introduction

Now that the nature of the introduction is understood to be that of a special transition, the analysis can start here.

Like the rest of the story the introduction is condensed. But although it is obviously important as a grammatical unit in the text in the reconstruction it seems to have a heightened importance shown by these points:

- (i) an inference at B 1 which explains why the girl did not escape the wind (although just how the house went up in the air is obliquely referred to by the 'funny ground'). This is important for her because of the significance of the addition of the larder into the story.
- (ii) the use of 'girl' instead of Dorothy which is a point that Bettelheim makes and which reinforces the notion of namelessness permitting the possibility of identification.
- (iii) the introduction, as a transition, should contain fairy tale vocabulary which gets the reader from one situation, her real life, to another, her fantasy life. The version, however, begins with an action, the ground going all funny. But at the same time it is the only section of the reconstruction that contains added explanations and this seems to be because of the transitory nature of the unit. The reader is forced to explain to herself what is happening and at the same time the 'larder', as we have seen', is the important link between OZ and her world. This makes

the introduction very important and the case-gram shows us this from its complexity.

From the point of view of 'reading' as a 'making' sense of structure and content within a context the introduction is vital for it provides the reader with the chance to keep a foot, as it were, in both worlds and, therefore, allows the reader to make the text intelligible and this is manifested in both the content and the structure of the introduction.

When the text's case-gram is compared with the version's at the introduction level, although one is shorter than the other, it is also clear that a certain density of vectors is common to both. In terms of content there is the already mentioned 'larder' addition but also the addition of the 'bedroom' which is a replacement for 'house'. The fact that a 'tornado' is the instrument of the transition is not mentioned, neither is the fact that she has landed in a magic country. It seems that her re-construction is a relentless attempt to stay on the ground. This is because, I would argue, of the 'fear' that this fairy tale has been shown to exploit and which is now seen to affect the reader's re-construction. Consider, for example, that at the end of the introduction (at the beginning of B 3) she has the wrong witch killed off, see A 3. It is as if the fear of what is going to happen is continually reduced either by omission, substitution and importantly by 'real' world inference.

2.7.4 The Transitions

Once again a tremendous amount has been condensed here. The first transition is marked only by the Kiss which is so vital later on in the story. Again, any mention of the dangers of the road are left out and only 'safe' things put in. Structurally, there is little to say for the first transition it is but a proposition, however the importance of the content, the 'good' kiss has not been overlooked.

The second transition, that of the denial of her wishes, is left out along with her companions. Structurally, transition two is a complex proposition containing a 'because' vector that indicates that Victoria is aware of the problem facing the heroine. In both, the heroine is referred to by personal pronouns, never as a particular little girl named Dorothy.

Once again, affectively, these units are more on the side of Security than Fear; Victoria is still constructing 'fear' out of the story.

2.7.5 The Episodes

This situation cannot last for long, however, yet the complexity of the episodes is almost completely omitted. Certainly a lot of the repetition is left out. Structurally, there is a compound proposition and it is unclear from it whether the reader understands that it is the monkeys that 'get' the girl. The content of the first episode deals only with the Winkies and the monkeys and the episodic part of the version ends with the 'soaking' of the bad witch who is there in the story thanks to an elaboration.

The general impression is once again of getting the girl out of trouble as soon as possible; the reader has to reconstruct some negative affect, some conflict; but this is kept to a minimum. The winkies proved to be cowards and the monkeys are kept because they are a narrative necessity. Interestingly enough, although the kiss is part of the version, it does not return in the episodic section. A comparison with the fuller analysis shows that the importance of the increasingly angry witch to the episodes is omitted; also omitted is the moral punch line; and so too is the episode about desire and the subtle didactic nature of it.

2.7.6 Ending

This unit shares with the introduction a significant distortion. The reader has inserted a fairy tale ending but from the analysis above of the introduction this is to be expected for it was difficult enough for the reader to travel with Dorothy; she in fact had to 'bring along the larder' together with the subsequent associations to her friend and the security provided by her friend's dog Flora. The happy ending and going back home are part and parcel of the unique way the reader has rendered this story intelligible, i.e. read it. It is the only way she could make sense out of the 'girl's' predicament and that is by seeing it in the light of her own predicament.

Structurally, the ending is a simple series of three propositions and it has little of the complications of the fuller analysis.

2.7.7 Results

When we look at the results that link the propositions it is obvious that the condensation that overshadows all other considerations makes the classification of results very difficult. There are, for example, few logical results; this is because a set of propositions is hardly ever built up. The only place where this happens is in the introduction when she hides in her bedroom etc., and this is duly marked as a 'because' vector. Also things that go up in the air must come down and this logical result is in the version.

It is probably an instance of a cultural result that the girl lives happily ever after at the end of the story; after all, she 'finds her way back home'. But it may be also true that the ending is the result of the reader's desire to close off awareness of negative affect that has so marked the rest of her version.

Generally though the 'results' aspect of Victoria's version is difficult to understand; they could be categorised as 'ad hoc' which, given the idea of 'results' would be a contradiction. On the other hand, they may be simply private and the task of tracing her associations better left to child psycho-analysis.

2.7.8 The Illustrations

Throughout the reconstruction Victoria referred to the text's illustrations which can also be analysed from a case grammar perspective. For the most part they seem to be simply comments on the text

and, although they undoubtedly have a part to play as cues to recall, I would argue that they do not significantly affect the reading. So, for the most part, the illustrations are commentary upon the events of the story. There are 11 illustrations and I will go through them using, as I have said, essentially the same analysis as the text and relate them to the text.

Illustration 1:

This depicts Dorothy standing in her house; the house is really very much in line with the notion that she is poor - it is really a one-room shack. Dorothy is waiting in the doorway for the 'big wind' which is approaching from her left and about to reach a tumble-down barn; in case terms she is the intended Receiver of the wind. The scenery is bleak.

Illustration 2:

This depicts the wicked witch of the East, crushed by the house of illustration 1. It shows this house containing a bed and outside it Dorothy and the dog Toto. There is an interesting relationship between the shoes of the crushed witch and Dorothy's and, of course, this will become important later on. Dorothy is seen here talking to the good witch of the North who is surrounded by fat, jolly types and everyone has bells hanging from the brims of their pointed hats. The agent here is clearly the witch and the illustrator has her with turned up palms which simply adds 'colour' to the proposition that she will not be able to go with the little girl to see the Wizard.

Illustration 3:

This shows the witch kissing Dorothy, an extremely important point for the narrative; Toto is looking faithfully on; Dorothy still has her plimsolls because it is after the kiss that she puts the silver shoes on.

Illustration 4:

This shows Dorothy's first encounter with one of her companions; she is sitting on a fence with her silver shoes. The dog Toto is leaning with his front paws up on the fence below Dorothy. Either the scarecrow is winking at Dorothy or he only has one eye; it is difficult to tell. In any case this is pure commentary.

Illustration 5:

This shows the encounter between the woodman made of tin and the black bees after the others had hidden in the scarecrow's straw.

Illustration 6:

This depicts the lion facing the winkies. The lion is seen here as enormous in proportion compared to the army he is facing - simply a commentary upon how they could be scared of him.

Illustration 7:

This depicts the witch in her magic cap instructing the flying monkeys. The witch significantly has an umbrella. Once again it is hard to see any other significance in this than as a commentary on the text.

Illustration 8:

This depicts the episode where the witch has tricked Dorothy out of her shoe; we can also see very clearly the mark of the kiss which is strongly associated to the mark of Cain; one wonders whether it is Frank Baum or the illustrator that makes, from my point of view, this 'cultural' slip. In any case this illustration is again a commentary rather than an addition to the action of the text.

Illustration 9:

The witch is melting and it depicts Dorothy, pail in hand, after throwing water on her. It is doubtful whether or not the illustrator has captured Dorothy's 'sorrow' at melting the witch.

Illustration 10:

Dorothy, eyes closed, sweeping up the mess of the melted witch and the mark of the kiss is very clear. So is the fact that she has the other shoe on. This illustration is somewhat different from the others in that the illustrator takes a liberty with the text and shows Dorothy cleaning up; the story itself does not intend this. It is after all quite irrelevant to the narrative. It could be that the illustrator had to have a scene in which Dorothy recovered the other shoe but more to the point is the idea that either the publishers are filling up space or they were moralising about cleaning up. In any case this does not help the reader or the text.

Illustration 11:

The final scene of the happy four plus Toto; the text tells the reader to buy another book to find out how they are all reunited (among other

things) and the illustrator shows it. This is not such a contradiction in that, from the point of view of the reader wanting another book about Dorothy and Toto, it is probably best to foreshadow the reunion without spelling it out. This is another addition on the part of the publishers and has a lot to do with the 'publisher's' ending.

2.8 Discussion : Summary and Overview

The first discussion in 2.2.5 analysed the preliminary work of the chapter in terms of its linguistic aspects, its affect aspect, reading aspects and the concept of 'primary signifier'. From this discussion certain problems arose which led to another type of analysis being undertaken. Linguistically it was felt that, although the binary heuristic provided a valuable and coherent explanation of text and reading, it was weak on the pattern of signifiers in the structure (the larger structure) of the text, the child's obvious competence to tell well formulated stories and the rather important fact that the text was a narrative and not a single signifier.

The whole concept of affect within the story - the affecteme - was seen to be tied up intimately with the need for another linguistic heuristic. But for the sake of clarity the elaboration of this heuristic and the integration of affect in it was done in two sections with the second part eventually integrating the first.

The new heuristic revealed the existence of a macro structure of both the text and its reconstruction and it was possible to say various

things not only about narratives and ~~re~~constructions but also about the particular story under consideration.

This second discussion section will follow the general categories of the first; those solutions to the problems of the first discussion section will be analysed and the problems that arise and still remain will be clarified. Finally, points will be made that direct the thesis to the final chapter which hopes to tie up through an analysis of another fairy tale outstanding problems.

2.8.1 In Linguistics

The need for a knowledge of the higher order structure of the text has resulted in the text grammar. Furthermore, the primary linguistic dimensions are reflected in the grammar; the horizontal, which includes how the text progresses and the vertical which shows that the text is also composed of a series of levels. However, the exact way that these levels are related remains a mystery in the analysis and although, on the horizontal dimension, certain 'transformations' such as inversion, supernatural and affective mediations and the more general reliance on the two types of 'results' have been discovered, their functional relationship to the vertical dimension is also at this moment unclear.

When the problem of the patterning of the signifiers in the text is considered, it can be said that it is because of the case-gram's ability to uncover, at the intermediate level, the dramatic relationships that holds between these signifiers that the text grammar is possible.

The original notion was that the reading of the text generated the idea that certain signifiers were more important than others, the Primary Signifiers. But what the case-gram shows is that within the text itself there are certain 'primary signifiers' which play vital roles in the text grammar. One only has to recall the importance of the 'kiss' and the 'shoes' for the episodic section of the story to realise this fact. It seems clear that one of the main strengths of the intermediate case analysis is that it now becomes possible to understand the text outside its reception by a reader; given, of course, the fact that the intermediate analysis is also a reading but one that is based in the structure of language.

This leads to the next point and that is that this method, more than the binary method, allows one to see in a fuller way just what the child is faced with. It was stated above that, although Bettelheim (1978) produces coherent 'readings' of stories, there is no reason to believe that these are what the child is faced with and, because of this, it is only legitimate to state that the text is a narrative system of signs. It is by applying a linguistic heuristic, in the first instance, that this problem of what the child is reading can start to be answered.

But a narrative system of signs, (indeed any semiotic system) must be based in conventions and communicate a message or messages. How has the heuristic accounted for this requirement?

First, it has been shown that the story is split into two parts: the transitions and the Episodes (including the ending(s)). Second, these

two parts can be said to be communicating messages. The transitions with their various functions seem to be saying to the reader important things such as what type of story she is about to read; its structure; its likely outcome; the need to suspend the testing of reality and the problems that will have to be faced. The Episodes are more obviously caught up with a communicating function; there are pointed didactic messages and more 'subtle' messages.

Both parts of the story are complex structures based in the conventions of the case-grammar but it is clear that in both parts of the story the messages that are communicated depend upon something more than the text grammar. There was a hint of this in the analysis of the 'results' where it was seen that the prospect of a creative result, *sui generis*, was impossible and, in fact, the actual meanings that the story allowed, its range of meanings, was dependent upon the structure of the language that the author was forced to use. Furthermore, the story is brought to a climax through a cultural code and how it is related to text and language must also be important.

Thus, a major problem arises at this point in the thesis and that is the relationship between the text grammar based in case analysis and the text's signification based in the structure of language itself. In taking this further, the next chapter attempts a rapprochement between text grammar and semiotics.

2.8.2 On Affect

Looking at the textual analysis there are good grounds for inferring that the affect level is inseparable both functionally and structurally from the other aspects of the grammar. The question of how they are related in the text remains, as mentioned in the previous section, to be discovered. Nevertheless, it is clear that affect-signifieds in the story are essential to the grammar, in all its aspects.

However, the status of the affect opposition in the text is not all that definite. It has been seen that the first part of the story, in the form of the grammatical units called transitions, are based in the affect-signifieds that the binary heuristic revealed. The second part is more complicated; other emotions are involved and the text becomes more obviously a semiotic system. But, can it be said that the twin affects, Fear and Security, have disappeared? This would be quite wrong for the events that do happen can certainly be accounted for by the original model and in fact 'Fear' returns quite forcibly when Dorothy is confronted by the flying monkeys. A solution to this is to say that the text's second part is 'underwritten' by the affect-signifieds of the first part. Over these generalised affects are laid more particular affects (e.g. Desire + or -).

This conclusion fits in well with the discussion in Section 2.3 where it was stated that developmentally the relationship between 'feeling state' and cognitive processes eventually coincides with a need to fulfil a wish for security through certain relationships with objects

that have proved successful in the past. If this is indeed a general wish or need, then it seems to be reasonable that the text is underwritten with it and even more reasonable that the first part presents a judicious balance of the two for a 'literary effect'.

2.8.3 Reading

It is, however, when the problem of the representation is considered that the ideas about the relationship between text grammar, affect, signification and range of meanings come together.

The discussion 2.2.4 proposed that reading was an active process where 'frames of reference' made sense out of the structure and content of the text. It will be recalled that three 'readings' were proposed; the first was based upon the religious way of looking at things; the second upon a socio-historic frame of reference and the third was Victoria's own reading. It was further pointed out that the first two were different from the third because of the level of abstraction at which they took place, and from this it was proposed that the third was both idiosyncratic (private) in its framework and public (in that the desire for a pet is a common fact of development).

Does the case-gram analysis of the reconstruction help in any way our understanding of what meaning the text has for Victoria?

The case-gram has told us quite a bit about the child's competence to tell stories and revealed as well the child's need to avoid the

negative affect in the story but it is the original solution to the data of the re-presentation, especially the personal associations that were elicited, that provides the answer as to why the child is reading The Wizard and the meaning that she gets out of it, namely the significance of a relationship between a girl and her dog; more accurately Victoria and her lack of a dog.

This supports the view that reading is a motivated and selective re-presentation of the range of signification available in the text; the informant has naturalised and personalised the text given her predicaments and context. Victoria's desire for a dog in her real life is satisfied momentarily by a fantasy dog within a story structure that reflects an emotional opposition (security vs. fear or non-security) she continually has to contend with. The dog is a way of mediating this developmental fact of the child's life. It is with her particular reading that the idea of an underwritten generalised affect is important in this thesis for Victoria seems to ignore the more complicated and semiotic second part of the story.

There is, of course, no way of telling whether the messages that are so abundant in the second part of the text 'get through' to the reader. But it is not unreasonable to suppose that in order to get her dog, on the imaginary plane, the reader has to swallow a lot of other things as well and, furthermore, it is equally reasonable to assume that this structure that seems avoided may be stored away and used when the circumstances are right for it.

Within the particular story under consideration the second part seems very much caught up with a 'cultural code'; how do we behave in society, and especially American society. This comes face to face with a child's desire for a pet, given her context. Is it not impossible that the text presents social messages about how to behave written over and somehow using a deep-seated affective contradiction to put these messages across?

Given the establishment of identification between reader and heroine, who has a dog, the case-gram informs us that the reader wants very little to do with the Fear side of the contradiction but she cannot have her cake and eat it if she wants to get the dog in this story; she needs, for example, the terrible flying monkeys and the 'horrid' witch. Her resolution of the narrative - bringing Dorothy back to Kansas - can only be temporary; the reader will have to read the story again and this increases the chances of more and more of the cultural code being assimilated.

The point is that, far from the fairy tale being an example of what the Formalists called Ostranenie, making strange of perceptions that have become taken for granted, it makes certain ways of behaving natural in the sense that they are the proper way to do things. It is here where the socialising nature of the text can be seen; reading fairy tales is the attempted subversion of desires by the cultural code : one's desires start to be structured by the text in much the same way that one's first 'feeling states' become part of cognition.

This can be put another way : the reader is Dorothy and she feels 'good' or secure having the dog but in the progression of the narrative she enters role relationships (i.e. languages) which are 'bad' and the reader tries to minimalise these bad relationships, hence the cosy narrative that is there construction. But, over and above this primary emotion, she must go through the episodes with Dorothy and it is here where she learns how to conduct herself given the emotions that the story is talking about. Dorothy enters into relationships with objects, she plays certain roles, and it is how Dorothy actually handles these relationships which is important. Put another way, it is how Dorothy and the dog are patterned in the story that is important, hence the case-gram.

Again it is impossible to know whether the informant has assimilated this structuring of emotion; all one can do is to point to the idea that a constant re-reading of the same text in order to get an imaginary dog which mediates primary feelings must have other effects than simply satisfying (momentarily) her desire for a pet which, because it only offers a mediation of the contradiction and not a resolution eventually does no more than force the child back to the text.

Once back at the text she can get her dog but also whatever else is there for the grasping. The case-gram analysis shows that a further investigation of the text and language structure is needed to allow us to understand how the text functions to allow the possibility of the reader getting a range of messages from it.

An important point is the unique solution that Victoria has found to her contradiction. Not only this but the unique way she has told the story to the researcher. Although it seems clear that there is a 'struggle' between the cultural code and desire it is also evident that the idiosyncratic, personal way of seeing or what was called above 'frame of reference' is manifested in all aspects of the work concerning the text's reception by the reader. And although the pet, for example, is undoubtedly a 'social' mediation of the primary contradiction, the way the informant actually 'fills in' those gaps she finds in the narrative (for example the 'larder' and the story around it) is unique to her - there cannot be many children, desperate for a pet, whose imaginations run to exactly this content.

All that it is possible to say about this is that this is where the reader is at this particular moment faced with her problems. She is at a particular place in her chains of associations and investing the text with a meaning from that place.

The next chapter will have as one of its goals the description of the relationship between the text and how it directs the child reader to particular chains of association or, put another way, to particular significations.

CHAPTER 3

BEAUTY AND THE BEAST

THE CONSPIRACY OF THE TEXT

Chapter 3

Beauty and the Beast : The Conspiracy of the Text

"The story is experienced". Bruno Bettelheim

3.0 OVERVIEW

This chapter starts with a skeletal description of a model of the text which incorporates the ideas of chapter two and also tries to answer the important questions found there concerning the function of the text in the reading process. The story of Beauty and the Beast is then placed upon the skeletal description to flesh the model out. By doing this, the shape of the model will change in the face of implications and contradictions that arise and this will lead to a deepening of the model and, I hope, to a demonstration of its richness and value as a contribution to the study of texts and the psychological process of reading.

In both the description and the story sections particular attention will be paid to the 'results' level of the model (cf. Chapter 2) and to a new level, the Semiosis level, which attempts to handle the problem of the relationship of the text to language and society. This section contains a detailed discussion on the meaning of the word 'code' within Semiotics.

The next section deals with my second informant's re-presentation of her favourite fairy tale and it shows how the model applies to it. The final section is given over to what it means to read.

3.1 The Text

My informant is named Melissa, aged eight with a younger brother. She goes to the same school as Victoria. Most of her background will come out in the section dealing with her re-presentation. Her favourite fairy tale is Beauty and the Beast which was in an anthology of other fairy tales; Beauty and the Beast is contained in Appendix F.

3.1.2 The Analysis of the Text : Introduction

The text receives the same treatment as The Wizard of Oz in Chapter 2. There is an initial decomposition into sets of sentences in terms of signification of affect, these are in turn subjected to the intermediate case analysis but instead of producing a case-gram of the decomposition the experience gained in Chapter 2 allows one to see quite clearly the basic units and their implications without going through the process of drawing the story out. Instead a new model of the text is produced whose shape demonstrates the structure and dynamic of the text in a more intelligible way and is also more easily carried out.

The model's mediation of the various problems posed in Chapter 2 is accomplished, in the main, by the use of a new level of signification that formalizes in a clear way the loose ends left there concerning the didactic function of the tale. The analysis also produces a more formal explanation of the 'results' by offering a categorisation of them and through this a clearer statement of their role in the coherence of the text's structure and eventually in the process of reading.

Table 3.1 shows how the text comprises seven levels. The top level is

the set of sentences and I will try to show through the other levels how these sets of sentences constitute units of reading distinguished from other units because of the other levels. For this reason I have called these sets of sentences Signifying Units (S.U.'s) at the appropriate levels.

3.1.3 A Description of the Vertical Dimension

(A) Grammatical Unit Level

This unit is familiar from the work of Chapter 2. The case analysis of Beauty and the Beast reveals large segments of the story, named in Chapter 2, the text's grammar; i.e. the text depends upon this level in a formal way.

The analysis shows a new grammatical unit that of the EVENT. The qualities of this and the other units will be discussed when they appear in the flesh in 3.2.

(B) The Level of Affect-Signified

Each signifying unit is differentiated from other S.U.'s by the affect that is signified. The importance of this level from both a theoretical and methodological perspective cannot be over-stressed.

Theoretically it is important that affect can be seen to be structured within the text. This not only follows from Bettelheim's work but also from the research into cognitive theories of emotion.

Methodologically, an S.U. gets its status as an S.U. because it signifies a particular affect. Although the initial decomposition is centered around the affect-signified this does not mean that the final differentiation is decided upon because of the affect. It is the function of the case analysis to reveal the dramatic structure which allows one to ascertain the real basis for difference. In most cases, it will be seen that an S.U. gets its status because of the affect that it signifies; on the other hand there are certain points in the narrative where affect does not have such a privileged place as a differentiator (see S.U.'s 18 and 19). The affect signified remains, however, the original, intuitively based access into the text's structure; the case analysis clarifies the intuition.

The affects that are represented in the model of Beauty and the Beast are again those discussed in Section 2.3; Security/Insecurity. The ultimate signified of these signs is the recognition or affirmation of one's self or the other. But these affects can take several forms and their structure can be of two types. In the first place the type of affect one is dealing with can be quite specific; say, insecurity because of fear. In the second place we could be dealing with a 'constellation' of affect where several sub-affects make up the insecurity or security; so, for example, the Security found in the Introduction to the story is made up of material and psychological factors.

One of the formal properties of the model is that each level can be seen as integrating the level that is above it. This concept of integration comes from linguistics and specifically as it was formulated by

Benveniste (1971). Each level of language integrates the next higher level in the sense that the lower unit enters and completes the higher level. The meaning of a unit is its capacity to integrate higher units. The form of a unit is its composition in terms of lower level units.

From the point of view of the two levels discussed so far, i.e. the Grammatical Unit and the Affect Signified, the latter's meaning within the organisation of the model is its capacity to constitute the grammatical level which is the next highest level. How this actually works will be shown when the text under consideration is added to the model.

(B) The Level of 'Results'

This level assumed a vital place in Chapter 2. There it was necessary for the movement of the narrative; it was also the basis for the coherence of the story. Because of this, it is that level of the text where an important interface with the reader takes place. Here, I hope to show that the Results level obeys the recomposition rule of integration but that it has a privileged place in relation to the 'socialising' level of signification. The model to be presented demonstrates that the "Results" section can be categorised in such a way as to indicate clearly how this important level functions both in the text and in the process of reading. Chapter two posed only two results: logical and cultural⁽¹⁾. The present model uncovers a more important binary classification which incorporates the logical and cultural and gives to the Results section its important function vis a vis the reader, the structure of the text and the structure of language.

(1) The explicit cultural result or 'reason' does not appear in the text of Beauty and the Beast but it does in the re-construction where it will be discussed.

The two classifications are:

(1) Internal Results:

These are propositions or parts of propositions whose coherence relies on something that has already taken place in the text. If we are told, for example, a character in a story is 'stupid' and some time later he is involved in a stupid action, then the action is coherent given the previous proposition.

(2) External Results:

These are propositions whose coherence is given by the experience of the reader. The reader is asked to fill in the gap in intelligibility that the text has not answered or has not as yet answered.

In theory, Internal results can have 5 modes of operation:

- (i) repetition : where an identical action happens at two points in the story.
- (ii) similarity : where actions are linked by a particular theme they have in common. This theme will refer to another level, usually the affect signified, in the model.
- (iii) inversion : where coherence owes its existence to an inverted action that happened previously.
- (iv) completion : where an earlier, unfinished action is completed later on.
- (v) factual : an action can receive coherence because of facts stated earlier in the text.

The external results can have three modes of operation:

- (i) the inter-textual : where a proposition is coherent because of other stories. (In this sense the structuralist would say that the text is a network of other texts, c.f. Figure 2.2 and Section 2.2.4).
- (ii) the 'natural' : these propositions are coherent because of "scientific beliefs" about the natural world - what goes up must come down.
- (iii) the cultural : where the reader is referred to 'ways of doing' in her environment; facts of the cultural world.

From the point of view of the reading, external results require more effort than internal results which only require a memory of the previous propositions in the story.

Internal results operate upon a horizontal dimension : they are contiguously related on a dimension that linguists would call the syntagmatic. External results operate upon a vertical dimension. The reader is asked to look for similar examples in her experience. This is what the linguist would call the paradigmatic dimension.

It is here at the level of the external result that tearing the text away from its reception is most difficult; once again, can the text exist in the absence of a reading? I hope to show from my reading that, although this level is the level of interface between reader and text, and thus vital to the process of reading, it is also something that

belongs to the text itself and must exist before the reading.

(D) The Level of the Proposition

Integrating the results level is the level of the proposition. A proposition is defined by its dramatic structure as revealed by the case analysis. For the analysis a proposition simply has to be; it is the ultimate foundation for any signification at all.

We can ascertain 5 types of dramatic structure categorised at this level:

- (i) descriptive : where a scene or situation is described.
- (ii) factual : where an action or series of actions are stated for the reader's information.
- (iii) action : where an episode in the story takes place.
- (iv) anticipatory : where action is anticipated.
- (v) conditional : where a character sets conditions.

(E) Level of Signifiers

Propositions are integrated by signifiers. In chapter two we saw that certain signifiers were important to the reader, e.g. the dog TOTO. It is clear that we cannot know in advance what will or will not constitute a primary signifier for the reader. However, within the text itself there will be signifiers which are vital in two ways:

- (i) those signifiers that are important to the structure of the narrative, that allow it to be a narrative I shall call 'key' signifiers.

- (ii) those that are important for the highest level of significance to be discussed presently I shall call 'primary'.

Key signifiers will receive a (+) notation and primary signifiers will receive a (*) notation. All signifiers will get a case value attached to them. Although the intermediate case analysis of Chapter 2 remains intact there are certain changes and conventions that the reader will have to know about. These are:

- (i) Verbs are grouped at the end of the list of signifiers and it is this grouping that gives the clue to the type of dramatic structure of the S.U. Each verb has attached to it its adverb.
- (ii) Verb forms whose infinitives are 'to be' or 'to have' have been left out. This is for economy of presentation and also because the concepts of 'being' and 'having' are relatively self-evident from the cases that signifiers take around them. To this end the case of a person who 'has' or 'is' I have labelled agent (A); I am aware that this raises philosophical problems; 'is one the agent of one's being etc.' I simply make the assumption that this is so. Furthermore, this is also my stance for emotions, if you become angry, 'you' I label the agent. (See the discussion on cognitive theories of emotion).
- (iii) the case notion of possession is handled by attribute (att).
- (iv) prepositions are kept with their verbs except 'if' which I have left to take care of itself. A further more atomistic decompos-

ition would take me beyond that which we need to know in order to read the story. To this end conditional 'if.....then' type S.U.'s have received a translation, see S.U.8 for example.

- (v) There is a new case of Comparison (Comp) found at S.U.24. This arises because it contains a similie that is dramatically important.

For the most part a description of the signifiers is redundant but where necessary I will point out the importance of a particular case value. Those signifiers that are primary relate to the next level of the model.

(F) The Level of Semiosis

By semiosis I mean that meanings are articulated for the reader; are offered to the reader as possible, to a greater or lesser extent, constructions of reality. Semiosis is then opposed to mimesis; it is not an imitation of the reader's world but a particular set of articulations of it.

I intend to discuss the rationale and operation of this level below (Section 3.1.3) but here I want to indicate that it is a mediation of the, at times, complicated and 'unintegrated' analysis of the didactive section of the Wizard. It takes over generally the role of signifying social psychological meanings (what I have called set of or ranges of meanings) to the reader.

I intend now to explain the structure and function of the last level of the text, that of the Semiosis. After this is done I will place the

story into the model. Putting flesh onto the bones of the model will make it change shape in certain ways and I will discuss these as I go along.

3.1.3 The Level of Semiosis : the S-level

In this section I want to explain the sixth level of the model because it is new to the argument presented so far. I will rely very much upon the theories of such semioticians as Barthes (1977) and Eco (1977). My main aim will be to demonstrate how it is possible for the fairy tale to constitute a reader's feelings; how in fact the child reader comes to articulate the ineffable through reading the story.

This level invites the reader to think about what is happening in the story and her life and, although it is obviously necessary to consider this function, as it is organised in the text itself, I will attempt to give a foundation for it taken from Semiotics and then re-insert this argument back into the model when the actual text is analysed.

3.1.3.1 Semiotics : the sign, message, code and signification

It will be recalled that semiotics is concerned first and foremost with the nature of the linguistic sign. This is because, although its subject matter can be any system of communication based upon convention, the linguistic system is the 'paradigm' system. For Saussure, the sign is an arbitrary relationship between the signifier and the signified.

The meaning of a sign is twofold:

- (i) its signification, the act of correlating the signifier with the signified, and
- (ii) its value vis à vis the other signs that form its context in the langue.

I mentioned above that researchers took either one of two aspects of the sign into their work; they either studied the organisation of the signifier or the organisation of the signified.

The study of the organisation of the signifier is more accessible than the study of the signified because of its materiality; the linguistic spoken sign has 'sonority'. I have shown, however, what the outcome of this was : a universal signified⁽²⁾.

The study of the organisation of the content on the other hand presents logical problems from the outset. One cannot isolate the content because it needs a signifying system to get round in; it needs a material vehicle⁽³⁾.

For Roland Barthes (1973) before speech the signifier is nothing more than 'an undefined mass of concepts which could be compared to a huge jelly fish, with uncertain articulations and contours.' (p.118). It seems clear that the 'act' or 'process' whereby the signifier is correl-

(2) According to Hjelmslev (1961) Saussure must have realised that that artificial separation of the expression from the content was meaningless (p.50).

(3) This is also pre-figured in Saussure and best brought out by Lacan (1966) who shows that the signified 'slides under' the signifier in that we can never grasp it as 'pure' thought but only through the relationship of signifiers, what he calls the chain of signifiers; an idea which the Level of Signifiers in the model attempts to encapsulate.

ated with the signified, i.e. the signification, is the area where semiotic research will be fruitful. It must be remembered, however, that for semioticians at least, this 'act' or 'process' mentioned above does not mean any 'psychologism'. The human being is simply the methodologically necessary element for a semiotics; theoretically the Langue provides meaning. As soon as an act of speech is perceived as a communication, '.... it is already part of the langue', and '...; to separate the langue from speech means ipso facto constituting the problematics of meaning !(Barthes 1977, 16-7)

Because they are interested in communication systems Semioticians find a communications theory framework useful. The most important use is the identification of code/message with langue/parole. This identification happened for the following reasons:

The first reason stems from the work of Benveniste (1971) who shows that what is arbitrary about the sign is its relationship to the referent, the thing in the world. On the other hand, the relationship between the signifier and the signified is said to be necessary; no English speaker has the right to alter these connections in the langue and they are in this sense necessary⁽⁴⁾.

A code is a convention or a rule which correlates the two aspects of the sign in the actual message. They are, therefore, necessary in the sense that Benveniste means.

(4) "Saussure says that 'a language is always a legacy' and that consequently it is, as it were, naturalised".(in Barthes 1977, p.51)

The second reason follows partly from the first : without the notion of a coded message we are unable to account for the fact that the Langue, taken as a whole, contains several discourses such as the culinary, fashionary, scientific etc., which may overlap but for the most part can be said to have 'areas' of the langue to themselves. The notion of Langue is much too amorphous to account for this fact. 'Code' on the other hand gives us the notion of several codes, perhaps overlapping, which organise explicitly messages in different discourses.

The third reason is that, for Semioticians, a code guarantees comprehension outside the person fixed as it is in an explicit rule which generates the message. A cumbersome subjective infinite regression is, therefore, removed from the field of study - the subject only being a methodological necessity. A 'pure' and contemporary statement of this position concerning the code comes from Umberto Eco (1977).

For Eco what correlates the expression (signifier) and the content (signified) is the code. The code apportions the one to the other and the result is not so much a sign but (after Hjelmslev) a sign function:

"A sign function is realised when two functives (expression and content) enter into a mutual correlation; the same functive can also enter into another correlation, thus becoming a different functive and, therefore, giving rise to a new sign function. Thus, signs are the provisional result of coding rules which establish transitory correlations of elements, each of these elements being entitled to enter - under given coded circumstances - into another correlation and thus form a new sign." (p.49)

In other words the correlation of expression to content is regulated by given codes; they are what makes sign functions possible; "a message

is nothing more than such a correspondence realised during a transmission process." (p.54)

The next reason for the identification of langue/parole and code/message is similar in theme to the other two. Saussure (1974) realised, but could not account for, the fact that within the langue there were already formed 'fixed syntagms' such as compound words or strings such as the French "s'il vous plait". In other words, the distinction upon which Semiology was to be built, i.e. langue/parole, was blurred by the concept of 'fixed syntagms', '...there is probably also a whole series of sentences which belong to the language, and which the individual no longer has to combine himself' (Saussure 1975, p.19). Barthes calls these 'stereotypes' and the notion of code here, as an explicit rule sanctioning the sign function, allows semiotics to accept and account for a langue which is more and more 'necessary'.

The final reason is directly related to the practice of semiotics. The idea of a code now allows researchers to concentrate upon the last area of work foreshadowed by Saussure's re-thinking of the sign, that of the process of signification itself. This is that process of the correlation of the expression and the content, the production of a sign function which is made possible by the code. For Eco then a code is 'a system of signification' and the process of signification depends upon this system. The actual occurrence of the sign function in a communication with an interpreting human is a message.

3.1.3.2 Connotation and Denotation

So far I have only talked about that part of the meaning of a sign (now a sign function) conceived of by semioticians as the signification. The other side to the sign's meaning is that of value. It will be recalled that, for Saussure, there are only negative values in the language; that the meaning of a sign is its difference in the system of signs that is the langue. It has already been pointed out, however, that already in the langue there are fixed syntagms. These are concatenations of signs whose organisation is imposed upon the speaker because of a code; 'thank you very much indeed' is a combination of signs whose meaning has been generated by the Courtesy code of English; in a similar vein, 'yours faithfully' at the end of a letter receives its meaning from the letter writing code of English when the name of the addressee is not referred to at the beginning.

If these syntagms were taken at the level of the individual sign they would produce some odd interpretations ('I remain, sir, your humble and obedient servant, etc.,' taken from part manifestations of the code make this rather more clear) and they are really only meaningful as 'texts', already written for the speaker, whose meaning is at a level of signification different from that of the individual signs.

In order to capture this, linguists see two levels of signification: the denotative, the level of the self-contained individual sign and the connotative, a level which uses the first level to convey another meaning.

Eco (1977) says:

"There is a connotative semiotics when there is a semiotics whose expression plane is another semiotics."
(p.55)

At the level of the individual sign, the meaning of 'rose' as a bush and as a sign of passion 'passionified roses' (according to Barthes (1972, p.113) is the difference between denotation and connotation. The following figure makes this clear.

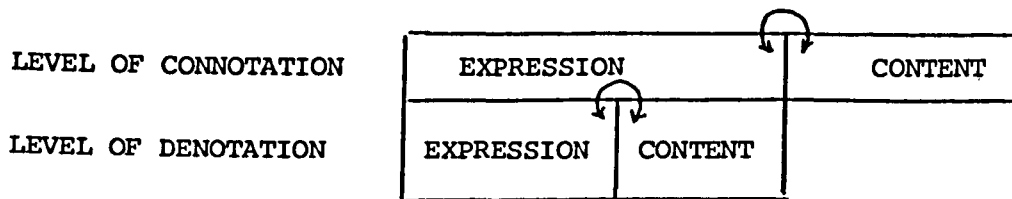

Figure 3.1 : The form of the semiotics of denotation & connotation

↻ = existence of a code

Figure 3.1 shows that, at the denotative level, a particular expression is correlated with a particular content; in the above example we have the expression 'rose' correlated with the content or signified rose. When, however, I takes roses to my mistress what was a sign function on the denotative level becomes, on the connotative level, the expression for another content; in Eco's terms there is another sign function and, therefore, another code. This seems reasonable; there is a code in our society at the present time that sanctions the giving of roses to 'female loved-ones' as a message of one's passion. The roses stand for something else to someone.

This, however, leads to an interesting and continual debate in the semiotics of denotation and connotation⁽⁵⁾. Can there ever be a denotative semiotics in the sense that 'rose' means a particular thing. This notion of a 'referential' denotation is supported by both Barthes (1973) but is contradicted by Eco (1977):

".... even when the referent could be the object named or designated by the expression, when language is used in order to mention something, one must nonetheless maintain that an expression does not, in principle, designate any object, but on the contrary conveys a cultural content."(p.61)

In the example of the 'rose' what is denoted is what we in our culture define as a rose (thing). It seems clear that the signification here is sanctioned by a code which we could call the botanical or horticultural. The meaning of rose has nothing to do with the bush but everything to do with the cultural content or unit that is correlated, through a code, with an expression:

"Every attempt to establish what the referent of a sign is forces us to define the referent in terms of an abstract entity which moreover is only a cultural convention." (p.66)

-
- (5) I am aware that this is not simply a modern semiotic debating point but that it also forms part of the history of philosophy concerned with meaning; the terms used there are extensional and intensional semantics. The first is concerned with the conditions of truth of a particular proposition and the latter with conditions of signification. It should be clear that the notion of codes is caught up with signification, as Eco (1971) says:

"Within the framework of a theory of codes it is unnecessary to resort to the notion of extension, nor to that of possible worlds; the codes, insofar as they are accepted by a society, set up a cultural world which is neither actual nor possible in the ontological sense; its existence is linked to a cultural order, which is the way in which a society thinks..." (p.61)

The same applies to the sign-function 'passionified roses'. Although the meaning is found at the connotative level of signification it is nonetheless organised by a code or system of signification. The example of the rose allows another point to be made; that is that both significations depend upon codes that can be said to be very stable in our society. This is a very important point. The sign at the denotative level is not significant because it refers to some object but because of a stable code that correlates expression with content. On the other hand can we say the same about the connotative level?

According to Barthes (1973) this is impossible; meanings which we consider to be connotative must be understood because of a vaguer more wooly code:

"As for the signified of connotation, its character is at once general, global and diffuse : it is if you like a fragment of ideology.....we might say that ideology is the form...of the signifieds of connotation." (pp 91-92).

In Mythologies (1973) Barthes is looking for an analysis of the signified (content). I pointed out above how this runs into logical problems from the start - a signified needs a signifier. Barthes' (1973) method of getting round this is brilliant but, unfortunately, idiosyncratic. He invents words. New signs are meant to signify 'general, global and diffuse' contents, pieces of ideology:

"China is one thing, the idea which a French petty bourgeois not so long ago had about it is something else again : there can be no other name, for this characteristic mixture of little bells, rickshaws and opium dens, than that of sinity." (p.79)

For Barthes the use of the neologism 'captures' this vague ideological concept or content that the French have of China. But captures for whom? For Barthes and fellow semioticians sinity may capture what the ideology of French petty bourgeois is but is that how the petty bourgeois himself actually goes about interpreting, 'bells, rickshaws and opium dens'? The point here is that the invention of sinity is a meta-language, also outlined by Hjelmslev (1961) in that the plane of the first level of signification (denotation) becomes the content for the expression (in this case 'sinity'); meta-language is the inversion of connotation.

I am concerned with the process whereby connotative messages are conveyed to an interpreting human addressee. In the example of the rose there seems no doubt that both levels of signification are based upon codes and that both codes are stable in society at the present time. Those codes which underlie, as systems of signification, connotative messages Eco calls sub-codes; our passion is regulated by the sub-code which sanctions, in context, the bringing of roses to lovers.

The important, and essentially Saussurean, point being made here is that these codes or sub-codes exist; rules relating expression to content in our society at a particular time, exist.

This may be true for the single sign of the rose. One could reasonably ask how connotation handles syntagms. I mentioned above how certain sentences already exist in the language and that these must be referred to a code for interpretation. This is the question of value and I showed

that the differentiation posed by Saussure was 'necessary'. But, by the same token, it is not only the single sign that can be used at the connotative level, '.....several denoted signs can be grouped together to form a single connotor' (Barthes, 1973, p.91); a connotor being the expression rectangle on the connotation plane of signification in Figure 3.1.

In this way, for example, a single experiment in reinforcement learning can signify Behaviourism at the connotative level. But this level can also be elevated to signify another content, let us say, 'empirical psychology'. It can be seen that someone could go on elevating from here to all sorts of connotative content.

With the introduction of 'someone' interpreting - getting the message - the problem of infinite regression emerges; after all what is there to stop an endless elevation? Stated another way what is the relationship between the codes of the language and thought?

Eco (1977) takes the view that there is a process of, what he calls, unlimited semiosis - infinite regression - the human subject simply being a methodological tool to demonstrate this.

Two points can be made here in favour of the subject as theoretically necessary as well. In the first place, although codes are external to the human subject, they are also created by human subjects and it seems certain any diachronic analysis of codes has to take people into account theoretically; it is only to the extent that there are other people that codes exist. The second point is that the use to which codes are

put is also more than a mere methodological event but of real theoretical importance for the study of reading. Codes, I will argue, constrain the regression by directing readers through particular chains of association. But there are other constraints in the process of reading all of which I will explore in the next section.

I began this further discussion of semiotics with the question of the meaning of a sign being its signification and value within the system of signs called the langue. Semioticians study systems of communication based upon convention and they have tried to use the distinction code/message for several reasons. I think that this identification of langue/parole is useful, but, like langue, code has been elevated to being an independent semiotic construct. They seem to be falling into the same irrelevance as theories of linguistic competence have done and it can only be made relevant by the positioning of the human addressee/addressor into the discourse of the code as a creator and user of it.

3.1.3.3. Constraints on Infinite Regression

There are two major constraints upon the interpreter of the message; one is the text within which the code is situated and the other is the desire of the reader, her interests, the reason why this is her favourite fairy tale.

I intend to show below that the reader will be invited to think about codes in either of two ways. In the first place, the code will be

familiar and used in an accepted manner; in the second, new codes will be presented which, because of their position in the story, could be used to make sense out of certain situations both in the text and in the life of the reader. Generally, there will be an invitation to think about the code, the outcome of which will depend upon the relative stability of the code, its structure in the text, the thought structure of the reader and her desires.

It is at the last level of the text - the S level - where I hope to be able to show these ideas clearly; its function is not to imitate the child's world but to articulate it for her leading her to possible interpretations of her feelings. Codes are, however, external and social and it is in this sense that I see the text as a conspiracy: it allows the reader to think about her feelings in a coded, accepted and social way.

3.1.3.4 Some Definitions in Summary

The reader will need some definitions to understand what follows.

- (1) System of Signification : this refers to the code and exists 'when there is a socially conventionalised possibility of generating sign-functions'. (Eco, 1977, p.4). The Saussurean question of value is contained here because it does not matter whether or not these social conventions correlate one functive (expression) to another functive (content) or if one functive happens to be a whole text which is correlated to, say, a single functive (War and Peace can be said to signify the content literature) as long as

there is a social convention sanctioning the correlation.

- (2) Process of Signification : there is a process of signification when the system of signification allows a sign-function in actual discourse; furthermore, this process of signification must have at least one interpreting human subject. There is a process of signification when someone reads a text, i.e. when the sign functions arouse an interpretive process in the human reader. According to Hjelmslev (1961):

"A priori it would seem to be a generally valid thesis that for every process there is a corresponding system....." (p.9)

In other words there can be no process of signification without the underlying system of signification but, from the preceding discussion, within the development of the human there can be no system without the process.

3.1.3.5 Re-statement of Process of Reading

In the last chapter the general conclusion was that reading is a process of investing a story with meaning by filling perceived gaps in the text and by taking up and fleshing out metaphorical constructions (cf. Lacan and Empson) in the reader's signifying chains. The motivation for all this is the reader's interest or desire to find something out; to find a solution to a problem or set of problems which make this text her favourite. To this end it is possible to say that desire directs her reading but at the same time, given the argument for

codes present above, this desire is directed itself and it, therefore, follows that desire can become social because codes are part of language.

Before the analysis of the text starts, I will list below some of the important codes that the text draws on in the Beauty and the Beast.

- (1) An important code is 'the problem to be solved code'. This holds out the promise that if one reads on there will be more information leading to a resolution. Barthes (1970) termed this the Hermeneutic code and it is based upon the logic of puzzle/solution; question/answer found in the novel. Barthes' code is a way of organising events in a text which are based upon one's experience of other texts and the world; questions are posed and solutions promised, hence the continual participation of the reader. For Barthes (1970):

"The units (that belong to the code) are so many flashes of that something that has been already read, seen, done, lived : the code is the wake of the already" "...A code is one of the voices of which the text is woven." (pp 27-28)

There is a lot here that is similar to my version of codes but it does not account for the process of setting the codes up - the child reader may not have already seen, done, etc. Also his idea of hermeneusis reconstitutes a division between affect and cognition which is no longer tenable; these problems are felt by the child, the question/answer idea seems primarily cognitive and we must remember that the "Hermeneutic code" was constructed around an adult's reading of an adult short story, see Barthes 1970.

It seems better to me to construct this code around the problem solving experience that the child already has lived; the ability to answer questions and what is more important the ability to recognise questions and problems that need, for whatever reason, to be solved. It is safe to do this when dealing with child readers because this is certainly a 'wake' in which they are well established and, if I am to stick to the project of describing what the child is faced with, then it seems clear she is faced with problems to be solved, internally and externally.

Barthes' notion that what the reader is faced with is a voice has a somewhat mystical feeling to it and the distinction between text and reader disappears with it and, indeed, from the semiotician's point of view the disappearance of the reader is not such a great loss to social science anyway. But the idea that what the reader is faced with are problems that are resolvable, through thinking about them brings the reader back into the situation and I think that this alone would justify my use of the problem to be solved code.

- (2) Another code is the father/daughter which associates the vital attributes that daughter and father share : love, affection, caring and worrying about the other.
- (3) Another code is the responsibility code which revolves around the notion of not harming or bringing harm to other human beings.

- (4) The Fairy Tale code is constantly used to inform the reader's reading.

This last code brings up an interesting point about codes and that is their stability. Stable codes are those which label all the key attributes that are subsumed in the code complex. So Daughters/Fathers shares loving, kindness etc. A code which is unstable in our society is one where the metaphors are unlabelled, where only some key attributes are shared⁽⁶⁾.

As the next section proceeds I will show how the text draws on each of these codes; I will also show how it sets up codes as possible ways of thinking about problems and how this is related to the problem to be solved code.

3.2 Beauty and the Beast : The Text and Its Structure

Table 3.1 shows how the levels of the model are related. In this section I want to take each S.U. in turn and describe them all in their vertical and horizontal dimensions as they function within the story. The illustrations function in the same way as in the Wizard. Their analysis is in Appendix H.

3.2.1 The Lure

The text is broadly divisible into two sections: the lure and the lesson. The first section is the lure and it lasts until S.U.16 when the Beast's intentions become clear.

- (6) The terms labelled and unlabelled metaphors comes from Bateson et al. 1956 Double Bind theory of Schizophrenia.

S.U.1 *Once upon a time there lived a rich merchant in a beautiful house with lovely gardens. He had four sons and three daughters of whom the two eldest, Marina and Rosina, were vain and lazy. They liked satin dresses and jewels. The youngest was Beauty: she was industrious, kind and lovely - she was her father's pet.*

Level of Affect-signified : because this is the level where the decomposition starts all the S.U.'s will be analysed from this point. Here, the affects are in opposition : selfishness v. selflessness. On the other hand there is in this S.U. a strong security which underwrites the opposed affects. This security is both affective and material.

Level of Results : according to Benveniste (1971) the form of a unit is its composition in terms of lower units. The level of affect-signified's form is then composed, in part, by the next level below it, the results section. But here, at the very beginning, we run into a problem. It seems clear that we are working within a much larger unit, found also in the Wizard; the introduction. The model is now faced with situating the grammatical units in the 'integrative' structure. Using Benveniste's notion of the form and the meaning of linguistic units, this particular G.U., the introduction, has as its form opposed affects, and an external inter-textual result. But what is its meaning? In other words, what does it integrate? I would like to argue that, as grammatical, it has an overall integrative function in terms of the highest level of the text; the semiosis level. For Benveniste the notion of integration stops at the level of the sentence and starts at the level of distinctive features. This formulation of the grammatical unit (and indeed the whole model of the text) extends the twin notions of form and meaning as they were originally used by Benveniste as regards the sentence. I hope to show in the text that the G.U.'s take on an

important integrative function and I will, therefore, place it between the level of affect-signified and the level of Semiosis.

Level of Grammatical Unit : I have stated above that this introduction has as part of its form an inter-textual result. But its coherence is also found in the culture generally because it is also the result of the reader's existential condition, mainly the desire to read a particular fairy tale or perhaps a result of the command : 'go to your room and read!' By their very nature introductions are also transitions which have to get the reader out of her situation, school or home for example, into another one. This transitional nature of the introduction is the result of a certain fundamental 'way of doing' in society; we read and children read Fairy Tales. We have, therefore, another 'result' which I have termed cultural.

Level of Propositions : the dramatic structure is descriptive.

Level of Signifiers : these integrate the propositions. The case value of these signifiers in S.U.1 contains a lot of attributes i.e. descriptions of characters, places and possessions.

Level of Semiosis : the message proposed at this level is : 'this is a fairy tale'. The form of this level is all the other levels that lie beneath it. By looking closely at it we can see how it operates. It has the ability to use any level it wants to; it can 'dip' into them. So the primariness of 'once upon a time' and its case value is readily understandable in terms of the Fairy Tale code which is 'stable' in our language.

This, however, is not the only level that the S-level uses. The results level is needed because it is taken for granted by the text that this is not the first fairy tale the child has read (how children start to read these stories is another project) it is, therefore, an inter-textual result, a textual introduction which is part of a system of such introductions; 'once' and 'once upon a time' have been read before. So the coherence of the introduction is to be found externally in the inter-textual experience of the reader. The level of affect-signified is also used by the S-level in that fairy tales, according to the code, are about affective themes.

But the importance of the introduction should not be overlooked. It allows the reader 'to read' through the use of established codes. The 'meaning', in Benveniste's terminology, of this Introduction is that it integrates the connotative message, this is a fairy tale; message, because it depends upon a code; connotative, because it 'uses' other levels of signification which are, in fact, other sign functions, (for example : affect-signifieds; 'once upon a time'). In fact we can see how the total S.U.1 is a connotor for this S-level message. Furthermore it is also possible to see how the form of this level is the other levels 'below' it. The signifiers integrate the dramatic structure of the propositions, these integrate the results which in turn integrate the affects signified which go up to make the Introduction; all these levels contribute to the message : 'This is a fairy tale.'

In addition, the complications of S.U.1 have a functional role vis a vis the Lure; S.U.1 must 'grab' the reader and take her from her existential situation into another place; in order to do this it relies on, in the first place, an extremely well constructed and 'integrated' verticality and a very stable code.

S.U.2 *The merchant lost his palace in a fire and his ships in a storm. The family moved into a small cottage. The two vain daughters grumbled about cooking and cleaning and coarse clothes.*

This unit is less complicated vertically but now it is necessary to deal with the concatenation of S.U.'s.

Level of Affect-Signified : there are two affects one of which is in direct opposition to this level in S.U.1 and the other is an insecurity coming from material lack that was part of the previous unit. Insecurity, caused by material lack, is opposed to the security that the merchant provided in the first unit. Selfishness, manifested in the daughters' grumbling, is carried over into this unit.

Generally, the affects of this unit are more straightforward and specific than in the first unit and for this reason it is part of a new grammatical unit.

Level of Grammatical Unit : this unit is called an event because of the specificity of the affect that is signified. An event is not an episode in that it is 'all of a piece'; there is no internal structure and as a consequence there is very little movement. Events state facts and generally give information.

Level of Results : the event in S.U.2 is integrated by the specific affects mentioned above; part of the form of the event and the affect levels is the set of results which integrate them. This set consists of two external and one internal. The first external result deals with the coherence of the destruction of the material well-being and the

second external result deals with the consequences of this destruction. The first external result points to coherence in the inter-textual experience of the reader; fairy tales are never smooth running throughout. The second external result is an example of a 'cultural' result; when you are in a position of material lack you cut down to size. In the present case you take smaller accommodation.

The internal result allows the reader to understand the daughters' grumbling; we know from the introduction that they are capable of this type of behaviour.

Level of Propositions : the overall impression is that information is being stated, a factual structure.

The level of Signifiers : this level integrates these propositions and there is very little agency; it is also important that Beauty does not appear here given the affects⁽⁷⁾.

The level of Semiosis : Once again the primary message here is to do with the fairy tale code : 'sometimes in fairy tales terrible events happen'. It can be seen that once again at this highest level of signification the text is relying upon a stable code to put its message across. The reason for this is that the reader has been asked to do a lot of work in making the story intelligible. So far there has been only one internal and hence easily coherent result. The reader must work hard at the beginning and the tale uses stable codes to 'keep' the reader reading.

(7) The textual and linguistic importance of the absence of certain signifiers is discussed below when the function of 'absence' becomes extremely significant. (See S.U.'s 22 and 26)

This is, of course, part of its narrative necessity in the service of the lure. The text can also, in its concatenation of S.U.'s cross-reference different levels; so the selfishness of the daughters mentioned in S.U.1 at the affect-signified level provides the internal coherence at the level of results in this S.U. This is termed an internal result in the similarity mode; and I think it is not an accident from the point of view of the 'lure' that the text uses once again an extremely stable code and an internal result to 'hook' the reader.

S.U.3 *One year later the merchant hears that one ship is safe.
He prepares to travel to the ship to get the gold yielded
by the cargo.*

The reader has even more support immediately following as the story starts to balance its impact and at the same time progress.

Level of Affect-Signified : the balance is achieved on this level. What is proposed here by way of affect-signified is the 'hope' of security.

Level of the Grammatical Unit : this is the first part of a transition. As was mentioned in Chapter 2, transitions (including introductions) act to set the scene for the movement of characters and action within the story.

Level of Results : there are two external and one internal. The first external result is the inter-textual one centred around the fact that other fairy tales propose possible solutions to problems. It is also 'logical' for the father to go and get the money from his ship.

The internal result is the coherence that centres around the 'security' affect; the hope of security here refers the reader back to the security of the introduction. It is, therefore, an internal coherence in the similarity mode.

Level of Propositions : a dramatic scene of anticipation.

Level of Signifiers : the dramatic structure of these signifiers is static but the verb 'prepares' gives the impression of impending movement.

Level of Semiosis : Once again the semiosis level can be seen to be in the service of the 'lure'. 'But fairy tales always leave a glimmer of hope'. If there were no hope (no transition out of the problem set by the introduction and the first event) then there would be no reading. At this highest level of reading the story is continually signifying itself as a particular genre in which certain things will always happen.

S.U.4 *The father asks the daughters what they want. Miranda wants dresses. Rosina wants jewels. Beauty wants her father's safety and a rose. He sets out.*

Level of Affect-Signified : affectively this S.U. is a repetition of the Introduction. We have here stated quite clearly the selfishness v. Selflessness themes along with the promise of material security. Beauty's request makes the Security complete.

Level of Grammatical Unit : This is the second part of the transition; the Father is now about to move. These transitions are in two parts because of the affect-signified which integrates them.

Level of Results : There is a set of results which are wholely in the internal similarity mode ; it is in fact the voice of the introduction.

The Level of Propositions : the dramatic structure is both anticipatory (we are still in the transitional unit) and descriptive.

Level of Signifiers : the dramatic structure is interesting in that this is the first time the roles of the daughters have been clarified by the daughters themselves; we know their desires. So although there is the same affect-signified base as the introduction, the main difference here can be seen in the dramatic set-up of the signifiers; the manifestation of the affective themes.

Level of Semiosis : here once again the text refers to itself not this time as genre but to a part of itself : 'life could return to the introduction'.

The S-level relies on the results level but it is not so clear cut as this. For example, it can be seen that what is coherent internally is the action of the girls and their desires which are intimately related to the affect level; i.e. we understand their requests because of the stated affective themes back in S.U.1. So, as mentioned above, coherence is internal in the similarity mode. The S-level gets its voice, as it were, from the results level and this level's relationship with the affect level. The S-level is speaking within the discourse of the text entirely and it is interesting to relate its message here to the message of S.U.3 where the 'glimmer of hope' message is now put into perspective by the text, i.e. a return to former times of full or complete security.

S.U.5 *He discovers that the captain has stolen the money. He is disappointed for the children.*

Level of Affect-Signified : this perspective is brought home to the reader at this level because of the familiar themes; insecurity and selfishness and we can see that, affectively, the first two S.U.'s are being repeated.

Level of Grammatical Unit : this is an event in much the same way S.U.2 was an event.

Level of Results : the integration of the first two levels is carried out on this level by an external result of the cultural type ('people steal') and an internal similarity result in that the Father's disappointment is coherent from the affective theme of insecurity found in S.U.2.

Level of Propositions : factual.

Level of Signifiers : Once again as with the other 'event' the dramatic structure is static.

Level of Semiosis : the message here is similar to that of S.U.2; that things are not always smooth running in fairy tales. Here the message is simply 'remember the event' of S.U.2 and again the text does a double referring act. It refers to itself as a genre specimen and for this it relies on the fairy tale code and its stability but it also refers to itself internally as the actual tale that is being read.

S.U.6 *On his return he sees a castle of gold in lovely gardens.
He sees a rose arbour and remembers his promise to Beauty.
He picks a rose.*

Level of Affect-Signified : Selflessness is the affect in that he goes out of his way to keep his promise to Beauty. This is the type of security that I term 'primary'; the desire for affirmation and recognition which this father's action is signifying.

Level of grammatical unit : this is the first part of an episode; it is not an event because of the fact that it will be internally structured. We can now get some idea of the reasons behind the double referring or reinforcing of the message that the reader is reading a fairy tale; the story is about to begin again and, until now, one general aim of the 'lure' has been to assure the reader that this really is a 'fairy tale'.

Level of Results : there are two internal results both in the completion mode. The father returns because he went away and the picking of the rose is both a completion result and a similarity result in that the keeping of his promise complete it and at the same time we know this father is capable of keeping promises. The external result is intertextual in that episodes happen in fairy tales.

Level of proposition : for the first time and, understandably given the Grammatical Unit, an 'action' dramatic structure.

Level of Signifiers : the dramatic structure also reveals the action nature of the S.U. and it is obviously important that the Father picks the rose remembering Beauty.

Level of Semiosis : significantly, this is the first time that the S-level has been allowed to communicate a message outside the discourse of the text as either a general type or this particular example of the type.

This is an important point for both the text and its reading. The message at the S-level is built upon the affect-signified of security and selflessness. The message is : 'the father loves his daughter very much'. The code that condones this message is the stable father/daughter code which has as one of its rules the expression of affection for each other whether symbolically (the rose) or physically (kisses for example).

On the other hand, it must be pointed out that the Father's actions are totally coherent within the story as well; the reader knows what a good father he is and especially of his affection for his 'pet' Beauty. What has happened here is that what is internally coherent has been made over into something which is socially intelligible; all fathers are like this.

The important point about S.U.6 is what it reveals about the operation of the text upon the reader; it brings what happens in the text to her life. Put another way it transforms what is internally coherent (Beauty's father's action) into a social meaning.

In general, I will argue that there are two types of signification within the text:

- (1) The first is the signification found at the affect-signified level; we have the spectacle of the Father's gesture of affection for Beauty - he keeps his promise and picks a rose. He has been a model father in the past of the story; i.e. he is being internally consistent and the internal results level points to a similarity coherence at the affect-signified levels of previous S.U.'s - especially the full security he provided before the loss of his house and ships. Type I significations are bound to the text.
- (2) Significations which rely upon a system of signification. These I shall call Type II significations.

The third term as always is the reader's experience and, in some way, significations within the story must be made relevant to the reader and her experience, as they are read.

S.U.6 provides a very clear example of this process at work. It is the first simple example of a process that will become more complicated as the Lesson takes over from the lure. The father's action - picking the rose while remembering Beauty - is intelligible in two ways:

- (1) Internally we know that he is capable of these actions; this coherence is given by the similarity mode of the Internal Result level; a Type I signification.
- (2) Externally, in our culture's system of signification we know as readers that this is proper behaviour for fathers generally; the code here is the Father/Daughter and this is a type II signification.

How does the story get from I to II? The story relies on the two processes upon which language itself is based; metaphor and metonymy (both contiguity and synecdoche). This seems quite a 'natural' conclusion given the reader is faced with a linguistic semiotic system. What happens is that the text allows the reader to make a simple substitution; Beauty's father for her father. Metaphor is a word for another word or what Jakobson (1956) calls selection:

"A selection between alternatives implies the possibility of substituting the one for the other, equivalent to the former in one respect and different from it in another."
(p.74)

The equivalence is that they are both fathers; the difference is that Beauty's father is not identical to the reader's father. Once the substitution has been made the reader can start to use the code of which fathers are a part. Jakobson points out that each selection is also part of a context. That is, it is in a relationship of contiguity to other signs. This contiguity can be of two types; either a contiguity of time and space in the spoken or written utterance or a contiguity of part to whole (synecdoche). The first I shall call metonymy I and the second metonymy II. Metonymy is the motive force that allows the fleshing out; i.e. re-constructing the code of which father is a part. The father/daughter code in this example.

In a sense, of course, it is not the text that is holding out the possibility of substitution but language (the code) itself and what links reader and story is the commonality of the language. Most of the messages in the story found at the S-level have been made possible by

very stable systems of signification. By far the most important has been the Fairy Tale code.

Even though the process of transforming Type I into Type II significations does not apply here the two modes of language do. Take for example S.U.1 : we can see that 'once upon a time' is a fixed syntagm communicating that this is a fairy tale; on the other hand for the code to be reconstructed it must be realised that 'once upon a time' is only a selection of other beginnings, 'long, long ago', for example, that is, a process of metaphor but these selections from the code imply a context, the conventions that hold in fairy tale genre i.e. 'once upon a time' stands for the whole genre (M II). This is a type II signification which has not be transformed : it relies on the external result whose modes point to where the code lies; here it is in the reader's inter-textual experience.

The important point about the role of metaphor and metonymy in thinking about the code is that, contrary to Saussure, Jakobson believes that these connections that the reader has the chance to make are already there concurrently in the language; for Jakobson (1978), Saussure:

"... succumbed to the traditional belief in the linear character of language 'qui exclut la possibilite de prononcer deux element a la fois'". (p.75)

The connections are there yet it is up to the reader to make them. On the other hand the 'experienced' story knows full well that in its context Beauty's father has a very good chance of receiving the reader's father as substitute.

Furthermore, it goes without saying that these twin processes of language are also the twin processes of thought and Jakobson (1971) has remarked on their similarity to Freud's (1900) description of the primary processes of the unconscious, condensation and displacement. How a particular reader fleshes out signifiers presented in the text, how she makes them relevant to her depends upon these twin processes of language/thought - what they actually are depends upon the signifiers associated and it is the role of codes to direct the exploration of signifiers in a socially acceptable way.

Consequently in S.U.6 the reader's interpretation of the message about the father in the story will be directed by the stable code of Fathers and Daughters. The connections will be possible because of the processes of metaphor and metonymy; the actual connection made will be because of the code.

The point is that the connections the text is going to make possible and those that the individual reader will make will be more or less coincident. In S.U.1 the coincidence of textual meaning and personal meaning is, in parts, quite close; this is because both are made possible by the same system of signification, the fairy tale code, as it is reconstructed using metaphor and metonymy.

But what about the other signifiers in the S.U.? If one takes, for example, 'kind', 'loving' or the 'father' they are also part of the fairy tale code; fairy tales are about affect and parents and children. But it is also clear that if the metaphor/metonymy is made with, say,

Father then there are further implications for the reader than simply the inter-textual experience. 'Father' is part of a very complicated whole and the meaning of 'father' can now be seen as the links that are made to it. Meaning here, for a reader, is the implications of having started 'fleshing out' the whole of which 'father' is a significant part. From the point of view of the text connections are laid on and the reading depends upon and is structured by the reader's desire; the reader has to 'work' on the implications. This will only happen if there is a need/desire, an ineffable that needs articulating, in the reader; this is why she is reading the story.

I hope to show below that the text tries to mediate the reader's desire by insinuating certain systems of signification which articulate her experience for her; it makes the 'work' easier through offering her a structure.

One final point that comes out of S.U.6 is that of the constraints that are placed upon interpretation; the question of limiting semiosis. It can be seen that as far as the text is concerned, the connotative message, because of the other levels (i.e. the form of the semiosis level) is exhaustive. The S-level is constrained by the particular nature of its verticality. But it is also constrained by the previous S.U.'s, for example, those that describe the Merchant (via the Results section).

The other constraint is the existence of codes or sub-codes that direct the reader to certain connections and not others.

The final constraint is the experience of the reader and the use she will make of the invitation that the text holds out to her. This last point of constraint should, of course, be in the section concerning the text's reception; its inclusion here indicates once again how difficult it is to talk of the text outside its reception or possible reception because the text is, after all, a semiotic system; furthermore the text is always being read by me and the nature of its structure is that it is readable. This is clear from the primary interface that the results section shows itself to be. Both types of results function by pointing the reader in the right direction for finding the coherence of a particular proposition or set of propositions.

External results point to an area of the reader's experience where she could find the basis for rendering a proposition intelligible. Internal results point to the past of the story and, of course, the reader's memory of this past. But internal results also function by telling the reader how to think about the proposition being read through its various modes. Once this internal coherence has been established the story transforms it into an 'external' codified signification through the use of metaphor and metonymy.

In the case of the present S.U. it can be seen that the metaphorical switch of fathers, presented by the text, leads the reader to understanding what was originally internal to the story, the father's action, in her own experience having to do with her father. The story's father becomes intelligible because of the Father/Daughter code reconstructed (possibly) in the metaphorical replacement. However, metonymically, the

father is only part of a whole which may be ineffable for the reader. As the story progresses it will be seen that this whole will be filled out for the reader; whether she takes it or not depends upon the peculiarity of her thought and problems.

S.U.7 *A horrible beast roars behind him. He has a head like a fierce animal and the body of a man. The merchant is afraid and tells his story.*

The Level of Affect-Signified : we have here the opposition from the affect-signified of the last S.U. viz insecurity.

Level of Grammatical Unit : the second part of the episode which has a simple binary structure; integrated as it is by these affects.

The Level of Results : there are two results here. The first is an internal result in the completion mode. The rationale for this is the title of the story, Beauty and the Beast. He had to appear sooner or later and his arrival completes, in much the same way as the promise of S.U.6 was completed, something that was started at the very beginning. The second result is an external logical result. We know that beasts are dangerous in nature and it is, therefore, quite intelligible to be afraid.

Level of Propositions : action and description.

Level of Signifiers : Dramatically it is quite simple, yet once again vital; the Beast roars at the Merchant; the Beast is described.

Level of Semiosis : this is the first time that this level is going to communicate two messages. There is on one level the connotative message that 'the Father will be punished for picking someone else's rose'. This is based, of course, on a particularly stable and explicit code, that of law and order. But the message that arises after this is in the form of a question to the reader : 'what is going to happen next?' These two connotative messages are in a strange relationship; on the one hand the law and order code firmly establishes the first message but the reader 'knows' from the title that the father will not die here; Beauty and the Beast are destined to meet and the Father is the key to this meeting. Given this another message arises which I have said is in the form of a question and it is related to the first message in that it is like a progression of thought; the Father can't die so what happens next? But what code sanctions this message which is a question? What in fact allows the question to be read?

The answer here is the 'problem to be solved code' mentioned above. In my opinion the child is facing problems both existential and textual; problems, that is, that concern her circumstances and that particular part of her circumstance called the story. After all, actually reading the story, as we have already seen in the Wizard, is an attempt at solving a problem facing her. Looking again at S.U.7 it can be seen that the second message of the S-level is asking a question, the meaning of which is assured by the above-mentioned code; it gets its meaning as a problem to be solved!

S.U.8 *The Beast tells the Merchant he will forgive him on one condition. One daughter will come to live with him."*

Level of Affect-Signified : The two familiar themes are represented : selfishness v. selflessness.

Level of Grammatical Unit : this is the first part of a transition in that it sets the scene for the movement of the Father out of his situation.

Level of Results : there is one External inter-textual result. The whole question of dilemmas and conditional statements is a Fairy Tale fact as is the demand for a Daughter. Internally the reader is referred to the affective themes of Selfishness v. Selflessness that constantly recur.

Level of Propositions : this is a conditional factual structure.

Level of Signifiers : there is a straightforward dramatic relationship. The Beast is setting the condition and the Merchant is receiving the message. Also only one Daughter is asked for ;

Level of Semiosis : there are two messages here. The first is the familiar aspect of the S-level's function in the 'lure'; the reader is reassured about the fact that this is a Fairy Tale. The connotative message that follows is once again in the form of a question; the text has answered the question in S.U.7 with another question : 'what does the Beast want with one of the Merchant's daughters?'

We can see that the primary signifiers 'one' and 'daughter' are important to this message; I have given 'daughter' a case value of (O) because, intuitively, the daughter is the proposed object of the Beast's desire. (Whatever, from the reader's point of view, that is!)

S.U.9 *The Merchant promises to tell his family. He promises to return and be the Beast's servant if they refuse.*

Level of Affect-Signified : the general affect here is - inter alia - insecurity which has been generated by uncertainty. This is combined with a certain 'selflessness' on the part of the father.

Level of Grammatical Unit : this is the second part of the transition.

Level of Results : the promisory nature of the propositions is coherent internally as repetition, i.e. the father has made promises before. The unit is also understandable internally as a completion result; it is the father's answer to the dilemma posed in S.U.8. Externally the reader is referred to the fact that 'logically' the daughters are in a binary choice situation; they can refuse to go.

The most interesting result for the model is the internal similarity one which renders intelligible the father's intended self-sacrifice. This is understandable because it refers to the kindness etc. of the father that we already have seen; he provides well and keeps promises. It is interesting here because it is a clear example of another level from another part of the text being used to make a current S.U. readable. But it is only coherence that this gives; it is not the predominant affect-signified of this S.U. which remains as insecurity.

The conclusion is that propositions can be understood as belonging to the sequence of events of the story, its syntagm, through the use of another level in a previous column (for example, in this case the 'security' of S.U.1) but that this other signified is not necessarily given a privileged position at its 'proper' level (i.e. the affect-signified) in the S.U. being read.

Level of propositions : the structure is anticipatory and factual.

Level of signifiers : the father is doing the promising and he is the proposed agent of selflessness.

Level of Semiosis : there are three messages connoted here. The first is sanctioned by the father/daughter code that we have already seen operating in S.U.6. The Father's self-sacrifice is an example or token of this code (see S.U.21 for a discussion of the implications of Tokens of codes to the reading process). The second message is sanctioned by the Problem Solving Code and elevated onto this is the third and last message that the reader is faced with; 'the plot is thickening'; the fairy tale code.

The message of the Father's protectiveness etc., through self-sacrifice is an example of the reinforcement of the transformation of this particular father into a general father and, possibly, into the reader's father; this was established back in S.U.6 and the reader is asked to think about whether this is an example of the code.

S.U.10 *The sisters declare if Beauty had not asked for such a ridiculous present, none of these misfortunes would have happened.*

Level of Affect-Signified : the insecurity of uncertainty that permeates S.U.9 is replaced by a different type of insecurity that contains the affects of blame and ridicule; it is insecurity of non-affirmation. Paired with this though is the familiar affect theme of selfishness - the sisters are graceless to say the least. This 'pairing' of insecurity and selfishness is no accident of the part of the text, it happened as well in S.U.5 and, in the general affect progression, the reader has been faced with the close association of these two affects.

Level of grammatical unit : this is the first part of an episode which, as I have pointed out, gets its meaning from the next part together with its verticality.

Level of Results : the internal result here is of the similarity type. We know from past experience that the sisters are capable of such declarations. The external result here is of the logical type in that, given the sisters' premise, then it follows that logically there would have been no trouble.

Level of propositions : factual.

Level of Signifiers : again this is a straightforward dramatic set-up which is fundamental to the reading : it is clearly important that the sisters blame Beauty for what has happened; father could not.

Level of Semiosis : the primary signifiers here contribute to the message : 'Beauty is responsible for getting the father into trouble'. The code is quite stable and moral : you are responsible for the other if you put that other in jeopardy; what could be called the 'Responsibility' code.

S.U.11 *At last Beauty says she will go and live with the Beast to save her father. The Father and Brothers protest.*

Level of affect-signified : Beauty's response signifies once again another familiar pairing of affects; selflessness and insecurity (see S.U.6).

Level of grammatical unit : this is the second part of the episode. It is differentiated by the switch to 'selflessness'.

Level of results : one result; that of similarity; Beauty's kindness and selflessness have already been stated and seen (her desire for a rose).

Level of propositions : anticipatory.

Level of signifiers : a point of interest arises in this S.U. Is the Beast an Object or a Receiver (and therefore human)? This, of course, is the question and it is clear that the case analysis of the dramatic structure contains it; hence the case value of (O/R).

Level of Semiosis : being responsible for the misfortunes what follows is quite reasonable. But here the S-level communicates exactly why Beauty gives herself up : 'Beauty feels responsible about what she has done'.

The code that sanctions the message is part and parcel of the 'responsibility' code of the last S.U.; having done something to jeopardize the safety of the other you make amends because you should feel responsible for what you have done. This I would argue is certainly a sub-code in our culture. One does not have to look far for the justification of this; the Christian faith is based upon a love-thy-neighbour credo where respect for others and their property is a paramount consideration. One can also see this working in the most obvious of codes : law and order. A point that I should make here is that it seems clear that from now on in the story it is going to be necessary 'to search for the code'; only a very few social codes are actually written down in scriptures or law books. Establishing a code is a research process which increases as the stability of the code decreases. Nevertheless, the assumption is that they are there.

One can see here an example of the transition from a Type I signification to a Type II. Beauty's selfless action is signified at the affect-signified level and absolutely coherent internally; she's just like that. But now the S-level offers the opportunity for all little girls to be that way (selfless) because of a codified sense of responsibility that one ought to feel if you've caused such or similar situations.

The reader is presented, by the story through the language, with a thought: 'if I were Beauty (metaphor) would I do the same and what would the implications be (metonymy II)? The whole that the reader is being invited to fill out is that of her relationship with her father but directed by the 'Responsibility' code.

S.U.12 *They set off and arrive at the castle which is already prepared for them. Beauty is charmed and they eat well. She almost forgets the Beast.*

Level of Affect-Signified : familiar again is the Hope of Security that the text offers when things are particularly bad. It is for this reason that we are still in the 'lure'; it is of course a false affect but the 'experienced' text does not want to lose its reader now.

Level of Grammatical Unit : this is a transition because it gets the couple from home to the castle.

Level of Results : the first result is internal and simply completes the intended action of the last S.U. The next result is external and depends upon the inter-textual reading of the reader where characters in Fairy Tales can have fore-knowledge; the last result is the internal similarity result which allows the reader to render intelligible Beauty's mood in that the Material security of the introduction recalls for the reader this last part of S.U.12.

Level of Propositions : action and descriptive.

Level of Signifiers : the structure is again straightforward; Beauty features more than the Father and it is significant for the whole S.U. (especially the Affect-Signified) that the Beast is not included.

Level of Semiosis : the S-level this time is once again in the service of the 'lure'. One recalls the transitional S.U.'s 3 & 4 where security features. In any case, the S-level is saying something like : 'things

may not be so bad'. We can see that it is based upon the Fairy Tale code and is reinforced by other past examples of it in this story.

S.U.13 *They hear a tramp, tramp in the passage. Beauty clings to her father. The Beast growls good evening to the old man and Beauty. Beauty is frightened but replies politely.*

Level of Affect-Signified : the insecurity here is based in fear and it becomes understandable why the affect of the last S.U. was based in security.

Level of Grammatical Unit : this is the first part of an episode.

Level of Results : the first result refers the reader to the fact that the Beast has to appear; they have come after all to his castle. Beauty clings to her father is internally coherent from the S-level in S.U.9 but also externally coherent because of S.U.'s 6 & 9 - the Father/Daughter code⁽⁸⁾. The growling of 'good evening' is external and cultural and the use of 'Old Man' is externally coherent from a logical point of view - father's are old from the perspective of a little girl. Beauty's fear has a ring about of the Father's fear in S.U.7 and her reply is an external cultural result.

Level of Propositions : action.

Level of Signifiers : the 'power structure' of this S.U. - the father as powerless - is made clear by the cases of the signifiers. The Beast

(8) Results that refer the reader to an internal coherence when that coherence has been made external (i.e. from Type I into Type II) are from then on 'double edged'.

is always the agent the other two are always receiving. Furthermore, the switch from father, merchant to old man supports this.

Level of Semiosis : the semiosis level is important here mainly because we can see from the level of signifiers that this is the first time that the three main protagonists are dramatically related.

The message here must be seen in its relationship to the last S-level message which held out some sort of relief from the terrible situation that Beauty was walking into. This message at S.U.13 is : 'but they could be'. This is sanctioned by the Fairy Tale code and also by past S.U.'s which had a similar structure.

We can see here something of the constraint which the text itself places upon connotation. One could flesh out the implications of the primary signifiers and perhaps come out with other messages other than the fact that things are going to get worse. The 'tramp, tramp' for example could connote death and destruction; the growling could connote tearing apart. Although here is nothing to stop the reader doing this it seems clear that the story would prefer to point the reader to other associations. Within the context of the story this S.U. has a particular past; the story has a particular title and it is, as we have been told constantly, a fairy tale; death by shredding is hardly likely even though there's nothing stopping this association being entertained by the reader - I just did it myself. Taken within the story though all that can be said now is that the situation is worsening.

S.U.14 *The Beast asks the Merchant : did Beauty come willingly?
The merchant says, yes. The Beast tells him to go first
thing in the morning and never to venture near the castle;
the old man leaves full of grief.*

Level of Affect-Signified : and it does get worse. The insecurity here is much more significant than the fear that permeated the last one. This is insecurity through loss, what we could call separation anxiety after Bowlby (1969), a primary insecurity.

Level of Grammatical Unit : this is the second part of a three-part episode. I have distinguished it from the first part because of the quality of the insecurity that is signified; that is to say the difference in the affect that integrates this S.U. as opposed to S.U.13 is a difference that makes a difference.

Level of Results : we know internally that Beauty did agree to come and live with the Beast; at one level of reading this was the result of her selflessness but at another level of reading it was also intelligible as the result of a moral code of responsibility. These two combine to produce Beauty at the Beast's castle. The first result then is internal and in the similarity mode; in the first instance because of the theme of selflessness so closely attached to Beauty and because of the code concerning reparations at the S-level of S.U.11. This is the first example then of a Type II signification being used by the text to support the possibility of coherence of another S.U. The merchant's reply simply states the fact; she did agree to go and this is, therefore, an internal factual result.

The proposition in which the Beast tells the Merchant to leave the castle is an internal result reliant on the S-level at S.U.8 which deals with the Beast's desire for one of the daughters; the old man leaving is simply the completion of the command and his grief is intelligible from what we know about him as a father.

Level of Propositions : action.

Level of Signifiers : the beast remains in charge and it is only the Old Man who is full of grief.

Level of Semiosis : built connotatively upon the insecurity of the loss of the father is the message : 'why does the Beast want Beauty to be there willingly and without her Father?' The code once again is the 'problem to be solved code' which sanctions this as a question; it can be seen simply as an extension of the question the story posed in S.U.8 there are simply more conditions attached : the text is not answering anything just yet.

It can be seen here why this part of the episode is distinguished from the first part; it provides more information for the reader about the real basis for insecurity, separation anxiety and the subsequent lack of recognition from one's Father. This is a much more specific affect component of insecurity than that of Fear (although fear is certainly part of it) which is more diffuse.

S.U.15 *One day in the garden a voice tells Beauty to be kind to the poor Beast and she will be happy.*

Level of Affect-Signified : this is a familiar affect and it signifies to us that the 'lure' is still in operation.

Level of Grammatical Unit : this is an event integrated by the specific hope of security.

Level of Results : the most obvious is the external inter-textual result; voices often speak to characters in tales; at any rate supernatural communication is quite possible. The rest of the S.U. relies on an external cultural result in that it is a way of doing in our society that we are kind to poor people/animals and we also know internally that Beauty is kind and has been happy because of it.

Level of Propositions : factual.

Level of Signifiers : the dramatic structure is static; it simply has Beauty listening to the promise of a happy future.

Level of Semiosis : there are two messages here. The first deals with the Fairy Tale code but the second asks : 'is the meaning of 'kind' in this context being selfless'? This is sanctioned by the problem to be solved code which makes this a question to be answered. The primary signifiers, through a contiguous association, contribute to the message. For example, kind-poor-Beast are related metonymically (I). It is clear that 'kind' has throughout the story a close association with the affect-signified, 'selflessness', and that the attribute 'poor' cannot refer to the Beast's financial state but rather refers to his 'sad' state

about which, so far, the reader knows nothing at all. Furthermore, the story is setting up a metonymy of contiguity INTER S.U. between the Father and the Beast; it is no accident that the Father's grief is mentioned just before the Beast's sadness. What links them, of course, is Beauty and particularly Beauty's kindness. We can see this reflected in the case value for Beast where, being in a 'poor' state, he is much more a receiver than an object. Nevertheless, it seems to me that this message must be in the form of a question to the reader; this is what the reader is faced with, i.e. a series of messages in the form of questions-to-be-answered and it seems possible now that the meaning of signs like 'kind' and 'selflessness' are going to get other contents.

In a sense the main rule of the problem to be solved code states that you have a problem when a discrepancy exists between a present state and a desired state whose fulfilling has a certain utility for the person; solving the problem involves a making congruent of these two states. In many ways this statement of the code is a brief summary of what psychologists who work in the area of problem solving know. The difference is that any exhaustive analysis of the problem by the child, as is required or looked for in cognitive psychology's problem solving, is impossible simply because of the affective nature of it within the context of the story and what the child is trying to understand.

Now within the context of the story the reader is reading to mediate some problem; there is an interest or desire. This desire structures the reading (where she will go in exploring her chains of signification) but from the point of view of S.U.15 questions have been posed and what I hope to show is that it proposes to answer them for her; in a sense construct her desire.

An interesting question is that if it is useful for the child to make these states congruent then what is the utility for the text? One can only answer the conspirators behind the conspiracy of the text - a sort of cultural presence that directs the reader's reading.

S.U.16 *Beauty admires the gold, dresses and jewels. The Beast seemed quite gentle. He said 'Good Evening' and he talked nicely. She sang to him. She says she is happy at the castle but she misses her sisters, brothers and dear Father.*

Level of Affect-Signified : here the two grand themes are presented to the reader. On the one hand the material security that we have seen intermittently all along. On the other hand the insecurity (sadness) that has resulted because of the separation from her father. These two are opposed here and the S.U. shows an affective contradiction.

Level of Grammatical Unit : these affects integrate an episode part I.

Level of Results : the first result is an internal inversion in that this is the first time we have seen Beauty being materialistic. The Beast's gentleness is cohesive internally in that he has been labelled 'poor' in the last S.U., i.e. he has had a similar tag before. The 'good evening' is part of his repartee and, of course, part of our culture's. The fact that he talks nicely is intelligible internally through inversion; he growled before. Beauty singing to him is both a cultural and internal result; women sing and especially in the 'once upon a time past' of the story and internally we can understand this as a relaxation by Beauty because of the Beasts 'good manners'. Culturally we know too that you can be happy in circumstances that are rich yet we can understand Beauty's missing her family both internally, she loves her family - even the sisters, and culturally the reader can find

evidence of people missing the warmth of the family and, for girls, especially that of the father.

Level of Proposition : the overall dramatic effect of the propositions is action, as one would expect at the beginning of an episode.

Level of Signifiers : 'the 'action' is integrated by signifiers whose case value is self-explanatory.

Level of Semiosis : there are two messages here; the first is that 'the Beast is not harmful'. It seems quite clear that the Beast is being portrayed as a 'civilised' individual and the primary signifiers 'quite gentle', 'nicely' and 'good evening' are used by the S-level to connote the Beast's lack of threat and danger. The sub-code here is the 'civil' code which is probably part of a more general 'courtesy' code. But the second message is again the major question and it follows on from the first message; 'but what does he want with her?' The point is if he is not going to tear her apart then what is he going to do? This relies on the 'discrepancy' rule; there is still a vital lack of information which the reader, who continues to read, will want to know.

With this S.U. we come to the end of the 'lure'. The reason for this division here is, of course, because of its relationship to the next S.U. but also because S.U. 16 presents the major themes of affect and the vital S-level question. Beauty is in a situation in which she is only half made-up; materially secure but emotionally out of balance because of the loss of her Father. My contention is that the story knows this too and will attempt to 'fill up' the other half in a way that suits it.

3.2.2 The Lesson

S.U.17 *The Beast asks Beauty to marry him and always live there as the mistress of the beautiful palace. Beauty says 'no' in horror. The Beast sighs and tells Beauty to have pleasant dreams.*

Level of Affect-Signified : the shock-horror here is unmistakable but it is not clear at this level why she is horrified.

Level of Grammatical Unit : this is the second part of the episode that tries to complete the first part - the emotional lack - but it is integrated by an even more powerful insecurity.

Level of Results : the Beast's proposal, from a naive point of view, comes as a surprise. This is only true, however, if you ignore the S-level because Internally from S.U.15 the meaning of 'kind' is being fleshed out. There is here then an answer (partial as we shall see) to the question of S.U.15. This is, therefore, a completion result. That he should go on and ask her to be mistress of the palace can be found intelligible externally in the culture, i.e. the housewife. However, that it should be a palace is hard to understand. One place to look for coherence is the inter-textual type of external result; people in fairy tales have been known to live in palaces. But it is also true that her house that burnt to the ground was described as a palace (S.U.2). In this case the reader is asked to search her memory of the story for a palace and when she arrives she will see that it is her Father's palace that was destroyed. All that the text is depending upon here is the reader's memory of the introduction and first event and, as a consequence, the metaphorical association is presented as possible. This is

an internal similarity result in that Beauty lived in a palace before as her father's pet - not quite the mistress but certainly the favoured female for reasons the reader knows a lot about.

Where does the coherence for Beauty's answer lie? In the first place, although the Beast has been 'civilised' by the story, one has to draw the line somewhere, after all, he is a Beast. However, Beauty's answer is tagged with such a strong affect that the coherence for this cannot be entirely internal just because of the fact that the story has been humanising the Beast.

The child reader is then faced with a problem. It is this : where does she look in order to render intelligible the severity of Beauty's rejection of the Beast's offer of marriage? It must, in part, be External and it must be in the cultural mode. It seems clear that coherence centres around the word 'marriage' and its meaning. So the reader must look around in her 'ways of doing' catalogue of experience for what she means by marriage.

The Beast's sigh is external and cultural - the result of rejection and his wish of pleasant dreams is likewise an External cultural result - it is a way of saying good night, ~~usually~~, to children.

Level of Propositions : the overall dramatic effect is that of action.

Level of Signifiers : the action is integrated by signifiers marked by adverbs, attributes and verbs of action. It seems obvious but worth

stating that it is necessary for any significance at all in this S.U. that the Beast does the asking and Beauty does the answering.

Level of Semiosis : it is at this level, integrated as it is by the other levels (which make up its form), that the loose ends of these other levels can be tied up.

The first connotative message is : 'the meaning of being kind is marrying the Beast.' Here, through an internal completion result, we have a 'lateral' connotative message where the question posed at the S-level of S.U.15 is being answered by the story. But what does it replace 'kind' with? The answer is the word 'marry' and this, in turn, sets up yet another (but from the point of view of the text infinitely more important) connotative message in the form of a question : 'But what is the meaning of 'marry'?' The basis for this is the search that the text sends the reader on within her signifying structure. When she arrives at the word 'marriage' she may or may not have firm connections with it. What we can say for sure now is that the text is offering her, through a contiguous metonymy in the mode of a question/answer style, the link : kind = marry. On the other hand, the reader has the possibility of knowing that 'kind' is also related to the continual theme of selflessness (which of course gets its meaning from its opposition to selfishness). So the link that is now possible is : kind = selflessness = marry. It is important to note that the next has not made this equation very coherent; but this is just the point, it is about to and this is going to be the substance of the 'lesson'.

This is why I think there is a 'natural' break in the narrative. S.U.16 has presented to the reader two opposing and seminal affective themes which are quite coherent given the past of the story. It is as if S.U.16 represents the introduction but this time with a lack or an emptiness. The story is going to try to fill this emptiness up and S.U.17 is the beginning of a lesson in which the story will offer the reader a difficult, yet possible, way of balancing the affective imbalance found in S.U.16. Furthermore, it can be seen that, in S.U.17, the transfer of signification found within the story (Type I) into a signification in the child's life (Type II) is once more being set up. The reader is being asked to think about marriage and marrying with the help of 'being kind' and 'being selfless'; the story is giving a meaning to a signifier and it will be remembered that in S.U.9 a similar process was taking place. However, in that S.U. the text relied upon a very stable code, the Father/Daughter, to effect its possible metaphorical and metonymical connections. S.U.17, on the other hand, presents the reader with an unintelligibility, the meaning of 'marry' (given Beauty's violent reaction); not having a stable code to produce the desired signification, the text is going to lead the reader to an understanding of this word. The way it starts to do this is to give the reader possible metaphors and metonymies; it starts thinking for her and, through the problem solving code, invites her to participate. What it now has to do is to solidify those connections until they are accepted or received, i.e. socially conventionalised.

(9) The point is that the story knows that the code of which 'marry' is a main signifier is not clear, or well labelled, in any child who is attached to this text.

S.U.18 *For some months Beauty lives in the comfort of the Castle. The Beast asks each evening Beauty to marry him. She always says 'no'. The Beast becomes sadder and sadder until Beauty felt quite sorry for him.*

Level of Affect Signified : the shock horror of the last S.U. is followed by a re-statement of the themes but this time one is formed from a different affect : the material security is restated by the insecurity is formed by sadness; the sadness is the Beast's because of his rejection and the concomitant sorrow of Beauty.

Level of Grammatical Unit : these affects integrate the third part of this episode and in order to understand the relationships of these affects it is necessary to see them within the structure of the whole episode and indeed the story itself. The text starts to become very complicated.

Level of Results : the first is an internal repetition in that her being there and him asking her to marry had happened before. The Beast's sadness is understandable externally in the culture in that this is one expression of rejection. Beauty's reaction is intelligible in two areas; the first is internal in that we know as readers that Beauty is 'kind to all' and has an astonishing capacity to give; the second is that culturally Beauty is making the proper reaction to someone's sadness.

Level of Proposition : the overall dramatic effect is static (factual) and descriptive.

Level of Signifiers : the descriptive nature of the propositions is integrated by signifiers which include a lot of adverbs, attributes and Time cases.

Level of Semiosis : at the first level of connotation there is a message which continues with the Beast's humanisation : 'the Beast has emotions just like a human'. The code that sanctions this message is the fairly stable rule that says that people express sadness when they are rejected; the requited lover rule if you will. The second message that arises from this is : 'Beauty is the cause of the Beast's distress.' This arises from the first message and is sanctioned by the same code in that for a lover to be requited there must be a requiter who is responsible for the requited's misery.

This progressive humanisation of the Beast is quite understandable. His elevation to humanity is part of the process of making a Type I to a Type II signification, being established here by the 'requited lovers code' and it seems clear that the story has as one of its goals the presentation of the Beast as potential marrying material. How the text will do this can only be seen when these first three parts of the episode are seen in relationship to the next S.U. which acts as both a completion to the episode and a transition.

S.U.19 *During this time Beauty often thought of her Father. One day she looked into a magic mirror. She saw her father lying ill in bed. She becomes sad.*

Level of Affect-Signified : affectively this represents a return to the type of insecurity found in S.U.17; the loss of the father and the sadness at the separation.

Level of Grammatical Unit : this affect integrates a transition part (I) in that the story is preparing the reader (and Beauty) for a shift of scene.

Level of Results : the first result is internal similarity because we know that Beauty misses her father. But this result is double-edged because its coherence is also External and cultural - little girls in similar situations would think of their fathers quite a lot.

The story itself has sanctioned this latter type of search in S.U.6 where the transformation of Type I to Type II signification was completed within the stable Father/Daughter code. So, having been transformed once via a stable code, external searches from then on may be legitimised by the story (this is still only in the story's structure and I am not making any statements about what the reader has made of the Father before S.U.6; it is just that, at S.U.6 the possibility becomes socially potential rather than simply a set of idiosyncratic associations).

Seeing her father in a magic mirror is external and inter-textual and internally a completion result; she thinks of her father and then she

sees him. Rendering intelligible the Father's illness can be found in the fact that, in the story, he has been tagged as an 'old man' and at the same time 'old men' are ill (die) in our culture (external: cultural). Beauty's sadness is also both internal because she is capable, with her father, of this emotion and external cultural because of the story's previous transformation of the text's father/daughter dyad into culture's father/daughter dyad.

Level of Propositions : this S.U. is mainly factual in that it states something that happened concurrently.

Level of Signifiers : Beauty is seen with most of the agency; her father is the receiver and it is obviously important that the Beast does not figure in this S.U.

Level of Semiosis : the first message that is connoted is that : 'this is still a fairy tale'. This arises from the 'magic mirror'. I would argue that this is more a 'stylistic' device on the part of the text in order to effect the transition than a reminder to the reader that she is still reading a fairy tale; nevertheless the message is clearly there to be grasped.

The second message is something like : 'the father's illness brings out Beauty's kindness.' This is so because of its relationship at the S-level that preceded it; Beauty is being unkind to the Beast. What is the code? The code is still the one that deals with the relationship of fathers to daughters in our society but, instead of it being the way it was in S.U.9, it is now a rule about how daughters should behave

towards fathers when they are in some sort of distress; we must be kind to (respect) our fathers. This message is, of course, integrated by various levels and S.U.'s in the story; Beauty is kind and has been kind to her father; she is a preterpluperfect daughter.

But the interesting thing here is to see these four S.U.'s schematically to illustrate what the text has in mind vis a vis the father and the Beast and, of course, Beauty.

The following figure 3-2 shows the text once again delighting in the process of metaphor/metonymy.

| S.U. | 16 | | 17 | | 18 | | 19 |
|---------------------|---|----|-------------------------|--|---------------------------------|----|--------------------------|
| S-level | Why does he want Beauty alone with him? | + | Marrying=kind= selfless | | Beauty is being unkind to Beast | v. | Beauty is kind to Father |
| Affect-Signified: | Sadness (separation) | v. | Shock horror | | Sadness Sorrow | + | Sadness Sorrow |
| Primary Signifiers: | Dear Father | v. | Marry the Beast | | Beast | + | Father |

Figure 3.2 : Schematic Representation of S.U.'s 16/17/18/19

The relationship between 16 and 17 is best described as an attempt to fill up the emptiness created by the separation. So at the S-level, a question is answered; a type of filling up. At the Affect-Signified level the 'emptiness of separation' is filled with fear. At the level of primary signifiers there is an attempt at a replacement of Father for the Beast; this fails miserably and we can place an opposition sign between them.

The relationship between 18 and 19 at the S-level is an opposition unkindness v. kindness; at the affect-signified level there is identical affect and it is through this identification that at the primary signifier level Beast is metonymically linked to father. Where the relationship of 16 and 17 fails because of the shock horror it succeeds in the relationship of 18 to 19 because of the sadness Beauty feels. The opposition remains at the S-level but starts to disappear at the level of the affect-signifieds and signifier. Beauty feels 'during this time' the same emotions for both the Beast and her Father but the contradiction is that she is being unkind to the Beast by rejecting him and kind to her father. A mediation is, therefore, called for by the text at the S-level.

S.U.20 *Next day Beauty asks the Beast to let her go home, for a little while, to see her father again and her brothers and sisters. The Beast was grieved as he loved Beauty so much. At last he agrees but Beauty must promise faithfully to return in two months or she may find him dead. He gives her a ring to return to the castle.*

Level of Affect-Signified : the attempt at mediation begins here with a re-statement of the dominant affective themes; the security of the father's presence opposed to the insecurity of the Beast's possible death; from the identification of affect in the last two S.U.'s we now come to an opposition centred around the Father and the Beast.

Level of Grammatical Unit : this is the second part of the transition in which Beauty actually sets off for home. It seems reasonable that the transition should be integrated by opposing affects (see 4 & 8) in that Beauty is leaving one place for another place and that these two places get their meaning from the affective difference.

Level of Results : the first is internal and completing because she does want to see her Father. Internally similar is the Beast's sadness and his eventual agreement is internally coherent in that he is not such a bad person; it is also coherent internally that he should set conditions, he has done it before and the content of his conditions can be understood internally because of his desire to marry Beauty. The giving of the ring is inter-textual and that she sets out is a completion of the whole transition.

Level of Propositions : obviously this is a conditional S.U.

Level of Signifiers : obvious, but important, that the Beast sets the conditions to Beauty's request and that she has to promise him faithfully to keep her end of the bargain.

Level of Semiosis : the first message must be to the effect that the Beast is really quite a nice person; we know that the story has been progressively elevating him to human-ness and he shows a certain kindness that is part and parcel of a fairly amorphous 'decency-civil' code that has been seen before in S.U.16. It follows from this that Beauty cannot let him die and that, 'they will see each other again' is a possible message reinforced as it were by the extremely stable code about keeping promises/honesty etc. The giving of the magic ring generates the third message that this is a fairy tale and there is a theme at all the levels of connotation in this S.U. that supports the Beast's survival - it would be a cruel trick if the conspirators behind the story killed the Beast off through Beauty's indifference - but of course that is not the intention as we shall see.

S.U.21 *She arrives and the family is happy. Beauty runs to her father's room and seeing her he soon recovers. He asks if the Beast treated her kindly. After she tells her father all he wanted to know she showed Miranda and Rosina the beautiful presents she brought them and precious things for her brothers and a chest of gold for her father.*

Level of Affect-Signified : at home there is a resolution of the two opposed affects into total security; material and that of recognition/affirmation but where these exist selfishness and selflessness can't be far behind.

Level of Grammatical Unit : this is the first part of an episode.

Level of Results : that she arrives is a completion; running to her father is double-edged both similar and culturally coherent. His recovery is coherent internally in that he loves her and this is culturally also coherent.

The asking of questions is a culturally coherent result in that father's do ask about daughter's activities; the concern is also internal because the last time the father interaction with the Beast the latter growled at him. The giving of presents is a good re-statement of Beauty's kindness (selflessness) and the introduction generally; that she should bring these things is an internal and factual result - the family is poor.

Level of Propositions : the dramatic structure is active.

Level of Signifiers : Beauty arrives and gives, runs to her father and he recovers; all extremely important dramatic relationships which provide the basis for any signification at all.

Level of Semiosis : Two messages; 'the father was ill because he missed Beauty' and, built on the security, 'everything is alright again'.

The stability of the Father/Daughter code - its labelling of the metaphors - ensures the first message, whereas the second is connoted largely through the memory of the introduction - for in fact this S.U. is but a variation on it.

S.U. 22. *Two happy months passed quickly. Beauty began to think of her promise to the Beast. Her brothers beg her to stay on. She puts off going back to the castle.*

Level of Affect-Signified : the main affect here is the selfishness Beauty generates from trying to keep the security of S.U.19.

Level of Grammatical Unit : the second part of the episode integrated by opposing affects.

Level of Results : the first is a completion result; she made the promise and it is simply a completion of an earlier action. That her brothers want her to stay is internally coherent in the similarity mode - they did not want her to go in the first place. This is also intelligible externally in our culture in that family cohesion is part of our experience. She puts off going back because we know as readers that she is happy but her action is also comprehensible internally as an inversion; it is contrary to expectation that Beauty should break a promise.

Level of Propositions : dramatic structure is rather static and it states certain facts.

Level of Signifiers : important here is the fact that only the brothers ask her to stay. This is extremely important in that we know for a fact that the story would lose all credence from the point of view of the affective themes of selflessness v. selfishness if the sisters asked her to stay and, for the father, who has just been made well by Beauty's arrival. The brothers are key signifiers from the point of view of the coherence of the narrative; like the fact that the flying monkeys refused to kill Dorothy because of the kiss.

Level of Semiosis : the brothers are not, however, particularly primary for this level. The message here is a straight connotation from the affect-signified level : 'Beauty is being selfish by breaking her promise to the Beast'. This is an example from the 'keeping one's promise code' which is stable not only in the adult world, 'my word's as good as my bond' but more important in the child's world where breaking a promise is a terrible crime.

S.U.23 *One night Beauty has a terrible dream. The Beast is lying ill under a large tree. She hears a voice : 'you have broken your promise, Beauty, and see what has happened'. Beauty is frightened and uses the ring to go to the castle.*

Level of Affect-Signified : the S.U. is filled with Beauty's guilt which is the result of her selfishness.

Level of Grammatical Unit : the first part of a transition which will move her (guilt is a powerful motive force).

Level of Results : that we dream is a cultural part of our experience. It is also internal in that she has been wished pleasant dreams (17). The Beast lying ill under a tree is a completion result; he warned her he might die. She hears a voice; she's heard them before (similarity) and dreams include dialogue (cultural). The fact that the voice says 'see what you have done' is an internal factual result in that it is a fact that if she broke the promise this would be the outcome is a completion result. Beauty's fear is a cultural reaction to causing someone's illness and the use of the ring is a completion result.

Level of Propositions : dramatically this is very active.

Level of Signifiers : the inclusion of the voice which does the speaking is significant because of its association with the voice that talked about being 'kind' to the Beast. So, where it all happens, under a tree, in a garden, one assumes, is important; and it is obviously important that Beauty has the dream and it is about the Beast and his predicament.

Level of Semiosis : the message here is quite straightforward τ 'Beauty feels responsible for the Beast's illness'. The code is the same that appeared in S.U.10; you are responsible for the other if you put the other in jeopardy. But unlike S.U.10 where Beauty was made to feel selfish by her sisters, here she does it all by herself; or rather the code does it for her; it makes her feel guilty.

With this S.U. the replacement by the story of the Father by the Beast is clinched. They are inseparably linked by the code of 'responsibility to the other'; but in order to do this Beauty had to feel guilty - an extremely 'social' emotion.

S.U.24 *She could not find the Beast in the castle. At last in the evening Beauty ran into the garden weeping and calling his name. She came to a tree, like the one in her dream. She saw the Beast lying, face down, apparently dead; she was horrified. She ran for some water to revive him.*

Level of Affect-Signified : following the guilt comes the anxiety; the story is putting Beauty through a wringer.

Level of Grammatical Unit : the second part of this transition. Beauty arrives motivated as she is by her guilt.

Level of Results : she cannot find the Beast in the castle because we know that he is in the garden (internal : logical); driven by guilt and anxiety logic is not someone's strong point. Running into the garden is the completion result - he is after all under a tree; calling and weeping is internally coherent in that she is guilty and anxious; on the other hand Beauty is now an exemplar of how to handle these emotions so the reader is also asked to search externally for 'ways of doing' (see the S-level). Seeing the Beast lying on the ground is a completion result and being horrified is intelligible internally and culturally; this time, however, Beauty's horrification, something she seems to be capable of (see S.U.17) is at what she has done to the Beast, not as in 17, what he did or proposed to do to her, i.e. marry him. So we have a similar emotion felt by the same person but in inverse circumstances (the dramatic structure has been inverted). The last result is an external logical result; water does revive people.

Level of Propositions : the dramatic structure is active.

Level of Signifiers : the adverbs of weeping and calling are vital;
Beauty's agency in all this is also important.

Level of Semiosis : the message here is : 'Beauty is suffering for what she has done to the Beast.' The code? Once again this is part of the code complex, an example of what happens after you have jeopardised the other - you act in this way, i.e. weeping, crying, in a word you suffer. This is in no way a 'natural' behaviour - it is a codified way of doing in our society.

S.U.25 *At last he opened his eyes. He was delighted to see Beauty again. He told her he would have supper with her that night.*

Level of Affect-Signified : relief - the Beast is not dead after all. This emotion makes Beauty feel secure again - she did not after all kill the Beast.

Level of Grammatical Unit : the first part of an episode.

Level of Results : the opening of the eyes is a completion result from the giving of the water to revive him. His delight is, of course, internal and similar and having supper is a repetition.

Level of Propositions : an active dramatic set-up.

Level of Signifiers : quite straightforward from the case point of view.

Level of Semiosis : the first message here is : 'Beauty makes amends by saving the Beast's life'. This is sanctioned by the responsibility moral code which requires that, having done harm to another, you 'pay back' in some way. Our culture can be seen as very generally being one where reciprocation is the liet motif. Criminals pay debts to society; the villain, if he does not make amends, will have a terrible fate; 'crime does not pay'; this is so in a lot of fairy tales as well, one only has to recall the fate of the Wicked Witch of the West when she tricked Dorothy out of her shoe for her greedy desire. It is also an important part of growing up in that one is taught to respect the other and his property. Not respecting him or her leads to reparations but the feeling of guilt is what is instilled to make these reparations possible; that is what I meant when I said above that guilt was a particularly social emotion and so, of course, is the concomitant anxiety. (10)

The second message is sanctioned by the problem solving code : 'why is he having supper with her?' The answer seems obvious and I think it is intended to be so. Nevertheless, the reader is still faced with the question.

(10) From the point of view of Security/Insecurity they are related to guilt and anxiety (inter alia) as primary is related to secondary; the former are basic the latter contingent. It is difficult to imagine a society where people did not need recognition as people but not difficult to imagine a society where guilt was a socially necessary concomitant.

S.U.26 *After supper the Beast asks Beauty to marry him. She answers 'Yes, dear Beast, I love you very much.' The Beast is surprised.*

Level of Affect-Signified : instead of the horror we saw in S.U.17 in the same circumstances we now have love - the ultimate form of security.

Level of Grammatical Unit : the second part of the episode; the relief from the burden of guilt is followed by love and recognition.

Level of Results : the asking to marry is a simple internal repetitive result. Now, however, comes the crunch as far as the whole story and in particular the results section is concerned. How does the reader render intelligible Beauty's affirmative reply and her declaration of love?

Internally we have seen how the Beast was not only humanised but he became a substitute for the father; the Beast is a metaphor for the Father. It is, therefore, very easy, if this is so (i.e. the story's been successful in effecting this substitution), to switch one's emotions onto the replacement, i.e. be kind/selfless to the Beast; we have already seen how this is possible in S.U.'s 18 and 19. But this, one might argue, cannot be enough and that would be right; Beauty's declaration of love is not simply because Father was cunningly associated with the Beast and vice versa but because she also FELT GUILTY. The coherence for this is found in the story from S.U.10 onwards where responsibility and selflessness are related in an episode dealing with Beauty getting her father into trouble and where one's moral responsibility

toward the SECURITY of the other was the message; on the other hand you could not, as a little girl, give yourself to an animal, a Beast; but you could if he was as cleverly associated with Father as this Beast has been.

Level of Propositions : an active dramatic scene.

Level of Signifiers : simple, straightforward asking and receiving.

Level of Semiosis : the message is : 'saving the Beast's life is not enough, Beauty must also marry and love him'. In order to establish the code that sanctions this message it is necessary to take a general look at the story until now.

One of the major accomplishments so far has been the substitution (metaphor) of the Beast for the Father; the story has managed this through metonymies of contiguity. For example S.U.'s 18 and 19 quite clearly showed that Beauty's sadness was simultaneously associated with the Beast and the father. Recently we have seen the spectacle of Beauty saving both the Father and Beast. All this has gone on with the Beast's habilitation into a human being since the 'old man' left the castle.

Having made the substitution possible, Beast for Father, the story also makes another type of metonymy possible that of synecdoche, or part for whole. In other words by making the Beast a metaphor for the Father he has also become a part of a whole of which the Father is a part.

The main attribute that links these two is that they are both men. In a sense, the Beast is like the father but not identical to the father. This is obviously an important point because the message of this S-level has to do with the love and affection of Beauty and upon whom she bestows it; someone who the story has made into being like her father but not exactly her father.

All this revolves around the primary signifier of 'marriage' and the signification it is given in the story. I would like to propose that the story is working to codify a set of signifiers some of which have affective signifieds. At the heart of these is 'guilt'. It seems clear that the moral/responsibility code which deals with responsibility for the other is being insinuated into an area of the language that has, as one of its main signifiers, 'marriage'. The story has been preparing the reader for the metonymies of marriage i.e. kindness and selflessness. The Beast, as I mentioned above, has been set up as acceptable marriage material. All that remains is to get her to marry the Beast; the motive force is guilt. The code is saying : women (girls) when feeling guilty about their responsibility to men concerning questions of 'marriage' must make amends by capitulation - agreeing, that is, to their demands.

We can distill the associations to : men - guilt - marriage. The story has not in any way emitted messages of an explicitly sexual nature; the important point is that it does not have to. The metonymies around 'marriage' for a little girl readers will fill this gap up. We have been formally aware, since Freud (1915) about children's speculation about sexuality; being married is what mother and father are; she is

the mistress of the house (palace) and the state of being married is a whole series of metonymies centred around mother and father and their activities, especially those that occur without the children. Furthermore, it is no accident that absent from the text but not from the language is the mother; if the Beast is a man not unlike her father then marrying the Beast makes Beauty a woman not unlike her mother. The inclusion of the mother in the narrative would have made nonsense of the strength of Beauty's feelings for her Father and the subsequent switching of them onto the Beast - another female who gives, is kind, selfless etc., to the Father would not have allowed the dramatic effect; 'mother' would have got in the way'.

It is an important notion that what is left out of a story is as important as the relationships actualised in the story. Linguistically on the other hand, according to Jakobson (1971), everything is present at once. The enunciation of Father has simultaneous associations with Mother (etc.) in the language.

The associations then to marriage, before reading Beauty and the Beast could be re-structured after reading it. 'Marriage' starts to take on a meaning and most importantly for the reader your feelings of kindness, love and guilt also start to take on a meaning.

The most important feeling that the story is dealing with is the love and affection that the daughter feels for her father and, from the daughter's point of view, father's feelings for her. The story established

this back in S.U.6 as a type II signification; these mutual feelings are a well established social practice. The story's achievement is to switch this affect (or rather to present the possibility of switching) onto someone who is like the father but who is not quite identical yet at a price; Beauty is made to feel guilty. It is not only Beauty who feels this way. We have seen as readers why she acts like this; her behaviour is internally coherent (if not consistent). On the other hand this behaviour receives social sanction at the S-level and we can see the ultimate purpose of this story; a type I signification has been exteriorised into a type II : this is the way all little girls should behave. It is very much the same process that we saw in the Wizard; what drives Beauty into loving and marrying the Beast is not so much her guilt about what she has done to him but the code that tells her what to do about it!

However, it is not enough to establish the code only in the story; what must be done is to establish the code for what it is, i.e. a socially conventionalised rule. One of the places to look for this code is in our literature about women. Diana Trilling (1978) presents what could be called a corrolary to the rule mentioned above. She points out that within the body of our literature from the Greeks to the present time the concept of the liberated heroine - generally that female character in a novel or play who would try to act and create her own space, and fail - are women who:

"...have subdued their personal needs to others... heroine-ism ... is seldom demonstrated in action, or not in freely elected action. Heroines are in the first instance women who please, help and wait. They please men and are helpful to them in their undertakings." (p.1163)

One of the great heroines is Emma Bovary who is punished severely for the hubris of wanting something different from the life that the insipid Charles could give her. I would point out that it was not so much Flaubert who killed Emma off but the social code; Emma's sin was not so much her extra-marital sexual activities but not looking after Charles like a good wife, caring for him and feeling for him.

Although the reason for the marriage has very little of the code in it the life she leads almost immediately after it confuses her original feelings for Charles:

"Before the wedding, she had believed herself in love. But not having obtained the happiness that should have resulted from that love, she now fancied that she must have been mistaken. And Emma wondered exactly what was meant in life by the words 'bliss', 'passion', 'ecstasy', which had looked so beautiful in books." (1970, p.47)

One is led to wonder what books she actually read as a little girl; it could very well be that these signifiers were related through guilt and selflessness in much the same way as Beauty and the Beast.

In any case the point is made that in literature marriages are often underpinned by the woman's selflessness. Eliot's Dorothea Brooke marries Casaubon in order to help his literary career instead of making her own, as Eliot says:

"Dorothea's inferences may seem large; but really life could never have gone on at any period but for this liberal allowance of conclusions, which has facilitated marriages under the difficulties of civilisation."
(in Trilling, p.47)

It seems clear that the capitulation of women is manifest in the literature that is based, in part, on women trying not to capitulate; they fail; they are killed off and held up to ridicule. Better in fact to give in.

From my point of view they have little other choice. Emma Bovary did not burst fully grown onto the pages of the book. People develop and society takes great care in how it structures its citizens; as far as women are concerned, if our literature on them is a reflection of their 'estate' their 'spirit' (a will to be free) this, according to Trilling, endangers the 'most intimate secret connection' which biology and culture have; it is of course one of the main points of the model presented in the thesis that this secret is uncoverable.

S.U.27 *As she said this there was a tremendous flash of lightning and peal of thunder. The ugly Beast becomes a most handsome prince standing beside Beauty. The Beast thanks Beauty for breaking a witch's spell.*

Level of Affect-Signified : the Beast's transformation signifies an affect of relief; mainly for the Beast but also for Beauty.

Level of Grammatical Unit : the third part of a three-part episode.

Level of Results : this is entirely an inter-textual result and for an important reason. By using the network of other texts that make up the child's reading experience this story conceals its cunningness over the humanisation and association with the father - the Beast becoming a man is put down to magic, not language. The vital thing about a conspiracy is that it should be left hidden.

Level of Propositions : an active dramatic structure.

Level of Signifiers : a new case value has to be added here which is something like scenery and special effects; the agency for all this is the Fairy Tale genre; it is obviously important that the Beast is transformed.

Level of Semiosis : the message here is quite clear : 'Beauty is rewarded for being kind to the Beast, he becomes a man.' The code here is the moral responsibility code; the message is something like : 'this is Beauty's reward for making amends'; the rule : guilt pays.

S.U.28 *Next day, the Prince sent for her Father, sisters and brothers. He told them that she promised to marry him. There was a grand wedding at the castle with many guests. They lived happily ever after.*

Level of Affect-Signified : a full type of security.

Level of Grammatical Unit : this is an ending and it recalls the introduction.

Level of Results : it is a cultural result that you tell the family of the girl that you intend to marry her. The wedding is a completion result and also, of course, cultural. Living happily every after is pure inter-textuality.

Level of Propositions: descriptive dramatic structure.

Level of Signifiers : a straightforward case structure.

Level of Semiosis : the first message is a reminder that the reader has been involved in a fairy tale and the second message must be that because of Beauty's kindness to the Beast everyone is happy.

3.3 Melissa's Reconstruction : Introduction

Melissa's reconstruction was gathered in much the same way as Victoria's. The child was interviewed in her bedroom which contained her books. She was asked what her favourite fairy tale was and she named Beauty and the Beast. The full interview appears in Appendix G.

The reconstructed narrative is handled in the same way as Text 1. Each Signifying Unit is differentiated as it signifies affect. But we run into problems straight away in that, for the most part, as in the Wizard, the linear reconstruction is affectless or flat⁽¹¹⁾.

When Text I was analysed its two dimensions were simultaneously present in that, quite simply, the text provided enough information about both its dimensions; it was if you will redundant. This was especially true, for example, with the 'double edged' result. Text I took the reader slowly through and very little was left to chance as to what set of meanings it was communicating.

(11) This flatness could be the result of a process described by Anderson & Bower (1972). They showed how the recall of significant (high affect) words were linked to contextual (low affect) cues although this is probably part of the explanation we will see later on that flat affect has a functional value in that other signifiers receive strong affect.

Now, on the other hand, we come face to face with the problem of Melissa's reconstruction and its status as a semiotic system; Table 3.2 shows the result of the application of the model onto the reconstruction. The most difficult problem encountered has been filling out the vertical dimension; in fact, how the child reader has made Text I coherent or intelligible is impossible to discover from just the linear reconstruction of the S.U.'s.

We know from Chapter 2 that the vertical dimension is only partially present in Text 2 because it is the child's thought. In other words, how the reader grasps Text I is only partially revealed in the reconstruction she presents; some of the processes by which she grasps the story still remain hidden. This is where the interview becomes important for it is here that the child's associations and thoughts about the story reveal what she has brought to bear upon the structure of Text I.

The problem can be seen as a methodological one, in effect, the question I am asking is : 'How is it possible for me to read her story in order to find out how she read Text I?' The answer is twofold:

- (1) We know the structure and function of a fairy tale; we know in fact how it makes itself readable and what contents it intends; i.e. the analysis of the S.U.'s.
- (2) We also know that the reader will bring something to the text and that moreover reading will be in the form of a type of problem solving.

What she does bring to the text is that part of the child's imagination that has rendered Text I intelligible for her. The only way we can understand this is to take each S.U. of Text 2 in turn but this time with two 'backdrops':

- (1) The existential circumstances of the reader as revealed by observation and interview, in relationship to,
- (2) The original text.

The reconstruction is incomplete whereas Text I is full. Whereas Text I is the product - inter alia - of stable and traditional systems of signification, Text 2 is the product of a developing thought structure which, if it is to be understood at all, must be seen in the broader context of the reader. Therefore, the recomposition that is represented in Table 3.2 has been filled in using three dimensions:

- (1) Text 1 (i.e. the model of it)
- (2) Text 2 (i.e. the linear reconstruction)
- (3) The thought structure inferred from points 1 and 2 and the interview data. The reconstruction plus the interview is the representation.

As for my place in this system, the semiotic perspective that I adopted for Text 1 will now have to be combined with the Social Psychological; i.e. a new perspective Psycho-Semiotics⁽¹²⁾.

(12) This is, of course, a restatement of Figure 2.2 along with the idea that reading is the application of a frame of reference in order to 'naturalise' the text. The hope is that with the use of these three perspectives the type and process of naturalisation carried out by Melissa will become clear.

3.3.1 Melissa's Story

S.U.1 *The nicest daughter was Beauty and the other one, the sisters, were selfish and they always wanted to take jewels and nice dresses.*

Level of Affect-Signified : without too much inferring it can be said that Melissa has the two main themes presented by Text I in the same S.U.; there is also the overriding atmosphere of a material security enjoyed by all. This notion is also supported in various places in the interview, especially at question 2 where the father's kindness and generosity are touched on by Melissa.

Level of Grammatical Unit : this is an introduction although a lot of those signifiers we would expect are not included. Nevertheless, the S.U. has a sort of descriptiveness about it.

Level of Results : nowhere is the problem of this analysis more striking than in this section. The results represent a level of interface between reader and text; my problem is to find out where she has gone in order to render Text I coherent and, to a certain extent, I myself need a directional indicator. From the interview at various times it seems clear that she has used the External : inter-textual result; but they are inter-textual with a certain significance. So, for example, to take just one we have the 'slip' of 'one sister' revealing Melissa's reference to her reading experience to one of Cinderella's sisters and at the same time the association of Cinderella's father with Beauty's and, of course, Cinderella with Beauty. It seems that another story is being used to fill in the present story (and one assumes vice versa); on the other hand, it also seems that there is more to it than just

another story as a reading aid - they are obviously related thematically and one could infer, justifiably, that Cinderella has been used to render the twin themes of selfishness v. selflessness intelligible, mainly because they are much more pronounced in that story than here and because of this we could say that, for some reason which is not quite clear at the moment, these themes are extremely important to Melissa.

In general then the level of results section will try to ascertain how Melissa has gone about finding coherence for the S.U.'s of Text 1.

Level of Propositions : this dramatic structure is descriptive; Melissa gives Beauty and her sisters attributes.

Level of Signifiers : integrating the whole S.U. are the signifiers, the most primary string of which is the 'slip'; 'and the other one'; it is difficult at this point to know whether we are dealing with an error or a genuine slip of the tongue which is significant. We shall see later on that the 'one' sister starts to take on a primariness that makes it hard to classify as a mistake. We can see here too the fact that she has omitted the father and the brothers from her introduction and the impression, at this S.U., is simply of the rivalry between the sister(s) and Beauty.

Level of Semiosis : this is the other major interface with the reader and again I must situate myself in the face of it.

In Text I it was relatively easy to formulate a code that structured the message that each S.U. contained; this was mainly because of the predominance of primary signifiers, the integrated nature of the S.U.'s and the existence of stable sub-codes within language. Here, on the other hand : what possible rule can there be and hence what message?

The difficulty again is that whereas Text 1 was an intact semiotic system, Text 2 is incomplete mainly because it is not intended to take part in a process of signification; Melissa is not telling a story in the same way as the 'conspiratorial' narrator is in Text I; it is a text of a different purpose very much like an exegesis⁽¹³⁾, a making over of Text I, a making sense of it for herself. This process will be underpinned in two ways:

- (1) by the individual's thought and
- (2) its relationship to society's codes.

Although they are both related in that her structure is in-the-world they are nevertheless, because of its development, more or less coincident.

So at the S-level of S.U.1 there are two messages : the first says that this is a fairy tale - this is a process of connotation made possible by the Affect-Signified level and coherent via the inter-textual result.

(13) In general what I want to do is to discover what meaning she has grasped from Text 1 and secondly to see how codified it is or not.

As a consequence, two possible levels can be deciphered in the Semiosis section : the first will relate to significations structured by the reader's thought processes and the second as to how much these have been structured by codes and sub-codes.

This level reveals the reconstruction as a 'version' rather than an exegesis.

The second message says something like : these themes are very important to me especially in the context of another girl (female) i.e. the exegetical is more important here. I propose that the first message here is identical to the connotative process that was going on in Text 1. We have a second order of signification in that the affect-signifieds within the context of a narrative signify a fairy tale.

The second message is a process of communication based upon codes which are part of the reader's thought structure plus the other evidence we have such as the omission of father and brothers and the addition of the 'one sister' ⁽¹⁴⁾; the coherence or directional indicator here is extremely interesting in that it is also the inter-textual result. That is, we have the story of Cinderella which figures prominently; but the story of Cinderella and its characters relate to Melissa's problem concerning the twin themes in the context of another girl. The inter-textual result is used to give a context to the affect-signifieds but these affect-signifieds also exist in her circumstances and certainly must make up part of her predicament and the reason why she is reading the story.

(14) It is very difficult to label this; in Chapter 2 Victoria's use of the larder etc. was marked as an elaboration; here we could say that 'one sister' is a subtraction rather than an addition which would then give the additional problem of why a sister was being left out along with why one was being given a special place. Both these questions will be faced below, but for now I would like to label all extra signs 'additions' mainly because they show the extent of the reader's contribution to the process of reading.

If this is true (and I hope to corroborate her motivation more fully below) the addition of 'one sister' means that she has started to think about this story vis a vis her experience concerning the themes and context outside, but in relation to, the fairy tale context.

We can say, therefore, that there are two messages at the S-level. The first deals with the well established code of fairy tales and the other deals with part of the reader's experience which, although given some context by the various fairy tales she has read, is still problematic. We can start to get an idea of how she structures this aspect of her experience from the way she has represented the introduction.

This also leads on to the fact that there is another result that has been used to make the introduction of Text 1 intelligible; this has to do with the fact that culturally children read fairy tales and for the specific purpose, I assume, of solving problems. The introduction to Text I has been rendered intelligible by the reader recognising this as an artefact that contributes to a need and this particular result was referred to in the analysis of Text I. We know introductions are vitally important because of their transitional nature; these themes and this context take place in another place. The link, however, between this place and the existential predicaments of the reader is not simply guaranteed by the processes mentioned above; we must also consider, as we did in the Wizard, the fundamental axioms of reading - identification and projection. Rather than assume these we can see from the interview that it is almost entirely permeated with data that point to a very strong identification by Melissa with Beauty combined with a tendency to project herself into Beauty's situations. For example, both she and

Beauty are very 'nice' in that they do the washing up without grumbling (see 5, 7); her favourite flower is a rose which she would like (see 28, 29) and she describes Beauty as having blue eyes when they are illustrated as brown - it is Melissa's eyes that are blue. There are many examples of identification and projection and it seems quite clear that this is a fact of the reading. From the point of view of the primary signifiers there is little question about the importance of Beauty. On the other hand, vis a vis message two we must also consider the slip as a primary (string) of signifiers.

S.U.2 ... *and but one day there was a dreadful fire.*

Level of Affect-Signified : the affect here is the insecurity caused by the fire. But again from the point of view of the reconstruction the affect is 'flat'. In any case it does begin the seesaw effect of affect in that S.U.1 was over-written with security.

Level of Grammatical Unit : this is an event integrated by the specific affect of insecurity.

Level of Results : the main result here is the inter-textual which refers the reader to other stories. Basically, after the introduction something has to happen and, as we have seen from the 'lure' section of Text 1, the affect-signified is opposed to the preceding S.U. in part.

Level of Propositions : a factual structure.

Level of Signifiers : the most interesting signifiers here are 'and' and 'but' which I consider to be separable for the following reasons:

"And" seems to be very much in the paradigm of 'then', i.e. a connector of the narrative in time; the 'but' shows us that this S.U. is dissimilar to the last one. This is mainly of course on the level of Affect-Signified; this is one of the ways the reader has of signifying the opposition of affect. So 'and but' signifies contiguity on one level (the narrative progression) and discontinuity on another level (affect- signified); all this has been made coherent in the first place by the inter-textual result.

Level of Semiosis : this level is taken up entirely with a social codification identical to the message intended in the same place in Text 1 : sometimes in Fairy Tales terrible things happen.

S.U.3 *and so somebody called to the man...the...um...father;
to go on, um, a ship with cargos.*

Level of Affect-Signified : the reader has again kept to the original affect pattern; hope of security.

Level of Grammatical Unit : this is a transition; the man/father is being called away.

Level of Results : again she has used an inter-textual result and the clue to this is in her narrative at the start of this S.U., 'and so'; these can't really be split up and she is signalling here that she is telling a story with a certain continuity; which stories have as an attribute.

Level of Propositions : anticipatory.

Level of Signifiers : the 'and so' seems to be fundamental as it helps to integrate the results level; but we can see also that she has added an agent to the S.U., 'somebody'; the story does not mention who tells the father about his ship with the cargos; Melissa has rendered this S.U. intelligible by deducing that somebody called him. It also shows us that she has used another result, an external ; logical one, in that, if you 'hear' some news then someone must tell you; a simple logic of communicational processes deduced using secondary processing from the notion that, in this context, the receiver must have a sender. There next follows a string 'the man...the...um...Father.' This is the first time the father has appeared and it almost seems like he is an after-thought; it is also confusing here at this S.U. because we can see from the interview that 'Father' is her favourite character. This may have something to do with the fact that until now the story has referred to him as either the father or the merchant; what we can say is that with the addition of 'um' the reader is bringing one of the story's very primary signifiers into her representation by allowing her to substitute the signifiers - father for man. It is as it were a transition not only at the grammatical level but also here at the signifiers.

On the other hand, the next 'um' operates in a different way in that it is more like a question to herself along the lines of : 'what happens next?' This 'um' seems much more like a mnemonic than a significant sign. (Although that does not mean to say that it's not in some way significant - just that it is not clear what it is).

Level of Semiosis : the first message here deals with the connotation from the Affect-Signified level that : 'fairy tales offer a glimmer of hope'.

The second message goes something like : 'the man in the story is also a father'. This is based upon the substitution she makes of man for father. Support for this is also the fact that in Text 1 this is when the father asks the daughters what they want from the wealth that the cargos would bring (i.e. a fatherly action). It also gets validity from two other sources. The first is the interview where the father is generally seen as kind and generous - 'he got what they wanted' (see 2, 3 and 61). The second area of support for this message is this S.U.'s structural relationship with S.U.'s 2 and 4.

S.U.4 *... and the daughters....when he....the daughters had to do all the cleaning and the washing because they had to move in a small, little cottage.*

Level of Affect-Signified : we have here the familiar patterning of the 'lure' but, whereas the insecurity of Text 1 was in the context of the theft of the money by the captain, for Melissa the insecurity comes out of S.U.2 where it really belongs.

Level of Grammatical Unit : as such it requires an 'event' label.

Level of Results : how has she made Text 1 coherent and how can we tell from her presentation of S.U.4?

The '...when he...' string is fairly easy for it refers to the proposed leaving of the Father and is, therefore, a completion result. The move

into a small, little cottage is also a completion result from S.U. 2's fire. On the other hand, Melissa seems to think that the reasons they have to do the cleaning and washing is because they moved into a small cottage - there is no mention of the loss of wealth directly it is only signified in the size of the house, which is strongly emphasised.

Level of Propositions : the reader is stating certain things.

Level of Signifiers : putting the S.U. together as a whole it seems reasonable to assume that she has mixed up the sequencing both within and between. Within, she realises that it is not only 'when he' (leaves)..., that the daughters are forced to do the housework; between the important point is the way she attenuates S.U.2 making it that much more significant than it is in Text I by placing it in S.U.4.

Importance is also signified in the emphasis she places on the size of the cottage signifying the loss of material security. She does the same thing, for different reasons, with the emphasis on 'cleaning and washing' as opposed to 'cooking and cleaning'. We can see from the interview at certain points that 'doing the washing' is extremely important to Melissa. (See 5,6,7,8,12, 14).

Level of Semiosis : the use of attenuation by mixing the sequence of Text 1 gives us a clue as to what message the reader has picked up from the story. It is clear that washing-up in the house is an important aspect of Melissa's daily life and she makes a point of associating herself

and Beauty as two girls who get on with their chores; 'she just did it'. Not only does Melissa not grumble she actually asks her mother if she can do it! Inter-textually too both Cinderella and Snow White are characters who do the cleaning and it is hard not to conclude that selfishness (not being nice) is connected with refusing to pull your own weight in household chores. Melissa's mother confirmed that it was part of their philosophy that little girls did chores that fitted in with sex-roles (making the beds was the example given) and that, according to the mother, Melissa's father is also intent upon her washing up and cleaning her bedroom.

The message here goes something like : 'washing up without protest is being a nice girl'. This message is caught up with the reader's experience of having to do household chores that the parents consider to be suitable for her. She has given 'washing-up' an inter-textual context and it seems that Beauty and the Beast is also important for the reader in that selflessness and how to 'give' as a girl are associated with chores. Text I makes it quite obvious that the sisters' greed and vanity is manifested in their reluctance to help around the house; wanting nice clothes and jewels is also to complain about work. To this extent then we must add another result, internal : similarity, the grumbling sisters have already been marked as selfish.

This S.U. is an extremely good example of a social codification (little girls should do things like this) having structured the reader's experience⁽¹⁵⁾ - the sisters grumbled but then again they are selfish

(15) Parental injunctions also play a role of course it is simply that this story is yet another way of allowing Melissa make sense of why she has to do the washing up in the household.

(i.e. not nice). Melissa seems to be well on her way to recognising this as a social necessity or more correctly as a 'natural' ⁽¹⁶⁾ way of being; so what was signified on the Affect-Signified level in Text 1 as selfishness appears on the S-level of the representation as a connotation about a way of doing as a girl in society. We can see this as well in questions 35 and 36; with Beauty gone they 'had' to do the washing up but the question of the brothers (who seem to do nothing at all) taking part in the 'feminine' chore of washing up is doubted by Melissa; this is true even though they were nice like Beauty, i.e. not selfish (see 33).

The evidence seems to converge upon the fact that her experience of washing-up etc. has been structured by a social code put forward jointly by her parents and fairy tales as the proper way of doing. Because of this it seems reasonable to assume that Melissa has used an external : cultural result to read this part of the story.

Between S.U. 4 and 5 there is a very long pause and we must consider whether she has simply forgotten the story sequence or whether this is a significant lapse. My position will be that this pause is significant for it is related to the last S.U. in that it indicates that she realises she has mixed up the sequence of the story with S.U.4 and in fact over-emphasised the importance of the washing up in the first part of the story. But the pause is also related to Text I in that, after the disappointment of the theft of the money incident, the story begins

(16) This idea of a naturalisation of social forms of being is part of the 'conspiratorial' nature of codes and codifying. The structure and function of Text 1 makes this clear as does the work of Leach (1964) and especially that of Barthes (1973).

all over again with the arrival of the Beast himself. Consequently, it seems reasonable to have a pause here because structurally the first part of the 'lure' is over. We can see also that in terms of the 'lure' an important negative affect is omitted in the space of the pause; its silence 'contains' the disappointment of the father (and the reader). In fact S.U.3's ships with cargos is not completed at all rather it is completed by the washing up that refers back to S.U.2. One cannot help but get the impression that the importance of the 'selfishness/washing-up' association has caused the reader to end the narrative at its most significant juncture for her; although Text I allows this she has used this allowance in her own peculiar way and it is only by encouraging her to go on and to 'forget' for the moment 'washing up' and its meaning that she can start the story again.

S.U.5 *I think he got a rose*

Level of Affect-Signified : where one would assume the affect to be most powerful for the daughter/reader it is most flat; but this is only if we concentrate upon the linear reconstruction; in the interview on the other hand the affective power of the rose is very clear. The sequence of questions from 28 to 32 shows that on the level of affect signified by the rose in our culture Melissa knows about the code.

Level of Grammatical Unit : this is the first part of an episode.

Level of Results : this relates to the cultural use of the Rose but as the interview makes clear, she is also aware that the father is 'getting

what Beauty wanted'; see in particular questions 2, 3, and 28 where she at once identifies with Beauty and projects herself into Beauty's position of wanting a rose. So it seems that she has rendered the original S.U. coherent by an internal completion result which is also related to the code, i.e. a double edged result. It is also clear that she has used an internal : similarity result in that father got what 'they' (see,2) wanted. This refers to S.U.1.

Level of Propositions : an action has taken place.

Level of Signifiers : the 'I think' is simply a response to my urging her to remember. The case values are straight-forward.

Level of Semiosis : from the re-presentation we can say that she has got the message about Fathers and Daughters and their affection for each other. The taking of the rose to her teacher, even though female, indicates the use of the rose in the context of 'parental' figure which, when combined with the fact that he got what she wanted, signify the reciprocal nature of the giving of a rose in our culture. We can say then the message here is : 'the father loves his daughter very much.' We can see that Melissa's experience surrounding 'roses' is highly codified by the rule and is, therefore, an example of a strong coincidence of 'codes' that is to say, the affection for her father and his for her (i.e. Melissa's perception of it) is intelligible or structured in the rules about roses manifested both in the text and in her life.

S.U.6 *and he got into trouble with the Beast.*

Level of Affect-Signified : the affect here is quite simple : an insecurity caused by the 'getting' of the rose.

Level of Grammatical Unit : the second part of an episode opposed to the first part.

Level of Results : 'getting into trouble' signifies that she has gone to her experience of the 'law and order code' to make the incident in Text I coherent. So this is an external : cultural result.

Level of Propositions : once again an action is taking place.

Level of Signifiers : the 'and' is a familiar device used by the reader to connect S.U.'s. The expression 'got into trouble with' is idiomatic and is left in the intermediate analysis as such. The case values are straightforward.

Level of Semiosis : the message here is in the code of law and order and goes something like : 'he stole the rose from the Beast'. Once again we can see the connotation from the Affect-Signified level established by the code.

S.U.7 *and he asked her ... um ... him to let Beauty... um
 come to him ... and so she ... um ... came*

Level of Affect-Signified: Although from the re-construction the affect is again quite flat there is an insecurity here. The interview indicates

that Beauty coming to the Beast generates some insecurity. Question 19 contains attributes like 'powerful', 'horrible-ness' that are bestial possibilities. Most important is the insecurity because of separation referred to inter-textually; The Miller's Daughter is her second favourite story.

Level of Grammatical Unit : A transition.

Level of Results : this section is complicated because of the slip 'and he asked her'. I have called this an internal: future⁽¹⁷⁾ result in that it seems in part to be the result of the Beast's offer of marriage which happens, in Text I, much later. We can also see from the interview that inter-textually the 'giving of daughters' is a primary theme in both Rapunzel and the Miller's Daughter. Beauty's arrival is an internal: completion result.

Level of Propositions : Action

Level of Signifiers : the slip of 'her' relates to the marriage proposal that happens later on in the story. But this is interesting vis a vis Text I which contains the message about what the Beast wants with 'one' daughter; the reader answers this question without waiting to build up suspense, all at once.

The first 'um' here works in much the same way as the 'um' in S.U.3. The reader substitutes him for her and the next two 'um's' seem also like the mnemonic 'um' in S.U.3.

(17) An obvious contradiction in terms but it captures the 'foreshadowing' that goes on.

Level of Semiosis : S.U.7 is an important place in the reconstruction from the point of view of the meaning that the child is getting from Text I.

At one level we can see that the reader fails to keep the suspense sanctioned by the problem solving code in S.U.8, Text I, so in a sense we can say that the reader has picked up on the question the story was posing at its S-level. But this is also the first time that the three main characters have appeared in a dramatic situation together and the substitutive 'um' allows us to see that, for the reader, Beauty and her father belong to the same paradigm and are in fact inseparable, in the first instance, from each other. This is the message then that rests upon the insecurity of separation signified in this S.U. : 'the father and daughter are inseparable'. Support for this comes from the interview in questions 24 to 28 where the closeness of the two is quite marked.

With 28 we can see the return of the 'one' sister who can now no longer be considered a mistake, '.....she said it was ridiculous'. It seems pretty clear that Melissa is attaching quite a lot of blame for the separation of daughter and father on the one sister, '.....he didn't want her to go' and '..... I felt sorry for him', (and finally)..... 'maybe she (Beauty) didn't want to go' (27).

But we know from the original text that the real blame lays at the feet of Beauty in a logical way; if she had not asked for the rose then father would not have 'got into trouble' with the Beast. On the other hand, although the sisters are quite right (for Melissa the sister)

the reader exerts a righteous indignation, '...but I thought it was all-right, I'd like a rose', which can only be sanctioned socially, i.e. by the code of roses in the context of daughter and father; 'all-right' can be read as 'socially acceptable'. We can see that in question 32 it is all right ' to give the rose to the teacher even though one is not allowed to pick them oneself (Melissa's father is the family gardener); one supposes that picking roses oneself would 'get you into trouble'. The overall impression is of a shifting of the blame for the father's predicament which is itself defused. The real affect here: the separation anxiety and sense of responsibility for the dilemma, are drained from the linear reconstruction and displaced in the interview from Beauty to the 'one' sister or, from the reader's point of view, from Melissa to whomever this 'one' sister is in her situation.

This multi-functional S.U. faces not only to the paradigmatic similarity but also to the future and, on the way, cuts out the suspense of the story⁽¹⁸⁾ by answering the questions posed by Text 1. On the other hand, we can see from the interview data that this S.U. is fleshed out by Melissa around the signifier of 'one sister'; i.e. the implications of the story at this point centre around the sister and the desire Melissa has to 'make sense of her' : this results in a further message that : 'the father and daughter are separated by the sister'.

(18) It could be argued, I suppose, that there is little chance of a suspenseful reconstruction because she has read this before and many times. This would be to miss the point of the 'favourite' story; the reader 'lives' Beauty's situations and the interview makes this abundantly clear. It is also to confuse re-presentation with recall; the reader is making sense out of this story for herself, not testing her powers of remembering.

This two-part message is a good example of where Melissa's experiencing of the story is well structured by codes - the rose and the father/daughter - and also where codes cannot bind the reader's experience because a particular signifier is too important to the reader, i.e. the one sister. The continual use of this sister shows an idiosyncratic primary processing at the same time using, of course, the context of the story's other signifiers.

From the point of view of the 'lesson' the story has already led the reader to associate this sister with extreme selfishness, very unlike Beauty (and, therefore, Melissa) yet it remains, at this point, unclear as to whether the essential lesson, a girl's selflessness faced with a man's desires, is being interiorised.

We can, however, see something of the primary structure of Melissa's thought centred as it is around the selfishness (not nice) and Father. The idea of being 'nice' is processed by Melissa, in this context, as a girl helping around the house unlike the 'one' sister. What is missing of course from this chain of signifiers is 'marry' and one of the functions of this S.U. has been to 'include it out'.

The importance of this S.U. in the interpretive process from my perspective is unmistakable : a lot of affect is 'crunched' into this S.U. : we can see too the processes used and the particular way Melissa makes sense out of this part of the story; her ability to grasp the social themes and at the same time to flesh out, as part of the task of reading, the implications of the text for her.

S.U.8

But she broke a promise when she saw
her father ill and she said she'd come
back after two months but she didn't

Level of Affect-Signified : the affects here are selfishness where Beauty's breaking of the promise is combined with the father's illness. In terms of the affect-signifieds this linking of Beauty's behaviour with her father's illness serves the function of lessening the selfishness signified; Test 1 after all proposed the selfish act after the father had recovered, Melissa proposes it contiguously with the father's illness. It is interesting to note that this lessening of affect seen here is the heightening of affect seen in S.U.1 where the twin themes were given special emphasis through the inter-textual result (see the use of Cinderella) and it seems that this is one of the processes reading; the intensity of affect can be manipulated by the reader for comprehension.

Level of Grammatical Unit : this is an event because of the specificity of affect (even though reduced in intensity).

Level of Results : we can say with some certainty that breaking the promise and the terms of it (2 months etc.) have been rendered coherent because of her father's illness. This would be then an external : cultural result based upon the affection (duty) of daughters for fathers; this accounts for the lessening of the affect-signified.

Level of Propositions : the overall impression is that Melissa is stating information.

Level of Signifiers : 'but' is a significant conjunction here; it allows Melissa to contain the idea that Beauty went home in the first place in order to break the promise. Until now the analysis of S.U.8 has not been able to tell us where Beauty's behaviour takes place the use of 'but' at one level indicates an opposition of situation; it could be expanded to say 'but she did not stay with the Beast'.

Similarly 'but' plays another role in which it introduces a complex re-construction based around the case values of time and location⁽¹⁹⁾. This S.U. signifies a certain diluted affect through the manipulation of contexts. We know she broke her promise at her home but Melissa would have it that Beauty broke it when she saw the ill father, this really takes place in the palace as does in fact her promising to come back in two months; on the other hand 'but she didn't' is located at her home. This mixing of the time and location of acts in the story actually take place is an important part of her re-construction for two reasons:

- (1) it allows her to integrate this S.U. so that it signifies a lessened affect of selfishness (Beauty/Melissa are not selfish it is the sister(s) who are) and continues a process of displacement of the responsibility that we saw quite clearly in S.U.7 where the sister comes in for the blame.
- (2) Grammatically she contains the movement of the story in a static event and so what is stated as mere information in the

(19) Although no location value is given in Table 3.2 S.U.8, it can be seen as an 'understood' case; events must take place somewhere. It is, however, true that 'location' is significant here because it is not mentioned which contributes to its grammatical function.

reconstruction is in fact significant in the story; especially the mixed feelings the story is trying to create concerning the Beast and his humanity - in effect his prospects as a groom. This facilitates the process of omission; the vital absence being the Beast's sadness at letting Beauty return home and his warning of what would happen if she broke her promise.

Level of Semiosis : when we come to the meaning that the child is taking from this part of the story it is a connotation arising from the weakened selfishness : 'Beauty breaks the promise because of her father's illness'; in fact, for Melissa there are mitigating circumstances. We have a certain support for this in the interview at questions 26 & 27 where Melissa ventures the idea that they did not really want to be apart in the first place (although she changes her mind after the transformation of the Beast, see 39).

So even though Beauty has wronged in breaking a promise the whole S.U. goes up to make it not such a great crime. The code structuring this is the father/daughter code and a drained affect of selfishness is necessary for this message.

In many ways this S.U. rejects the possible metaphorical substitution of Beast for Father. In the original story we have seen how the Beast and the Father are related through affect and Beauty's reactions. Melissa condenses all this and creates a metonymy (I) which distorts just when and where she breaks her promise; the association is with Beauty and her Father which follows from the inseparability mentioned in the last S.U. and continues here. The interview brings this out at

question 17 where she is stuck for another character as her favourite. This is also the case at question 23. On the other hand, it seems clear that when she is probed about the Beast, 18 - 21 for example, she has a representation of him and his relationship with Beauty, '... he didn't ... he wasn't horrible to Beauty!'. Is this representation of the Beast part of the same network of association as the father? The nearest she does come to associating the two is through the relationship between the signifiers, 'cruel' (see 3), 'powerful' and 'horrible' (see 19) furthermore the opposite of 'horrible' seems to be 'nice' (19) and one of the meanings given to nice is 'selflessness'; the Beast was not selfish with Beauty, but then neither was the father. It seems that the only other person who is selfish is the 'one' sister who receives this affect within the context of 'household chores' and as the person responsible for the father's/Beauty's predicament - it was 'all right to ask for a rosé!'

In general the meaning being 'grasped' in these last two S.U.'s has to do with 'mitigating' circumstances; i.e. displacement in S.U.7 the sister was at fault; in this S.U. Beauty's breaking of the code of 'promise keeping' is displaced onto the father's illness (the father/daughter code) and I have shown how she does this through a metonymy that mixes up the dramatic structure, especially time and location. Finally, once again we can see the blurring of the distinction of S-level messages in that here there is a strong coincidence of codes. The mitigating circumstances also relate to Melissa's feelings for her father and they are insinuated into the re-presentation because of these feelings - why else put them it?

S.U.9

... and so um she dreamed that she saw um Beast um dead under a large tree and when she went there she did and then there was thunder and he woke up.

Level of Affect-Signified : where we would expect guilt through the making amends, especially agreeing to marry and declaring love for the Beast, we find instead excitement. Furthermore, this is the first time in the re-presentation that an affect-signified is found solely in the interview primarily at question 20 but as I will show below made coherent within the structure by other questions, see 55, 58.

There is also an overriding insecurity here that must be part of the excitement that Melissa feels when reading this part of the story; the Beast is dead and then 'wakes up'; Beauty had to go to him and the thunder and lightning (see Drawing 1) constitute a 'good scene', see 58.

Level of Grammatical Unit : she has managed to combine here an episode and a transition; the reason that these are in one S.U. is because of the affect of excitement that is signified. In fact this is an event because of the affect but it is very difficult to classify because it is not really specific - the excitement is diffuse and contains many components. In any case we can say that vis a vis Text I so much is drained out of the original that Melissa more or less states what has happened. Because of this I would like to say that this is probably best classified as an Event.

Level of Results : this level starts to give some clue as to what it is that excites Melissa about this part of the story. Through the use of External : inter-textual results Melissa fills in gaps that are not so much part of Text I's structure (I have shown how 'neat' this is) but Melissa's perception of these holes.

The scenes that Melissa is reading are structured in the first instance by the fairy tale code through the inter-textual result. We have especially here both Rapunzel and The Miller's Daughter which fall within the code. But on the other hand even though they fall within the fairy tale code and are good examples of it (the selfish witch and the magical transformation of hay into gold) what Melissa actually uses them for vis a vis how she fills in her constructed gaps is much more idiosyncratic and 'asocial' than the code.

From the context of the fairy tale code Rapunzel is the main story that she uses but her second favourite story, The Miller's Daughter, is used as well and both will be discussed in the Semiosis section. It is probably a safe inference that she has used an internal : completion result as well - the string 'and so' seems to indicate this.

Level of Propositions : the overall dramatic structure is factual although what is stated is active.

Level of Signifiers : 'and so.....' as mentioned above is one of the ways that Melissa signifies the completion of a previous action, see S.U.7. This conjunction though is slightly more of a 'therefore' than that in S.U.7 in that it is the result of breaking the promise; it is

much more definite given the code surrounding 'promises'.

The 'ums' here seem to have the function of de-affecting the unit; after all Beauty is going through a lot of agonising in this part of Text 1. The 'ums' seem negatively mnemonic, simply allowing her to get onto those aspects that she desires to reconstruct and which also allow her to remain coherent.

The primary signifiers in this S.U. are the 'and she did' and 'he woke up'. The first represents an enormous simplification. What seems to have happened is that she would rather not reconstruct this part of the story. Question 55 makes it pretty certain that she knows what happened and that the declaration of love and marriage are the cause of embarrassed laughter. The Beast's beastification and transformation into a prince is elaborated in the interview by the inter-textual experience i.e. Rapunzel. The question is : what is it about Rapunzel and, for that matter, her other fairy tales that make sense out of this part of Text 1?

Level of Semiosis : we have here, I think, at this moment of her greatest excitement in reading the story her most important statement of the solution she has imposed upon the structure offered to her. We also have the explanation as to why she is excited. The expression 'she did' is a displacement. We have seen this process before in Melissa's reconstruction and what she is consistent about is who receives the negative affect that the text has tried to signify (and, in fact, through its own conspiratorial process get the reader to accept) : that person is the 'one' sister.

Fitting Rapunzel into all this is very interesting from the point of view of the model of reading; the inter-textual result leads to a particular area of experience which has been structured by the fairy tale code; in this case the code structures the 'transformation' of characters. In Rapunzel the prince is made blind (not by the witch as Melissa would have it but because of a fall when he thinks Rapunzel is dead) then transformed back into a prince and they live happily ever after. There is a fairly concrete rule in the fairy tale code that says that people - and characters generally - can be changed and changed back again. So we have at a very coded level the message : 'this is a fairy tale'.

Why does she consider Rapunzel to be also a good token of the code? The answer is that there are other attributes of this story that make Melissa's understanding of Beauty and the Beast coherent for her. Rapunzel is about the 'giving of a child' and so is Beauty and the Beast; the difference is that whereas in Beauty and the Beast it is the Beast who is receiving the child; in Rapunzel it is the witch. Both the Beast and the witch covet and keep the daughters; but whereas the Beast becomes steadily humanized, the witch remains evil, jealous and vindictive right to the end. The stories are similar in that it is the daughters who 'break the spell'; in Rapunzel her tears make the prince see again (he 'wakes up'). In our text we know that it is Beauty and her love of the Beast that make him 'wake up'. The difference is that there is no spell in Rapunzel but there is (or was in the past) in Beauty and the Beast.

Now we can 'enter into' Melissa's solution and the problem she is solving here where the difference makes a difference. Rapunzel is distorted by Melissa (i.e. she puts a spell into that story) in order to realise the primary difference which is the fact that whereas Beauty has no mother, Rapunzel does in the form of the jealous step-mother.

We do not have to go far to understand this: in Text I we saw that the mother was significant because of her absence - 'mother would have got in the way' and for Melissa she is quite definitely no longer part of the mother-father-family paradigm - 'she's dead', see question 60. Furthermore, from the interview the inter-textual clues are very strong in favour of the significance of the mother as this 'one' sister that is constantly referred to by Melissa. Snow White is used because of the jealous and evil queen who just happens to desire to be the most 'beautiful'; although 'she hasn't got two sisters' she has got what Beauty hasn't got and Melissa does have a mother. So in fact does Cinderella, '.... a wicked sort of mother, but she (Beauty) hasn't got one you see.' (Question 12). All the stories including her 'second favourite' contain what the 'authors' of 'Beauty and the Beast' felt obliged to leave out. Not only does Melissa reinstitute the mother back into the family through the inter-textuality but also through the 'one' sister who is greedy, vindictive and does not care for Beauty very much.

Text I had to leave the mother out because of its messages concerning 'men-selflessness-guilt' etc., but Melissa has to have her included.

The reason for this is simply that in the context of the story of Beauty and the Beast within the structure that it has and within the context of the reader's life - her existential predicament - mother needs to be understood; she is part of her thought at this moment which she wants to have structured for her. The relevance of Beauty and the Beast is that it attempts this with the affective context of selflessness v. selfishness; furthermore it links this very often with the primary affective contradiction : security v. insecurity.

Now we know for certain that, in Melissa's family, being selfless takes the form (there are probably many others) of doing the household chores; not only that but they are the chores that 'women' should do (Snow White washed up at the dwarf's house). It seems clear that the contradiction that Melissa feels is structured and has been structured around the selflessness v. selfishness and that the mediator is the 'one' sister who, in Melissa's context, must be the mother.

But this is a displacement in that it is much easier for Melissa to unload this negative affect on a sister than on a parent⁽²⁰⁾; all the bad feelings, the greed, the ridicule and the grumbling are associated with this one sister who is once removed from Mother and twice removed from the centre of these feelings, Melissa herself. We can see that she does this for two reasons:

- (1) Melissa knows that she too is selfish; in question 65 she is the one with the most clothes in the family, and

(20) In the Introductory Lectures (1974) Freud makes a similar point in discussing the arrival of a brother or sister and the incumbent's reaction; 'it is even true that as a rule children are far readier to give verbal expression to these feelings of hate than those that arise from the parental complex'. (p. 377)

(2) it seems a reasonable inference that she would feel selfish if she did not wash up in her house and this is obviously how her family gets her to do things; by making her feel selfish they present the possibility of a withdrawal of love or security; no-one loves a bad girl; one who is not nice. For Melissa, rather than contain this, she gives it to the mother and as a consequence she surpasses these feelings (momentarily) and the solution takes on what Dunker (1972) would have called a functional value.

Also this same feeling she has is related to her relationship with her father; not only is her father, according to the Mother, keen on her doing female chores, but he is also clearly adored by his daughter (see 61) but whereas in Text I Beauty and her Father were extremely close (she was his pet) this relationship in Melissa's family is impossible, mainly for the reasons that it was possible in the story; the mother. It is the mother who separates father and daughter (S.U.7) just as it must be the case in Melissa's family. So once again in a different yet related context the mother mediates these feelings for Melissa, she is both selfish with husband (father) who sides with her in the household chores problem - and selfless in that as her mother she cannot be all bad.

Beauty and the Beast provides an almost perfect mirror for the child; what it lacks, and must lack, is a mother; Melissa fills in the gap that she perceives in the text. This is her favourite because the contradiction that Melissa feels between her selfishness (she has the most dresses) and her selflessness (she asks mother if she can do the washing up) is within the context of female duties that are being thrust

upon her in the process of feminisation and also within the context of her relationship to her father and mother. The displacement of the affects onto the mother/sister as mediator momentarily resolves this feeling but it can never be a final solution. For underlying all this is, of course, the primary contradiction which permeates the use made of the two secondary affects. Selfishness, she has been taught, leads to insecurity, a withdrawal of love and consequently a sense of guilt; selflessness on the other hands leads to security, love, recognition etc. Faced with this Melissa, in real life, has little choice but to situate herself, if she wants recognition, closer to the 'nice' girl position than the bad. This means doing certain things like washing up. But we know too that the text had other 'things' in mind; the switching of her desire from father to another man motivated by guilt. Melissa's lesson was to be that she would be living one day within the context of 'other' household chores burdened by a sense of guilt. Up to now the process of uncovering the reader's reading has been based upon the model and its system; that is to say the inferences have been tied down. When we come to that area of her thought containing herself, father, mother, selflessness and guilt all the interview reveals is an embarrassed laugh and an 'I don't know'.

This is obviously a denial of the facts of the story concerning marriage and love and guilt. What must be asked is : how far does the data support the notion that Melissa has interiorised the lesson? There are two peices of evidence directly related to this : the first is the nervous laugh when she is asked, in a more direct way than usual, about the final interaction between Beauty and the Beast. Her denial, 'I don't

know...' combined with the laugh that indicates that she does know, or has a fairly good idea.

The second piece of evidence comes from her second 'favourite' tale (see 57, 58). This story is also about the 'giving of children' but her answer in 58 allows an interpretation that seems to indicate a further denial of the story's lesson and that, in fact, although she may have it, she does not feel ready for it.

There are two points to be made at 58:

- (1) It seems clear that she has made a strong identification with the Miller's daughter : she tells us as much in the slip 'I haven't' and her correction of it, '... and she says ...'.
- (2) The next slip is very important. Melissa says that Rumpelstiltskin asks the Miller's daughter for her children 'when you grow up' but the Miller's daughter is not a little girl - she is very marriageable and is, in fact, married to the King three days after meeting him and they soon have a baby. It is in fact Melissa who is the little girl that will have to grow up, get married and have babies. I would argue that Melissa does not feel herself to be ready for that now.

The Miller's Daughter is significant for the solution as indeed are the other texts. Cinderella, Snow White and Rapunzel share one important thing in common : they contain wicked mothers! The Miller's Daughter does not; rather it contains a good mother who loves and cherishes her

baby, '.... but she didn't want to give her young'. Once again the emphasis is on the mother but this time she is good; just like Melissa will be when she grows up. What constitutes a good wife/woman/mother is what Melissa has to learn and Beauty and the Beast is one way of positioning the reader in this problem.

With this analysis of Melissa's solution the thesis reaches its limit best signified perhaps by the embarrassed laugh. The point is that although the evidence indicates that she has denied the lesson this does not mean that, as in the analysis of Victoria's reading, this structure has not been packed away for future use when she is grown up.

What I can do is to point to the evidence that is all around the 'laugh' and add that it should be remembered that Melissa is in a process of becoming and trying to make sense out of her feelings and the world. The primary signifier for her is the 'one' sister the analysis of which has shown its importance in the re-presentation and Melissa's life at the moment. She is reading the story to 'get' the one sister; i.e. to understand her in the context of family life.

The last point accounts for the excitement that Melissa feels which she would rather put down to 'it's just a good scene'. What is exciting is that she has been allowed by the text to explore the meaning of mother. Put another way she is exploring the code that will enable her to understand herself in relation to Mother and father and this is exciting.

This is not to deny the entertainment that is going on; the thunder, lightning and transformation etc. it is to point out that through the entertainment the child is allowed to explore or 'flesh out' the meaning of mother and, in this case, females (herself) generally. There can be no greater excitement than being allowed to make what is inarticulate, confusing and unstructured, clear. But the price of this is her 'feminisation' in other areas such as doing the washing up.

As for the meaning grasped here it is very difficult to summarise because we have in S.U.9 the culmination of the solution imposed. She rejects, or refuses to enunciate, the switch of feelings from father to beast and instead wishes to situate mother in the relationship; this seems to me a wholly realistic type of solution. The message gained from the reading could be summed up, perhaps inadequately as: 'I love my father but my mother is a problem!'

What is missing here is the fact that the affective contradiction is Melissa's and that the mother is the 'surplus signifier' that mediates it; i.e. just as security and insecurity were contained by TOTO, so selflessness and selfishness are contained by mother who ultimately contains the primary affects because of the way these two secondary affects are related to them.

S.U.10

... and they had a wedding

Level of Affect-Signified : the happiness here is quite genuine; she is happy for Beauty, the Beast and the father because 'he wanted her to get married'. (See 39).

Level of Grammatical Unit : an ending which is much like an event.

Level of Results : all the other fairy tales used have a happy ending therefore we have an inter-textual result and there is also a completion result; she wakes up'.

Level of Signifiers : 'and' indicates a completion; 'they' does not include, for Melissa, the sisters, see 51.

Level of Semiosis : the reading of the story could be said to have ended in S.U.9; S.U.10 is really a very classical denouement but significantly Melissa would like to emphasise the rapprochement with the sisters (I am assuming especially the 'one' sister) which does happen in the story but which, I think, Melissa does not quite believe (see 51). In fact, this supports the analysis in S.U.9; the problem with mother (and herself) is never solved; only mediated. So the happiness signified here is only partial; she would really like once and for all to be at one with her mother - but in her 'existential predicament' this is, at the moment impossible. So the message here is that the situation is not entirely happy and also the Fairy tale message is not far away in this S.U. as in the last.

By way of summary we can say that whereas Bettelheim would suggest the text offers 'subtle solutions' to affective problems, what the reader does with these 'solutions' (in this case the switching of feelings) is largely the result of the person reading the text. We cannot say for sure that the lesson has not been interiorised as a structure to be used later on but I have tried to point out how the developing reader

is caught up in a process of structuring which offers her the chance to think in a particular way.

3.4 Conclusions and Discussion - Overview

In this last section of the thesis I want to summarize some of the gains that have been made, i.e. what has been learnt about texts and reading. I also want to situate the work within the general academic problematics of psychology and semiotics and state more clearly the case mentioned above for a psycho-semiotics. Finally, I want to outline the methods used so that the presented analyses can be carried out by interested readers on, not only other childrens' literature, but perhaps on other semiotic systems with other psychological readers.

3.4.1 On Reading

It seems clear now to me that reading can be seen as a type of problem solving along the lines of the emotional problem solving originally posed by Bettelheim (1978). But the process is not as simple as Bettelheim made out; the overriding process is what I have called 'naturalisation' a term borrowed from semiotics. What I have shown is that, in the case of fairy tales, this process of naturalisation is directed by the story and in fact it is a 'conspiratorial' goal of the text to direct the reader to 'natural' ways of thinking about their problems. The important point is, of course, that these ways of thinking and being proposed by the text are not natural at all but social and accepted and thus 'necessary'.

The process is carried out by filling in of the text. What is filled in is a perceived lack or need in the text that is also felt by the reader, i.e. there is an affective structure in the text that is relevant to the reader's life. This structure is based in the two primary affects of Security and Insecurity. Structure, however, is not enough for it is important that a relevant content also be presented in the text for it is primary signifiers, surplus signifiers, which are the vehicles of this process.

Reading vis a vis the structure of the text is extremely selfish; Victoria read for the desire of a dog, Melissa to come to terms with her mother and father. The text offers a structure which is rich in signification both at the level of affect and semiosis but the potential of the text to signify negative affect is from the analysis presented reduced and flattened; the guilt intended for Melissa ends up at the feet of the sister; the fear in the Wizard is reduced in the telling. It is not a case of children reading 'because they like to be frightened' but rather in order to find out about important problems they are faced with as they grow up cultural artefacts lodge the answers in insecurity. The most important process that gets the child through such stories is displacement of affect onto a signifier that is well positioned to take up the surplus affect. This use of the text is extremely clever; the main point of Beauty and the Beast was to direct the reader to thinking about the Beast, marriage, guilt and herself, but the reader uses the story to think about her mother - she postpones the grim reality she will one day face, she stays as a child attached to her father and finding every reason to distrust her mother. The important point is that

at the centre of reading seems to be but one primary signifier, mediating primary affects, satisfying desires and central to an enormous network of signifiers whose connections are more or less directed by codes, and whose implications the child will explore in a more or less directed way to make the text intelligible.

We can see, too, how the process of reading is underpinned by language itself, in that any thought about signifiers is possible because of the twin poles of language metaphor and metonymy. Investing meaning by exploring (Empson) one's chains of signification (Lacan) is a process of selection of signifiers and fleshing out the wholes which form their contexts. The one sister is both metaphorical, a selection and metonymical, part of a context, which if she could explore it fully would eventually lead to attaching negative affects to signifiers which would cause great distress, viz, either her mother or herself. Instead the affect is displaced onto the surplus signifier.

We could state this from the point of view of literary criticism. The reader re-writes the text foregrounding that which is central to her thought and backgrounding that which is unwelcome to her thought. If this is true then the background is there and there is good reason to assume that this background, at another point in time, could be foregrounded. The notion as to whether structures which the code has tried to create are totally lost or are simply packed away for future reference cannot be shown in this thesis but it still remains a very good possibility given the reader's involvement in her favourite fairy tale. Again, this involvement is axiomatically based in the processes of identification and projection; the reader identifying with the heroine situated in a particular structure with a particular content.

3.4.2 On the Text

We have seen how the text is a coherent, integrated structure that depends upon the dramatic structure of language. The goal that I set at the beginning was to uncover what the child was faced with and my answer is a semiotic system with social psychological intentions.

As a semiotic system it depends upon the twin poles of language. It offers through its structure the possibility of significations being transformed from the text (Type I) to the world of the reader (Type II). It articulates a particular world for the reader by proposing metaphors and metonymies which are social psychologically acceptable.

The text is a coherent structure which offers directional indicators on where to go to find its coherence, either in the text itself or externally in the reader's experience. Most importantly, the text has an affect structure which is an integral, inseparable part of its semiotic function.

The text grammar shows that the fairy tales considered are also literary facts which have a macro structure that attracts the reader and then teaches the reader but we have also seen how this and indeed all other levels are integrated, speak with one voice as it were; they are all marshalled for its conspiratorial intentions.

3.4.3 Psychology and Semiotics

One of my goals was to show how any signification could be grasped from the text. If the reader is Bettelheim then an extremely well worked

out thought structure is brought to bear upon the story i.e. the meta-psychological framework of psycho-analysis especially that which deals with the Oedipus complex.

It seems clear though that Bettelheim's is a 'second' reading; his involvement is different from the identifying child reader 'living' Beauty's predicaments. Even so I would argue that both readings, her's and Bettelheim's are accounted for by the range of meaning that the text grammar demonstrates is possible. The difference between the readings has to be located in the signifying chains each has explored in order to render the text intelligible, the framework brought to bear upon the text.

The important point to be answered is where is the reader when reading? The semiotician would attempt to offer a theory of reading by describing all the systems of signification within a text but without or outside the reader who is 'only a methodological necessity'. The thesis has shown that reading is a psychological process and that the person is at a particular place in the signifying chains at a particular time. The semiotician attempts to map the entire field - the whole structure which is all the codes and sub-codes. There is never any attempt to study how the codes are used and produced. Without this there is no notion of reading; no subject with no development and no emotions.

Codes, like history, are produced from, what I have termed here, after Bettelheim, existential predicaments as such they are only independent to the extent that the users are, theoretically (cf. also Levi-Strauss)

negated from the process. This becomes apparent when the reader reads her favourite fairy tale in an attempt to solve a problem that is real enough both internally and externally for the reader; the process of development that this reveals is an active making sense out of the environment and its institutions. People produce the codes.

3.4.4 Method

The methods can be divided into two parts. The first deals with the informant and the second deals with the texts (1 and 2).

The methods in the first part owe a lot to in depth interviewing techniques and general ethnographic procedure. This must always be combined though with a certain experience and intuition, especially about primary signifiers, which is very like the key-word analysis proposed by Evans-Pritchard (1951)⁽²¹⁾. Above all one must listen to the informant and be sensitive to where she wants to go and does not want to go. The reader can also be asked to draw the story or parts of it. All the verbal data is recorded and transcribed.

In many ways the advice of the Anthropologist Clifford Geertz who recommends an "Ethnography of the Disciplines" (1973) seems valuable. That is to treat one's subject matter, in this case the child's version of a favourite fairy tale and associations to it, as an exotic language, from an exotic culture - first one must understand the language and how to use it. A photocopy of the text is taken.

(21) '... the most difficult task in anthropological field work is to determine the meaning of a few key words upon an understanding of which the success of the whole investigation depends.' (p.110)

The methods used for the texts are as follows.

After Levi-Strauss the text is broken down into a minimal set of sentences and, after Bettelheim, the criterion for this is the extent to which they signify affect; these are the S.U.'s. Next carry out an intermediate case analysis in order to clarify the original decomposition and to demarcate the Grammatical Units, Results and the case values for the signifiers which allows a propositional description in terms of dramatic structure.

The S.U.'s are then recomposed using the rule of integration. The notion of connotation and primary signifier is used to establish the S-level of message and code. The same procedure is used for both texts except that for Text 2 there are two different S-level messages possible. Also, through the method of 'convergent validation', the solution that the reader has imposed is sought from the representation and observation i.e. all available sources. The solution should come to light as the only possible mediation of an affective contradiction that has already been established in the first textual analysis.

Deciphering the solution will be helped if one is guided by Raymond Chandler's maxim:

"There are things that are facts, in a statistical sense, on a tape recorder, in evidence. And there are things that are facts because they have to be facts, because nothing makes any sense otherwise."

* * * * *

CHAPTER FOUR

SUMMARY OF THE THESIS AND ITS CONCLUSION

4.0 Overview

This chapter summarizes the main points of the argument. The first section deals with the goals of and reasons for the thesis. It outlines the problems and methods.

The next section takes the two main areas of inquiry - the reader and the text - and summarizes the gains made and how they came about.

The third section puts the research into academic perspective commenting on the relationships with cognitive psychology, Psycho-Analysis and Semiotics.

The last section is a concluding statement of the argument.

4.1 Re-statement of the Aims of the Thesis

The main aim of this thesis was to answer the question: 'What does it mean to read?' Within this general question certain sub-questions needed answering:

- i) the nature of comprehension: the relationship between meaning and affect.
- ii) the adequacy of current cognitive psychology's ideas on understanding and the need for a new approach to the problem of understanding.
- iii) the problem of the 'structuring' text; what is the reader faced with and how to understand this.
- iv) the position of the psychological subject when reading.
- v) the socializing aspects of the text; the text's relationship with the developing reader.

Reading is conceived as a clash of structures and the primary aim is to investigate this interaction. The main underlying point in this formulation of the problem is of two active structures. As far as reader and text are concerned we can see from the work of J. J. Gibson (see Section I. D) that, at a micro level of analysis, two active structures are engaged. On the one hand the perceptual systems actively search for invariances or structure

(they 'hunt for clarity') while the stimulus itself is 'active' in the sense that it is structured in certain ways that constrain the types of events in which it might be involved. This is the notion of affordances, that for example, a sharp object affords piercing; objects provide information for the activities and interactions they afford. This is what I termed the range of meanings of the text.

Within the context of the research, stimuli of high-order, such as texts, afford certain interactions and it is the aim of the thesis to understand the structure of these high ordered stimuli and the interaction they afford the reader.

Furthermore, the idea of available and effective stimuli gets its importance from the use of the girls' favourite fairy tale. At the level of high-ordered stimuli then, certain text will be effective given, what Bettelheim (1978) called, the 'existential predicament' of the child.

This leads onto two very important points for the argument I have presented. First, it seems clear that the concepts used by American structural linguistics for coming to terms with 'comprehension' are inadequate. I showed in Section I.2.I that the problem of the competence/performance distinction created an inadequate theory of meaning both at a formal and at a performance level.

Secondly, meaning is meaning for someone at a particular time and the child's favourite fairy tale is favourite because it has an affective function for the reader in her context.

What follows from this is that, given other 'existential predicaments', the reader will be reading another (effective) text. The problem of the stimulus aspect of the thesis is simply, 'What does this effective stimulus 'look' like and how does it work?' Semiology has been for a long time hard at work on this problem by uncovering the invariances that exist in cultural artefacts such as myths. This approach is presented in the thesis as a better method than that offered to cognitive psychologists because it provides a theory of meaning based upon the sign rather than the sentence and its grammatical syntax. It

also deals with 'real' texts as opposed to those made especially for psychological experiments. But the use of the binary method can be seen to be wrong. In the first place Levi-Strauss' analysis of the myth takes it as a sign open to a phonological analysis and in the second place he relates reading to a function of the brain.

This need to anchor one's theory in something substantial is contrary to the original semiological project. But we can also see it in the work of Bettelheim in that his anchorage is sexuality and therefore equally biological. The main point about both is the exclusion of the reader or subject and his or her place in the clash of structures. A prime aim of the thesis has been to turn both upside down and then consider the text for what it is: a narrative system of signs and also the reader for what she is: a person developing in a context. We now come to the effect one has on the other. The point is that a fairy tale is structured around affect and that this has an effect on the reader. This leads onto an important psychological point of the thesis: the relationship between meaning and affect and the impossibility of their separation which is a traditional one in cognitive psychology.

Sandler and Sandler state that for a stimulus to be meaningful it must be 'linked with feeling' (see page 116) and they assume that 'all meaning is developmentally functionally related to states of feeling'. The importance of these ideas is that cognitive or representational processes incorporate affective states; that the person will either through cognitive or behavioural processes, try to re-experience subjective aspects of his or her world. Consequently, the traditional division between cognition and affect is removed in favour of the concept 'thought' which unites both cognition and affect. What follows from this is that because representational processes are public (eg. language) and deal with role relationships between self and other(s) then the affect incorporated will be structured or constructed according to the relationships that exist in the culture in which the person develops. To re-instate Saussure here, the apprenticeship the child goes through is not just in the langue but in being as determined by the langue. Affect is

relational and not some thing according to Bretch, "We think feelingly and feel thoughtfully".

It follows then that certain stimuli afford certain relationships, certain meanings and that the fairy tale is assumed to offer ways of being to the reader so that she can continue her apprenticeship in becoming a citizen.

The next problem then is to depict the fairy tale structure that affords the range of meanings that could be effective for a particular reader. If we take the text for what it is - a narrative system of signs - then structuralist poetics have provided various ways of depicting texts. My argument for the structure of texts rests on the idea that signs enter into what Greimas (see page 121) calls, dramatic roles and that his idea is akin to the case grammar.

What the case grammar does is to combine Greimas' idea with that of Propp's - that signs also have a meaning in the story as a whole not just the sentence - and consequently a text grammar can be developed.

The last goal of the thesis is to situate the subject in the process of reading. Once the removal of the subject as 'pollutant' has been denied then the use of semiology (poetics) and the Sandler's can show that the person is not simply a 'methodological necessity (Eco)' but also a theoretically necessary; that the reader is part of a process, not as a Cartesian centre, but as a person at a particular moment in their social development, constructing and being constructed.

4.2.0 The Aims and the Text and the Reader

4.2.1 The text

The two fairy tales that were analysed showed a progressive development of the model. The Wizard's analysis began with the binary heuristic and finished with the case-gram. The reason for this was that a simple binary structure said little about 'primary signifiers' in the text.

Next the idea of the narrative or plot was blurred by Levi-Strauss' methods as was any competence on the part of the reader to read stories.

The analysis of the text showed that there must be a relationship between the text's messages and the wider language outside the story. The final analysis of the Wizard pointed to a didactic aspect that relied upon certain ways of doing within the culture that the text is read. In fact, the story was brought to a climax through a cultural code (see page 171) and the analysis at that point failed to understand the important relationship between code/message and langue/parole which forms a major part of the third chapter. At the end of the analysis of the Wizard :

'A major problem arises.....in the thesis and that is the relationship between the text grammar based in the case analysis and the text's signification based in the structure of language itself'.

The progression to the analysis of Beauty and the Beast is because of this problem. What is here added is a level of the text grammar, the S-level, which establishes the relationship between textual messages and the language.

This relies heavily upon the idea of a code which is in turn related to semiotics. The idea is established in Chapter Three that a code combines signifiers in accepted ways to produce, in the act of communication, messages. Furthermore, the two terms denotation and connotation apply within the text and the constraints that exist to stop the possibility of an infinite semiosis that these two terms imply are to be found partly in the text, partly in the codes themselves and partly in the reader.

Textual constraints obviously concern the signifier(case) level of the final textual model but as one progresses up the integrative structure constraints become stronger. So for example, an intertextual result points the reader to a set of experiences of other texts; once there she arrives at (we assume for our particular readers) a highly coded area of her thought. This is the

constraint of the stability of codes. Stable codes are ones where the key signifiers are labelled - they are associated in a particular way. The most stable code would be in this example the fairy tale code. Now messages that are affordable in the text are not necessarily effective for a reader. It is not enough that codes exist in the text as underlying systems of signification they have to in some way get their message across to the reader. To account for this there are two types of signification I and II. Level I refers to messages at the affect-signified level of the text, they are said to be bound to the text (see page 216); type II significations refer to messages bound to the codes of the codes of the language. Now it is clear that any message depends upon a system of signification; where there is a process there is a system. The point about the distinction of types of signification is that characters that act in a drama can have meaning in terms of the story itself but that these meanings must become social or unbound from the text. The way the text gets from textual meanings to social ones is related to the fact that both text and code rely on the process which language and thought are based upon; metaphor and metonymy. Signifiers are linked by the code which obeys these processes. The text's function (conspiracy) is to direct the reader to permissible linkages. Some, like the fairy tale code are already established for our readers, but others such as ways of being concerning accepted male/female roles and expectations, correct behaviours and correct thoughts may not be established; it is the function then of the text to make these linkages not only possible but 'natural'.

The final model presented in Chapter Three shows how the fairy tale Beauty and the Beast offers the possibility of ways of thinking about her self in relation to others - primarily men. The text associates the father with the Beast, humanizing the Beast and, building upon Beauty's relationship with the father, transfers her thought about him onto the Beast, see page 247.

The reader is led to think in a particular way in order to experience a certain security in her relations to men. The tale is one way that the reader can come to an accepted way of being in this context.

Through relations presented to her she can make sense out of her body, learn to label it in an appropriate way; where before there was nothing now there is meaning.

So from the point of view of the text the final model shows how an affordable range of meanings is possible. This is the advantage of chapter three over two, and now we can understand the reader in this.

4.2.2. Reading and the Reader

In chapter two a discussion on the process of reading established the idea that it was a type of 'naturalisation' in which another object was created which made sense out of the first. This is what I termed the 'structuralist' activity in the introduction. We found that what is added is the reader her self in her situations with her own needs and desires; in a sense it is her imagination that is added.

The reading of the Wizard showed that reading was for some purpose; in that case it was the desire for a dog. It was this surplus', primary signifier which gave the suggestion that the binary method used was less than adequate. What Victoria brought to the story was a desire for a dog which, because of her context or 'existential predicament' had to be obtained on an imaginary plane. But this was not any old dog; it was a dog who belonged to a little girl similar in key attributes to the reader and which was also concatenated in a story that was structured around security and insecurity - affects that were opposed in her situation. Besides this notion of the primary signifier for a reader we can also get from Victoria's reading a glimpse of the process that is going on. We know that reading is a fleshing out or an investing of a story with meaning; the reader fills in gaps in the text to read (write) her very own version.

Whereas Victoria is reading to get a dog the purpose of Melissa's reading is a desire to find something out (see page 201). Although the text is leading the reader to understanding herself and her relations with men what Melissa does is to use it - inter alia - to find out about mother, the 'one' sister of her version. Melissa's context does not contain a sister, evil or otherwise, but it does contain a mother and my reading of her reading depends upon the metaphorical substitution of Melissa's emphasis on her sister, who is given many negative attributes, with her mother. This is what makes sense out of her reading and it is a desire by Melissa to find out about her mother (in relation to father and self) that directs her reading.

On the other hand we know that the text is also directing the reading and it is this clash that results in the representation. The reader who has identified with Beauty goes through the relations that she does; Beauty's final acceptance of the Beast as a groom is the culmination of a way of being that has been subtly structured by the text. We saw that the thought structure of the text provided has Beauty capitulating to the Beast's desires because of the association of selflessness-guilt and marriage. We could say that Beauty feels guilty but in so doing it must not be understood that 'guilt' is an innate substance; feelings are relational (see 2.3), the result of representational processes and before these relations are learned guilt does not exist. Our reader for example may still be undergoing her apprenticeship yet to ask the 'genetic' question here requires more than an analysis of fairy tale reading: Melissa's semiotic function started early and appropriate ways of being were presented early. It seems that each form of our culture that the child comes up against (household duties to fairy tales) as it develops never tires of putting similar messages across (probably working on the redundancy principle). The lessons

learnt, however, are extremely important culturally as the main message of Beauty and the Beast shows. Developmentally, built upon the need for recognition are affects that culture prescribes as ways of attaining it. The analysis of Beauty and the Beast shows how security and insecurity (both material and psychological, it seems clear that this separation is dubious because certainly material goods within the father/daughter code signify security as does their lack signify insecurity) form a stage upon which particular relationships can be acted and thought out. Did Melissa get the message? We know that she investigated the story from two areas; her inter-textual and her family experience. In both cases the 'one' sister is a surplus signifier that receives displaced negative thoughts. The code has directed but it has been unable to keep the affect centred on the reader who uses it to make sense out of her mother. She explores the code about feminine responsibility with the one sister - she is the nodal point for all the associations the text is trying to make natural for girls, including the reader.

Whereas with Victoria negative affect was simply left out with Melissa a more refined process is taking place - it is being used to understand the sister/mother through displacement. But this one sister is part of a whole the fleshing out of which eventually comes to Melissa herself (she is not only female, does female chores around the house but also has the most clothes in the family). My guess is that Melissa is not willing to accept the code and its implications just yet and the analysis of her use of the Miller's Tale seems to indicate that, even though she has a strong identification with the heroine, she is not 'grown up' like the girl in the story who is able and willing to be married and have children.

Generally the readings that were analysed showed that it is a re-writing process, a structuralist activity, filling in or investing meaning for the readers themselves. In both cases the investment is directed by personal desire but also by the systems of signification that organise the messages of the text.

Both readers have one foot in the imaginary realm of fairy tales but the other is lodged firmly in their sensuous existence, their need to know and their need for recognition within that knowledge.

4.3.0. The Thesis in Academic Perspective

4.3.1. Cognitive Psychology

I have already pointed out the inadequacy of current cognitive theories for an understanding of meaning and comprehension (see Section 1.2.0.). Their main defect is the refusal to deal with affect and 'performance'. Furthermore, those who work in the field never offer meaningful texts in their experiments and remain tied to dependent variables that are irrelevant to the reading process. The example of Anderson who puts forward temporal variables as the only important ones for understanding comprehension makes this point clear.

What they lack is a theory of linguistics that is not tied down to the legacy of Transformational Grammar and the computer.

Semiotics offers a way out of traditional syntax and gives a more refined idea of 'semantics' in which the sign is conceived as part of a system of signs whose meaning is their difference. Furthermore, this meaning is not the perfect formal construct that 'competence' leads us to but a social construct i. e. with a context and history.

With the introduction of meaning and context then readers can be admitted to the work of cognitive psychologists; they can now start to present.

story paragraphs that actually mean something to someone; what they can no longer do is to consider their 'subjects' machines for making inferences. To continue to do so means that models of comprehension will lack adequate accounts of meaning - not a good position to be in! It seems clear too though that the thesis has given a lot of support to ideas and the work of Bransford and Franks (1972) especially the notion of enriching structures, but it is also within the tradition of Bartlett, '.....the process of fitting is an active process, depending directly upon the preformed tendencies and bias which the subject brings to the task' (p.41 this thesis).

Also the work of J.J. Gibson, who actually proposed the possibility of an analysis of high ordered stimuli, gets support in the notions of affordable and effective stimuli. But what all the workers mentioned above miss is the need for a linking of affect and cognition.

4.3.2. Cognition plus Affect is Thought

The denial of contemporary cognitive psychology has been accomplished largely through the coherence of the semioticians' arguments. The idea that cognition plus affect equals thought has both theoretical and empirical coherence. The work of Schacter and the Sandler (see 2.3.) shows that the affect displayed and felt is determined by cognitive cues (Schacter) and that looked at developmentally representational processes are intimately related to 'feeling states' which, in the developing person, take on the form of recognition or security (Sandler). Within psychology the division between emotion and cognition has always played a major role. Historically it is related to the mind/body problem and attempts to solve it, in psychology, have taken either extreme.

On the one hand the body side of the problem was considered the only worthwhile area of investigation, e.g. the Behaviourists. On the other hand, Cognitive psychologists, e.g. Piaget, tended to ignore the body

side. Even Schacter still talks of an 'interaction' which continues the idea of a split.

It is only with the extension of Freud's ideas by the Object Relations School of psycho-analysis that the division become meaningless.

The relationship between self and object(s) originally underpinned by the body (feeling states + or -) become possible with the onset of the semiotic function in the imagination, through wish-fulfilment. What the thesis has done is to show that 'imagination' can be directed. We can no longer talk about a 'centre of imagination' because imagination has another side to it; it depends upon public systems of signification which are 'out there' and social. And the subject must find its way within these systems in order to obtain its wishes or desires.

The implication for 'cure in therapy' then is that the aim is to situate the patient in the apposite systems of signification for his context; to think in the right way and to recognize situations. Security is a social act garnered in society.

So we come to the problem of the subject in the 'search for the subject aspect of the thesis' (see note 5, page 9). A main theme has been to resurrect the subject from its status as a 'pollutant' assigned to it by prominent semioticians. But it is not just semioticians who have done this; biological theories of personality also dissolve the subject and it could be that Levi-Strauss is right when he claims that the goal of the social sciences is to dissolve the subject. Explanations of man and his behaviour have primarily been reductionist which, of course, has a lot to do with what we accept as an explanation - the 'science' code is very stable.

The thesis shows that the reading subject is not a fixed entity but a person exploring or fleshing out systems of signification that have been offered to it. This active attempt at intelligibility is more or less coded,

directed and accomplished in the citizen. To be lost in them, to be taking different pathways accounts for style, creativity, madness and the development of the language itself. After all, the 'word salad' of schizophrenics was only seen as intelligible when it was realised that different meanings had been invested into the patients' lives.

The fundamental criticism of semioticians then is that they offer a formal system or set of sub-systems of signification with no-one in them either trying to make themselves intelligible in them or trying to change them. The irony is that they fall into a competence performance split that they reject when the transformational school proposes it. The '/' between competence and performance should not mean a non-functional, accidental or trivial relationship; the same is true for langue/parole and code/message.

The thesis has shown the possibility of investigating imagination; that it is not mysterious, an unknown ingredient added to the first object to make the second. It is a concrete attempt to make sense out of the person's existence.

4.4.0. Conclusion

Reading is an active process where a primary signifier is acquired in order to invest a text with meaning; but this signifier has strings attached to it. It can only be got in accepted systems of signification, the reader is either more or less within these systems depending on her problems and development.

The thesis has shown how two readers attempted to solve their particular problems and how the text attempts to lead them to 'thoughts' which are part of an accepted and received solution. The final model

established in chapter three accounts for the progressive codability of the reader's thought.

REFERENCES

1. ATKINSON, J.W. Motives in Fantasy, Action and Society. New York, D. van Nostrand Company Inc., (1958)
2. BARTHES, R. Elements of Semiology, Trans. Annette Lavers and Colin Smith, New York : Hill and Wang, 1977.
3. BARTHES, R. Mythologies, Trans. Annette Lavers, London, Paladin 1973.
4. BARTHES, R. S/Z Senil, Paris 1970.
5. BARTHES, R. "The Structuralist Activity", in the Structuralists from Marx to Levi-Strauss, Richard and Fernande Degeorge (eds), New York, Double Day and Co. Inc., 1972.
6. BARTHES, R. Writing Degree Zero, ^u Cope, 1970.
7. BARTLETT, F.C. Remembering, Cambridge U.P., 1932.
8. BAUM, L. Frank. American Fairy Tales, New York, Dover Publications, 1978.
9. BENVENISTE, E. Problems in General Linguistics, Trans. Mary Elizabeth Meek, University of Miami Press, 1971.
10. BETTELHEIM, B. The Uses of Enchantment, The Meaning of Fairy Tales, London, Penguin, 1978.
11. BLOOMFIELD, L. Language, New York, Hold, Rinchort, & Winston, 1933
12. BOWER, T. Human Development, San Fransisco, Freeman, 1979.
13. BOWLBY, J. Attachment and Loss I : Attachment, London, Hogarth, 1969.
14. BORGER, R. and SEABORN, A.E.M. (Eds) The Psychology of Learning, London, Penguin Books Ltd., 1971.
15. BRANSFORD, J.D. and FRANKS, J.J. "The Abstraction of Linguistic Ideas : A Review." Cognition : An International Journal of Psychology. 1972, 2, 24 - 249.

16. BRUNER, J.S., GOODNOW, J.J., AUSTIN, G.A.
A Study of Thinking, New York, Science Editions, 1967.
17. CANDLAND, D.K. et al. Emotion, California U.S.A. Wadsworth Publishing Company, 1977.
18. CHANDLER, R. Playback, London, Penguin Books, 1958.
19. CHAPMAN, A. Linguistics and Literature : an introduction to literary stylistics, London, Edward Arnold, 1973.
20. CHOMSKY, N. Syntactic Structures, Mouton & Co. Ltd., 1957.
21. CHOMSKY, N. Aspects of the Theory of Syntax, Cambridge, Mass. MIT Press, 1965.
22. CHOMSKY, N. Language and Mind, Harcourt, Brace and World, 1968.
23. CHOMSKY, N. Reflections on Language, London, Fontana, 1976.
24. COULSON, M.A. and RIDDELL, C. Approaching Sociology, London, Rontledge and Kegan Paul, 1970.
25. COWARD, R. and ELLIS J., Language and Materialism, London : Rontledge & Kagan Paul Ltd., 1977.
26. CULLER, J. Saussure, Glasgow, Fontana/Collins, 1976.
27. CULLER, J. Structuralist Poetics; Structuralism, Linguistics and the Study of Literature, London, R.K.P.1975.
28. DANZIGER, K. (Ed.) Readings in Child Socialisation, London, Pergamon Press, 1970.
29. DERRIDA, J. Of Grammatology, Trans. Gayatri Chakravorty Spivak, London, The John Hopkins Press, 1976.
30. DUNKER, On Problem Solving, Trans. L.S. Kes. Greenwood Press, 1972.
31. ECO, UMBERTO. A Theory of Semiotics, London : Macmillan Press Ltd. 1977.
32. EMPSON, W. Seven Types of Ambiguity, London : Penguin Books Ltd. 1965.

33. ENKVIST, N.E. et al, Linguistics and Style, London, Oxford University Press, 1964.
34. EVANS-PRITCHARD, E.E. Social Anthropology, London, Calper West, 1951.
35. FEYERABEND, P. Against Method, London, N.L.B. 1975.
36. FILLMORE, C.J. The Case for Case, in E. Bach and R.T. Harms (eds) Universals in Linguistic Theory, HSH Rinehart and Winston
37. FLAUBERT, G. MADAME BOVARY. Trans Alan Russell, London, Penguin, 1970.
38. FOKKEMA, D.W. and KUNNE-IBSCH, E. Theory of Literature in the Twentieth Century. London : C. Hurst and Company, 1977.
39. FOUCAULT, M. The Order of Things : An Archaeology of the Human Sciences, London, Tavistock, 1970.
40. FOWLER, R. Linguistics and the Novel, London, Methuen & Co. Ltd., 1977.
41. FREUD, S. Three Essays on the Theory of Sexuality, S.E. Vol.VII, 1905.
42. FREUD, S. The Interpretation of Dreams, S.E., Vol.V., 1900.
43. GIBSON, J.J. The Senses Considered as Perceptual Systems, Houghton Mifflin Co. 1966.
44. GOERTZ, C. An Ethnography of the Disciplines, Eminent Lectures Series, BIOSS, Brunel University, 1979.
45. GREENE, J. Psycholinguistics, CHOMSKY and Psychology, London, Penguin Books Ltd., 1972.
46. GUIRAUD, P. Semiology, London, R.K.P., 1975.
47. HARRE, R. The Conditions for a Social Psychology of Childhood, in The Interpretation of a Child into the social world, Martin P.M., Richards (Ed.) London, Cambridge University Press, 1974.

48. INGLEBY, D. The Psychology of Child Psychology in The Integration of a Child into a Social World, Martin P.M. Richards (Ed), London, Cambridge University Press, 1974.
49. HJELMSLEV, L. Prolegomena to a Theory of Language, Trans. Whitfield, F.J. Manison, University of Wisconsin Press, 1961.
50. HOLMAN, G.W. Some Effects of Spinal Cord Lesions on Experienced Emotional Feelings, *Psychophysiology*, 1966, 3, 143-156.
51. HULL, C.L. Principles of Behaviour : An Introduction to Behaviour Theory, New York, Appleton Century Crofts, 1943.
52. KATZ, J.J. and FODOR, J.A. The Structure of a Semantic Theory, *Language*, Vol. 39, pp 170-210. Jakobovits and Miron, 1967.
53. KLEIN, G.S. Freud's Two Theories of Sexuality in Berger, L. (Ed.) *Clinical and Cognitive Psychology*, Prentice Hall, 1972.
54. KLEIN, M. Narrative of a Child, *Psycho-analysis*, Vol. IV, London, Hogarth.
55. JAKOBSON, R. and HALLE, M. Fundamentals of Language, Netherlands, Mouton & Co., 1971.
56. JAKOBSON, R. Six Lectures on Sound and Meaning. Trans. John Mepham. Hassocks. The Harvester Press Ltd., 1978.
57. JAMESON, F. The Prison House of Language, Princeton, N.J. Princeton University Press, 1972.
58. KATZ, J.J. and FODOR, J.A. The Structure of A Semantic Theory, *Language*, 39, 1963.
59. KINTSCH, W. The Representation of Meaning in Memory, Hillsdale, N.J. Lawrence Erlbaum Associates, 1974.
60. KUHN, T.S. The Structure of Scientific Revolutions : International Encyclopaedia of Unified Science, London, The University of Chicago Press Ltd., 1970.

61. KRISTEVA ., J. REY-DEBOUE, J., UMIKER, D.J. (eds) Essays in Semiotics, Netherlands, Mouton & Co., 1971.
62. LACAN, J. Ecrits, Paris, Semil, 1966.
63. LACAN, J. The Insistence of the Letter in the Unconscious or Reason since Freud, in De George R. & De George, F. (eds.) The Structuralists from Marx to Levi-Strauss, New York, Doubleday & Co. Inc., 1972.
64. LAPLANCHE, J. & PONTALIS, J.B. The Language of Psycho-analysis, London : The Hogarth Press and the Institute of Psycho-Analysis, 1973.
65. LEACH, E. Anthropological Aspects of Language : Animal Categories and Verbal Abuse, in New Directions in the Study of Language (ed.) Lenneberg, E.A., M.I.T. Press, pp 23-63 (1964).
66. LEACH, E. Levis Strauss, London, Fontana/Collins, 1970.
67. LEVI-STRAUSS, C. The Raw and the Cooked, Trans. John & Doreen Weightman, London, Jonathan Cape Ltd., 1970.
68. LEVI-STRAUSS, C. The Structural Study of Myth and Four Winnebago Myths, in The Structuralists from Marx to Levi-Strauss, Richard and Fernande De George (eds) New York Doubleday & Co. Inc. 1972.
69. LINDSAY, P.H. and NORMAN, D.A. An Introduction to Psychology, London, Academic Press Inc. Ltd., 1972 & 1974.
70. LYONS, J. CHOMSKY, London, Fontana/Collins, 1970.
71. LYONS, J. Semantics, Cambridge, Cambridge University Press, 1977.
72. MANDLE, G. Mind and Emotion, London, Wiley, 1975.
73. MANNONI, O., Freud The Theory of the Unconscious, Trans. Renand Bruce, London, Pantheon Books, 1971.
74. MARANDA, P. (Ed.) Mythology, London, Penguin, 1972.

75. MINNIS, N. (Ed.) Linguistics at Large, London, Paladin, 1973.
76. MORRIS, C. Foundations of the Theory of Signs (International Encyclopaedia of Unified Science 1-2) University of Chicago Press, 1938.
77. MULDER, J.W.G. and HERVEY, S.G.J., Theory of the Linguistic Sign, The Hague, Mouton & Co. 1972.
78. NEWELL A., & SIMON, H.A. Human Problem Solving, Englewood Cliffs, N.J. Prentice-Hall, 1972.
79. PETTIT, P. The Concept of Structuralism : A Critical Analysis, Dublin, Gill & Macmillan Ltd., 1975.
80. PIAGET, J. Structuralism, Trans. Chaninah Maschlek, London : Routledge and Kegan Paul, 1971.
81. PROPP, V. Morphology of the Folktale Trans. Laurence Scott, London, University of Texas Press, 1968.
82. PUTNAM , H. On Reductionism, Cognition, 1971.
83. RICHARDS, M.P.M. (Ed.) The Integration of a Child Into a Social World, London, Cambridge University Press, 1974.
84. SAPIR, E., Language, London, Harcourt, Brace and World Inc., 1949.
85. SANDLER, J. & SANDLER, A.-M. On the Development of Object Relationships and Affects, International Journal of Psycho-Analysis, 59, 205, 1978.
86. SAUSSURE, F. De. Course in General Linguistics, Trans. Wade Baskin, Glasgow, Fontana/Collins, 1974.
87. SCHACHTER, S. Emotion, Obesity and Crime, New York, Academic Press, 1971.
88. SCHWARZ, B. et al, On Ideology, London, Hutchinson & Co., 1978.

89. SPURLING, L. Phenomenology and the Social World, London, Routledge and Kegan Paul Ltd., 1977.
90. STUNOCK, J. (Ed.) Structuralism and Since : From Levi Strauss to Denida, Oxford, Oxford University Press, 1979.
91. TRILLING, D. The Liberated Heroine, Times Literary Supplement, London, October, 1978.
92. ULLMANN, S. The Principles of Semantics, Oxford, Basil Blackwell & Mott Ltd., 1957.
93. ULLMANN, S. Meaning and Style, Oxford, Blackwell, 1973.
94. VYGOTSKY, L.S. Thought and Language, Trans. Eugenia Haufmann and Gertrude Vakar, Cambridge, The Massachusetts Institute of Technology, 1962.
95. WATSON, J.B. Psychology as the Behaviourist Views It, Psychological Review, 20 (1913), 158-177.

* * * * *

APPENDIX A

The TEXT of The WIZARD OF OZ : Dorothy Kills the Witch

The Wizard of Oz: Dorothy Kills the Witch

ONCE there was a little girl named Dorothy who lived on a farm in Kansas. One day the sky grew dark and a big wind began to blow across the flat prairies that stretched all around the farm. Dorothy ran into her house to take shelter but the tornado came closer and closer until—suddenly—it lifted Dorothy's house high up into the sky, with Dorothy and her little dog Toto still inside. The house came to rest at last in a magic country, as Dorothy realized the moment she opened the door and walked outside.

The first person she saw was an old lady. She looked just like any other old lady except that she was smaller and wore a high, pointed hat on her head with gold bells hanging from it, and a white gown. She was followed by three small men, all dressed in blue. They too wore high, pointed hats with bells hanging from them, and big boots that reached right over their knees.

"Who are you?" asked Dorothy.

"I am the Witch of the North, and I have come to thank you for killing the Wicked Witch of the East."

Dorothy looked surprised. "I've never killed anybody!" she replied.

"Well, your house did, when it landed here. It fell right on top of her and killed her—you can still see her silver shoes sticking out from under the wall there. Take them; they are yours now."

Dorothy looked down at her own shabby shoes. "Well, it's a long walk back to Kansas from here; I might as well get some good shoes for the journey," she said. "Can you tell me the way home, please?"

"Oh, no, my dear," the old lady replied. "Only the Great Wizard of Oz knows that. You will have to ask him."

"Where does he live?" asked Dorothy.

"A long way away, in the Emerald City. The road there is very dangerous."

I

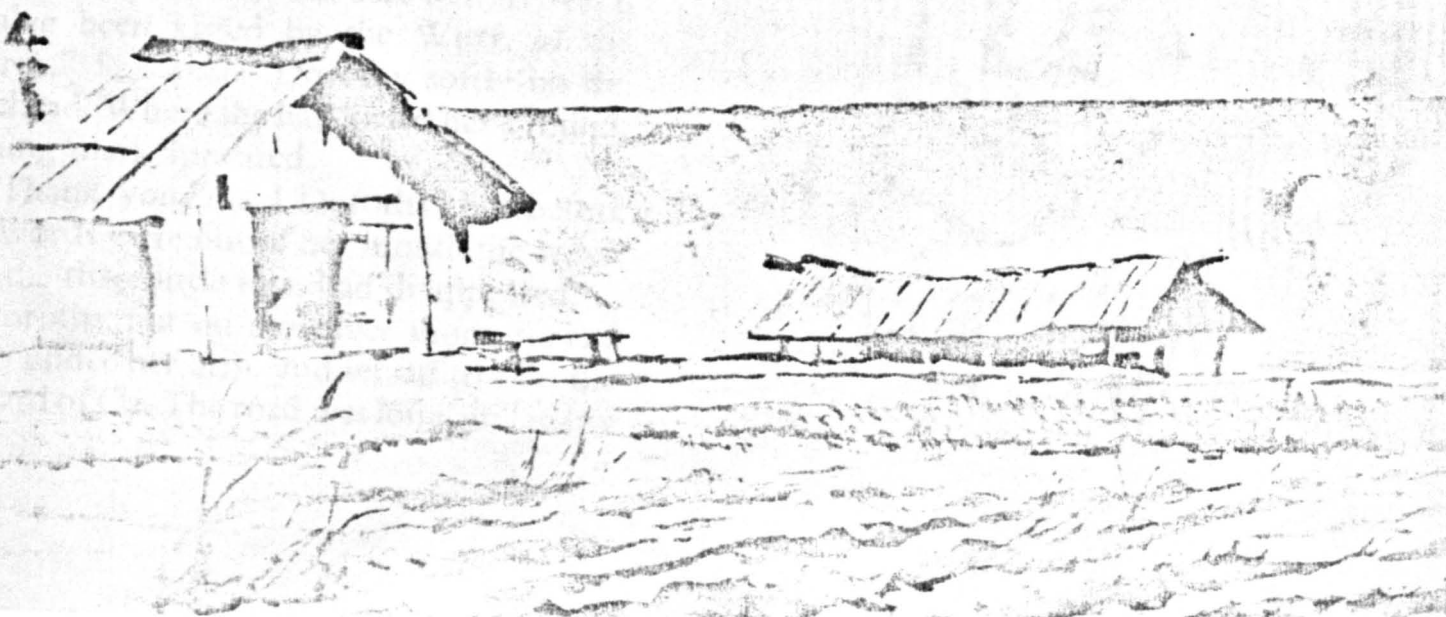



“Will you come with me?” asked Dorothy.

“No, I can’t do that, but I will give you my kiss, and no one will dare to hurt you if you’ve been kissed by the Witch of the North.” She kissed Dorothy softly on the forehead. Where she had kissed her a round, shining mark appeared.

“Thank you,” said Dorothy, but before the words were out of her mouth the witch and the three little men had disappeared.

Dorothy put on the silver shoes, tucked Toto under her arm, and set off to find the Wizard of Oz. The road was long, and many

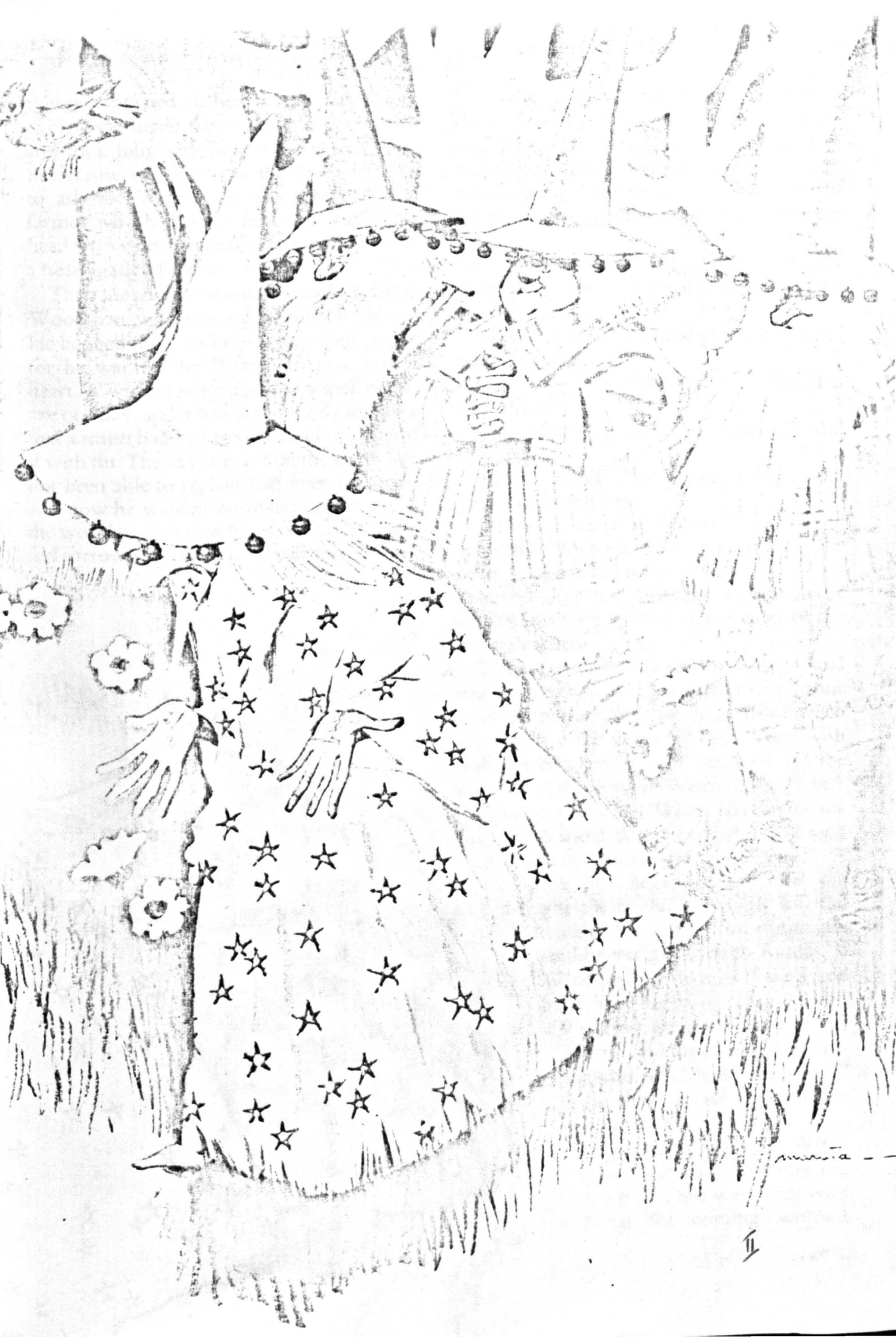

murcia

things happened to her on the way there.

First she made friends with a Scarecrow and took him with her on her search. The Scarecrow was going to the Emerald City to ask the Wizard for some brains. The farmer who had made him had stuffed his head with straw, and nobody can think with a head made of straw.

Then she and the Scarecrow came across a Woodman who was made entirely of tin. He begged them to let him join their party, for he wanted the Wizard to give him a heart. A wicked witch had put a spell on his axe one day, and it had cut his body so badly that a smith had had to replace every part of it with tin. The only thing that the smith had not been able to replace had been his heart, and now he wanted more than anything in the world to get a new heart, so that he could feel sorrow and happiness as other people do.



Finally, as they were walking through a dark forest, they met a Lion who had a very fierce roar but who was in fact afraid of everything. Being so cowardly made him very unhappy, for he knew that as king of the beasts he ought to be braver than anyone else.

“Do you think Oz could give me courage?” the Cowardly Lion asked Dorothy.

“Just as easily as he could give me brains,” said the Scarecrow.

“Or give me a heart,” said the Tin Woodman.

“Or send me back to Kansas,” said Dorothy.

“Then, if you don’t mind, I’ll go with you,” said the Lion.

“You’re very welcome,” answered Dorothy, “for you will help keep away the other wild beasts on our journey.”

So off they set, and after a great many adventures they arrived at the gates of the Emerald City.

There they asked to see the Wizard, and one by one they were admitted to his throne room to present their requests. But to each one he gave the same answer, “Your wish will not be granted until you have rid the country of the Wicked Witch of the West.” To Dorothy he said, “When you can tell me that the Wicked Witch is dead, I will send you back to Kansas—but not before.”

The little girl began to cry, for she thought she couldn’t possibly kill the Witch and feared that this meant she would *never* get back to Kansas.

“What shall we do now?” she asked her friends sadly.

“We must go to the land of the West,” said the Lion. “We must find this Witch and destroy her.”

So they set off towards the Wicked Witch’s castle.

It wasn’t long before the Witch found out about Dorothy and her party. She was angry with them for coming without

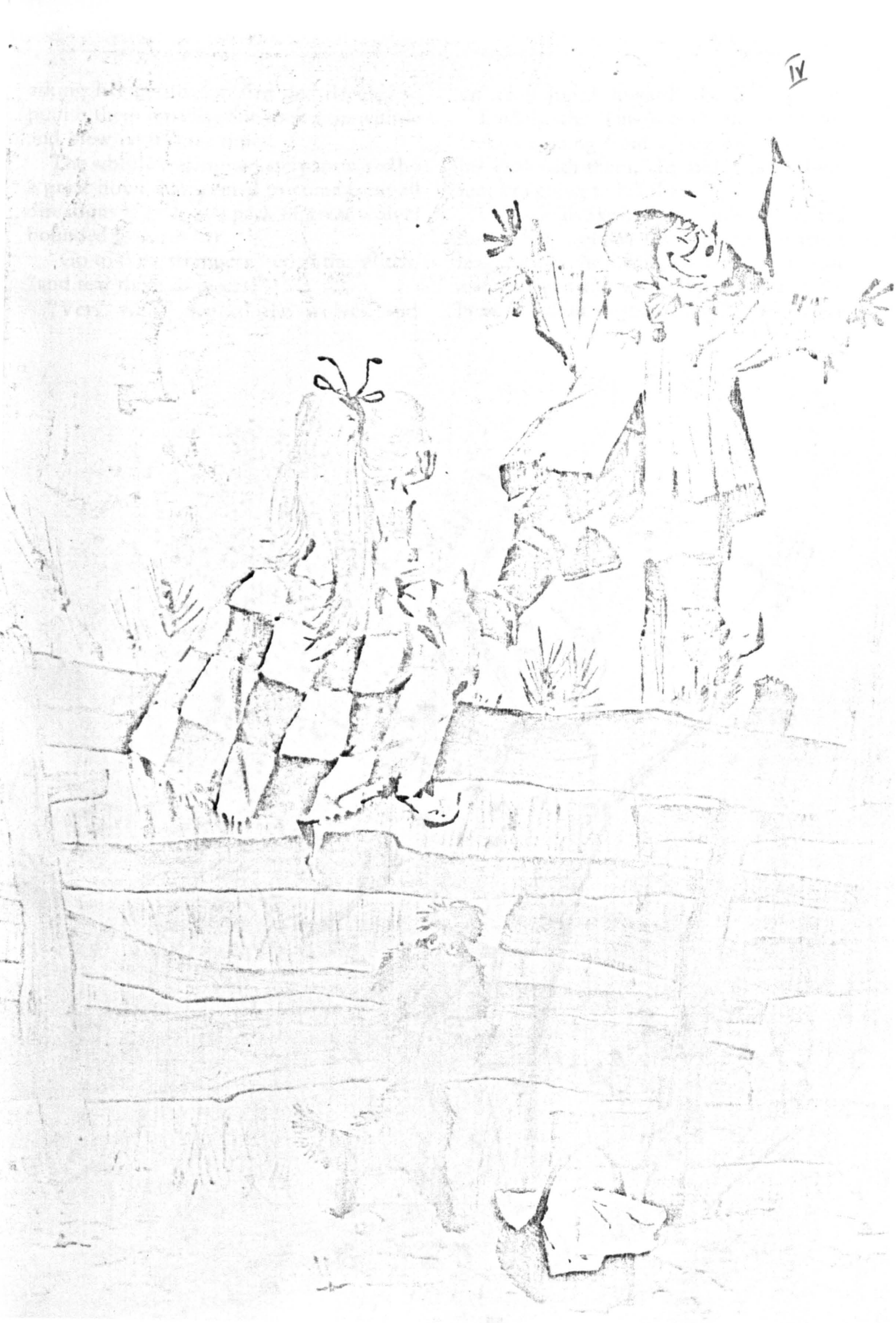

asking her permission first and decided to punish them terribly. She took a tin whistle and blew on it three times.

The whistle was immediately answered by a great howl that seemed to come from all directions at once as a pack of great wolves bounded towards her.

"Go to these strangers," cried the Witch, "and tear them to pieces!"

"Very well," replied the wolves, and

off they loped towards the little group.

Luckily the Tin Woodman heard the wolves coming from a long way off. "Let me deal with them," he said. "Get behind me; I'm going to kill them."

He took his axe in both hands and waited for the first wolf. When it was just an arm's length away, he swung the axe into the air and chopped the wolf's head off, and the beast fell dead to the ground. There were



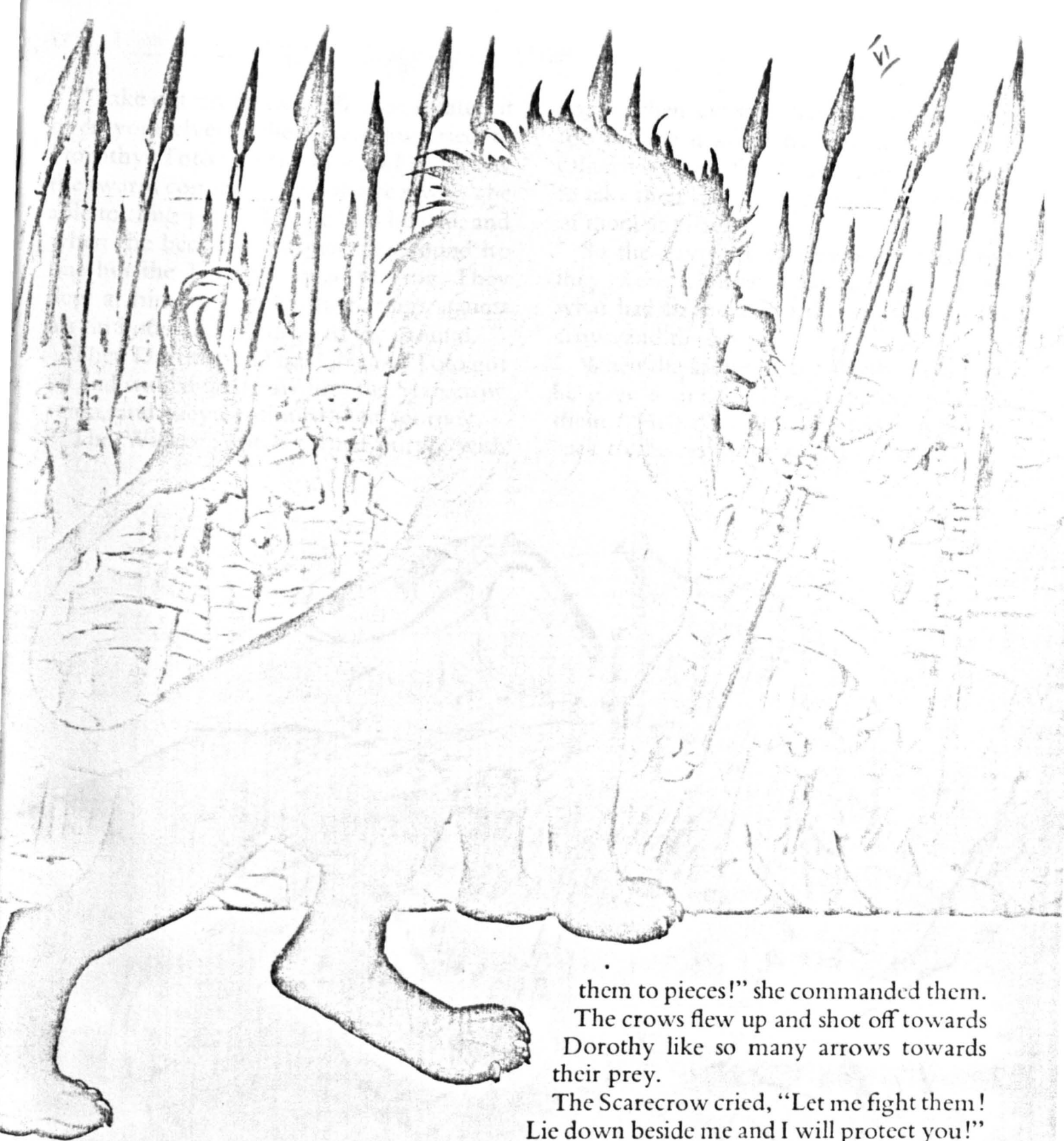

forty wolves in all, and as each one jumped at the Woodman, he knocked it flying. When they all lay dead on the ground, he wiped his axe and put it away.

When the Wicked Witch saw what had happened, she was very angry indeed. She blew another three blasts on her whistle. Immediately a flock of fierce crows flew down and settled at her feet.

“Peck out the strangers’ eyes and tear

them to pieces!” she commanded them. The crows flew up and shot off towards Dorothy like so many arrows towards their prey.

The Scarecrow cried, “Let me fight them! Lie down beside me and I will protect you!” He stretched up his arms and caught each bird as it flew down and broke its neck.

When the Wicked Witch saw all her crows lying dead on the ground, she grew even angrier than before. She blew three more times on her whistle. And at once she was surrounded by a swarm of black bees.

“Go to the strangers and sting them to death!” she cried, and the bees flew off towards Dorothy and her friends like so many bullets shot from a gun.

"Take out my straw stuffing and scatter it over yourselves!" the Scarecrow cried to Dorothy, Toto and the Lion, when he saw the swarm coming. "Then the bees won't be able to sting you!" They did as he said, and when the bees came down they found no one but the Tin Woodman to sting. They flew at him and broke their stings against his tin body and fell dead to the ground.

Then Dorothy and the Lion and Toto got up and stuffed the straw into the Scarecrow again, and they continued their journey.

The Wicked Witch turned purple with

anger when she saw that her precious bees too had been killed by the strangers. She called her slaves, the Winkies, and told them to take their sharpest spears and kill the five of them at once.

So the slaves set off down the road, but they were frightened because they knew what had happened to the wolves and the crows and the bees.

When the Lion saw the Winkies coming, he gave a great roar and sprang towards them. "Help!" they cried, and scuttled off back to the castle as fast as they could run.



TEXT BOUND INTO

THE SPINE

Then the Wicked Witch sat down and began to think hard. She could not understand how she had failed to destroy the little group, and she was more determined than ever to kill them.

She had in her safe a golden cap with a circle of diamonds and rubies curling around it. This was a magic cap, for whoever owned it could call on the winged monkeys and make them carry out any order they were given. But no one could call on the monkeys more than three times. Twice already the Wicked Witch had made them

do her bidding. She could use the cap to call the monkeys only once more, and she did not want to do this until all her other magic had been used up. But she had tried everything she could against the strangers: her wolves and her crows and her bees were dead, and her slaves had been scared away. There was only the golden cap left.

The Witch took it out of her safe and put it on her head. Slowly she intoned in a chant.

"Ep-pe, pep-pe, kak-ke!"

Suddenly the sky went black, and a low

VII



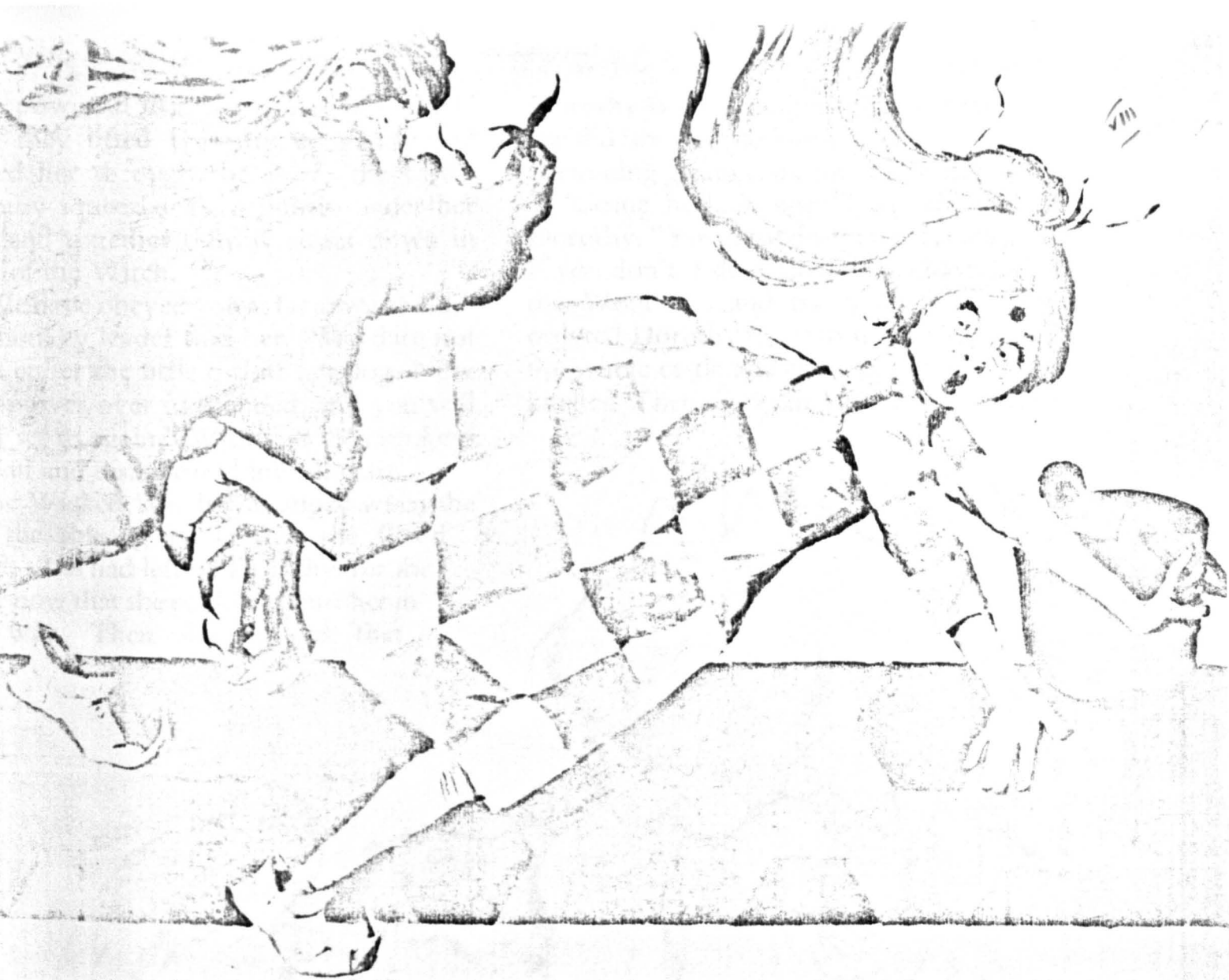

rumbling like the sea breaking over rocks could be heard. The air was filled with winged monkeys as they flocked into the castle. The biggest one among them flew up to her and said:

"For the third and last time we come at your call, Wicked Witch of the West. What do you want?"

"Go to the strangers and destroy them all except the Lion. Bring him to me. I want to harness him like a pony and make him drive me around."

"We go at your command," said the leader, as they flew off towards Dorothy and her friends. They swooped down and picked up the Tin Woodman and carried him through the air to a rocky place. There they dropped him so that he crashed down onto the rocks and was so battered and dented that he could not move.

Then they picked up the Scarecrow and

began tearing the stuffing out of his body. When they had scattered the straw, they tied up his clothes and threw them into a tree.

They threw coils of strong rope around the Lion and tied him up like a parcel. Then they lifted him up and flew away with him to the Witch's castle.

Dorothy was very frightened when she saw what the monkeys were doing to her friends. She stood with Toto in her arms watching them, knowing that it would be her turn next. The leader of the monkeys flew up to her and stretched out his long, hairy arms to snatch her away. Then he stopped suddenly. His face was quite close to hers, and he was looking at the round, shining mark that the kiss from the Good Witch of the North had left on Dorothy's smooth young forehead.

"Don't hurt her!" he cried. "She is protected by the power of good! It's much

re powerful than the power of evil is!"
o they lifted Dorothy up gently and
ied her through the air to the castle.
rothy squeezed Toto tightly under her
t, and together they were set down in
t of the Witch.

"We have obeyed you as far as we could,"
monkey leader told her. "We dare not
m either the little girl or her dog. Now
r power over us is ended, and you will
er see us again." With that the monkeys
v off and disappeared into thin air.

The Wicked Witch was angry when she
the shining circle that the Good
tch's kiss had left on Dorothy, for she
w now that she could not hurt her in
way. Then she noticed that

Dorothy was wearing magic shoes and that
she did not seem to know they were magic.
A cunning gleam came into the Witch's eye.

"Come here at once!" she shouted at
Dorothy. "You must do exactly as I tell you.
If you don't, I shall kill you as I have killed
the Woodman and the Scarecrow!" She
ordered Dorothy to set to work to clean up
the whole castle and to stoke the fire in the
kitchen. Then she went out into the yard to



see the Lion who had been shut up there.

"How grand I shall look," she thought, "when I'm driven through the streets by a lion." She opened the door cautiously. The Lion leapt up. "Arr-rr!" he roared, and the Witch's teeth rattled together in fear.

She jumped back to a safer distance and shouted at him, "If you don't do as I say, I shall starve you to death!" "Arr-rr!" the Lion replied and shook his mane.

When the Witch went to bed that night, Dorothy crept into the yard and brought him some food. She came to him every night and talked to him, trying to work out a means of escape for them both. But every gate and bridge around the castle was guarded by the Witch's slaves.

"I *must* get hold of Dorothy's magic shoes!" the Witch said to herself. "When I have them, I'll be so powerful that I'll have no more worries on earth." But Dorothy never took off her shoes except at night and when she went to have a bath. The Witch was too afraid of the dark to steal them in the night, and she was even more afraid of water. In fact she always made quite sure that she

kept right away from even the tiniest splash and carried an umbrella with her wherever she went.

Eventually the Witch tried to steal the shoes away by a trick. She put an iron bar in the middle of the kitchen and cast a spell on it to make it invisible. Dorothy did not see it and so she fell right over it. One of her shoes flew off and the Witch snatched it up at once.

"Ha-ha! It's mine now and you can't work the spell any more, even if you knew how to!" she said.

"I've got no idea what you're talking about," said Dorothy crossly. "Give me back my shoe at once!"

"I will not," hissed the Witch. "It's my shoe now!"

"You are wicked!" cried Dorothy. "That shoe belongs to me!"

"I shall keep it just the same, and some day I'll get the other one from you too!"

This made Dorothy so angry that she picked up the bucket of water she had just pumped up and threw it over the Witch, soaking her from head to foot.

"Aaah! Iiih!" screamed the Witch. She





began to shake and melt away at the edges. "See what you've done!" she cried. "I'm going to evaporate!"

"I'm sorry," stammered Dorothy, who was really frightened to see the Witch melting away before her eyes. "Was there anything wrong with that water?"

"No, there wasn't. But any sort of water is the death of me. Oh dear, oh dear, here I go!" And with these words the Witch melted right away into a little brown puddle.

Dorothy put her second silver shoe back on again. Then she picked up the Witch's bunch of keys and ran out into the yard to unlock the Lion's cage. "We're free! We're free! The Wicked Witch is dead!" she cried.

How Dorothy and her friends were reunited, how the Wizard of Oz granted them all their wishes, and how the little girl found her way back at last to her home in Kansas is a long story which you must find in another book.

APPENDIX B

Victoria's Drawings of the Story

I



APPENDIX C

Full Case - Gram of The WIZARD

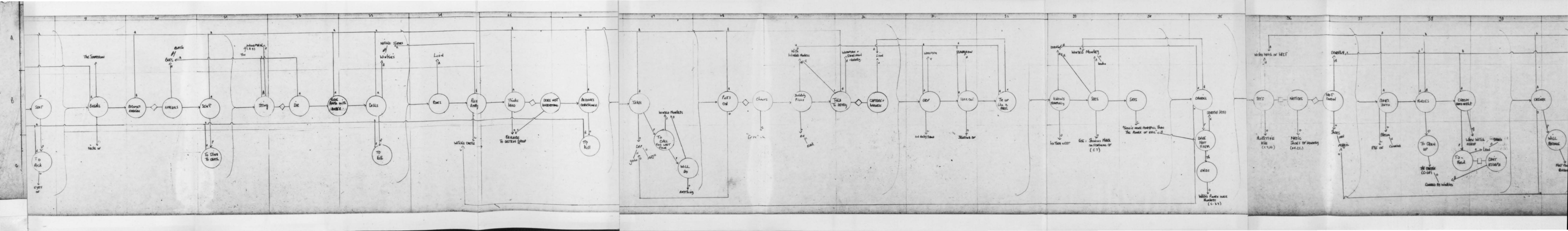

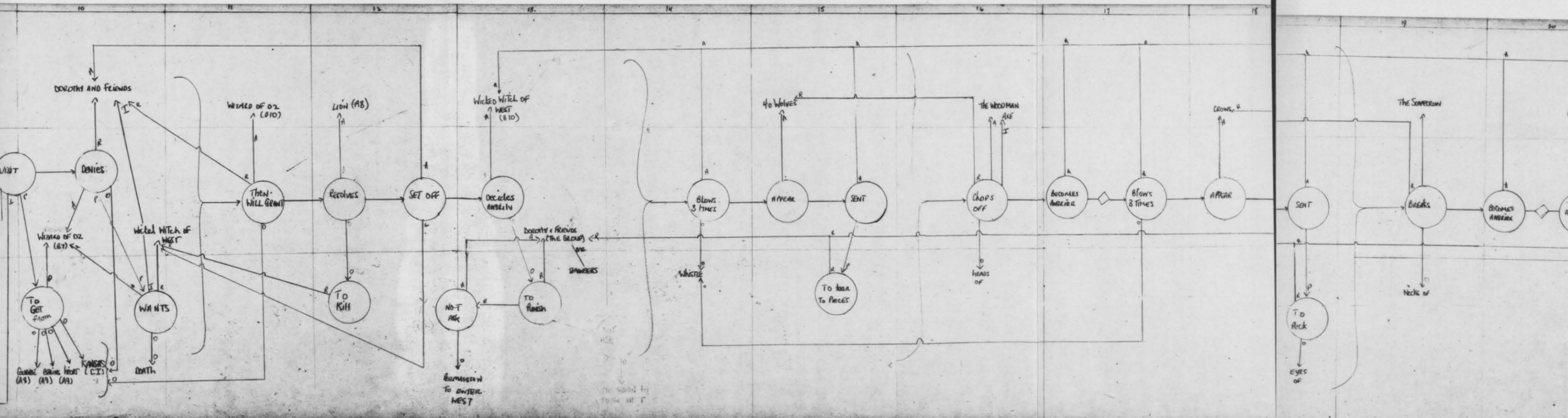
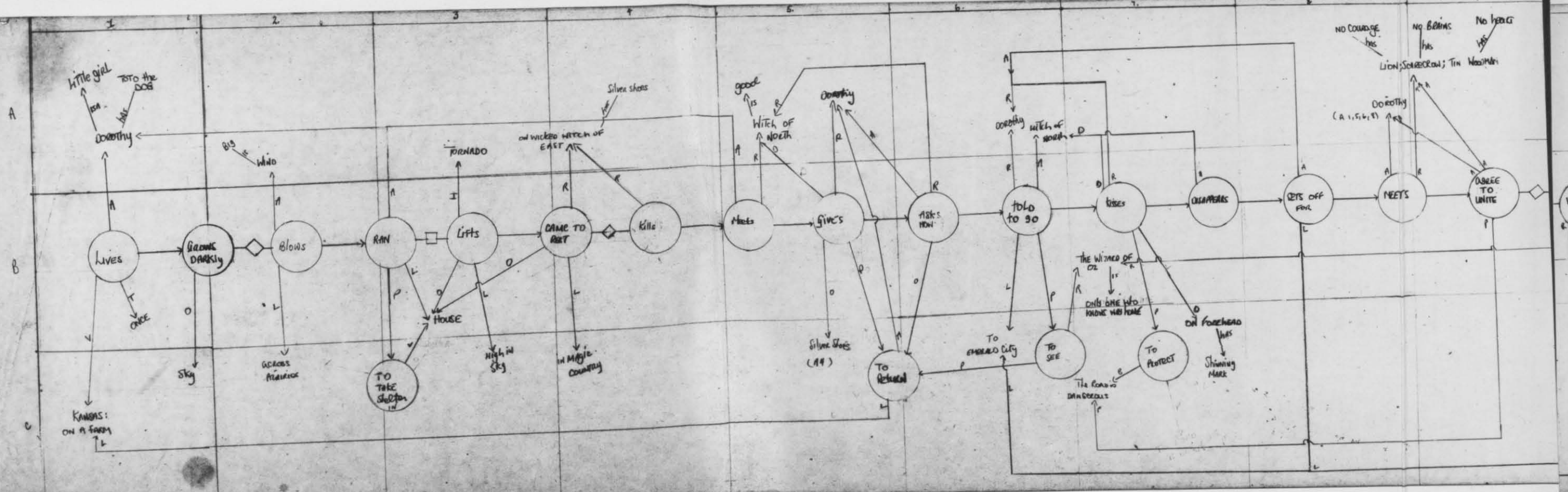

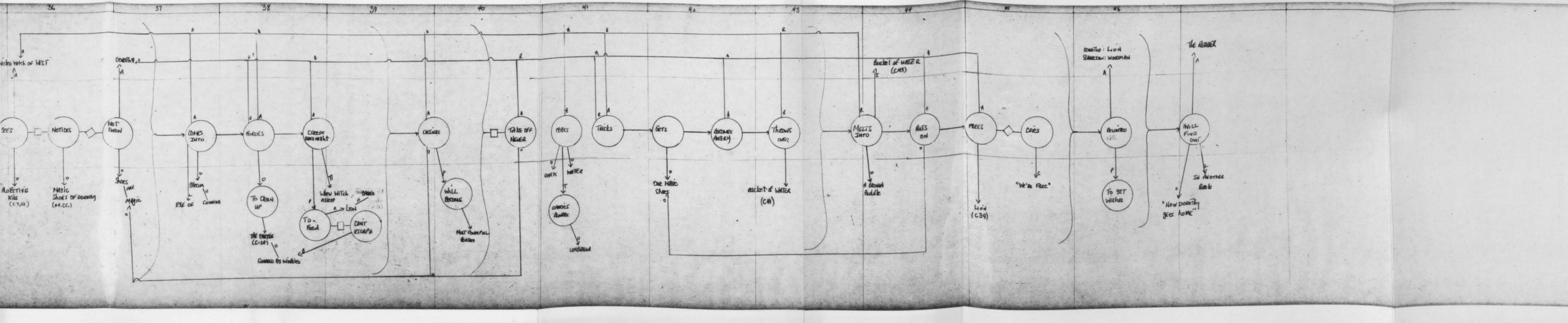

APPENDIX D

Affecteme Case - Gram of The WIZARD

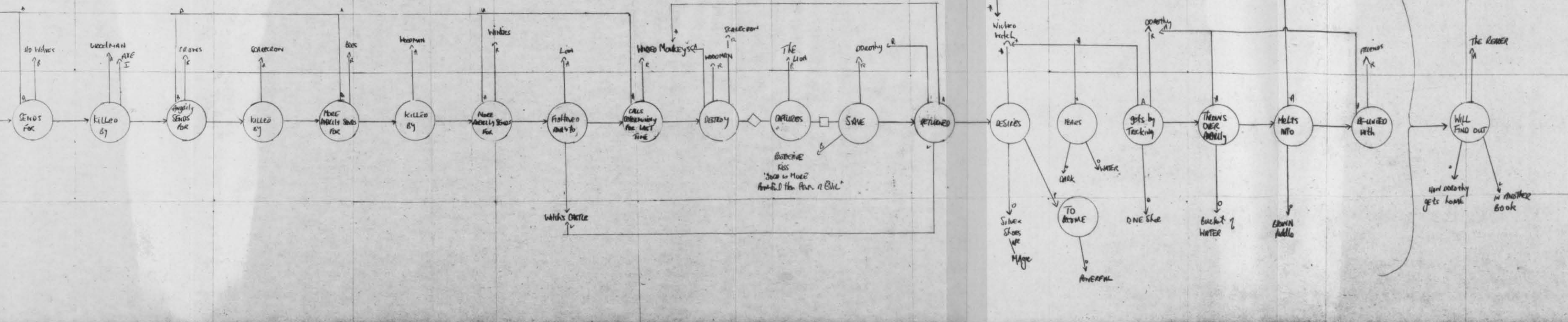
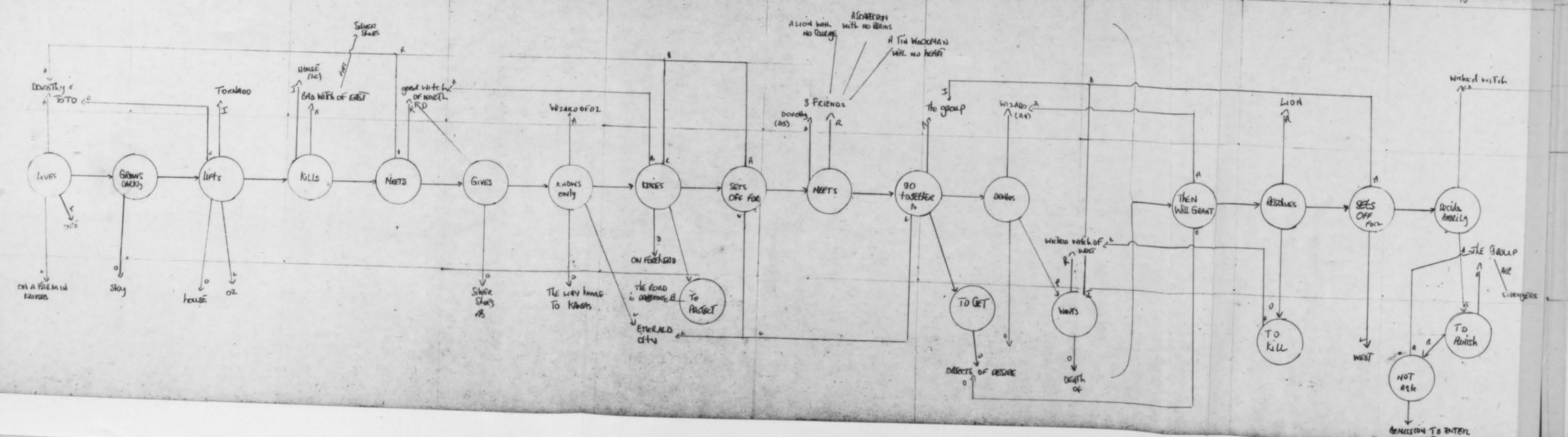

APPENDIX E

Victoria's Version : Case - Gram

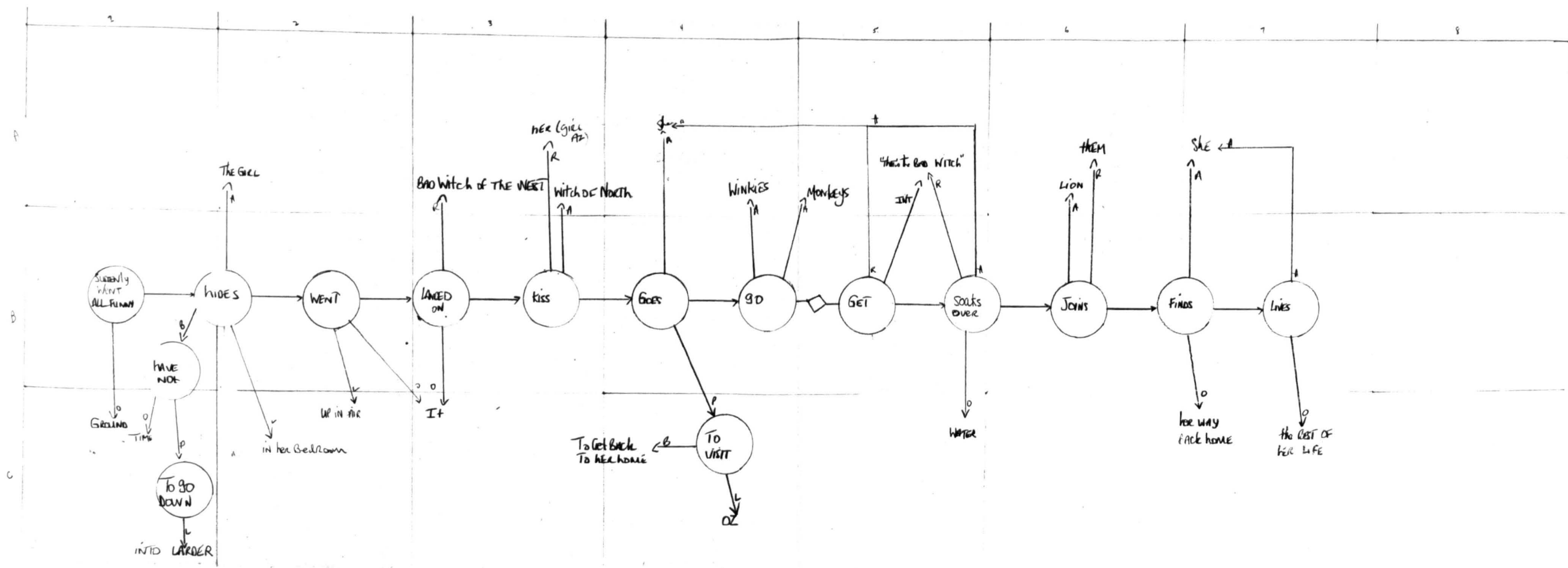

APPENDIX I

Mellissa's Drawings of BEAUTY AND THE BEAST

'THE ONE SISTER'

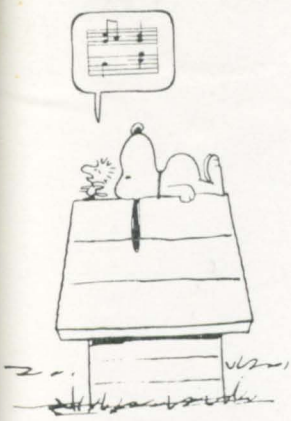



'BEST SCENE'

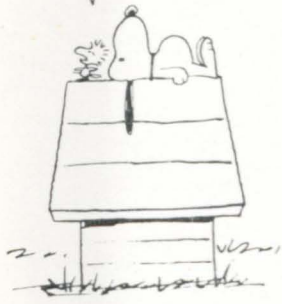

SCHWAZ



APPENDIX F

The TEXT of BEAUTY AND THE BEAST

Beauty and the Beast

ONCE upon a time, there lived a very rich merchant. He had a beautiful house, surrounded by gardens full of flowers and rare birds. He had four sons and three daughters, who had everything for which they could possibly wish. The two eldest daughters, Miranda and Rosina, were very vain and lazy, and were fond of silk and satin dresses and jewels. The youngest daughter was her father's pet; she was so lovely that she was called Beauty and was industrious, and kind, and loving to her father and sisters and all who came near her.

One day the beautiful palace in which they lived was destroyed by a dreadful fire; all their fine things were spoiled, and the gardens ruined. Then, a few days after the fire, a messenger arrived bringing the news that two of the merchant's ships, full of precious cargo, had gone down in a great storm, and the third one had not been heard of for many months.

The merchant was now very poor and he and his family moved into a tiny cottage. His daughters had to do the cooking and cleaning and Miranda and Rosina

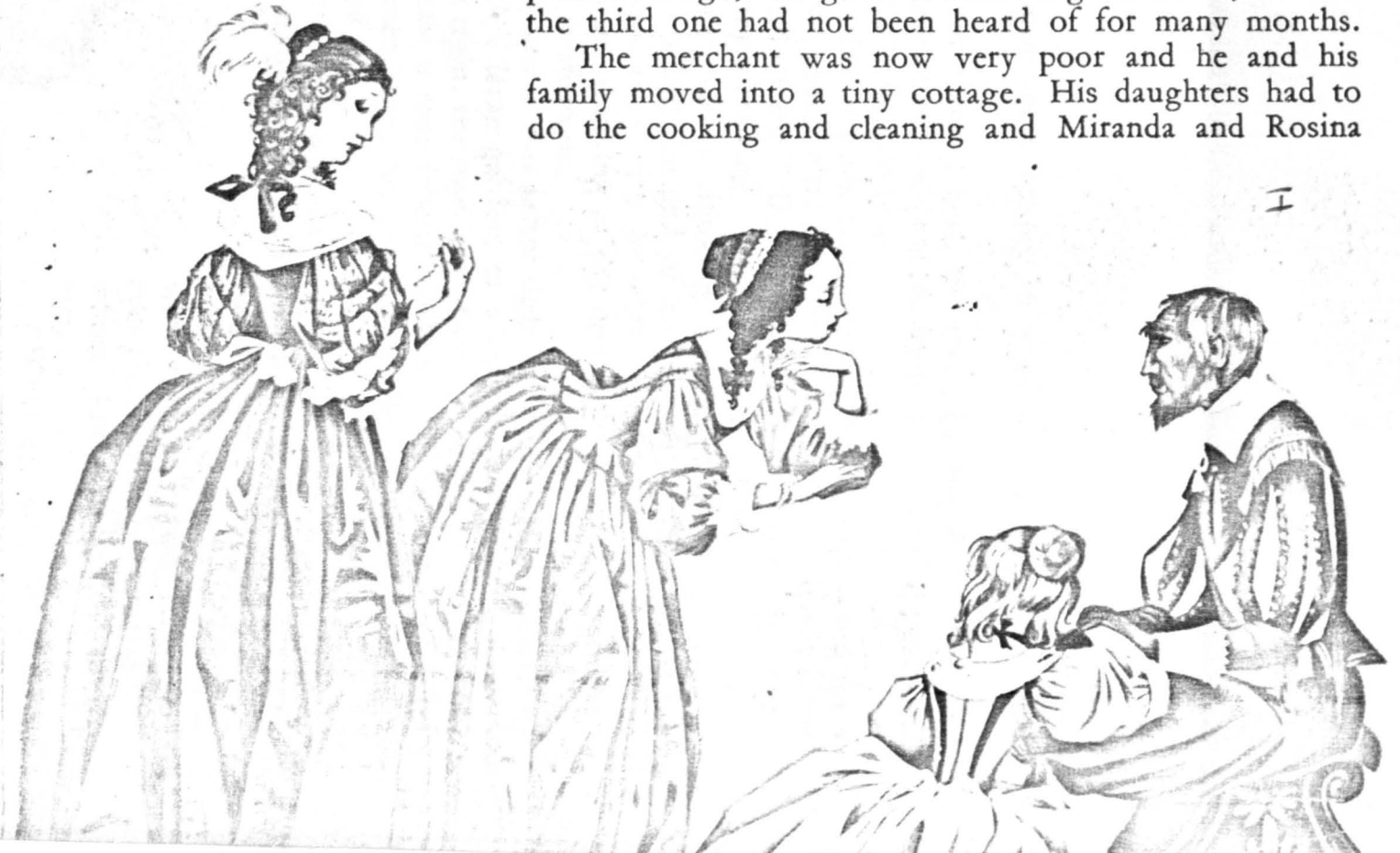

hated this and grumbled all day long about having to work and wear coarse clothes instead of silks and satins.

After they had lived like this for about a year, the merchant heard that his third ship, which he had thought lost, had arrived safely at its destination, and he determined to take a journey and find out if this news was true.

Miranda asked her father to bring back six satin dresses, and Rosina asked for a necklace of rubies. When Beauty was asked what she would like, she said, "If you come back safely, dear Father, that will satisfy me." But the merchant wanted her to have a present, so Beauty asked him to bring a red rose.

The merchant set out on his long journey, thinking of the gold which the valuable cargo would yield, but when he reached the end of his journey, he found that the captain had sold the cargo, and sailed away with the money to a distant country. The poor merchant set off for home again, thinking of the disappointment of his children when they should learn of his new misfortune.

He had not ridden far when he saw a wonderful sight in front of him; a castle of shining gold, and surrounded with a large garden, in which the most lovely flowers bloomed. As there was nobody in sight, the merchant dismounted from his horse and walked through the garden. He saw a rose arbour, covered with the most beautiful blossoms of every shade. He remembered his promise to Beauty, and, selecting a magnificent red rose, he broke it off.

Scarcely had he done so when a tremendous roar just behind him nearly frightened him to death. Turning round he beheld a most horrible beast, with a head

like a fierce animal and a man's body. The Beast was foaming with rage and two large red eyes glared at the poor merchant, whose knees trembled under him.

"What are you doing with my roses?" thundered the dreadful Beast, gnashing its teeth.

"Oh, forgive me, sir," cried the frightened merchant. "I did not think your highness would mind my picking just one rose; it was for my daughter, Beauty."

He then told the Beast all his troubles, and of the promise he had made to his youngest daughter.



"I will forgive you only on one condition," said the Beast, "and that is that one of your daughters will come and live with me."

The poor merchant was very frightened at this, as he was afraid, if he refused, the Beast would kill him, and he was so fond of his children that he could not bear that one of them should put themselves under the power of this dreadful creature.

At last, however, he promised to go home and tell his sons and daughters what the Beast said, and if one of them would not come, the merchant promised to return himself, and be the Beast's servant.

When the merchant arrived at his home he found his family waiting anxiously for him, and eager to see what he had brought them. He told them of all his adventures, and of the dreadful trouble he had got into by picking the rose. The merchant's sons were very distressed and did not want their father to go back to the awful monster.

The sisters declared that if Beauty had not asked for such a ridiculous present, none of these misfortunes would have happened.

At last, however, Beauty said she would go and live with the Beast, in order that her dear father might stop at home in safety. Of course, at first, her father and brothers would not hear of such a thing, but at last Beauty persuaded her father to let her go, and the next day she and her father set out.

The merchant and Beauty passed through the gardens without meeting anybody, and into the castle, where they found preparations made for them as if they had been expected.



A magnificent banquet was spread in the banquet hall, to which they sat down with much pleasure, as they were tired and hungry after their journey. Beauty was so charmed with all she saw that she was beginning to feel quite happy and had almost forgotten the Beast.

Just then they heard a tramp, tramp, coming along the passage, and Beauty clung to her father in terror. In a few minutes the Beast entered, and said, in a growling voice, "Good evening, old man; good evening, Beauty."

Beauty was very frightened, but she said, "Good evening," politely. The Beast then asked the merchant if Beauty had been willing to come.

The merchant said "Yes," which seemed to soothe the Beast a little.

"I shall expect you to go first thing tomorrow morning, but never venture near my castle again, or it will be the worse for you," the Beast told the merchant.

The next day, after saying farewell to Beauty, the poor old man started for home, full of grief at leaving his daughter behind, perhaps never to see her again.

Beauty wandered about in the gardens, smelling the beautiful flowers, and thinking of her home and father, and brothers and sisters. As she passed a fountain she seemed to hear a voice say: "Be cheerful, dear Beauty, for your lot is not as hard as you think, and one day you will be very happy; only be kind to the poor Beast, however rough he may seem to be." Beauty looked round to see who had spoken, but saw no one; but on a tree just above her a little canary was singing loudly.





Beauty then wandered through the rooms of the castle, admiring the furniture which was all of solid gold; and the beautiful dresses and jewels she found in her room.

She did not see the Beast until the evening and trembled as she heard his heavy footsteps coming along the passage. But the Beast seemed quite gentle, and said, "Good evening, dear Beauty," and asked her what she had been doing all day. He talked so nicely that Beauty quite forgot to be frightened.





She sang to him, and played one of his lovely musical instruments. Later he asked her if she was happy at the castle. "Oh yes, Beast," said Beauty. "I have everything I can possibly want, but I feel rather sad and lonely without my sisters and brothers, and my dear father."

"Dear Beauty," said the Beast. "Will you marry me, and live here always as the mistress of this beautiful place?"

"Oh, no," cried poor Beauty in horror. The Beast sighed and said:

"Well, good night, Beauty. I hope you will have pleasant dreams."

For some months Beauty lived on at the castle, where she found everything for her comfort. She had lovely needlework to do, if she felt industrious, musical instruments to play upon, birds to sing to her and wonderful flowers to pluck when she felt inclined.

Every evening the Beast had supper with her, and before saying "Good night", asked her if she would marry

him. Each time Beauty said "No" he seemed to become sadder and sadder, until Beauty felt quite sorry for him.

During this time, Beauty often used to think of her father, and wonder how he was, and what he was doing, and one day she happened to look in a magic mirror, and there she seemed to see her father lying ill in bed.

The next day she was looking so sad that the Beast said: "What ails you, dear Beauty?"

"I long to see my father again, and my brothers and sisters," said Beauty. "Please, Beast, let me go home for just a little while, and I promise you I will come back after two months."

The Beast was very much grieved at this request, as he loved Beauty so much, but, at last, he said she might go, if she would promise faithfully to come back at the end of two months. "If you do not return," continued the poor Beast, "you may find me dead."

He then gave her a ring, and told her to blow on it directly she was ready to return to him, when she would immediately find herself back at the castle.

The next morning Beauty said farewell to the Beast who was looking really sad, and set out on the long journey to her old home. When, at last, she arrived, her sisters and brothers hugged and kissed her; they were so delighted to see her once again. Then Beauty ran up to her father's room and tears ran down her cheeks when she saw how ill he looked. He had been worrying about Beauty and had missed her cheerful and loving company, but he was so overjoyed that she had come home that he soon recovered.

Beauty's father asked her all sorts of questions, as he wanted to know what she had been doing all this time, he also wanted to hear about the Beast and if he had treated her kindly.

After Beauty had told her father all he wanted to know she showed Miranda and Rosina the beautiful presents she had brought for them: satin and silk dresses, and jewels. She had also brought all manner of precious things for her brothers and a chest full of gold for her father.

The two months, full of happiness, passed very quickly and Beauty began to think of her promise to the Beast, but her brothers begged her to stay a little longer, so she put off going back to the castle, day after day.

One night, Beauty had a dreadful dream, in which she saw the Beast lying ill on the ground under a large tree, and heard a voice crying:

"You have broken your promise, Beauty, and see what has happened!"

Poor Beauty was dreadfully frightened, and determined to go back at once, so she blew on the magic ring, and immediately found herself back in the Beast's castle.



She wandered from room to room all day, longing to see the Beast, and to tell him how sorry she was that she had broken her promise, but she could not find him anywhere.

At last, evening came, but the Beast still did not appear and Beauty ran out into the garden weeping and calling his name. Presently she came to a tree, like the one she had seen in her dream, and to her horror saw the Beast, lying face down, apparently dead.

Beauty ran and fetched some water to try to revive him, and at last he opened his eyes. He was delighted to see Beauty again, and told her that he would have supper with her that night.

After supper, the Beast asked, as usual, "Dear Beauty, will you marry me?" and to his surprise, Beauty answered,

"Yes, dear Beast, I do love you very much."

As she said this, there was a tremendous flash of lightning, and a great peal of thunder that shook the castle. And, lo! instead of an ugly Beast, Beauty saw a most handsome prince standing beside her.

The prince was dressed in a suit of satin, trimmed with gold. He smiled at Beauty and knelt before her, then thanked her for breaking the spell which had been cast over him by a wicked witch.

The next day the prince sent for Beauty's father and sisters and brothers, and told them that she had promised to marry him.

Not many days after, there was a grand wedding at the castle, and there was great excitement as guests arrived from near and far.

All day long the joy bells pealed for the wedding of the handsome Beast and his beautiful bride, Beauty, who lived happily ever after.





APPENDIX G

Full INTERVIEW with Melissa

The nicest daughter was Beauty and the other one, the sisters were selfish and they were always wanted to take jewels; and nice dresses. And but one day wha... there was a dreadful fire and so somebody called to the man... the un father to go on um a ship with cargos. And they the daughters...when he... the daughters had to do all the cleaning and the washing because they had to move in a small little cottage.

(She has a pause here; I encourage her to try and remember what happens after that.)

I think he got a rose and he got into trouble with the Beast and he asked her um him to let Beauty um come to him and so she um came. But she broke a promise when she saw her father ill and she said she'd come back after two months but she didn't and so um she dreamed that she saw um beast um dead under a large tree and when she went there she did and then there was thunder and he woke up and they had a wedding.

INTERVIEW:

1. Who is your favourite character in the story/favourite person?
"I like the father best"
2. Why?
"Well, he was kind and he got what they wanted".

3. He got?
"What Beauty wanted, and he wasn't cruel".
4. And who do you like least in that story?
"Alioese" (not comprehensible), I didn't like the sisters".
5. Why weren't they very nice?
"Well, when they did the washing up they grumbled; and Beauty didn't, she just did it".
6. Do you do the washing up here?
"Sometimes"
7. Do you grumble when you do it?
"I ask mummy if I can do it".
8. And do you think that Beauty did the washing up?
"Yes"
9. What does Beauty look like?
"Um, she's got fair hair and she's got blue eyes, and she has a sort of um necklace round there and she has um blue eyes and ..."
10. What kind of clothes does she wear?
"She wears a silver sort of dress and um black"
11. Does the sister remind you of anyone?
"...One of Cinderella's sisters".
12. Does this story remind you of Cinderella and in what way?
"They wanted lots of clothes and they grumbled and they did the washing up but they didn't do it. Cinderella had a kind father as well... and like she just had a wicked sort of mother, but she hasn't got one, you see".
13. Does it remind you of any other fairy tales you have read?
"Snow White maybe but I'm not sure about that because she hasn't got two sisters".

14. But why Snow White?
"Well, because she was like Cinderella and um (correcting herself)
Beauty because she was kind to the animals and she did the wash-
ing up in the dwarf's house.
15. Does your brother do the washing up or is he too small?
"Too small"
16. Who is your second most favourite character in this story?
"Beauty".
17. And who is the third most?
"I don't know".
18. Do you like the Beast?
"Yes"
19. Why do you like him?
"Well, he wasn't sort of powerful, he was nice, he didn't....
he wasn't horrible to Beauty".
20. What do you think is the most exciting event in this story?
"When she had to go to the Beast and when she dreamt that he
was dead".
21. Why do you think the witch put a wicked spell on the Beast?
"..... (long pause) cause I think that it was like Rapunzel :
when he, she had maybe the the witch had a daughter and he was
trying to get her but she found out and so she, the witch, put
a spell on him."
22. Do you think that Beauty has ever been naughty in her life?
"Naughty? (long pause) No."

23. If this story were written without the father would you still want to read it?

"Well, not really."

24. Do you think the father was good?

"Yes".

25. Is that why you like him best?

"Yes".

26. How did you feel when he had to send his daughter to the beast?

"I felt sorry for him".

27. Him?

"And Beauty, maybe she didn't want to go and I don't think he wanted her to go". "But I think that the sisters wanted her to go because they didn't like her".

28. Why were they against Beauty?

"Because they said, when she wanted a rose, she said it was ridiculous, to have a rose, but I thought it was alright; I'd like a rose.

29. Is a rose your favourite flower?

"Yes".

30. Do you have roses in the garden?

"Yes".

31. Do you get roses from your garden?

"No".

32. Aren't you allowed to have them?

"No, I do have some plants; I give the roses to my teacher at school.

33. How do you think the brothers felt, when Beauty had to leave?
"I think they felt sad, they were nice like Beauty and they weren't selfish".
34. When she came back they didn't want her to go did they? Why?
"I think they'd been sad because she went and they just liked her and missed her so they wanted her to stay a little bit longer".
35. Who was doing the washing up when Beauty left?
"Um...I think the sisters...had to".
36. Would the Brothers?
"I don't think so".
37. How did you feel at the end of the story?
"Uh... I felt happy... (laugh)..."
38. For whom?
"For Beauty and the Prince".
39. And anybody else?
"Yes, for the father...because I think he wanted her to marry".
40. Who would you leave out if you could leave someone out?
"I'd leave out one of the sisters".
41. Which one?
"Um... the one who wanted the ruby necklace".
42. Why?
"Well, because it's expensive".
43. And you think she's greedy do you?
"Yes".
44. And who else would you leave out and still like this story?
"Um... the other sister".
45. No one else?
"No".

46. Drawing commenced for about ten minutes. The first drawing was of the sister who wanted the necklace (see Appendix I):
Why are you drawing the sister first?
"I think she's the easiest one".
47. She's not the prettiest is she?
"No".
48. What part of that story would you now like to put into pictures?
She now draws the scene of the dead beast with lightning in the sky i.e. the beast is both dead and being reborn.
49. What scene is this you are drawing now?
"When he's dead under the large tree, with lightning".
50. When does that lightning happen in the story?
"I think when he's dead".
51. If you read this story again what would you add? To make it more enjoyable?
"I'd say that they lived in the castle and that...um... the sisters made friends with Beauty".
52. What do you think his name is, besides Prince?
"Prince Andrew".
53. Where do you think his parents are?
"In a palace".
54. Not in his palace?
"No".
55. How do you think he can change into a handsome man?
"I think she just...um...I don't know...(laugh)".
56. Why did you stop reading fairy tales?
"Well, I thought they were a bit young for me so I felt I was going to read older books".

57. What is your second most favourite fairy tale?

"The Miller's Daughter. And she had to spin the thread into gold".

58. Why is it your favourite?

"Because it's sort of exciting...when she, you think she can't do it all in one night, but it's exciting when that little man comes in and helps her, and in the end he says what will you give and I haven't.... and she says I've got nothing to give you and so he says when you grow will you give me your young, but she didn't want to give her young".

I also got her description of the important event of the beast under the tree, dead. Her favourite scene remains the Beast lying under the tree even though she seems aware of the fact that Beauty broke the spell.

Asked why she said that "it's just a good scene".

59. Description of the Father in the story.

He has grey hair, kind face, brown boots, green suit.

60. Description of Mother:

She's dead, had a kind face, a red dress, yellow hair, red shoes and a rose was her favourite flower. (Her mother's favourite flower is a lily.)

61. Description of your father.

Kind, strong and generous.

62. Which one of Cinderella's sisters did you dislike?

The one who has a black dress, lots of clothes, is nasty, small nose (the nose is in fact very big), black hair and shoes.

63. What is your teacher like?

She has grey curly hair, wears a patterned dress; kind; kind face, pretty, old, like grandma.

64. Why is this sister in the story easy to draw.

The other is too complicated.

65. Who has the most clothes in the family?

I do.

APPENDIX H

Analysis of Illustrations of BEAUTY AND THE BEAST

Beauty and the Beast - Illustrations

Once again as in the Wizard the illustrations are largely commentaries on the action of the story.

Illustration : I

This appears at S.U.1 and it shows the 'pecking' order of the daughters; also the illustrator has done a good job on the two vain sisters who are seen either as self-admiring or plaintive while Beauty, facing away from the reader, is 'sitting at her father's feet'. The material security is also well drawn.

Illustration : II

This is the important S.U.6. A straightforward commentary on the unit of reading which is so important to the story.

Illustration : III

The beast is setting out the conditions; the father is afraid and the Beast is depicted as towering over him - a type of power relationship that becomes important later on.

Illustration : IV

Beauty is depicted here as in the gardens and it is the S.U. where she is told to be 'kind' to the Beast; the illustrator adds in the connotation with rabbits about the possible meaning of 'kind'.

Illustration : V

Beauty is seen singing to the Beast at S.U.16. Another rabbit appears to her left. One cannot help but notice that both of them are associated quite strongly with nature and that only one illustration takes place indoors, at S.U.1.

.../

The Beast is seen as lion-like and this is truly an addition by the illustrator - in fact he's not so bad looking and rather dashing, depicted as he is in swashbuckling clothes.

Illustration : VI

Beauty's shock-horror at the proposal; it is interesting here that she is in bed and it becomes difficult to associate this illustration with the proposal; it could after all refer to the father lying ill in bed. On the other hand it might refer to both.

Illustration : VII

The beast is lying on the ground, face down looking in the reader's direction. The tree is missing.

Illustration : VIII

The transformed Beast now a prince thanking Beauty for breaking the spell - more or less the posture of a man proposing in the custom of another time.

This is the last illustration and generally one can say that little has been added except the Beast's head which, of course, was necessary. Also of course there is the whole 'period' costuming that has been decided by the illustrator - basically what I would call an inter-textual result.

That the Beast should be a lion or like a lion seems a mistake in that the switching of affect onto an 'ugly' Beast (see S.U.27) is much more powerful; it seems that the illustrator has emphasized the ferocity of the Beast rather than what he looks like as a potential partner in marriage.

.../

In any case these illustrations are mostly comments on the story but one must agree with Bettelheim when he regrets the intrusion of the illustrator into this genre - much better to imagine the head of your typical Beast.

For the most part illustrations get in the way of the text; either for publisher's reasons in the Wizard or for adult mis-interpretations of the text, found here

APPENDIX J

TABLE 3.1 BEAUTY AND THE BEAST

TABLE 3-1

1

2

| | | |
|---------------------------|--|--|
| SIGNIFYING UNIT | Once upon a time there lived a rich merchant in a beautiful house with lovely gardens. He had four sons and three daughters. The two eldest, Miranda and Rosina, were vain and lazy. They liked satin dresses and jewels. The youngest was Beauty who was her father's pet. She was industrious, kind and loving to all. | The merchant lost his palace in a fire and his ships in a storm. The family moved into a small cottage. The two vain daughters grumbled about cooking and cleaning and coarse clothes. |
| LEVEL OF SEMIOSIS | This is a fairy tale | Sometimes in fairy tales terrible things happen. |
| LEVEL OF GRAMMATICAL UNIT | Introduction | Event |
| LEVEL OF AFFECT SIGNIFIED | Selfishness v. Selflessness SECURITY | Selfishness Insecurity |
| LEVEL OF RESULTS | External : inter-textual External : cultural | External : inter-textual External : cultural Internal : similarity |
| LEVEL OF PROPOSITIONS | Descriptive | Factual |
| LEVEL OF SIGNIFIERS | *Once upon a time (T) Rich (Att) Merchant (A) Beautiful (Att) House (L) Lovely (Att) Gardens (L) He (A) 4 sons (Att) 3 daughters (Att) 2 eldest (Att) | Miranda & Rosina (A) Vain & Lazy (Att) Satin dresses (o) Jewels (o) Youngest (Att) Beauty (A) Father's pet (att) She (A) Industrious (Att) Kind (Att) Loving (Att) To All (R) Lived Liked |
| | | Merchant (R) Palace (O) *Fire (P) Ships (O) *Storm (P) Family(A) * Lost Small(att) Moved Cottage(L) Grumbled 2 (att) Daughters (A) Cooking (O) Cleaning (O) Coarse (Att) Clothes (O) |

SIGNIFYING UNIT

One year later the Merchant hears that one ship is safe. He prepares to travel to the ship to get the gold yielded by the cargo.

LEVEL OF SEMIOSIS

But fairy tales always leave a glimmer of hope

LEVEL OF GRAMMATICAL UNIT

Transition (I)

LEVEL OF AFFECT SIGNIFIED

Hope of Security

LEVEL OF RESULTS

External : inter-textual
External : logical
Internal : similarity

LEVEL OF PROPOSITIONS

Anticipatory

LEVEL OF SIGNIFIERS

| | |
|----------------|---------------|
| *One (att) | He(A) hears |
| Year later (T) | to travel (P) |
| Merchant (R) | Ship (L) |
| one (att) | to get (P) |
| Ship (O) | Gold (o) |
| *Safe (att) | *prepares |
| | Cargo(o) |
| | Yielded by |

The father asks the daughters what they want. Miranda wants dresses. Rosina wants jewels. Beauty wants the Father's safety and a rose. He sets out.

Life could return to the introduction

Transition (II)

Selfishness v. Selflessness

Security (material/affective)

Anticipatory
Descriptive

| | |
|--------------------|----------|
| Father (A) | asks |
| *Daughters(R) | wants |
| What they want (O) | promises |
| Miranda(A) | sets out |
| *Dresses(O) | |
| Rosina (A) | |
| *Jewels (O) | |
| Beauty(A) | |
| *Father's (O) | |
| *Safety (O) | |
| *Rose (O) | |
| We(A) | |

SIGNIFYING UNIT He discovers that the captain has stolen the money. He is disappointed for the children.

LEVEL OF SEMIOSIS Remember the event

LEVEL OF GRAMMATICAL UNIT Event

LEVEL OF AFFECT SIGNIFIED Selfishness
Insecurity

LEVEL OF RESULTS External : cultural
Internal : similarity

LEVEL OF PROPOSITIONS Factual

LEVEL OF SIGNIFIERS He (A)
Captain (A)
Money (O)
He (A)
*Disappointed (att)
Children (R)
Discovers
*has stolen

On his return he sees a castle of gold in lovely gardens. He sees a rose arbour and remembers his promise to Beauty. He picks a rose.

The father loves his daughter very much

Episode Part (I)

Security
Selflessness

Internal : completion
External : inter-textual
Internal : completion : similarity

Action

On his return (T)
He (A)
Castle (O)
Gold (att)
Lovely (att)
Gardens (L)
*he (A)
Rose arbour (O)
*Promise (O)
*Beauty (R)
*Rose (O)
sees
remembers
*picks

SIGNIFYING UNIT

A horrible Beast roars behind him. He has a head like a fierce animal and the body of a man. The merchant is afraid and tells his story.

LEVEL OF SEMIOSIS

2. What is going to happen next?

1. The Merchant will be punished for picking someone else's rose.

LEVEL OF GRAMMATICAL UNIT

Episode Part (II)

LEVEL OF AFFECT SIGNIFIED

Insecurity

LEVEL OF RESULTS

Internal : completion
External : logical

LEVEL OF PROPOSITIONS

Action
Description

LEVEL OF SIGNIFIERS

Horrible(att)
*Beast(A)
Behind(L)
Him(O)
He(A)
Like a fierce animal(att)
The body of a man(att)
+Merchant(A)
*Afraid(Att)
Story (O)
Roars
Tells

The Beast tells the Merchant he will forgive him on one condition. One daughter will come to live with him.

2. What does the Beast want with one of the Merchant's daughters?

1. This is a fairy tale.

Transition Part (I)

Selfishness v. Selflessness

External : inter-textual
Internal : similarity

Conditional
Factual

Beast(A)
Merchant(R)
He(A)
Him(R)
*On one condition(P)
*One(att)
*Daughter(O)
Him(Acc)
Tells
will forgive
will come
*to live with

SIGNIFYING UNIT The Merchant promises to tell his family.
He promises to return and be the Beast's servant if they refuse.

LEVEL OF SEMIOSIS 3. The plot is thickening
2. What will the daughters reply?
1. The father is brave, honest and protective.

LEVEL OF GRAMMATICAL UNIT Transition Part (II)

LEVEL OF AFFECT SIGNIFIED Insecurity/selflessness

LEVEL OF RESULTS Internal : completion
Internal : similarity
Internal : repetition
External : logical

LEVEL OF PROPOSITIONS Anticipatory : factual

LEVEL OF SIGNIFIERS *Merchant(A)
To tell (O)
Family(R)
He(A)
To return and be(O)
*The Beast's servant(O)
If(preposition)
*promises
*promises
*refuse

The sisters declare if Beauty had not asked for such a ridiculous present, one of these misfortunes would have happened.

Beauty is responsible for getting the Father into trouble.

Episode Part (I)

Insecurity/Selfishness

Internal : similarity
External : logical

factual

Sisters (A)
If (prep)
Beauty (A)
*Such (att)
*Ridiculous (att)
*Present (O)
Misfortunes (O)
Declare
None would have happened

SIGNIFYING UNIT At last Beauty says she will go and live with the Beast to save her Father. The Father and brothers protest.

LEVEL OF SEMIOSIS Beauty feels responsible about what she has done.

LEVEL OF GRAMMATICAL UNIT Episode Part (II)

LEVEL OF AFFECT SIGNIFIED Insecurity
Selflessness

LEVEL OF RESULTS Internal : similarity

LEVEL OF PROPOSITIONS Anticipatory

LEVEL OF SIGNIFIERS Beauty (A)
She (A)
Beast (O/R)
*Father (R)
*To save (P)
Father (A)
Brothers (A)
Will go and live with (at last)
Protest

They set off and arrive at the castle which is already prepared for them. Beauty is charmed and they eat well. She almost forgets the Beast.

Things may not be so bad.

Transition

Hope of security

Internal : completion
External : inter-textual
Internal : similarity

Action / Descriptive

They (A)
Castle (L)
Which is already prepared for them (att)
Beauty (A)
*Charmed (att)
*They (A)
well (adv)
She (A)
Almost (adv)
Beast (R/O)
Set off and arrive
*Eat

SIGNIFYING UNIT

They hear a tramp, tramp in the passage.
Beauty clings to her Father. The Beast growls
good evening to the old man and Beauty.
Beauty is frightenedbut replies politely.

LEVEL OF SEMIOSIS

But they could be.

LEVEL OF GRAMMATICAL UNIT

Episode Part (I)

LEVEL OF AFFECT SIGNIFIED

Insecurity (fear)

LEVEL OF RESULTS

Internal : completion
Internal : similarity
External : cultural
External : logical
Internal : similarity
External : cultural

LEVEL OF PROPOSITIONS

Action

LEVEL OF SIGNIFIERS

They (A)
*Tramp, tramp (O)
Beauty (A)
Father (R)
*Beast (A)
Good evening (O)
Old man and Beauty (R)
Beauty (A)
But (conj)
Politely (adv)
Hear
*Clings
*Growls
Replies

The Beast asks the Merchant : did Beauty come
willingly. The Merchant says, yes. The Beast
tells him to go first thing in the morning and
never to venture near the castle; the old man
leaves, full of grief.

Why does the Beast want Beauty to be willingly
there without her father?

Episode Part (II)

Insecurity (loss)

Internal : similarity
Internal : factual
Internal : similarity
Internal : completion
Internal : similarity

Action

Beast (A) asks
Merchant (R) did
*Beauty (A) says
*Willingly (adv) tells
Merchant (A) *to go
Yes (O) to venture near
*Beast (A) *leaves
Him (R)
First thing in the
morning (T)
*Never (T)
Castle (L)
Old (att)
*Man (A)
Full of grief (adv)

SIGNIFYING UNIT

One day in the garden a voice tells Beauty to be kind to the poor Beast and she will be happy.

LEVEL OF SEMIOSIS

2. Is the meaning of 'kind' in this context selflessness?

1. Fairy tales always leave a glimmer of hope.

LEVEL OF GRAMMATICAL UNIT

Event

LEVEL OF AFFECT SIGNIFIED

Hope of security

LEVEL OF RESULTS

External : inter-textual
External : cultural
Internal : similarity

LEVEL OF PROPOSITIONS

Factual

LEVEL OF SIGNIFIERS

One day (T)
In the Garden (L)
+Voice (A)
*kind (O)
*Poor (att)
*Beast (R)
She (A)
*Happy (att)
tells
will be
to be

Beauty admires the gold, dresses and jewels. The Beast seemed quite gentle. He said 'good evening' and he talked nicely. She says she is happy at the castle but she misses her sisters, brothers and dear father.

2. What does the Beast want with Beauty?

1. The Beast is not harmful.

Episode Part I

Security v. Insecurity
(material) (separation)

Internal : inversion
Internal : similarity
External : cultural; internal: sim.
Internal : similarity
External : cultural

Action

| | |
|---------------------|--------------|
| Beauty (A) | Castle (L) |
| Gold (O) | But (conj) |
| Dresses (O) | She (A) |
| Jewels (O) | Sisters (R) |
| Beast (A) | Brothers (R) |
| *quite gentle (att) | *Dear (att) |
| He (A) | *Father (R) |
| *Good evening (O) | admires |
| He (A) | seemed |
| Nicely (adv) | talked |
| She (A) | says |
| Happy (A) | misses |

SIGNIFYING UNIT

The Beast asks Beauty to marry him and always live there as the mistress of the beautiful palace. Beauty says no, in horror. The Beast sighs and tells Beauty to have pleasant dreams.

For some months Beauty lives in the comfort of the Castle. The Beast asks each evening Beauty to marry him. She always says No. The Beast becomes sadder and sadder until Beauty felt quite sorry for him.

LEVEL OF SEMIOSIS

2. But what is the meaning of marriage?
1. The meaning of being 'kind' is marrying the Beast; the meaning of kind is selfless.

2. Beauty is the cause of the Beast's distress.
1. The Beast has emotions just like a human.

LEVEL OF GRAMMATICAL UNIT

Episode Part II

LEVEL OF AFFECT SIGNIFIED

Insecurity (shock/horror)
Material security

Security v. Insecurity
(material) (sorrow at rejection)

LEVEL OF RESULTS

Internal : completion (S-level)
External : cultural
Internal : similarity; ext. : inter-textual
External : cultural
External : cultural

Internal : repetition
External : cultural
Internal : similarity; ext.: cul.

LEVEL OF PROPOSITIONS

Action

Descriptive

LEVEL OF SIGNIFIERS

Beast(A) says in horror
Beauty(R) sighs
*To marry(O) tells
Him(R)
There(L)
Beautiful (att)
Palace(O)
Beauty(A)
No(O)
Beast(A)
Beauty(R)
To have(O)
Pleasant(att)
Dreams(O)
asks
live as mistress

For some months(T) *Him(R)
Comfort(att) lives
Castle(L) asks
Beast(A) *says always (adv)
Each evening(T) becomes
Beauty(R) *felt quite sorry (adv)
To marry(O)
Him(R/O)
She(A)
Always(adv)
*No(O)
*Beast(A)
*Sadder and sadder (att)
Until(T)
*Beauty(A)

SIGNIFYING UNIT

During this time Beauty often thought of her father. One day she looked into a magic mirror. She saw her father lying ill in bed. She becomes sad.

LEVEL OF SEMIOSIS

2. The father's illness brings out Beauty's kindness.
1. This is still a fairy tale.

LEVEL OF GRAMMATICAL UNIT

Transition Part (I)

LEVEL OF AFFECT SIGNIFIED

Insecurity (sorrow at loss)

LEVEL OF RESULTS

Internal : similarity; ext.: cul.
 External : inter-textual; int.: completion
 Internal : factual
 Internal : similarity: ext.: cul.

LEVEL OF PROPOSITIONS

Factual

LEVEL OF SIGNIFIERS

| | |
|---------------------|-------------|
| During this time(T) | Father(R) |
| Beauty(A) | Ill(O) |
| Often(adv) | Bed(L) |
| Father(R) | *She(A) |
| One day(T) | *Sad(att) |
| She(A) | Thought |
| +Magic(att) | Looked into |
| +Mirror(O) | Saw |
| She(A) | Lying |
| | Becomes |

Next day Beauty asks the Beast to let her go home, for a little while, to see her father again and her brothers and sisters. The Beast was grieved as he loved Beauty so much. At last he agrees but Beauty must promise faithfully to return in two months or she may find him dead. He gives her a ring to return to the castle.

3. This is (still) a fairy tale
2. They will see each other again
3. He is really quite nice (decent)

Transition Part (II)

Security
 (seeing the father
 again)

v. Insecurity
 (the Beast's death)

Internal : similarity
 Internal : similarity
 Internal : similarity
 Internal : similarity
 Internal : similarity
 External : inter-textual
 Internal : completion

Conditional

| | |
|-----------------------|------------------|
| Next day(T) | As(Reason) |
| Beauty(A) | He(A) |
| Beast(R) | Beauty(R) |
| To let her go home(P) | *So much(adv) |
| For a little while(T) | At last (adv) |
| To see(P) | He(A) |
| Her father(R) | But(conj) |
| Again(adv) | *Faithfully(adv) |
| Brothers&Sisters(R) | *To return |
| *Beast(A) | In two months(T) |
| *Grieved | Or(conj) |

SIGNIFYING UNIT (20) Cont/...

She (S)
Him (R)
Dead (att)
He (A)
Her (R)
*Ring (O)
To Return (P)
The Castle (L)
She (A)
Next morning (T)
asks
loved
*agrees
must promise
may find
gives
sets out

SIGNIFYING UNIT

She arrives and the family is happy. Beauty runs to her father's room and seeing her he soon recovers. He asks if the Beast treated her kindly. After she tells her father all he wanted to know she showed Miranda and Rosina the beautiful presents she brought them and precious things for her brothers and a chest of gold for her father.

LEVEL OF SEMIOSIS

2. Everything is alright again.

1. The father was ill because he missed Beauty.

LEVEL OF GRAMMATICAL UNIT

Episode Part (I)

LEVEL OF AFFECT SIGNIFIED

Security (both types)
Selflessness v. Selfishness

LEVEL OF RESULTS

Internal : completion
Internal : similarity: Ext : cul
Internal : similarity
Internal : similarity: Ext : cul
Internal : similarity
Internal : factual

LEVEL OF PROPOSITIONS

Action

LEVEL OF SIGNIFIERS

| | |
|-------------------|--------------|
| She (A) | If (prep) |
| Family (A) | Beast (A) |
| Happy (att) | Her (R) |
| Beauty (A) | Kindly (adv) |
| Father's room (L) | After (adv) |
| Her (R) | She (A) |
| Soon (adv) | *Father (R) |
| He (A) | All (att) |

Two happy months passed quickly. Beauty began to think of her promise to the Beast. Her brothers beg her to stay on. She puts off going back to the castle.

Beauty is being selfish by breaking her promise to the Beast.

Episode Part (II)

Insecurity (selfishness)

Internal : completion
Internal : similarity : ext : cul
Internal : similarity ; ext : cul
Internal : inverse

Factual

| | |
|----------------|----------------|
| Two (att) | To stay on (O) |
| *Happy (att) | She (A) |
| Months (T) | Going Back (O) |
| Quickly (adv.) | Castle (L) |
| Beauty (A) | passed |
| To think (O) | began |
| *Her promise | beg |
| *The Beast | *puts off |
| +Brothers (A) | |
| Her (R) | |

SIGNIFYING UNIT (21) Cont/...

| | |
|---------------------|-------------|
| He(A) | *Gold(att) |
| To know(O) | Father(R) |
| She(A) | arrives |
| Miranda & Rosina(R) | runs |
| *Beautiful(att) | seeing |
| *Presents(O) | *recovers |
| She(A) | asks |
| Them(R) | treated |
| *Precious(att) | tells |
| Things(O) | wanted |
| Brothers(R) | showed |
| Chest(O) | Brought for |

SIGNIFYING UNIT

One night, Beauty has a terrible dream. The Beast is lying ill under a large tree. She hears a voice: 'You have broken your promise Beauty, and see what has happened.' Beauty is frightened and uses the ring to go to the castle.

LEVEL OF SEMIOSIS

Beauty feels responsible for the Beast's illness.

LEVEL OF GRAMMATICAL UNIT

Transition Part (I)

LEVEL OF AFFECT SIGNIFIED

Insecurity (guilt)

LEVEL OF RESULTS

Internal : inversion (the bad dream)
 External : cultural
 Internal : completion
 Internal : similarity; Ext : cul.
 Internal : factual
 Internal : completion

LEVEL OF PROPOSITIONS

Active

LEVEL OF SIGNIFIERS

| | |
|-----------------------|-----------------|
| One night(T) | Beauty(A) |
| Beauty(A) | Frightened(att) |
| Terrible(att) | +Ring(I) |
| Dream(O) | To go to(P) |
| Beast(A) | Castle(L) |
| Ill(att) | hears |
| Large(att) | *broken |
| Tree(L) | *see |
| She(A) | uses |
| Voice(O) | |
| You(A) | |
| Your(att) | |
| *Promise(O) | |
| Beauty(A) | |
| *What has happened(O) | |

She could not find the Beast in the Castle. At last in the evening Beauty ran into the garden weeping and calling his name. She came to a tree, like the one in her dream. She saw the Beast lying face down, apparently dead; she was horrified. She ran for some water to revive him.

Beauty is suffering for what she has done.

Transition Part (II)

Insecurity (anxiety)

Internal : logical
 Internal : completion
 Internal : similarity; Ext.: cul.
 Internal : completion
 Internal : inversion
 External : logical

Action

| | |
|----------------------------------|----------------------|
| She(A) | Apparently dead(att) |
| Beast(R) | She(A) |
| Castle(L) | Horrified(att) |
| At last in the evening(T) | She(A) |
| *Beauty(A) | For some water(O) |
| The garden(L) | To revive him (P) |
| *Weeping and calling (adv) | Could not find |
| His name(O) | ran |
| She(A) | came |
| +Tree(L) | saw |
| Like the one in her dream(comp.) | lying |
| She(A) | ran |
| Beast(R) | |
| Face down(adv) | |

SIGNIFYING UNIT

At last he opened his eyes. He was delighted to see Beauty again. He told her he would have supper with her that night.

LEVEL OF SEMIOSIS

2. Why is he having supper with her?

1. Beauty makes amends by saving the Beast's life!

LEVEL OF GRAMMATICAL UNIT

Episode Part (I)

LEVEL OF AFFECT SIGNIFIED

Security (relief)

LEVEL OF RESULTS:

Internal : completion
Internal : similarity
Internal : repetition

LEVEL OF PROPOSITIONS

Action

LEVEL OF SIGNIFIERS

At last (adv)
He (A)
Eyes (O)
He (A)
Delighted (att)
To see (O)
Beauty (R)
Again (adv)
He (A)
Her (R)
*He (A)
*Supper (O)
Her (R)
That night (T)
opened
told
*would have with

After supper, the Beast asks Beauty to marry him. She answers 'yes, dear Beast, I love you very much'. The Beast is surprised.

Saving his life is not enough, she also has to marry him.

Episode Part (II)

Security (love)

Internal : repetition
Internal : similarity
Internal : inversion

Action

After supper (T)
Beast (A)
Beauty (R)
*to marry (O)
Him (R)
She (A)
*Yes (O)
*Dear (O)
Beast (R)
I(A)
You (R)
asks
*answers
*love very much

Beast (A)
Surprised (att)

SIGNIFYING UNIT As she said this there was a tremendous flash of lightning and peal of thunder. The ugly Beast becomes a most handsome prince standing beside Beauty. The Beast thanks Beauty for breaking a witch's spell.

LEVEL OF SEMIOSIS 2.This is Beauty's reward for making amends.
1. This is a fairy tale.

LEVEL OF GRAMMATICAL UNIT Episode part (III)

LEVEL OF AFFECT SIGNIFIED Security (relief)

LEVEL OF RESULTS External : inter-textual

LEVEL OF PROPOSITIONS Action

LEVEL OF SIGNIFIERS As (adv)
She (A)
This (O)
*there was a tremendous flash of lightning and peal of thunder. (Case value of scenery and special effects)
Ugly(att)
Beast(A)
*Most handsome (att)
*Prince(R)
*Standing(att)
*Beside(L)
*Beauty(R)
Beast(A)
Beauty(R)
Breaking a witch's spell(O)
said
becomes
thanks

Next day, the Prince sent for her Father, sisters and brothers. He told them that she promised to marry him. There was a grand wedding at the castle with many guests. They lived happily ever after.

2. Everyone is happy because of Beauty's selflessness.
1. You have been reading a fairy tale.

Ending

Security

External : cultural
Internal : completion; Ext.: cul.
External: inter-textual

Descriptive

Next day (T)
*Prince (A)
Father, sisters, brothers(R)
He(A)
Them (R)
She (A)
To marry (O)
Him (R)
Grand (att)
Castle (L)
*with many guests(att)
They (A)
*Lived happily ever after (adv.)

APPENDIX K

TABLE 3.2 Mellissa's Version of The STORY

Table 3.2

| | 1. | 2. |
|---------------------------|--|---|
| SIGNIFYING UNIT | The nicest daughter was Beauty and the other one, the sisters, were selfish and they always wanted to take jewels and nice dresses. | ... and but one day there was a dreadful fire. |
| LEVEL OF SEMIOSIS | 2. These themes are important to me 1. This is a fairy tale | Sometimes in fairy tales terrible things happen. |
| LEVEL OF GRAMMATICAL UNIT | Introduction | Event |
| LEVEL OF AFFECT SIGNIFIED | Selfishness v. Selflessness MATERIAL SECURITY | Insecurity |
| LEVEL OF RESULTS | EXTERNAL : inter-textual | EXTERNAL : inter-textual |
| LEVEL OF PROPOSITIONS | Descriptive | Factual |
| LEVEL OF SIGNIFIERS | *Nicest (Att) Jewels (O) Daughter (A) Nice (Att) Beauty (A) *Other one (A) Take Sisters (A) Always wanted Selfish (ATT) | + and (conj) + but (conj) one day (T) * dreadful (Att) fire (O) |

-326-

3.

4.

SIGNIFYING UNIT and so somebody called to the man ... the ... um ... father; to go on, um, a ship with cargos.

... and the daughters...when he... the daughters had to do all the cleaning and the washing because they had to move in a small, little cottage.

LEVEL OF SEMIOSIS 2. The man is also a father
1. Fairy tales offer a glimmer of hope

1. Washing up without protest is being a nice girl

LEVEL OF GRAMMATICAL UNIT Transition

Event

LEVEL OF AFFECT SIGNIFIED Hope of security

Insecurity

LEVEL OF RESULTS External : inter-textual

Internal : completion
Internal : completion

LEVEL OF PROPOSITIONS Anticipatory

Factual

LEVEL OF SIGNIFIERS + and (conj)
+ so (conj)
+ somebody (A)
* Man ...the...um...father (R)
um ship (O)
with cargos (Att)
Called
to go on

and (conj)
the daughters (A)
+ when (r)
he (A)
the daughters (A)
* all the cleaning and the washing (O)
because (conj)
they (A)
in a small, little (Att)
cottage (O)
had to do
had to move in

| | | | |
|---------------------------|---|--|---|
| | 5. | | 6. |
| SIGNIFYING UNIT | I think he got a rose | | and he got into trouble with the Beast. |
| LEVEL OF SEMIOSIS | 1. The father loves his daughter very much | | 1. He stole the rose from the Beast |
| LEVEL OF GRAMMATICAL UNIT | Episode part I | | Episode part II |
| LEVEL OF AFFECT SIGNIFIED | Security | | Insecurity |
| LEVEL OF RESULTS | External : cultural Internal : completion | | External : cultural |
| LEVEL OF PROPOSITIONS | Action | | Action |
| LEVEL OF SIGNIFIERS | I (A) * he (A) * Rose (O) think got | | + and (conj) * he got into trouble with (idiomatic) the Beast (A) |

7.

SIGNIFYING UNIT and he asked her ... um ... him to let
 Beauty ... um come to him ... and so she
 ... um ... came

LEVEL OF SEMIOSIS 2. The father and daughter are separated
 by the sister

 1. The father and daughter are inseparable

LEVEL OF GRAMMAT- Transition
 ICAL UNIT

LEVEL OF AFFECT
 SIGNIFIED Insecurity

LEVEL OF RESULTS Internal : future
 External : inter-textual

LEVEL OF PROPOSITIONS Action

LEVEL OF SIGNIFIERS and (conj)
 he (A)
 * her (R)
 him (R)
 Beauty (R)
 and so (conj)
 she (A)
 asked
 to let
 um come to
 um came

8.

But she broke a promise when she saw her father
 ill and she said she'd come back after two months
 but she didn't

1. Beauty breaks the promise because of father's
 illness

Event

Selfish

External : cultural

Factual

+ But (conj) broke
 She (A) saw
 a promise (O) said
 when (T) would come back
 she (A) didn't
 her (ATT)

+ father (ATT)
 * ill (ATT)
 she (A)
 after 2 months (T)
 but (conj)
 she (A)

9.

10.

SIGNIFYING UNIT ... and so um she dreamed that she saw
 um Beast um dead under a large tree and
 when she went there she did and then there
 was thunder and he woke up.

... and they had a wedding.

LEVEL OF SEMIOSIS 2. I love my father but mother is a problem
 1. This is a fairy tale

2. The situation is not entirely happy
 1. This is a fairy tale

LEVEL OF GRAMMATICAL UNIT

Event

Ending

LEVEL OF AFFECT SIGNIFIED

Excitement
 Insecurity

Happiness

LEVEL OF RESULTS External : inter-textual
 Internal : completion

External : inter-textual
 Internal : completion

LEVEL OF PROPOSITIONS Factual

Factual

LEVEL OF SIGNIFIERS and so (conj) thunder
 + um and
 she (A) he
 um Beast (O/R) dreamed
 um dead (Att) saw
 under a large tree (L) went
 and when (T) * did
 she (A) woke up
 there (L)
 she (A)
 and then (conj)

and (conj)
 they (A)
 a wedding (O)