



Citation for published version:

Akinbade, Y, Harries, KA, Flower, CV, Nettleship, I, Papadopoulos, C & Platt, S 2019, 'Through-culm wall mechanical behaviour of bamboo', *Construction and Building Materials*, vol. 216, pp. 485-495.
<https://doi.org/10.1016/j.conbuildmat.2019.04.214>

DOI:

[10.1016/j.conbuildmat.2019.04.214](https://doi.org/10.1016/j.conbuildmat.2019.04.214)

Publication date:

2019

Document Version

Peer reviewed version

[Link to publication](#)

Publisher Rights

CC BY-NC-ND

University of Bath

Alternative formats

If you require this document in an alternative format, please contact:
openaccess@bath.ac.uk

General rights

Copyright and moral rights for the publications made accessible in the public portal are retained by the authors and/or other copyright owners and it is a condition of accessing publications that users recognise and abide by the legal requirements associated with these rights.

Take down policy

If you believe that this document breaches copyright please contact us providing details, and we will remove access to the work immediately and investigate your claim.

1 **Through-Culm Wall Mechanical Behaviour of Bamboo**

2 Yusuf Akinbade¹, Kent A. Harries², Chelsea V. Flower³, Ian Nettleship⁴, Christopher Papadopoulos⁵ and
3 Shawn Platt⁶

4 5 **Abstract**

6 Performance of full-culm bamboo structures is dominated by longitudinal splitting behaviour, often
7 exacerbated by connection details. This behaviour is a function of the transverse properties of this highly
8 orthotropic material. Considerable study of the longitudinal properties of bamboo is available in which it
9 is often concluded that bamboo may be considered as a fibre-reinforced composite material and material
10 properties may be assessed using rule-of-mixture methods. Nonetheless, few studies have addressed the
11 transverse properties of the bamboo culm wall, despite these largely governing full-culm behaviour. This
12 study investigated the transverse material property gradient through the culm wall and attempts to connect
13 the mechanical results to physical observations and phenomena. Most importantly, the study demonstrates
14 that the complex transverse behaviour of bamboo does not appear to behave as a classic fibre-reinforced
15 composite material in the direction transverse to the fibres. In this study, five different bamboo species,
16 *Phyllostachys edulis*, *Phyllostachys bambusoides*, *Phyllostachys meyeri*, *Phyllostachys nigra*, and
17 *Bambusa stenostachya* were tested using a modification of the flat-ring flexure test to obtain a measure of
18 the transverse tensile capacity of the bamboo. Microscopy analyses are used to qualitatively describe the
19 culm wall architecture and to quantitatively assess the failure modes through the culm wall thickness.

20 21 **Keywords**

22 bamboo; fibre gradient; fibre volume; material testing; rule of mixtures; splitting

23 24 **1. Introduction**

25 A functionally graded, natural fibre-reinforced material [Ghavami et al 2003], bamboo has evolved in
26 nature to efficiently resist environmental loads. Bamboo has been shown to have mechanical properties
27 comparable to those of conventional building materials and its worldwide availability gives it great
28 potential as an alternative building material. Rapid growth (mature in 3 to 5 years followed by a 2 to 3
29 year harvest cycle), very low fertilizer requirement (typically none) and the ability to replace conventional

¹ PhD candidate, Department of Civil and Environmental Engineering, University of Pittsburgh

² Bicentennial Board of Visitors Faculty Fellow and Professor, Department of Civil and Environmental Engineering, University of Pittsburgh; kharries@pitt.edu

³ Undergraduate Research Fellow, Department of Civil and Environmental Engineering, University of Pittsburgh

⁴ Associate Professor, Department of Materials and Mechanical Engineering, University of Pittsburgh

⁵ Associate Professor, Department of Civil and Engineering, University of Puerto Rico at Mayaguez

⁶ Post doctoral Researcher, University of Bath, United Kingdom.

30 materials that are resource and energy intensive, combine to make bamboo a potentially sustainable
31 material in terms of both ‘carbon footprint’ and social equity. Bamboo offers versatility for use in a broad
32 range of international contexts, from use as an affordable and sustainable material in developing countries
33 to rapidly-deployable structures for disaster relief, to mainstream or niche construction in wealthier
34 countries.

35 The structure of bamboo is composed of culms (stalks) with solid transverse diaphragms or ‘nodes’
36 separating hollow inter-nodal regions along its height (Figure 1a). The circular cross section (Figures 1b-
37 d) is composed of unidirectional cellulosic fibres oriented parallel to the culm’s longitudinal axis
38 embedded in a parenchyma tissue matrix [Grosser and Liese 1971]. The parenchyma tissue matrix
39 lignifies (hardens) as the culm matures leading to increased density and improved mechanical properties.
40 As a functionally graded material, bamboo has evolved to resist its primary loading in nature: its own
41 self-weight and the lateral effects of wind. As seen in Figure 1c, the density of fibres increases from the
42 inner culm wall to the outer culm wall. The wall thickness is largest at the base of the culm and decrease
43 with height up the culm. However, the size and quantity of vessels decrease with the height of the culm
44 and are replaced with bamboo fibres. This addition of fibres compensates for loss in strength and stiffness
45 due to reductions in diameter and wall thickness near the top of the culm, resulting in relatively uniform
46 engineering properties along the entire culm height [Amada 1996; Harries et al. 2017]. Like any fibre-
47 reinforced material, mechanical properties are highly correlated to the proportion and distribution of
48 fibres in the cross section. Mechanical properties are influenced by density, which depends on fibre
49 content, fibre diameter, and cell wall thickness [Janssen 2000]. The density of most bamboo is 700 – 800
50 kg/m³ depending on species, growing conditions, and position along the culm. The volume fraction of
51 fibres ranges from approximately 60% at the exterior face of the culm wall to 10-15% near the interior
52 face (Figure 1c). The variation in density through the culm wall has been assumed by various researchers
53 to be linear, quadratic, exponential, or a power function and is known to be species-dependent [Amada et
54 al. 1996 and 1997]. Table 1 summarises fibre volume distributions reported in the literature in addition to
55 gross section and inner and outer wall fibre volume ratios (V_f) and longitudinal moduli (E_L). Due to the
56 complex variation of the fibres and vascular bundles, the variation of material properties through the
57 culm-wall thickness has been shown to be significant [Richard and Harries 2015] and to have the effect of
58 increasing gross culm stiffness by about 10% as compared to an assumed uniform distribution of the same
59 volume of fibers [Janssen 2000]. Harries et al. [2017], in a more refined analysis, showed the effect of
60 fibre gradient on gross culm stiffness to result in about a 5% increase for thin-walled culms ($D/t < 8$) and
61 as much as 20% for thick-walled culms ($D/t > 8$; where D is the culm outer diameter and t is the culm
62 wall thickness).

63 In general, while highly variable, the longitudinal behaviour of bamboo is relatively well understood in a
64 qualitative sense. From an engineering perspective, the longitudinal behaviour is most typically
65 considered as a fibre-reinforced material in which longitudinal properties are obtained using a rule of
66 mixtures approach. For example, gross section modulus, E_L , is estimated from:

$$67 \quad E_L = V_f E_f + (1 - V_f) E_m \quad \text{Eq. 1}$$

68 Where V_f is the fibre volume ratio and E_f and E_m are the moduli of the fibre and matrix (parenchyma)
69 phases, respectively. Janssen (2000) reports typical values of $E_f = 35$ GPa and $E_m = 1.8$ GPa.

70 The dominant failure mode of bamboo, however, is longitudinal splitting associated with bamboo
71 carrying flexure, compression or tension loads; splitting is exacerbated by the use of simple bolted
72 connection details common in some bamboo construction [Sharma et al. 2012]. Janssen [1981] describes
73 the bending stresses in a culm as being characterised by the longitudinal compressive stress and
74 transverse strain in the compression zone of the culm, with failure eventually occurring due to
75 longitudinal splitting. This is ideally a Mode II⁷ longitudinal shear failure. However, in the presence of
76 perpendicular stresses (as is the case where ever there is a non-zero shear-to-moment ratio), there is some
77 Mode I component stress which significantly reduces the Mode II capacity. Richard et al. [2017]
78 demonstrate the effects of such mode mixity using longitudinal shear tests [ISO 2004] which capture pure
79 Mode II behaviour, split pin tests [Mitch et al. 2010] which capture Mode I behaviour, and culm bending
80 tests of different spans resulting in different degrees of mode mixing. For two different species, a thin
81 walled *P. edulis* and thick-walled *B. stenostachya*, the split pin tests resulted in Mode I capacities equal to
82 only 18% of the Mode II capacity determined from the longitudinal shear tests. Beam tests having mixed
83 mode behaviour exhibited shear capacities ranging from 40-70% of the Mode II capacity.

84 Both the Mode I and II behaviours described are primarily functions of the transverse properties of the
85 fibre-reinforced culm which are believed to be dominated by matrix (parenchyma) properties. Despite
86 their importance in the dominant observed behaviour of full-culm bamboo, there are few studies of the
87 transverse properties of the culm wall. In early work, Arce-Villalobos [1993] concluded that there is no
88 correlation between the density of bamboo and its transverse tensile strength. Janssen [2000], based on
89 flexural tests, reports that a transverse strain of 0.0013 results in transverse tensile failure of the culm wall
90 (with no indication of species or other variation). More recently, test methods have been proposed for
91 obtaining transverse properties of bamboo culms [Mitch et al. 2010; Sharma et al. 2012; Virgo et al.
92 2017] although these have not yet been widely adopted to obtain material properties over a range of
93 species and conditions. Sharma and Harries [2012] report a unique attempt to refine an edge bearing test
94 to determine through culm-wall distribution of properties. In this study, the culm was cut, using a water

⁷ Reference to Modes II and I are in relation to classical fracture mechanics in which Mode II refers to forces resulting in 'in-plane shear' and Mode I refers to perpendicular in-plane 'peeling' forces.

95 jet, into two or three concentric annular sections. Edge bearing test results for each resulting ‘ring’
 96 provided an improved measure of through-thickness transverse properties than could be obtained from a
 97 single full-culm section. The approach was limited to thicker culm walls, provided only two or three data
 98 points across the culm wall and did not result in repeatable specimens and was therefore abandoned.
 99 Tan et al. [2011] conducted a micro-scale study on the crack growth and toughening mechanisms of *P.*
 100 *edulis*. The study revealed that toughening was inversely related to fibre density. The authors noted that
 101 their results suggest the need to account for the anisotropic strength and fracture properties of bamboo in
 102 the design of bamboo structures.

103 In order to understand the transverse behaviour of bamboo, it is informative to consider laminate theory
 104 and the rule of mixtures for transverse properties:

$$105 \quad E_T = [V_f/E_f + (1 - V_f)/E_m]^{-1} \quad \text{Eq. 2}$$

106 Equation 2 is conventionally considered a lower-bound estimate of transverse properties since it does not
 107 account for the anisotropic nature of the fibre itself and, as a result, underestimates off-longitudinal
 108 properties [Mallick 2008]. The Halpin-Tsai equations [Halpin and Kardos 1976] are most often adopted
 109 to describe transverse behaviour of fibre-reinforced composites:

$$110 \quad E_T = E_m(1 + \zeta n V_f)/(1 - n V_f) \quad \text{Eq. 3}$$

$$111 \quad \text{Where } n = (E_f/E_m - 1)/(E_f/E_m + \zeta) \quad \text{Eq. 4}$$

112 The value of ζ is an empirical constant fitted to the elasticity solution for a fibre geometry and confirmed
 113 by experimental data [Halpin and Kardos 1976]:

$$114 \quad \zeta = 2 + 40V_f^{10} \quad \text{Eq. 5}$$

115 When considering transverse properties of longitudinally reinforced fibre composites having V_f less than
 116 0.5, it is conventional to assign $\zeta = 2$ [Hewitt and de Malherbe 1970]. Halpin-Tsai is equally applicable to
 117 determining longitudinal properties. For longitudinal properties of long continuous fibre composites (such
 118 as bamboo) however, Halpin-Tsai results in the same relationship as the rule-of-mixtures (Eq. 1).

119 Figure 2 presents theoretical longitudinal and transverse modulus distributions determined using the rule
 120 of mixtures and Halpin-Tsai, respectively (Equations 1 and 3). The fibre volume distribution illustrated is
 121 that proposed by Dixon and Gibson [2014] for *P. edulis* and is representative of most distributions
 122 reported in Table 1. The modulus distributions shown are normalised by the average modulus for the
 123 culm wall which is what should be obtained when testing a full-culm specimen (i.e., the apparent modulus
 124 of the gross section). In addition to the variation in properties, a shift of the neutral axis of the section (at
 125 which location ratios equal unity) toward the outer culm wall is evident. This shift results in the increase
 126 in gross culm stiffness described previously [Janssen 2000; Harries et al. 2017].

127 The objective of the present study is to investigate the transverse material property gradient through the
 128 culm wall and to connect the mechanical results to physical results, such as fibre density. In this study, a

129 modification to the flat-ring flexure [Virgo et al. 2017] test specimen, in which only portions of the culm
130 wall cross-section are tested, is used to obtain a measure of the transverse tensile capacity of the bamboo.
131 Microscopy analyses are used to qualitatively describe the culm wall architecture and to quantitatively
132 assess the failure modes through the culm wall thickness. Throughout this study, all data is also
133 normalised by culm wall thickness ($x = 0$ is the inner wall and $x = 1$ is the outer wall).

134 **2. Flat-ring Flexure Test**

135 The flat ring flexure test [Virgo et al. 2017] assesses the tendency of bamboo to fail via longitudinal
136 cracks using a full cross-sectional specimen that is $L \approx 0.2D$ in length. The specimen is subjected to 4-
137 point flexure as shown in Figure 3. The desired failure for this test occurs in the constant moment region.
138 The flat ring flexure test gives the apparent modulus of rupture of the specimen (f_r) which, due to
139 specimen geometry, is related to the transverse tension capacity of the bamboo. The modulus of rupture is
140 calculated from the test results as:

$$141 \quad f_r = 3Pa/(t_N + t_S)L^2 \quad \text{Eq. 5}$$

142 Where P is total load applied to specimen; a is the shear span; t_N and t_S are culm wall thickness at the
143 failure locations on either side of the culm; and L is the length of culm section tested (i.e., the flexural
144 depth of specimen). A practical test span is found to be approximately $S = 0.85D$ and the shear span
145 should be at least $0.33S$. This test is easily translated to a field setting, requiring only two loading plates,
146 four pins, and free weights, rather than a hydraulic press. Nonetheless, in this study, all tests were carried
147 out in a mechanically driven universal test machine. Tests are conducted in displacement control at a rate
148 of crosshead travel of 0.76 mm/min resulting in failure in between 1 and 5 minutes. Loads are obtained
149 using a load cell with a precision of $\pm 0.4\text{N}$. A specimen loading apparatus (Figure 3b) is used to ensure
150 accurate and repeatable specimen alignment. With this apparatus, test span and shear span can be varied
151 independently in increments of 5 mm. Prior to this study, the flat-ring flexure test has been used on only
152 full-culm cross sections. Such full-culm cross section specimens are referred to in this work as the control
153 specimens and the modulus of rupture thus obtained is denoted f_{rC} .

154 **2.1 Clipped Flat-ring Test Specimens**

155 This study adopts a modification to the flat-ring test specimen, in which only portions of the cross-section
156 are tested in order to determine the effect of the material property gradient through the culm wall. The
157 culms were cut into full cross-section specimens approximately $0.2D$ in length. Approximately 20
158 specimens were obtained from each internode and all specimens are obtained from three or four adjacent
159 internodes. In this way it can reasonably be assumed that there is little variation in properties among
160 specimens. Importantly, there is little variation in D and t among the samples used. ‘Clipped’ specimens
161 (Figure 4a) had test regions machined using an end mill (Figure 4b). Specimens were machined such that
162 $\alpha \approx 0.20t$ or $0.25t$ and β and γ are in increments of approximately $0.20t$ or $0.25t$ such that the sum $\alpha + \beta +$

163 $\gamma = t$, the culm wall thickness. This approach divides the culm wall into segments for which the modulus
164 of rupture determined from each segment is calculated from Eq. 6 and is assumed to represent the average
165 value for that segment; the value is then assigned to the centroid of the segment.

$$166 \quad f_r = 3Pa / (\alpha t_N + \alpha t_S) L^2 \quad \text{Eq. 6}$$

167 The machining was controlled such that α and β at both the N and S quadrant are the same in each
168 specimen (as a result, γ may differ slightly based on variation of t in the cross section). All as-tested
169 dimensions were recorded and these are used in individual calculations of specimen capacity. Control
170 specimens were not clipped; thus $\alpha = t$ and $\beta = \gamma = 0$. The results from the control specimens represent the
171 gross cross-section modulus, f_{rC} , against which the clipped-specimen data is normalised.

172 **3. Specimen Materials**

173 Five different bamboo species were tested in this study, *Phyllostachys edulis*, *Phyllostachys bambusoides*,
174 *Phyllostachys meyeri*, *Phyllostachys nigra*, and *Bambusa stenostachya*. All are thin-walled (D/t generally
175 greater than 8) except *B. stenostachya* which is a thick-walled species. All *Phyllostachys* culms were
176 obtained from a commercial importer and were water treated and kiln dried. The *B. stenostachya* was
177 commercially imported from Vietnam and was borax treated.

178 In order to place the materials reported in this study in the context of the broader literature, standard
179 longitudinal compression and longitudinal shear (so-called “bow-tie” test) tests (ISO 22157:2019) of all
180 species were conducted; the results are reported in Table 2. Bamboo density normalized for 12%
181 moisture content, ρ_{12} , (ISO 22157:2019) is also reported in Table 2. Specimens had been stored in a
182 laboratory environment for some time prior to testing; the moisture content of all specimens at time of
183 testing was between 13% and 15% as measured with an electronic (pin-type) moisture meter (Table 2).
184 The objective of this study is to assess the effects of through-culm wall fibre distribution. In order to limit
185 – to the extent possible – material variation, all specimens reported in this paper were taken from the
186 lower region of only a few culms coming from the same batch of each species. Test specimens were cut
187 from within 2 m of each other and included $0.2D$ long specimens for flat ring flexure and $1.0D$ long
188 specimens for compression and longitudinal shear testing. Adjacent samples were used for control and
189 clipped specimens. At least 30 control specimens were tested for each species and as many as 6
190 specimens of each clipped case were tested (n in Tables 3 and 4). Average culm diameter, D , and wall
191 thickness, t , for each group of samples are reported with the summary of test results in Tables 3 and 4.

192 **3.1 Fibre Distribution**

193 Seven full-culm cross sections (four for *B. Stenosostachya*) were selected and digital images were taken at
194 each of the four quadrants (N, S, E and W). These images were processed using a purpose-built MatLab
195 script to obtain the distribution of fibres through the wall cross section. An example of a collected image
196 and resulting MatLab pixel map is shown in Figure 5. The collected images are square, having a

197 dimension equal to the culm-wall thickness, t (Figure 5a). The image is divided in the through-thickness
198 direction into ten equal regions of thickness $t/10$ (Figure 5b) and the fibre volume ratio obtained for each
199 (Figure 5c). From this analysis, the average fibre distribution (expressed as third-order polynomial best-
200 fit curves) is obtained as summarised at the bottom of Table 1 in terms of the normalised culm wall
201 thickness, x ($x = 0$ is the inner culm wall and $x = 1$ is the outer culm wall). The coefficient of variation of
202 measured fibre volume ratios was less than 0.18 for all but *P. nigra*, which exhibited a COV = 0.24. The
203 28 *P. edulis* samples shown in Figure 5c have a COV = 0.13. The best-fit equations representing fibre
204 volume distribution reported in Table 1 all have a coefficient of determination $R^2 = 0.99$.
205 The fibre distribution among the four thin-wall *Phyllostachys* species is very similar. Indeed, a single
206 relationship could be given for all four species having $R^2 = 0.96$ as shown in Table 1. A marked
207 difference in fibre distribution is observed in the thick-walled *B. stenostachya*. Thus, fibre distribution is
208 observed to differ by genera (*Phyllostachys* and *Bambusa*) but less so among species in the same genera
209 (*Phyllostachys*).

210 **4. Full-wall Thickness Flat-Ring Flexure Test Results**

211 Modulus of rupture, f_{rC} , (Eq. 5) determined for the full-culm control specimens is reported in Table 3.
212 Within the genus *Phyllostachys*, these values are similar and notably greater than that observed for *B.*
213 *stenostachya*. Observed variation of test results is typical of bamboo and similar to that reported in Virgo
214 et al. [2017]. As recommended by Virgo et al., only specimens failing within the constant moment region
215 (Figure 3a) are included in the reported data. Additionally, outliers defined as data falling outside 1.5
216 times the interquartile range (so called Tukey fences (Hoaglin 2003)), were excluded from the reported
217 data.

218 **5. Clipped Flat-ring Test Results**

219 Experimentally determined values of normalised f_r/f_{rC} determined from the clipped tests are shown in
220 Figure 6 and the corresponding best fit second-order polynomial relationships are reported in Table 3.
221 These all illustrate a similar trend although *P. nigra* specimens exhibit relatively little variation through
222 the culm wall compared to the other species. With the clipped specimens, all failures occurred in the
223 clipped region and no data was determined to be an outlier.

224 **6. Effect of Outer Layer of Bamboo Culm**

225 Integrating the f_r/f_{rC} best-fit curves (Table 3) from $x = 0$ to $x = 1$ should represent the gross modulus
226 across the section; that is, the integral $\int f_r/f_{rC} dx$ should equal unity. However, as shown in Table 3, with the
227 exception of *P. meyeri*, the gross modulus obtained by integrating the clipped data exceeds unity by as
228 much as 20%. A possible explanation for this behaviour – one in which the sum of the parts exceeds the
229 capacity of the whole – is that failure of the full wall section control specimens is being initiated by a

230 ‘weak link’. A brittle failure of the outer layer of the culm wall initiating failure would explain this
231 observation.

232 The extreme outer layer of a bamboo culm consists of a silica-rich outer skin (epidermis) and a thin
233 region of densely packed fibres (this can be seen at the top of Figure 5). It is believed that this layer will
234 be more brittle than the rest of the culm wall and may help to initiate failures in specimens in which the
235 outer wall is included. Therefore in the clipped specimen testing a question arises: *is the outer layer*
236 *contributing disproportionately to the observed behaviour, especially to the control and $\beta = 0$ tests?* To
237 investigate this effect, additional specimens were tested having $\beta \approx 0.05t$ and $\alpha \approx 0.95t$ (i.e. $\gamma = 0$, see
238 Figure 4a); essentially, these are full-culm sections with only the outer layer ‘shaved’ away.

239 Twenty flat-ring flexure specimens were cut from comparable samples of each species tested in the
240 clipped test program (*P. edulis* was not included as there were no comparable specimens available).

241 Alternating specimens along the culm were prepared using a belt sander such that $\beta \approx 0.05t$ and $\alpha \approx 0.95t$
242 (Figure 4a). Resulting wall thicknesses in the constant moment region are reported in Table 4. Apart from
243 specimen preparation, all tests were identical to those reported previously. To assess potential changes in
244 specimen ductility, displacement of the applied load, δ , was measured and reported at failure of each
245 specimen. Results are presented in Table 4. Also shown in Table 4 is the p-value determined from an
246 unpaired t-test for each set of ‘shaved’ and unshaved specimen. The p-value is the probability that there is
247 no statistically significant difference between the compared conditions.

248 It is seen that the modulus of rupture, f_r , is essentially unaffected by the removal of the outer layer. With
249 the exception of *P. nigra*, the displacement at failure is observed to increase upon the removal of the outer
250 layer. This increase is greater than can be attributed to the loss of 5% of the moment of inertia of the cross
251 section (resulting from shaving the specimen) alone. To consider the observed behaviour in a normalised
252 fashion, the tangent ‘stiffness’, f_r/δ is also calculated. As seen in Figure 7, specimen stiffness (represented
253 as linear best-fit line in Figure 7) falls on the order of 15 to 30% (with the exception of *P. nigra*) despite
254 the moment of inertia being reduced only 5%. The modulus of rupture itself remains unchanged.

255 **7. Discussion of Observed Transverse Behaviour**

256 The data shown in Figure 6 and equations reported in Table 3 indicate a generally parabolic distribution
257 of modulus of rupture through the culm wall thickness with higher values at both the inner and outer
258 walls and a minimum near the middle of the wall thickness. The fibre volume distributions, also shown in
259 Figure 6 and given in Table 1, indicate a typically observed distribution having few fibres at the inner
260 wall and a greater volume fraction at the outer wall. Based on these fibre distributions, the predicted
261 distribution of modulus of rupture using the Halpin-Tsai equation (Equation 3) does not appear to capture
262 the experimentally observed behaviour, particularly in the inner half of the culm wall where fibre volumes

263 are lowest. Bamboo does not appear to be behaving as a classic fibre-reinforced composite material in the
264 direction transverse to the fibres.

265 The observed behaviour requires further study and may represent a material variation or morphological
266 variation through the bamboo culm wall thickness. To investigate this further, the failure planes of full-
267 culm wall thickness control specimens were investigated using a scanning electron microscope (SEM).
268 Figure 8 shows an SEM image of a typical *P. edulis* vascular bundle (near the outer culm wall) showing
269 the fibre bundles comprised of microfibrils surrounding the vessel and the parenchyma into which the
270 bundle is embedded. In Figure 8, the fibre bundle can be seen to be penetrated by intra-fibril cracks
271 whereas the interfaces between fibres and parenchyma appear quite intact. It is noted that the parenchyma
272 cell walls are relatively thick indicating a relatively mature culm age [at harvest] (Liese and Weiner
273 1996). The cracking of the fibres may therefore be a function of culm age (observed although not
274 described by Liese and Weiner). The age at harvest of the bamboo used in this study is unknown and
275 without comparative images, age cannot be estimated. Liese and Weiner (1996), however clearly describe
276 and Liese (1998) illustrates the thickening of the parenchyma wall with age. Alternatively, these cracks
277 may have formed as a result of shrinkage associated with drying (desiccation of the vessel) or treatment
278 of the bamboo. Chen et al (2018) clearly describes different behaviour of the parenchyma and interaction
279 between the parenchyma and fibres based on moisture content. Orsorio et al. (2018) argues that these
280 cracks result for extraction and preparation of the SEM sample. Further study will be made to address the
281 source of these cracks – which are relatively commonly seen – as they represent a stress raiser in the
282 adjacent parenchyma and may be the source of cracks in the parenchyma. Such an effect is shown in an
283 image in Chen et al. (2018) although not described by the authors.

284 Figure 9 shows SEM images taken from the failure plane of a flat-ring flexure test specimen. Each failure
285 plane was divided into a grid and images of each obtained, allowing the entire failure plane to be imaged.
286 The images shown in Figures 9b and 9c are typical of images obtained at the outer and inner walls,
287 respectively, of a *P.edulis* specimen obtained slightly above the neutral axis of the section in flexure (see
288 Figure 9a). Image features did not vary considerably based on their location through the depth of the
289 specimen (dimension L in Figure 9a).

290 In Figures 9b and 9c the failure plane can be seen to both follow the edge of the fibre bundles but also to
291 go through the bundles themselves – presumably propagating along the cracks observed in Figure 8. In
292 some locations, the failure plane can be seen to expose the vessels (voids) surrounded by the bundle.

293 Where it is seen at the failure plane, the interface between the parenchyma and the fibre bundle appears
294 intact. This supports the observation that the cracks in the fibre bundle initiate cracks in the parenchyma.

295 In such a case the failure plane represents the propagating crack and little damage would be expected at

296 interfaces parallel to the crack plane. Similar behaviour is reported by Chen et al. (2018) as the
297 propagation of cracks through the parenchyma but around the microfibrils comprising the fibre bundle.
298 Additionally, the parenchyma shown in Figures 9b and 9c, appear to be behaving differently. Near the
299 outer culm wall (Figure 9b), the failure appears to follow the interfaces between parenchyma cells. Near
300 the inner culm wall (Figure 9c), the failure plane often appears to pass through the parenchyma cells (seen
301 as non-intact cell walls in Figure 9c). This observation is typical of all images obtained in this study.
302 Indeed, near the outer culm wall, the parenchyma is occasionally observed to fail in ‘sheets’ of intact cells
303 as shown in Figure 10a. In other images (Figure 10b) the intact parenchyma close to the inner culm wall
304 appear ‘desiccated’: the intact cell wall appears to be ‘caving in’ or concave rather than being slightly
305 convex nearer the outer culm wall (Figure 8). This observation may suggest a gradient in moisture content
306 through the culm wall or a residual effect of moisture gradient during the drying process – recall that the
307 *P. edulis* was kiln-dried. Such a gradient should be expected. The bamboo culm epidermis is relatively
308 impermeable and resistant to wetting whereas the inner culm wall is permeable (Liese 1998, Yao et al.
309 2011). The effects of moisture content, 0%, 6% and 20%, on parenchyma behaviour of *P. edulis* has been
310 recently reported by Chen et al. (2018) who attribute increased toughness – particularly of the
311 parenchyma matrix, with increased moisture content.

312 The longitudinal aspect ratio of the parenchyma cells can be seen to be different in the outer (Figure 10a)
313 and inner (Figure 10b) regions of the culm wall. In recent work, Zeng et al. (2019) identified significantly
314 different morphology of parenchyma cell walls through the culm wall thickness of *P. edulis* samples.
315 Near the outer culm wall, parenchyma cell walls were tightly packed laminar structures with little annular
316 space at interstices (Figure 11c). Nearer the inner culm wall, the laminar structure of the cell wall was
317 separating and a larger triangular pore is present at parenchyma cell interstices (Figure 11a). It is unclear
318 how these differences impact the behaviour illustrated in Figure 9 but it is evident that parenchyma is not
319 homogeneous through the cross section. Neither Zeng et al. (2019) nor Liese (1998) provide insight on
320 the source of this inhomogeneity and the present authors can only speculate on its cause, although it does
321 appear to affect the through thickness mechanical behaviour of the culm wall.

322 **8. Conclusion**

323 This study investigated the transverse material property gradient through the bamboo culm wall and
324 attempts to connect the mechanical results to physical observations and phenomena. Most importantly,
325 the study demonstrates that the transverse behaviour is complex and that bamboo does not appear to
326 behave as a classic fibre-reinforced composite material in the direction transverse to the fibres.

327 In this study, a modification to the flat-ring flexure test specimen, in which only portions of the culm wall
328 cross-section are tested, is used to obtain a measure of the transverse tensile capacity of the bamboo.

329 Microscopy analyses are used to qualitatively describe the culm wall architecture and to quantitatively
330 assess the failure modes through the culm wall thickness. The following conclusions are made:

- 331 1. Fibre volume distribution through the culm wall was best described by third-order polynomial curves
332 and the COV was observed to be on the order of 0.20 in all cases. Fibre distribution and modulus of
333 rupture, f_{rc} , among the four thin-wall *Phyllostachys* species was very similar, while the same values
334 for *B. stenostachya* was markedly different.
- 335 2. The gross modulus obtained by integrating the clipped data exceeds the experimentally determined
336 value of f_{rc} by as much as 20%; that is, the sum of the parts exceeds the capacity of the whole culm.
- 337 3. The silica-rich epidermal layer of the culm wall appears to disproportionately affect the full-culm
338 modulus, f_{rc} . Full-culm specimens were tested without this layer and the modulus of rupture was
339 essentially unaffected. The stiffness of the specimens tested without the epidermal layer was reduced
340 considerably more than the small reduction in geometry implies.
- 341 4. The distribution of fibre volume and modulus of rupture through the culm wall thickness are shown to
342 not be correlated by conventional assumptions of fibre-reinforced composite material behaviour. The
343 Halpin-Tsai equation (Equation 3) does not appear to capture the experimentally observed behaviour,
344 particularly in the inner half of the culm wall where fibre volumes are lowest.

345 Scanning electron microscopy (SEM) images of the flat-ring flexure tests failure surfaces reveal a
346 complex behaviour that is not consistent with the assumptions of fibre-reinforced composite behaviour.

347 The following is observed:

- 348 5. Failure planes generally pass through the fibre bundles, affected by the vessels (voids) contained in
349 the bundles and cracking between individual fibres comprising the bundles. In general, the interface
350 between fibres and parenchyma (matrix) remains intact.
- 351 6. Failure within the parenchyma also varies based on location through the culm wall. Near the outer
352 culm wall, the failure appears to follow the interfaces between parenchyma cells however near the
353 inner culm wall, the failure often appears to pass through the parenchyma cells.
- 354 7. Morphologic characteristics of the parenchyma are seen to vary through the culm wall thickness
355 although it is unclear how these differences impact behaviour.

356 Considerably more research is required to understand the source of the variation in parenchyma structure
357 and its effect on mechanical properties of the bamboo culm. The variation may simply be the natural
358 morphology of the bamboo but may also arise from drying, curing and/or treatment processes. While
359 gross section properties are most important for full-culm bamboo construction, variation of properties
360 through the culm wall may be critical to the performance of laminated bamboo products, particularly
361 those employing tangentially cut strips such as glue-laminated bamboo and cross laminated bamboo
362 [Sharma et al. 2015].

363

364 **Acknowledgements**

365 This research was funded through National Science Foundation Award 1634739 *Collaborative Research:*
366 *Full-culm Bamboo as a Full-fledged Engineering Material*. Additional support from the 2015 Institute of
367 International Education Global Innovation Initiative Award *Bamboo in the Urban Environment* and the
368 University of Pittsburgh Swanson School Of Engineering *Summer Research Internship Program* is
369 gratefully acknowledged.

370

371

372 **References**

- 373 Amada, S., Ichikawa, T., Munekata, T., Nagase, Y., and Shimizu, H., (1997) Fiber texture and mechanical
374 graded structure of bamboo, *Composites: Part B*, **28B**, 13-20.
- 375 Amada, S., Munekata, T., Nagase, Y., Ichikawa, Y., Kirigai, A. and Zhifei, Y. (1996) The mechanical
376 structures of bamboos in viewpoint of functionally gradient and composite materials, *Journal of*
377 *Composite Materials*, **30**, 800-819.
- 378 Arce-Villalobos O.A. (1993) *Fundamentals of the design of bamboo structures*, Master's thesis,
379 Eindhoven University of Technology, The Netherlands.
- 380 Chen G., Luo H., Yang H., Zhang, T. and Li, S. (2018) Water effects on the deformation and fracture
381 behaviors of the multi-scaled cellular fibrous bamboo. *Acta Biomaterialia* **65**, 203-215
- 382 Dixon, P.G. and Gibson, L.J. (2014) The structure and mechanics of Moso bamboo material, *Journal of*
383 *the Royal Society Interface* **11**, 20140321.
- 384 Dixon, P.G., Ahvenainen, P., Aijazi, A.N., Chen, S.H., Lin, S., Augusciak, P.K., Borrega, M., Svedstrom,
385 K. and Dixon, L.J., Comparison of the structure and flexural properties of Moso, Guadua and Tre Gai
386 bamboo, *Construction and Building Materials*, **90**, 11-17.
- 387 Ghavami, K. and Marinho, A.B. (2005) Propriedades físicas e mecânicas do colmo inteiro do bambu da
388 espécie Guadua angustifolia, *Revista Brasileira de Engenharia Agrícola e Ambiental*, **9**(1), 107-114.
389 (in Portuguese)
- 390 Ghavami, K., Rodrigues, C.S., and Paciornik, S., (2003) Bamboo: Functionally Graded Composite
391 Material, *Asian Journal of Civil Engineering (Building and Housing)*, **4**(1), 1-10.
- 392 Grosser and Liese (1971) On the anatomy of Asian Bamboos, with Special Reference to their vascular
393 bundles. *Wood Science and Technology*, **5**, 290-312.
- 394 Habibi, M.K., Samaei, A.T., Gheshlaghi, B., Lu, J. and Lu, Y. (2015) Asymmetric flexural behaviour
395 from bamboo's functionally graded hierarchical structure: Underlying mechanisms, *Acta*
396 *Biomaterialia*, **16**, 178-186.
- 397 Halpin, J.C. and Kardos, J.L. (1976) The Halpin-Tsai Equations: A Review, *Polymer Engineering and*
398 *Science* **16**(5), 344-352.
- 399 Harries, K.A., Bumstead, J., Richard, M.J. and Trujillo, D. (2017) Geometric and Material Effects on
400 Bamboo Buckling Behaviour, *ICE Structures and Buildings* Themed issue on bamboo in structures
401 and buildings, **170**(4), 236-249.
- 402 Hewitt, R.L. and de Malherbe, M.C. (1970) An Approximation for the Longitudinal Shear Modulus of
403 Continuous Fiber Composites, *Composite Materials*, **4**, 280.
- 404 Hoaglin, D.C. (2003) John W. Tukey and Data Analysis, *Statistical Science* **18**(3), 311-318.
- 405 ISO 22157:2019 *Bamboo structures -- Determination of physical and mechanical properties of bamboo*
406 *culms -- Test methods*. International Organization for Standardization
- 407 Janssen, J. (1981) *Bamboo in Building Structures*. Doctoral Dissertation, Eindhoven University of
408 Technology, Netherlands.
- 409 Janssen, J.J.A., (2000) *Designing and Building with Bamboo*, INBAR Technical Report 20. International
410 Network for Bamboo and Rattan, Beijing, China.
- 411 Krause, J.Q., Andrade Silva, F., Ghavami, K., Gomes, O.F.M, Toledo Filho, R.D., On the influence of
412 Dendrocalamus giganteus bamboo microstructure on its mechanical behavior, *Construction and*
413 *Building Materials*, **127**, 199-209.

414 Liese, W. (1998) *The Anatomy of Bamboo Culms*, Brill. 204 pp.

415 Liese, W. and Weiner, W. (1996) Ageing of Bamboo Culms. A Review. *Wood Science and Technology*,
416 **30**, 77-89.

417 Mallick, P. K. (2008). *Fiber-reinforced composites: materials, manufacturing, and design* (third edition).
418 CRC press.

419 Mitch, D., Harries, K.A., and Sharma, B. (2010) Characterization of Splitting Behavior of Bamboo
420 Culms. *ASCE Journal of Materials in Civil Engineering* **22**, 1195-1199.

421 Nogata, F. and Takahashi, H. (1995) Intelligent functionally graded material: bamboo, *Composites*
422 *Engineering*, **5**, 743-751.

423 Osorio L., Trujillo E., Lens F., Ivens, J. Verpoest, I. and Van Vuure, AW., (2018) In-depth study of the
424 microstructure of bamboo fibres and their relation to the mechanical properties. *Journal of Reinforced*
425 *Plastics and Composites* **37**, 1099-1113

426 Richard, M. (2013) *Assessing the Performance of Bamboo Structural Components*, Doctoral Dissertation,
427 University of Pittsburgh.

428 Richard, M., Gottron, J., Harries, K.A. and Ghavami. K. (2017) Experimental Evaluation of Longitudinal
429 Splitting of Bamboo Flexural Components, *ICE Structures and Buildings* Themed issue on bamboo in
430 structures and buildings, 170(4), 265-274

431 Richard, M.J., Harries, K.A., (2015) On Inherent Bending in Tension Tests of Bamboo, *Wood Science*
432 *and Technology* **49**(1) 99-119.

433 Shao, Z.P., Zhou, L., Liu, Y.M., Wu, Z.M. and Arnauld, C. (2010) Differences in structures and strength
434 between internode and node sections of Moso bamboo, *Journal of Tropical Forest Science*, **22**(2),
435 133-138.

436 Sharma B, Gatoo A, Bock M, Ramage M (2015) Engineered Bamboo for structural applications.
437 *Construction and Building Materials*, **81**, 66-73.

438 Sharma, B., Harries, K.A. and Ghavami, K. (2012) Methods of Determining Transverse Mechanical
439 Properties of Full-Culm Bamboo, *Journal of Construction and Building Materials*, **38**, 627-637.

440 Sharma, B. and Harries, K.A. (2012). Effect of Fiber Gradation on the Edge Bearing Strength on Bamboo
441 Culms, *Key Engineering Materials*, Vol 517, pp 63-70.

442 Tan, T., Rahbar, N., Allameh, S.M., Kwoolfie, S., Dissmore, D., Ghavami, K. and Soboyejo, W.O. (2011)
443 Mechanical Properties of functionally graded hierarchical bamboo structures, *Acta Biomaterialia* **7**,
444 3796-3803.

445 Vaessen, M.J. and Janssen, J.A. (1997) Analysis of the critical length of culms of bamboo in four-point
446 bending tests, *HERON*, **42**(2), 113-124.

447 Virgo, J., Moran, R., Harries, K.A., Garcia, J.J., and Platt, S. (2017) Flat Ring Flexure Test for Full-Culm
448 Bamboo, *Proceedings of 17th International Conference on Non-Conventional Materials and*
449 *Technologies (17NOCMAT)*, Yucatán, México, November 2017.

450 Yao, L.H., Wang, X.M. and Fei, B.H. (2011) Study on Permeability Coefficient of Different Bamboo/Fir
451 Veneer Surface, *Advanced Materials Research*, **311-313**, 1634-1637.

452 Zeng, Q., Zhang, Q., Lu, Q., Zhou, Y., Chen, N., Rao, J. and Fan, M. (2019; in press) Wetting behavior
453 and laminate bonding performance of profiled tangential surfaces of moso bamboo, *Industrial Crops*
454 *and Products*

455

Table 1 Summary of through-culm wall fibre volume and modulus distributions.

ref ¹	method ²	species	B M T ³	gross section		interior ($x = 0$)		exterior ($x = 1$)		proposed relationship
				V_f	E_L (GPa)	V_f	E_L (GPa)	V_f	E_L (GPa)	
1, 2	IA	general	nr	0.40	-	0.20	-	0.60	-	$V_f = 0.40x + 0.20$
3	V_f : IA E_L : RoM	<i>P. edulis</i>	B	-	9.1	0.09	2.5	0.77	22.6	exponential V_f $E_L = (E_{L,x=0})e^{2.2x}$
			T	-	13.7	0.11	3.8	0.88	33.8	
4	V_f : IA E_L : tens	<i>P. edulis</i>	B	0.25	-	0.17	4	0.50	29	exponential V_f and E_L
			M	0.28	-	0.18	6	0.56	30	
			T	0.34	-	0.10	6	0.60	32	
5	IA	<i>P. edulis</i>	nr	0.28	-	0.12	-	0.62	-	$V_f = 0.49x^2 + 0.0066x + 0.12$
5	IA	<i>D. giganteus</i>	B	0.42	-	0.29	-	0.53	-	$V_f = -0.09x^2 + 0.33x + 0.29$
			M	0.43	-	0.21	-	0.62	-	$V_f = 0.07x^2 + 0.29x + 0.26$
			T	0.43	-	0.19	-	0.60	-	$V_f = -0.12x^2 + 0.51x + 0.21$
6	V_f : SEM E_L : tens	<i>G. angustifolia</i>	B	0.26	16.0	0.19	-	0.62	-	$V_f = 0.83x^2 - 0.41x + 0.19$
			M	0.26	14.6	-	-	0.54	-	$V_f = -1.02x^3 + 2.61x^2 - 1.38x + 0.33$
			T	-	13.2	-	-	0.54	-	$V_f = -4.13x^4 + 9.68x^3 - 6.68x^2 + 1.71x - 0.04$
7	tens	<i>P. edulis</i>	M	-	-	0.12	4.5	0.54	21	$E_L = 40.13V_f + 0.22$
8	nano	<i>P. edulis</i>	nr	-	-	-	6.5	-	13.8	none reported
9	SEM	<i>P. edulis</i>	B	0.21	-	0.06	-	0.52	-	$V_f = (0.23x + 0.71)(0.09e^{1.83x})$
			M	0.23	-	0.06	-	0.58	-	$V_f = (0.23x + 0.71)(0.09e^{1.48x})$
			T	0.26	-	0.06	-	0.69	-	$V_f = (0.23x + 0.71)(0.09e^{2.11x})$
10	V_f : SEM E_L : nano	<i>P. edulis</i>	nr	-	14.9	0.07	-	0.58	-	none reported
		<i>G. angustifolia</i>	nr	-	19.7	0.16	-	0.60	-	
		<i>B. stenostachya</i>	nr	-	13.8	0.05	-	0.42	-	
11	flex	<i>P. edulis</i>	nr	-	8.7	-	2.8	-	15.2	$E_L = 12.43x^{0.43} + 2.78$
12	V_f : SEM E_L : tens	<i>D. giganteus</i>	M	-	-	0.38	17.6	0.55	30.7	culm wall divided into thirds
		at $x = 0.5$	-	-	0.45	27.3	-	-		
this study	IA	<i>P. edulis</i>	B	0.29	-	0.12	-	0.67	-	$V_f = 1.41x^3 - 1.23x^2 + 0.50x + 0.10$
		<i>P. bambusoides</i>	B	0.32	-	0.14	-	0.65	-	$V_f = 0.96x^3 - 0.91x^2 + 0.57x + 0.10$
		<i>P. nigra</i>	B	0.26	-	0.07	-	0.64	-	$V_f = 0.94x^3 - 0.63x^2 + 0.36x + 0.06$
		<i>P. meyeri</i>	B	0.35	-	0.11	-	0.70	-	$V_f = 0.15x^3 + 0.34x^2 + 0.17x + 0.11$
		<i>B. stenostachya</i>	B	0.35	-	0.24	-	0.64	-	$V_f = 1.75x^3 - 1.98x^2 + 0.75x + 0.20$
		all four <i>Phyllostachys</i>	B	-	-	-	-	-	-	$V_f = 0.86x^3 - 0.61x^2 + 0.40x + 0.09$

x = normalized dimension through culm wall; V_f = fibre volume ratio; E_L = longitudinal tensile modulus of elasticity

¹references: 1 = Janssen 1981; 2 = Vaessen and Janssen 1997; 3 = Nogata and Takahasi 1995; 4 = Amada et al. 1996; 5 = Ghavami et al. 2003; 6 = Ghavami and Marhinho 2005; 7 = Shao et al. 2010; 8 = Tan et al. 2011; 9 = Dixon and Gibson 2014; 10 = Dixon et al. 2015; 11 = Habibi et al. 2015; 12 = Krause et al. 2016

² methods of determining data: IA = image analysis; SEM = scanning electron microscope; RoM = rule of mixtures; tens = tension tests; nano = nanoindentation; flex = flexural tests

³ locational along height of culm: B = bottom; M = middle; T = top; nr = not reported

459

Table 2 Mechanical properties bamboo used in this study (COV in parentheses).

species	density at 12% MC, ρ_{12}	moisture content at time of test	compressive strength, f_c	longitudinal shear strength, f_v
	kg/m ³	%	MPa	MPa
<i>P. edulis</i>	896 (0.01)	14.0	48.1 (0.20)	15.1 (0.11)
<i>P. bambusoides</i>	818 (0.04)	14.6	59.3 (0.26)	14.6 (0.22)
<i>P. nigra</i>	907 (0.02)	14.8	45.2 (0.13)	14.6 (0.16)
<i>P. meyeri</i>	840 (0.04)	13.7	55.8 (0.11)	16.4 (0.05)
<i>B. stenostachya</i>	616 (0.03)	13.0	46.0 (0.21)	9.9 (0.11)

460

461

462

Table 3 Summary of experimental results on clipped specimens (COV in parentheses).

species	full-culm control specimens			clipped specimens					
	n	D mm	t mm	f_{rc} MPa	n	D mm	t mm	f_r/f_{rc}	$\int \frac{f_r}{f_{rc}} dx$
<i>P. edulis</i>	33	117 (0.06)	10.1 (0.10)	17.3 (0.18)	13	112 (0.05)	9.5 (0.09)	$4.0x^2 - 4.9x + 2.3$ ($R^2 = 0.82$)	1.18
<i>P. bambusoides</i>	27	95.5 (0.05)	8.2 (0.22)	15.7 (0.21)	14	94.8 (0.06)	8.1 (0.24)	$2.6x^2 - 2.5x + 1.5$ ($R^2 = 0.31$)	1.12
<i>P. nigra</i>	31	93.5 (0.03)	6.7 (0.19)	15.6 (0.14)	16	92.4 (0.01)	6.5 (0.14)	$0.7x^2 - 0.8x + 1.4$ ($R^2 = 0.08$)	1.23
<i>P. meyeri</i>	49	65.3 (0.12)	6.6 (0.10)	20.0 (0.16)	20	65.2 (0.09)	6.4 (0.11)	$2.4x^2 - 1.8x + 1.1$ ($R^2 = 0.59$)	1.00
<i>B. stenostachya</i>	39	77.5 (0.06)	14.5 (0.32)	9.4 (0.13)	17	75.4 (0.06)	14.7 (0.28)	$4.1x^2 - 3.6x + 1.6$ ($R^2 = 0.77$)	1.17

463

464

Table 4 Summary of results from specimens having outer layer removed (COV in parentheses).

species	n	<i>D</i>	<i>t</i>	modulus of rupture, f_r		deflection, δ		f_r/δ	
		mm	mm	MPa	p ¹	mm	p ¹	MPa/mm	p ¹
<i>P. bambusoides</i>	10	99.6 (0.01)	6.47 (0.09)	18.1 (0.08)	0.09	1.86 (0.13)	0.00	9.9 (0.14)	0.01
outer layer removed	10	99.8 (0.01)	0.92 t (0.04)	19.7 (0.12)		2.30 (0.16)		8.4 (0.08)	
<i>P. nigra</i>	10	96.0 (0.01)	8.44 (0.03)	26.4 (0.16)	0.75	2.10 (0.09)	0.59	12.6 (0.15)	0.99
outer layer removed	9	95.8 (0.01)	0.95 t (0.02)	26.0 (0.06)		2.06 (0.06)		12.6 (0.06)	
<i>P. meyeri</i>	4	62.8 (0.00)	6.58 (0.02)	22.5 (0.08)	0.22	0.95 (0.20)	0.06	25.0 (0.33)	0.09
outer layer removed	5	62.9 (0.01)	0.95 t (0.02)	21.0 (0.07)		1.21 (0.14)		17.6 (0.14)	
<i>B. stenostachya</i>	7	71.7 (0.02)	15.00 (0.03)	13.8 (0.10)	0.86	1.59 (0.22)	0.10	9.3 (0.30)	0.13
outer layer removed	9	72.2 (0.02)	0.95 t (0.04)	14.0 (0.09)		1.91 (0.18)		7.6 (0.17)	

¹ p-values indicate the probability that there is no statistical difference between the compared samples

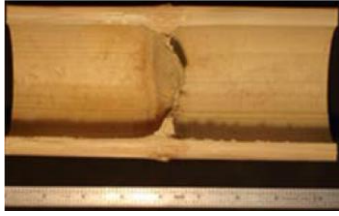

a) longitudinal section of bamboo culm showing portions of internodes to either side of node



b) cross section of culm near node diaphragm

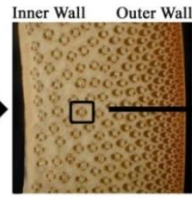

c) section through culm wall

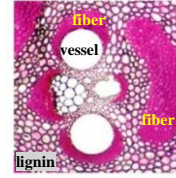

d) vascular bundle

Figure 1 Anatomy of bamboo culm showing functionally graded distribution of fibre in culm wall [adapted from Richard 2013].

468

469

470

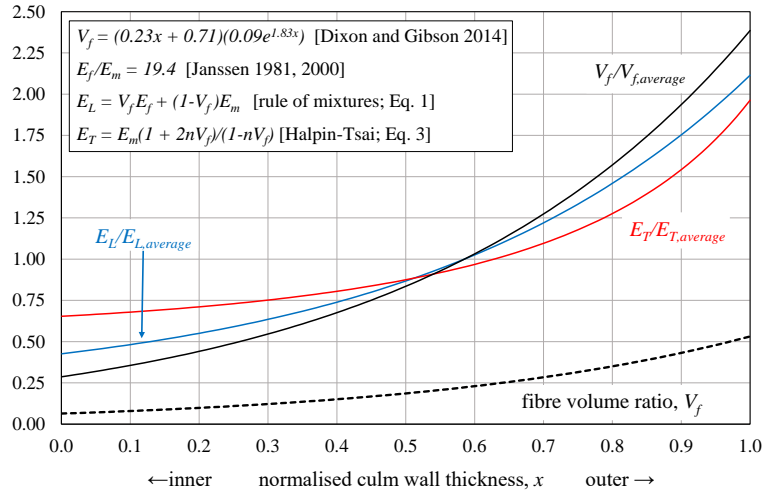

471

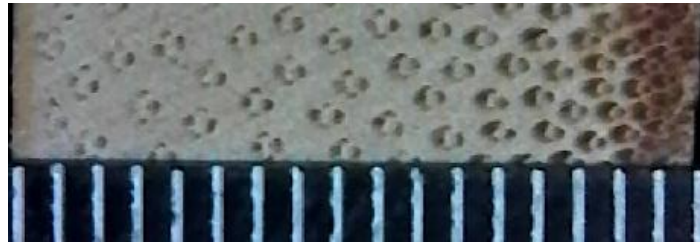

472

473

474

Figure 2 Distribution of fibres and modulus through culm wall based on rule of mixtures.

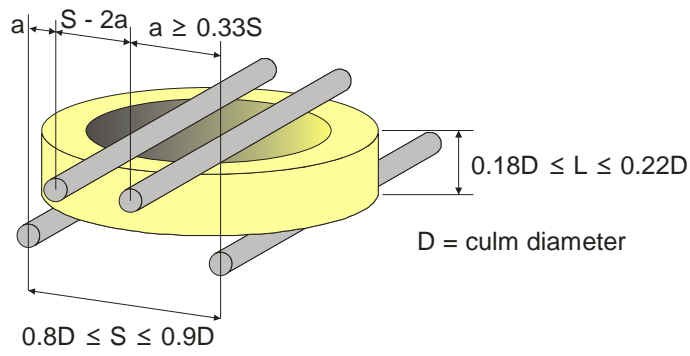

a) test set-up schematic and dimensions



b) test being conducted in universal test machine (shown: 100 mm diameter culm tested over 80 mm span with 25 mm shear span)

475

476

477

478

Figure 3 Flat ring flexure test.

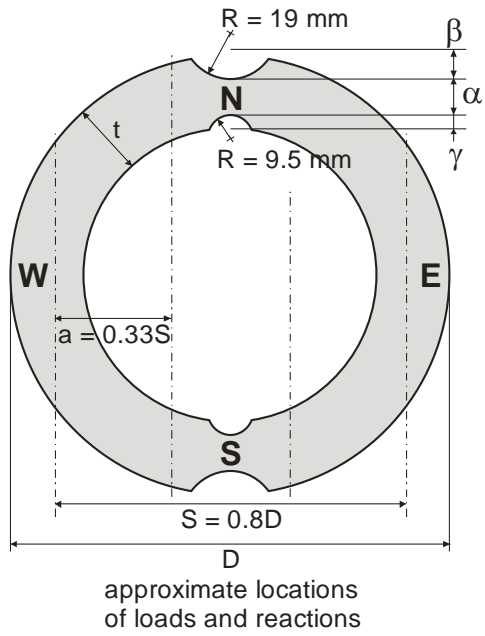

a) test specimen schematic and dimensions b) specimen machining (shown: $\beta = 0$, $\alpha = 0.20t$ and therefore, $\gamma = 0.80t$)

479

480

Figure 4 Flat ring flexure specimen.

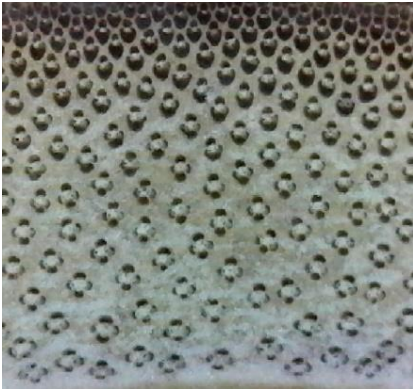

a) image of culm wall

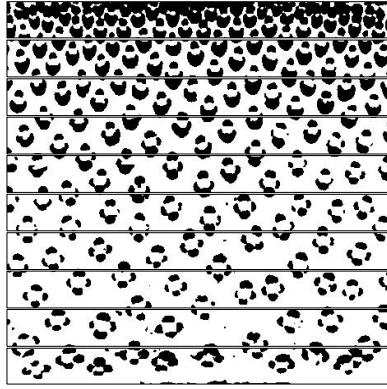

b) MatLab pixel map of fibres divided into ten layers

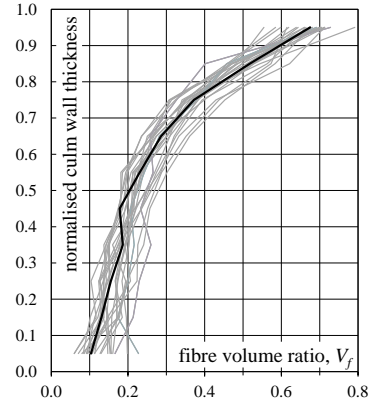

c) fibre volume distribution for 28 *P. edulis* samples, Black line corresponds to image in figures a) and b)

481
482
483
484
485

Figure 5 Example of digital image analysis of culm wall (*P. edulis* sample shown)

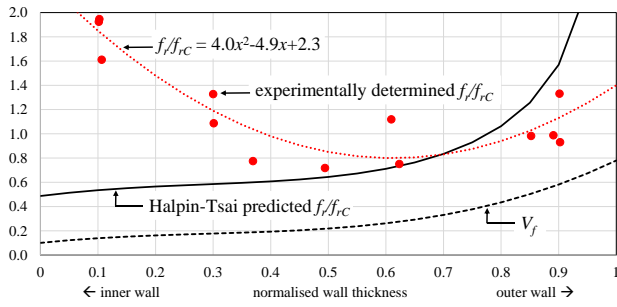

a) *P. edulis*

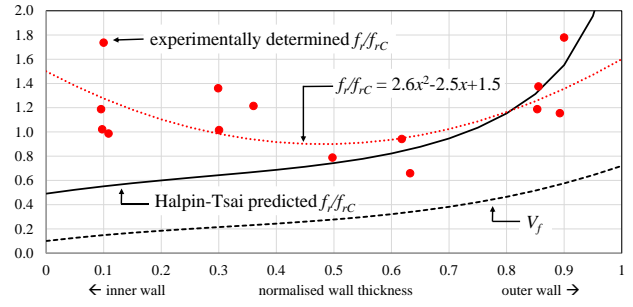

b) *P. bambusoides*

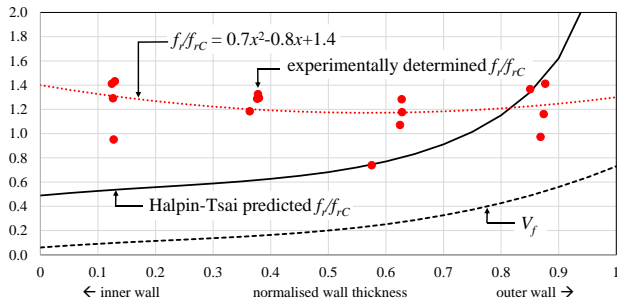

c) *P. nigra*

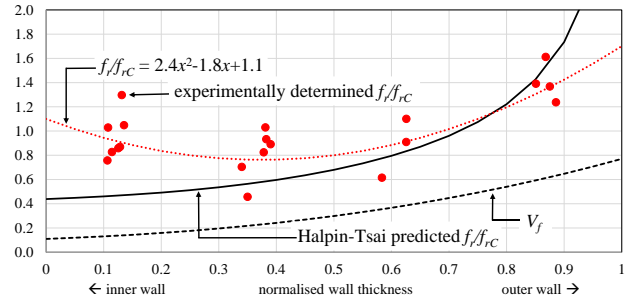

d) *P. meyeri*

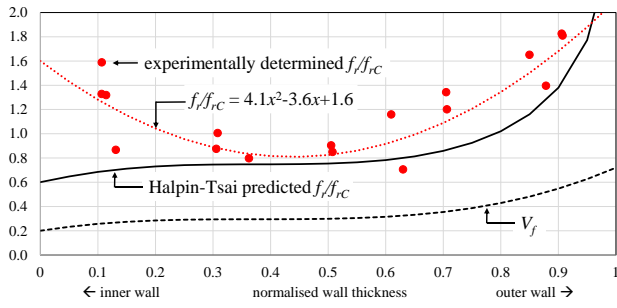

e) *B. stenostachya*

Figure 6 Variation of modulus of normalised rupture through culm wall section.

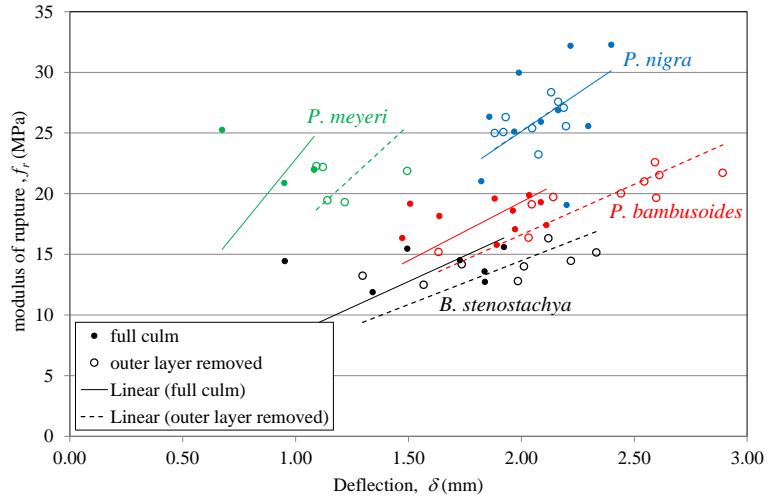

488

489

Figure 7 Comparison of full-culm specimens and those having only outer layer removed.

490

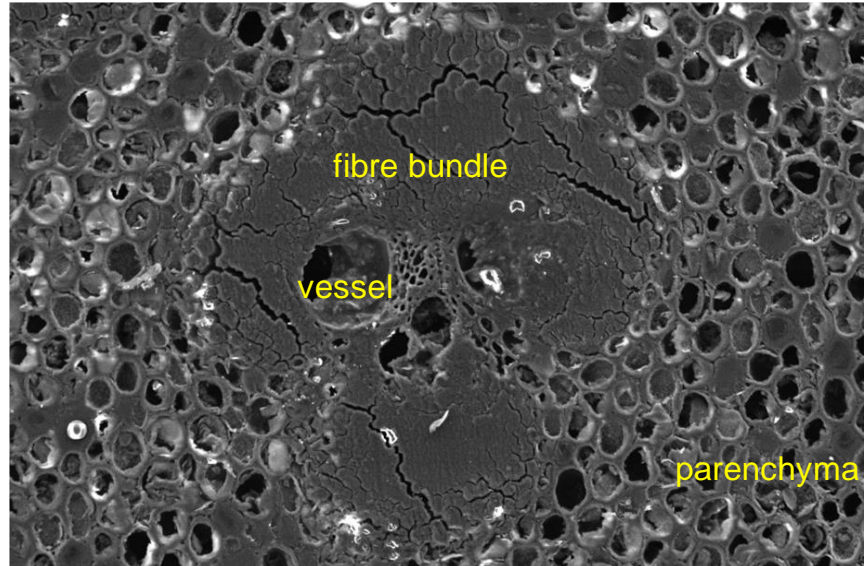

491
492
493

0.2 mm
Figure 8 SEM image of *P. edulis* vascular bundle

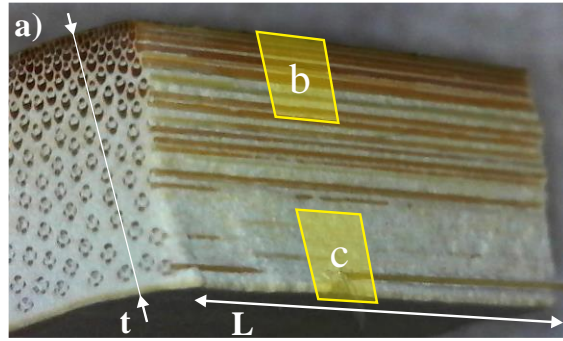

outer wall

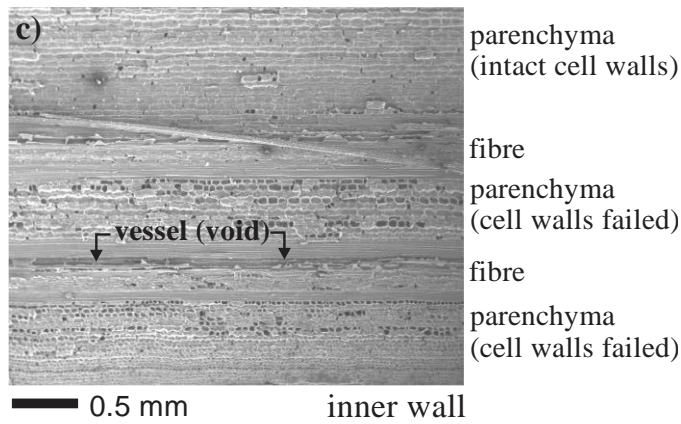
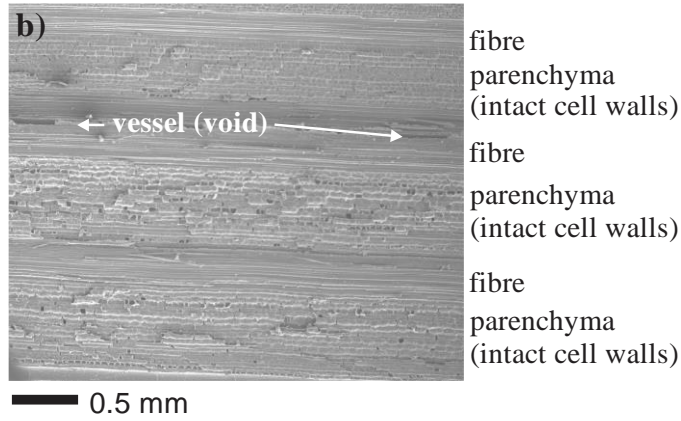
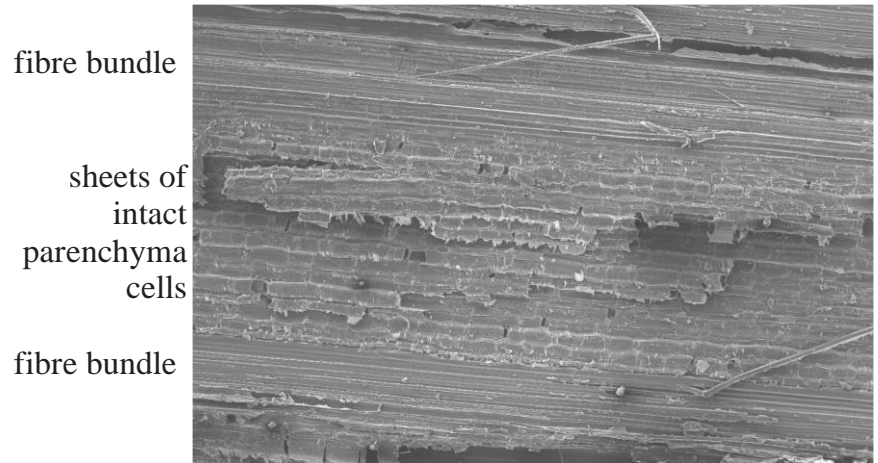

Figure 9 Detail of culm wall images of *P. edulis* specimen
 (note that images in parts b and c are not the same specimen as shown in a)

494
 495
 496
 497
 498



0.2 mm

a) parenchyma between two fibre bundles near outer culm wall

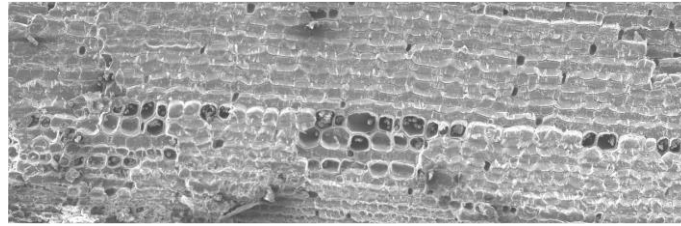

0.2 mm

b) parenchyma near inner culm wall

Figure 10 SEM images of *P. edulis* parenchyma.

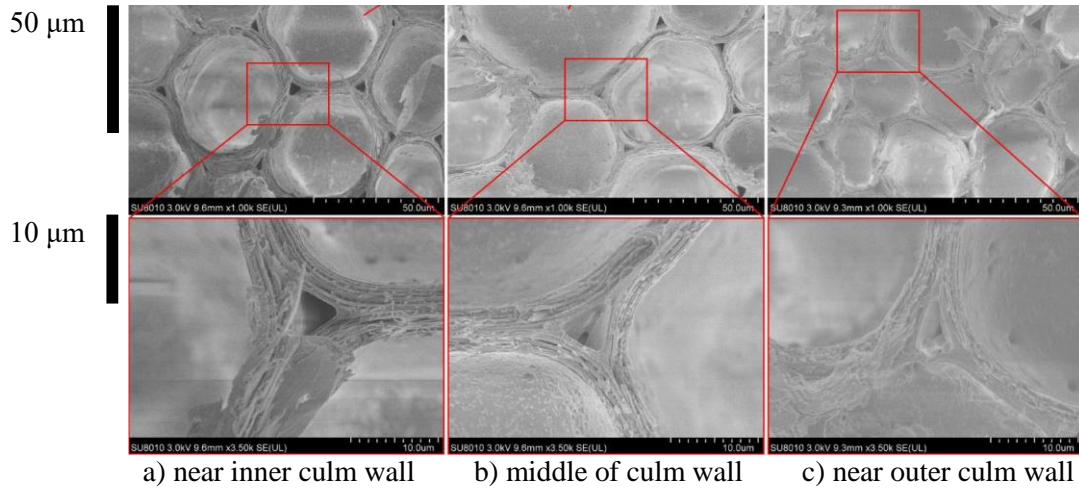

502
503

Figure 11 SEM images of parenchyma cell wall interstices (Zeng et al. 2019)