



*Citation for published version:*

Hammond, JL, Formisano, N, Estrela, P, Carrara, S & Tkac, J 2016, 'Electrochemical biosensors and nanobiosensors', *Essays in Biochemistry*, vol. 60, no. 1, pp. 69-80. <https://doi.org/10.1042/EBC20150008>

*DOI:*

[10.1042/EBC20150008](https://doi.org/10.1042/EBC20150008)

*Publication date:*

2016

*Document Version*

Peer reviewed version

[Link to publication](#)

**University of Bath**

**Alternative formats**

If you require this document in an alternative format, please contact:  
[openaccess@bath.ac.uk](mailto:openaccess@bath.ac.uk)

**General rights**

Copyright and moral rights for the publications made accessible in the public portal are retained by the authors and/or other copyright owners and it is a condition of accessing publications that users recognise and abide by the legal requirements associated with these rights.

**Take down policy**

If you believe that this document breaches copyright please contact us providing details, and we will remove access to the work immediately and investigate your claim.

# Electrochemical biosensors and nanobiosensors

**Jules L. Hammond<sup>1</sup>, Nello Formisano<sup>1</sup>, Pedro Estrela<sup>1,\*</sup>,  
Sandro Carrara<sup>2</sup> and Jan Tkac<sup>3</sup>**

<sup>1</sup> *Department of Electronic and Electrical Engineering, University of Bath, Bath BA2 7AY, UK*

<sup>2</sup> *Integrated Systems Laboratory, École Polytechnique Fédérale de Lausanne, 1015 Lausanne, Switzerland*

<sup>3</sup> *Institute of Chemistry, Slovak Academy of Sciences, Dubravská cesta 9, 845 38 Bratislava, Slovakia*

## **Abstract**

Electrochemical techniques have great promise for low-cost, miniaturised, easy-to-use, portable devices for a wide range of applications – in particular medical diagnosis and environmental monitoring. Different techniques can be used for biosensing, with amperometric devices taking the central role due to their widespread application in glucose monitoring. In fact, glucose biosensing takes a share of around 70% of the biosensor market due to the need for diabetic patients to monitor their sugar levels several times a day, making it an appealing commercial market.

In this chapter we present the basic principles of electrochemical biosensor devices. A description of the different generations of glucose sensors is used to describe in some detail the operation of amperometric sensors and how the introduction of mediators can enhance the performance of the sensors. Electrochemical impedance spectroscopy is a technique being increasingly used in devices due to its ability to detect variations in resistance and capacitance upon binding events. Novel advances in electrochemical sensors due to the use of nanomaterials such as carbon nanotubes and graphene are presented as well as future directions that the field is taking.

**Keywords:** biosensor, electrochemistry, amperometric biosensor, glucose, electrochemical impedance spectroscopy, chronocoulometry, carbon nanotubes, graphene, reduced graphene oxide.

*\*To whom correspondence should be addressed (email [p.estrela@bath.ac.uk](mailto:p.estrela@bath.ac.uk)).*

## **Introduction**

Electrochemical sensors operate by reacting with the analyte of interest to produce an electrical signal proportional to the analyte concentration. A typical electrochemical sensor consists of a sensing electrode (working electrode) and a reference electrode separated by an electrolyte. For most applications, a 3-electrode system is used with the reference connected to a high input impedance potentiostat and a counter electrode is used to complete the circuit for current flow. A range of electrochemical techniques can be used for biosensing applications, namely potentiometric (measuring variations in open circuit potential, of which biologically sensitive field-effect transistors is a special type and discussed in Chapter 9), amperometric (measuring currents due to reduction or oxidation of electroactive species) and impedimetric sensors (measuring the impedance of the system upon immobilisation of biolayers at the electrode surface). Other electrochemical techniques can be used for biosensing, although their application is not as important.

One of the key advantages of electrochemical biosensors relies on their relative simplicity. Inexpensive electrodes can be easily integrated with simple electronics to perform rapid measurements in miniaturised, easy-to-use, portable systems. The ability to determine the concentration of an analyte within a complex sample at the point of care and in near real-time is extremely attractive for medical diagnosis, monitoring of existing conditions and environmental monitoring. Amperometric biosensors in particular have been widely used for the monitoring of glucose levels by people with diabetes, where a test can be made within minutes using a small droplet of blood extracted by pricking a finger with a small needle. The use of nanomaterials such as carbon nanotubes and graphene on electrochemical biosensors is lowering the limits of detection to unparalleled levels, opening the doors to new and exciting biosensing applications.

## **Amperometric Biosensors**

Amperometric biosensors are a class of electrochemical biosensors that transduce the biological recognition events caused by electroactive species at the sensing surface into a current signal for the quantification of analyte within a sample matrix. The intrinsic simplicity of the transducer lends itself to low-cost, portable devices for applications ranging from disease diagnosis to environmental monitoring.

The amperometric transducer is used to study the charge transfer between the interfaces of phases, for example between two electrodes separated by an electrolyte. Often the term *electrochemical cell* is used to describe the system of phases and interfacial boundaries. One of the half-cell reactions within the electrochemical cell is carefully controlled in order to study the changes in charge transfer at the interface of the other half-cell reaction, usually called the working electrode.

By controlling a fixed or varying potential across the electrochemical cell, an overpotential can be formed, which is the difference between the applied potential and the cell equilibrium potential. On formation of the overpotential, electron transfer becomes thermodynamically viable and oxidative or reductive reactions will ensue. These processes are termed *Faradaic* processes as they obey Faraday's law. Other processes (such as the development of an adlayer) that change the interfacial surface but do not cause charge transfer across the interfacial boundary are termed *non-Faradaic* processes.

The Faradaic current  $i$ , is determined by the number of electrons involved in the reaction,  $n$ , the Faraday constant,  $F$ , the electrode area,  $A$ , and the flux of the analyte at the interfacial boundary,  $j$ :  $i = nFAj$ . The flux is of primary concern and describes the rate of the reaction; comprising of the electron transfer heterogeneous rate constant,  $k_0$ , which describes the electron transfer kinetics, and the concentration of analyte at the electrode/electrolyte interface,  $c_0$ , which is dependent on mass transport of analyte to the interface:  $j = k_0c_0$ . It is this dependence on the analyte concentration that allows the current to be correlated to the concentration of analyte within the sample matrix for use in biosensing applications. By sweeping the potential, the oxidation and reduction currents can be measured and these can be correlated to the concentration of electroactive species.

An important point to mention is that the slowest process within the system will become the overall reaction rate-determining process. Awareness of factors that detrimentally affect these processes is important should one wish to devise strategies to mitigate them in order to improve the overall biosensor performance. In general, the factors that influence the reaction rate include:

- concentration of analyte and other species within the matrix *and* at the interfacial boundary;
- mass transport (diffusion, convection and migration) of species from bulk solution to the interfacial boundary;
- electron transfer across the interfacial boundary;

- other chemical reactions occurring within the sample matrix;
- other electrode interactions (adsorption, electrodeposition, etc.);
- external factors (temperature, pressure, etc.).

An abundance of literature covering in these processes in detail are available [1-3]. Different amperometric methods can be used in biosensors: e.g. cyclic voltammetry, differential pulse voltammetry or square wave voltammetry – the latter two tend to be used in most commercial products (glucose being the most common) as they are sensitive only to the Faradaic processes of interest.

### **Glucose – a model system**

A prime example of a commercially successful amperometric biosensor is that of glucose detection for the monitoring of diabetes. First introduced by Clark and Lyons in 1962 [4], the concept has seen significant advances and improvements over the decades [5-7]. Diabetes patients can now accurately self-monitor their blood glucose levels using low-cost, handheld devices with rapid analysis times [8].

Given its prevalence, we shall use glucose detection as a model system to explore some of the different architectures of biorecognition layers that can be employed for the enzymatic amperometric determination of glucose. It is quite common for amperometric biosensors to utilise an enzyme or a sequence of enzymes to catalyse the reaction to improve performance. Glucose detection is no different and the enzyme glucose oxidase (GOx) is often used for its high selectivity to its substrate, high catalytic performance, stability and its low cost [9].

Starting with the simplest architecture, first-generation biosensors (figure 1) rely on measuring the depletion of substrate (S) or yield of product (P) during the reaction, catalysed by an enzyme (E) such as GOx [4,10-11]:

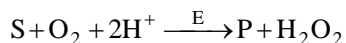

In this example, a major issue with monitoring the oxygen depletion is that the natural concentration of oxygen in samples can fluctuate. Furthermore, the wide potential window required for hydrogen peroxide oxidation and oxygen reduction overlaps with the redox potentials of background interferents.

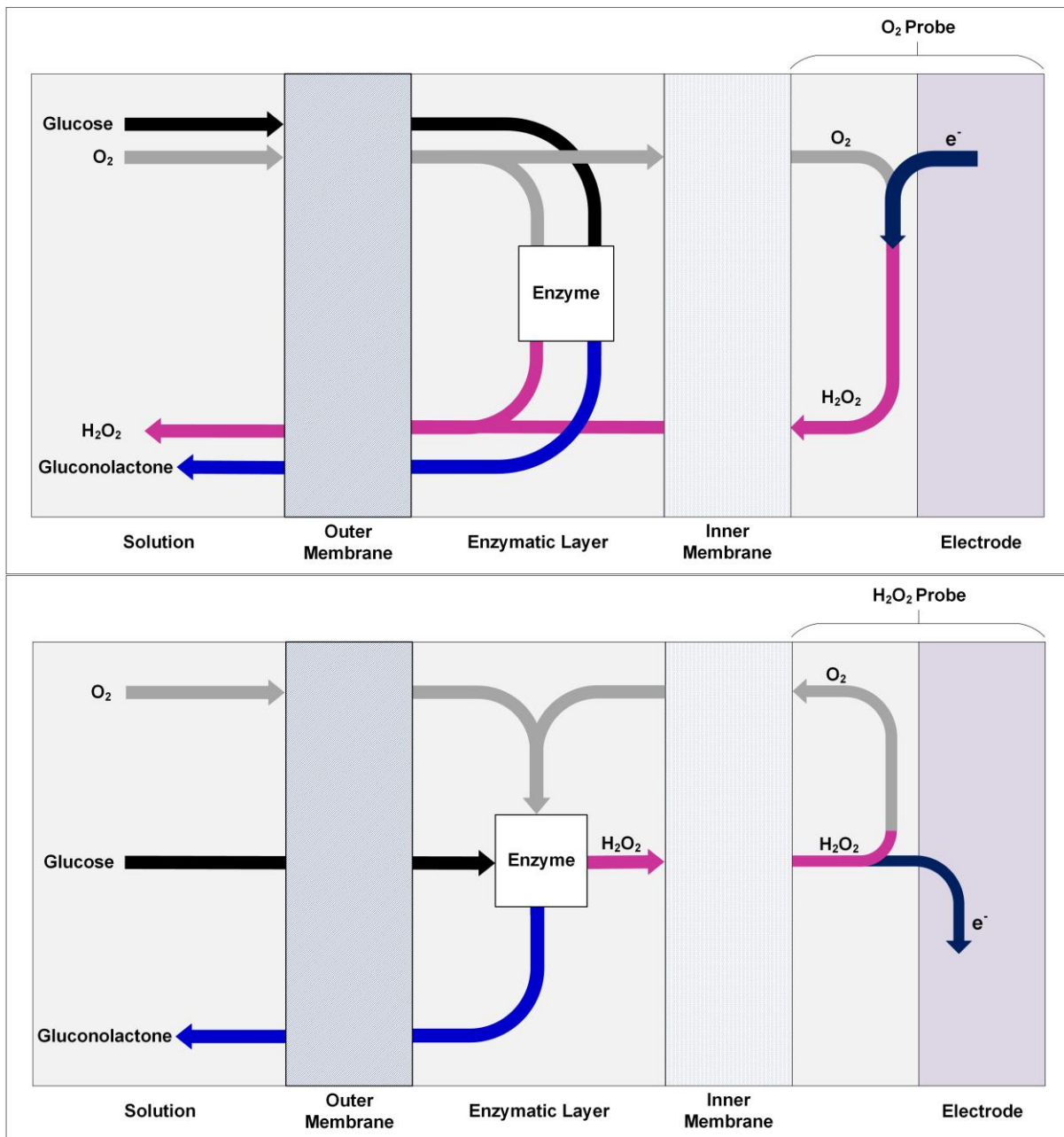

**Figure 1.** Diagrams of oxygen-linked (a) and hydrogen peroxide-linked (b) first-generation amperometric biosensors for glucose detection.

In order to overcome the drawbacks associated with first-generation glucose biosensors, Cass *et al.* [12] demonstrated that a mediator (acting as both a donor and acceptor of electrons to and from the enzyme) could be introduced to improve the electron transfer of the system (figure 2). This also reduces the necessary potential window of the system, minimising effects from interferences thus improving the selectivity.

There are several attributes important to selecting a suitable mediator:

- the electron transfer kinetics of the mediator ( $k_M$ ) should be fast;

- mobility within the sample matrix should be high;
- it must be electrochemically reversible and stable in both reduced and oxidized states;
- it should not be affected by the pH of the sample matrix;
- the redox potential should be similar to that of the cofactor(s) of the enzyme;
- it should not undergo reactions with interferences within the sample matrix.

Mediators may be freely diffusing, such as ferrocene and phenazine derivatives, quinones and ruthenium complexes [13]. Metal oxides may also be incorporated into carbon pastes or inks. Alternatively, functional groups of the mediator may be used to covalently bond to the electrode, enzyme or within a polymer:

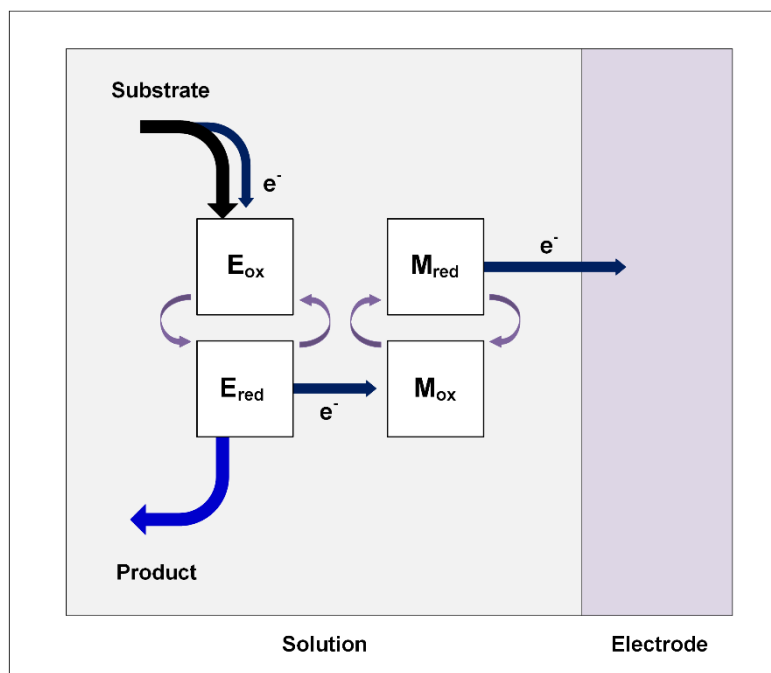
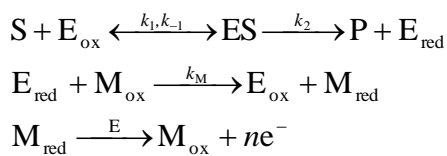

**Figure 2.** Diagrammatic representation of the architecture of a second-generation amperometric biosensor.

In the final architecture, direct electron transfer between the enzyme and electrode is facilitated by immobilising the enzyme at the electrode surface (figure 3) [14-16]. Usually a self-assembled monolayer (SAM) is used to perform this task, allowing controlled spacing

and selection of accessible functional groups, permitting the construction of complex biosensor architectures.

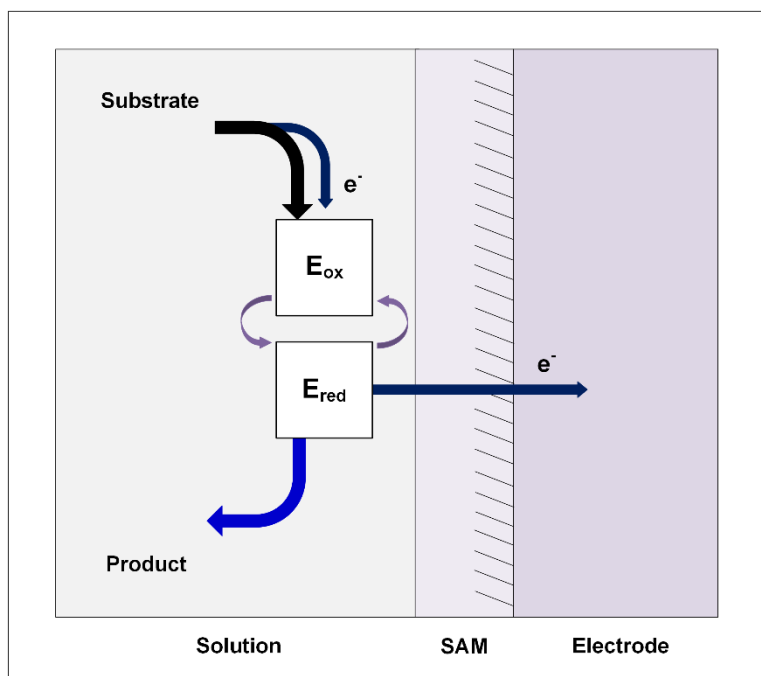

**Figure 3.** Diagrammatic representation of the architecture of a third-generation amperometric biosensor.

In the example of glucose sensing, a conducting polymer, polypyrrole is used extensively for the immobilisation of GOx [17]. Conducting organic salt electrodes [18] have also been shown to be an efficient strategy in third-generation biosensing, particularly for *in vivo* applications where the low toxicity of the system is appealing.

## Impedimetric sensors

The impedance of a generic electrical component is given by dividing the a.c. potential applied across its terminals by the a.c. current that flows through it. The impedance is a complex number and, *in very simplistic terms*, the real part is often linked to resistive processes and the imaginary part to capacitive processes. Electrochemical impedance spectroscopy (EIS) is the most common technique used in impedimetric biosensors, where the impedance is measured over a wide range of a.c. potential frequencies (typically from 100 kHz to 1 mHz). The frequency-domain response from EIS can provide useful



information about the physico-chemical changes that take place when an analyte binds to a bioreceptor immobilised on an electrode. Such information comprises the charge transfer processes from the solution to the electrode surface, solution resistance as well as diffusion transport of species to and from the bulk solution and double layer capacitance formation [19]. Moreover, the analysis of an EIS experiment allows to model the electrochemical double layer with an electrical equivalent circuit, the most used is the so-called Randles circuit (figure 4). The values of the electrical components are extracted from the equivalent electrical model using least square minimisation fitting of the EIS spectrum.

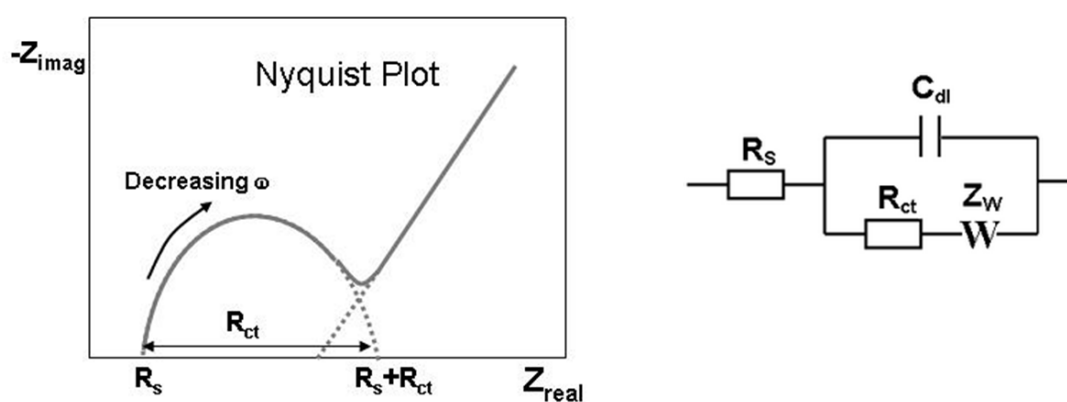

**Figure 4.** EIS Nyquist plot ( $Z_{imag}$  vs  $Z_{real}$ ) and Randles circuit ( $W$  is a so-called Warburg element, which accounts for diffusion processes).

EIS is subdivided in two main categories: Faradaic and non-Faradaic EIS. In the former, redox probes are used in the experiment and the main analysis is focused on charge transfer resistance changes generated by the obstructing presence of the analyte when it binds the surface. The latter exploits charging currents; redox probes are not used and the analysis is mostly based on the double layer capacitance changes upon target binding. In this respect, capacitive sensors such as interdigitated electrodes (IDEs) are gaining particular attention in the last years.

EIS has been intensively studied for many years as a characterization technique, e.g. to confirm the layer-by-layer fabrication processes onto a sensor surface [20]. This could be achieved since standard EIS does not require the addition of any label molecules. Furthermore, as a label-free technique, EIS can monitor the binding affinity in real time. However, the lack of labelling processes caused loss in sensitivity and poor ability to use EIS in real matrixes such as blood. Nonetheless, EIS gained much popularity in recent years and

the above mentioned advantages, along with improved binding strategies and surface optimisation [21-22], allowed EIS to be used for accurate and sensitive biosensing. As a result and the number of EIS applications in biosensing rapidly increased in the last decade, making EIS one of the most promising electrochemical techniques. Recent studies reported on protein detection down to attomolar (aM) concentrations [23]. EIS-based sensors have been reported for countless applications such as detection of cancer and other disease biomarkers, bacteria, polluting agents, water contamination, toxins, etc. [24]. Furthermore, EIS can be integrated in multimodal detection systems for improved confidence levels [25].

## **Chronocoulometric sensors**

Chronocoulometry refers to the measurement of the charge of electroactive species adsorbed onto an electrode with respect to time. One field of investigation where chronocoulometry sensors are widely used is the quantification of nucleotidic molecules. For instance, the negative charge of the phosphate backbone of DNA strands can be quantified measuring the amount of diffusing current originated by a positively charged redox probe, such as  $\text{Ru}(\text{NH}_3)_6^{3+}$ , which is needed to counterbalance the DNA charge [21,26]. Diffusion-limited currents are generated applying controlled potential steps that induce the oxidation of the redox species. In a more general context, chronocoulometry is also used for the determination of diffusion coefficients and for understanding the adsorption kinetics.

## **Carbon-nanotubes-based electrochemical biosensors**

Carbon Nanotubes are formed by one (Single Walled Carbon Nanotubes – SWCNT) or more (Multi Walled Carbon Nanotubes – MWCNT) atom thick sheets made by carbon atoms and organized in tubes (concentric tubes in case of MWCNT) (figure 5). Carbon nanotubes present amazing properties originating from the quantum transport through the crystalline structure of their walls. Table 1 summarizes some of these properties and shows how the electrons travelling inside the tube follows ballistic conductivity: considering that the mean length of a MWCNT is in few  $\mu\text{m}$  maximum, a mean free path of about 25  $\mu\text{m}$  for MWCNT at room temperature means that all the electrons pass through the tube without any interaction with the carbon lattice. Carbon nanotubes have been proposed for a huge plethora of different applications, including but not limited to touch screens [27], solar cells [28], batteries,

supercapacitors and transistors [29], super strong materials for structural composites [30] and to improve biosensors [31-32].

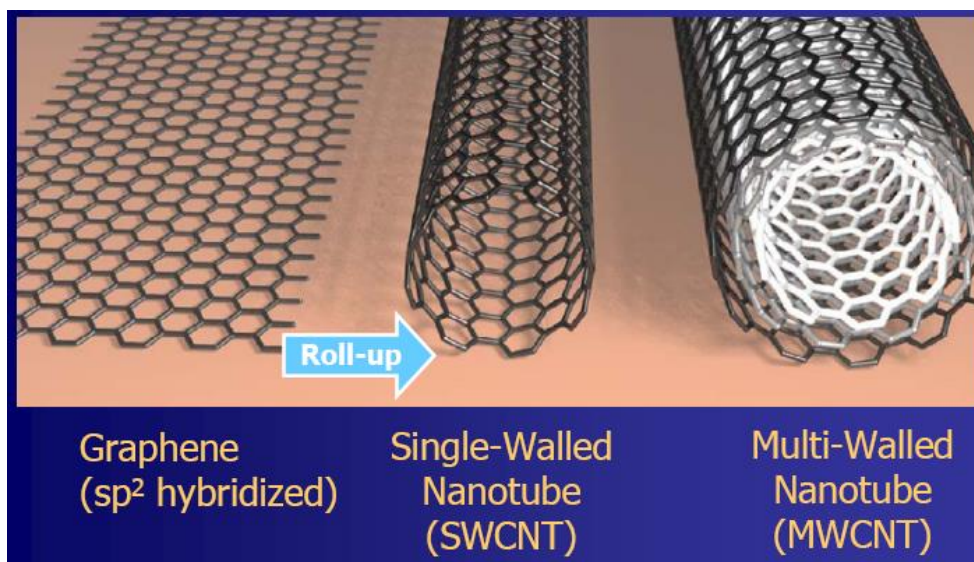

**Figure 5.** A scheme showing as graphene could be ideally rolled-up to form single or multi walled carbon nanotubes (Courtesy: K. Banerjee, California University).

**Table 1.** Some of the transport properties of Carbon Nanotubes (and comparison with Cu).

	Cu	SWCNT	MWCNT
<b>Max current density (A/cm<sup>2</sup>)</b>	< 1×10 <sup>7</sup>	> 1×10 <sup>9</sup>	> 1×10 <sup>9</sup>
<b>Thermal conductivity (W/mK)</b>	385	5800	3000
<b>Mean free path at room temperature (nm)</b>	40	>1000	25000

In biosensing, carbon nanotubes have been largely used since 2000. MWCNTs offer several improving effects on the biosensor features. The easiest to be considered is the increase in electro-active surface area due to nano-structuring of the working electrode. This results in the appearance of thin-layer phenomena [33] that also typically provide a huge increase of the so-called layering effects [31], leading to an increase of the acquired Faradic currents emerging from any redox reaction occurring at the surface of the carbon nanotubes (figure 6). More often, this increase of the peak current is related to a shift of its Nernst potential as observed in many cases, and this shift in potential is extremely useful, in some cases, to avoid interferences with other compounds (e.g, uric and ascorbic acids) when

dealing with monitoring of human fluids [34]. Of course, the provided increase in terms of current collected by redox reactions immediately results in a huge improvements of the two main features of electrochemical biosensors: an increasing of the sensitivity and a related decreasing of the Limit of Detection (LOD).

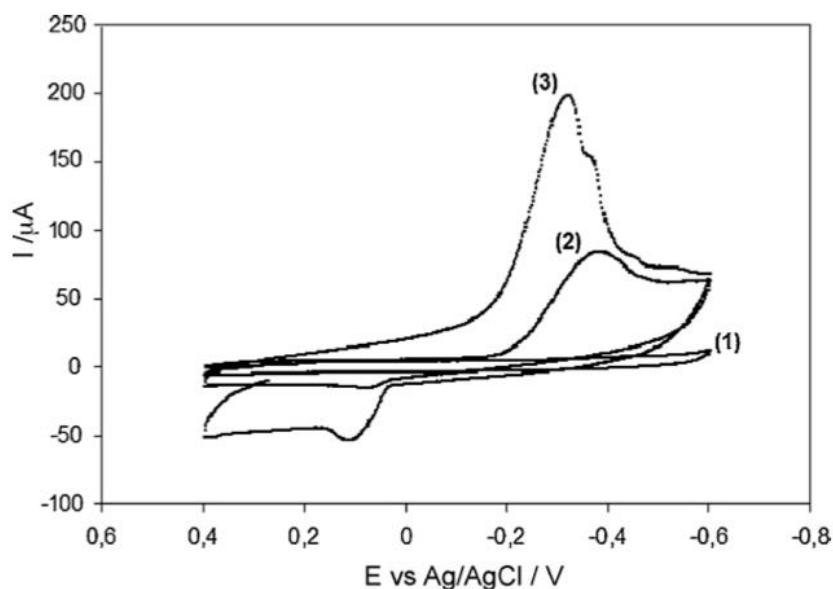

**Figure 6.** Cyclic voltammograms acquired on screen-printed rhodium–graphite electrodes modified with a metalloprotein: standard electrode (1), modified with gold nanoparticles (2), modified with MWCNT (3) (reprinted from [35] with permission from Elsevier).

For all these reasons, MWCNT have been extensively reported to increase biosensor performance toward detection of many endogenous human molecules including but not limited to glucose [32], lactate [36], cholesterol [35], etc. and for exogenous human molecules including but not limited to anti-cancer agents [37], anti-inflammatory compounds [38], etc.

## Graphene-based electrochemical biosensors

Graphene is one atom thick silk-like sheet made of ordinary carbon with exceptional properties originating from quantum physics with use of graphene in a diverse range of fields including touch screens, solar cells, (bio)batteries, transistors, super strong materials applied in construction of planes, cars, satellites and for construction of biosensors [39]. Graphene properties were for the first time studied in 2004 by Geim and Novoselov [40] and in 2010

both received the Nobel Prize in Physics for this discovery. Their approach for obtaining graphene flakes is quite interesting – they used graphite, which is found in ordinary pencil, and by peeling off layer by layer of carbon flakes using a Scotch tape finally they ended up with one atom thin layer of carbon. This was done at a time when it was believed that such thin flake cannot be stable.

Highly pure graphene sheets needed for special applications prepared by mechanical cleavage or by chemical deposition techniques are quite expensive. A cost effective way for producing graphene materials is to start with “graphite oxide” prepared by oxidation of graphite with strong mineral acids with subsequent exfoliation of graphene oxide flakes (GO, figure 7). GO having a high density of oxygen-containing functional groups is not very conductive due to disrupted conjugated  $\pi$ - $\pi$  bonds, and conductivity can be restored by reduction, performed either chemically, thermally, or electrochemically and such material is termed reduced graphene oxide (RGO). While graphene sheets by definition should not contain any oxygen, its total amount can reach up to 30% in GO and by reduction, oxygen amount is decreased approximately to 5-10% in RGO [41]. This set of features allowed the development of electrode interfaces capable of hosting high amounts of bioreceptors enhancing sensitivity of the biosensor devices. Lower conductivity of GO compared to graphene can be applied in devices based on impedimetric or field-effect sensing transducing schemes. Carboxyl and other oxygen-containing moieties of GO or RGO can be also used for covalent attachment of biorecognition molecules either to modify biosensor surface or to prepare graphene-based bioconjugates for sandwich assay formats.

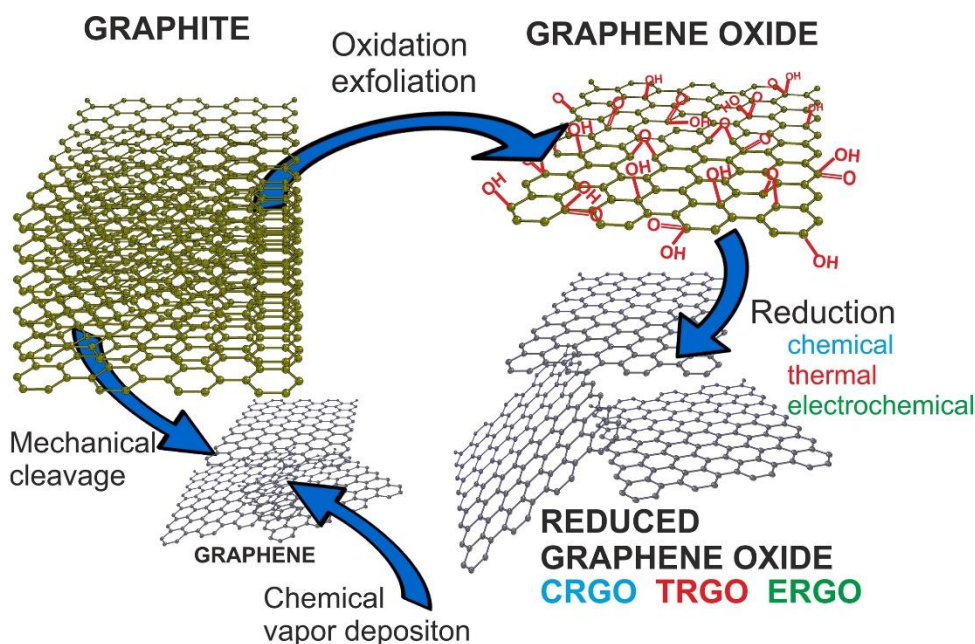

**Figure 7.** A scheme showing various ways graphene and graphene-based material can be prepared. CRGO – chemically reduced graphene oxide, TRGO – thermally reduced graphene oxide, ERGO – electrochemically reduced graphene oxide (Reprinted from [42] with permission from Elsevier).

Graphene has been applied to a wide range of biosensors and, in particular for affinity-based biosensors (i.e. immunosensors or DNA sensors) for analysis of high-molecular weight analytes, such as DNA or proteins. For example an electrode modified by RGO could detect DNA down to 5 fM, while an electrode modified by vertically aligned nanowalls from RGO with a favourable orientation of RGO towards oxidation of DNA bases could detect the same analyte down to 9 zM (~5 DNA molecules in 1 mL) [43]. Antibodies and DNA aptamers-based sensors have also been achieved with LODs in the order of aM.

Graphene-based materials with high surface area and numerous functionalities allow immobilising antibodies and enzymes, which can dramatically enhance electrochemical readout by signal amplification. Since GO or RGO is much cheaper compared to other nanomaterials such strategy can result in cost-effective preparation of an ultrasensitive affinity-based electrochemical biosensors [41].

## Conclusions

Continued work with the plethora of new materials such as boron doped diamond (BDD) [44], that offer improvements in solvent and potential ranges, reduced background currents

and antifouling properties, will open up new branches of research within electrochemistry. Further development of nanomaterials and the optimisation of fabrication processes should yield improvements in sensitivity and selectivity and the utilisation of other quantum effects [45]. Coupling these systems with micro- and nanofluidics for sample preparation, processing and introduction will make them more attractive for use in biosensing where reduced sample volumes are desired [46]. As these fields of nanotechnology mature, relatively new techniques such as redox cycling in nanogaps [47] and nano-impact detection [48] may become more established.

The push from industry has seen the cost of microelectronics reach the point where smartphones are now ubiquitous within our culture. These devices offer exciting opportunities to exploit the powerful processing capabilities to be used in conjunction with low-cost point-of-care biosensors.

Although screen-printed electrodes have already been widely adopted in mass production for low-cost disposable biosensing, further research on surface modification, incorporation of biomaterials and elaborate geometries will likely see their applications broaden. With the appropriate validation, the increasing affordability of computing performance has improved the popularity of computational modelling as a tool to increase understanding of the biosensor mechanisms and streamlined optimisation of biosensor design.

The main advantages of application of nanomaterial-modified electrodes for construction of biosensors compared to planar electrodes can be summarised as follows:

- higher surface area allowing to immobilise larger density of biomolecules [49];
- better accessibility (lower diffusion limitations) of analyte molecules to reach immobilised biomolecules [23];
- direct electronic wiring of redox enzymes allowing direct electron transfer between the modified electrode and active site of the enzyme making such enzymatic biosensors more selective [50];
- enhanced catalytic action towards enzymatic by-products (hydrogen peroxide and reduced nicotinamide adenine dinucleotide being an enzyme cofactor) represented by higher current density and/or analysis at lower overpotential [49,51];
- application of nanomaterials for enhanced loading of secondary biorecognition elements to make a sandwich configuration [41].

The main application niche for electrochemical biosensors is in analysis of low-molecular weight analytes indicating physiological status of the body such as glucose, lactate and cholesterol using enzymes (redox enzymes and hydrolases) [52] or high-molecular weight analytes such as nucleic acids using DNA/RNA biosensors or detection of various proteins. DNA/RNA biosensors could be applied for analysis of various cancer genes (i.e. bBRCA1, breast cancer gene 1), mRNA (messenger RNA) for expression of various proteins (i.e. p53, a tumour suppression protein) and microRNAs, which are post-transcriptional regulators of gene expression [53]. The main protein analytes detected by biosensors are biomarkers of various diseases such as troponin (cardiac disease), glycosylated haemoglobin (diabetes) and various glycoproteins being cancer biomarkers such as a prostate specific antigen [54].

## Summary

- Electrochemical biosensors are some of the most used biosensors in the market, mainly due to glucose monitoring
- Electrochemical biosensors are easily miniaturised, inherently inexpensive and require simple electronics for conditioning and readout, making them ideal for point-of-care applications
- Amperometric biosensors measure currents due to electroactive species, often using mediators to enhance electron transfer
- Electrochemical impedance spectroscopy-based biosensors are some of the most promising electrochemical sensors for systems with well-defined charges such as DNA
- Electrochemical nanobiosensors with extremely low limits of detection are nowadays being developed thanks to the extraordinary properties of nanomaterials such as carbon nanotubes and graphene

## Acknowledgements

The authors acknowledge support from the European Commission FP7 Programme through the Marie Curie Initial Training Network PROSENSE (Grant No. 317420, 2012–2016). J.L.H. is funded through an EPSRC (UK) Doctoral Training Award.



## References

- [1] A.J. Bard, L.R. Faulkner (1980). *Electrochemical Methods: Fundamentals and Applications*. Chichester: Wiley.
- [2] A.C. Fisher (1996). *Electrode Dynamics*. Oxford: Oxford University Press.
- [3] J. Wang (2006). *Analytical Electrochemistry*. John Wiley & Sons.
- [4] L.C. Clark, C. Lyons (1962). Electrode systems for continuous monitoring in cardiovascular surgery. *Annals of the New York Academy of Sciences*, **102**, 29–45.
- [5] J. Wang (2001). Glucose biosensors: 40 years of advances and challenges. *Electroanalysis*, **13** (12), 983–988.
- [6] J. Wang (2008). Electrochemical glucose biosensors. *Chemical Reviews*, **108** (2), 814–825.
- [7] A. Heller, B. Feldman (2010). Electrochemistry in diabetes management. *Accounts of Chemical Research*, **43** (7), 963–973.
- [8] J.D. Newman, A.P.F. Turner (2005). Home blood glucose biosensors: a commercial perspective. *Biosensors & Bioelectronics*, **20** (12), 2435–2453.
- [9] S.B. Bankar, M.V. Bule, R.S. Singhal, L. Ananthanarayan (2009). Glucose oxidase – an overview. *Biotechnology Advances*, **27** (4), 489–501.
- [10] G.G. Guilbault, G.J. Lubrano (1973). Enzyme electrode for amperometric determination of glucose. *Analytica Chimica Acta*, **64** (3), 439–455.
- [11] Y. Shimizu, K. Morita (1990). Microhole array electrode as a glucose sensor. *Analytical Chemistry*, **62** (14), 1498–1501.
- [12] A.G. Cass, G. Davis, G.D. Francis, H.A.O. Hill, W.J. Aston, I.J. Higgins, E.V. Plotkin, L.D.L. Scott, A.P.F. Turner (1984). Ferrocene-mediated enzyme electrode for amperometric determination of glucose. *Analytical Chemistry*, **56** (4), 667–671.
- [13] M.L. Fultz, R.A. Durst (1982). Mediator compounds for the electrochemical study of biological redox systems: a compilation. *Analytica Chimica Acta*, **140** (1), 1–18.

- [14] A.L. Ghindilis, P. Atanasov, E. Wilkins (1997). Enzyme-catalyzed direct electron transfer: fundamentals and analytical applications. *Electroanalysis*, **9** (9), 661–674.
- [15] C. Léger, P. Bertrand (2008). Direct electrochemistry of redox enzymes as a tool for mechanistic studies. *Chemical Reviews*, **108** (7), 2379–2438.
- [16] V. Polohova, M. Snejdarkova (2008). Electron transfer in amperometric biosensors. *Chemické Listy*, **102** (3), 173–182.
- [17] M. Singh, P.K. Kathuroju, N. Jampana (2009). Polypyrrole based amperometric glucose biosensors. *Sensors and Actuators B*, **143** (1), 430-443
- [18] R. Pauliukaite, A. Malinauskas, G. Zhylyak, U.E. Spichiger-Keller (2007). Conductive organic complex salt TTF-TCNQ as a mediator for biosensors: an overview. *Electroanalysis* **19** (24), 2491–2498.
- [19] E. Barsoukov, J.R. Macdonald, eds. (2005). Impedance Spectroscopy: Theory, Experiment, and Applications. John Wiley & Sons.
- [20] N. Jaffrezic-Renault (2013). Label-free affinity biosensors based on electrochemical impedance spectroscopy. In *Microelectrode Biosensors* (S. Marinesco, N. Dale, eds.), Springer, pp. 295-318.
- [21] S.D. Keighley, P. Li, P. Estrela, P. Migliorato (2008). Optimization of DNA immobilization on gold electrodes for label-free detection by electrochemical impedance spectroscopy. *Biosensors and Bioelectronics*, **23**, 1291-1297.
- [22] P. Jolly, N. Formisano, J. Tkáč, P. Kasák, C.G. Frost, P. Estrela (2015). Label-free impedimetric aptasensor with antifouling surface chemistry: a prostate specific antigen case study. *Sensors and Actuators B*, **209**, 306-312.
- [23] T. Bertok, A. Sediva, J. Katrlík, P. Gemeiner, M. Mikula, M. Nosko, J. Tkac (2013). Label-free detection of glycoproteins by the lectin biosensor down to attomolar level using gold nanoparticles. *Talanta*, **108**, 11-18.
- [24] E.P. Randviir, C.E. Banks (2013). Electrochemical impedance spectroscopy: an overview of bioanalytical applications. *Analytical Methods*, **5**, 1098-1115.
- [25] N. Formisano, N. Bhalla, L.C.C. Wong, M. Di Lorenzo, G. Pula, P. Estrela (2015). Multimodal electrochemical and nanoplasmonic biosensors using ferrocene crowned

nanoparticles for kinase drug discovery applications. *Electrochemistry Communications*, **57**, 70-73.

[26] A.B. Steel, T.M. Herne, M.J. Tarlov (1998). Electrochemical quantitation of DNA immobilized on gold. *Analytical Chemistry*, **70** (22), 4670-4677.

[27] D.S. Hecht, D. Thomas, L. Hu, C. Ladous, T. Lam, Y. Park, G. Irvin, P. Drzaic (2009). Carbon-nanotube film on plastic as transparent electrode for resistive touch screens. *Journal of the Society for Information Display*, **17** (11), 941-946.

[28] M.W. Rowell, M.A. Topinka, M.D. McGehee, H.J. Prall, G. Dennler, N.S. Sariciftci, L. Hu, G. Gruner (2006). Organic solar cells with carbon nanotube network electrodes. *Applied Physics Letters*, **88**, 233506.

[29] R.H. Baughman, A.A. Zakhidov, W.A. de Heer (2002). Carbon nanotubes – the route toward applications. *Science*, **297**, 787-792.

[30] P. Calvert (1999). Nanotube composites: a recipe for strength. *Nature*, **399**, 210-211.

[31] S. Carrara, V. Bavastrello, D. Ricci, E. Stura, C. Nicolini (2005). Improved nanocomposite materials for biosensor applications investigated by electrochemical impedance spectroscopy. *Sensors and Actuators B*, **109** (2), 221-226.

[32] A. Guiseppi-Elie, C. Lei, R.H. Baughman (2002). Direct electron transfer of glucose oxidase on carbon nanotubes. *Nanotechnology*, **13** (5), 559.

[33] I. Streeter, G.G. Wildgoose, L. Shao, R.G. Compton, Cyclic voltammetry on electrode surfaces covered with porous layers: an analysis of electron transfer kinetics at single-walled carbon nanotube modified electrodes. *Sensors and Actuators B*, **133** (2), 462-466.

[34] I. Taurino, A. Magrez, F. Matteini, A. Cavallini, L. Forró, G. De Micheli, S. Carrara (2014). High performance multi-panel biosensors based on a selective integration of nanographite petals. *Nano Letters*, **14** (6), 3180-3184.

[35] S. Carrara, V.V. Shumyantseva, A.I. Archakov, B. Samorì (2008). Screen-printed electrodes based on carbon nanotubes and cytochrome P450<sub>scc</sub> for highly sensitive cholesterol biosensors. *Biosensors and Bioelectronics*, **24** (1), 148-150.

[36] J. Weber, A. Kumar, A. Kumar, S. Bhansali (2006). Novel lactate and pH biosensor for skin and sweat analysis based on single walled carbon nanotubes. *Sensors and Actuators B*, **117** (1), 308-313.

- [37] C. Baj-Rossi, G. De Micheli, S. Carrara (2012). Electrochemical detection of anti-breast-cancer agents in human serum by cytochrome P450-coated carbon nanotubes. *Sensors*, **12**, 6520-6537.
- [38] C. Baj-Rossi, T. Rezzonico Jost, A. Cavallini, F. Grassi, G. De Micheli, S. Carrara (2014). Continuous monitoring of Naproxen by a cytochrome P450-based electrochemical sensor. *Biosensors and Bioelectronics*, **53**, 283-287.
- [39] Graphene applications: Focus issue. *Nature Nanotechnology*, **9** (10), 725-868.
- [40] K.S. Novoselov, A.K. Geim, S.V. Morozov, D. Jiang, Y. Zhang, S.V. Dubonos, I.V. Grigorieva, A.A. Firsov (2004). Electric field effect in atomically thin carbon films. *Science*, **306**, 666-669.
- [41] J. Filip, P. Kasák, J. Tkac (2015). Graphene as signal amplifier for preparation of ultrasensitive electrochemical biosensors. *Chemical Papers*, **69**, 112-133.
- [42] J. Filip, J. Tkac (2014). Is graphene worth using in biofuel cells? *Electrochimica Acta*, **136**, 340-354.
- [43] O. Akhavan, E. Ghaderi, R. Rahighi (2012). Toward single-DNA electrochemical biosensing by graphene nanowalls. *ACS Nano*, **6** (4), 2904-2916.
- [44] J.V. Macpherson (2015). A practical guide to using boron doped diamond in electrochemical research. *Physical Chemistry Chemical Physics*, **17** (5), 2935-2949.
- [45] X.Q. Zhang, Q. Guo, D.X. Cui (2009). Recent advances in nanotechnology applied to biosensors. *Sensors*, **9** (2), 1033-1053.
- [46] S. Kumar, S. Kumar, M.A. Ali, P. Anand, V.V. Agrawal, R. John, S. Maji, B.D. Malhotra (2013). Microfluidic-integrated biosensors: prospects for point-of-care diagnostics. *Biotechnology Journal*, **8** (11), 1267-1279.
- [47] S.E.C. Dale, F. Marken (2013). Electrochemistry within nanogaps. *Electrochemistry*, **12**, 132-154.
- [48] E. Kätelhön, R.G. Compton (2015). Understanding nano-impacts: binary nature of charge transfer during mediated reactions. *ChemElectroChem*, **2** (1), 64-67.
- [49] S. Carrara, C. Baj-Rossi, C. Boero, G. De Micheli (2014). Do carbon nanotubes contribute to electrochemical biosensing? *Electrochimica Acta*, **128**, 102-112.

- [50] Y. Xiao, F. Patolsky, E. Katz, J.F. Hainfeld, I. Willner (2003). Plugging into enzymes: Nanowiring of redox enzymes by a gold nanoparticle. *Science*, **299**, 1877-1881.
- [51] J. Filip, J. Sefcovicova, P. Tomcik, P. Gemeiner, J. Tkac (2011). A hyaluronic acid dispersed carbon nanotube electrode used for a mediatorless NADH sensing and biosensing. *Talanta*, **84** (2), 355-361.
- [52] S. Carrara, C. Boero, G. De Micheli (2009). Quantum dots and wires to improve enzymes-based electrochemical bio-sensing. In *Nano-Net* (A. Schmid, S. Goel, W. Wang, V. Beiu, S. Carrara, eds.), pp. 189-199, Springer Berlin Heidelberg.
- [53] E. Palecek, M. Bartosik (2012). Electrochemistry of nucleic acids. *Chemical Reviews*, **112** (6), 3427-3481.
- [54] E. Palecek, J. Tkac, M. Bartosik, T. Bertok, V. Ostatna, J. Palecek (2015). Electrochemistry of nonconjugated proteins and glycoproteins: Toward sensors for biomedicine and glycomics. *Chemical Reviews*, **115** (5), 2045-2108.

## Authors' biographies

**Jules Hammond** is a PhD student at the University of Bath, under the supervision of Dr. Pedro Estrela and Prof. Frank Marken. He previously completed his MEng (Hons) degree in Electronic & Electrical Engineering at the University of Bath. His research interests include electrochemical biosensing, developing portable biosensors, nanofabrication, and finite element analysis.

**Nello Formisano** is in his final year of PhD in the biosensors group of Dr. Pedro Estrela at the University of Bath (UK). Nello's research focuses on impedimetric-based techniques. He received his master and bachelor degrees at the Università degli Studi di Napoli "Federico II" in Naples, Italy. Before joining Dr Estrela's group he received a fellowship funded by the Istituto Superiore di Sanità (Italy) for carrying out research at the Center for Applied Proteomics and Molecular Medicine of the George Mason University (Virginia, USA) co-directed by Prof. Dr. Lance A. Liotta and Prof. Dr. Emanuel Petricoin III.

**Pedro Estrela** is an Associate Professor in Advanced Sensor Technologies at the University of Bath. He has a first degree and Masters in Physics from the University of Lisbon and a PhD in Physics from the University of Amsterdam. His research interests include label-free electrical detection of biomolecular interactions, biologically sensitive field-effect devices, electrochemical impedance spectroscopy of biological systems, surface biofunctionalization, electronic microarrays, and nanobiosensors. He is the Coordinator of the Marie Curie Initial Training Network "Cancer Diagnosis: Parallel Sensing of Prostate Cancer Biomarkers" (PROSENSE).

**Sandro Carrara** is faculty at EPFL in Lausanne (Switzerland). He is former professor at Genoa and Bologna Universities. He is founder and Editor-in-Chief of the journal BioNanoScience by Springer, Topical Editor of the IEEE Sensors Journal, and Associate Editor of IEEE Transactions on Biomedical Circuits and Systems. He is member of the BoG of the IEEE CAS Society and Sensors Council. He has been appointed as CASS Distinguished Lecturer for years 2013-14. He has more than 200 publications and 12 patents, including several Top-25-Hottest-Articles and Best Awarded papers. He has been the General Chairman of the Conference IEEE BioCAS 2014

**Ján Tkáč** received his Ph.D. degree (2000) from Slovak University of Technology in Bratislava, Slovakia, and D.Sc. degree (2011) from Slovak Academy of Sciences (SAS) in Bratislava, Slovakia. He did postdoctoral stays at Linköping University, Sweden (2001–2003), Lund University, Sweden (2003–2006), and Oxford University, UK (2006–2008). Currently, he is a Head of Department of Glycobiotechnology at the Institute of Chemistry, SAS in Bratislava, Slovakia. His research activities cover nanoscale surface patterning protocols, electrochemical biosensors, glycan and lectin biochips/biosensors. He was the recipient of an Individual Marie-Curie Fellowship (2003–2006), and currently he is the holder of an ERC Starting Grant (2013–2017).

- 1 Carrara, S., Baj-Rossi, C., Boero, C. and De Micheli, G. (2014) Do carbon nanotubes contribute to electrochemical biosensing? *Electrochimica Acta* **128**, 102-112
- 2 Xiao, Y., Patolsky, F., Katz, E., Hainfeld, J. F. and Willner, I. (2003) "Plugging into enzymes": Nanowiring of redox enzymes by a gold nanoparticle. *Science* **299**, 1877-1881
- 3 Filip, J., Sefcovicova, J., Tomcik, P., Gemeiner, P. and Tkac, J. (2011) A hyaluronic acid dispersed carbon nanotube electrode used for a mediatorless NADH sensing and biosensing. *Talanta* **84**, 355-361
- 4 Carrara, S., Boero, C. and De Micheli, G. (2009) Quantum dots and wires to improve enzymes-based electrochemical bio-sensing. In *Nano-Net* (Schmid, A., Goel, S., Wang, W., Beiu, V. and Carrara, S., eds.). pp. 189-199, Springer Berlin Heidelberg
- 5 Palecek, E. and Bartosik, M. (2012) Electrochemistry of nucleic acids. *Chemical Reviews* **112**, 3427-3481
- 6 Palecek, E., Tkac, J., Bartosik, M., Bertok, T., Ostatna, V. and Palecek, J. (2015) Electrochemistry of nonconjugated proteins and glycoproteins. Toward sensors for biomedicine and glycomics. *Chemical Reviews* **115**, 2045-2108