

Cordless Printed Circuit Board Transformers for Power Transfer in Neuroprosthesis

T.M.Fung¹, K.W.E.Cheng¹, K.Y.Tong², A.B.Rad¹

Department of Electrical Engineering¹, Department of HTI², The Hong Kong Polytechnic University

Abstract- This paper describes some methods to improve the efficiency of power transfer in neuroprosthesis. In the neuroprosthesis, there is a low power level DC to DC converter in which the size is very small for the power conversion. The reduction of size of the converter uses the technique of cordless printed circuit board transformers that allows the contactless power transfer through the skin. In such, the coupling of the primary and secondary transformers is only skin and air gap. Meanwhile, the magnetizing inductance, leakage inductance and some other parameters affects the efficiency of the power transfer. The paper will discuss the relationship of those parameters and some suggestions for improvement of the overall performance of the converter.

I. INTRODUCTION-

The normal nerve system transmit signal from brain to the other parts of the body in order to control the body movement. Unfortunately, some of the patients suffer from diseases which disturb or damage the path of the nerve signals to parts of the body. In such case, artificial signal paths are needed. Those paths provide a good connection of the nerve system. With the need for improvement of technology in medicine, the system is outside the body, whereas only with the sensors are implanted under the skin. The implanted sensors needed power to operate. There are many researches on this type of power transfer device. As in the case study before, the maximum power consumption is 50 milliwatt[1] used for the system. It is necessary to study the factors which will affect the transfer efficiency in which they will be discussed in this paper.

II. METHODOLOGY

In the traditional transformer, the energy transfer from primary to secondary windings through a magnetic path (a ferrite). Although the leakage is very small, the efficiency is only about 50%-70%. However, it is not possible to implant the transformer with core under the skin. Thus there is a new transformer—cordless printed circuit board transformer invented [2]-[8].

The cordless printed circuit board (cordless PCB as shorted) is that the copper wire is absent and the winding is printed on the PCB (Fig.1). It is possible to implant the thin PCB winding inside the skin to receive energy or data from or to the body.

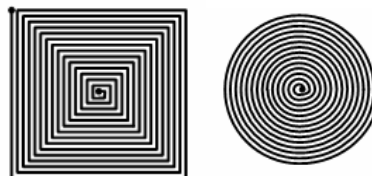

Fig.1 the cordless PCB

In the absence of the magnetic core between the primary and secondary winding, the leakage inductance is significantly high and the magnetizing inductance is relatively low. Thus the efficiency is quite low.

To cope with these problems, there are two methods used to improve the efficiency of energy transfer.

1. Resonance effect is produced within the inductor (winding) and an added capacitors.

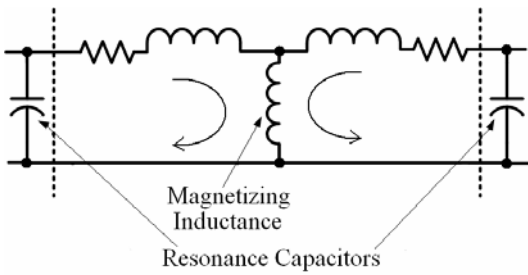

Fig.2 Parallel winding with resonant capacitors

2. Instead of a single winding, a Parallel (Fig.3) or “Matrix” (Fig.4) winding is proposed.



Fig.3 Parallel Winding

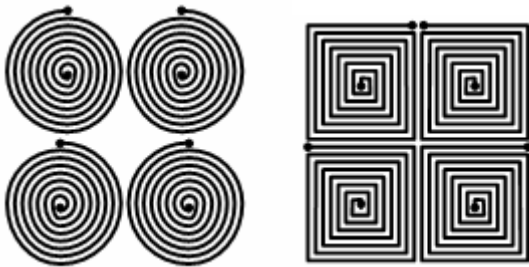

Fig.4 “Matrix” Winding

III. EXPERIMENTAL RESULTS

There are many types of converter used in DC to DC power supply. In this paper, the flyback converter is chosen. Meanwhile, two improved topologies are two-transistor flyback converter and paralleling flying converter.

Two-transistor flyback converter (Fig.4) is mainly used in low voltage output. Moreover, switching device used in such topology is only half voltage needed than those used of single transistor. As low power (in the range of milliwatt) will damage the human being or animals, it is suitable for the usage of this paper.

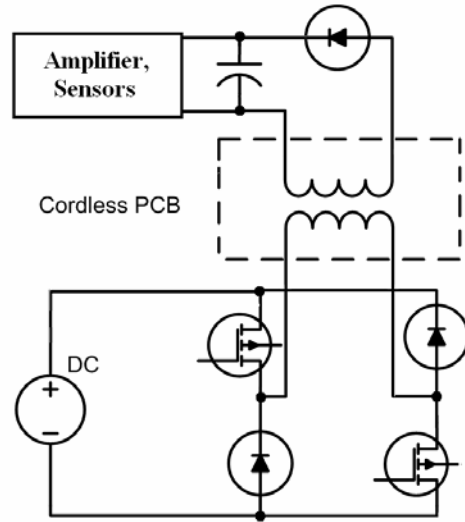

Fig. 5 Two-switching device flyback converter

Paralleling flyback converter is used in high power level. Even though, its advantages are (1) improved the system reliability, (2) higher the switching frequency, lesser current pulsation will be obtained. This is not used in this paper.

There are many shapes for the cordless transformer. The traditional one is the circular. However, there are some region is not fully occupied, thus the single square winding is used instead of a single circular winding. The magnetizing inductance verse the operating frequency is shown in Figs.6 to 8 and the equation is

$$L_m = 3E-06f^3 - 0.0004f^2 - 0.0067f + 5.4447.$$

And the leakage inductance verse operating frequency is shown in Fig.9 to 11 and the equation is

$$L_l = -3E-08f^3 + 9E-06f^2 - 0.0026f + 1.5048.$$

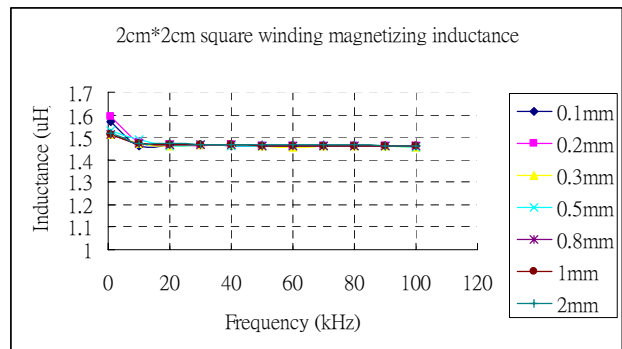

Fig.6. 2cm*2cm Square Winding

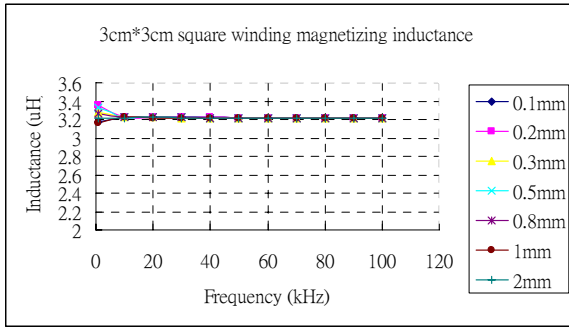

Fig. 7 3cm*3cm Square Winding

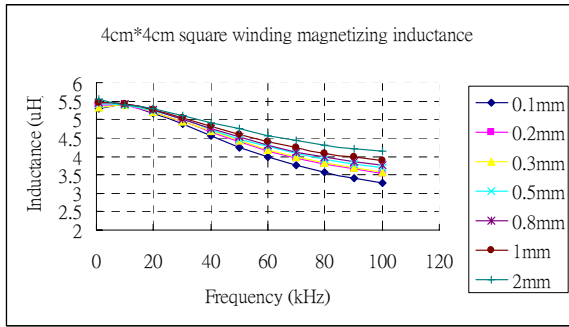

Fig. 8 4cm*4cm Square Winding

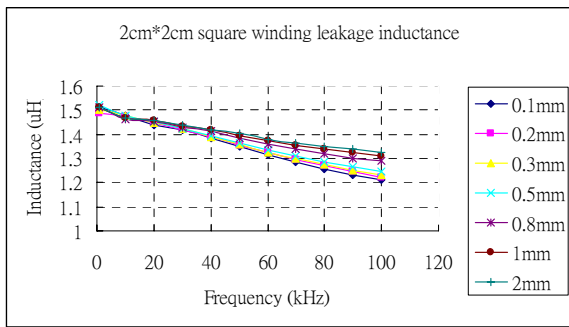

Fig. 9 2cm*2cm Square Winding

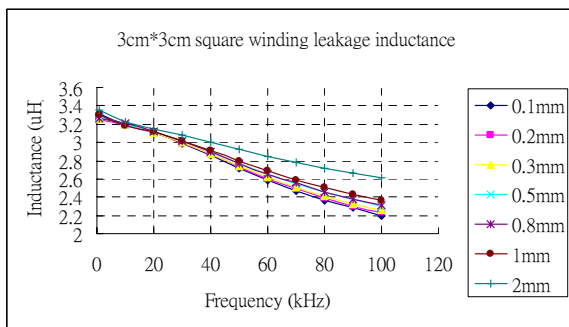

Fig. 10 3cm*3cm Square Winding

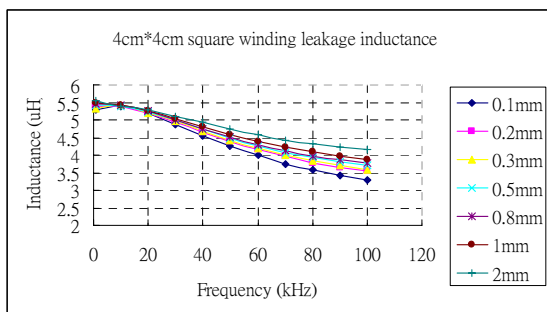

Fig. 11 4cm*4cm Square Winding

It is interesting to find that the magnetizing inductance does not vary extensively when frequency is higher than 20kHz for size 3*3 and 2*2 cm². In all the cases, the leakage inductance decreases with frequency. It is also found that the leakage inductance is only very slightly different from the magnetizing. It is therefore found that the coupling between the primary and secondary is very poor and only at high frequency of operation, the coupling is improved. This is clearly seen for 3*3 and 2*2 cm² windings.

After studying the single winding, a “Matrix” winding method is then studied. The four single windings are connected in series to increase the number of turns of the total number of turns. The result of magnetizing inductance versus operating frequency are shown in Fig 12 to 14 and the equation is

$$L_m = -6E-07f^3 + 0.0001f^2 - 0.0067f + 2.0825 .$$

The leakage inductance versus the operating frequency are shown in Fig 15 to 17 and the equation is

$$L_l = 4E-07f^3 - 7E-05f^2 - 0.002f + 3.7958.$$

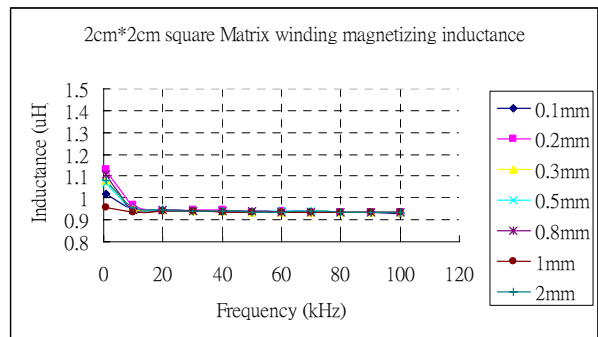

Fig. 12 2cm*2cm Matrix Winding

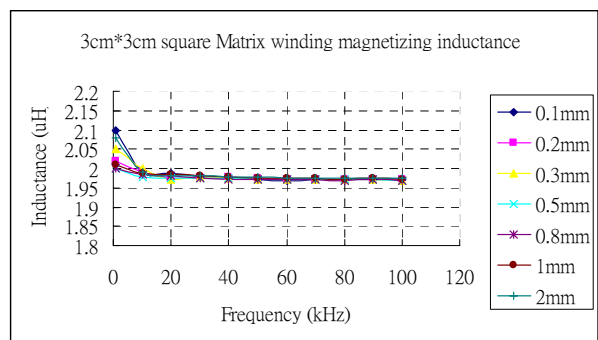

Fig. 13 3cm*3cm Matrix Winding

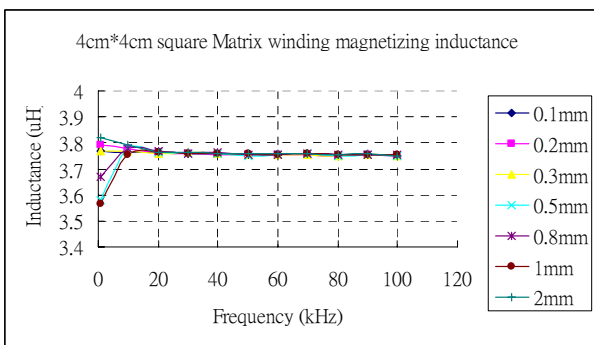

Fig.14 4cm*4cm Matrix Winding

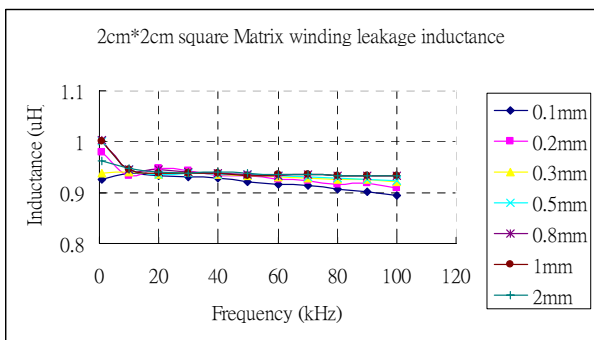

Fig.15 2cm*2cm Matrix Winding

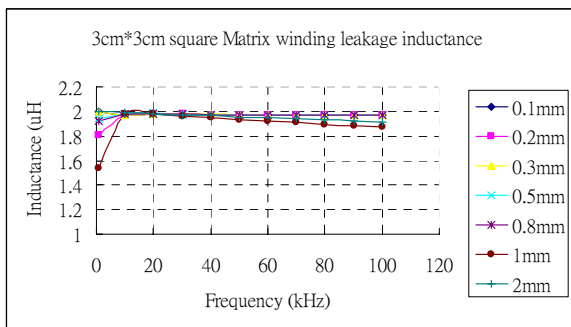

Fig.16 3cm*3cm Matrix Winding

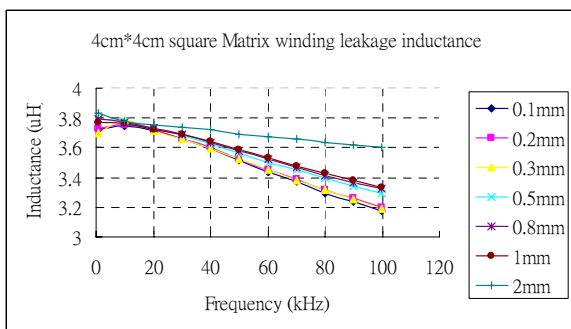

Fig.17 4cm*4cm Matrix Winding

IV. ACHIEVEMENTS

It is found that the magnetizing inductance of the air gap cordless transformer is independent of the distance between the primary and the secondary winding. With the higher winding surface area, the larger magnetizing

inductance it will be.

From the result, it shows that the leakage inductance decreases while the distance of primary and the secondary winding decreases. The 4*4 cm² configuration gives better results in the coupling as the leakage inductance improve with frequency. For other areas, the coupling is poor.

The use of matrix winding provides more turns in the same area than those in single winding. It is an interesting finding that the new topology is efficient for large area because of the reduction of the leakage flux in the air gap.

The formulation of the magnetizing and leakage inductance of the contactless transformer has been developed. The equations can be used to access the future design of the contactless conversion for neuroprosthesis application.

V. CONCLUSIONS AND DISCUSSION

In this paper, there are two methods are introduced to improve the efficiency of the energy transfer in the neuroprosthesis. The first one, there are two capacitors added in parallel so as to have a resonance effects in both the primary and secondary side. The effects can store the energy which is not transferred to the secondary winding. It can also reduce the low magnetizing impedance problem during the lower frequency operation and hence reduce the loss in the magnetizing inductance. The second one is that the formation of the winding pattern. A “Matrix” winding is introduced.

VI. Acknowledgement

The author would like to express the thanks to the financial support of the Research Committee of the Hong Kong Polytechnic University under project G-YD90.

VII REFERENCES

1. Jose A. B. Gerald, Goncalo Tavares, Moises S. Piedade, Elisio Varela, Ricardo Ribeiro, “RF-Link for cortical neuroprosthesis,”

- Circuit and Systems, 2005, ISCAS 2005, IEEE international symposium on 23-26 May 2005, Vol.3, pp. 2739-2742, 2005.
2. S.Y.R. Hui, S. C. Tang, H. Chung, "Coreless printed-circuit board transformers for signal and energy transfer", *Electronics Letters* Vol.34, No.11@IEE, pp. 1052-1054.
 3. Christian Sauer, Milutin Stanacevic, Gert Cauwenberghs, Nitish Thakor, "Power Harvesting and Telemetry in CMOS for Implanted Devices", *IEEE transactions on circuits and systems- Regular Papers*, Vol.52, No.12, December 2005, pp. 2605-2613.
 4. S.Y.R. Hui, S. C. Tang, H. Chung, "Optimal Operation of Cordless PCB Transformer-Isolated Gate Drive Circuits with Wide Switching Frequency Range", *IEEE transactions on power electronics*, Vol. 14, No. 3, May 1999, pp. 506-514.
 5. Iasonas F. Triantis, Andreas Demosthenous, "A BiCMOS ENG Amplifier with HIGH SIR Output", *Circuit and Systems, 2005, ISCAS 2005, IEEE international symposium on 23-26 May 2005*, Vol.1, pp. 744-747
 6. H.L.Chan, K.W.E. Cheng and D. Sutanto, "A Simplified NEUMANN'S Formula for Calculation of Inductance of Spiral Coil", *Power Electronics And Variable Speed Drives*, 18-19 December 2000, Conference Publication No. 475 @IEE 2000, pp. 69-73.
 7. K.W.E. Cheng, H.L. Chan, D. Sutanto, "Development of a superconducting transformer using self-resonant techniques for DC/DC power conversion", *IEEE Proc.-Electr. Power Appl.*, Vol.151, No3, May 2004, pp. 296-302.
 8. T.A. Thrasher, M.R. Popovic, "Rehabilitation of incomplete spinal cord injury using a neuroprosthesis for walking", *Engineering in Medicine and Biology Society*, 2003. Proceedings of the 25th Annual International Conference of the IEEE Volume 2, 17-21 Sept. 2003, pp. 1566-1568, Vol.2
 9. W.R. Patterson, Yoon-Kyu Song; C.W. Bull, I. Ozden, A.P. Deangellis, C. Lay, J.L. McKay, A.V. Nurmikko, J.D. Donoghue, B.W. Connors, "A microelectrode/microelectronic hybrid device for brain implantable neuroprosthesis applications", *Biomedical Engineering*, *IEEE Transactions on Volume 51*, Issue 10, Oct. 2004, pp. 1845-1853
 10. R.F. Kirsch, "Development of a neuroprosthesis for restoring arm and hand function via functional electrical stimulation following high cervical spinal cord injury", *Engineering in Medicine and Biology Society*, 2005, *IEEE-EMBS 2005. 27th Annual International Conference of the 01-04 Sept. 2005*, pp. 4142-4144.