

Spherically shaped active transducer based on proton-irradiated vinylidene fluoride-trifluoroethylene 70/30 mol % copolymer

S. T. Lau,^{a)} H. L. W. Chan, and C. L. Choy

Department of Applied Physics, The Hong Kong Polytechnic University, Hung Hom, Kowloon, Hong Kong, China and Materials Research Centre, The Hong Kong Polytechnic University, Hung Hom, Kowloon, Hong Kong, China

W. Y. Cheung and S. P. Wong

Department of Electronic Engineering, The Chinese University of Hong Kong, Shatin, New Territories, Hong Kong, China

(Received 4 October 2005; accepted 5 April 2006; published online 26 May 2006)

Spherically shaped active transducers using proton-irradiated vinylidene fluoride-trifluoroethylene 70/30 mol % copolymer films as the active elements are described. The copolymer films prepared by hot compression molding were irradiated with a high energy proton over a broad dose range (20–250 Mrad). The electrostrictive and piezoelectric responses of the copolymer have been characterized before subsequent transducer fabrication. The performances of the focused transducers constructed with a 4 mm aperture size and epoxy backing were evaluated under dc bias voltages. The transducers with focal lengths of 17.4–19.0 mm and a center frequency of 19 MHz display a broad bandwidth up to 94%. Besides, the transmitting output of the transducers increases with the dc bias voltage. For the copolymer active element irradiated at a proton dose of 107 Mrad, the transducer shows the highest transmitting voltage response of 1.34 kPa/V. © 2006 American Institute of Physics. [DOI: [10.1063/1.2200878](https://doi.org/10.1063/1.2200878)]

I. INTRODUCTION

Ultrasound has become increasingly important in the practice of medicine over the past two decades. High frequency ultrasonic imaging with medical applications in dermatology,^{1–3} ophthalmology,^{3,4} and intravascular imaging⁵ has been speculated by many researchers to be the next frontier in ultrasonic imaging. The role of a transducer as an element in the imaging systems for converting electric to acoustic power is emphasized. Hence, considerable effort has been spent into the development of high performance transducers with broad bandwidth, high power, and high operating frequency for better lateral resolution. Since the attenuative loss of the ultrasound observed in various human soft tissues becomes obvious at high frequency (>10 MHz), the increased signal loss limits the penetration depth as well as the resolution of the ultrasound beam. To improve its lateral resolution, spherically shaped transducers^{6,7} have been fabricated for beam focusing.

Since the 1960s, piezoelectric ceramics have been extensively used in fabricating piston-type ultrasonic transducers because of their outstanding electromechanical properties.^{8,9} As the acoustic impedances of ceramics are much higher than those of the subjects under test (i.e., tissues in medical diagnosis), the energy transmission is inefficient. Besides, to fabricate transducers for high frequency operation, piezoelectric elements with a thickness less than 0.2 mm are required which are difficult to fabricate with conventional pi-

ezoelectric ceramics. Following the discovery of piezoelectric polymers, such as polyvinylidene fluoride (PVDF) and its copolymers with trifluoroethylene (TrFE), these polymers have been used as the active elements of ultrasonic transducers^{10–12} as they have high degree of flexibility and low acoustic impedance. However, a very high electric field (>100 MV/m) is required to elicit the piezoelectric property in the polymers.

In recent years, irradiation treatment has been applied for modifying many performances of the piezoelectric PVDF and P(VDF-TrFE) copolymer.^{13–17} Lovinger¹³ and exposed P(VDF-TrFE) copolymer films to electron irradiation, and found a polymorphic transformation of the ferroelectric phase to the paraelectric phase was induced at room temperature. Calcagno *et al.*¹⁴ observed that the melting temperature and crystallinity of PVDF film reduced after irradiation with a carbon beam. More recently, Zhang and co-workers^{15,16} reported that the piezoelectric P(VDF-TrFE) copolymers of various compositions have been converted into relaxor ferroelectrics upon electron irradiation at high temperature, which possessed an exceptional high electrostrictive strain response (~4%) and a slim polarization hysteresis loop. In our previous work,^{17,18} we found that irradiating P(VDF-TrFE) at room temperature by proton can produce giant electrostrictive effect compared to that of electron irradiation at high temperature. These irradiated copolymer films with thickness of several tens of micrometers have demonstrated promise as active materials for high frequency ultrasonic transducers. In this article, the construction and evaluation of the spherically shaped active transducers using copolymer samples irradiated with different proton doses are reported.

^{a)} Author to whom correspondence should be addressed; FAX: (852) 2333 7629; electronic mail: apstlau@polyu.edu.hk

P(VDF-TrFE) 70/30 mol % copolymer films prepared by hot compression molding method were irradiated by 3 MeV proton at room temperature over a wide range of doses. Before transducer fabrication, the effect of the proton dose on both electrostrictive and piezoelectric properties of the copolymer films was studied. The copolymer films, with proton doses of 75, 107, and 150 Mrad, were fabricated into focused active transducers with epoxy backing and with no front face matching layer. All transducers were characterized in water under the application of different dc bias voltages, whereby the focal length, center frequency, bandwidth, and transmitting voltage response were measured.

II. EXPERIMENT

Copolymer of vinylidene fluoride and trifluoroethylene [P(VDF-TrFE)] with the composition of 70/30 mol %, supplied in pellet form by Piezotech, Saint Louis, France, was used. The copolymer films (25 mm in diameter) were fabricated using compression molding at a temperature of 210 °C and a pressure of 50 MPa for 10 min. To increase the crystallinity of the copolymer films, the films were annealed at 120 °C for 2 h. The film thickness was 30–40 μm .

The proton irradiation process on the copolymer samples was conducted in a 2 MV tandem electrostatic accelerator (model 4120-LC Tandetron, High Voltage Engineering Europa B.V., Netherlands). The samples were placed in the chamber at a pressure of 1.3×10^{-4} Pa, and a 3 MeV energetic proton beam with a diameter of 5 mm was used to scan through the sample during the process. To avoid excessive temperature increase in the sample, a low beam current of about 0.01 mA/m² was set. The proton fluence was in the range of $(1.19\text{--}14.8) \times 10^{17}$ ion/m², which was converted to dose by multiplying the irradiation fluence with linear energy transfer [~ 20 eV/nm for 3 MeV proton beam irradiating on P(VDF-TrFE) copolymer] and dividing by the copolymer density (~ 1900 kg/m³) and finally using a conversion factor of 1 Gy equals to 6.24×10^{18} eV/kg (where 1 Gy=100 rad). The proton dose used was calculated to be in the range of 20–250 Mrad.

To characterize the electromechanical property of the samples, circular aluminum electrodes of 3 mm diameter and 150 nm thickness were evaporated on both surfaces of the copolymer samples. The electrostrictive strain response along the thickness direction was measured by a heterodyne laser interferometer¹⁹ at a frequency of 10 kHz. The direct piezoelectric effect of the samples, poled by an ac field of 100 MV/m, was evaluated using a ZJ-3B d_{33} meter (Institute of Acoustics, Academia Sinica). For comparison, the piezoelectric and electrostrictive responses of unirradiated copolymer sample were also measured.

For the transducer fabrication, circular disks of 8 mm diameter were cut from both the unirradiated and irradiated copolymer films as the active elements of the transducers. Figure 1 shows the schematic structure and photograph of the focused transducer. A chromium-gold (Cr/Au) layer of 4 mm diameter and 150 nm thickness was sputtered on one of the copolymer film surfaces as bottom electrode. A copper wire of 0.1 mm diameter was soldered onto the center pin of

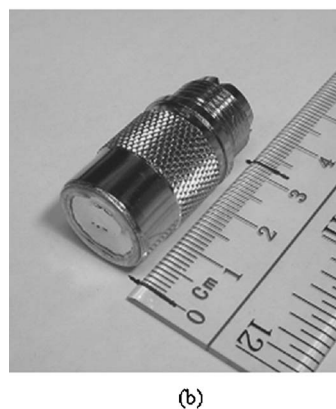
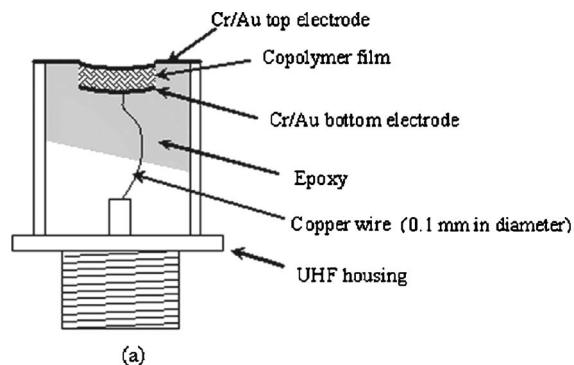

FIG. 1. (a) Schematic structure of the high frequency focused transducer and (b) photograph of the focused transducer.

an ultrahigh frequency (UHF) connector and the other end was glued to the bottom electrode of the copolymer film by silver paint (supplied by Agar Scientific Ltd.). The connector was filled with epoxy as backing material. When the epoxy had partially hardened, the copolymer film with copper wire connected was then pressed onto the epoxy with a steel ball. After the epoxy had set, the steel ball was taken away. The curvature of the focused transducer was dependent on the radius of the steel ball (16.5–17.8 mm). A Cr/Au layer was sputtered on the top surface of the copolymer element to make contact with the metal housing and served as the ground electrode.

The transmitting responses of both the unirradiated and irradiated copolymer transducers were evaluated in the water tank (Fig. 2). The transducer was excited by an electrical impulse (with 4 μJ energy, 1 kHz repetition, and 50 Ω damping) generated from the Panametrics 5900PR ultrasonic transducer analyzer. By using the irradiated copolymer as the active element, the transducer was required to operate under dc bias voltages; a decoupler²⁰ was then used to superimpose the electrical impulse (as shown in the insert of Fig. 2) on the bias voltage to drive the transducer. A plane P(VDF-TrFE) copolymer transducer was used as a receiver in the testing of the focused active transducers. The receiver was placed at the focal region of the transducer to detect the ultrasonic signal from the transducer. The voltage signal from the receiver was processed by the Panametrics analyzer through the receiving terminal *R*. The focal region of the transducer was found by adjusting the separation between the receiver

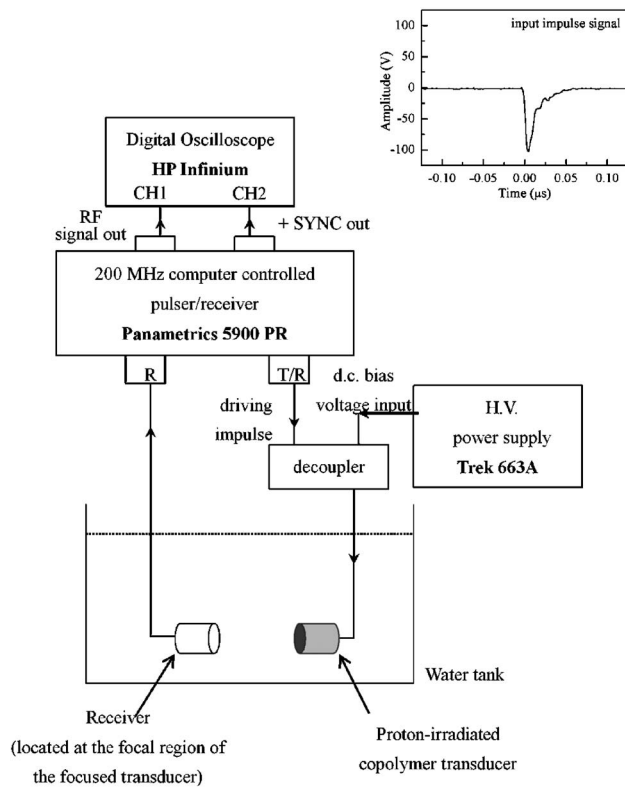

FIG. 2. Schematic diagram of the setup for testing the focused transducer.

and the transducer to maximize the amplitude of the output voltage. The waveform of the received signal was recorded by the HP Infinium digital oscilloscope.

III. RESULTS AND DISCUSSION

A. Electrostrictive and piezoelectric responses of the proton-irradiated copolymer

The longitudinal strain S for both the unirradiated and irradiated copolymer samples induced under an applied electric field E was measured with the laser beam incident on the electroded surface of the samples. Figure 3 shows the variation of the strain plotted as a function of the square of the applied electric field. The observed linear relation between S and E^2 implies the electrostrictive effect and the electrostrictive coefficient M_{33} can be calculated by²¹

$$S = M_{33}E. \quad (1)$$

As the sample is driven by an ac field only, $E = E_0 \cos(\omega t)$, Eq. (1) will be rewritten to

$$S = \frac{1}{2}M_{33}E_0^2 + \frac{1}{2}M_{33}E_0^2 \cos(2\omega t). \quad (2)$$

In this work, the field induced strain was measured using the heterodyne laser interferometer in which the steady strain [the first term on the right of Eq. (2)] was compensated by a feedback system in the interferometer, and hence only the varying strain [the second term in Eq. (2)] was recorded. Table I shows the electrostrictive coefficient M_{33} of unirradiated and irradiated P(VDF-TrFE) copolymer samples. The piezoelectric coefficient d_{33} of the samples poled by a high ac field was also presented in Table I. After irradiation, the electrostrictive coefficient increases but the piezoelectric co-

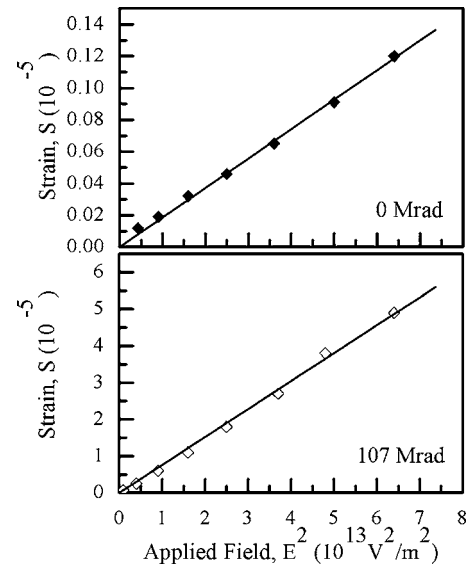

FIG. 3. Longitudinal strain as a function of the square of the applied field for unirradiated and irradiated copolymer films.

efficient decreases. At the dose of 107 Mrad, the M_{33} coefficient reaches a maximum value of $1.65 \times 10^{-18} \text{ m}^2/\text{V}^2$ and the d_{33} coefficient reduces to -2.0 pC/N . Comparing with the M_{33} coefficient obtained in unirradiated sample, the M_{33} coefficient is improved by nearly two orders of magnitude through the irradiation process. Our previous reports^{17,18} indicate that the high energy proton beam destroys the ferroelectric ordering and breaks up the macroscopic domains into nanosized regions, resulting in significant decrease in the polarization as well as the piezoelectric response. The proton beam converts the crystalline regions from the ferroelectric (polar) phase, characterized by an all-*trans* conformation in the molecular chains, to a paraelectric (nonpolar) phase, indicated by the *trans-gauche* conformations in the molecular chains. By applying an electric field to the irradiated copolymer, local phase transformation between the paraelectric phase and ferroelectric phase is induced. Due to the large difference between the lattice spacing of the two phases, this phase transformation leads to the high electrostrictive strain response. Further increase in the proton dose, the M_{33} coefficient reduces gradually and d_{33} coefficient is close to zero. This may probably due to the significant decrease in the crystallinity of the irradiated sample.

The outstanding electrostrictive strain response observed

TABLE I. Electrostrictive coefficient M_{33} and piezoelectric coefficient d_{33} of unirradiated and irradiated P(VDF-TrFE) copolymer samples.

Dose (Mrad)	M_{33} ($10^{-18} \text{ m}^2/\text{V}^2$)	d_{33} (pC/N)
0	0.04	-28.8
20	0.08	-22.7
43	0.18	-17.4
75	0.84	-8.0
107	1.65	-2.0
150	0.50	...
200	0.23	...
250	0.20	...

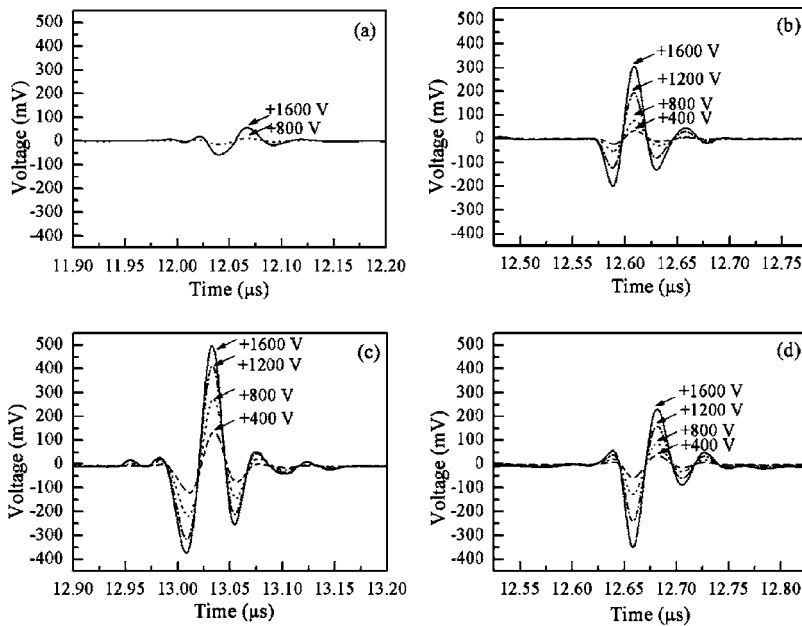

FIG. 4. The waveforms obtained for proton-irradiated P(VDF-TrFE) copolymer transducers under dc bias voltages of +400, +800, +1200, and +1600 V. Proton doses: (a) 0 Mrad, (b) 75 Mrad, (c) 107 Mrad, and (d) 150 Mrad.

in irradiated copolymer has considerable interest for the use of this material in ultrasonic transducer application. Due to their weak piezoelectric responses, the irradiated copolymer films with proton doses of 75, 107, and 150 Mrad were fabricated into spherically shaped active transducers. The focal depths were achieved by press focusing the copolymer films into a spherical curvature of the steel ball. The performances of these transducers were evaluated in water under the application of different dc bias voltages.

B. Characterization of the active transducer based on proton-irradiated copolymer

To induce the electrostrictive strain response of both unirradiated and irradiated active elements, the transducers were tested in water under a dc bias voltage. The focal region of the transducer was found by translating the receiver normal to the acoustical axis of the transducer. The maximum output signal was received at a distance range of 17.4–19.0 mm, which is slightly higher than the expected geometric focal distance of 16.5–17.8 mm. This implied that the surface of the irradiated active element was not perfectly in contact along the spherical curvature of the steel ball. Figure 4 shows the wave forms received for the transducers with different proton doses. The dc bias voltages were set at

+400, +800, +1200, and +1600 V. The thickness of the active element was $\sim 35 \mu\text{m}$, hence the maximum field applied to the element was $\sim 45 \text{ MV/m}$. The amplitudes of waveform increase with the bias voltage, indicating that transducers with tunable transmitting output have been fabricated.

In comparison to the irradiated transducers, the signal from the unirradiated transducer is quite weak, indicating that it has a low transmitting response. For the irradiated transducer with the dose of 107 Mrad, the signal transmitted from the active element shows the largest amplitude as it provides the highest electrostrictive strain response. As the active element irradiated with higher proton dose, the electrostrictive strain response decreases, resulting in a decrease in the transmitting response. Figure 5 shows the waveform transmitted from the 107 Mrad irradiated copolymer transducer under a negative bias voltage. If the bias voltage changes its sign, the waveform is inverted. Figure 6 describes the strain response ΔS dependence of the electric field E when the electrostrictive copolymer film is excited under a dc bias field (E_D). When the transducer is driven by an electrical pulse, the copolymer film resonates. The strain of the film leads to the generation of ultrasonic wave from the transducer and the voltage signal obtained by the re-

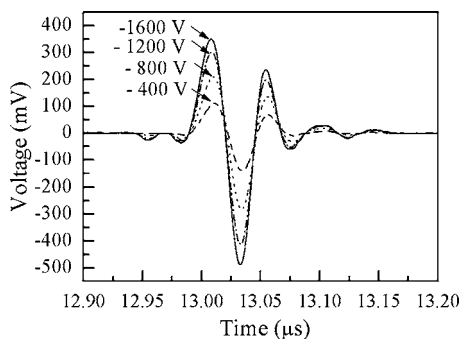

FIG. 5. Inverted waveforms obtained for 107 Mrad irradiated transducer under -400, -800, -1200, and -1600 V dc bias voltages.

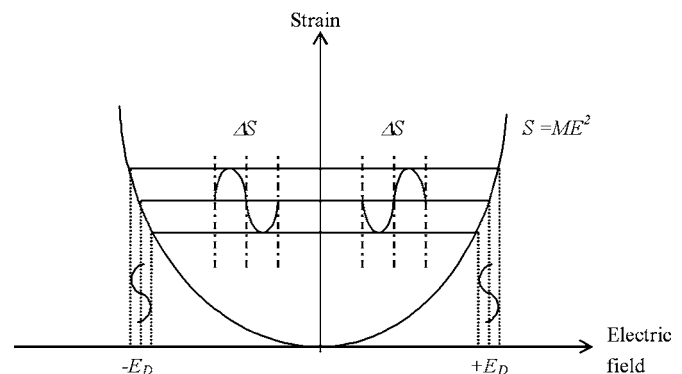

FIG. 6. Electrostrictive strain response ΔS induced by an electrical pulse for the irradiated copolymer film operated under a dc bias field ($\pm E_D$).

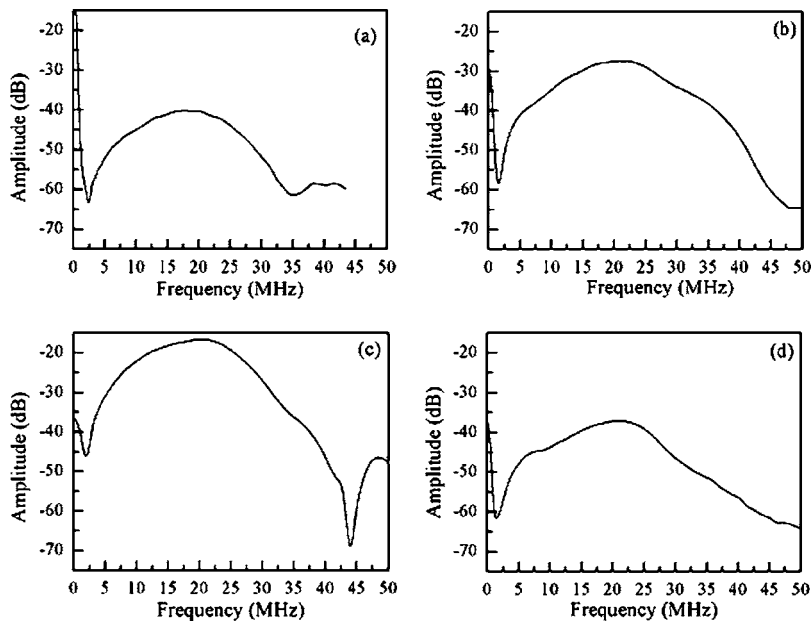

FIG. 7. Frequency spectra obtained for P(VDF-TrFE) focused transducers with active element irradiated at different proton doses: (a) 0 Mrad, (b) 75 Mrad, (c) 107 Mrad, and (d) 150 Mrad.

ceiver. When the dc bias field changes from positive to negative, ΔS is reversed and an inverted voltage pulse is obtained. Besides, as E_D increases, a higher strain response is obtained which agrees with our experimental results.

The frequency spectra of the transducers obtained by applying the fast Fourier transform (FFT) after patching zeros to the measured time waveforms are shown in Fig. 7. The signal loss due to attenuation in the water tank was compensated for using an attenuation of 2.2×10^{-4} dB/mm MHz². The center frequency (f_c), transmitting voltage response (TVR), -6 dB fractional bandwidth (BW), and ringdown²² of both unirradiated and irradiated transducers are summarized in Table II. The center frequencies of the unirradiated and irradiated transducers are about 18 and 19 MHz, respectively, which can be varied by changing the film thickness. For the active element irradiated at 107 Mrad, the highest TVR at the center frequency is observed among all transducers. Under a dc bias of 800 V, it shows the TVR of 0.61 kPa/V. By increasing the dc bias to 1600 V, the TVR increases to 1.34 kPa/V. The -6 dB BW of the irradiated transducers is up to 94%. This bandwidth is better than can be obtained using either ceramic or ceramic/polymer composite devices but the transmitting response is poorer. Snook *et al.*²³ showed that a PbTiO₃ ceramic transducer and a LiNbO₃ crystal transducer displayed a bandwidth of 47%.

TABLE II. Properties of the proton-irradiated P(VDF-TrFE) 70/30 mol % focused transducers.

Transducer (with active element irradiated at different doses)	f_c (MHz)	BW (%)	TVR (kPa/V)		Ringdown
			at 800 V dc bias	at 1600 V dc bias	
0	17.6	105	0.07	0.15	1.5
75	19.9	90	0.23	0.65	1
107	18.6	94	0.61	1.34	2
150	19.3	89	0.29	0.82	2

Kowk *et al.*²⁴ reported that PZT/P(VDF-TrFE) 1–3 composite transducers have the bandwidth of 27%–49% and transmitting voltage response of 2.4–4.5 kPa/V. With the epoxy as the backing material, the transducers provide short ring-down which is desirable to produce pulses of very short duration. This optimizes the axial resolution of the transducer.

In this paper, spherically shaped active transducers using irradiated P(VDF-TrFE) 70/30 mol % copolymers as the driving elements are introduced. The effect of proton dose on the electrostrictive and piezoelectric properties of the copolymer films has been investigated before transducer fabrication. Upon irradiation, the electrostrictive M_{33} coefficient increases but the piezoelectric d_{33} coefficient decreases. At a proton dose of 107 Mrad, the maximum M_{33} of 1.65×10^{-18} m²/V² is obtained and the d_{33} is only -2 pC/N. Under the application of dc bias voltage, the transducers can generate ultrasonic waves at a center frequency of 19 MHz with a -6 dB bandwidth up to 94%. Besides, transmission efficiency of the transducers increases with dc bias voltages. For the active element irradiated with the optimum proton dose of 107 Mrad, the transducer shows the highest transmitting voltage response of 1.34 kPa/V. Comparing to the piezoelectric ceramic and composite transducers, this irradiated transducer has a broader bandwidth but lower transmitting response.

ACKNOWLEDGMENTS

The authors would like to thank the Centre for Smart Materials (CSM) of the Hong Kong Polytechnic University, the Hong Kong Research Grants Council (PolyU 5147/02E), and the Hong Kong Polytechnic University Postdoctoral Fellowship Scheme (Project No. G-YX16) for the financial support of this work.

¹T. Yano, H. Frkukita, S. Uneo, and A. Fukumoto, Proc.-IEEE Ultrason. Symp. 2, 875 (1987).

²M. Berson, F. Villant, F. Patat, and L. Pourcelot, Ultrasound Med. Biol. 18, 471 (1992).

³C. Passman and H. Ermert, IEEE Trans. Ultrason. Ferroelectr. Freq.

- Control **43**, 545 (1996).
- ⁴R. H. Silverman, F. L. Lizzi, B. G. Ursea, L. Cozzarelli, J. A. Ketterling, C. X. Deng, R. Folberg, and D. J. Coleman, *J. Ultrasound Med.* **20**, 979 (2001).
- ⁵R. W. Martin, F. E. Silverstein, and M. B. Kinney, *Ultrasound Med. Biol.* **15**, 273 (1989).
- ⁶G. R. Lockwood, D. H. Turnbull, and F. S. Foster, *IEEE Trans. Ultrason. Ferroelectr. Freq. Control* **41**, 231 (1994).
- ⁷K. Li, H. L. W. Chan, and C. L. Choy, *IEEE Trans. Ultrason. Ferroelectr. Freq. Control* **50**, 1371 (2003).
- ⁸D. A. Berlincourt, D. R. Curran, and H. Jaffe, *Physical Acoustics*, edited by N. P. Mason (Academic, New York, 1964), Vol. 1, Pt. A, p. 170.
- ⁹B. Jaffe, W. R. Cook, Jr., and H. Jaffe, *Piezoelectric Ceramics* (Academic, New York, 1971).
- ¹⁰A. Ambrosy and K. Holdik, *J. Phys. E* **17**, 856 (1984).
- ¹¹M. Platte, *Ferroelectrics* **75**, 327 (1987).
- ¹²K. Kimura and H. Ohigashi, *J. Appl. Phys.* **61**, 4749 (1987).
- ¹³A. J. Lovinger, *Radiation Effects on Polymers*, edited by R. L. Clough and W. Shalaby (American Chemical Society, Washington, DC, 1991), Chap. 6.
- ¹⁴L. Calcagno, P. Musumeci, R. Percolla, and G. Foti, *Nucl. Instrum. Methods Phys. Res. B* **91**, 461 (1994).
- ¹⁵Q. M. Zhang, V. Bharti, and X. Zhao, *Science* **280**, 2101 (1998).
- ¹⁶Y. Z. Cheng, V. Bharti, T. Mai, T. B. Xu, Q. M. Zhang, T. Ramotowski, K. A. Wright, and R. Ting, *IEEE Trans. Ultrason. Ferroelectr. Freq. Control* **47**, 1296 (2000).
- ¹⁷S. T. Lau, K. Y. Leung, H. L. W. Chan, C. L. Choy, B. Sundaravel, and I. Wilson, *Ferroelectrics* **273**, 9 (2002).
- ¹⁸S. T. Lau, H. L. W. Chan, and C. L. Choy, *IEEE Trans. Dielectr. Electr. Insul.* **11**, 210 (2004).
- ¹⁹Z. Zhao, H. L. W. Chan, and C. L. Choy, *Ferroelectrics* **195**, 35 (1997).
- ²⁰S. S. Guo, S. T. Lau, H. L. W. Chan, X. Z. Zhao, and C. L. Choy, *Ultrasonics* **41**, 223 (2003).
- ²¹J. F. Nye, *Physical Properties of Crystal* (Oxford University Press, London, (1957), p. 1957).
- ²²NEMA standard methods for testing single-element pulse-echo ultrasonic transducers—Interim Standard (August 1981); *J. Ultrasound Med.* **1**, 7 (1982).
- ²³K. A. Snook, J. Z. Zhao, C. H. F. Alves, J. M. Cannata, W. H. Chen, Jr., R. J. Meyer, T. A. Ritter, and K. K. Shung, *IEEE Trans. Ultrason. Ferroelectr. Freq. Control* **49**, 169 (2002).
- ²⁴K. W. Kowk, H. L. W. Chan, and C. L. Choy, *IEEE Trans. Ultrason. Ferroelectr. Freq. Control* **46**, 626 (1999).