



**AALBORG UNIVERSITY**  
DENMARK

**Aalborg Universitet**

## **Power Control Flexibilities for Grid-Connected Multi-Functional Photovoltaic Inverters**

Yang, Yongheng; Blaabjerg, Frede; Wang, Huai; Simoes, Marcelo

*Published in:*  
IET Renewable Power Generation

*DOI (link to publication from Publisher):*  
[10.1049/iet-rpg.2015.0133](https://doi.org/10.1049/iet-rpg.2015.0133)

*Publication date:*  
2016

*Document Version*  
Peer reviewed version

[Link to publication from Aalborg University](#)

*Citation for published version (APA):*  
Yang, Y., Blaabjerg, F., Wang, H., & Simoes, M. (2016). Power Control Flexibilities for Grid-Connected Multi-Functional Photovoltaic Inverters. IET Renewable Power Generation, 10(4), 504 – 513. DOI: 10.1049/iet-rpg.2015.0133

### **General rights**

Copyright and moral rights for the publications made accessible in the public portal are retained by the authors and/or other copyright owners and it is a condition of accessing publications that users recognise and abide by the legal requirements associated with these rights.

- ? Users may download and print one copy of any publication from the public portal for the purpose of private study or research.
- ? You may not further distribute the material or use it for any profit-making activity or commercial gain
- ? You may freely distribute the URL identifying the publication in the public portal ?

### **Take down policy**

If you believe that this document breaches copyright please contact us at [vbn@aub.aau.dk](mailto:vbn@aub.aau.dk) providing details, and we will remove access to the work immediately and investigate your claim.

# Power Control Flexibilities for Grid-Connected Multi-Functional Photovoltaic Inverters

Yongheng Yang, *Member, IEEE*, Frede Blaabjerg, *Fellow, IEEE*, Huai Wang, *Member, IEEE*,  
and Marcelo Godoy Simões, *Senior Member, IEEE*

**Abstract**—This paper explores the next-generation photovoltaic (PV) system integration issues considering a high penetration level, where the grid is becoming more decentralized and vulnerable. In that case, the PV systems are expected to be more controllable with both higher efficiency and higher reliability. Provision of ancillary and intelligent services, like Low Voltage Ride-Through (LVRT), flexible active power control (i.e., outside the maximum power point tracking), reactive power compensation (e.g., reactive power at nights), and reliability-oriented thermal management/control by PV systems are key methods to attain higher utilization of solar PV energy in the power electricity generation. Those essential functionalities for the future PV inverters can contribute to reduced cost of energy, and thus enable more cost-effective PV installations. In order to implement the advanced features, a flexible power controller is developed in this paper, which can be configured in the PV inverter and flexibly change from one to another mode during operation. This power control strategy is based on the single-phase  $PQ$  theory, and it offers the possibilities to generate appropriate references for the inner current control loop. The references depend on the system conditions and also specific demands from both system operators and prosumers. Besides, this power control strategy can be implemented in a commercial PV inverter as standardized function, and also the operation modes can be achieved online in a predesigned PV inverter. Case studies with simulations and experiments in this paper have verified the effectiveness and flexibilities of the power control strategy to realize the advanced features.

**Index Terms**—Photovoltaic power systems, active power control, reactive power control, grid integration, ancillary service, reliability, single-phase, dc-ac inverters, power conversion.

## I. INTRODUCTION

Another spectacular growth of grid-connected photovoltaic (PV) systems has been witnessed in the year of 2014 [1], where the total installed capacity of 177 gigawatts has been reached, corresponding to an annual addition of 40 gigawatts. The penetration level of PV systems will be further increased in the future [2], since it is an effective solution to carbon-dioxide reduction and also an essential component of “smart” grid and/or “intelligent” power systems [3]–[6].

Manuscript received April 2, 2015; revised October 20, 2015; accepted November 11, 2015. This paper has been in part presented at the 4th International Workshop on Integration of Solar Power into Power Systems. Approval from the Energynautics GmbH has been obtained upon the submission of this manuscript to IET RENEWABLE POWER GENERATION for peer-review.

Y. Yang, F. Blaabjerg, and H. Wang are with the Department of Energy Technology, Aalborg University, 9220 Aalborg, Denmark (e-mail: yoy@et.aau.dk; fbl@et.aau.dk; hwa@et.aau.dk).

M. G. Simões is with the Department of Engineering, Colorado School of Mines, Golden, CO 80401 USA (e-mail: mgsimoes@ieee.org).

Digital Object Identifier 10.1049/iet-rpg.2015.xxxx.

© The Institution of Engineering and Technology 2015 (www.ietdl.org).

However, a considerably expanding installation of PV systems into the grid also brings side-effects on the entire distributed network due to the intermittent nature of solar PV energy (e.g., solar irradiance variations and temperature fluctuations, and thus fluctuating PV power), which will as a consequence affect the availability, the reliability, and the quality of the distributed grid that is connected to. Even for residential PV systems of a few kilowatts, the impact can not be ignored today [7]–[10] due to the ever increasing number of PV units. Possibly, the controllability of the whole PV-integrated power system will be weakened, especially when a very high penetration level is reached, owing to a continuous injection of the fluctuating PV power. In order to facilitate a reliable and efficient power generation from solar PV energy, grid integration guidance associated with critical customer demands is continuously and timely being updated [7], [9], which imposes more challenges for the interfaced PV inverters. Then, making most of PV systems to provide multiple functions is desired. As a result, it calls for advanced and intelligent control strategies for the next-generation multi-functional PV inverter systems to be of much control flexibility in order to achieve those goals.

Hence, it is expected for the future (next-generation) PV systems to have much more controllability by providing ancillary and intelligent services, e.g. Low Voltage Ride-Through (LVRT) [11]–[17], reactive power compensation (Var Comp.) [18]–[21], power quality enhancement [22]–[27], frequency control through active power curtailment (Freq.-Watt function) [13], [28]–[30], active power control (e.g., the  $P$  constraints) [31]–[34], and reliability-oriented thermal management/control [33], [35]–[37]. Together with higher efficiency and higher reliability demands, those functionalities for the future PV inverters are the key to further reduce the total cost of PV energy, and thus an expansion of cost-effective PV systems into the grid.

In order to implement those advanced features, a flexible power controller is developed in this paper, which can be configured in the PV inverter to fulfill the above services and flexibly be changed from one to another mode of operation according to the grid requirements and/or the end-customer demands. This power control strategy is based on the well-known single-phase  $PQ$  theory [46], being of simplicity. It yet offers the possibilities to generate appropriate power references, which are dependent on the system conditions and also specific demands from both system operators and/or the prosumers, and then utilized in the inner control systems. Additionally, this power control strategy can be implemented in a commercial PV inverter as a standardized function, and

TABLE I  
SUMMARY OF MULTIPLE FUNCTIONS (ANCILLARY SERVICES) FOR FUTURE PV INVERTER SYSTEMS.

Features	Remarks
Volt.-Var control	Reactive power control in order to maintain the grid voltage level [38], [39]. However, it should be noted that for small PV systems, the line is mainly resistive, and thus the reactive power control is of less effectiveness compared to the conventional Var compensation plant.
Freq.-Watt control	Based on the droop characteristic between grid frequency and active power production, this control feature is to achieve a constant grid frequency by regulating the active power injected into the grid [28], [29], [40], [41].
$P$ constraints	Active power constraints [31], [33], e.g., delta power production, constant power generation, power ramp control, and peak power limiting control. The constant power generation control has been witnessed as an effective mean to mitigate the overloading happening through sunny days.
Dynamic grid support	In response to voltage faults, PV systems should stay connected to the grid with reactive power injection, especially at a high PV penetration level [11]–[13], in order to avoid triggering severe events, e.g., blackouts.
Lower downtime & higher efficiency	In order to further reduce the cost of energy, both improving the reliability and increasing the efficiency should be enhanced [42], [43].
Harmonic comp.	The PV systems can take an active role in the power quality control, e.g. act as an active power filter [24], [27], [44], [45].
Smart operation	Var injection/compensation at nights, when there is no solar irradiance and the PV inverters remain idle [21].
Flexible integration	As a part of “smart” systems, the PV inverters should be flexibly integrated with other embedded energy systems [10], [26], e.g., batteries, wind turbines, and electric vehicles, where the requirement of communication may increase the total cost, and thus calling for cost-effective communication technologies.

also multiple operation modes can be achieved online in a predesigned PV inverter through the power control strategy.

In addition, this paper also explores the next-generation PV system integration features, develops a power control solution to achieve those advanced features, and initiates further research perspectives. In § II, a summary of the key features for next-generation PV systems is given by briefly reviewing the currently active grid standards/codes, followed by the power control strategy for multi-functional PV inverters. Case studies on the LVRT, reactive power injection (e.g., “Q” at nights), constant active power generation control (e.g., the  $P$  constraints, and also referred to as the absolute active power control), and temperature management using the power control strategy are conducted on a single-phase grid-connected PV inverter system. The results presented in § IV have demonstrated the power control flexibilities for grid-connected PV inverters of multiple functionalities, and it can enable a more controllable and more manageable integration of PV systems into the grid.

## II. ADVANCED PV INVERTER FEATURES

Seen from the developing trend of PV systems, it can be predicted that the grid, where more PV systems are going to be connected to, will become even more decentralized and also vulnerable. This may result in complicated control systems and violate the grid stability due to the injection of the fluctuating PV power, but a reduction of carbon-dioxide emission will be achieved. However, it should be noted that PV systems are not just about decarbonisation, and they can be beneficial in different ways for both grid operators and the customers beyond the basic green-electricity generation [3], [7], [27], [31]. As a consequence, more PV systems are expected in the conventional power networks as well as in the emerging “smart” energy systems.

In order to reach the objective of an even wider scale adoption of PV systems and also to expand the potential

benefits, a smoother transition has to be initiated by the grid system operators and the PV generators by means of revising the integration regulations and developing advanced control strategies, respectively. Nonetheless, most of the currently active grid standards/codes seem largely to require the grid-connected PV inverters to cease energizing once a grid disturbance is confirmed [8], [31], [32], which is against the energy transition. Moreover, specific ancillary services by PV systems have not yet been clearly defined. In order to make the most of solar PV energy in a cost-effective way, a common control strategy has to be developed, and it should be simple, but flexible for future advanced PV inverters with the features listed in Table I, which shows the emerging services/benefits from PV systems.

Notably, the “Volt.-Var control” and “Freq.-Watt control” are based on the droop relationship between the grid voltage and the reactive power injection, and the relationship between the grid frequency and the active power production, respectively [47], [48]. Due to the very low  $X/R$  ratio of single-phase feeders, grid voltage and frequency control through reactive power and active power control is not very effective in a single-phase PV system for residential applications. While this could be an alternative for the PV systems at a high penetration level by appropriately managing the active power production and properly using the reactive power. In this paper, a part of the advanced features shown in Table I for grid-friendly PV systems have been demonstrated. In addition, forecasting, monitoring, and communication technologies also have to be advanced in order to implement these emerging multiple functions.

## III. FLEXIBLE POWER CONTROL STRATEGY

### A. System Description

Fig. 1 shows a grid-connected single-phase PV system, which is a commonly used configuration for residential applications of lower power ratings (e.g., up to 5 kW). As

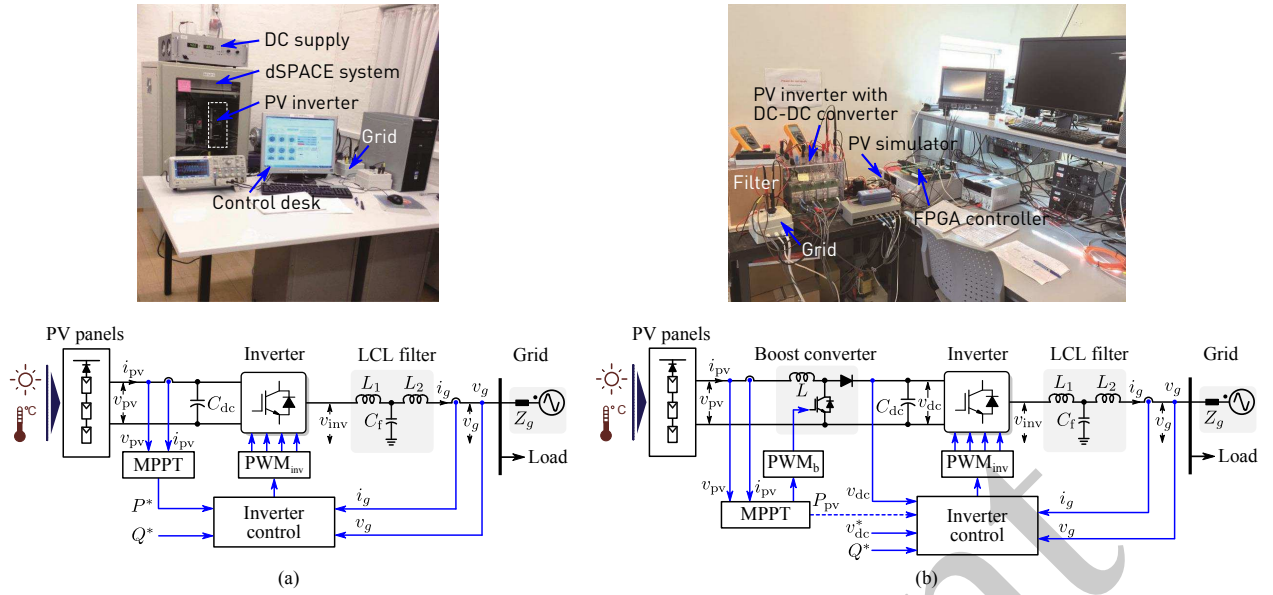

Fig. 1. Typical single-phase grid-connected PV system (transformerless) with an  $LCL$  filter (top: test-rig photo, bottom: schematic): (a) single-stage configuration and (b) double-stage configuration (IGBT Part No.: SKM 50 GB 123D).

TABLE II  
SPECIFICATIONS OF THE SINGLE-PHASE PV SYSTEMS.

Parameter	Symbol	Value	Unit
PV nominal maximum power	$P_{MPP}$	1~3	kW
PV nominal voltage (single-stage)	$v_{MPP}$	400~450	V
PV nominal voltage (double-stage)	$v_{MPP}$	300~350	V
Grid voltage (RMS)	$V_g$	230	V
Grid frequency	$\omega_0$	$2\pi \times 50$	rad/s
DC-link capacitor	$C_{dc}$	1100	$\mu\text{F}$
$LCL$ filter (single-stage)	$L_1$	3.6	mH
	$C_f$	2.35	$\mu\text{F}$
	$L_2$	4	mH
$LCL$ filter (double-stage)	$L_1$	4.8	mH
	$C_f$	4.3	$\mu\text{F}$
	$L_2$	4	mH
Boost converter inductor	$L$	1.8	mH
Inverter switching freq. (single-stage)	$f_{inv}$	10	kHz
Inverter switching freq. (double-stage)	$f_{inv}$	8	kHz
Boost converter switching freq.	$f_b$	16	kHz

achieving high efficiency is always of interest for the inverter manufacturers and also the PV owners, normally, the isolation transformer is as a result removed, being the popular transformerless PV inverter configurations. In order to flexibly maximize the output PV energy with extended operational hours, a DC-DC converter can be adopted between the PV panels and the PV inverter, where the Maximum Power Point Tracking (MPPT) is implemented [33], as shown in Fig. 1(b). In that case, the DC-link control is aimed at an appropriate power injection by controlling the PV inverter, and the DC-link voltage  $v_{dc}$  is controlled to be 450 V in the double-stage system in a 230-V 50-Hz AC grid system. A current controller with harmonic compensation is normally implemented in the inverter control unit as shown in Fig. 1, since the current controller is responsible for shaping the injected current (i.e.,

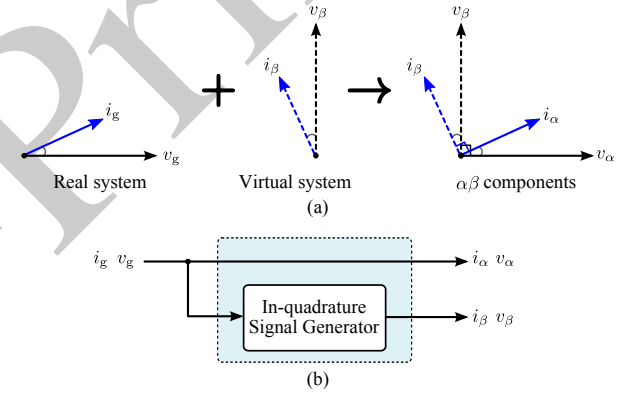

Fig. 2. (a) Graphical representations of the single-phase  $PQ$  theory and (b) in-quadature system generation.

the current quality), which also has to be synchronized with the grid voltage usually by means of a Phase Locked Loop (PLL) in the normal operation mode [49], [50]. Table II shows the system specifications. The experimental setups are also shown in Fig. 1, where commercial PV inverters are adopted.

### B. Flexible Power Control Strategy

With the help of Clarke transformation ( $abc \rightarrow \alpha\beta$ ), the instantaneous power theory proposed by Akagi has been widely used in the three-phase systems [51]. Although this theory is not appropriately applicable to single-phase systems due to a limited number of control variables (i.e., the grid voltage  $v_g$  and the grid current  $i_g$ ), its attractiveness of direct and intuitive active power and reactive power control remains in single-phase systems. Therefore, efforts have been devoted to create an imaginary (virtual) system [46], [49] in order to adopt the instantaneous power theory as it is shown in Fig. 2, being used for the single-phase  $PQ$  theory. According to the

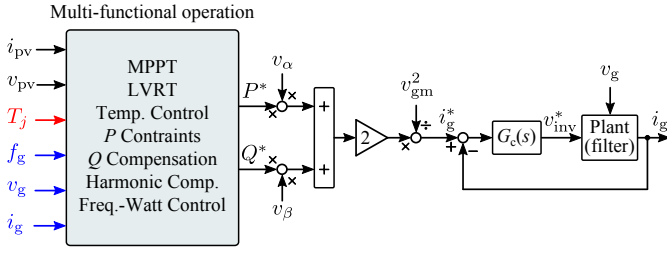

Fig. 3. Closed-loop control block diagram of the single-phase PV system based on the single-phase  $PQ$  theory using a multi-function control, where  $T_j$  and  $f_g$  are the estimated junction temperature of the device and the estimated grid frequency, and  $i_{pv}$ ,  $v_{pv}$ ,  $i_g$ , and  $v_g$  are the measured PV current, PV voltage, grid current, and grid voltage.

single-phase  $PQ$  theory [46], the active power and the reactive power in the  $\alpha\beta$  stationary reference frame can be given as,

$$\begin{cases} P = \frac{1}{2}(v_\alpha i_\alpha + v_\beta i_\beta) \\ Q = \frac{1}{2}(v_\beta i_\alpha - v_\alpha i_\beta) \end{cases} \quad (1)$$

with  $v_{\alpha\beta}$ ,  $i_{\alpha\beta}$  being the grid voltage and grid current in the  $\alpha\beta$  reference frame, and  $P$ ,  $Q$  being the active power and the reactive power, respectively. Referring to Fig. 2, the grid current  $i_g^*$  can then be derived from (1), as it is given by,

$$i_g^* = i_\alpha^* = \frac{2}{v_\alpha^2 + v_\beta^2} [v_\alpha \ v_\beta] \begin{bmatrix} P^* \\ Q^* \end{bmatrix} \quad (2)$$

with

$$v_{gm} = \sqrt{v_\alpha^2 + v_\beta^2} \quad (3)$$

where “\*” denotes the reference signals and  $v_{gm}$  is the grid voltage amplitude. Subsequently, the entire flexible power control diagram based on the single-phase  $PQ$  theory can be illustrated in Fig. 3. The single-phase  $PQ$  theory also enables the use of popular Proportional Integrator (PI) controllers in the  $dq$  rotating reference frame for the grid current control, where a Park transformation is required. Moreover, it is also possible to use PI controllers to control the active power and the reactive power injected to the grid [11]. However, the use of PI controller as the current controller is not covered in this paper for simplicity.

It can be observed in (2) and Fig. 3 that, the power control solution does not require a PLL system to synchronize the grid current with the grid voltage. Instead, the dynamics of the power control system are highly dependent on the performance of the built-up  $\alpha\beta$  system, i.e.,  $v_\alpha$  and  $v_\beta$ , where the synchronization actually is also achieved. Consequently, as it is shown in Fig. 2, the implementation of the power control strategy is shifted to create a quadrature signal generator, e.g., based on the Hilbert transformation, inverse Park transformation, and the Second Order Generalized Integrator (SOGI) [46], [49], [52]. A SOGI based in-quadrature generation system has been adopted in the power control strategy in this paper, where the in-quadrature voltage system can be expressed as

$$\mathbf{v}_{\alpha\beta}(s) = \begin{bmatrix} v_\alpha(s) \\ v_\beta(s) \end{bmatrix} = \begin{bmatrix} \frac{k\omega s}{s^2 + k\omega s + \omega^2} \\ \frac{k\omega^2}{s^2 + k\omega s + \omega^2} \end{bmatrix} v_g(s) \quad (4)$$

in which  $k$  is the tuning parameter and  $\omega$  is the grid frequency. It can be observed in (4) that the in-quadrature system exhibits a second-order band-pass (i.e.,  $v_\alpha(s)/v_g(s)$ ) and a second-order low-pass filter (i.e.,  $v_\beta(s)/v_g(s)$ ), respectively. It is confirmed that the SOGI based in-quadrature system has good harmonic rejection ability. In addition, once the tuning parameter  $k = \sqrt{2}$ , it also results in relatively fast dynamics and optimal overshoots. More details of the SOGI system are directed to [49].

Notably, in such a power control system, all the current controllers in the  $\alpha\beta$  stationary reference frame like the Proportional Resonant (PR) and the repetitive controller can directly be adopted to regulate the injected grid current [53], [54]. In contrast to the PI-controlled system, there is no need for Park and inverse Park transformations ( $\alpha\beta \rightarrow dq$ ) for the current controllers acting in  $dq$  reference frame. Furthermore, as shown in Fig. 3, the “Multi-functions operation” unit (i.e., the power reference unit) is an objective-determined reference generator for the power control strategy. As a consequence, the power control of multi-functional PV inverters can be achieved by flexibly setting the appropriate power references, in spite of its performance-dependency on the in-quadrature system, as it is shown in Fig. 3. In addition, in the flexible power control strategy, only current controllers have to be designed (i.e., control parameter tuning in the current controllers), which is an advantage of the control strategy from the complexity point of view.

## IV. APPLICATION EXAMPLES

### A. Low Voltage Ride Through

LVRT requirements were firstly introduced to the renewable systems of medium- and high-power ratings (e.g., from tens kilowatts to several megawatts) that connected to medium- or high-voltage grids, e.g., wind turbine systems and utility-scale PV power plants. As the PV penetration level is continuously growing at a rapid rate and also the power rating of an individual PV system is going higher, similar requirements have been extended to and imposed on other PV systems. A shift of those requirements towards next-generation PV systems, covering a wide range of applications from single-phase PV systems of lower power ratings to three-phase higher power PV plants, has been initiated in some countries [7], [12], [14], [15], like Italy, Germany, and Japan, where PV systems have a large share of the electricity generation.

Associated with the fault ride-through, which is defined as the stay-connected time for the grid-connected system in response to voltage faults as exemplified in Fig. 4(a), the reactive current injection has also to be enabled in order to support the voltage recovery [55]. Fig. 4(b) shows an example of the minimum reactive current for medium- and high-voltage systems in response to a voltage sag [7], [13]. As a consequence, the next-generation PV system has to meet two requirements in the case of voltage faults: (a) remain connected to the grid during the transient as what the current wind turbine systems do and (b) provide reactive current to support the voltage recovery especially in the case of a high penetration degree. Both can be implemented in the flexible

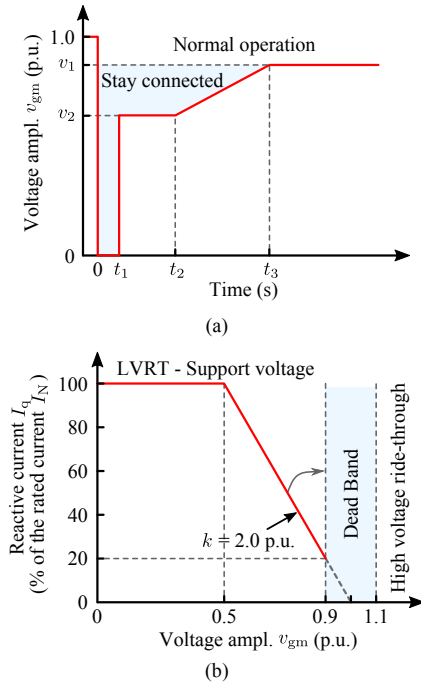

Fig. 4. Fault ride-through requirement: (a) stay-connected time under grid faults and (b) reactive current injection profile in response to the grid voltage faults [13], where  $k = (I_q/I_N)/(1 - v_{gm})$  with  $k \geq 2$  p.u.,  $I_N$  being the rated current,  $I_q$  being the reactive current, and  $v_{gm}$  being the grid voltage amplitude.

power control strategy shown in Fig. 3. Notably, in the case of LVRT for PV systems, the reactive power injection is limited by the PV inverter rating (i.e., the apparent power), as it can be given by

$$\sqrt{P^2 + Q^2} \leq S_{\max} \quad (5)$$

in which  $P$ ,  $Q$  are the injected active power and reactive power according to the voltage level, and  $S_{\max}$  is the inverter maximum apparent power. If the apparent power exceeds  $S_{\max}$ , LVRT operation can not be achieved as the inverter will be triggered due to over-current protection.

Considering the above operation constraints under grid faults, a 1-kW single-phase single-stage grid-connected system has been tested in LVRT operation mode referring to Figs. 1 and 3. It should be pointed out that since the major objective is to test the LVRT of the single-phase PV inverter, a commercial DC source has been adopted instead of PV panels with an assumption that the MPPT control is robust [11]. Other parameters of the system have been given in Table II. A PR current controller with paralleled resonant Harmonic Compensators (HC) has been employed for the grid current control [50]. The current controller  $G_c(s)$  is given as (6), where only the 3<sup>rd</sup>, 5<sup>th</sup>, and 7<sup>th</sup> order harmonics are compensated.

$$G_c(s) = \overbrace{k_p + \frac{k_r s}{s^2 + \omega_0^2}}^{\text{PR}} + \overbrace{\sum_{h=3,5,7} \frac{k_{ih} s}{s^2 + (h\omega_0)^2}}^{\text{HC}} \quad (6)$$

in which  $k_p = 20$ ,  $k_r = 2000$ , and  $k_{ih} = 5000$  are the control gains of the current controller.

Fig. 5(a) shows the performance of the single-phase single-stage system under grid faults with the flexible power control strategy. As it can be observed that, once a voltage fault is confirmed, the system with the power control scheme is able to inject appropriate reactive power according to the demands, which is dependent on the grid voltage level. In the consideration of the inverter rating (the apparent power, cf., (5)), the injection current amplitude is maintained constant during this short-term event. Besides, when the grid fault is cleared, the power control solution can quickly change back to unity power factor operation mode with a maximum active power injection. The test results have demonstrated that the single-phase PV inverter is capable of riding through voltage faults enabled by the flexible power control strategy. It is further verified by the LVRT tests that the operation mode change from MPPT to LVRT or reversely will not challenge the control stability (i.e., the power control scheme is of high robustness).

### B. VAR Operation at Nights

Although double-stage PV inverters can extend the operating hours during a day, there is still a gap at nights where the solar irradiance level is almost 0 kW/m<sup>2</sup> and thus the PV inverters remain idle. Consequently, no active power is available in that period, while the reactive power is not like the case. That is to say, the PV systems can provide reactive power, which can be used to secure the entire grid, since it affects the grid voltage throughout the system at a high penetration level of PV systems. This operation mode is referred to as ‘‘Q at Nights’’ [21], [56]. In addition to reactive power operation at nights, there is a room for most PV inverters to provide reactive power compensation even in the day-time operations [56]–[58], since the PV inverters are rarely operating at the rated power levels and thereby utilize the capability of the power devices. The maximum available reactive power  $|Q_{\max}|$  can be determined by

$$|Q_{\max}| = \sqrt{S_{\max}^2 - P_{\text{ins}}^2} \quad (7)$$

where  $P_{\text{ins}}$  is the instantaneous active power and  $S_{\max}$  has been defined previously. Considering the reactive power constraint of a PV inverter shown in (7), the flexible power control strategy can enable the VAR operation mode of PV systems at nights. However, the key to the implementation of this function is to monitor the available active power, and thus to determine the start of the VAR operation (e.g.,  $P_{\text{ins}} = 5\% P_{\text{MPP}}$  with MPP denoting the Maximum Power Point). In addition, if too much reactive power is injected by the PV systems, the line voltage may rise. In that case, the voltage management should be coordinated between the PV systems and the grid. Those require advanced monitoring, forecasting, and communication technologies.

Fig. 5(b) shows the performance of the flexible power control strategy for a single-phase PV system in the VAR injection mode, where the solar irradiance is very weak. It can be seen that the power control strategy can effectively enable the PV system to inject reactive power when the solar irradiance level is very low (and thus the active power is

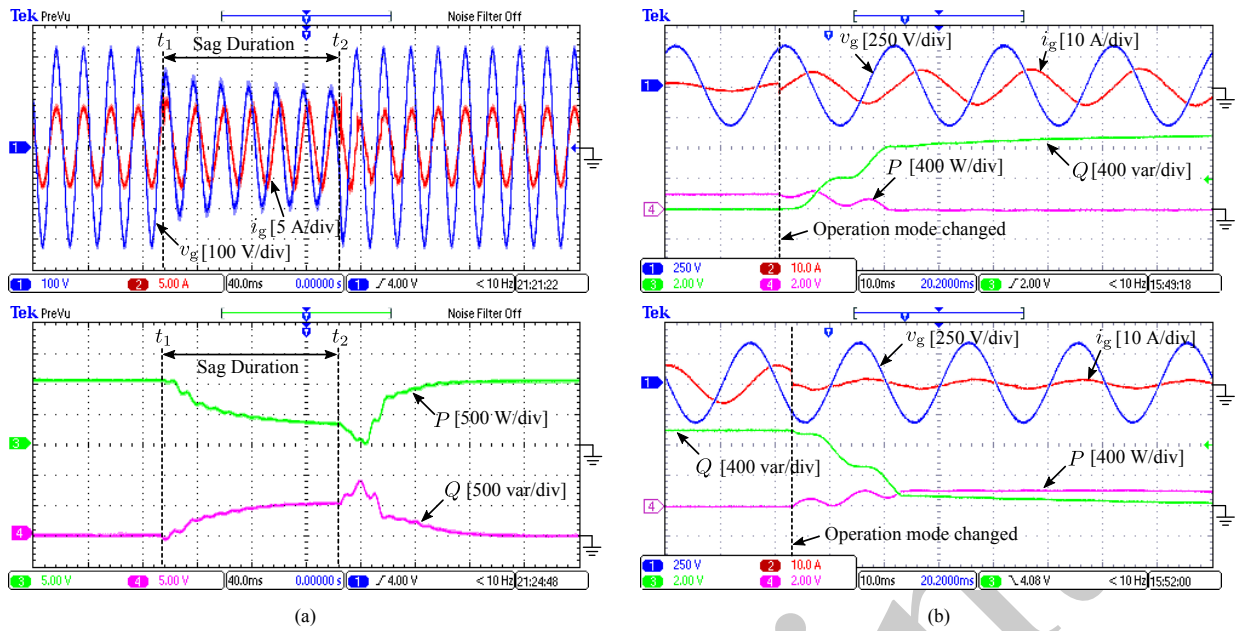

Fig. 5. Experimental tests of a 1-kW single-phase single-stage grid-connected PV system (see Fig. 1(a), grid voltage -  $v_g$ , grid current -  $i_g$ , active power -  $P$ , reactive power -  $Q$ ): (a) low voltage ride-through operation (0.43 p.u. voltage sag) and (b) VAR operation representing the “Q at Night” operation (top: start of VAR operation, bottom: end of VAR operation), where the flexible control strategy shown in Fig. 3 was employed.

also low) or vice versa. However, when the PV inverter is operating in the VAR injection mode at nights, an additional power loss and thus thermal stress on the power devices will appear in the PV inverter [21], [36], [59]. The increased thermal loading can accelerate the device degradation, and thus increase maintenance cost. For example, Fig. 6 demonstrates the thermal performance of a 3-kW single-phase single-stage PV system operating with and without VAR injection at nights. It can be observed from Fig. 6 that the average device junction temperature is increased. Additionally, the number of temperature cycles is also increased due to the injection of reactive power, which can be quantified using a rainflow counting algorithm [60]. Both increases will contribute to a reduced lifetime [21], [35], [37], [60]. However, when compared to the costs for conventional compensation plants/devices, the investment costs brought by PV systems in the VAR injection at nights might still be lower [59] although the devices are “heated-up”. Therefore, a research perspective regarding VAR operation at nights for PV systems can be directed to a detailed thermal loading analysis under different VAR injection levels, so that a tradeoff between the PV inverter reliability and the savings for reactive power compensations. Besides, further in-depth investigations of the reactive power compensation effect on the distributed grid should be conducted considering the interactions between the paralleled PV inverters.

### C. Constant Active Power Generation Control

Overloading of the line is a significant issue brought by a high penetration degree of PV systems operating at sunny days where the solar irradiance is quite strong [31], [33], [34]. It has been reported that parts of the Northern Ireland had an experience of overloading during the peak power production periods in 2013 [61]. Thus, measures should be taken to

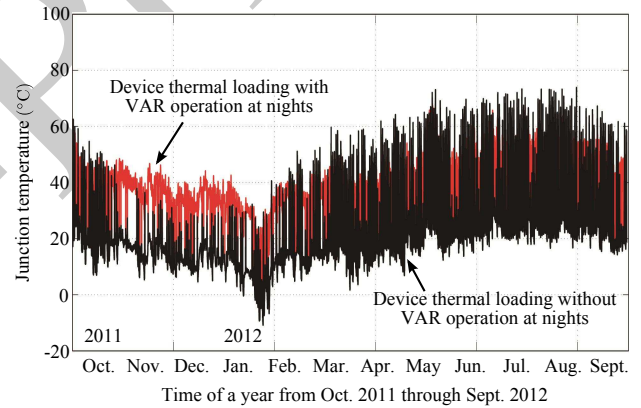

Fig. 6. Thermal loading (power device junction temperature) of a 3-kW single-phase single-stage grid-connected PV system Fig. 1(a) with and without VAR operation at nights through an entire year (from October 2011 to September 2012).

tackle this issue associated with the increase of PV or other renewable energy systems. For example, expanding the grid by means of upgrading the power infrastructure is one solution [62], [63]; or installing energy buffers (e.g., energy storage systems) in the systems to store the surplus energy during peak power generation periods [64], [65], but both resulting in more investment. However, it is common to us that the PV systems are rarely operating at its rated power through a year [31], [33]. As a consequence, it is feasible to limit the PV output power at a certain level so as to mitigate the overloading issue, which in return allows more PV installations in the grid. This is called “Constant Power Generation (CPG)” control, and also referred to as absolute active power control. Actually, the CPG control is one of the active power constraints defined in the Danish grid codes for wind turbine systems [66]. These active

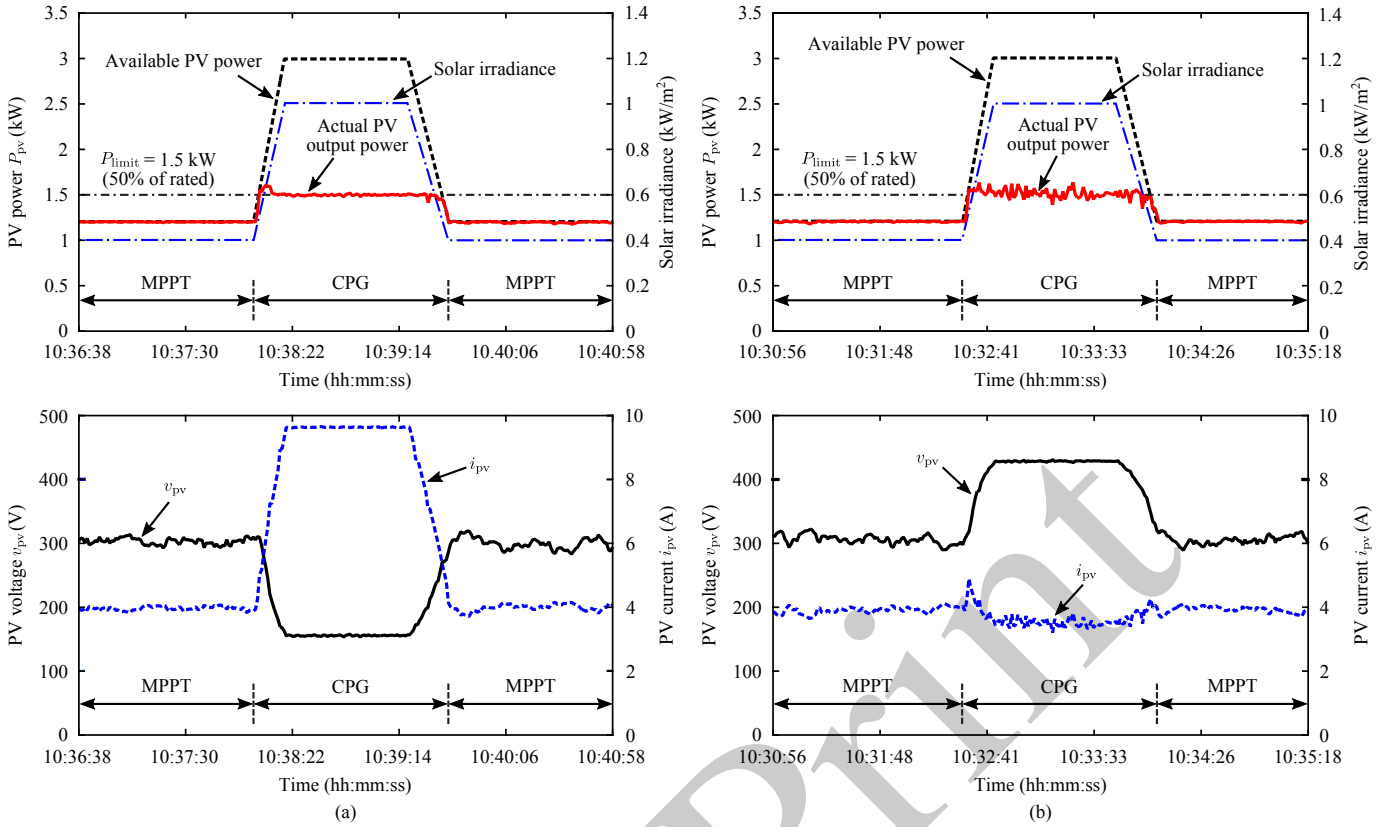

Fig. 7. Experimental results of a 3-kW single-phase double-stage PV system of Fig. 1(b) with the constant power generation control under a fast solar irradiance change (top: PV output power and solar irradiance profile, bottom: PV voltage and current), where the power limit is set to be 50 % of the rated power (i.e.,  $P_{\text{limit}} = 1.5$  kW) and the ambient temperature is 25 °C: (a) when operating point is on the left of the MPP and (b) when operating point is on the right of the MPP.

power control functions will be extended to PV systems [32], and they can be implemented in the flexible power control strategy as well. In respect to the CPG control, there are several ways to implement it. For instance, a constant power output can be achieved at a system level in a highly PV-penetrated system by an appropriate power management. It can also be attained at the MPPT control level, where a power limiter or voltage limiter is added. Alternatively, directly changing the operation mode can contribute to a stable CPG operation [33]. In the following, the CPG control is demonstrated on a 3-kW single-phase double-stage system as shown in Fig. 1(b), where a Perturb and Observe (P&O) MPPT algorithm is used and it is modified during CPG operation in order to achieve the performance. In the case, the PV output power  $P_o$  can be expressed as,

$$P_o = \begin{cases} P_{\text{PV}}(t), & \text{when } P_{\text{PV}}(t) < P_{\text{limit}}, \text{ MPPT mode} \\ P_{\text{limit}}, & \text{when } P_{\text{PV}}(t) \geq P_{\text{limit}}, \text{ CPG mode} \end{cases} \quad (8)$$

in which  $P_{\text{PV}}(t)$  is the instantaneous power of the PV system with the P&O MPPT control, and  $P_{\text{limit}}$  is the power limitation (e.g., 50 % or 80 % of the rated power).

First, the CPG control was tested on a 3-kW single-phase two-stage PV system under a fast change in the solar irradiance, where the ambient temperature is 25 °C. The test results are presented in Fig. 7, which shows the solar irradiance changed from 400 W/m<sup>2</sup> to 1000 W/m<sup>2</sup> within 15 s, and back

to 400 W/m<sup>2</sup> in 20 s. Since a boost converter is used, it should be pointed out that the PV system can operate either on the right of the MPP or the left of the MPP according to the PV characteristics. In both cases (i.e., the operating point is controlled either at the right side of the MPP or the left side of the MPP), the output power of the PV system can effectively be regulated to the set-point (e.g., 50% of the rated) by the flexible power controller. Furthermore, it can be observed in Fig. 7, when the operating point is at the right-side of the MPP, there will be large power oscillations due to the high  $dp/dv$  in that region. Nevertheless, the tests confirmed the effectiveness and the robustness of the flexible power controller for the CPG control scheme.

In addition, Fig. 8 shows more experimental tests of the 3-kW single-phase double-stage PV systems operating at the CPG mode. In this case, the solar irradiance changed from 400 W/m<sup>2</sup> to 1000 W/m<sup>2</sup> within 60 s, and back to 400 W/m<sup>2</sup> in 60 s. It can be observed in Fig. 8(a) that the response speed is slow when the operating point is on the left while the steady state accuracy is high. In contrast, when the system operating point is on the right during CPG operation, the steady state accuracy is poor due to the high  $dp/dv$  and a fast response is achieved. This is in agreement with the previous test shown in Fig. 7. Moreover, as long as the solar irradiance is lower (i.e., available power is less than the power limit – 2.4 kW), the PV system goes back to MPPT control with a relatively high accuracy and a fast speed. In all, the test results in Figs.



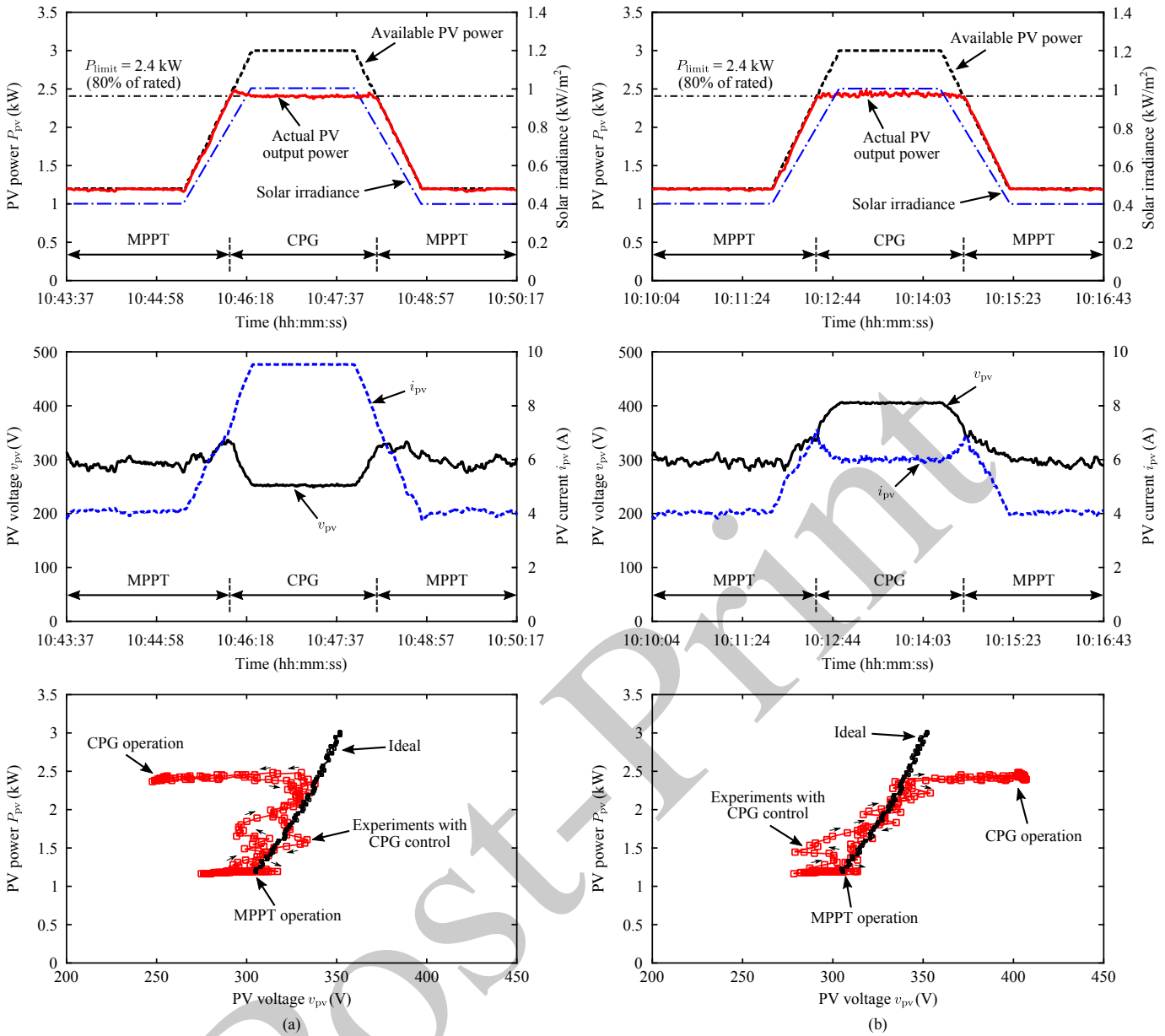

Fig. 8. Experimental results of a 3-kW single-phase double-stage PV system of Fig. 1(b) with the constant power generation control under a slow solar irradiance change (top: PV output power and solar irradiance profile, middle: PV voltage and current, bottom: PV voltage v.s. PV power), where the power limit is set to be 80 % of the rated power (i.e.,  $P_{\text{limit}} = 2.4$  kW) and the ambient temperature is 25 °C: (a) when operating point is on the left of the MPP and (b) when operating point is on the right of the MPP.

7 and 8 show the control power flexibility of single-phase PV systems using the power control strategy.

#### D. Power Control to Enhance Reliability

Since the thermal stress on the power switching devices will induce additional power losses and may cause the device fail to operate, reliability-oriented design and control of power electronics converters (e.g. PV inverters) have become of high interest [21], [33], [35], [55], [67]. It is also observed in the power electronics applications that temperature peaks and variations appearing on the power electronics devices are more challenging to the reliability [35], [37], [68]. Hence, a stable junction temperature with small variations is desirable from

the reliability point of view in power electronics applications. Due to the coupled relationship between power losses and junction temperatures, it is possible to control or manage the device temperature by appropriately allocating the active power and reactive power distributions in the power converters. The feasibility of this temperature control strategy is demonstrated by the experimental tests on a three level Neutral Point Clamped (NPC) PV inverter as it is shown in Fig. 9(a), which illustrates that the device junction temperature has a relatively linear relationship with the power factor (i.e., the power allocation). As a consequence, it is possible to control the junction temperature of the power electronics devices through appropriate power control and the control can be implemented in the flexible power control strategy shown in

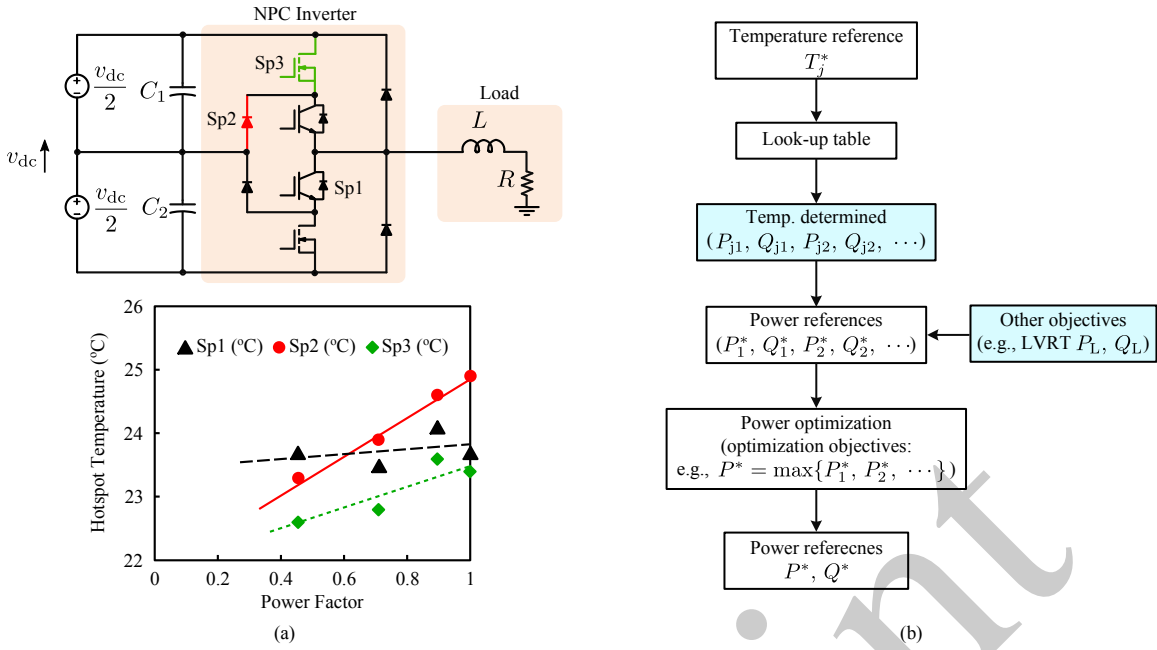

Fig. 9. Enhancing the reliability of PV inverters through the flexible power control strategy in Fig. 3 (i.e., junction temperature control scheme): (a) feasibility tests on a single-phase three-level Neutral Point Clamped (NPC) PV inverter under different power factors (top: experimental setup, bottom: test results) and (b) flow-chart of the junction temperature control method.

Fig. 3. Therefore, the flexible power control strategy offers a possibility to enhance the reliability of the power electronics devices, and thus to reduce the cost of PV energy.

The flow-chart of the junction temperature control through the flexible power control is further illustrated in Fig. 9(b), which shows the possibility to achieve multiple objectives at the same time (e.g., a desirable constant junction temperature and the fault ride-through operation). In that case, the power references for different control objectives (e.g.,  $P_{j1}^*$ ,  $Q_{j1}^*$ ,  $P_{j2}^*$ ,  $Q_{j2}^*$ , ..., and  $P_L^*$ ,  $Q_L^*$ ) have to be optimized. Specifically, as an example, the PV system is operating at the LVRT mode and at the same time a constant junction temperature is also desired. In that case, a minimum reactive power dependent on the voltage sag levels has to be injected to the grid, as discussed in § IV.A. If the maximum PV power is also injected to the grid, the junction temperature will rise due to the increased power losses. Hence, the active power has to be reduced in order to maintain a constant junction temperature as it is in the pre-sag condition. Clearly, the active power and reactive power reference can be set through the flexible power control scheme shown in Fig. 3. The key to the implementation of the temperature control scheme is to create a proper look-up table, which maps the junction temperature with the active power and reactive power, as it has been achieved in [37].

In order to demonstrate the flexibility of the power control method in terms of temperature management, a 1-kW single-phase single-stage PV system has been simulated under grid faults, where a constant junction temperature is also enabled through the operation. The control system is shown in Figs. 1 and 3. The results, which are given in Fig. 10, have confirmed that, with the flexible power control, the junction temperature of the power devices is maintained constant during the fault ride through, and sufficient reactive power is also injected to

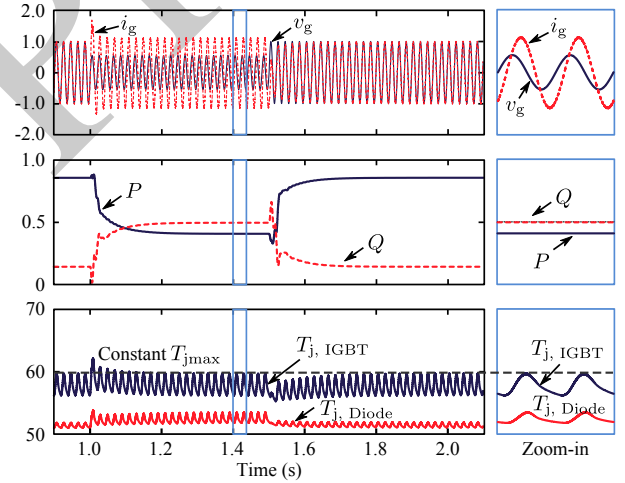

Fig. 10. Simulation results of a 1 kW single-phase single-stage grid-connected PV system under a grid fault with the junction temperature control (0.45 p.u. voltage sag, i.e.,  $v_{gm} = 0.55$  p.u.): top: grid current  $i_g$  [p.u.] and grid voltage  $v_g$  [p.u.], middle: active power  $P$  [p.u.] and reactive power  $Q$  [p.u.], and bottom: junction temperature of the power devices  $T_j$  [°C].

support the voltage recovery as required, as long as the power references are generated appropriately. Nonetheless, according to the above discussions, multiple functions of PV inverters have been achieved by the flexible power control strategy, which is verified by the experimental case-studies.

## V. CONCLUSION

The integration issues of next-generation PV systems have been presented in order to achieve a smooth and grid-friendly integration of large-scale PV systems. The power control flexibilities based on single-phase  $PQ$  theory have been focused

on and explored in this paper. The introduced control strategy can be an enhancement for the future PV inverters, and it offers a flexible power controllability to enable intelligent services from multi-functional PV systems. Selected cases for single-phase PV systems have demonstrated the effectiveness and flexibility of the power control strategy. It has been shown that an implementation of such flexible power control strategy is strongly dependent on the performance of the built-up in-quadrature system. An alternative to flexible power control especially for single-phase PV systems based on the Conservative Power Theory (CPT) is ascertained in recent studies [69]–[72]. This could be an attractive solution for grid-friendly PV inverters, as the CPT offers more terms to flexibly control, e.g., harmonic compensation, reactive power compensation, and active power injection.

#### ACKNOWLEDGMENT

The authors would like to sincerely acknowledge Mr. Ariya Sangwongwanich from the Department of Energy Technology, Aalborg University and Mr. Anup Anurag from the Department of Electrical Engineering and Information Technology, Swiss Federal Institute of Technology (ETH, Zurich) for parts of the experimental tests.

#### REFERENCES

- [1] REN21, "Renewables 2015 - Global status report," Tech. Report, Online Available: [www.ren21.net](http://www.ren21.net), 2015.
- [2] I. Clover, "European council ups 2030 renewables target to 30%," Press Release (PV Magazine), Online Available: [www.pv-magazine.com](http://www.pv-magazine.com), 3 Sept. 2014.
- [3] B. Azzopardi and J. Mutale, "Smart integration of future grid-connected PV systems," in *Proc. of 34th IEEE Photovoltaic Specialists Conference (PVSC)*, pp. 2364–2369, Jun. 2009.
- [4] R. G. Wandhare and V. Agarwal, "Reactive power capacity enhancement of a PV-grid system to increase PV penetration level in smart grid scenario," *IEEE Trans. Smart Grid*, vol. 5, no. 4, pp. 1845–1854, Jul. 2014.
- [5] K.D. McBee and M.G. Simoes, "General smart meter guidelines to accurately assess the aging of distribution transformers," *IEEE Trans. Smart Grid*, vol. 5, no. 6, pp. 2967–2979, Nov. 2014.
- [6] H. El-Kanj Baitie and T. Selmi, "Review of smart grid systems' requirements," in *Proc. of EVER'15*, Mar. 2015, pp. 1–6.
- [7] Y. Yang, P. Enjeti, F. Blaabjerg, and H. Wang, "Wide-scale adoption of photovoltaic energy: Grid code modifications are explored in the distribution grid," *IEEE Ind. Appl. Mag.*, vol. 21, no. 5, pp. 21–31, Sept.–Oct. 2015.
- [8] Y. Yang, "Advanced control strategies to enable a more wide-scale adoption of single-phase photovoltaic systems," Ph.D. dissertation, Department of Energy Technology, Aalborg University, Aug. 2014.
- [9] M. Morjaria, D. Anichkov, V. Chadliev, and S. Soni, "A grid-friendly plant: The role of utility-scale photovoltaic plants in grid stability and reliability," *IEEE Power and Energy Mag.*, vol. 12, no. 3, pp. 87–95, May 2014.
- [10] F. Lamberti, V. Calderaro, V. Galdi, A. Piccolo, and G. Graditi, "Impact analysis of distributed PV and energy storage systems in unbalanced LV networks," in *Proc. of IEEE PowerTech*, pp. 1–6, Jun. 2015.
- [11] Y. Yang, F. Blaabjerg, and H. Wang, "Low-voltage ride-through of single-phase transformerless photovoltaic inverters," *IEEE Trans. Ind. Appl.*, vol. 50, no. 3, pp. 1942–1952, May 2014.
- [12] H. Kobayashi, "Fault ride through requirements and measures of distributed PV systems in japan," in *Proc. of PES General Meeting*, pp. 1–6, Jul. 2012.
- [13] Y. Bae, T.-K. Vu, and R.-Y. Kim, "Implemental control strategy for grid stabilization of grid-connected PV system based on German grid code in symmetrical low-to-medium voltage network," *IEEE Trans. Energy Conversion*, vol. 28, no. 3, pp. 619–631, Sept. 2013.
- [14] N. P. Papanikolaou, "Low-voltage ride-through concept in flyback inverter based alternating current photovoltaic modules," *IET Power Electron.*, vol. 6, no. 7, pp. 1436–1448, Aug. 2013.
- [15] G. Dotter, F. Ackermann, N. Bihler, R. Grab, S. Rogalla, and R. Singer, "Stable operation of PV plants to achieve fault ride through capability - Evaluation in field and laboratory tests," in *Proc. of PEDG'14*, pp. 1–8, 2014.
- [16] G. Ding, F. Gao, H. Tian, C. Ma, M. Chen, G. He, and Y. Liu, "Adaptive DC-link voltage control of two-stage photovoltaic inverter during low voltage ride-through operation," *IEEE Trans. Power Electron.*, vol. PP, no. 99, pp. 1–12, DOI: 10.1109/TPEL.2015.2469603, 2015.
- [17] Y. Chen, C. Tang, and Y. Chen, "PV power system with multi-mode operation and low-voltage ride-through capability," *IEEE Trans. Ind. Electron.*, vol. PP, no. 99, pp. 1–10, DOI: 10.1109/TIE.2015.2449777, 2015.
- [18] L. Liu, H. Li, Y. Xue, and W. Liu, "Reactive power compensation and optimization strategy for grid-interactive cascaded photovoltaic systems," *IEEE Trans. Power Electron.*, vol. 30, no. 1, pp. 188–202, Jan. 2015.
- [19] M. N. Kabir, Y. Mishra, G. Ledwich, Z. Y. Dong, and K. P. Wong, "Coordinated control of grid-connected photovoltaic reactive power and battery energy storage systems to improve the voltage profile of a residential distribution feeder," *IEEE Trans. Ind. Informat.*, vol. 10, no. 2, pp. 967–977, May 2014.
- [20] R.G. Wandhare and V. Agarwal, "Reactive power capacity enhancement of a PV-grid system to increase PV penetration level in smart grid scenario," *IEEE Trans. Smart Grid*, vol. 5, no. 4, pp. 1845–1854, Jul. 2014.
- [21] A. Anurag, Y. Yang, and F. Blaabjerg, "Thermal performance and reliability analysis of single-phase PV inverters with reactive power injection outside feed-in operating hours," *IEEE J. Emerg. Sel. Top. Power Electron.*, vol. 3, no. 4, pp. 870–880, Dec. 2015.
- [22] D. G. Infield, P. Onions, A. D. Simmons, and G. A. Smith, "Power quality from multiple grid-connected single-phase inverters," *IEEE Trans. Power Del.*, vol. 19, no. 4, pp. 1983–1989, Oct. 2004.
- [23] P. Acuna, L. Moran, M. Rivera, J. Dixon, and J. Rodriguez, "Improved active power filter performance for renewable power generation systems," *IEEE Trans. Power Electron.*, vol. 29, no. 2, pp. 687–694, Feb. 2014.
- [24] J. He, Y. W. Li, F. Blaabjerg, and X. Wang, "Active harmonic filtering using current-controlled, grid-connected DG units with closed-loop power control," *IEEE Trans. Power Electron.*, vol. 29, no. 2, pp. 642–653, Feb. 2014.
- [25] R. A. Mastromauro, M. Liserre, T. Kerekes, and A. Dell'Aquila, "A single-phase voltage controlled grid connected photovoltaic system with power quality conditioner functionality," *IEEE Trans. Ind. Electron.*, vol. 56, no. 11, pp. 4436–4444, Nov. 2009.
- [26] E. Romero-Cadaval, B. Francois, M. Malinowski, and Q. Zhong, "Grid-connected photovoltaic plants: An alternative energy source, replacing conventional sources," *IEEE Ind. Electron. Mag.*, vol. 9, no. 1, pp. 18–32, Mar. 2015.
- [27] M. Patsalides, V. Efthymiou, A. Stavrou, and G. E. Georghiou, "Simplified distribution grid model for power quality studies in the presence of photovoltaic generators," *IET Renew. Power Gener.*, vol. 9, no. 6, pp. 618–628.
- [28] B. Craciun, T. Kerekes, D. Sera, and R. Teodorescu, "Frequency support functions in large PV power plants with active power reserves," *IEEE J. Emerg. Sel. Top. Power Electron.*, vol. 2, no. 4, pp. 849–858, Dec. 2014.
- [29] M. Datta, T. Senjyu, A. Yona, T. Funabashi, and C.-H. Kim, "A frequency-control approach by photovoltaic generator in a PV-diesel hybrid power system," *IEEE Trans. Energy Conversion*, vol. 26, no. 2, pp. 559–571, Jun 2011.
- [30] M. I. Marei and M. H. Soliman, "A coordinated voltage and frequency control of inverter based distributed generation and distributed energy storage system for autonomous microgrids," *Electric Power Components and Systems*, vol. 41, no. 4, pp. 383–400, 2013.
- [31] Fraunhofer ISE, "Recent facts about photovoltaics in Germany," Fraunhofer Inst. Sol. Energy Syst., Freiburg, Germany, Tech. Report, [Online]. Available: [www.pv-fakten.de](http://www.pv-fakten.de), 19 May 2015.
- [32] A. Hoke and D. Maksimovic, "Active power control of photovoltaic power systems," in *Proc. of SusTech*, pp. 70–77, Aug. 2013.
- [33] Y. Yang, H. Wang, F. Blaabjerg, and T. Kerekes, "A hybrid power control concept for PV inverters with reduced thermal loading," *IEEE Trans. Power Electron.*, vol. 29, no. 12, pp. 6271–6275, [Open Access], Dec. 2014.

- [34] A. Sangwongwanich, Y. Yang, and F. Blaabjerg, "High-performance constant power generation in grid-connected PV systems," *IEEE Trans. Power Electron.*, vol. 31, no. 3, pp. 1–4, Mar. 2016.
- [35] H. Huang and P. A. Mawby, "A lifetime estimation technique for voltage source inverters," *IEEE Trans. Power Electron.*, vol. 28, no. 8, pp. 4113–4119, Aug. 2013.
- [36] K. Ma, M. Liserre, and F. Blaabjerg, "Reactive power influence on the thermal cycling of multi-MW wind power inverter," *IEEE Trans. Ind. Appl.*, vol. 49, no. 2, pp. 922–930, Mar. 2013.
- [37] Y. Yang, H. Wang, and F. Blaabjerg, "Reduced junction temperature control during low-voltage ride-through for single-phase photovoltaic inverters," *IET Power Electron.*, vol. 7, no. 8, pp. 2050–2059, Aug. 2014.
- [38] W. Xiao, K. Torchyian, M. S. El Moursi, and J. Kirtley, "Online supervisory voltage control for grid interface of utility-level PV plants," *IEEE Trans. Sustain. Energy*, vol. 5, no. 3, pp. 843–853, Jul. 2014.
- [39] Z. Ziadi, M. Oshiro, T. Senjyu, A. Yona, N. Urasaki, T. Funabashi, and C.-H. Kim, "Optimal voltage control using inverters interfaced with PV systems considering forecast error in a distribution system," *IEEE Trans. Sustain. Energy*, vol. 5, no. 2, pp. 682–690, April 2014.
- [40] T. Senjyu, M. Datta, A. Yona, and C.-H. Kim, "A control method for small utility connected large PV system to reduce frequency deviation using a minimal-order observer," *IEEE Trans. Energy Conversion*, vol. 24, no. 2, pp. 520–528, Jun. 2009.
- [41] H. Xin, Y. Liu, Z. Wang, D. Gan, and T. Yang, "A new frequency regulation strategy for photovoltaic systems without energy storage," *IEEE Trans. Sustain. Energy*, vol. 4, no. 4, pp. 985–993, Oct. 2013.
- [42] E. Koutroulis and F. Blaabjerg, "Design optimization of transformerless grid-connected PV inverters including reliability," *IEEE Trans. Power Electron.*, vol. 28, no. 1, pp. 325–335, Jan. 2013.
- [43] S. Harb and R. S. Balog, "Reliability of candidate photovoltaic module-integrated-inverter (PV-MII) topologies - a usage model approach," *IEEE Trans. Power Electron.*, vol. 28, no. 6, pp. 3019–3027, Jun. 2013.
- [44] T.-F. Wu, H.-S. Nien, H.-M. Hsieh, and C.-L. Shen, "PV power injection and active power filtering with amplitude-clamping and amplitude-scaling algorithms," *IEEE Trans. Ind. Appl.*, vol. 43, no. 3, pp. 731–741, May 2007.
- [45] K. C. A. De Souza and D. C. Martins, "A single-phase active power filter based in a two stages grid-connected PV system," in *Proc. of EPE-PEMC*, pp. 1951–1956, Sept. 2008.
- [46] M. Saitou and T. Shimizu, "Generalized theory of instantaneous active and reactive powers in single-phase circuits based on Hilbert transform," in *Proc. of PESC*, vol. 3, pp. 1419–1424, 2002.
- [47] R. H. Lasseter, "Microgrids," in *Proc. of IEEE PES Winter Meeting*, vol. 1, pp. 305–308, 2002.
- [48] K. De Brabandere, B. Bolsens, J. Van den Keybus, A. Woyte, J. Driesen, and R. Belmans, "A voltage and frequency droop control method for parallel inverters," *IEEE Trans. Power Electron.*, vol. 22, no. 4, pp. 1107–1115, Jul. 2007.
- [49] R. Teodorescu, M. Liserre, and P. Rodriguez, *Grid converters for photovoltaic and wind power systems*. John Wiley & Sons, 2011.
- [50] M. Ciobotaru, R. Teodorescu, and F. Blaabjerg, "Control of single-stage single-phase PV inverter," in *Proc. of EPE*, pp. P.1-P.10, 2005.
- [51] H. Akagi, E. H. Watanabe, and M. Aredes, *Instantaneous power theory and applications to power conditioning*. John Wiley & Sons, 2007.
- [52] Y. Yang and F. Blaabjerg, "A new power calculation method for single-phase grid-connected systems," in *Proc. of ISIE*, pp. 1–6, May 2013.
- [53] F. Blaabjerg, R. Teodorescu, M. Liserre, and A.V. Timbus, "Overview of control and grid synchronization for distributed power generation systems," *IEEE Trans. Ind. Electron.*, vol. 53, no. 5, pp. 1398–1409, Oct. 2006.
- [54] Y. Yang, K. Zhou, and F. Blaabjerg, "Frequency adaptability of harmonics controllers for grid-interfaced converters," *International Journal of Control*, pp. 1–12, DOI: 10.1080/00207179.2015.1022957, 2015.
- [55] Y. Yang, H. Wang, and F. Blaabjerg, "Reactive power injection strategies for single-phase photovoltaic systems considering grid requirements," *IEEE Trans. Ind. Appl.*, vol. 50, no. 6, pp. 4065–4076, Nov. 2014.
- [56] SMA, "Profitable night shift," Technical Information, Online Available: [www.sma.de](http://www.sma.de), Mar. 2013.
- [57] A. D. Dominguez-Garcia, C. N. Hadjicostis, P. T. Krein, and S. T. Cady, "Small inverter-interfaced distributed energy resources for reactive power support," in *Proc. of APEC*, pp. 1616–1621, Mar. 2011.
- [58] H.-G. Yeh, D. F. Gayme, and S. H. Low, "Adaptive VAR control for distribution circuits with photovoltaic generators," *IEEE Trans. Power Sys.*, vol. 27, no. 3, pp. 1656–1663, Aug. 2012.
- [59] SMA, "Q at Night - reactive power outside of feed-in operation with the CP XT production series," Technical Information, Online Available: [www.sma.de](http://www.sma.de), 2013.
- [60] M. Musallam and C. M. Johnson, "An efficient implementation of the rainflow counting algorithm for life consumption estimation," *IEEE Trans. Reliability*, vol. 61, no. 4, pp. 978–986, Dec. 2012.
- [61] D. Maxwell, "Parts of Northern Ireland's electricity grid overloaded," *BBC News*, [Online]. Available: <http://www.bbc.co.uk/>, 13 Nov. 2013.
- [62] D. Rosenwirth and K. Strubbe, "Integrating variable renewables as Germany expands its grid," [Online]. Available: <http://www.renewableenergyworld.com/>, Mar. 2013.
- [63] T. Thien, R. Alvarez, Z. Cai, P. Awater, M. Leuthold, A. Moser, and D.U. Souer, "Storage- and grid expansion needs in a European electricity-supply-system with a high share of renewable energy," in *Proc. of IRES'12*, pp. 656–663, Nov. 2012.
- [64] H. Beltran, E. Bilbao, E. Belenguier, I. Etxeberria-Otadui, and P. Rodriguez, "Evaluation of storage energy requirements for constant production in PV power plants," *IEEE Trans. Ind. Electron.*, vol. 60, no. 3, pp. 1225–1234, 2013.
- [65] H. Beltran, E. Perez, N. Aparicio, and P. Rodriguez, "Daily solar energy estimation for minimizing energy storage requirements in PV power plants," *IEEE Trans. Sustain. Energy*, vol. 4, no. 2, pp. 474–481, 2013.
- [66] ENERGINET.DK, "Wind power plants with a power output greater than 11 kW," *Technical Regulation 3.2.5*, Sept. 2010.
- [67] H. Wang, M. Liserre, F. Blaabjerg, P. de Place Rimmen, J. B. Jacobsen, T. Kvisgaard, and J. Landkildehus, "Transitioning to physics-of-failure as a reliability driver in power electronics," *IEEE J. Emerg. Sel. Top. Power Electron.*, vol. 2, no. 1, pp. 97–114, Mar. 2014.
- [68] T. Bruckner and S. Bernet, "Estimation and measurement of junction temperatures in a three-level voltage source converter," *IEEE Trans. Power Electron.*, vol. 22, no. 1, pp. 3–12, 2007.
- [69] P. Tenti, H. K. M. Paredes, and P. Mattavelli, "Conservative power theory, a framework to approach control and accountability issues in smart microgrids," *IEEE Trans. Power Electron.*, vol. 26, no. 3, pp. 664–673, Mar. 2011.
- [70] A. Mortezaei, C. Lute, M. G. Simões, F. P. Marafão, and A. Boglia, "PQ, DQ and CPT control methods for shunt active compensators - A comparative study," in *Proc. of ECCE*, pp. 2994–3001, Sept. 2014.
- [71] T. D. C. Busarello and J. Antenor Pomilio, "Bidirectional multilevel shunt compensator with simultaneous functionalities based on the conservative power theory," in *Proc. of PEMD*, pp. 1–6, Apr. 2014.
- [72] M. G. Simoes, T. D. C. Busarello, A. S. Bubshait, F. Harichi, J. A. Pomilio, and F. Blaabjerg, "Interactive smart battery storage for a PV and wind hybrid energy management control based on conservative power theory," *International Journal of Control*, in press, DOI: 10.1080/00207179.2015.1102971, 2016.