



AALBORG UNIVERSITY
DENMARK

Aalborg Universitet

EHV/HV Underground Cable Systems for Power Transmission

Bak, Claus Leth

Publication date:
2015

Document Version
Peer reviewed version

[Link to publication from Aalborg University](#)

Citation for published version (APA):

Bak, C. L. (2015). EHV/HV Underground Cable Systems for Power Transmission. Department of Energy Technology, Aalborg University.

General rights

Copyright and moral rights for the publications made accessible in the public portal are retained by the authors and/or other copyright owners and it is a condition of accessing publications that users recognise and abide by the legal requirements associated with these rights.

- ? Users may download and print one copy of any publication from the public portal for the purpose of private study or research.
- ? You may not further distribute the material or use it for any profit-making activity or commercial gain
- ? You may freely distribute the URL identifying the publication in the public portal ?

Take down policy

If you believe that this document breaches copyright please contact us at vbn@aub.aau.dk providing details, and we will remove access to the work immediately and investigate your claim.

PhD Dissertation Defense

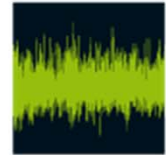
Pontoppidanstræde 101, Aalborg, March 27, 2015.



EHV/HV Underground Cable Systems for Power Transmission

Claus Leth Bak

Supervisor: Head of Department John K. Pedersen



Major acknowledgement

This PhD defense lecture is a tribute to more than a decade of underground transmission cable research for Energinet.dk and Department of Energy Technology

ELSAM

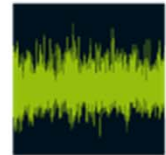
eltra

ENERGINET/DK



DEPARTMENT OF ENERGY TECHNOLOGY
AALBORG UNIVERSITY

Research results have been proven useful for society



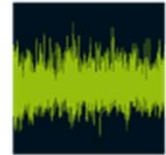
Acknowledgement



DEPARTMENT OF ENERGY TECHNOLOGY
AALBORG UNIVERSITY

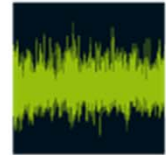


- My numerous professionally very skilled and good colleagues at Energinet.dk
- My colleagues at the Department of Energy Technology at Aalborg University
- Dr Wojciech Wiechowski, Dr Søren Damsgaard Mikkelsen and MSc Kim Søggaard for being the forward-looking initiators of cable research
- My co-authors of the publications
- Anyone with whom I have had professional cooperation in High Voltage and Power Systems throughout the years
- The assessment committee for assessing the thesis and conducting the defense
- Professor Frede Blaabjerg for good advice and source of inspiration
- Head of department associate prof. John K. Pedersen for supporting this process
- Head of doctoral school professor Dr Tech. Torben Larsen for valuable guidance
- My very good, close colleague associate professor Filipe Faria da Silva for always brilliant and ingenious contributions to our common work



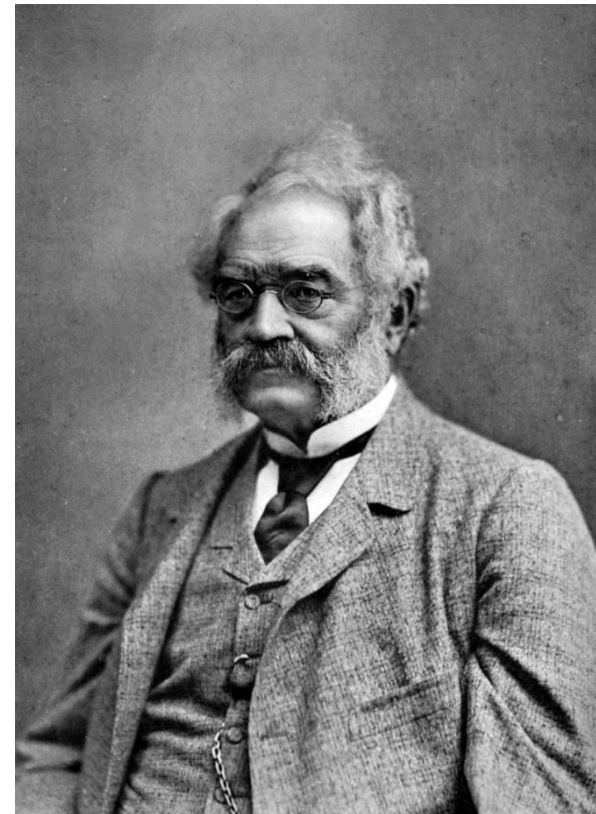
Outline

- Introduction to the challenges of using underground cables in the transmission network
- Main hypothesis and “how to”
- Modelling of underground cable systems
- Dynamic studies for underground cable systems
 - Resonances
 - Fault clearing
 - Energisation
 - De-energisation
 - Zero-miss
- Harmonics in cable based transmission systems
- Modeling depth and systematic approach
- Protection of underground cable systems
- Fault location in underground cable systems
- Conclusions
 - Conclusions and future works in a broader perspective
 - Main hypothesis – final remark
 - Scientific contributions
 - Publications



Philosophy – why research?

*DIE MODERNE KULTUR BERUHT AUF DER
HERRSCHAFT DES MENSCHEN ÜBER DIE
NATURKRÄFTE
UND JEDES NEU ERKANNTENATURGESETZ
VERGRÖßERT DIESE HERRSCHAFT
UND DAMIT DIE HÖCHSTEN GÜTER UNSERES
GESCHLECHTES*



From Wikipedia, photo by Giacomo Brogi

Werner von Siemens



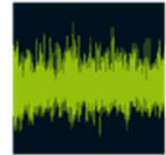
Introduction – power transmission

This is what people usually DON'T like !



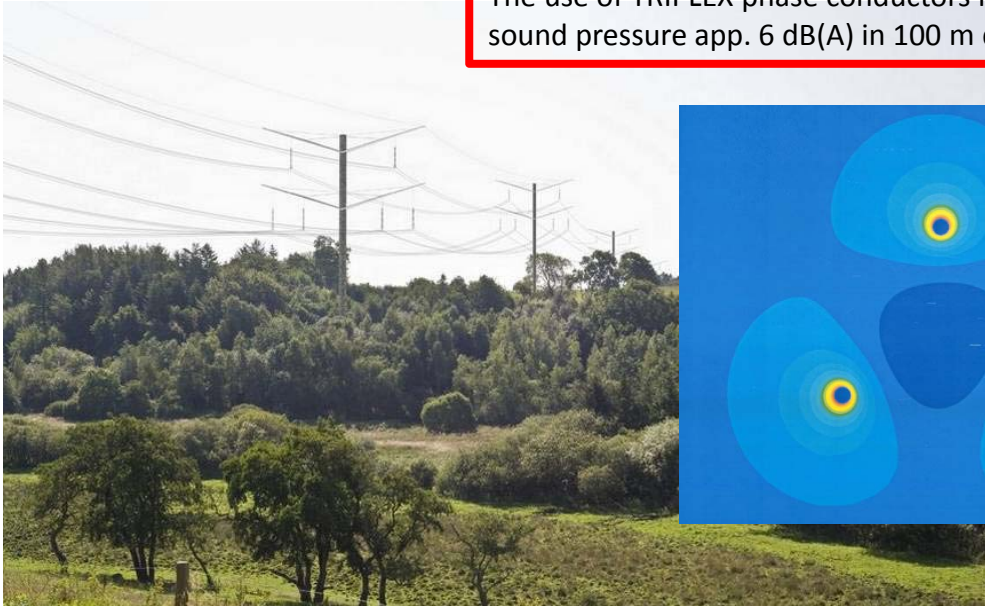
Introduction – power transmission

Suppose power transmission could avoid interfering with our view of nature ?
Is it possible to avoid visual impact and make modern power systems INVISIBLE?

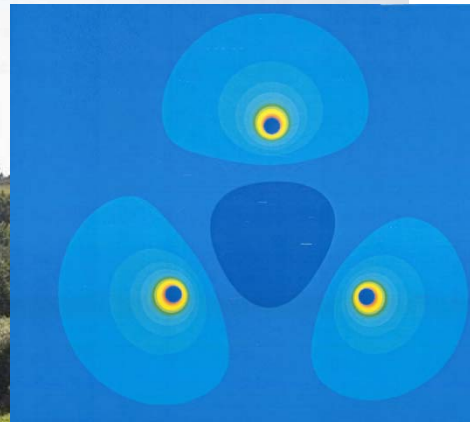


Introduction – power transmission

The use of TRIPLEX phase conductors reduces sound pressure app. 6 dB(A) in 100 m distance



<http://www.tu.no/kraft/2010/10/18/danskenes-stillfarende-monstre>



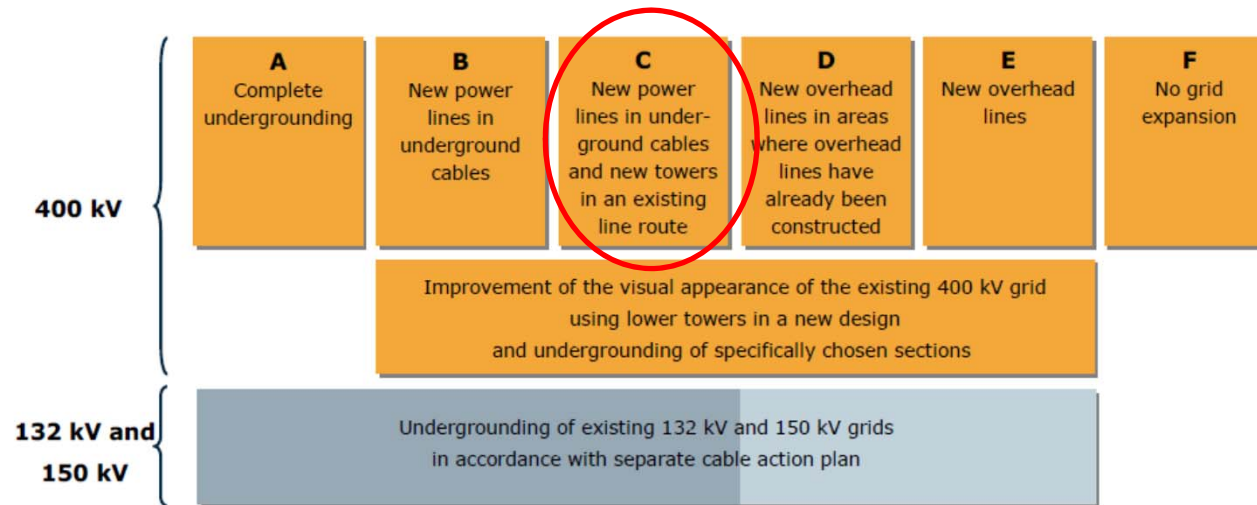
PhD thesis by Teruo Ohno, 2012.

Surely, we must expect a difference in electrical behavior!



Introduction – power transmission

2009: Governmental decision to underground the transmission system



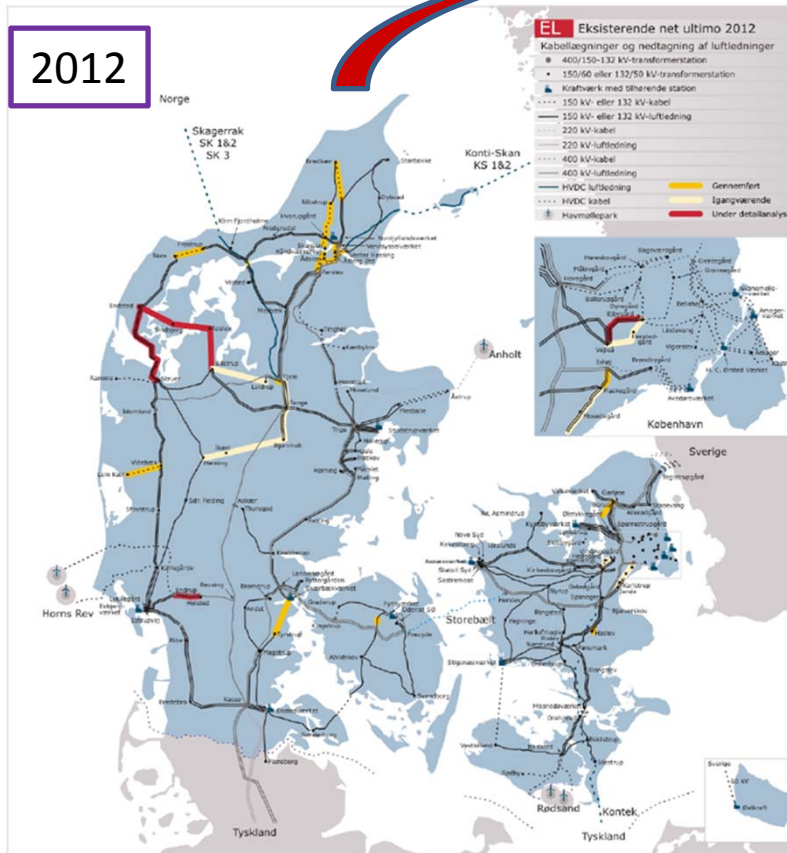
Teknisk redegørelse om fremtidig udbygning og kabellægning i eltransmissionsnettet, April 2008.

<http://www.energinet.dk/SiteCollectionDocuments/Danske%20dokumenter/EI/Elinfrastrukturrapporten%202008.pdf>

No country has undergrounded major parts of 420 and 170/145 kV transmission network. At the time of the project commencement, the only country with some experience was TEPCO in Japan.

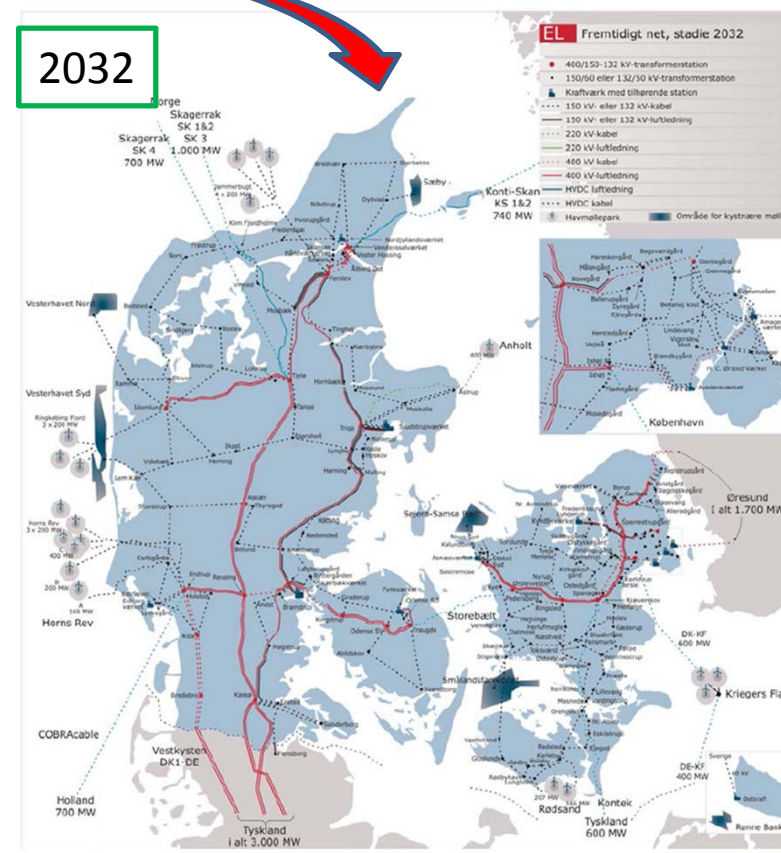


Introduction – power transmission



Figur 3 Gennemførte projekter 2009-2012, igangværende anlægsprojekter 2013 og projekter under detalplanlægning med forventet idriftsættelse 2014.

Reference: Energinet.dk Netudviklingsplan 2013



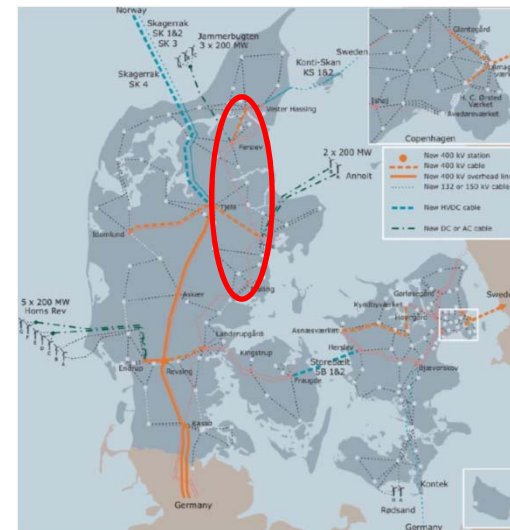
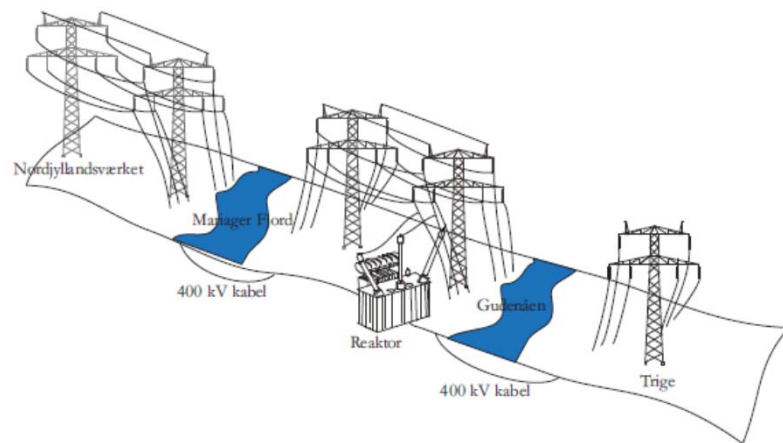
Figur 14 Den langsigtede netstruktur for transmissionsnettet i Danmark.

The transmission system is **CHANGING!**



Introduction, the early days

Danish "Energistyrelsen" approved a new 400 kV line between the cities of Aalborg and Aarhus in 2001 on the condition that areas of natural beauty were not visually influenced by the OHL. The crossings of Mariager Fjord and Gudenaen were such areas and the line was designed using underground cables in these sections.



Introduction, the early days

My first personal insight into underground cable dynamic behavior was conveyed to me by Energinet.dk (at that time ELTRA) chief engineer H. P. Elmer.

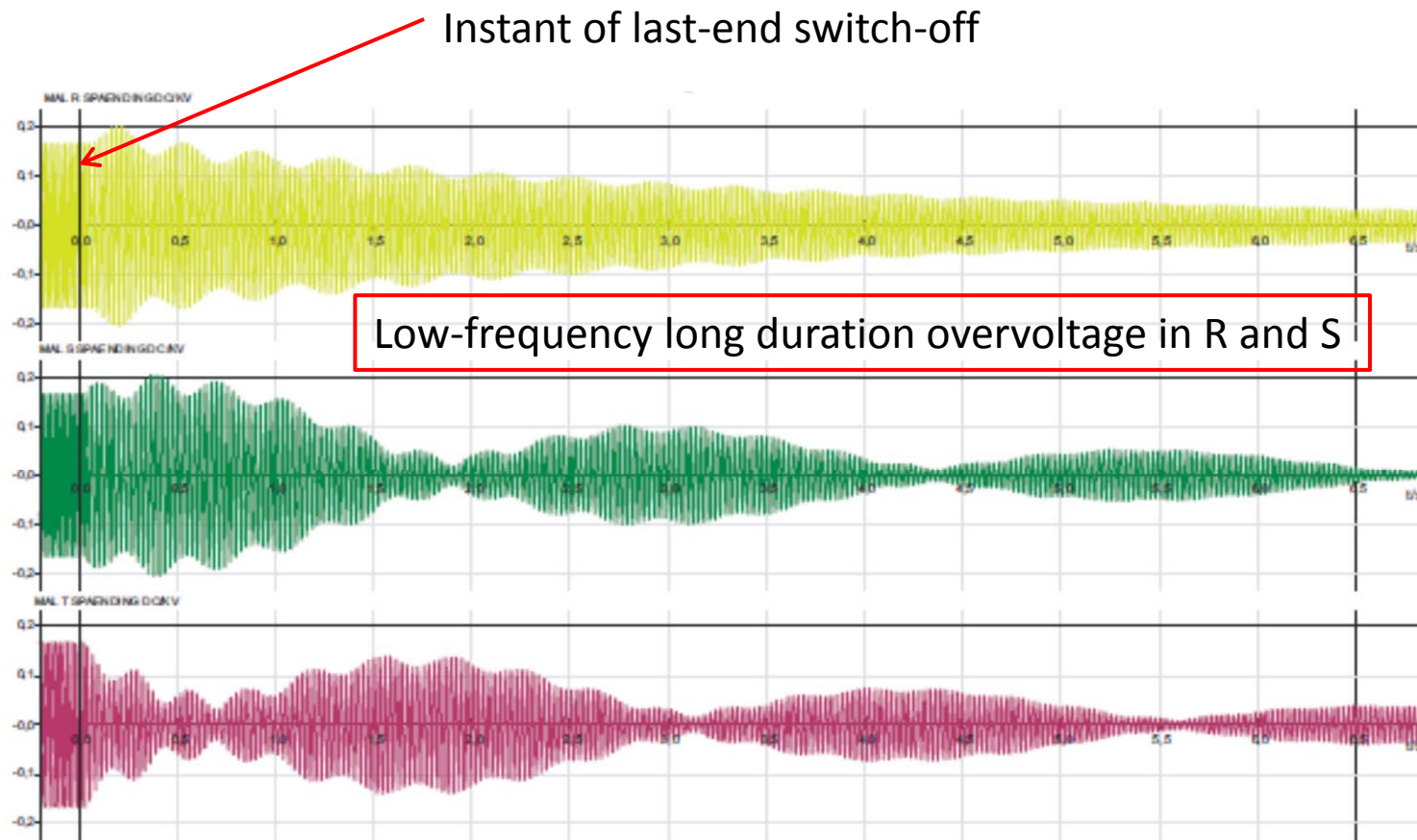
The Aalborg – Aarhus line was energized for the first time in 2004 and in order to monitor such a "hybrid" and at that time unknown constellation did not "misbehave", transient recorders were used to monitor switch-on and switch-off events.

And I remember Elmers comment on the latter of the above measurements:

*With such behavior in our (my!) transmission network,
I will not be able to sleep or spend one single relaxed moment
before a proper explanation is found!*



Introduction, the early days



Introduction, the early days

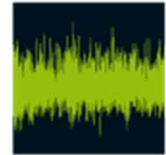
The first analysis of the modulated switch-off behavior of a combined OHL/UGC line was conducted in 2005 by Kim Søggaard in his MSc thesis. The main findings were:

- When **switching the line off the 50 Hz system, it will start resonating** with a frequency equal to its resonant frequency given by its inductances and capacitances, which are **dominated by the shunt reactor inductance and the cable capacitance**. In this case, this frequency is around 35 Hz.
- The differences in appearance for the three phases is due to the **slightly different resonant frequencies of each phase** (caused by reactor and line asymmetries), which are coupled by mutual couplings (also unsymmetrical, both inductive and capacitive, or just inductive, as the phenomenon was also registered in a pure cable line) between phases and thereby added. Adding two sinusoidals with slightly different frequency yields such low-frequency modulations.



Introduction, the early days

- The **overvoltage stems from the summation of both the capacitive and inductive induced voltages as the frequencies are slightly different** per phase and thereby, the induced voltages in one phase (from the other two) will either more or less add to the phase voltage and thereby add to the phase voltage increasing it or subtract from the phase voltage lowering it.
- The fact that the three phases are not switched off at exactly the same time, due to current interruption in current zero in the circuit breaker, adds to the non-aligned adding of the phase voltages.”



Introduction, the early days

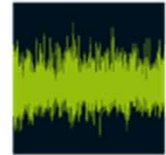
The last **disaster** we could imagine (at that time ..) was related to the use of single-phase autoreclosure in the OHL part of the line.

Suppose a single-phase fault occurs in the OHL line part

Can we expect the **arc in the faulted place to extinguish?**

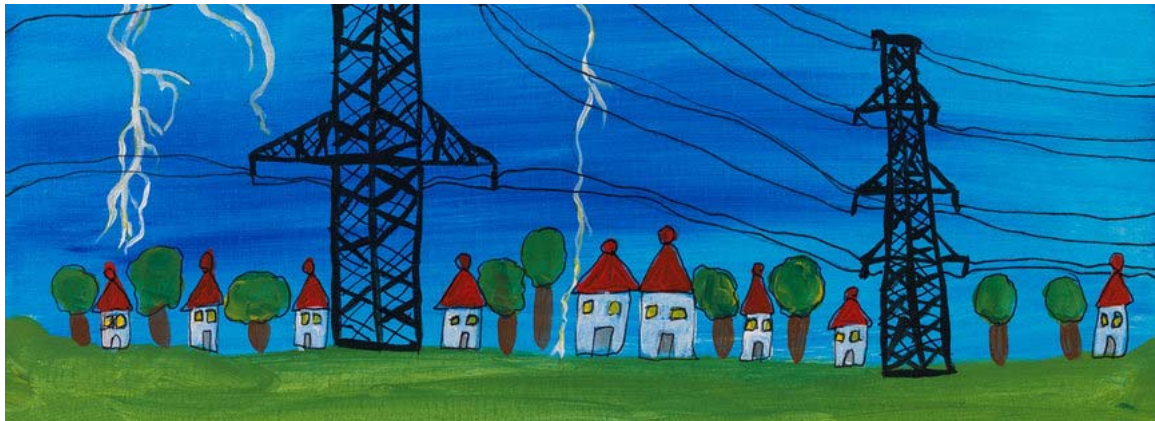
It will surely be fed via the (strong) mutual couplings from which we have evidence from in the switch-off modulated voltage waveforms.

The practical experience of this led to the following conclusions



Introduction, the early days

Undergrounding the transmission system makes the electrical behaviour of this much different compared to an OHL system. The electrical characteristics of cables results in their dynamics to be different as compared to OHL. The entire design foundation for a transmission line, including reactive power compensation, simulation models, transient studies, protection and fault location must be revised in order for us to be able to design undergrounded transmission systems with a confidence and reliability similar to OHL



From OMICRON webpage <https://www.omicron.at/>



Main Hypothesis

Is it possible to put up a complete set of tools and guidelines which enable analysis and assessment of underground transmission cable mode of operation and with such level of detail and confidence that we ultimately can design such cable transmission systems as easily and as reliable as conventional overhead lines?



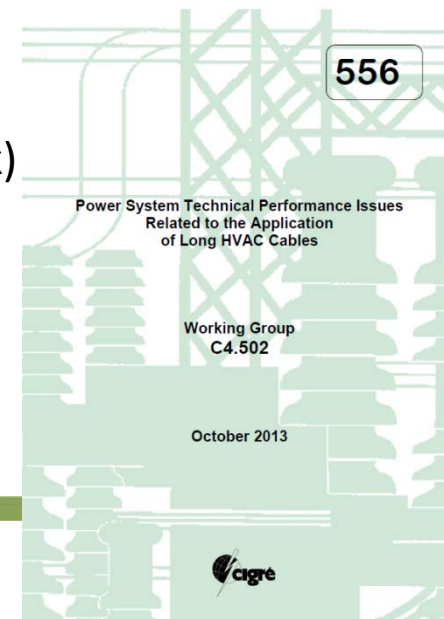
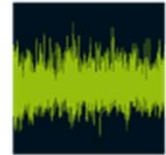
How to ??

A reliable operation of an underground transmission system can be achieved by assessing the physical factors of its operation, which can lead to danger, if exceeding the cable's initial design parameters.

Furthermore, the cable can, by its specific electric behavior, affect the surrounding transmission network to which it is connected (transformers, GIS, WPP..).

Such analysis must be conducted in the design phase and can typically be "contained" in what we know as

- Insulation coordination (stresses vs. strength)
- Power flow (sharing of loads in a meshed network)
- Thermal issues (ampacity and heating)
- Harmonic impedance studies



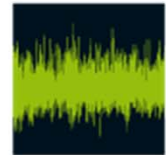
How to – more detailed

SYSTEM PLANNING STUDIES

Determining the need for new lines and ratings

- Cable types to use
- Parallel transmission paths
- Shunt compensation schemes
- Phase transposition and cross-bonding
- EMF issues

This is typically steady state power flow studies using positive sequence power frequency modeling.



How to – more detailed

SYSTEM IMPACT STUDIES

Determining the impact of the cable on the rest of the system

- Fault levels
- Self-excitation synchronous generators
- Voltage stability
- Transient stability
- Small signal stability
- Temporary overvoltages TOV – resonances, energization and islanding
- Ferroresonance
- Protection issues

Both lumped parameter and distributed parameter modeling used, in some cases positive sequence, in other three-phase unbalanced. DC – few kHz.



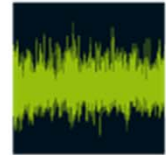
How to – more detailed

EQUIPMENT AND SYSTEM DESIGN STUDIES

Determining detailed protection and operating procedures for cable, sheath switchgear, shunt compensation and related equipment.

- Switching transients
- Energisation of long cables back-to-back
- TOV and surge arrester energy class
- Circuit breaker restrike
- Lightning transients – surge arresters
- Protection and autoreclosure
- Zero-miss
- Surge phenomena in general (TRV, incoming, VFT, overvoltages in general)

Basic and necessary tools are accurate frequency dependent EMT programs!



Modelling of underground cable systems

EMT models for OHL's are widely used and have been proved valid. This is not the case for UGC's as their use has been rather limited.

Much of the high level design studies rely on complicated EMT frequency dependent numerical models.

We MUST be able to trust results obtained with such simulation models, or else we cannot design an UGC in a reliable way!

The ONLY way to **validate** such simulation tools is by comparing to **high-quality real, full scale UGC measurements**.

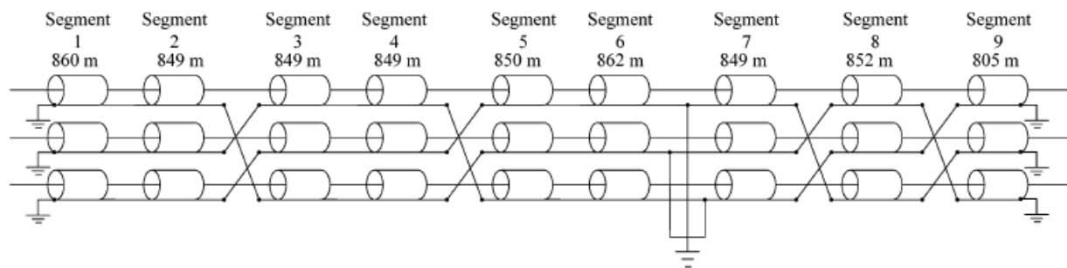


Photos from PhD Thesis by Unnur Stella Gudmundsdottir 2010.

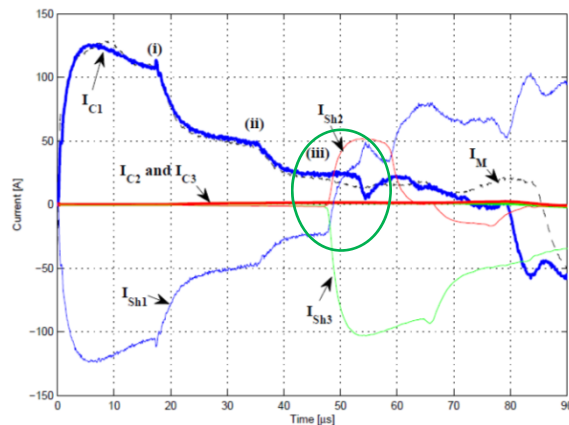


Modelling of underground cable systems

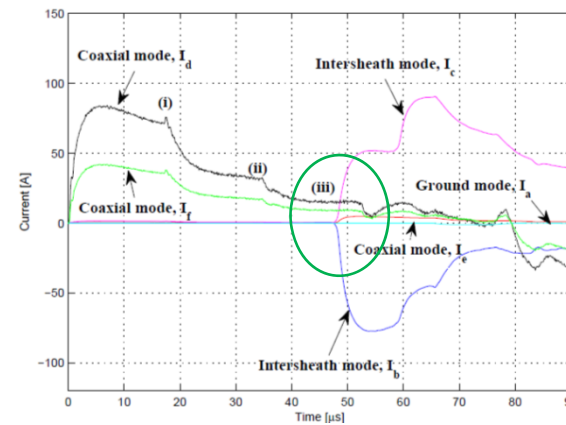
Field measurements on a 7,6 km 400 kV cross-bonded UGC in flat profile



Phase currents



Modal currents



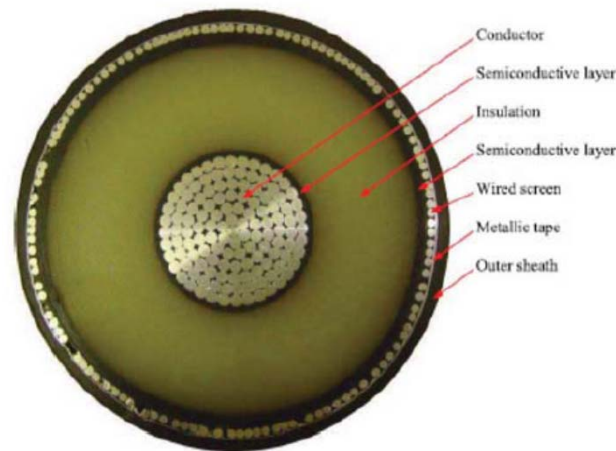
When intersheath mode starts to occur $\approx 48 \mu\text{s}$ we see that simulated (blue) and measured currents (black) start deviating.



Modelling of underground cable systems

The intersheath mode physical current flow in the sheaths must be accurately modeled in order to represent correct magnitude, damping and frequency response – if not, this will lead to inaccurate phase quantities.

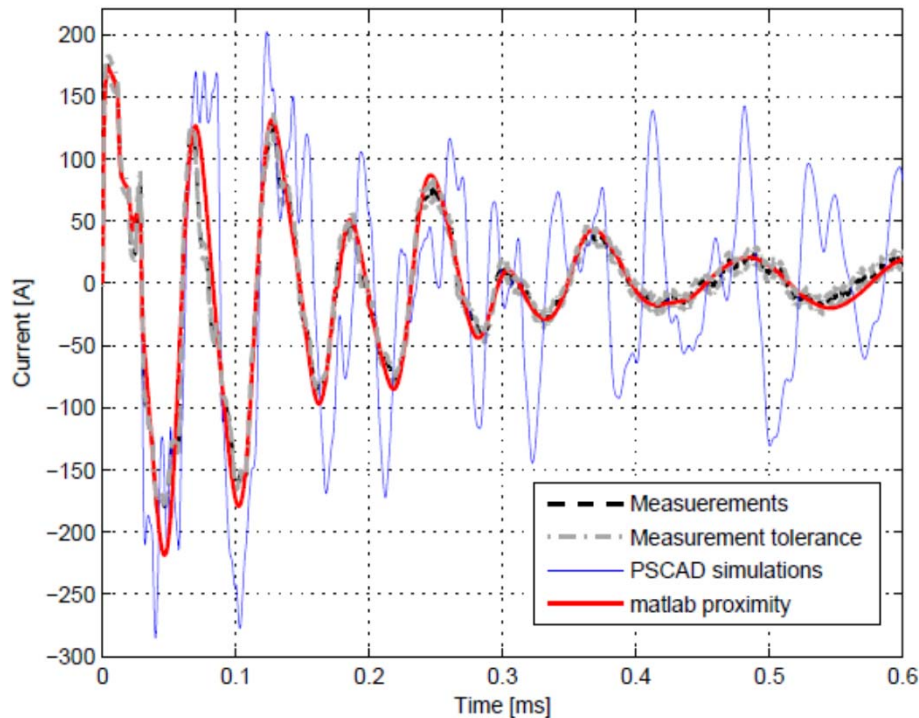
Proximity effect in sheaths are not modeled and the actual layout of the sheath is simplified to be modeled as a solid coaxial shell. This results in damping, which is not in accordance with cable real behavior.



Modelling of underground cable systems

Improving the model yields much better resemblance between simulated and measured results.

150 kV single major section sending end current



C. Leth Bak and F. Faria da Silva, High Voltage AC underground cable systems for power transmission – a review, part 1, Journal of Electric Power System Research, 2015 (submitted – under review).



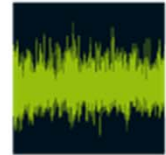
Dynamic studies for underground cable systems

RESONANCES

TOV caused by resonances are more likely to occur in a cable-based transmission system due to the presence of shunt reactors and the much larger shunt capacitance as compared to OHL.

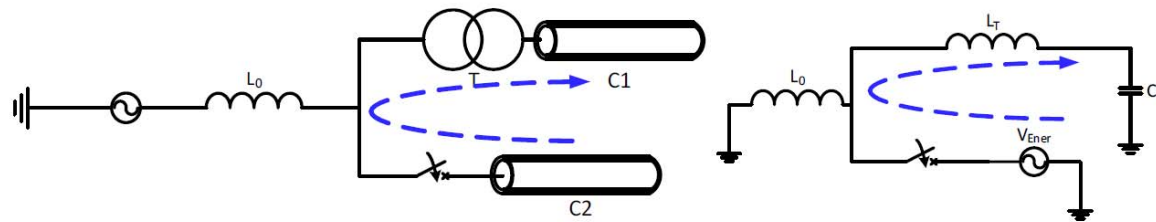
Therefore, we must expect phenomena such as energisation of transformers and cables, fault clearing, load shedding and system islanding to result in long-duration TOV's.

Such TOV's must be well-known in order for us to be able to design surge arrester energy absorption capability.

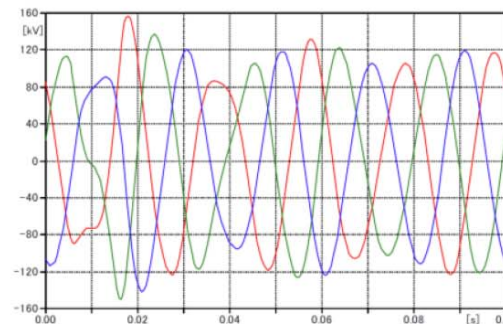


Dynamic studies for underground cable systems

Series resonance can be excited by energising a cable in the vicinity of a series resonant circuit such as another cable which is fed through a transformer. In this way, transformer leakage inductance is in series with cable shunt capacitance.



Energizing C2 makes this energisation transient voltage travel into series connection of T and C1. If the energisation overvoltage contains the natural frequency of the series resonance circuit, an overvoltage can be created at the secondary of the transformer.

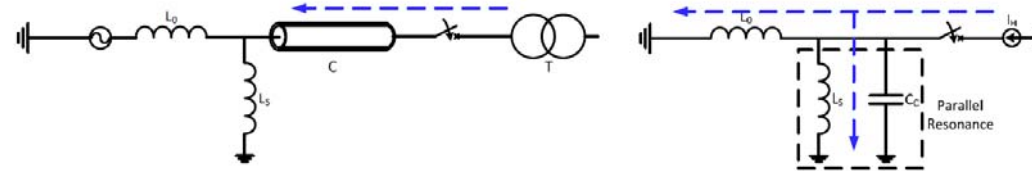


C. Leth Bak and F. Faria da Silva, High Voltage AC underground cable systems for power transmission – a review, part 1, Journal of Electric Power System Research, 2015 (submitted – under review).

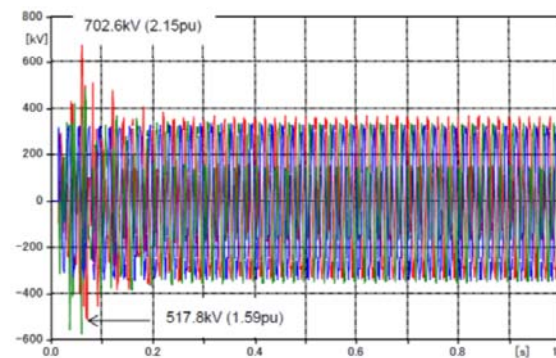


Dynamic studies for underground cable systems

Parallel resonance can for instance be the energisation of a transformer connected to a weak network by means of a long cable.



Energisation of transformer T causes the harmonic inrush current to flow into the parallel branch consisting of cable shunt capacitance C_c , shunt reactor inductance L_s and equivalent network series impedance L_0 . This creates a parallel resonance overvoltage.

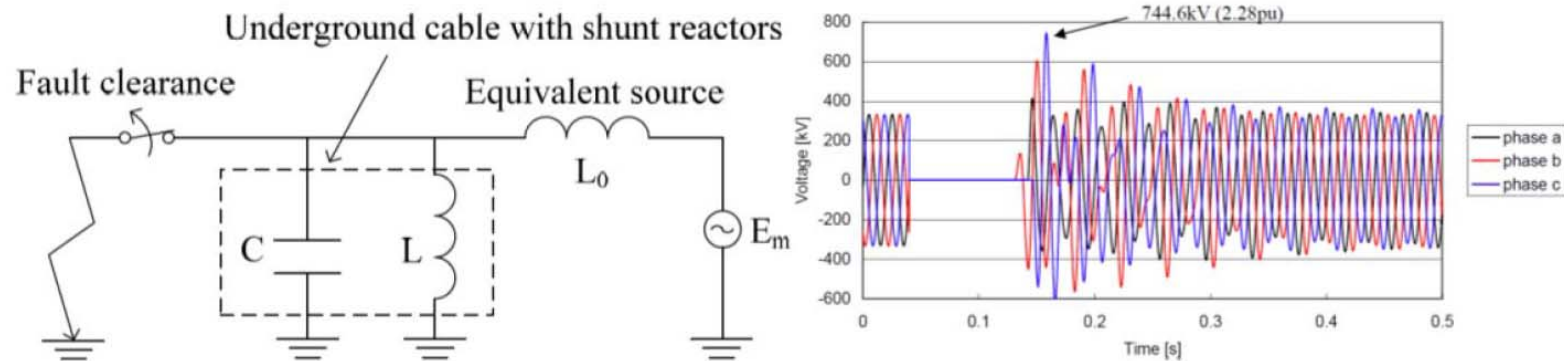


C. Leth Bak and F. Faria da Silva, High Voltage AC underground cable systems for power transmission – a review, part 1, Journal of Electric Power System Research, 2015 (submitted – under review).



Dynamic studies for underground cable systems

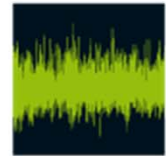
Fault clearing and system islanding creates transient voltages. These depend on system parameters and contain both power frequency and an excited resonant frequency.



When a fault gets cleared, parallel connection of cable shunt capacitance C and shunt reactor inductance L have to re-charge. This creates a resonant overvoltage in the remaining system.

Generator data and AVR will also play a role in the long term due to the rejection of load.

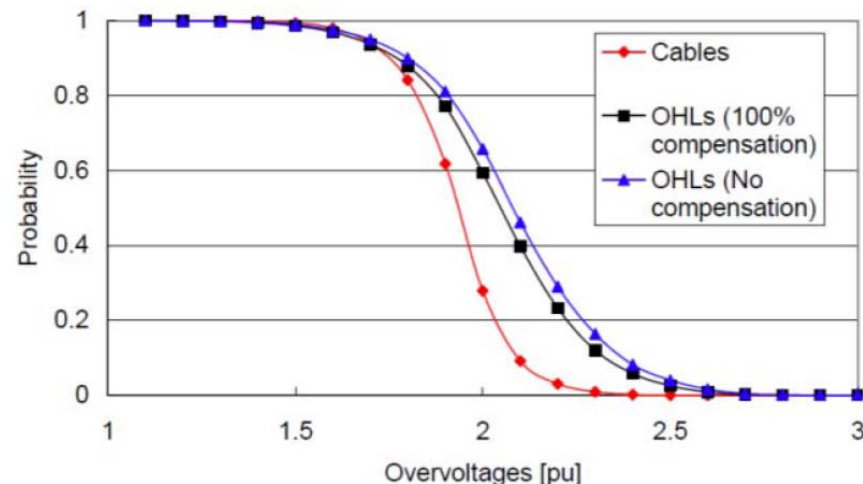
C. Leth Bak and F. Faria da Silva, High Voltage AC underground cable systems for power transmission – a review, part 1, Journal of Electric Power System Research, 2015 (submitted – under review).



Dynamic studies for underground cable systems

Energisation of UGC systems generally creates lower overvoltages than OHL's. This is mainly due to the much lower surge impedance of the UGC as compared to OHL.

Studies have been conducted to reveal statistical switching overvoltage when energising a cable line. The simulations were made in a Monte Carlo manner employing four different line lengths and four different equivalents in feeding networks.



C. Leth Bak and F. Faria da Silva, High Voltage AC underground cable systems for power transmission – a review, part 1, Journal of Electric Power System Research, 2015 (submitted – under review).



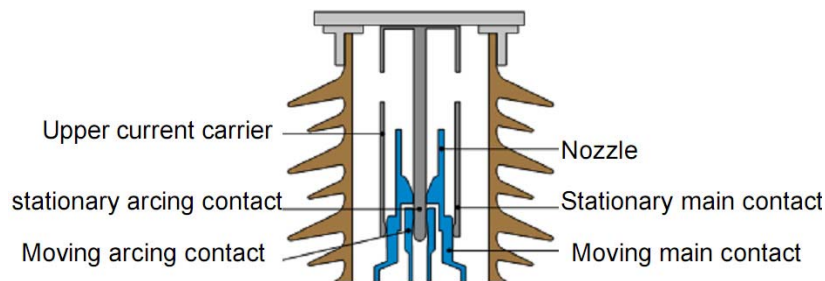
Dynamic studies for underground cable systems

Cable energisation in an extensive cable network can be compared to capacitor back-to-back switching due to the UGC's large shunt capacitance.

IEC 62271-100 "High Voltage alternating current circuit breakers" 2nd edition circuit breakers must fulfil requirements regarding back-to-back capacitor inrush making currents.

Rated values

For all voltage levels, these values are $I_{bi} = 20\text{kA}$ peak and $f_{bi} = 4250\text{Hz}$, where I_{bi} designates max. peak value and f_{bi} max. frequency of the inrush current transient. IEC standard 1st edition the product of I_{bi} and f_{bi} for certain conditions were not to exceed the product of $I_{bi,N}$ and $f_{bi,N}$ ($20\text{kA} \cdot 4250\text{Hz} = 85 \cdot 10^6 \text{ A/s}$).

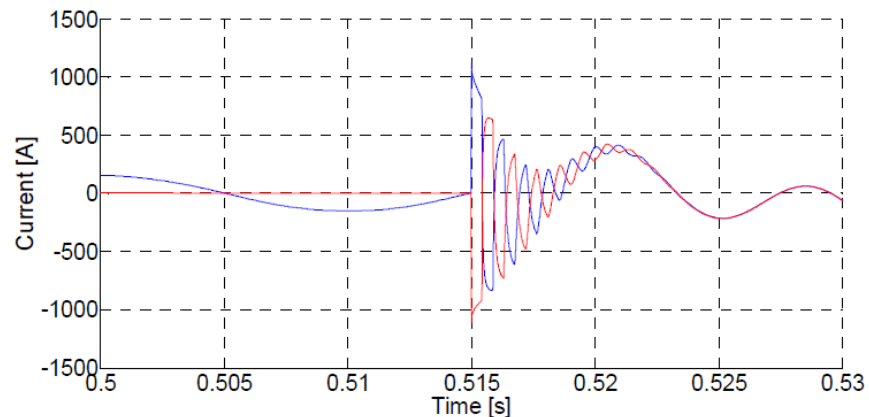
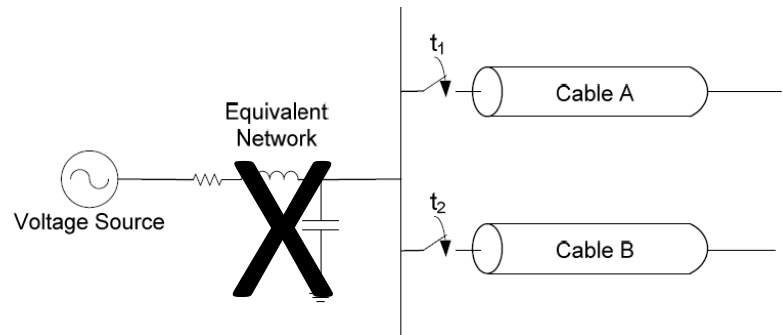


High f , high $i(t)$ will, due to skin effect, lead to a cone shaped, extensive wear of the stationary arcing contact leading to prestrikes and premature failure.



Dynamic studies for underground cable systems

Ideal case using frequency dependent phase model and ideal voltage source



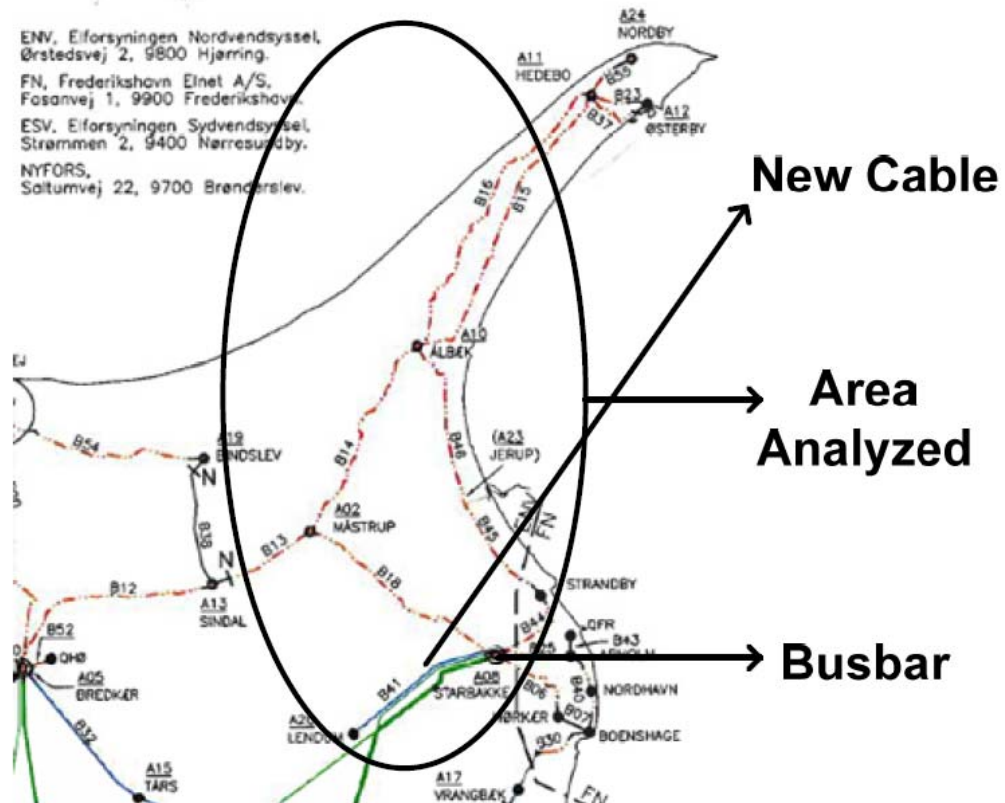
For the simulation using an ideal voltage source, the peak inrush current is 3100A and its frequency is 5kHz. Multiplying the two values is obtained $15.5 \cdot 10^6 \text{ A} \cdot \text{Hz}$, a value 5.5 times inferior to the allowed maximum of IEC.

Sending end current when switching on cable B. Blue: Current in cable A and Red: Current in cable B



Dynamic studies for underground cable systems

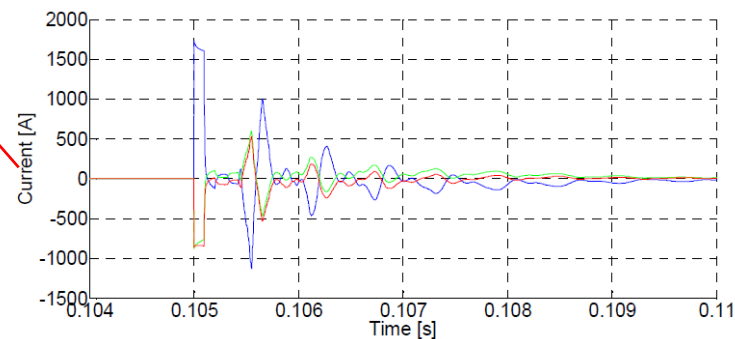
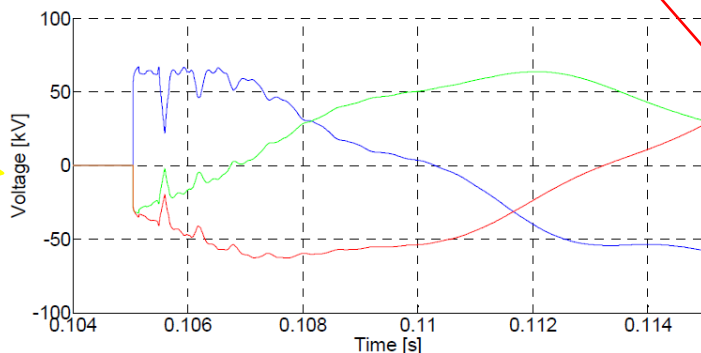
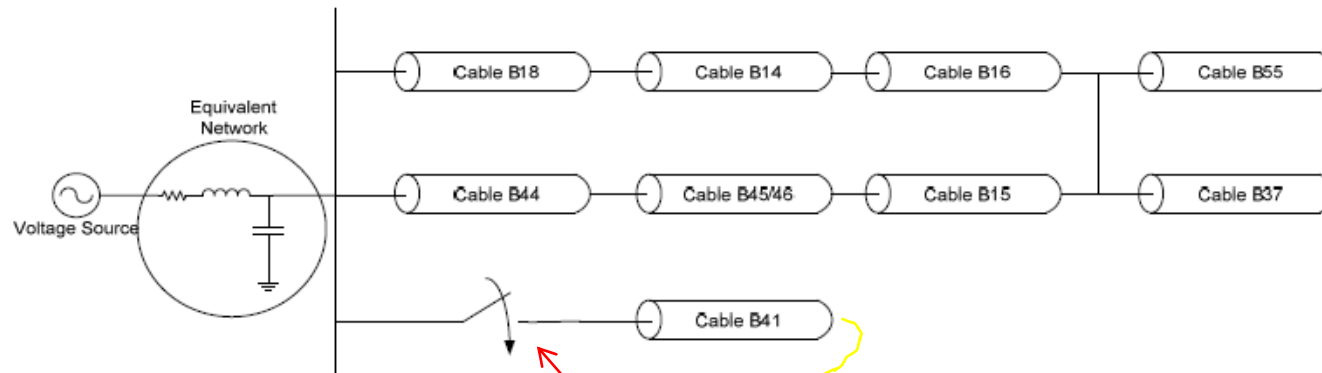
Real case installing a new 60 kV cable in NORDENERGI (ENV) network.



The good question was:
Will installing a new relatively long UGC in a substation already having many UGC feeders lead to "danger" for the CB already in place?



Dynamic studies for underground cable systems



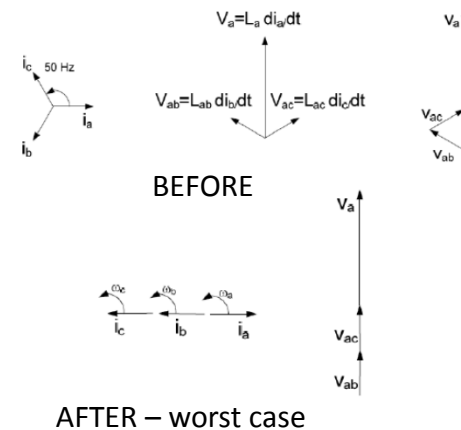
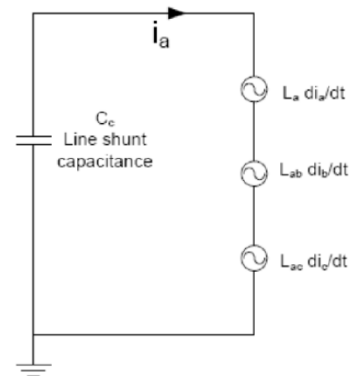
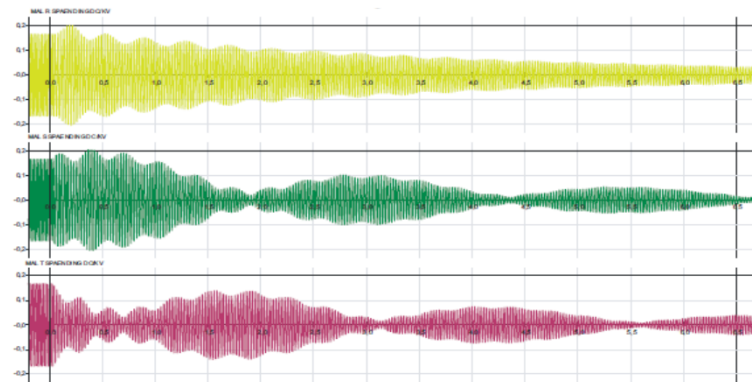
When using the real network, the value of the peak inrush current is 1750 A and the inrush current frequency is 5kHz. Multiplying both values is obtained $8.75 \cdot 10^6$ A•Hz, a value about 10 times inferior to the allowed maximum of IEC.



Dynamic studies for underground cable systems

De-energisation can cause slowly decaying UGC voltage containing several beat frequencies as well as overvoltage.

This is due to more or less symmetrical mutual couplings of the line including the shunt reactor.

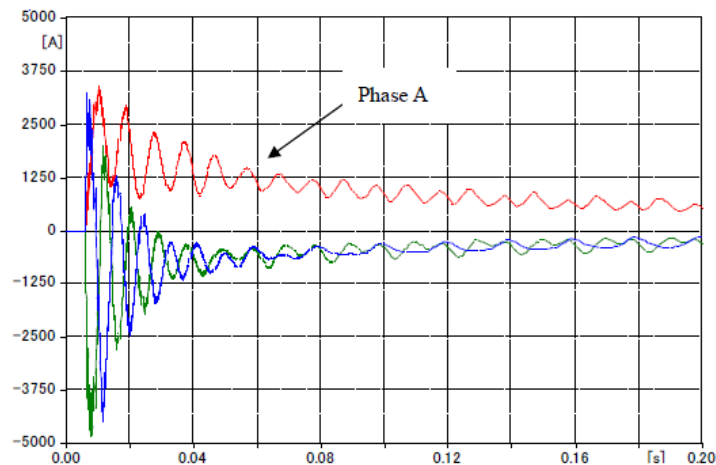


- Overvoltage must be considered for line surge arrester TOV and IVT.
- Single phase ARC in a hybrid line has been proven (in one specific case) to be succesful.



Dynamic studies for underground cable systems

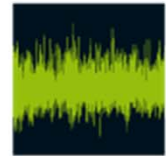
Zero-miss occurs when switching on an UGC with a directly connected shunt reactor in voltage zero. This is due to the fact that AC reactor current and AC cable capacitive current are in phase opposition and that $i_L(t^-) = i_L(t^+)$



COUNTERMEASURES

- Using SR with less than 50% compensation directly connected to the cable line
- Using pre-insertion resistors in the CB. This increases the cost of the CB.
- Synchronised switching using single-phase operated CB and point on wave equipment
- Sequential switching opening faulted phase and switching shunt reactors before healthy phases
- Energise shunt reactor after cable. Produces larger voltage steps.

Teruo Ohno, "Dynamic Study on the 400 kV 60 km Kyndbyværket – Asnæsværket Line", PhD thesis, Aalborg University - Dept. of Energy Technology, 2012



Harmonics in cable based transmission systems

Underground cable transmission systems have **much lower resonant frequency** than their OHL counterparts. This is mainly **due to the very high shunt capacitance** of the cables. This leads to a shifting of the frequency characteristic resonant points towards lower frequencies which in hand leads to **an increased risk of exciting resonances when switching the network**. Another issue is the likelihood of a **permanent resonant overvoltage or overcurrent due to transmission network background harmonic distortion**.

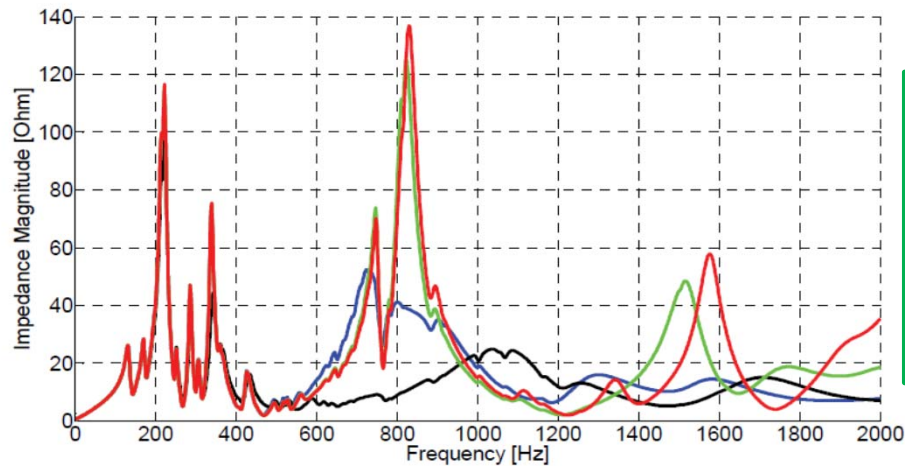
The background distortion contains harmonics, mainly due to non-linear components such as transformers (5th and 7th) and HVDC converters (LCC 11th and 13th and 23th and 25th). Furthermore, mainly due to rectifier loads, harmonic load currents from the distribution system are being transferred to the transmission network.

This increasing content of harmonics together with the reduced resonant frequency of underground cable transmission lines leads to a higher risk of harmonic excitation with the possible danger of TOV.



Harmonics in cable based transmission systems

Example: The frequency spectrum varies for different bonding configurations. The spectrums are estimated for a 150 kV node of the 2030 West Denmark Network. The node is connected to three cables with lengths of 23.7 km, 29.7 km and 47.5 km. The nodes up to two busbars of distance are modelled by means of FD-models and the rest of the network is modelled by means of lumped-parameters models. All the network transformers, generators and loads are included in the model.



Resonances present at low frequencies

Bonding plays a role for frequencies higher than 400 Hz

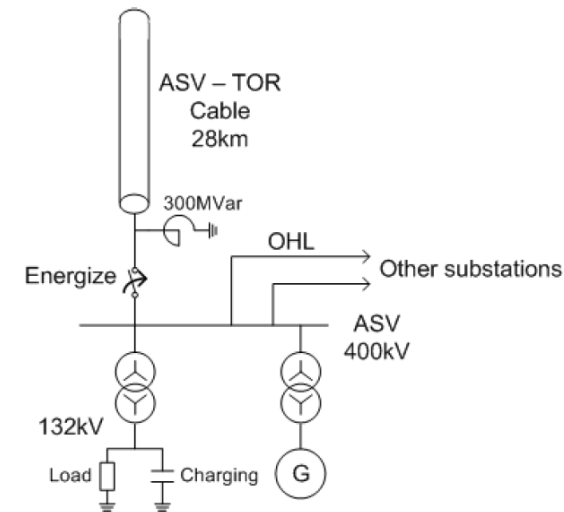
Black: All cables bonded in both-ends; Blue: All cables with one cross-bonded major section; Green: The three cables attached to the reference node with three cross-bonded major sections and the remaining cables with one cross-bonded major section; Red: All cables with six cross-bonded major sections



Harmonics in cable based transmission systems

Example of harmonic resonance TOV for a planned 400 kV line (UGC)

For a given length of a line, one propagation velocity is linked to one dominant frequency. This is used in [A] to derive theoretical formulas of the frequency component contained in the overvoltage related to long EHV cables.



Check for series resonant overvoltage in ASV

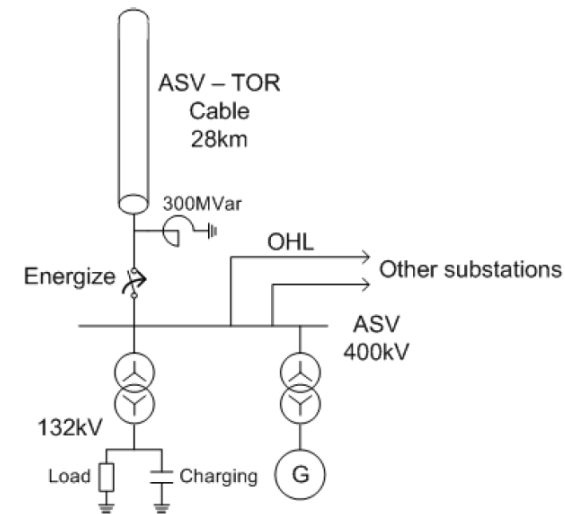


Harmonics in cable based transmission systems

Dominant frequencies in the energisation transient – *theoretical formulas*

DOMINANT FREQUENCIES DERIVED THROUGH PROPOSED FORMULAS

Source impedance [mH] (dummy)	0.1	50	100	200	No dummy
Network Source Impedance [mH]	0.1	24.5	37.5	51.0	71.4
Propagation velocity [m/ μ s]					
mode 1	100.5	44.7	37.1	32.2	27.5
mode 2	89.0	42.5	35.8	31.4	27.0
average	94.8	43.6	36.4	31.8	27.2
Dominant frequency [Hz]	846.0	389.3	325.4	283.9	243.4

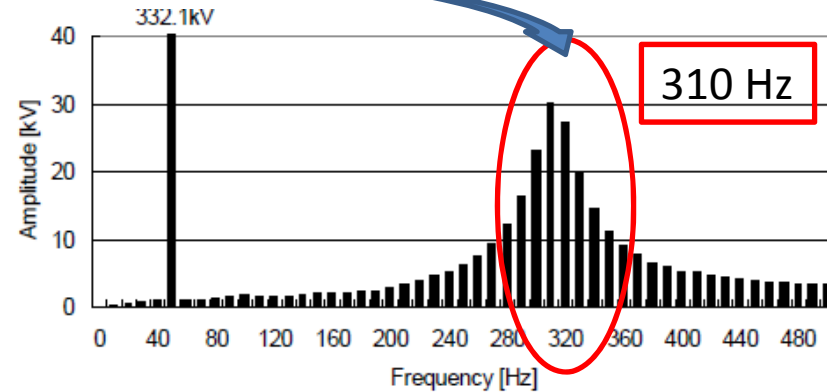
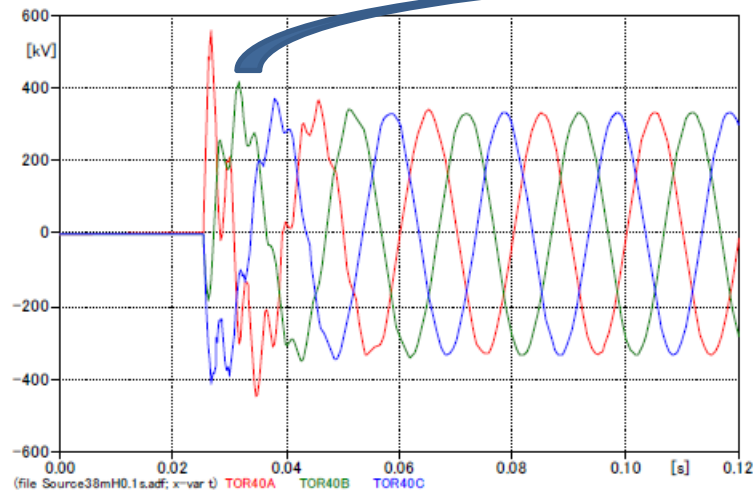


The network impedance is given by off-peak (worst case) and by varying the dummy impedance actual influence on source impedance is shown.

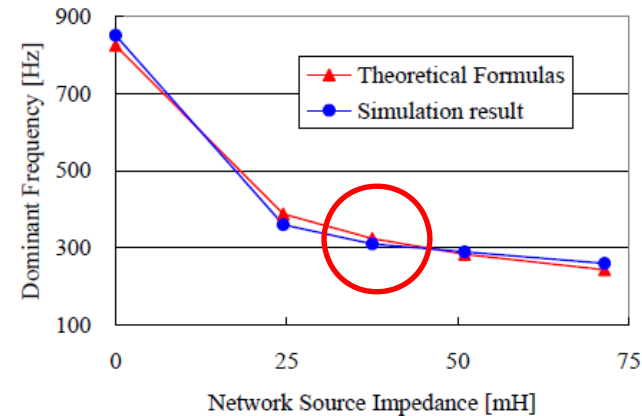
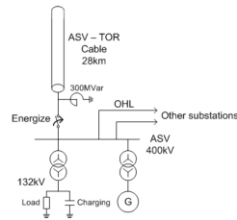


Harmonics in cable based transmission systems

Dominant frequencies in the energisation transient – *EMT simulations*



Voltage at open TOR terminal during cable energisation with 100 mH source dummy.



Modeling depth and systematic approach

The simulation studies presented must be conducted when laying down the specifications for a partly or fully cable-based transmission network. Such studies are **time consuming** and require **numerous time domain simulations**. Time domain simulation **runtime highly depends on the adopted model complexity**, which relates to the **level of detail** with which the network is modelled. How detailed are the network components represented? How many components are modelled one by one or are parts of the entire network modelled by **simpler equivalents**?

The results obtained depend on the level of detail in the modelling approach so that **the higher level of detail, the higher the accuracy**, if we disregard possible numerical instabilities due to a high level of details. The dependence is so that the higher the degree of accuracy, the better should be the level of detail in modelling. However, beyond a certain level of detail, only minor improvement or no improvement of the results is achieved. Knowledge of this level of detail to reach a fair accuracy is highly valuable as it reduces computer simulation time. Such a concept is pronounced "**Modelling depth**".

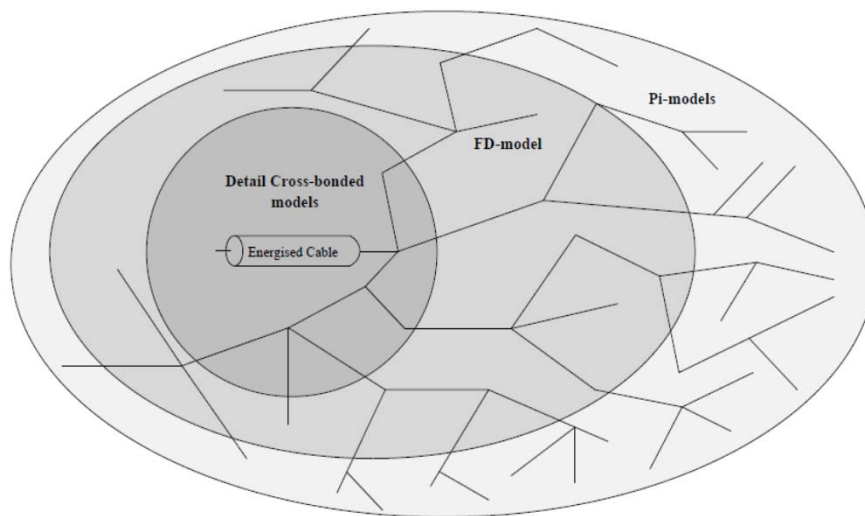


Modeling depth and systematic approach

Switching phenomena

IEC 60071-4 suggests including only the network of the same voltage level up to one or two busbars behind the node of interest, with the rest of the network being modelled by an equivalent Thévenin.

It is proposed that the simulation model is divided into three zones, each with different levels of modelling detail.



1st zone FD and all minor sections (cross-bondings)

2nd zone FD and only one major section

3rd zone lumped parameter one busbar and rest equivalent network (thévenin)



Modeling depth and systematic approach

Resonance phenomena

In order for us to be able to **calculate TOV's originating from resonances**, an adequate modelling of the network is necessary. Frequency scans of the network must be available and **the admittance of the equivalent network should be modelled by Frequency-Dependent Network Equivalents (FDNE)**. For practical reasons, this is not normally possible, and approximations must be made using simulation models.

One possible method is to design a detailed network model and to extract the frequency domain response of the node(s) of interest and use this to obtain the FDNE. The drawback of this method is the need for a reference detailed network mode.



Modeling depth and systematic approach

Another possibility is to use **an empirical approach** consisting of

- Designing a detailed system up to a distance of two or three busbars from the point of interest and use an equivalent network (50/60Hz) for the rest of the grid
- Repeating the previous point, but increasing the modelling depth of the detailed area in one busbar
- Comparing the frequency spectrums for both systems;
- Repeating the process until the difference between the spectrums is minimum around the frequencies of interest

This procedure is somewhat time consuming and can be combined/verified with the approach of the theoretical formulas for the frequency components.

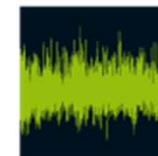
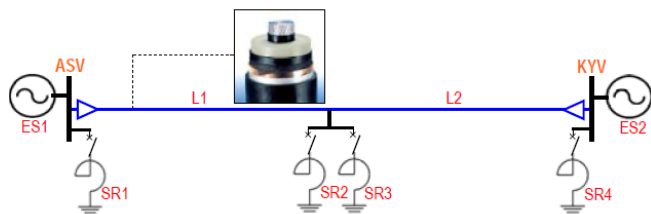


Protection of underground cable systems

A reliable and proven protection scheme employing proper main protection as well as back-up protection is of great importance for underground power cables as they suffer **permanent damage** when struck by a fault.

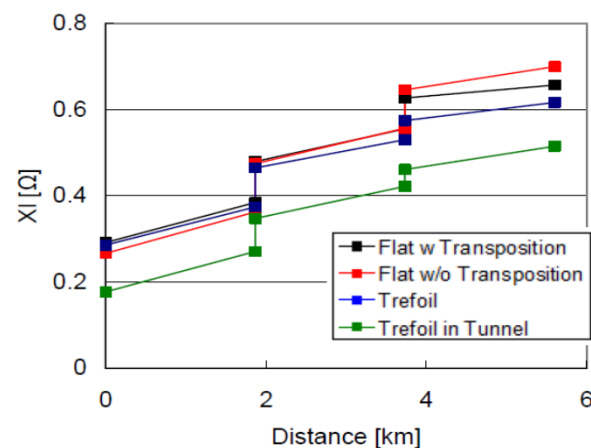
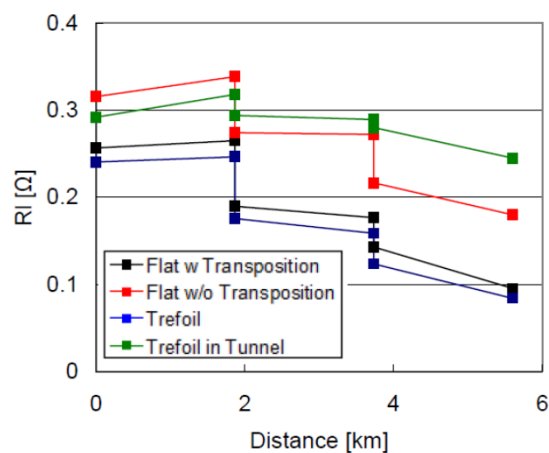
Main protection of underground cable systems is usually laid out as current differential using both instantaneous value comparison and phasor comparison.

Backup protection of cables usually uses distance protection without communication channels. In order to use distance protection correctly, the measured impedance of the faulted loop must be well known to be able to lay down a setting scheme assuring both selectivity and confidence in trip when faults are present.



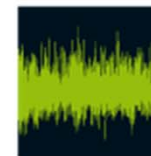
Protection of underground cable systems

Cable faults are usually single phase to ground (SLG) faults due to the phase separation as well as the single phase screen only being separated from the phase conductor by the XLPE insulation. As seen by the distance relay, the SLG fault loop impedance is expected to be **non-continuous** due to the shifting of the screen currents in the cross-bonding points along the cable line.



17% > ΔZ > 11%

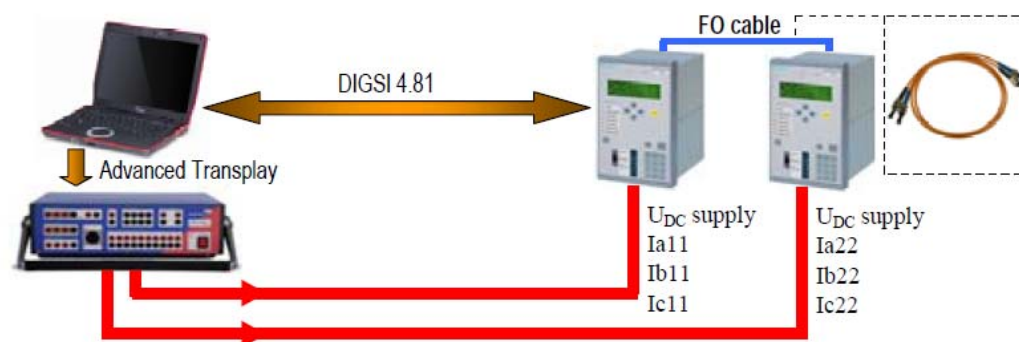
Non-continuous impedance for one major section of the ASV-TOR 400 kV UGC



Protection of underground cable systems

The main conclusion is that **distance protection can be used without problems** as a back-up protection for UGC's of a realistic length.

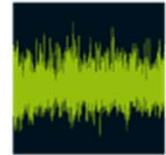
Differential protection is well suited as a fast main protection. TD simulation studies testing various transient occurrences for both internal and external faults have been replayed to a "real" relay and it has been concluded that the relay reacts fully satisfactorily with regards to speed and accuracy, also in transient conditions.



Fault location in underground cable systems

Usually, **faults located in OHL transmission lines can easily be found** by visual inspection. Furthermore, insulation of an OHL is of the self-restoring type, which means that it restores after a fault has been switched off. This is due to the nature of gaseous insulation. Conductors, armature parts, arcing devices and insulators can suffer damage due to the high temperature arc in the faulted location. Such damages are easily visible by inspection.

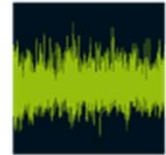
This is not the fact for underground cables as these are literally buried 1-2 meters below ground surface and thereby not at all visible for inspection. Furthermore, the insulation is of the non-self-restoring type, which means that a fault creates permanent damage to the cable which then must be repaired before energisation.



Fault location in underground cable systems

It is evident that the location of a fault in a cable system can be both costly, time consuming and very tedious. We need to excavate the cable in order to be able to identify the faulted location. Underground cables are often laid in farm land which means that the crops will be destroyed in case of excavation. Traditional methods of estimating the faulted location usually rely on positive sequence reactance of the line and are somewhat inaccurate, causing several kilometres of excavation of cable in order to locate the fault.

Offline methods such as time domain reflectometer and bridge methods can be used to locate the fault, but it is often seen in XLPE insulation that faulted location puncture closes so the fault turns into a high resistive fault, which is difficult to locate.



Fault location in underground cable systems

For onshore underground cable lines, repair time can be several days, and even longer for offshore cables, where weather conditions play a major role in the ability to perform repair.

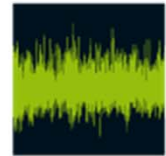
Hence, a method which locates cable transmission system faults fast and with high accuracy would be highly beneficial.

Online fault location methods can be subdivided into two categories:

- Impedance-based methods
- Travelling wave-based methods

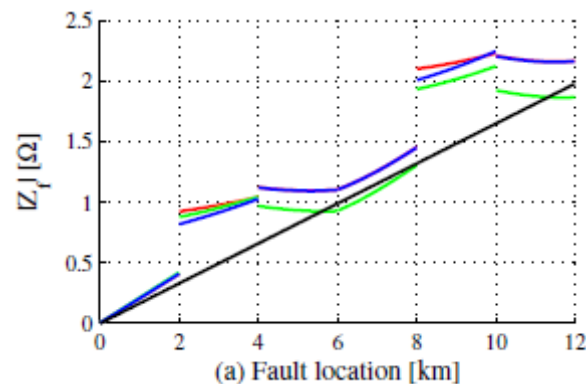


Photo of a single phase cable fault at the onshore part of the Horns Reef 2 170 kV HVAC cable. From PhD Thesis by Christian F. Jensen, 2013.



Fault location in underground cable systems

Impedance-based fault location methods are widely used for OHL due to the **continuous nature of the series impedance** and the fact that larger inaccuracy means less, e.g. because a few hundred meters of OHL can easily be overlooked. Such inaccuracy is unwanted for buried cable systems. The **discontinuous behavior of cross-bonded cable systems** will inevitably lead to **large difficulties in accurately locating** a fault. Furthermore, measuring accuracy of instrument transformers and the impedance calculating device will play a major role in trying to get good fault location accuracy, or, in other words; how much cable we have to excavate.



Fault location in underground cable systems

The three coaxial mode velocities are equal and constant for frequencies above 10 kHz and they are considerably faster than the intersheath and ground mode velocities.

This makes the **coaxial mode velocities well** suited for a travelling wave-based fault location method.

Travelling wave fault location can be applied as either single-terminal or two-terminal methods. The single-terminal method is unsuitable for cross-bonded cable systems, as reflections from the cross-bonding point will interfere with the second wave and make it difficult to detect the reflections. The two-terminal method is well-suited and obtains a good accuracy.

Fault resistance [Ω]	Cable length [km]	Fault location error at 5% [m]	Fault location error at 35% [m]	Fault location error at 60% [m]	Fault location error at 90% [m]
0	18	37	30	28	43
	36	56	50	41	61
	60	85	75	60	81
10	18	39	31	28	42
	36	60	54	43	63
	60	86	85	61	84



Conclusions

The main conclusion is that underground cable transmission systems are a technically possible way for power transmission in the future transmission network. However, compared to OHL, many technical challenges are still to be faced. This requires a much larger design effort as compared to OHL design. Furthermore, the operational experience with undergrounded cable systems is rather limited, making it hard to assess the major question “Are underground cables equivalent to OHL with regards to reliability and lifetime”?

The best we can do for the present is to conduct a most thorough design study when planning a new cable line. This is necessary as not much accumulated design knowledge and design guidelines have been created yet, as the cables have only been used in a relatively short time period as compared to OHL’s.

In the author's opinion, the best thing to do is to **follow dedicated design guidelines** as given in **Cigré TB 556 Power System Technical Performance Issues Related to the Application of Long HVAC Cables**, Cigré Technical brochure WG C4.502, Cigré 2013.



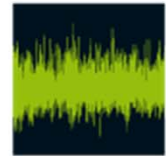
Conclusions

At the time of publication (December 2014), **several papers report a progress** in both the intentions of installing underground cables, onshore and offshore as well as the actual installed systems.

An example is the Cigré 2014 General session, where **SC B1 holds 33 publications** within isolated cables. Many obstacles have been overcome via research carried out by the research community so far, but as cable transmission systems are still in their youth, operational experience as well as continued research uncovers needs for further research in the years to come.

Some future key research issues are:

- Three phase submarine cables exact loss modelling
- Resonance problems in meshed transmission networks employing a high share of power electronic converters
- Underground cable lifetime assessment, condition monitoring and maintenance



Conclusions

Main hypothesis – final remark

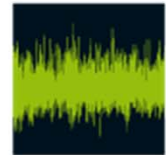
The research presented in this PhD thesis summary and the publications upon which it is based has led to the development of a practically useable set of tools and design guidelines enabling a widespread use of underground cables in the transmission system. The technical disciplines used to design OHL has been reformulated and adapted to suit the design of underground transmission cable systems in order to foresee a reliable operation of such. Cable transmission is in its youth, so only years of operational experience can prove the developed design guidelines to be adequate, thus leading to a long term reliability at the same level as OHL.



Conclusions

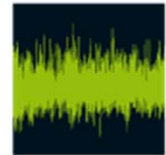
Scientific contributions

- Identification of research needs in order to be able to design underground cable transmission systems in a reliable and practically applicable way
- Management of a 10 year research study in underground cable transmission systems
- A new OHL audible noise calculation model for snow and frosty mist
- Identification of the fundamental cause of the switching transients in underground cable systems
- Studied the wear of circuit breakers when subject to cable energisation and assessed the use of IEC 62271-100 to study this phenomenon
- A hybrid method to assess dynamic simulations studies in meshed grounding systems
- Contributions to frequency dependent underground cable model improvement and verification
- Contributions to full scale measuring methods for underground cable systems
- Contributions to simulation guidelines for harmonic studies in underground cable systems
- Contributions to analysis of the behavior of distance and differential protection application in underground cable systems
- Co-authored a book “Electromagnetic transients in power cables”
- Authored a comprehensive review paper (part 1 and part 2) giving the state of art for underground cable transmission system design studies as researched by the Department of Energy Technology and Energinet.dk



Publications

- [1] Claus Leth Bak, Wojciech Wiechowski, Kim Sjøgaard and Søren Damsgaard Mikkelsen, Analysis and simulation of switching surge generation when disconnecting a combined 400 kV cable/overhead line with shunt reactor, IPST 2007.
- [2] F. Faria da Silva, Claus L. Bak, M. Lind Hansen, Back-to-Back Energisation of a 60kV Cable Network - Inrush Currents Phenomenon, IEEE-PES GM 2010.
- [3] Claus L. Bak and Christian F. Jensen, Distance Protection of Cross-Bonded Transmission Cable-Systems, DPSP 2014 BEST PAPER AWARD.
- [4] F. Faria da Silva and Claus Leth Bak, Electromagnetic transients in power cables, 1st Edition, Springer 2013.
- [5] F. Faria da Silva, W. Wiechowski, C. Leth Bak, U. Stella Gudmundsdottir, Full Scale Test on a 100km, 150kV AC Cable, paper B1-301 Cigré General session 2010.
- [6] Michal Szykiel, Claus Leth Bak, and Sebastian Dollerup, Line Differential Protection Scheme Modelling for Underground 420 kV Cable Systems, EMTDC/PSCAD Relays Modelling, International Protection Testing Symposium, 2011.
- [7] Claus Leth Bak, Wojciech Wiechowski, Kristin E. Einarsdottir, Einar Andresson, Jesper M. Rasmussen and Jan Lykkegaard, Overvoltage Protection of Large Power Transformers – a real life study case, ICLP 2006.
- [8] Claus Leth Bak, Kristin Erla Einarsdóttir, Einar Andresson, Jesper M. Rasmussen, Jan Lykkegaard, and Wojciech Wiechowski, Overvoltage Protection of Large Power Transformers—A Real-Life Study Case, IEEE TRANSACTIONS ON POWER DELIVERY, VOL. 23, NO. 2, APRIL 2008.
- [9] F. Faria da Silva, C. Leth Bak and P. B. Holst, Study of Harmonics in Cable-based Transmission Networks, C4-108 Cigré General Session 2012.
- [10] C. Leth Bak and F. Faria da Silva, High Voltage AC underground cable systems for power transmission – a review, part 1, Journal of Electric Power System Research, 2015 (submitted – under review).
- [11] C. Leth Bak and F. Faria da Silva, High Voltage AC underground cable systems for power transmission – a review, part 2, Journal of Electric Power System Research, 2015 (submitted – under review).
- [12] C. Leth Bak, S. D. Mikkelsen and C. Jensen, Overhead line audible noise measurements and calculation model for snow and frosty mist, ISH 2005.
- [13] Cigré TB 556 Power System Technical Performance Issues Related to the Application of Long HVAC Cables, Cigré Technical brochure WG C4.502, Cigré 2013.



Thank you very much for your attention !



Electric power
became my destiny.

And always with
pride and joy!

