



AALBORG UNIVERSITY
DENMARK

Aalborg Universitet

Global Operations Networks

Slepnirov, Dmitriy; Wæhrens, Brian Vejrum; Johansen, John

Publication date:
2014

Document Version
Publisher's PDF, also known as Version of record

[Link to publication from Aalborg University](#)

Citation for published version (APA):
Slepnirov, D., Wæhrens, B. V., & Johansen, J. (Eds.) (2014). Global Operations Networks: Exploring New Perspectives and Agendas. (1. ed.) Aalborg: Aalborg Universitetsforlag.

General rights

Copyright and moral rights for the publications made accessible in the public portal are retained by the authors and/or other copyright owners and it is a condition of accessing publications that users recognise and abide by the legal requirements associated with these rights.

- ? Users may download and print one copy of any publication from the public portal for the purpose of private study or research.
- ? You may not further distribute the material or use it for any profit-making activity or commercial gain
- ? You may freely distribute the URL identifying the publication in the public portal ?

Take down policy

If you believe that this document breaches copyright please contact us at vbn@aub.aau.dk providing details, and we will remove access to the work immediately and investigate your claim.

Edited by Dmitrij Slepniov, Brian Vejrum Waehrens & John Johansen

GLOBAL OPERATIONS NETWORKS

EXPLORING NEW
PERSPECTIVES
AND AGENDAS

AALBORG UNIVERSITY PRESS

Global Operations Networks: Exploring New Perspectives and Agendas

Edited by

Dmitrij Slepnirov, Brian Vejrum Waehrens & John Johansen

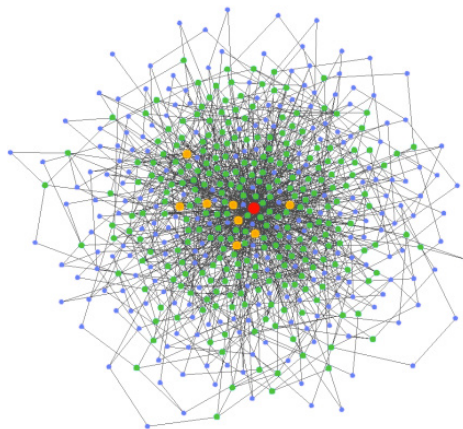

AALBORG UNIVERSITY PRESS

Global Operations Networks:

Exploring New Perspectives and Agendas

Edited by Dmitriy Slepniov, Brian Vejrum Waehrens & John Johansen

1. E-book edition (Open access)

© The authors and Aalborg University Press, 2014

Layout: Hofdamerne ApS v/ Cecilie von Haffner & Lea Rathnov

ISBN: 978-87-7112-191-9

Published by:

Aalborg University Press

Skjernvej 4A, 2nd floor

DK – 9220 Aalborg Ø

Phone: +45 99407140

aauf@forlag.aau.dk

forlag.aau.dk

This book is published with financial support from Center for Industrial Production, Aalborg University.

All rights reserved. No part of this book may be reprinted or reproduced or utilized in any form or by any electronic, mechanical, or other means, now known or hereafter invented, including photocopying and recording, or in any information storage or retrieval system, without permission in writing from the publishers, except for reviews and short excerpts in scholarly publications.

CONTENTS

PREFACE	5
Acknowledgements	5
Objectives	5
Themes and Structure of the Book	6
Overview of the Contributions	8
SECTION 1	13
Chapter 1	
Offshoring and Changes in Firms' Domestic Employment: The Case of Denmark	15
<i>Bram Timmermans & Christian Richter Østergaard</i>	
Chapter 2	
Factory Roles: A Scandinavian Perspective	55
<i>Marja Blomqvist, Virpi Turkulainen, Eero Eloranta & Aki Laiho</i>	
Chapter 3	
Operations Network Development: Internalisation and Externalisation of Value Chain Activities	85
<i>Yang Cheng & John Johansen</i>	
Chapter 4	
Managing Hidden Costs of Offshoring: Learning to Achieve System Integration	115
<i>Marcus M. Larsen & Torben Pedersen</i>	
Chapter 5	
Managing Increasing Technological Complexity: Delivering Large System Products	143
<i>Mikko Mattila</i>	
Chapter 6	
Managing Sustainability: Capabilities For Sustainable Operations	163
<i>Johanna K. Jaskari</i>	

Chapter 7	
Servitisation in Danish Manufacturing Firms: A Strategy for Survival?	183
<i>Dmitrij Slepnirov, Brian Vejrum Waehrens & John Johansen</i>	
Chapter 8	
Designing an Operations Network	203
<i>Aki Laiho & Marja Blomqvist</i>	
Chapter 9	
Integration of Manufacturing and Development in Emerging Markets	225
<i>Peder Veng Sjøberg & Brian Vejrum Wæhrens</i>	
Chapter 10	
The Future of Manufacturing in High-Cost Countries – A Finnish Perspective	247
<i>Eero Eloranta, Marja Blomqvist & Aki Laiho</i>	
SECTION 2	283
Case 1	
Consequences and Opportunities of a Global Two-Factory Production Network	285
<i>Anna Fredriksson & Patrik Jonsson</i>	
Case 2	
The Dynamics of Make vs. Buy Decisions in a Global Economy – A Firm Study	307
<i>Kari Jussila, Michael Gylling & Markku Saarinen</i>	

PREFACE

ACKNOWLEDGEMENTS

Many individuals helped shape this volume and we would like to express our deep appreciation to all of them. For more than three years the Global Operations Networks (GONE) project brought together numerous academic and industrial partners from Denmark, Sweden and Finland. Our big Thank you goes to all of them for their interest and commitment to the study.

We are also particularly grateful to the sponsors of this volume: Danish Research Council (Det Strategiske Forskningsråd (KINO), Projekttilitel: Global Operations Networks (GONE).'

OBJECTIVES

This book has been planned as a collective and collaborative effort of all international partners affiliated with Global Operations Networks (GONE) project. The project has outlined the contours of contemporary global operations networks, risks and benefits as well as managerial and other processes associated with them.

There are several objectives of this book: 1) to collect some of the project results into one summative volume; 2) to disseminate the results to academics and practitioners; and 3) to provide supplementary inputs to teaching materials on the subject of global operations and operations strategy.

This volume utilises the rich and diverse empirical foundation generated during the project activities in Denmark, Sweden and Finland. Chapters of the book are based on quantitative data and multiple case studies which the project partners have been closely working with, and which are best suited to illuminate a particular aspect of organising and managing global operations in networks.

THEMES AND STRUCTURE OF THE BOOK

The book addresses the following broadly defined themes:

- Global operations networks: insights from the Scandinavian context;
- Contexts of global operations networks;
- Configurations of global operations networks;
- Capabilities and processes; and
- Trajectories and reconfiguration.

The themes are intended to incorporate elements which in combination provide a comprehensive multidisciplinary view on operations networks.

- Behind these themes lay clusters of questions and topics that guide the contributions to the book. To better define the scope of the book, these clusters are unpacked and discussed in more detail in the following sections.

Global Operations Networks

– Insights from the Scandinavian Context

In the current context of global economic liberalisation and technological advancements, industrial companies are less likely to generate products in the traditional vertically integrated value chain. Instead, they are doing so by means of elaborate cross-border and cross-organisational networks. As a rule, these networks are configured on a global basis and consist of diverse and interdependent affiliates (linked both through ownership and nonequity relationships), which are engaged in an exchange of goods, services and information.

The Scandinavian context is no exception to this trend. Nevertheless, international comparative studies providing comprehensive insights from it are still rare. To contribute to bridging this gap, this book focus-

es on the general theme of global operations networks originating in the Scandinavian context. This is covered through theoretical insights and a set of case studies of Danish, Swedish and Finish firms.

Contexts

In much of the previous work on production networks, the environment has been treated as an exogenous factor and a source of undefined uncertainties. In other words, traditionally, environment is 'put into brackets' as opposed to being seen as a field of specific interactions coevolving with the organisations embedded in it. The aspirations of the GONE project are to treat the environment as a vital part of the operations network and to address the relationship between multiple levels of analysis (firm-industry-nation).

Configurations

The 'configurations' theme of the book deals with the structural dimension of global operations networks. This dimension encompasses multiple interrelated variables. In uncovering them, ownership/partnership mode and location of sites can be taken as a point of departure for the analysis of global operations configuration choices.

Configurations gravitating towards captive partnership mode can be categorised as *rooted*, while those gravitating towards contractual mode may be called *footloose* (Ferdows, 2008). Driven by forces inside and outside the firm, manufacturing companies move towards either of the two generic operations strategies: 1) build a footloose operations network by outsourcing operations units to lower-cost locations (offshore outsourcing), or 2) build a rooted operations network, by strengthening capabilities in existing vertically integrated operating units (captive offshoring). However, the contributions to the book also point to the prominent existence of the intermediary form, which encompasses elements of both footloose and rooted strategies.

Capabilities and Processes

The structural issues focus on 'bricks and mortar' decisions about number, location, capacity and ownership of sites. However, how these are bound together is equally, or perhaps even more important. There-

fore, the book also attends to the 'infrastructure' of global operations networks, or in other words, capabilities and processes required for aligning internationally dispersed operations into a cohesive global network.

Trajectories and Reconfiguration

Operations networks are not static; rather they are in constant motion and may be studied through their temporality. From the outset, suppliers may be given only operational roles, while the focal company keeps the responsibility for innovation, product development, design and other strategic activities. However, such distribution of roles within a group of companies is likely to change over time. The constant 'process of becoming' that applies to global operation networks poses a major challenge for decision making and strategy development in the companies involved. The focal organisations are under pressure to orchestrate their partners and monitor developments in the network on a continuous basis. Therefore, the focus of this concluding part of the book is on temporality and the constant reconfiguration of operations networks.

OVERVIEW OF THE CONTRIBUTIONS

The book opens with the chapter by Bram Timmermans and Christian Richter Østergaard. The authors take a national perspective on the operations networks and investigate the difference in employment between offshoring and nonoffshoring firms that are active in manufacturing industries and business services in Denmark. The chapter concludes that there are clear differences between Danish offshoring and nonoffshoring firms in terms of employment growth and how the employee skill composition changes over time. The change in employment composition differs considerably between manufacturing industries and business services and has significant implications for whether firms offshore administrative and technical business functions or other types of business functions.

Marja Blomqvist, Virpi Turkulainen, Eero Eloranta and Aki Laiho discuss roles that are assigned to factories located in the context of high

labour costs. Finland is used as an example. The authors discuss existing models of factory roles and report research findings from a survey of factories located in Finland. The chapter adds to the book by providing a regional point of view and establishing what kinds of roles are typical in the context of small local markets and a high labour cost area, such as Scandinavia. Practitioners can also use the chapter in assessing their own factory networks and the corresponding factory roles.

Yang Cheng and John Johansen investigate a broad theoretical base, and based on the analysis of three cases of Danish companies, discuss various development trajectories in global operations networks. The authors propose that the discussions on internationalisation and externalisation need to be extended from manufacturing activity to other value chain activities. The chapter concludes with recommendations for managers on the importance of maintaining a relative balance between various trajectories in order to manage a global collaborative value network.

Marcus M. Larsen and Torben Pedersen investigate the concept of the 'hidden costs' of offshoring, i.e. unexpected costs exceeding the initially expected costs of offshoring. Using the LEGO Group case, the authors argue that a major response to the hidden costs of offshoring is the identification and utilisation of strategic mechanisms in the organisational design to eventually achieve system integration of a globally dispersed and disaggregated organisation.

Mikko Mattila focuses on how companies can manage the increasing technological complexity associated with the growing variety of the products and evolving technology. The situation results in challenges in managing deliveries, manufacturing, order handling and decision making. The case of the KONE Group is used to illustrate these challenges. The chapter concludes with looking at ways to manage complexity through the product structure and architecture design throughout the lifecycle of a product.

Johanna K. Jaskari zooms in on an emerging sustainability agenda for global operations networks and explores how two emerging sustain-

ability issues – carbon neutrality and low-energy use for operations networks – may transform industrial firms' processes in different industrial contexts. Based on interviews in global Finnish manufacturing firms, the issues in this area are analysed from different perspectives. The results of the analysis provide insights into how managers can create and maintain sustainable carbon neutral and low-energy operations in future industrial contexts.

Dmitrij Slepnirov, Brian Vejrum Waehrens and John Johansen focus on servitisation, i.e. the refocusing of firms from running fabrication and assembly processes to developing integrated product solutions with a large service component. Based on multiple cases of Danish companies, this chapter outlines the main reasons for and strategic implications of servitisation. Furthermore, it delineates strategies for how traditional manufacturers can recoup the desired level of return from the developments associated with servitisation.

Aki Laiho and Marja Blomqvist discuss the challenge of operations network design in a global environment. The design process is often related to a substantial change, specifically strategy change, restructuring or expansion. The chapter is built around case research with five Finnish small and medium-sized enterprises (SMEs) and a parallel literature review. The authors dedicate their effort on the factors that need to be taken into account when designing a network and conclude with a design framework that can be used by both academics and practitioners.

Peder Veng Sjøberg and Brian Vejrum Wæhrens investigate the problems related to functional integration between manufacturing activities and research and development (R&D) activities of multinational companies in emerging markets. The authors develop a framework and use four case studies to illustrate its use. The findings point to the importance of adopting cross-functional colocation drivers and contingencies such as clockspeed and technological complexity, as well as the extent to which local adaptation is needed as an integral part of corporate relocation decisions.

Eero Eloranta, Marja Blomqvist and Aki Laiho focus on the future of manufacturing in high-cost countries. The perspective of this chapter is that of a manufacturing company with production facilities in Finland and other Nordic countries. The authors introduce a multilayer model for designing and locating factories in these countries to support the primary corporate competitive strategy and the related production imperative. The chapter concludes that the production of factories located in high-cost countries should focus on the imperatives of the production of the first product, the production of the best product and agile production, while mass production in high-cost countries seldom seems to be justified.

The book closes with two cases that provide more in-depth empirical insights from Sweden and Finland.

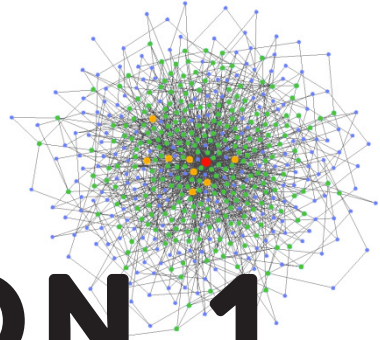

SECTION 1

CHAPTER 1

Offshoring and Changes in Firms' Domestic Employment: The Case of Denmark

Bram Timmermans, *Aalborg University, Denmark*

Christian Richter Østergaard, *Aalborg University, Denmark*

ABSTRACT

In this chapter, by merging the Danish linked employer-employee database with a large-scale Danish offshoring survey, we investigate, the difference in employment between offshoring and nonoffshoring firms that are active in manufacturing industries and business services in Denmark. The findings of the analyses show that there are clear differences between Danish offshoring and nonoffshoring firms in employment growth and how the employee skill composition changes over time. The change in employment composition differs considerably between manufacturing industries and business services and in whether firms offshore administrative and technical business functions or other types of business functions.

INTRODUCTION

Over the last couple of years, offshoring and outsourcing have received increasing attention in both the business press and within academia (see e.g. Bertrand, 2011; Jensen & Pedersen, 2011; Maskell, Pedersen, Petersen, & Dick-Nielsen, 2007; Rasheed & Gilley, 2005). Offshoring decisions are regarded as being of strategic importance for firms in order to (i) reduce the costs of production and/or bring about other efficiency gains to remain competitive, (ii) penetrate and strengthen a firm's po-

sition in foreign markets and (iii) provide access to international pools of knowledge. Traditionally, offshoring involved to relocation of routinised production activities and standardised services (Mudambi, 2007). However, in the last 10 to 15 years, a shift has occurred, since these activities move along a learning path leading to the offshoring of additional value-added and related activities (Maskell et al., 2007). This might explain why we more frequently observe the offshoring of knowledge-intensive activities, such as research and development (R&D), engineering functions and management and administrative tasks.

Offshoring has been studied from various angles; however, one of the most debated issues related to offshoring is its impact on domestic employment. Most studies which investigate the impact of offshore outsourcing on the overall employment composition of home country industries have been inspired by the pioneering work of Feenstra and Hanson (1996). The point of departure in their study was to test whether offshoring could be an alternative explanation in the increased demand for skilled labour, which negatively influences the wage level of low-skilled workers and thus creates more wage inequality in an economy. Up to this point, most politicians and academics were of the opinion that international trade, including offshoring, hardly had any general employment impact and that the increased wage inequality could mainly be attributed to the skill-biased technological change (Berman, Bound, & Griliches, 1998). Feenstra and Hanson's findings spurred a line of studies investigating the impact of offshore outsourcing on the demand of low-skilled labour in other non-US countries through a variety of methods (e.g. Egger, Pfaffermayr, & Wolfmayr-Schnitzer, 2001; Falk & Koebel, 2002; Hijzen, Görg, & Hine, 2005; Strauss-Kahn, 2004). Most of these studies confirmed that offshore outsourcing contributes significantly to a relative increase in the demand for high-skilled labour.

In this chapter, we add to the existing work on offshoring and the overall effect on firms' domestic employment by moving beyond the anecdotal evidence and the macroeconomic perspective. We empirically investigate the microeconomic effects of offshoring on the change in domestic employment by comparing offshoring and non-offshoring firms in Danish manufacturing and business services. In addition to

existing studies that focus on employment and the often-used low- and high-skill taxonomy, we extend this investigation in two ways. First, when firms decide to offshore their activities, it might change not only the demand from low- to high-skilled labour but also the demand for specific types of skills. This can partly be explained by the impact of servitisation, where domestic manufacturing activities are being replaced by more developed integrated product solutions, including a high service component (see Slepnirov et al. in this book for a broader discussion on servitisation within global operation networks). This change of focus most likely leads to demand for another type of skills, and not necessarily to a change in the overall level of skills. Second, firms engaged in offshoring often go through different stages, where the company learns from initial offshoring of simple production and subsequently offshores a larger share of their productions, including other production-related activities, e.g. the offshoring of more value-added activities such as engineering and R&D (Maskell et al., 2007). Consequently, it can be expected that firms which offshore more value-added activities experience a change in employment that is different compared to firms that offshore the more traditional production tasks. Therefore, it is necessary to track changes in numbers of employees in more detail, rather than only looking at the aggregate wage bill.

To investigate these issues, we rely on an offshoring survey conducted by Statistics Denmark in 2007.¹ This survey was part of a wider European project with the purpose of gathering information on several aspects of international offshoring, e.g. target countries, kinds of activities that have been offshored, motivation factors, impact, barriers and the consequences for domestic employment during the period 2001–2006. The survey was distributed among all Danish firms with more than 50 employees and a sample of firms with 20–50 employees. The benefits of using this survey are as follows: (i) a more accurate measure of offshoring – existing studies create a proxy for outsourcing and offshoring by looking at imports and exports, while international outsourcing and offshoring is a much rarer phenomenon than interna-

1 Statistics Denmark refers to this survey as an outsourcing survey. However, the definition they use refers more to offshoring than to outsourcing.

tional procurement and trade; (ii) existing research tends to focus on larger firms, but the survey also provides insights into the offshoring activities, divided into different types of business functions, of small and medium-sized enterprises (SMEs); and (iii) the large-scale survey allow the study of general offshoring trends, not just single cases.

This survey will be merged with the Danish Integrated Database for Labour Market Research (IDA). IDA is a universal and longitudinal database that provides detailed information on all establishments and all individuals in Denmark in the period 1980 and onwards. Due to the unique person and plant identification number, it is possible to identify the human resource composition of each establishment, as well as on the aggregated industry level. Because the IDA provides detailed information on education, it is possible to proxy the level of skills and type of skills. Consequently, in addition to the strengths offered by the survey, another strength is that in contrast to most of the studies that exist, it is possible to investigate the change in employment on the firm level (a notable exception within international economics is Görg and Hanley (2005), who investigated the labour demand effects of international outsourcing on plant-level data).

The research conducted in this chapter will contribute to the literature in the following three ways. First, the study will provide firm-level evidence on the difference in the overall change of domestic employment between offshoring and nonoffshoring firms. In addition, it will be possible to observe the trend during an economic recession. A crisis situation is often a motivation for firms to engage in offshoring (Larsen and Pedersen's chapter shows that this was the case for Lego). By following the trend in employment for the period 2000–2007, it will be possible to identify how offshoring and nonoffshoring firms reacted during and just after this recession in 2001. Such a recession resulted in layoffs, and although the following economic recovery provided new jobs recovery may also affect the rehiring of employees differently in offshoring compared to nonoffshoring firms, e.g. the economic downturn can lead to a restructuring on the allocation of labour. Second, the chapter will investigate whether a change can be observed in the type of skills required between offshoring and nonoffshoring firms in

the various industries. Third, the study will provide insights into how employment changes depend on the type of business function that is being offshored.

In the next section, we give more information on the offshoring phenomenon and how offshoring has moved from primarily production to other, more valued added activities. Afterwards, we will discuss how offshoring has affected firms' domestic employment, and based on this existing work, we will identify the major shortcomings of the literature and formulate the research questions that will be addressed in this chapter. After this theoretical exercise, we will move towards the empirical analysis by presenting the method of analysing the difference in employment growth, the data and the empirical results. The chapter will conclude with a discussion of the findings and suggestions for future research.

THEORY

The offshoring phenomenon

Offshoring refers to 'the process by which companies undertake some activities at offshore locations instead of their countries of origin' (Kumar, van Fenema, & von Glinow, 2009, p. 642). The term *offshoring* can refer to two types of relocation activities: (i) when a firm offshores activities to a firm's own affiliate outside the home country, this is called internal or captive offshoring; while (ii) offshoring to an independent unaffiliated partner or supplier is referred to as offshore outsourcing (Kenney et al., 2009). In this chapter, we refer to either of these two activities as offshoring. The offshoring phenomenon has been part of the corporate landscape for several decades, and more than 30 years' worth of research can be found on the topic (Hätönen & Eriksson, 2009; Jensen & Pedersen, 2011; Lewin & Peeters, 2006; Maskell et al., 2007). Nevertheless, only recently has the offshoring phenomenon received increased attention in the public media and academic literature (Bertrand, 2011; Jensen & Pedersen, 2011; Maskell et al., 2007; Rasheed & Gilley, 2005). This increasing interest can be attributed to the increased fragmentation of production processes and the associated rise in offshoring activities as a result of technological changes, e.g. lowering of

transportation costs and advancements in communication technologies, economic and competitive pressures to reduce costs and improve productivity and institutional developments that are in favour of trade liberalisation (Bertrand, 2011; Olsen, 2006). By offshoring, firms attempt to gain access to the comparative advantage of offshore locations (e.g. low cost of production and/or labour, access to skilled labour and new markets) in combination with their own resources and competencies (McCann & Mudambi, 2005; Mudambi, 2008). These benefits are then weighted against the costs associated with having a geographically dispersed production network. Since offshoring primarily involves production, as well as the most routinised production activities, combined with the decreasing costs of logistics and the often low cost of production factors in the offshore location, these benefits generally outweigh the cost of offshoring.

When firms started to engage in the relocation of firm activities, this primarily affected production and blue-collar jobs. Since the mid-1990s, a shift occurred where offshoring has been moving up the value chain, not only affecting production and standardised services, but also activities such as R&D – a process that was mainly driven by advancements in communication technology (Lewin & Peeters, 2006). Up to that point, it was difficult to imagine that firms would be offshoring administrative and technical business functions, including information technology, call centres, engineering tasks and R&D activities, to non-Organisation for Economic Co-operation and Development (OECD) nations (Kenney et al., 2009). Nevertheless, this change from offshoring solely production to the offshoring of other, more value added, types of activities is not that easy. Maskell et al. (2007) identified this shift much more with a learning process, where firms started out with offshoring for cost reasons, but slowly moved into more differentiated offshoring strategies, including more innovation-based ones (Kenney et al., 2009).

Arguably, depending on where firms are in this offshoring learning process, a different pattern in the demand for skilled labour might emerge, for example, amongst firms that are exclusively engaged in the offshoring of core business functions, e.g. production. Instead of only losing domestic employees, firms might put their focus on other types

of activities within the value chain close to their home base. The activities developed in the home market focus more on the provision of services related to the core business function, a process often referred to as *servitisation* (see Slepnirov et al. in this volume for a more thorough discussion on this phenomenon). It can be assumed that this process of servitisation would require a different skill-set.

Given the learning process of offshoring, firms will gradually offshore these value-added activities, which will again lead to a change in the demand of skills, i.e. the domestic demand of skills associated with the servitisation process will be negatively affected due to the offshoring of other, more value added business functions. Consequently, treating offshoring as a general phenomenon when investigating the overall domestic employment effect would be inconclusive and it is necessary to consider the type of activities offshored in order to provide a more accurate picture on the change in employment.

Offshoring and domestic employment

The topic of offshoring is closely related to the demand for labour. Early offshoring activities were mainly motivated by labour cost reduction but the access to talent in offshoring destination gained in importance as a motivation for offshoring (Florida, 1997). Nowadays, firms are actively engaged in accessing pools of talent in countries like China, India and Brazil (Couto, Mani, Lewin, & Peeters, 2007; Lewin & Peeters, 2006; Manning, Lewin, & Massini, 2008), partly due to the availability of cheap skilled labour in these countries and partly the lack of trained personnel, in particular science and engineering graduates, in the developed world (Manning et al., 2008).

Despite this changing offshoring pattern, there are hardly any studies at the firm level that have addressed the issue of how firms' domestic employment changes as a result of offshoring and taken into account the type of business function being outsourced and in what industry the outsourcing firm is active. An exception is Teirlinck et al. (2010), who addressed the issue of R&D outsourcing and R&D employment intensity. However, undisputedly, offshoring activities have a direct impact on firms' employment because of plant closures, plant relocations

or large reductions in operations (Di Gregorio et al., 2009) and offshoring of more value added activities might lead to a relative decrease in the demand of this more highly skilled type of labour.

The study of Feenstra and Hanson (1996), which adopted a broad definition of offshoring (referred to as outsourcing), investigated the role of both skill-biased technological change and outsourcing, the two most heavily cited explanations for the relative decline in the wages of low-skilled workers. Up to that point, the role of offshoring had hardly been investigated, as most researchers and policymakers put emphasis on the impact of skill-biased technological change, i.e. the relative decrease in the demand for low-skilled labour is a result of investments in technology that can replace this type of labour, (see, e.g. Berman, Bound & Grilliches, 1994). Feenstra and Hanson, however, followed a comparative advantage perspective of outsourcing by stating that the import competition resulting from offshore outsourcing will result in a move of nonskilled activities abroad and a shift of employment towards skilled workers within these industries. To investigate this, they used import data for all US manufacturing industries from the National Bureau of Economic Research (NBER) trade database for the period 1972–1994 in combination with disaggregated data on input purchases from the Census of Manufacturing to estimate the industry-by-industry outsourcing for the period 1972–1992.² To distinguish between low-skilled and skilled workers, they use non-production workers' share of the industry wage bill to measure the relative demand for skilled labour. The result of their study was that skill-biased technological change played an important role in the wage gap between skilled and unskilled workers, but approximately 15% of this gap could be explained by outsourcing (Feenstra & Hanson, 1999).

Following this pioneering work, other studies investigated the impact of offshoring on the employment structure in other non-US countries like Austria (Egger & Egger, 2003; Egger et al., 2001), Germany (Falk & Koebel, 2002; Geishecker, 2006), Sweden (Ekholm & Hakkala, 2008),

² They measured the extent of offshoring as the share of imported intermediate inputs in the total purchase of non-energy materials.

France (Strauss-Kahn, 2004), Denmark (Munch & Skaksen, 2009), the United Kingdom (Hijzen et al., 2005), Ireland (Görg & Hanley, 2005) and Japan (Head & Ries, 2002). Based on various types of methods, some more elaborate than others depending on the availability of data, and definitions, whether using a broad or more narrow definition, all of these studies identified a negative impact of offshoring on the low-skilled labour force.

Despite their similar results, these macro-based studies have some major shortcomings. The first problem is with their definitions of *offshoring* and outsourcing. On their level of aggregation, there are hardly any data available that indisputably indicate offshoring; instead, the studies rely mainly on import and export data. Offshoring, however, is a rarer phenomenon than international trade. Second, these studies are based on country or industry aggregates and do not provide any insights into how offshoring firms perform in relation to nonoffshoring firms. Finally, they all take a position whereby offshoring involves the relocation of low value added activities. Although most of the jobs that are offshored are low-skilled jobs, which amounts to approximately two-thirds of all job losses (Munch & Skaksen, 2009), this disregards the effect of offshoring administrative and technical business functions.

In this chapter, we investigate the issue of change in domestic employment using three related research questions that have to do with the effect of offshoring:

1. How does the overall level of employment differ between Danish offshoring and nonoffshoring firms? This research question focuses on the level of the firm, but also makes a distinction between manufacturing and business services.
2. Focusing on both the level of skills and the types of skills, how do offshoring and non-offshoring firms in Denmark differ in terms of the change in high-skilled workers?
3. Is there a difference in the change in employment between firms whose offshoring includes administrative and technical

business functions compared to firms that offshore other business functions?

METHOD

The purpose of this study is to compare how offshoring firms differ in the growth of (high-skilled) employment compared to nonoffshoring firms. A problem that arises is that, based on their characteristics, some firms are more likely to (not) engage in offshoring than others (e.g. based on size and industry characteristics). Consequently, there is a selection bias which makes it difficult to assess whether the difference in employment is a result of offshoring or another feature. This issue can be addressed using matching estimators. In essence, it is possible to test what a firm that offshored business functions (a treated firm), with a given set of characteristics, would have done if it had not offshored (not received treatment). Thus, in order to evaluate how offshoring firms differ from nonoffshoring firms, it is important that for each offshoring firm a match is found among the subsample of non-offshoring firms.³

There is a choice between several matching approaches. In this study, we will incorporate a partial propensity score matching method, where we use a combination of covariate matching and propensity score matching. The covariate matching technique matches treated and untreated firms based on a set of covariates on which they have to be similar. A problem of this approach is the curse of dimensionality (Caliendo & Kopeinig, 2008), which occurs because conditioning on all relevant covariates is limited when the number of covariates is high. On the other hand, propensity score matching can solve this problem (Rosenbaum & Rubin, 1983) and this is why we combine the two matching methods. With this matching procedure, we start by using a logit mod-

3 This approach is similar to testing the impact of a specific type of medication on a patient. To assess this, two individuals with identical characteristics (same age, gender, health condition, etc.) are selected, where one receives the medication and the other person does not (often, her or she will receive a placebo). After the treatment period, how the medication affected the person in question is assessed by comparing the progression of the two individuals.

el to estimate the propensity for a firm to engage in offshoring based on a set of variables that can explain a firm's decision to offshore. This propensity score is then used as a matching criterion. In our partial propensity score matching approach, we take the point of departure in the propensity score, but include two additional covariate-matching criteria that should be met, i.e. the firms must be active in the same industry class and be in the same size category. Thus, after we calculate the propensity scores and matched the treated and untreated firms on industry and size class, we will conduct calliper matching.⁴ In this approach, we impose a tolerance level on the maximum propensity score distance, which we set at 5 percentage points. All matches in this range will be included in the analysis.⁵

As a result of this matching procedure, those firms that are so unique that they cannot be matched with another firm will be removed from the sample. To illustrate this, Denmark has several national champions – large multinational companies that are active within a specific industry (e.g. Danfoss, Grundfos, Lego, Vestas, Novo Nordisk). It appears to be impossible, within the Danish context, to find a firm that matches any of these champions' characteristics and which at the same time did not engage in offshoring; similarly, some firms have such a low propensity to outsource that it is impossible to match them with a firm that, given its characteristics, has engaged in offshoring. For this reason, it is likely that these national champions and those firms with a very low propensity score will be excluded from the matched sample.⁶

A limitation of this matching approach is that it is only possible to select observable covariates. Consequently, one assumes that there are no unobserved characteristics that explain whether a firm is engaged in offshoring. Although it is impossible to observe all the determinants,

4 Other often-used matching techniques are: nearest neighbor matching, radius matching, stratification and interval matching and kernel matching (Caliendo & Kopeinig, 2008).

5 In other matching procedures, e.g. nearest neighbor matching, only one match per treated firm is often included.

6 Due to the anonymity of the data, it is not possible to identify whether this is the case for (all of) these Danish national champions.

we maintain the assumption that we can observe all the important determinants of offshoring.

DATA AND SAMPLE

To investigate the issue at hand, we will investigate the change in employee composition in Danish manufacturing and business services. As indicated by Jensen and Pedersen (2011), '[t]he Danish economy is closely tied to the international economy and is thus subject to global economic flows and trends, including offshoring trends' (p. 9). The sample which will be used for the analysis is taken from a Danish survey on the offshoring of business functions; this was conducted in 2007 as part of a wider European-based project. This project investigated different aspects of offshoring, e.g. target countries, kinds of business activities the firm has offshored, motivation factors, effects, barriers and the consequences for domestic employment in the period 2001–2006 in 13 EU member states and European Economic Area (EEA) countries.⁷ The survey was distributed among all Danish firms with more than 50 employees (with a response rate of approximately 97%). In addition, the survey was supplemented with a sample of firms in the size category of 20–49 employees. The total number of observations in the Danish offshoring survey was 4,161.

This survey provides a number of advantages over other methods of investigating this issue. First, it presents the possibility of identifying firms that are actually engaged in offshoring; earlier studies provided proxies of both offshoring and outsourcing by defining offshoring and outsourcing in terms of procurement activities, e.g. imported inputs, parts and components purchased abroad, etc. (Horgos, 2009). As mentioned by Gilley and Rasheed (2000), offshoring and outsourcing cannot be defined as simply a purchasing decision, because all firms have some procurement element in their operations, while offshoring and outsourcing are less common activities. In this survey, offshoring is defined as 'the total or partial movement of business functions (core

⁷ Countries that participated are: Czech Republic, Denmark, Germany, Ireland, Norway, Spain Italy, Portugal, Slovenia, Finland, Sweden and the United Kingdom.

or support business functions) performed in-house or domestically outsourced by the resident enterprise to either non-affiliated (external suppliers) or affiliated enterprises located abroad' (Statistics Denmark, 2008, p. 13).⁸

A second advantage of this survey is that it offers a broader perspective regarding offshoring. Many studies on offshoring focus on anecdotal evidence of strategies conducted by large firms. Nevertheless, globalisation pressures and offshoring are not only present within large firms; they are also part of the competitive landscape of SMEs. This survey includes small and medium-sized firms, i.e. firms that had at least 20 employees in 2007.

A final strength of the offshoring survey is the possibility to merge it with IDA. IDA is a longitudinal linked employer-employee dataset constructed from government registers and maintained by Statistics Denmark; see Timmermans (2010) for a thorough description of this database and its use. Its longitudinal nature enables us to identify changes in employment structures and labour mobility flow by comparing employer-employee relationships in consecutive years. A change in this relationship would indicate a change in the employment composition. The education background (based on a detailed eight-digit education class) is the employee characteristic that attracts our main interest. This variable makes a distinction between higher and lower education and the type of background. In this study, we are particularly concerned with the divide between science and engineering, which has a strong manufacturing angle, and social sciences and administration, which can be linked more with the servitisation perspective.

All the firms in the survey can be merged with IDA, but before starting the analysis, we set a number of criteria for the firms that are selected for our final sample. First, we will only select those firms that are active in manufacturing industries (NACE 15–37) and business services

⁸ Statistics Denmark refers to this survey as an outsourcing survey. However, the definition they use refers more to offshoring than to outsourcing. Furthermore, this definition is narrower compared to the definition provided by Kumar et al. (2009).

(NACE 72–74), which narrows the sample down to 2,631 observations. Furthermore, we are interested in the change in employment structure; thus, we select two years in which this change occurs. It would be ideal to evaluate the change in skill composition just before and shortly after offshoring has taken place; however, the survey does not allow for such an analysis, since it asks about the outsourcing activities in the period 2001–2006. For this reason, we select those firms that were active in both years and analyse the subsequent change between these two years. In the survey, 2,098 firms fulfil both criteria. Furthermore, it is possible to see how the general employment trend varies between offshoring and nonoffshoring firms during times of crisis. A crisis situation is often a motivation for firms to engage in offshoring (Larsen and Pedersen’s chapter shows that this was the case for LEGO). Denmark, like many other parts of Europe, was hit by an economic recession in the early 2000s. This recession caused an increase in Danish unemployment. It is thus possible to identify how the different firms reacted during the upswing of the economy in the following years.

In addition to the above-mentioned advantages of the survey, there are, next to the general limitation of survey-based studies, some survey-specific limitations. First, this offshoring survey asks only on whether firms offshore, but not about the magnitude of offshoring. It is therefore not possible to identify whether firms engage in large offshoring activities that affect the domestic operations to a large extent, or whether it involves the relocation of a single job position. Second, we only observe whether firms have been engaged in offshoring over a five-year period (2001–2006). A more precise indication on the offshoring activity, e.g. the year of offshoring, is not available. Third, the indications of business functions, in particular core business functions, are not strictly defined. Firms might perceive any of the supporting business functions, i.e. information technology (IT), logistics, sales, R&D, etc., as core activities. Finally, we only select surviving companies. This means that firms that engaged in offshoring in the period 2001–2006 but closed down in the same period will not be observed.

Treatment variables

The treatment variable is a dummy variable that has the value 1 whenever the firm in the sample indicates that it was engaged in offshoring in the period 2001–2006 (OFFSHORE=1); otherwise, the variable has the value 0 (OFFSHORE=0). A firm is considered active in offshoring when it has offshored one or more of the following business functions: (i) core business functions; (ii) distribution and logistics; (iii) marketing, sales and after sales services; (iv) information and communication technology (ICT) services; (v) administrative and management functions; (vi) engineering and related technical services; (vii) R&D; and (viii) other functions. In total, 440 firms answered that they had offshored one or more business functions during the period 2001–2006.

Table 1. Offshored functions of firms in the full sample

Offshored functions	Offshoring (n=440)		
	#	%	% of offshoring firms
Core business functions*	268	12.77	60.90
Distribution and logistics	78	3.72	17.73
Marketing, sales and after sales services	69	3.29	15.68
ICT services	83	3.96	18.86
Administrative and management functions	47	2.24	10.68
Engineering and related technical services	105	5.00	23.86
R&D	74	3.53	16.82
Other functions	37	1.76	8.41

* Statistics Denmark (2008, p. 13) states that core business functions include the production of final goods or services intended for the market/for third parties carried out by the enterprise and yielding income. The core business function in most cases equals the primary activity of the enterprise. It may also include other (secondary) activities if the enterprise considers these to comprise part of its core functions

Table 1 presents the distribution of the different types of functions that have been offshored. The majority of offshoring firms offshore only one business function (i.e. 265 firms), primarily the core business functions (i.e. 155 firms). The remaining 175 firms offshore a combination of business functions in the period 2001–2006.⁹

Control variables

The control variables are those observable characteristics of the firm that can be considered as important determinants of offshoring. Whenever possible, these variables are measured at the beginning of the period, i.e. all at the start of 2001. Due to the longitudinal nature of the IDA, it is possible to obtain various firm characteristics from the end of 2000, which is prior to the observation period 2001–2006.¹⁰

It is crucial to include only variables that have a significant impact on the likelihood to offshore. Some variables are known to determine the likelihood of offshoring, e.g. industry and size.

For industry classes we applied a relative narrow industry definition based on the NACE (rev 1.1.) industry classification, i.e. manufacturing of food beverages and tobacco; manufacturing of textiles and leather; manufacturing of wood and paper products; publishing, printing and reproduction of recorded media; manufacturing of chemical products; manufacturing of plastics; manufacturing of other nonmetallic mineral products; manufacturing of basic metals and fabricated metal products; manufacturing of machinery and equipment; manufacturing of electrical and optical equipment; manufacturing of transport equipment; manufacturing of furniture and other manufacturing; computer and related activities; R&D; business consultancy; technical consultancy; and other business services. As a measure of size, we identified the size of each firm in the sample in 2000. To control for the skewness in size, the natural log is taken.

9 It is likely that firms already offshored some of their business activities in the period before 2001. A limitation of this study is that we cannot check which firms have done this.

10 All information for the year 2000 was obtained in the end of the year (primarily in November). This would give a good estimation on the characteristics of the firm at the start of 2001

Table 2. Industries and size category distribution

Industry	Total (n=2,058)		Offshoring (n=440)		
	#	%	#	%	% of industry
			6	215	7.90
			24	23	10.21
			22	77	20.94
			32		28.89
Manu. of food, beverages and tobacco	158	7.53	25	5.68	15.82
Manu. of textiles and leather	47	2.24	23	5.23	48.94
Manu. of wood and paper products	107	5.10	12	2.73	11.21
Publishing, printing and reproduction of recorded media	107	5.10	11	2.50	10.28
Manu. of chemicals products	63	3.00	15	3.41	23.81
Manu. of plastics	102	4.86	19	4.32	18.63
Manu. of other nonmetallic mineral products	74	3.53	8	1.82	10.81
Manu. of basic metals and fabricated metal products	283	13.49	47	10.68	16.61
Manu. of machinery and equipment	303	14.44	87	19.77	28.71
Manu. of electrical and optical equipment	154	7.34	64	14.55	41.56
Manu. of transport equipment	47	2.24	15	3.41	31.91
Manu. of furniture, manufacturing n.e.c.	109	5.20	24	5.45	22.02
Computer and related activities	126	6.01	45	10.23	35.71
Research and development	24	1.14	7	1.59	29.17
Business consultancy	128	6.10	5	1.14	3.91
Technical consultancy	124	5.91	23	5.23	18.55
Other business services	142	6.77	10	2.27	7.04

Firm size categories	#	%	#	%	% of industry
			6	215	7.90
			24	23	10.21
			22	77	20.94
			32		28.89
< 20 employees*	79	3.77	16	3.64	20.25
20–50 employees	668	31.81	95	21.59	14.22
50					
51–100 employees	565	26.93	100	22.73	22.73
101–250 employees	479	22.83	120	27.27	25.05
251–500 employees	173	8.25	50	11.36	28.90
> 500 employees	134	6.39	59	13.41	44.03

*The survey implemented the size criteria for firms in 2007; in the year 2000, some firms were smaller than the minimum requirement of 20 employees. In the partial propensity score matching method, this category will be merged with 20–50 employees.

Table 2 presents how these firms are distributed based on the above-mentioned industry classification. In total, 440 firms were engaged in offshoring during the period 2001–2006. There are clear differences based on industry and size on whether firms offshore. Offshoring appears to be a strategy primarily conducted by firms in manufacturing industries; however, some industries (e.g. manufacturing of textiles and leather, manufacturing of electrical and optical equipment, manufacturing of transport equipment, and computer and related activities) are more engaged in these activities than others (e.g. publishing and printing and business consultancy). Although the Danish textile industry started outsourcing and offshoring in the 1970s, textile firms still offshored in the survey period. As expected, there is a clear size effect where large firms tend to be more active in offshoring compared to smaller firms.

Other potential variables that characterize offshoring firms are relatively unknown. For this reason, we rely on the statistical significance

of a set of variables, both demographic characteristics and financial indicators, to find other variables that have an effect on the likelihood to offshore. This approach is common within propensity score matching when the specifications are unknown (Caleindo & Kopeinig, 2008). In this case, we started with a simple model including the size and industry variables and then test by iteratively adding variables into the specification. In this way, we can identify what other variables have a significant impact on the likelihood that a firm is engaged in offshoring; in the process, we also take into account the improvement in model fit statistics.

In addition to total size in employees (LN_EMPL2000), we tested other employee characteristics, e.g. the number of highly educated workers (LN_HEEMPL2000), the number of employees with a foreign citizenship (LN_FOREIGN2000) and various age variables of the employees (i.e. MEAN_AGE2000, STD_AGE2000 and Q3_AGE2000). The number of employees with foreign citizenship did not have any effect while the logarithm to the number of highly educated employees turned out to have a positive impact on the likelihood to offshore. However, this effect disappeared when we added the age characteristics, in particular the standard deviation in age (STD_AGE2000). Since adding this variable improved the model considerably, we retained this standard deviation variable to calculate the propensity scores. The average age had no significant effect, while a high third quartile in age (Q3_AGE2000) led to a lower likelihood of engaging in offshoring, although this effect disappeared when STD_AGE2000 was added. It can be assumed that the significant negative impact of a higher standard deviation of age is strongly dependent on a deviation towards the older ages.

Various financial data about the firm were also included. The measures were exports, value added, turnover and wage cost. Exports (LN_EXPORT2000) was included because this indicates to what extent firms are engaged in international trade, where we assume that a firm with high level of exports is more likely to engage in offshoring. Value added (LN_VALUEADDED2000) and turnover (LN_TURNOVER2000) indicate an overall performance measure of the firm, which might affect the likelihood to offshore either positively or negatively, depending on

the motives for offshoring. Wage costs (LN_WAGECOST2000) provide information on the firm's total expenses in wages and pensions. It can be expected that high wage costs might have a positive impact on the likelihood to engage in offshoring. When including these variables in the model, only two turn out to have a significant effect on the likelihood to offshore. First, there is the export variable. Firms with a high level of exports have a higher likelihood of engaging in offshoring. On the other hand, value added has a negative relation to the likelihood to engage in offshoring. Other financial indicators, e.g. growth indicators of the above-mentioned variables in the period 1999–2000 did not have any significant effect.

Finally, we tested the impact on whether the firm is located in the Capital Region of Denmark (CPH=1) or in another region (CPH=0). Our argument for including this control variable is that firms in the Capital Region are known to have a more international profile compared to firms in any of the other four regions, i.e. Region Zealand, Region of Southern Denmark, Central Denmark Region and North Denmark Region.

Outcome variables

In this study, we want to investigate how offshoring affects a number of firm employment characteristics. First, we will measure the difference in growth in the overall employment (EMPL_GROWTH) between offshoring and nonoffshoring firms. To calculate this growth, we identify the number of employees in 2000 (LN_EMPL2000) and subtract this from the number of employees in 2007 (LN_EMPL2007) to get the change in number of employees (on a logarithmic scale) between these two years.

Furthermore, we investigate the growth in high- and low-skilled employees. Previous studies that investigate the impact of offshoring on skill composition have, in line with Berman et al. (1994) and Slaughter (2000), defined high- and low-skilled employees in terms of production and nonproduction workers. We will not make a distinction between production and nonproduction workers but take the education level of employees, which has been identified as a better method to proxy the level of skills within a firm (Anderson et al., 2001). Thus, we will inves-

tigate the respective change in employees with a high education (HE_GROWTH), employees with a medium-level education (ME_GROWTH) and employees with a low level of education (LE_GROWTH). Highly educated employees are employees with a university or polytechnic degree. Employees with a medium-level education are those with a certificate from the dual vocational training system. The remaining employees are classified as having low education.

Finally, in addition to the effect of offshoring on the change of employment between high, medium and low levels of education, we also test the difference in growth in terms of specific high educational backgrounds. High-, medium- and low-level education only accounts for part of the story; therefore, we distinguish between people with a high-level degree in science and engineering (S&E_GROWTH) and social sciences and administration (ADM_GROWTH).¹¹ All these variables will also be measured within the period to see the trend in the entire period 2001–2006.

EMPIRICAL RESULTS

As a first step in creating the matched sample, we needed to estimate the propensity scores. In order to do this, we included all the control variables in a logit model with the dependent variable OFFSHORE, i.e. whether the firm was engaged in offshoring in the period 2001–2006. Table 3 presents some descriptive statistics in the full sample, comparing offshoring and nonoffshoring firms in terms of their mean differences. The firms in the two subsamples differ significantly in terms of the variables that will be used to calculate the propensity scores. Regarding employment in offshoring and nonoffshoring firms, there are clear differences between them. First, the average growth in the number of employees is significantly different between offshoring and nonoffshoring firms, where nonoffshoring firms grow more compared to offshoring ones. The growth in employees with both low and high

11 In making a distinction in the level of education, there is the possibility that some firms will have 0 employees in one or more categories. To solve this problem, we apply a log transformation for the more detailed employment figures, i.e. $\ln(x+1)$.

educational backgrounds is higher in nonoffshoring firms (for offshoring firms, there is a decline in employees with a low level of education); nevertheless, there are no significant differences between the two subsamples. The growth in employees with a medium level of education is significantly higher in nonoffshoring firms. When looking at the differences between offshoring and nonoffshoring firms in terms of the growth in employees with an academic background in science and engineering and social science and administration, Table 3 shows that there is no significant difference between these two types of firms for science and engineering, but offshoring firms have significantly higher growth in employees with a social science and administration background.

Table 3. Descriptive statistics (full sample)

Variable	Off-	N ¹ =433	Off-	N ⁰ =1,634	p-value of two-tailed t-test on mean differ- ence
	shoring=1		shoring=0		
	<i>Mean</i>	<i>Std. dev.</i>	<i>Mean</i>	<i>Std. dev.</i>	
Ln_empl2000	4.704	1.263	4.030	1.018	0.000
Std_age2000	10.471	1.785	11.118	2.149	0.000
Ln_ex- port2000	15.313	6.163	11.277	7.597	0.000
Ln_value_add- ed2000	17.488	1.847	16.884	1.451	0.000
Cph	0.333	0.472	0.282	0.450	0.040
Propensity Score	0.244	0.189	0.174	0.141	0.000
Empl_growth	0.013	0.639	0.121	0.753	0.006
He_growth	0.258	0.654	0.272	0.693	0.719
Me_growth	-0.033	0.678	0.094	0.730	0.001
Le_growth	-0.049	0.741	0.085	0.801	0.468
S&E_growth	0.174	0.655	0.173	0.655	0.987
Adm_growth	0.302	0.613	0.201	0.612	0.002

Note: The total number of observations and the number of offshoring firms has decreased due to missing observations in the financial data, i.e. export and value added.

To start the matching procedure, we created a propensity score by running a logit model on the control variables presented earlier and described in Table 3. The propensity scores for offshoring firms, as expected, are significantly higher compared to those of nonoffshoring firms; through matching, these propensity scores will become more similar.¹²

After matching, which gives a sample of 367 treated (firms that offshore) and 1,399 untreated firms, we observe some differences in the various employment figures compared to the full sample (see Table 4). Total growth in employment remains significantly positive for nonoffshoring firms. Growth in the number of employees with an academic or polytechnic education is higher in nonoffshoring firms, but the difference is not significant. Nonoffshoring firms have a significant increase of employees with a medium and low level of education; for offshoring firms, the number of firms with these two educational backgrounds decreases. Despite the slightly stronger increase in employees with an academic background in science and engineering in nonoffshoring firms, the increase is not significant, while the offshoring firms experience a significant stronger increase (at the 10% level of significance) in employees with an academic background in social sciences and administration.

Table 4. Mean difference in the change in domestic employment between offshoring and non-offshoring firms (matched sample)

Variable	Off- shoring=1	N ¹ =367	Off- shoring=0	N ⁰ =1,399	p-value of two-tailed t-test on mean dif- ference
	<i>Mean</i>	<i>Std. dev.</i>	<i>Mean</i>	<i>Std. dev.</i>	
Empl_growth	0.026	0.631	0.172	0.685	0.000
He_growth	0.259	0.675	0.301	0.660	0.277
Me_growth	-0.017	-0.086	0.140	0.104	0.000
Le_growth	-0.024	0.695	0.139	0.732	0.000
S&E_growth	0.171	0.662	0.180	0.641	0.797
Adm_growth	0.285	0.616	0.222	0.580	0.068

¹² The logit model used to calculate the propensity scores is presented in the Appendix.

The results presented in Table 4 are based on the entire match sample. There may be some industry differences in the change in employment. For this reason, we look at the mean difference amongst firms in manufacturing (NACE 15–39) and business service (NACE 72–74). Table 5 presents the matched sample of firms that are active in the manufacturing industries. In this manufacturing subsample, there are 303 treated and 1,066 untreated firms. The results are very similar to the results of the overall analysis: Nonoffshoring firms in manufacturing experience significantly higher growth in the number of employees compared to offshoring firms. There is no significant difference in the growth of employees with a higher education; however, the growth is slightly higher in offshoring firms, which is different from the full sample. The growth in employees with a low and medium level of education is significantly higher in nonoffshoring firms. Nonoffshoring firms experience a lower growth in employees with both science and engineering and social science and administration academic backgrounds, but only the latter is significantly different.

Table 5. Mean difference in the change in domestic employment between offshoring and nonoffshoring firms in manufacturing (matched sample)

Variable	Off- shoring =1	N ⁱ =303	Off- shoring =0	N ^o =1,066	p-value of two-tailed t-test on mean dif- ference
	<i>Mean</i>	<i>Std. dev.</i>	<i>Mean</i>	<i>Std. dev.</i>	
Empl_growth	0.013	0.588	0.127	0.598	0.003
He_growth	0.264	0.632	0.247	0.598	0.677
Me_growth	0.008	0.575	0.112	0.584	0.002
Le_growth	-0.037	0.684	0.119	0.639	0.000
S&E_growth	0.150	0.081	0.123	0.090	0.448
Adm_growth	0.302	0.578	0.182	0.533	0.001

Table 6 shows the mean differences between offshoring and non-offshoring firms in business services, which contains 63 treated and 333 untreated firms. Interestingly, the significance disappears for the majority of the employment growth variables. Nevertheless, nonoffshoring firms experience a significant growth in the total number of employees compared to the offshoring firms. The other rather unexpected finding is that nonoffshoring firms experience a significantly stronger increase in the number of employees with an academic and polytechnic background.

Table 6. Mean differences in domestic employment change between offshoring and nonoffshoring firms in business services (matched sample)

Variable	Off- shoring=1	N ⁱ =63	Off- shoring =0	N ^o =333	p-value of two-tailed t-test on mean dif- ference
	<i>Mean</i>	<i>Std. dev.</i>	<i>Mean</i>	<i>Std. dev.</i>	
Empl_growth	0.087	-0.115	0.314	0.893	0.061
He_growth	0.023	0.086	0.471	0.806	0.032
Me_growth	-0.058	1.014	0.227	0.899	0.238
Le_growth	0.040	0.749	0.204	0.970	0.200
S&E_growth	0.269	0.879	0.357	0.866	0.414
Adm_growth	0.202	0.771	0.351	0.696	0.123

In the tables presented above, we only investigate whether there is a significant difference in the growth of domestic employees between offshoring and nonoffshoring firms in 2000 and 2007. From these tables, it is not possible to identify the difference in the overall trend in employment, which we will discuss below. Analysing this trend can provide some interesting insights into how offshoring firms have

changed their employment strategies as a result of economic downturn. Denmark experienced a recession starting in 2001, followed by slow growth in 2002–2003, and from 2004, a period of economic prosperity and low unemployment.

In Figure 1 we observe that there is an overall upward trend of employment with a small dip in employment because of the economic recession. Changes in employment usually lag behind changes in the business cycle, since firms want to retain their employees as long as possible to avoid costs related to hiring and firing. The recovery following this recession is only visible in nonoffshoring firms. The domestic employment growth of offshoring firms is lagging behind, and involves a slower rate of recovery, i.e. the peak that is visible in 2002 is again reached in 2007, while nonoffshoring firms surpass this peak already in 2005.

Figure 1. Trend in employment, 2000–2007 (matched sample)

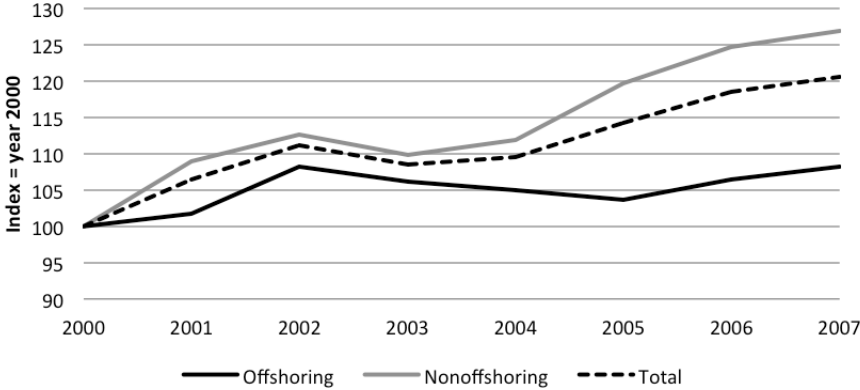

Again, this pattern varies considerably between manufacturing and services. In Figure 2 we present the numbers for manufacturing industries. In manufacturing, the ‘peak’ for 2002 is again reached in 2007, and the nonoffshoring industries are responsible for the overall recovery. Offshoring firms in this industry follow a similar decline in employees compared to nonoffshoring firms during the recession, but the recov-

Figure 2. Trend in employment in manufacturing, 2000–2007
(matched sample)

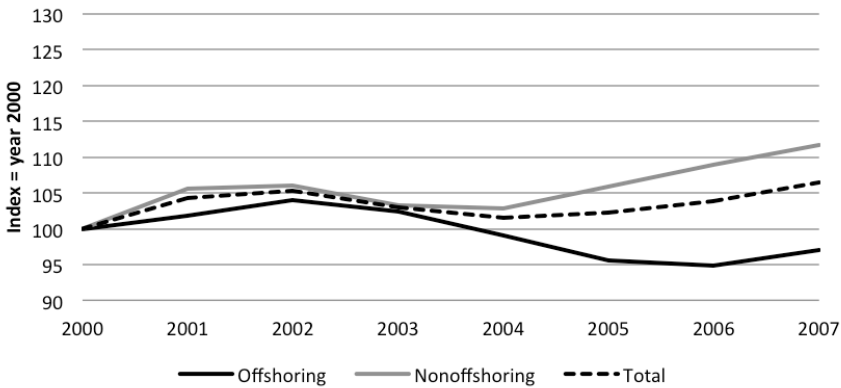

ery follows a more divergent path. The economic recovery does not lead to any form of employment growth for these firms, at least not within Denmark.

In services, Figure 3, there is strong growth visible for both offshoring and nonoffshoring firms. Since the share of offshoring firms is relatively low, the pattern of nonoffshoring firms closely resembles the pattern of the overall business service industry (not shown in the figure). Nevertheless, for both types of firms, the impact of the recession is visible in terms of declining employment levels, but here there is also a slower rate of recovery for offshoring firms.

The last table, Table 7, presents the mean differences in employment growth between firms that offshore administrative and technical business functions (ATBF=1) and other offshoring firms.¹³ There is no significant difference between the growth rates in overall employment. However, firms that offshore administrative and technical business functions exhibit significantly lower growth in the number of highly educated employees. They also have a significant lower growth rate,

¹³ Those firms that offshore administrative and technical business functions can also offshore other activities.

Figure 3. Trend in employment in business services, 2000–2007 (matched sample)

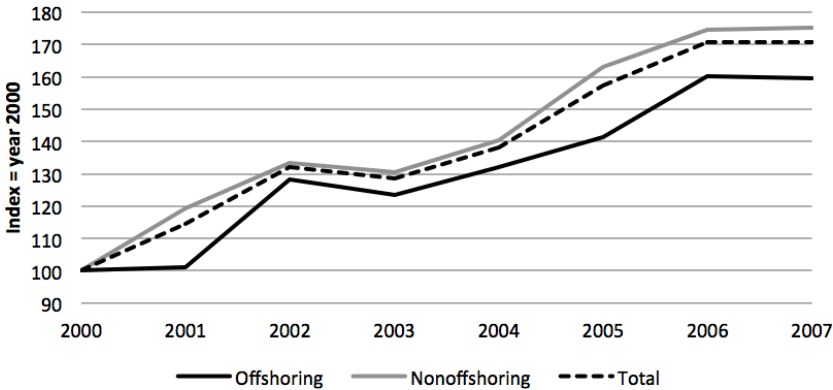

which on average is decreasing, in the number of employees with a medium level of education (although significant on the 10% level of significance). Although the average increase in the number of employees with a science and engineering degree is higher in those firms that offshore technical administrative business functions, the mean difference is not statistically significant. Finally, firms that offshore administrative and technical business functions have a significantly lower increase in employees with a social science or administration degree.

Table 7. Mean differences in domestic employment change between firms that offshore administrative and technical business functions (ATBF) and other offshoring firms

Variable	ATBF=1	N ¹ =135	ATBF =0	N ⁰ =232	p-value of two-tailed t-test on mean difference
	<i>Mean</i>	<i>Std. dev.</i>	<i>Mean</i>	<i>Std. dev.</i>	
EMPL_GROWTH	-0.031	0.709	0.059	0.581	0.187
HE_GROWTH	0.127	0.800	0.335	0.579	0.004
ME_GROWTH	-0.094	0.797	0.028	0.583	0.095
LE_GROWTH	-0.077	0.697	0.007	0.694	0.264
S&E_GROWTH	0.110	0.775	0.206	0.282	0.177
ADM_GROWTH	0.159	0.703	0.358	0.547	0.003

DISCUSSION

As expected, offshoring has an impact on the employment levels in Danish firms and the development of employment in offshoring firm differs compared to that of nonoffshoring firms. However, contrary to previous studies, which mainly focus on manufacturing firms, this study showed that it is problematic to generalise earlier findings across industries, on the various offshored business functions and between different types of skills.

The cost motivation for offshoring has resulted in the offshoring of production, and for this reason, it is understandable that many studies have focused on the offshoring activities of manufacturing firms. Nevertheless, service industries are involved in offshoring to an increasing

extent, and despite the relatively lower levels of offshoring in service industries compared to manufacturing industries, there are particular types of service industries that are just as active in offshoring as the most active offshoring manufacturing industries, e.g. computer and related activities. Given that services consist of a much larger share of Danish employment, including the largest share of high-skilled labour, it can be expected that the increasing offshoring activity in this industry will have a considerable impact on the Danish economy. Consequently, we recommend that attention to the impact of offshoring on this industry in particular should be increased.

This need is illustrated by the differences in the offshoring pattern and the impacts on employment between these industries, which can partly be explained by some fundamental differences in the underlying characteristics of both industries. Due to the stronger knowledge-intensive character of firms in service industries, we can argue that these firms are more prone to offshore knowledge-intensive business functions compared to manufacturing firms. For this reason, it is also not surprising that nonoffshoring firms in services experience a higher growth rate in highly educated employees compared to offshoring firms. This difference is not visible in manufacturing firms; instead, based on the change in employment, we might argue that these firms are mainly engaged in the offshoring of core business functions, most likely production, which negatively influences the number employees with a low and medium level of education.

The offshoring of these core functions does not appear to affect the overall growth in highly educated employees, since offshoring and nonoffshoring firms are increasing the number of higher educated employees to a similar extent. However, it may be that offshoring manufacturing firms focus on supportive tasks, since there has been a significantly different increase in the number of employees with a social science background in offshoring firms. The latter might provide support for the increasing attention to servitisation.

Despite the difference that can be observed in employees with a social science background, there are no significant differences in the growth

of employees with an engineering or science background. However, on average, the number of employees with an engineering and science background is increasing. It is difficult to say what this means for the loss or gain of technological knowledge in the offshoring and nonoffshoring firms; this would require further investigation.

The type of business function being offshored is an important determinant in how the employee structure of offshoring and nonoffshoring firms differs. It is expected that firms that offshore ATBF would have a relatively lower domestic demand for high-skilled labour. This expectation is confirmed by our results; nevertheless, both types of firms experience an increase in this type of employees. In addition, this change is only visible employees with a social science background, although there are differences in the average increase of engineers and scientists. Again, a more detailed analysis could provide a thorough description of this phenomenon.

CONCLUSION

This chapter attempted to contribute to the offshoring discussions by moving beyond the existing anecdotal and macroeconomic evidence and providing microeconomic evidence on the role of offshoring on changes in employment. By making use of a Danish offshoring survey, in combination with the Danish register data, our study provided strong evidence that the effect of offshoring on employment cannot be taken at face value, but rather has to be considered in light of the type of industry and the type of activity that is being outsourced. To analyse the difference in growth rates, we used a partial propensity score method where we identified multiple firms that can act as a comparable control group for the offshoring firm. We also identified firms that were unique in such a way that no nonoffshoring counterpart would be removed from the analysis.

As expected, we found that the offshoring firms experienced lower growth in the number of employees compared to nonoffshoring firms. In addition, they experienced a lower growth in the number of employees with a medium and low level of education; on average, there

was even a decrease. This picture changed, however, when taking into account the type of industry, i.e. manufacturing industries vs. business services, and when considering the type of activities being offshored. Manufacturing industries followed roughly the same overall pattern. The change in employment of business services, however, presented a different picture. It appeared from the analysis that nonoffshoring firms had a higher increase in the number of employees with a higher education. This can potentially be explained by the fact that manufacturing firms are mainly involved in the offshoring of their core-activities, while business services offshore other supportive business functions to a higher extent, i.e. sales and marketing, IT, administration and management functions, technical and engineering functions and R&D.

When looking at offshoring of administrative and technical business functions, it was shown that this has a stronger impact on the change in employees with a higher education background, where those firms that offshore experienced a lower growth in the number of employees, especially employees with a background in social sciences and administration; there was also lower average growth in employees with a science and engineering background, but there was no significant difference between the two subsamples. Furthermore, overall, the number of employees with a background in social sciences and administration seemed to increase more in offshoring firms.

Many issues remain to be investigated in future research. One topic is the broader employment issue: The labour effects of offshoring might be underestimated and relatively ambiguous due to the disregard of labour spillovers and feedback effects among firms and industries (Egger & Egger, 2005). What happens to those employees that leave the firms? Do they move out of the active labour force? Do they move to other firms in the same industry or are they 'forced' to take a job in other industries. Furthermore, what impact does offshoring have on the suppliers of the offshoring firms, i.e. what are the indirect employment effects? Another issue to be explored is what happens to the overall performance of these firms, focusing in particular on innovation. Firms have traditionally offshored simple manufacturing tasks, but when these tasks become more complex, firms might lose

the 'factory as a laboratory'. Many innovative activities occur on the work floor in relation to manufacturing tasks, and when these activities disappear abroad, this might hamper the capacity for innovation of domestic firms. This problem might be enhanced when firms start to offshore activities like R&D (called ATBF in our study), which is why the OECD (2008) suggests assessing the impact of R&D offshoring on a country's innovative capacity. Answering these and others questions would certainly increase our understanding of how offshoring affects the demand for labour and the economic performance of firms, and to what extent this influences the economy as a whole. Finally, although offshoring firms do not appear to perform as well as nonoffshoring firms, there are no grounds to conclude that offshoring is bad for employment. An offshoring decision is often driven by the need to remain competitive, and not offshoring might lead to more job losses.

REFERENCES

- Anderson, M.A., Robertson, R. & Smith S.L.S. (2001). Measuring skill intensity: Production worker vs. education data in the NAFTA countries. *Office of Economics Working Paper No.2001-07-B*
- Berman, E., Bound, J., & Griliches, Z. (1994). Changes in the demand for skilled labor within U.S. manufacturing: Evidence from the Annual Survey of Manufacturers. *Quarterly Journal of Economics*, 109, 367–97.
- Bertrand, O. (2011). What goes around, comes around: Effects of offshore outsourcing on the export performance of firms. *Journal of International Business Studies*, 42(2), 334–344.
- Caliendo, M., & Kopeinig, S. (2008). Some practical guidance for the implementation of propensity score matching. *Journal of Economic Surveys*, 22(1), 31–72.
- Couto, V., Mani, M., Lewin, A.Y., & Peeters, C. (2007). *The globalization of white-collar work: The facts and fallout of next-generation offshoring*. Working paper, Offshoring Research Network. Center for International Business Education and Research, Duke University, Durham, NC.
- Danish Ministry of Economic and Business Affairs. (2008). *Økonomisk tema: Danske virksomheders outsourcing*. Copenhagen.
- Di Gregorio, D., Musteen, M. & Thomas, D.E. (2009). Offshore outsourcing as a source of international competitiveness for SMEs. *Journal of International Business Studies*, 40, 969–988.
- Egger, H., & Egger, P. (2003). Outsourcing and skill-specific employment in a small economy: Austria after the fall of the iron curtain. *Oxford Economic Papers*, 55(4), 625–643.

- Egger, P., Pfaffermayr, M., & Wolfmayr-Schnitzer, Y. (2001). The international fragmentation of Austrian manufacturing: The effects of outsourcing and productivity on wages. *North American Journal of Economics and Finance*, 12, 257–272.
- Falk, M., & Koebel, B.M. (2002). Outsourcing, imports and labour demand. *Scandinavian Journal of Economics*, 104(4), 567–586.
- Feenstra, R.C., & Hanson, G.H. (1996). Globalization, outsourcing and wage inequality. *The American Economic Review*, 86(2), 240–245.
- Feenstra, R.C., & Hanson, G.H. (1999). The impact of outsourcing and high-technology capital on wages: Estimates for the United States, 1979–1990. *Quarterly Journal of Economics*, 114, 907–941.
- Florida, R. (1997). The globalization of R&D: Results of a survey of foreign-affiliated R&D laboratories in the USA. *Research Policy*, 26(1), 85–103.
- Gilley, K.M., & Rasheed, A. (2000). Making more by doing less: An analysis of outsourcing and its effects on firm performance. *Journal of Management*, 26(4), 763–790.
- Görg, H., & Hanley, A. (2005). Labour demand effects of international outsourcing: Evidence from plant-level data. *International Review of Economics and Finance*, 14, 365–376.
- Hätönen, J., & Eriksson, T. (2009). 30+ years of research and practice of outsourcing—Exploring the past and anticipating the future. *Journal of International Management*, 15(2), 142–155.
- Head, K., & Ries, J. (2002). Offshore production and skill upgrading by Japanese manufacturing firms. *Journal of International Economics*, 58, 81–105.

- Hijzen, A., Görg, H., & Hine, R.C. (2005). International outsourcing and the skill structure of labour demand in the United Kingdom. *The Economic Journal*, 115, 860–878.
- Horgos, D. (2009). Labor market effects of international outsourcing: How measurement matters. *International Review of Economics and Finance*, 8(4), 611–623.
- Hummels, D., Rapoport, D., & Yi, K.M. (1998). Vertical specialization and the changing nature of world trade. *Federal Reserve Bank of New York Economic Policy Review*, 79–99.
- Ibsen, R., & Westergaard-Nielsen, N. (2005). Job creation and destruction over the business cycles and the impact on individual job flows in Denmark, 1980–2001. Working Paper 05-4, Department of Economics, Aarhus School of Business.
- Jensen, P.D.Ø., & Pedersen, T. (2011). The economic geography of offshoring: The fit between activities and local context. *Journal of Management Studies*, 48(2), 352–372
- Kenney, M., Massini, S., & Murtha, T.P. (2009). Offshore administrative and technical work: New fields for understanding the global enterprise. *Journal of International Business Studies*, 40(6), 887–900.
- Kumar, K., van Fenema, P.C. & von Glinow, M.A. (2009). Offshoring and the global distribution of work: Implications for task interdependence theory and practice. *Journal of International Business Studies*, 40(6), 642–667.
- Lewin, A.Y., & Peeters, C. (2006). Offshoring work: Business hype or the onset of fundamental transformation? *Long Range Planning*, 39(3), 221–239.
- Manning, S., Lewin, A. Y., & Massini, S. (2008). A dynamic perspective on next-generation offshoring: The global sourcing of science and engineering skills. *Academy of Management Perspectives*, 22, 35–51.

- Maskell, P., Pedersen, T., Petersen, B., & Dick-Nielsen, J. (2007). Learning paths of offshore outsourcing: From cost reduction to knowledge seeking. *Industry and Innovation*, 14(3), 239–257.
- McCann, P., & Mudambi, R. (2005). Analytical differences in the economics of geography: The case of the multinational firm. *Environment and Planning A*, 37, 1857–1876.
- Munch, J.R., & Skaksen, J.R. (2009). Specialization, outsourcing and wages. *Review of World Economics*, 145(1), 57–73.
- Mudambi, R. (2007). Offshoring: Economic geography and the multinational firm. *Journal of International Business Studies*, 38(1), 206.
- Mudambi, R. (2008). Location, control and innovation in knowledge-intensive industries. *Journal of Economic Geography*, 8(5), 699–725.
- Organisation for Economic Co-operation and Development. (2008). *The internationalization of business R&D: Evidence, impacts and implications*. Paris: OECD.
- Olsen, K.B. (2006) *Productivity impacts of offshoring and outsourcing: A review*. OECD Directorate for Science, Technology and Industry, Working Paper 2006/1.
- Olsen, K., Ibsen, R., & Westergaard-Nielsen, N. (2004). Does outsourcing create unemployment? The case of the Danish textile and clothing industry. Working Paper 04-5, Department of Economics, Aarhus School of Business.
- Pyndt, P., & Pedersen, T. (2006). *Managing global offshoring strategies—A case approach*. Copenhagen: Copenhagen Business School Press.
- Rasheed, A., & Gilley, K.M. (2005). Outsourcing: National- and firm-level implications. *Thunderbird International Business Review*, 47(5), 513–528.

Rosenbaum, P., & Rubin, D. (1983). The central role of the propensity score in observational studies for causal effects. *Biometrika*, 70(1), 41–55.

Statistics Denmark. (2008). *International sourcing: Moving business functions abroad*. Copenhagen: Statistics Denmark.

Strauss-Kahn, V. (2004). The role of globalization in the within-industry shift away from unskilled workers in France. In R. Baldwin & A. Winters (Eds.), *Challenges to globalization*. 209-234 Chicago: University of Chicago Press.

Teirlinck, P., Dumont, M., & Spithoven, A. (2010) Corporate decision-making in R&D outsourcing and the impact on internal R&D employment intensity. *Industrial and Corporate Change*, 19(6), 1741–1768.

Timmermans, B. (2010). The Danish Integrated Database for Labor Market Research: Toward a demystification for the English speaking audience. DRUID working paper no. 10–16.

APPENDIX: Logit model on the offshoring dummy

Variable	Coefficient	Std. err.	Odds	Marginal effect
Intercept	-0.154	0.763		
Ln_empl2000	0.635 ***	0.075	1.887	0.502
Std_age2000	-0.238 ***	0.037	0.788	-0.188
Other business services	-1.127 ***	0.343	0.474	-0.891
Technical consultancy	0.012	0.252	1.481	0.009
Business consultancy	-1.940 ***	0.484	0.210	-1.534
Research and development	-0.265	0.579	1.124	-0.209
Computer and related activities	0.271	0.234	1.920	0.214
Manu. of furniture, manufacturing n.e.c.	0.523 **	0.249	2.470	0.414
Manu. of transport equipment	0.785 **	0.328	3.209	0.620
Manu. of electrical and optical equipment	1.049 ***	0.185	4.181	0.830
Manu. of machinery and equipment	0.668 ***	0.157	2.854	0.528
Manu. of basic metals and fabricated metal products	0.162	0.179	1.721	0.128
Manu. of other nonmetallic mineral products	-0.503	0.378	0.885	-0.398
Manu. of plastics	0.030	0.262	1.509	0.024
Manu. of chemicals products	-0.233	0.322	1.160	-0.184
Publishing, printing and reproduction of recorded media	-0.389	0.325	0.992	-0.308
Manu. of wood and paper products,	-0.443	0.311	0.940	-0.351
Manu. of textiles and leather	1.782 ***	0.308	8.700	1.409
Manu. of food, beverages and tobacco	--Benchmark--			
Ln_export2000	0.035 ***	0.011	1.036	0.028
Ln_value_added2000	-0.113 **	0.048	0.893	-0.090
Capital Region of Denmark	0.193 ***	0.073	1.472	0.153
<i>N</i>	2,067			
<i>Offshoring firms</i>	433			
<i>Likelihood ratio</i>	343.857			
<i>Adjusted R2</i>	23.88			

CHAPTER 2

Factory Roles: A Scandinavian Perspective

Marja Blomqvist, Aalto University, Finland

Virpi Turkulainen, Aalto University, Finland

Eero Eloranta, Aalto University, Finland

Aki Laiho, Aalto University, Finland

ABSTRACT

Today's global manufacturing landscape is changing dramatically; in the quest for lower costs and access to new markets, companies are moving production into fast-growing market areas and low-cost countries, increasingly engaging in the outsourcing of their operational activities. This raises the question about the future of manufacturing in the Western world. The purpose of this chapter is to discuss the roles of factories located in areas with high labour costs, using Finland as an example. We discuss existing models of factory roles and report research findings from a survey of factories located in Finland. The objectives of the chapter are to take a regional point of view and discuss the types of roles that are typical in the context of small local markets and a high labour cost area, such as Scandinavia. For practitioners, the chapter gives insights into the variety of roles which factories may have in order to assess their own factory networks and corresponding factory roles.

INTRODUCTION

Western European companies are becoming increasingly global in terms of both the markets to which they sell their products and the locations of their manufacturing. Establishing manufacturing units abroad has traditionally been seen as the final step in the internation-

alisation of a company (Johanson & Wiedersheim-Paul, 1975), but recently in particular, many companies are also globalising their research and development (R&D) activities (Ambos & Schlegelmilch, 2007). Establishing manufacturing abroad can be motivated, for example, by proximity to the markets, access to skills and knowledge and access to low-cost manufacturing resources (e.g. Brush, Maritan, & Karnani, 1999; Ferdows, 1989). Like in many other Western countries, companies in Finland are also radically developing their manufacturing activities. The manufacturing function is becoming increasingly global due to major business changes such as focused strategies, the reduction of the viability of mass production in the high-cost context, mergers and acquisitions as well as emerging new markets—for example, in Asia (Lovio, 2006). This has major consequences for the manufacturing industries in Finland and the Finnish economy (Eloranta, Ranta, Salmi, & Ylä-Anttila, 2010); what kinds of manufacturing will companies have in the future in Finland? A dramatic example is the change in the Finnish electronics industry, which experienced a rapid growth largely driven by Nokia, passing the forest industry as the largest industry in Finland in 2000. Within the past ten years both Nokia as well as the supplier base of the whole industry, including companies like Aspocomp, Efore, Elcoteq, Elektrobit, Perlos and Scanfil have largely moved out of Finland, moving their production partly or even totally closer to main markets and lower-cost production resources (Eloranta et al., 2010).

In this chapter, we build on research on factory roles to understand what kind of factories are located in the Western world and elaborate it further in the following sub-chapter. The chapter focuses on Scandinavian countries as the context for discussing factory roles. Scandinavian countries make an interesting context because of small local markets and high labour costs. Critical question for the economy thus is: What kind of roles do factories in Scandinavia have? Addressing the status of current manufacturing activities in the context allows us to discuss also what activities will be feasible to be located in Scandinavia in the future. In order to understand the roles of factories located in Finland, we present results of a survey of nearly one hundred mid- to large-sized factories, containing factories of both Finnish and foreign ownership. Factories represent variety of industries and process types. In

the survey, unit managers evaluated factory competences and reasons for the factory location. Additional questions related to operations, suppliers, and performance were also addressed. In this chapter, the term 'factory' is used to describe an industrial production site covering activities beyond the traditional production such as order management, research and development, and sourcing. The rest of the chapter is organised as follows: First, the theoretical background is discussed, starting with different research streams around factory roles and continuing with the origins of the factory roles in operations strategy and in subsidiary roles. We present and discuss the key frameworks of factory roles. The second part of the chapter presents a survey on Finnish factories. Finally, the findings are discussed and conclusions are made.

FACTORY ROLES

Background

Research on global manufacturing has been carried out from several different points of view. Early research on operations strategy already highlighted the importance of the roles of factories; operations should be designed to support the corporate and business strategies of the firm (Skinner, 1969). Skinner (1974) also introduced the concept of focused factory, emphasising the strategic importance of the task given to a factory. In addition to, for example, assigning the operational priorities for each factory, factory location is one of the key decisions of operations strategy (Hayes, Pisano, Upton, & Wheelwright, 2005; Hayes & Wheelwright, 1984; Hill, 1985; Skinner, 1969).

In recent discussions about offshoring (moving operations to offshore locations), access to low-cost production resources has been emphasised as a key rationale for producing abroad (Farrell, 2006; Lewin & Peeters, 2006). This is a rather limited point of view and other reasons have also been pointed out: In a recent Finnish study, the main reasons for transferring the production abroad were identified as proximity and access to markets, cost and increased flexibility (Ali-Yrkkö, 2006). Offshoring is increasingly being discussed along with outsourcing (moving work previously done by the company itself to be done by a third party) (e.g. Aron & Singh, 2005; Kinkel & Maloca, 2009). It has

been proposed that organisations should approach the outsourcing of current operations at least from two points of view: costs and competencies (Holcomb & Hitt, 2007). These views have been addressed when assessing outsourcing decisions by combining transaction cost theory and resource based view (Holcomb & Hitt, 2007; McIvor, 2009). The combination of these two theories has also been used more broadly in areas involving both aspects of manufacturing location and ownership, for example, global sourcing (Ettlie & Sethuraman, 2002).

Another stream of research has focused on different supply chain types, which also has direct implications for the roles of manufacturing units. While it had been recognised within the context of manufacturing systems that one size does not fit all (Sewchuk, 1998), the discussion has been extended to supply chains, proposing that different supply chains may provide the best fit in different situations. As an example, highly variable and unpredictable demand, in combination with short product lifecycles, calls primarily for a responsive rather than a cost-efficient supply chain (Fisher, 1997). Further identified drivers for differentiated supply chains have been, for example, demand volume and order dynamics, customer requirements for lead times and order decoupling points, supply uncertainty and product type and variety (Childerhouse, Aitken, & Towill, 2002; Childerhouse, Peck, & Towill, 2006; Christopher, Peck, & Towill, 2006; Collin & Eloranta, 2009; Lee, 2002). The idea of differentiation in supply chains implies that factories may and should have different competences (Christopher et al., 2006): For example, a factory serving a lean supply chain should focus on producing as cost efficiently as possible, whereas a factory in an agile supply chain should have high flexibility to accommodate changes in demand.

A fourth stream of research has taken a network perspective and assessed the collection of various organisational units located in different parts of the world within a company: What different roles are assigned – intentionally or unintentionally – to the different units and how are these units with varying roles managed as a network (Brush et al., 1999; Ferdows 1989, 1997)? This stream of study builds partly on research on global corporations and the management of multibus-

iness organisations; within a corporation, various business units are assigned different roles, which then should support the given strategy of the firm (Bartlett & Ghoshal, 1986). In this chapter, we build on this research stream.

Roots of factory roles in operations strategy

According to prior research, production and operations can contribute to the competitive advantage through, for example, cost, quality, flexibility, delivery and recently also innovation (Boyer & Lewis, 2002; Hayes et al., 2005; Rosenzweig & Easton, 2010). The relative importance of these competitive priorities may vary in different business situations. Finding a balance between the different objectives can be seen as the foundation of manufacturing or operations strategy (Da Silveira & Slack, 2001). Although there is general agreement that the operational priorities do exist, the discussion about the relationship between these priorities remains active. Some suggest that these priorities are tradeoffs (Skinner, 1969), so that it is, for example, difficult to simultaneously improve quality and reduce costs. Others, on the other hand, argue for cumulative competencies and suggest that different priorities like quality and costs can be improved at the same time, at least if the order of the priorities is carefully considered (Boyer & Lewis, 2002; Da Silveira & Slack, 2001; Ferdows & De Meyer, 1990; Schmenner & Swink, 1998).

Operations strategy can be seen as a set of goals, policies and self-imposed restrictions that together describe how the organisation proposes to direct and to develop all the resources invested in operations so as to best fulfil and possibly redefine its mission (Hayes et al., 2005). Factory location is one of the key decisions of operations strategy (Hayes et al., 2005; Hayes & Wheelwright, 1984; Hill, 1985; Skinner, 1969). While the choice of location may be driven by different criteria, such as cost, proximity to market or access to skills and knowledge (Ferdows, 1989), it affects the nature of the production facility and the role it has in the whole manufacturing network. For example, the capabilities in a factory geared to the lowest possible cost are at least partly different from those of a factory, where the main target is high agility for serving different customer needs. Further operational strategy decisions influ-

encing the role of the factory include the choice of produced products, on a scale from mass production to more project-type products which are highly standardised and customised (Hayes & Wheelwright, 1984; Hill, 1985). This might also affect how widely additional functions such as R&D exist on the site. The served markets and segments contribute to the breadth of responsibility: Is the factory a local niche-factory or does it have global responsibilities? Make or buy decisions have a similar effect: Is the company serving the end customers of the company, or is it feeding materials and components to another factory in the company network? With the concept of focused factories, it was argued that no factory can be good at everything, but in order to excel, factories should be focused, for example, on to the products they produce, process technologies or served markets (Hill, 1985; Skinner, 1969). It was also noted that the focus of a factory may change according to the lifecycle of a product, and that the factories themselves may have lifecycles (Hill, 1985; Schmenner, 1983; Skinner, 1974). As a conclusion, the fundamental seeds for differentiated factory roles within a company's operations network are already found in the fundamental operation strategy decisions.

Research on multinational corporations and subsidiary roles

Whereas operations strategy research pointed out the importance of assessing the roles of factories, research on different roles emerged in the context of a more general discussion on subsidiary roles in multinational corporations. Bartlett and Ghoshal (1986) suggested in their pioneering work on subsidiaries of multinational corporations (MNCs) that in successful MNCs, the roles of subsidiaries are differentiated rather than homogeneous, and the responsibilities are dispersed rather than concentrated. Based on their empirical research, they suggested a two-dimensional model for the subsidiary roles: The competence of the local organisation and the strategic importance of the local environment. Consequently, there are four different types of subsidiaries, which are shown in Figure 1.

Figure 1. Roles for national subsidiaries (Bartlett & Ghoshal, 1986)

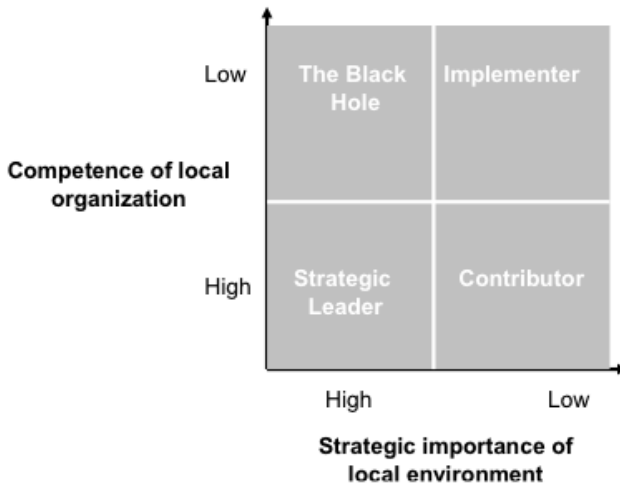

While Bartlett and Ghoshal (1986) approached the role of a subsidiary from the top level company point of view, the issue has also been tackled from national or regional point of view. In the Scandinavian context, Benito, Groggaard and Narula (2003) examined how business environment influences subsidiary roles of MNCs by focusing on the European integration as the context. Their framework was based on the scope of activities and the level of competence, and is presented in the following figure. This framework was used in a large-scale survey of foreign-owned units in Denmark, Finland and Norway. Participation in the European integration as an example of external factors was found to affect both the scope and the competence level of subsidiaries, and the results suggest that more developed roles can be expected for subsidiaries located within the European Union area compared to those outside the European Union (Benito et al., 2003).

Figure 2. Different types of subsidiaries (Benito et al., 2003)

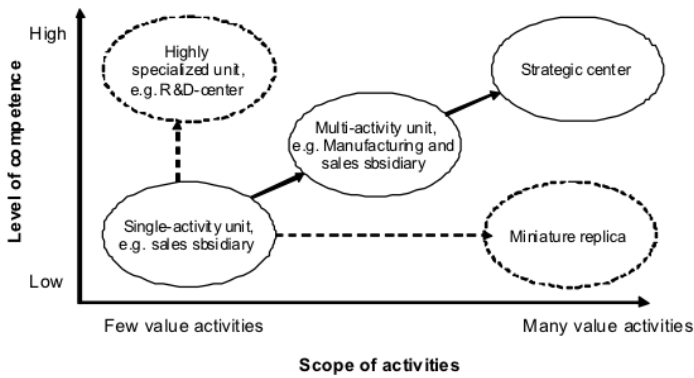

As a conclusion, research on subsidiary roles focuses on the level of the MNC and its various subsidiaries, paying less attention to specifically operational units (e.g. factories) within the subsidiary. Whereas the different subsidiaries can have different roles within the MNC, following the same logic, so could the operational units within a subsidiary.

Research on factory roles

The research on factory roles originates from the seminal work of Kasra Ferdows (1989, 1997). His work describes the strategic roles assigned to different factories within a company, assuming that there are several factories in the firm. He also suggests a pattern for how these roles evolve through time. The framework is based on two dimensions. The first is the extent of activities or level of competence at the factory. The basic activity is the production task itself, and additional activities or competences include production-related tasks such as maintenance, production planning and control and process improvement, but also, more general operational activities such as procurement and product improvement and R&D. It should be noted that according to Ferdows (1989), the order of development of these activities is not fixed, but it is the total extent of the activities which is significant. The second dimension is the primary strategic reason for the location of the factory. The framework is presented in the following figure.

Figure 3. Roles of different global factories (adapted from Ferdows, 1997)



The individual roles are characterised as follows (Ferdows 1989, 1987):

- Offshore factories utilise local low-cost production input factors, producing either components for further work in another factory or final products for sale;
- Source factories have also primarily been established for benefitting from low-cost production, but have a broader strategic role in the network, with more managerial and technical activities and higher competences on site;
- Server factories supply specific national or regional markets, and typically originate in the need to overcome tariff barriers and reduce taxes, logistics costs or exposure to exchange rates;
- Contributor factories also serves a specific national or regional market, but in comparison to server factories, have more extensive responsibilities such as product and process development

and supplier management, as well as possessing corresponding competences;

- Outpost factories' primary role is to collect information; they are thus located in areas where advanced suppliers, competitors, research laboratories or customers are located; and
- Lead factories create new processes, products and technologies for the entire company by actively using the local knowledge; they can be seen as a partner of headquarters in building strategic capabilities in the manufacturing function.

The arrows in the figure illustrate the development of the roles over time. Ferdows (1989) pointed out that although companies tend to establish their foreign factories with strategically lower roles such as offshore or server, it is important to develop them to higher roles such as source, contributor and even lead factory in order to maximise the benefit from the potential of the international units.

Ferdows' roles can be seen as descriptive rather than prescriptive in nature (Meijboom & Vos, 2004), and the roles are mainly conceptual. Despite this, Ferdows' framework is widely recognised and is considered to have strong face validity (Meijboom & Vos, 2004; Vereecke & De Meyer, 2002). It has also been tested and the empirical findings seem to give support to the existence of the various roles illustrated in the model.

Ferdows (1997) sees the lead factory as the ultimate role for a factory, towards which all factories should be developed in order to maximise the benefit from them. This argument also implies that the factories in the proximity of headquarters are lead factories and remain so. However, the development of the Danish manufacturing industry, with its significant outflow of activities from the country, shows different trends (Johansen & Riis, 2005; Riis, Johansen, Vejrum Waehrens, & Englyst, 2007). In their multiple case study of six Danish companies, Riis et al. (2007) found that some Danish factories evolve away from lead factory, either to strategically less significant roles in Ferdows' terms (contributor, source) or remain in the lead factory role but with lower

volume and other emerging lead factories abroad. While the lead factories abroad have assumed the responsibility of the main volumes, the Danish factories have been described with a different taxonomy, which is suggested to better illustrate the roles of factories located in a high-cost context such as Denmark (Riis et al., 2007):

- Full-scale: Fast, reliable delivery to customers at competitive prices; main source;
- Benchmarking: Providing knowledge about production possibilities and the costs associated carrying out effective, small-scale production (while main volumes are produced elsewhere);
- Ramp-up: Setting up the delivery of a new product or a customer-adapted version of an existing one; may also serve as an integrator with product development;
- Prototype: Assists the product development function in developing and testing products; and
- Laboratory: Develops develop new manufacturing processes and new production configurations.

Four of the five roles above could be seen as specialist roles, where full-scale production is not necessarily carried out, but a strategically important role is still vested upon the site. The roles are based on dimensions other than the Ferdows' typology; consequently, the roles are different from those of Ferdows. Thus, these four roles can be considered roles that expand the single role slot of Ferdows' lead factory. It could even be claimed that these roles can be considered 'post-lead factory' roles. Moreover, we consider that there is perhaps a chance to combine the two factory roles by Ferdows (1989, 1997) and Riis et al. (2007).

Discussion of factory roles

Interesting questions arise when the different frameworks of subsidiary and factory roles are compared. One of these is the imperative of developing factories towards lead factories: Is the competitiveness of

manufacturing really enhanced when all factories are developed towards a lead factory, as suggested by Ferdows (1997)? Consider a situation where a company is expanding its manufacturing footprint through establishing production sites in foreign countries. Would it be worthwhile to develop all the factories towards full lead factories, or would some factories remain contributors serving a given market area? Alternatively, would current lead factories even change from lead factories to contributors, responsible only for the local market, while other factories take the position of lead factories?

Developing all factories towards a lead factory can be seen to include significant risks in the light of the findings of Bartlett and Ghoshal (1989) on subsidiary roles. Bartlett and Ghoshal (1989) emphasised the importance of differentiated subsidiary, criticising an overemphasised role of headquarters and uniform treatment of subsidiaries' roles; it could be claimed that developing all factories towards a similar role as lead factory entails a risk of decreasing or even losing the differentiation between the subsidiaries. The findings of Johansen and Riis (Johansen & Riis, 2005; Riis et al., 2007) suggest that there are roles beyond lead factories – roles where the factory does not have full-scale production any more, but nevertheless serves an important purpose within the company network. Finally, although in Ferdows' model, lead factories are considered to be more strategic and more competent than others, developing all factories to that role basically ignores all potential differences between locations in terms of sources of inputs and markets. In some cases, for example, if a company has regional strategy and has a single factory in each region, and the nature of the product does not allow transportation across the world in a cost-efficient manner, these regional plants might be developed towards a lead factory role. However, the perception that a lead factory role is the aim regardless of strategy and context lacks explanation and reasoning.

When different roles are assessed, a further interesting question is also that of which dimensions would best describe the potentially differentiated roles. Combining previously presented literature about factory and subsidiary roles, several dimensions are recognised. Different models take into account the scope of activities and/or competences at

the site (Bartlett & Ghoshal, 1989; Benito et al., 2003; Ferdows 1989, 1997). However, the interpretation of this aspect is slightly different in different models. While Benito et al. (2003) recognise the scope of activities and level of competences as two different things, other models only consider one of them. Separating these two would imply that there is at least the theoretical possibility of a site carrying out a wide scope of activities with low competences (for example, a situation of inadequate resourcing), or having high competences but only limited scope of activities (such as a stand-alone R&D unit). Bartlett and Ghoshal (1986) use competence as their dimension. In his original model, Ferdows (1989) used the dimension scope of activities, but later changed this to competences (Ferdows, 1997), although he was referring more to the actual functions or activities present at the site rather than competences in the sense of capabilities. A further note on the scope of activities is that in the model of Johansen and Riis (Johansen & Riis, 2005; Riis et al., 2007), all roles except the full-scale production role describes a set of activities that is in some way less than a complete, full-scale production facility. However, the roles require high-level competences; for example, a ramp-up factory needs intense cooperation with R&D. Thus, it can be concluded that the scope of activities and the corresponding capabilities are an important factor when assessing the role of a factory or a subsidiary in general.

Besides these internal dimensions, fully or partly external dimensions have also been recognised. Bartlett and Ghoshal (1986) used as one dimension the strategic importance of the local environment, which is clearly a dimension that the site itself can only influence very limitedly. Another external dimension is the second dimension of Ferdows, i.e. the strategic reason for a site (Ferdows, 1989, 1997). This dimension has a somewhat different character from the other suggested dimensions. First, it is the only one which cannot be described on the scale of low to high. Rather, it describes a set of choices. Although Ferdows has emphasised that the dimension should be understood as the primary strategic reason for the site, the question still arises of whether the primary reason for the site can be identified at all in all situations, or whether multiple, equally important reasons for the site can be identified in some cases.

Ferdows' (1989, 1997) original model looks into the factory roles from the point of view of a global company and its network of factories. Further research on the model also mostly considers the networks of individual companies in various locations. As discussed above, in the literature on subsidiary roles, the national or regional viewpoint also can be found pertaining to what kind of subsidiaries exist overall in a given area. This approach to factory roles was adopted by Feldmann, Olhager and Persson (2009), who build on Ferdows' model to assess the types of factories that exist in Sweden. They carried out a survey of Swedish factories with two guiding research questions: What do manufacturing networks around Swedish factories look like? What roles can be assigned to the Swedish factories? Our research presented in following sections builds on the ideas of Ferdows (1989) and Feldmann et al. (2009), as the purpose of the chapter is to understand what kind of factories are found in the Finnish context, which is characterised by small local markets and high costs.

ROLES OF FACTORIES LOCATED IN FINLAND

Data collection

The data for this study were collected using an Internet-based survey. The aim of the survey was to develop a better understanding about what kinds of factories exist in Finland, the reasons for locating a factory in Finland and what kinds of roles can be assigned to factories located in Finland. The survey focused on assessing the management of manufacturing networks and included questions related to the following topics: location decisions, plant roles and competences, supplier selection, competitive priorities and plant performance, risk management and coordination. In order to allow comparability and to be able to make some broader conclusions about the Scandinavian manufacturing context, the questionnaire closely followed the survey of Feldmann et al. (2009) conducted in Sweden in 2007 (articles based on the survey data include Feldmann et al., 2009; Feldmann & Olhager, 2008; Olhager & Feldmann, 2008).

The survey was targeted to factories located in Finland with more than 50 employees, altogether approximately 1,000 plants around the coun-

try. Industries included metal industry, food industry, biotechnology, lumber industry, mechanical engineering and construction industry. It is notable that in contrast, for example, to Ferdows' ideas, our purpose is not to assess various factory roles within a specific manufacturing network of a company, but rather to use the factory role framework to assess the roles of factories at a national level.

Plant managers were contacted by email and invited to participate in the survey. Three reminders were sent by e-mail and a further reminder was sent by mail to about third of the sample (randomly chosen), with a questionnaire and a return envelope. Some of the respondents were contacted by phone as well. Nearly 200 of the possible respondents could not be reached due to, for example, changed contact information or because the email was filtered as junk mail, giving a population of about 800 plants. In total, 67 plants responded to the survey. This gives a response rate of about 8.5%. The main characteristics of the plants that responded to the questionnaire are shown in the following illustration. Most of the respondents were either plant or production managers, and most plants had 50–250 employees. It can be seen that the sample is highly diverse in terms of size and industry, as was intended. Assessment of differences between the first and later response waves showed no statistically significant difference in most performance factors, which implies that the potential nonresponse bias is likely not significant (Lambert & Harrington, 1990). Furthermore, there was no difference in the response rate between the small- and larger-size plants. Finally, a comparison was made between the sample factories and the total population. The comparison indicated that even though the size of the sample is small, it reflects the population rather well; in terms of number of employees, the sample includes only slightly larger factories.

Figure 4. Sample characteristics

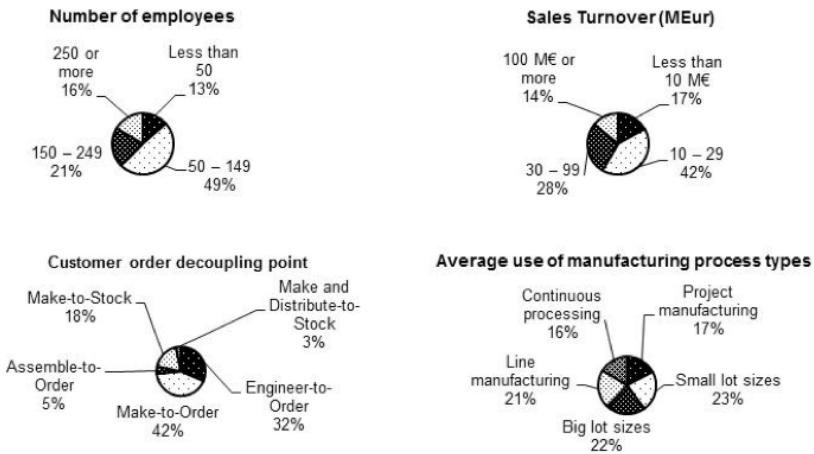

Analysis

The analysis aimed at developing a better understanding of the kinds of factories which exist in Finland. The plants were considered stand-alone objects, as the purpose was to understand the roles of units within the chosen context, and not within their respective networks. The survey data were analysed on the two dimensions of Ferdows' (1989, 1997) model, specifically the strategic reason for the factory and responsibilities of the factory. The strategic reasons for the plant locations were operationalised by asking the respondent to evaluate the importance of eight location factors for the factory or advantages of the present location:

- Proximity to markets;
- Proximity to transportation centres;
- Proximity to cheap labour;
- Proximity to knowledge centres;

- Proximity to competitors;
- Proximity to raw materials;
- Access to cheap energy; and
- Favourable sociopolitical climate.

The evaluation was conducted using a seven-point Likert scale (1 = not important at all, 7 = absolutely the most important). The descriptive results are presented in Figure 5.

Figure 5. Importance of different criteria in factory location decisions

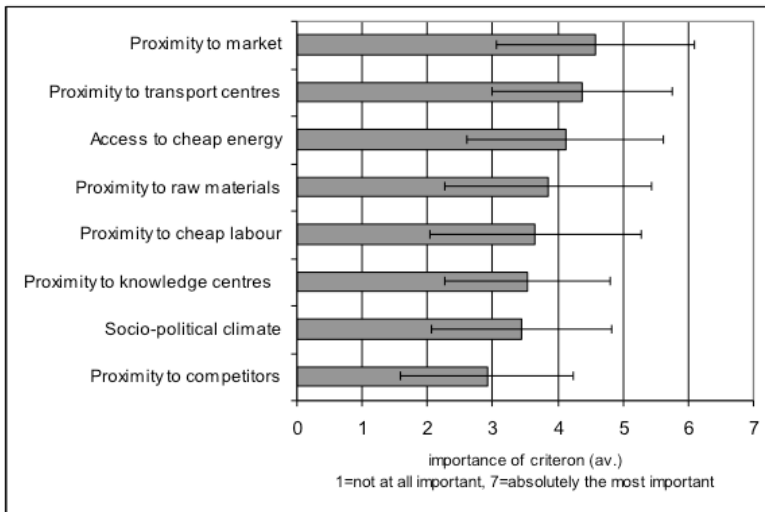

The results indicate the importance of local markets; the most important element in the location of factories in Finland seems to be proximity to the market (average 4.58/7), which is one of the three main strategic reasons in Ferdows' model (1989, 1997). Good transport connections were also considered very important. This would imply that

factories in Finland have a strong role in serving nearby markets. The other two main reasons which Ferdows lists, access to low-cost production (cheap labour and cheap energy) and access to knowledge, were not considered very important on average. The former result is not surprising, since Finland is considered a high-cost country. The low importance of the proximity to knowledge centres, i.e. access to knowledge, on the other hand, is rather surprising and even somewhat alarming. In current political discussion, a high education level and an educated work force are considered to be Finland's strengths and the basis for future operational activities in the country. It is also a surprising finding when comparing the results to the research on Sweden (Feldmann et al., 2009), where the proximity to knowledge centres was found to be the most important reason for factory location. Other than the importance of proximity to knowledge centres, the Swedish survey shows very similar results: The proximity to the transportation centres and proximity to the market, which in Finland are considered the two most important elements, are the second and third most important in Sweden.

Looking at the strategic reasons for factory location alone, it would seem that Finnish factories are mainly contributors (or even servers) in Ferdows' roles, since the most important element is proximity to the markets. Due to the cost level of the country, we were not expecting to see offshore or source factories, as the results also indicate. The lower importance of proximity to knowledge centres, on the other hand, implies that the factories are not likely to be outpost or lead factories either.

In order to measure the activities or the competence level of the factory, 11 competence areas were assessed based on prior literature (Ferdows, 1989, 1997; Feldmann et al., 2009):

- Production;
- Production planning;
- Technical maintenance;

- Process development;
- Purchasing;
- Logistics;
- Introduction of new process technologies;
- Supplier development;
- Introduction of new product technologies;
- Product development; and
- Supply of global markets.

With each of these competence areas, responsibility can be assigned to the factory or held centrally or regionally. In the surveys, the respondents were asked to evaluate the extent to which the factory is responsible for these areas on a seven-point Likert scale (1 = no local authority, 7 = full local authority). The descriptive results are presented in Figure 6.

Figure 6. Extent of responsibility held by the plant

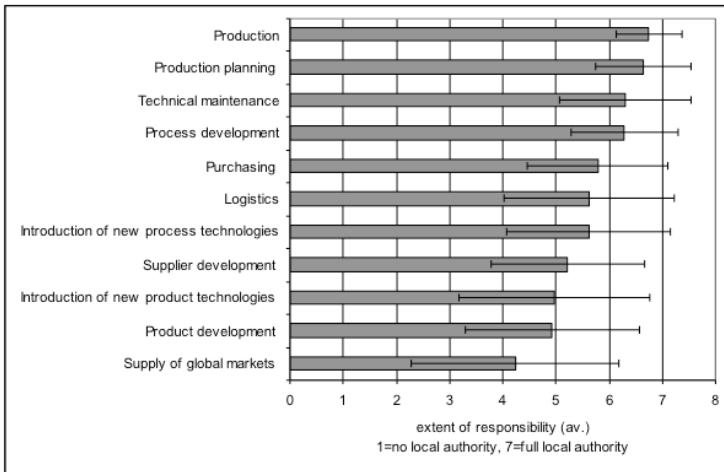

On average, the factories have fairly high authority in the different areas of responsibility. Logically, production is the activity most often given local authority, followed closely by production planning, technical maintenance and process development. All of these areas are closely related to the actual production activities. On the other end, supplier development, introduction of new product technologies, product development and supply of global markets are activities for which the factory is not responsible. This is understandable, particularly when the company has several factories, and these issues are often decided globally or regionally at the corporate or business unit level. The low level of responsibility for the supply of global markets, on the other hand, also supports the idea that the factories located in Finland serve local markets. Notable is that even in the areas with the lowest responsibility, the rating was fairly high, which indicates that the plants have a lot of responsibilities and act quite independently.

In order to find out whether there are correlations between the items within the two respective dimensions, the reason for the location and the competence level of the factory, a more detailed analysis was conducted. Previous research has often operationalised the level of strategic role of the factory as a single item (e.g. Maritan, Brush, & Karnani, 2004; Vereecke & Van Dierdonck, 2002), in which case potential patterns are not necessarily revealed. Previous research has mostly used a single or rather simple measure for determining the level of factory competence, and has manually grouped the factories in terms of the reason for the location. An exception is Olhager and Feldmann (2008), who performed both a factor analysis and a cluster analysis to study the two dimensions and their joint variation. The analysis in the present chapter was carried out in a similar fashion.

In the first phase, a factor and cluster analysis were performed to assess whether the eight location factors are interrelated, and specifically whether same major reasons can be found as pointed out by Ferdows (1989, 1997) and Vereecke and Van Dierdonck (2002). However, neither the factor nor the cluster analysis which we performed gave any clear results. It can thus be concluded that the reason for factory location among the factories in Finland cannot be used to determine the roles

of the plants following Ferdows (1989, 1997) and the empirical findings among Swedish plants (Olhager & Feldmann, 2008). This implies that within the sample of factories in Finland, the underlying reasons for the factory location are complex and no clear major reasons can be found – location is rather a combination of factors differing from case to case. Another potential explanation can be found in historical reasons; especially in cases of rather small companies which might have just a single factory, the factory is still located where it was established, likely to serve a very local market at that time.

A similar analysis was conducted for the 11 items related to factory competence. First, principle component analysis with varimax rotation was conducted. The analysis gives four factors, which were called (1) development, (2) supply chain, (3) manufacturing and (4) process. The first component consists of new product development, introduction of new product and process technologies and global market introductions, which are all related to development efforts. Logistics, procurement and supplier development are related to the supply chain. The third component includes the basic operations functions at a factory: production and production planning. The final component then includes process maintenance and process improvement. The results of the principle component analysis are somewhat different than what was found in the Swedish sample (Olhager & Feldmann, 2008), as they focused on only the three first factors.

As a second step, a cluster analysis was conducted. In further analysis, it was found that while the factories can be characterised using the four factors of development, supply chain, manufacturing and process, the factories can also be clustered according to their level of activities into three clusters, which show a cumulative pattern: The first group of plants is somewhat high on manufacturing and process competencies, second group is high on these as well as supply chain competencies and the final group on all three of these elements, as well as development competencies. This is illustrated in Figure 7, which also shows the number of factories in each cluster.

Figure 7. Cumulative factory competences

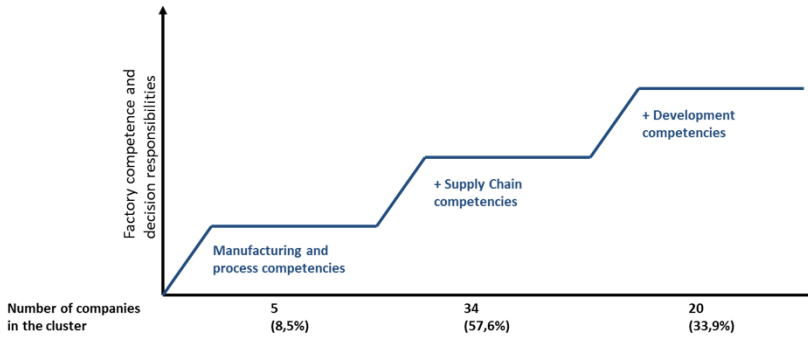

DISCUSSION AND CONCLUSIONS

Based on the survey results, it can be concluded that factories in Finland seem to have roles which involve rather high local decision making authority and a lot of responsibilities. The main reasons for the location of factories in Finland seem to be related to proximity to local markets. For a high-cost location like Finland, it is logical that low production cost is not important as a location factor. However, it is somewhat surprising that the proximity to knowledge centres does not seem to be a major reason to locate a factory in Finland. This is even somewhat alarming from an economic point of view in terms of the future of manufacturing in Finland, or potentially, other Scandinavian countries. Based on these results, factories in Finland seem to especially resemble contributor factories in Ferdows' (1989) typology, i.e. factories, which serve a specific national or regional market, but have in comparison to a server factory more extensive responsibilities, such as product and process development, supplier management and possesses corresponding competences. The low importance of access to knowledge centres and the relatively low share of factories with global delivery responsibilities suggest that lead factories, which Ferdows (1989, 1997) considered to be the most desirable role for a factory, exist

only in limited number in Finland. However, supply of global markets had a very high standard deviation, so the responsibility level of factories varies a lot. Factories also have quite a lot of responsibility for product development and introduction of new product technologies, which indicates that many factories have the competencies required by a lead factory. It should also be noted that the results point to significant variety in the factories' roles regarding competence level.

The current political discussion strongly emphasises the importance of education and a qualified workforce as a strength of Finland as a host of manufacturing activities, especially in the future. However, the survey findings indicate that the access to knowledge centres is one of the least important location factors for Finnish factories. Furthermore, only a few factories with truly global delivery responsibility could be found in this sample. Ferdows (1997) suggests that factories should be developed towards lead factories in order to fully utilise their potential. If factories in Finland are mainly of the contributor-type, the question arises of what will happen to them if the market loses importance and decreases. Most likely, contributor factories serving only those regional markets will suffer, and this will have significant implications for the Finnish economy.

One explanation for the lack of high competence factories, such as lead factories which cannot be tested with this survey data could have to do with the 'post-lead'-type of factory role. Based on Danish research, Johansen and Riis (Johansen & Riis, 2005; Riis et al., 2007) have suggested roles beyond lead factories such as laboratory, benchmarking, prototype and ramp-up. The low number of lead factories in our sample might partly be due to the fact that, with the operationalisation that was used, not all roles were identified in our study. Thus, some of the factories may well have high competences and no global supply responsibility but still serve important roles in their respective factory networks as, e.g. prototype or ramp-up factories. There may even be unrevealed roles which require high levels of competence but do not involve global delivery responsibilities, or even full-scale production (Blomqvist & Turkulainen, 2011).

From a managerial point of view, the models of factory roles provide structured frameworks to analyse the roles of the factories and the operations networks of their companies. Relevant questions for an individual company include the following: What kinds of roles do the factories currently have? What kind of operations network do they build together? Is this network balanced as a whole? Do the individual factories and the network as a whole support the corporate strategy and help to reach the goals and targets of the company? And finally, what improvements and changes are needed for individual factories and the whole network?

REFERENCES

- Ambos, B., & Schlegelmilch, B.B. (2007). Innovation and control in the multinational firm: A comparison of political and contingency approaches. *Strategic Management Journal*, 28(5), 473–386.
- Aron, R., & Singh, J.V. (2005). Getting offshoring right. *Harvard Business Review*, 83(12), 135–143.
- Ali-Yrkkö, J. (2006). *Ulkoistus ja toimintojen siirrot Suomesta ulkomaille—katsaus 2000-luvun alun tilanteesta* [Outsourcing and offshoring—Overview from Finland in the early 21st century]. ETLA Discussion paper nr 1059. Helsinki: ETLA (Research Institute of the Finnish Economy).
- Bartlett, C.A., & Ghoshal, S. (1986). Tap your subsidiaries for global reach. *Harvard Business Review*, 64(6), 87–94.
- Benito, G.R.G., Grogaard, B., & Narula, R. (2003). Environmental influences in MNE subsidiary roles: Economic integration and the Nordic countries. *Journal of International Business Studies*, 34(5), 443–456.
- Blomqvist, M., & Turkulainen, V. (2011). Managing global manufacturing networks—Uncovered plant roles of global manufacturing companies. Paper presented at the 18th International Annual EurOMA Conference: Exploring interfaces. Cambridge, UK, July 3–6, 2011.
- Boyer, K.K., & Lewis, M.W. (2002). Competitive priorities: Investigating the need for trade-offs in operations strategy. *Production and Operations Management*, 11(1), 9–20.
- Brush, T. H., Maritan, C., A., & Karnani, A. (1999). The plant location decision in multinational manufacturing firms: An empirical analysis of international business and manufacturing strategy perspectives. *Production and Operations Management*, 8(2), 109–132.
- Childerhouse, P., Aitken, J., & Towill, D.R. (2002). Analysis and design of focused supply chains. *Journal of Operations Management*, 20(6), 675–689.

- Christopher, M., Peck, H., & Towill, D. (2006). A taxonomy for selecting global supply chain strategies. *The International Journal of Logistics Management*, 17(2), 277–287.
- Collín, J., & Eloranta, E. (2009). How to design the right supply chain for your customers. *Supply Chain Management: An International Journal*, 14(6), 411–417.
- Da Silveira, G., & Slack, N. (2001). Exploring the trade-off concept. *International Journal of Operations and Production Management*, 21(7), 949–964.
- Eloranta, E., Ranta, J., Salmi, P., & Ylä-Anttila, P. (2010). *Teollinen Suomi* [Industrial Finland]. Helsinki: SITRA.
- Ettlie, J.E., & Sethuraman, K. (2002). Locus of supply and global manufacturing. *International Journal of Operations and Production Management*, 22(3), 349–370.
- Farrell, D. (2006). Smarter offshoring. *Harvard Business Review*, 84(6), 84–92.
- Feldmann, A., & Olhager, J. (2008). Internal and external suppliers in manufacturing networks—An empirical analysis. *Operations Management Research*, 1(2), 141–149.
- Feldmann, A., Olhager, J., & Persson, F. (2009). Designing and managing manufacturing networks—A survey of Swedish plants. *Production Planning and Control*, 20(2), 101–112.
- Ferdows, K. (1989). Mapping international factory networks. In K. Ferdows (Ed.), *Managing international manufacturing* 3–21. Elsevier, Amsterdam.
- Ferdows, K. (1997). Making the most of foreign factories. *Harvard Business Review*, 75(2), 73–88.

- Ferdows, K., & De Meyer, A. (1990). Lasting Improvements in manufacturing performance: In search of a new theory. *Journal of Operations Management*, 9(2), 168–184.
- Fisher, M.L. (1997). What is the right supply chain for your product? *Harvard Business Review*, 75(3), 105–116.
- Hayes, R., Pisano, G., Upton, D., & Wheelwright, S. (2005). *Operations, strategy, and technology—Pursuing the competitive edge*. Hoboken, NJ: John Wiley & Sons.
- Hayes, R.H., & Wheelwright, S.C. (1984). *Restoring our competitive edge: Competing through manufacturing*. New York: John Wiley & Sons.
- Hill, T. (1985). *Manufacturing strategy: The strategic management of the manufacturing function*. London: Macmillan.
- Holcomb, T.R., & Hitt, M.A. (2007). Toward a model of strategic outsourcing. *Journal of Operations Management*, 25(2), 219–584.
- Johansen, J., & Riis, J.O. (2005). The interactive firm—Towards a new paradigm. *International Journal of Operations and Production Management*, 25(2), 202–216.
- Johanson, J., & Wiedersheim-Paul, F. (1975). The internationalization of the firm—Four Swedish cases. *Journal of Management Studies*, 12(3), 305–322.
- Kinkel, S., & Maloca, S. (2009). Drivers and antecedents of manufacturing offshoring and backshoring—A German perspective. *Journal of Purchasing and Supply Management*, 15(3), 154–165.
- Lambert, D.M., & Harrington, T.C. (1990). Measuring nonresponse bias in customer service mail surveys. *Journal of Business Logistics*, 11(2), 5–25.

- Lee, H.L. (2002). Aligning supply chain strategies with product uncertainties. *California Management Review*, 44(3), 105–119.
- Lewin, A. Y., & Peeters, C. (2006). The top-line allure of offshoring. *Harvard Business Review*, 84(3), 22–24.
- Lovio, R. (2006). *Sijainti seuraa strategiaa: kokonaiskuva suomalaisten monikansallisten yritysten globaalien karttojen muutoksista 2000–2005* [Location follows strategy: Changing global maps of the Finnish multinational enterprises 2000–2005]. Discussion paper nr 1053. Helsinki: ETLA (Research Institute of the Finnish Economy).
- Maritan, C.A., Brush, T.H., & Karnani, A.G., (2004). Plant roles and decision autonomy in multinational plant networks. *Journal of Operations Management*, 22(5), 489–503.
- McIvor, R. (2009). How the transaction cost and resource-based theories of the firm inform outsourcing evaluation. *Journal of Operations Management*, 27(1), 45–63.
- Meijboom, B., & Vos, B. (2004). Site competence dynamics in international manufacturing networks: Instrument development and a test in Eastern European factories. *Journal of Purchasing and Supply Management*, 10(3), 127–136.
- Olhager, J., & Feldmann, A. (2008). Svenska fabrikers roller [Plant roles of Swedish plants]. *Produktionsstrategi*, 4(2).
- Riis, J.O., Johansen, J., Vejrum Waehrens, B., & Englyst, L. (2007). Strategic roles of manufacturing. *Journal of Manufacturing Technology Management*, 18(8), 933–948.
- Rosenzweig, E.D., & Easton, G.S. (2010). Tradeoffs in manufacturing? A meta-analysis and critique of the literature. *Production and Operations Management*, 19(2), 127–141.
- Schmenner, R.W. (1983). Every factory has a life cycle. *Harvard Business Review*, 61(2), 121–129.

- Schmenner, R. W., & Swink, M. L. (1998). On theory in operations management. *Journal of Operations Management*, 17(1), 97–113.
- Shewchuk, J.P. (1998). Agile manufacturing: One size does not fit all. In U.S. Bititci & A.S. Carrie (Eds.): *Strategic management of the manufacturing value chain. Proceedings of the International Conference of the Manufacturing Value-Chain in Troon, Scotland, UK, 1998* (pp. 143–150). Norwell, MA: Kluwer Academic Publishers.
- Skinner, W. (1969). Manufacturing—Missing link in corporate strategy. *Harvard Business Review*, 37(3), 136–145.
- Skinner, W. (1974). The focused factory. *Harvard Business Review*, 52(3), 113–121.
- Turkulainen, V., & Blomqvist, M. (2011). Plant roles in high cost countries—A survey analysis of manufacturing networks in the Northern Europe. Paper presented at the 18th International Annual Eu-roma Conference: Exploring Interfaces. Cambridge, UK, July 3–6.
- Vereecke, A. & van Dierdonck, R. (2002). The strategic role of the plant: Testing Ferdows' model. *International Journal of Operations and Production Management*, 22(5), 492–514.

CHAPTER 3

Operations Network Development: Internalisation and Externalisation of Value Chain Activities

Yang Cheng, Aalborg University, Denmark

John Johansen, Aalborg University, Denmark

ABSTRACT

Since the late 1980s, manufacturing systems have gradually evolved from factory/plant-based systems towards globally collaborative inter-firm networks. Shi (2004) proposed a roadmap for the manufacturing system evolution. Taking this work as a starting point, this chapter first investigates the existing literature on the factory/plant, international manufacturing network, supply network and global manufacturing virtual network (GMVN). Claiming that conceptual insights describe only one of the two worlds (i.e. research and practice) of operations management, this chapter successively explores what is actually happening in practice to address potential queries. Then, three cases are selected from GONE project for in-depth analyses in order to understand the internationalisation and externalisation of manufacturing. The empirical findings derived from the case studies suggest that the discussions on internationalisation and externalisation need to be extended from manufacturing activity to other value chain activities. The roadmap proposed by Shi (2004) thus has to be extended in the internationalisation and externalisation dimensions. Accordingly, two new development trajectories, that is, the internationalisation and the externalisation of value chain activities, are proposed. Their similarities and differences are further compared and discussed. Finally, this chapter indicates that the case companies tend to combine two development trajectories, and

suggests that managers must make a tradeoff between internationalisation and externalisation and maintain a relative balance in order to manage a global collaborative value network.

INTRODUCTION

Since the late 1980s, manufacturing has become more international because it is the single largest type of foreign direct investment in most countries (Ferdows, 1997a; Kogut, 1990; Yip, 1989). Accordingly, manufacturing companies have attempted to globalise their geographically dispersed plants by coordinating them with a synergetic network (Ferdows, 1997a, b; Shi & Gregory, 1998), and their role has accordingly changed from supplying domestic markets with products via supplying international markets through export, to supplying international markets through local manufacturing. This integration has further resulted in a rapid change in manufacturing system concepts, which have moved from a focus on the plant to one on international manufacturing networks (Ferdows, 1989; Rudberg & Olhager, 2003).

Meanwhile, it has also become more accepted for all types of companies to downsize and outsource non-core manufacturing tasks and to organise interfirm collaborations (Lambert, Cooper, & Pagh, 1998; Lamming, Johnsen, Zheng, & Harland, 2000). This development has pushed companies further into new relationships beyond the conventional concepts of the firm that owns and operates its own factories. Although companies may own only a very small portion of a supply chain, they still are strategically able to coordinate or integrate the whole supply chain to deliver a competitive product to the targeted market (Shi, 2004).

Combining both developments, Shi (2004) proposed a matrix derived with the characteristics of internalisation and externalisation of manufacturing activities in order to illustrate a roadmap for the evolution of manufacturing systems (see Figure 1). Many other studies on global outsourcing and partnership have also sought to develop a framework with similar architecture and strategic capabilities pursuing higher value and innovation (e.g. Bovel & Martha, 2000; Normann & Ranfrez, 1993; Parolini, 1999).

Figure 1. Manufacturing system evolution matrix and key drivers
(Source: Shi, 2004)

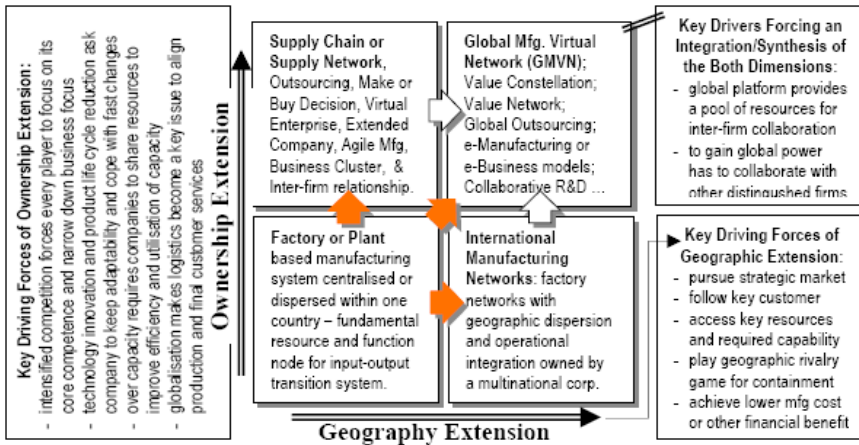

Taking this matrix as a starting point, the purposes of this chapter are threefold. First, it aims to investigate what has been done in the two indicated developments by reviewing the relevant literature. Second, based on explorative case studies, it will explore what is happening in the development of manufacturing systems (networks) in practice. Third, it attempts to determine what we can learn from current theories and practices by providing an integrated understanding of internationalisation and externalisation, as well as seeking to identify further developmental trends.

THEORETICAL BACKGROUND

The aim of this section is to investigate what has been done in the two indicated developments, that is, the internationalisation and externalisation of manufacturing activities. Taking Figure 1 as an analytical framework, we attempt to review the existing literature on those four boxes in the figure, that is, (1) the strategic roles of plants, (2) the international manufacturing network, (3) supply networks and (4) global manufacturing virtual networks (GMVNs), in order to generate a deep understanding on the two developments.

The strategic roles of plants

Global manufacturing did not attract much attention in the operations management (OM) community until the 1980s. During the late 1970s and the early 1980s, more scholars noticed the need to manage not only a single factory but also multiplant organisations. However, the research during this period was mainly concerned with location-based criteria (Shi & Gregory, 1998) and mostly focused on plant location decisions (Meijboom & Voordijk, 2003). At that time, plant location decision making referred merely to selecting a site for a new plant. For some plants, the choice was straightforward, involving only the selection of the least costly site (Schmenner, 1979). In the OM literature, these choices are often based on mathematical programming (Canel & Khumawala, 1996; Katayama, 1999), which mainly concentrates on the *where* aspect, paying little attention to *why* issues. The only *why* issue described is cost minimisation (Meijboom & Voordijk, 2003). On the other hand, more recent research has argued that cost evaluation does not reveal the complete story. Furthermore, it sometimes does not show differences that are significant enough to make a location choice strictly on their merit. Researchers and managers should therefore look beyond the obvious in choosing plant locations. An exploration of the intangible and qualitative features of a location is expected to contribute to the company's competitive success (Schmenner, 1979).

Because plants are expected to contribute more than lower costs to companies, they are recognised as being capable of playing different roles in manufacturing networks (Ferdows, 1989, 1997b). Although the concept of plant roles was first introduced by Ferdows (1989, 1997b), the discussions generally began by looking at the roles of subsidiaries in multinationals. The literature on international strategy provides several taxonomies describing the strategic roles of these subsidiaries (Bartlett & Ghoshal, 1989; Ghoshal & Nohria, 1993; Roth & Morrison, 1992; Taggart, 1998), giving rich insights into the distinct strategic roles subsidiaries may play in multinationals. Ferdows (1989, 1997b) translated the strategic classifications of subsidiaries into the manufacturing classification of plants. His model distinguishes plants based on plant competences and location advantages, and identifies six types of plants, which he labels offshore, source, server, contributor, outpost

and lead plant. Furthermore, Ferdows makes interesting assertions about the evolution of strategic roles that can or should be expected due to the pressure to reduce costs, which may call for concentrating production in a smaller number of plants, or the appearance of new opportunities (De Meyer & Vereecke, 1996).

Ferdows' model gained academic recognition, and many researchers have taken it as a point of departure for their research (Fusco & Spring, 2003; Maritan, Brush, & Karnani, 2004; Meijboom & Voordijk, 2003; Meijboom & Vos, 2004; Vereecke & Dierdonck, 2002). In addition to Ferdows' model, other plant typologies were introduced from the different perspectives of other researchers. For example, Vereecke, Van Dierdonck and De Meyer (2006) proposed a new, empirically derived typology of plants in international manufacturing networks based on knowledge flows between plants. The analysis led to the identification of four types of plants with different network roles: the isolated plant, the receiver, the hosting network player and the active network player.

Internationalisation: From plant to international manufacturing network

Although during the late 1970s and the early 1980s more scholars noticed the need to manage not only a single factory, but also multiplant organisations, researchers still tended to treat each factory as a separate single facility and thereby ignore networking issues (Schmenner, 1982). This is because manufacturing was fairly geographically concentrated even if markets became global at that time. Nevertheless, during the later 1980s and 1990s, models and frameworks which were developed in the fields of international business and strategy further facilitated manufacturing strategy research focusing on international operations (Vereecke & Dierdonck, 2002). More scholars, for example, Ferdows (1989, 1997b), Flaherty (1986, 1996), and Shi and Gregory (1995) attempted to build a link between manufacturing strategy concepts and views from international strategy and/or international business, and accordingly, international manufacturing networks gradually became one of the foci.

Within the decision-making process related to the global manufactur-

ing network, two types of decisions can be distinguished: configuration and coordination (Fawcett, Birou, & Taylor, 1993; Porter, 1986). *Configuration* indicates the plants' locations and the interfacility allocation of resources along the value chain (Meijboom & Vos, 1997). It concerns issues such as the building of a network of subsidiaries with particular emphasis on the differentiated structural requirements of different environments. This aspect has its origins in multiplant research and is dominated by location-based criteria of various sorts (Dubois, Toyne, & Oliff, 1993; Ferdows, 1997b). Initially, much research concentrated on identifying the drivers for allocating manufacturing facilities in specific locations (Bolisani & Scarso, 1996; Ferdows, 1989, 1997b; MacCarthy & Atthirawong, 2003; Meijboom & Vos, 1997; Vos, 1991). However, because more researchers have recently recognised the importance of entire manufacturing networks, studies have no longer been limited to plant location decisions and have extended to international manufacturing network configurations. Schmenner (1979, 1982), although concentrating on plant-by-plant decisions, hinted at the network idea and devised five possible types of multiplant strategies. Shi and Gregory (1998) put forward an international configuration map which groups seven network configurations into four blocks along two dimensions: degree of geographical dispersion and level of coordination. Hayes et al. (2005) suggested four network configurations – a horizontal network (product-focused network), a vertical network (process-focused network), a mixed network and an 'orchestrated' network (collaborative network with one major hub). More recently, Ferdows (2009) expanded his original model of strategic plant roles to include global manufacturing networks.

Coordination is related to managing a network and refers to the question of how to link or integrate the production and distribution facilities in order to achieve the firm's strategic objectives. The aim of coordination is to achieve an efficient and effective plan for global production activities, which involves primarily tactical decisions in different business areas and within several processes. In addition, this planning aim is concerned with technology transfer and diffusion, as well as within-network learning (Ferdows, 2006; Flaherty, 1996; Gailbraith, 1990). Bhatnagar et al. (1993) provided an extensive literature review of

the available models for general and multiplant coordination and distinguished two broad levels of coordination: a general level and a multiplant level. Das et al. (1998) proposed an approach based on reinforcement learning to coordinate a multiplant and multicountry facility network that spans manufacturing and distribution stages. Rudberg and West (2008) presented a concept that describes how companies can manage their international operations to facilitate coordinating their manufacturing networks, focusing on blending cost competitiveness, flexibility and innovativeness.

Configuration and coordination are closely related. Therefore, in some instances, attempts have been made to integrate the two issues to achieve an overall view of the manufacturing network (Porter, 1986; Shi & Gregory, 1998; Vereecke & Dierdonck, 1999). Pursuing a similar line of research, Rudberg and Olhager (2003) presented a typology for analysing network systems that resulted in four basic network configurations: plant, intrafirm network, supply chain and interfirm network. These configurations correspond to four coordination approaches: utilise, optimise, synchronise and harmonise.

Externalisation: From plant to supply network

Related to the internalisation of manufacturing activities, another trend often observed is externalisation from traditional vertical integrated firms in almost every sector (Shi, 2004). Due to the increased focus on the externalisation or outsourcing, topics related to the supply chain/network become even more relevant and necessary. Setting roots in physical distribution and materials management, research on the supply chain/network tends to analyse the network as an external network with facilities owned by different organisations. Traditionally, research focused on the links between the nodes (and to some extent distribution nodes), whereas manufacturing network research tends to focus on the (manufacturing) nodes themselves (Rudberg & Olhager, 2003).

Similar to the international manufacturing network, the externalised interfirm supply network has extended its boundaries from the plant-based manufacturing system, as illustrated in Figure 1, but with quite

different focuses, such as collaboration, partnerships, trust, customer relationship management, customer service management, demand management, order fulfilment and procurement (Lambert & Cooper, 2000). This further makes the supply network a new unit of analysis with more features than the classical plant (Shi, 2004). Since the 1980s, supply chain networks as a research topic have attracted increasing attention. In addition, various supply chain network models have been developed. For example, Fisher (1997) suggested that two distinct types of supply networks exist: those for 'innovative-unique' products and those for 'functional' products. Lambert and Cooper (2000) proposed a supply network framework which consists of three closely interrelated elements: the supply chain network structure (i.e. the member firms and the links between these firms), the supply chain business processes (i.e. the activities that produce a specific output of value to the customers) and the supply chain management components (i.e. the managerial variables by which the business processes are integrated and managed across the supply chain). Andersen and Christensen (2005) provided an ideal-type model of the international supply network, encompassing the five principal positions (i.e. local integrator, export base, import base, international spanner and global integrator) in a supply network spanning international and local business contexts. Camuffo, Furlan, Romano and Vinelli (2007) identified three different routes toward supplier and production network internationalisation: traditional subcontracting, coordinated subcontracting and supply system relocation. Actually, the main contents of supply network management are not new to production/OM, and three streams can generally be recognised (Shi, 2004): inventory models and control mechanisms; strategic management about collaboration and value creation; and clustering studies.

A possible combination: Global manufacturing virtual networks (GMVNs)

Shi and Gregory (2005) discussed the internalisation and externalisation of manufacturing activities in a holistic way by addressing intra-firm and interfirm (external) networks at the same time. The authors reported that the manufacturing industry is currently transforming from the traditional, vertically integrated value chain to collaboration

between specialised independent companies, and the collaboration between original equipment manufacturers (OEMs) and contract (electronics) manufacturers (CEMs) leads global manufacturing networks (GMNs) to evolve into global manufacturing virtual networks (GMVNs). Furthermore, combining research on global manufacturing networks, international strategic alliances and virtual organisations, the authors proposed that a GMVN can be considered the synthesis of views along four basic dimensions:

- 'G': Global disposition and the evolution of manufacturing internationalisation are represented in the manufacturing internationalisation dimension;
- 'M': Value-creation-oriented manufacturing activities and positioning are represented in the value and supply chains dimension;
- 'V': Collaborations with other companies to formulate a strategic alliance or temporary virtual supply chain are represented by the strategic alliance dimension;
- 'N': A synthesis process, which must include network strategy process, communication platform and operational mechanisms.

The GMVN provides a new platform that engages developing countries' manufacturing firms to play complementary roles and to be integrated into a global supply chain. However, current research on manufacturing systems and OM is still limited to two-dimensional constructs – either on the GxV 'plane' dealing with internationalisation and alliances, or the GxM plane dealing with supply chain and internationalisation (Harland et al., 1999).

EMPIRICAL EXPLORATIONS

The literature review in the last section revealed the research which has been conducted and the theories which have been developed in terms of two development trends, that is, the internationalisation and

externalisation of manufacturing activities. Derived from academic research, these conceptual insights merely address one of the two worlds (i.e. research and practice) of OM (Slack, Lewis, & Bates, 2004), which is not enough, since OM treated as an 'empirical science' (Swamidass, 1991) normally focuses on 'real' managerial preoccupations (Wilson, 1995) and regularly rededicates itself to the needs of practitioners (e.g. Hayes, 2000). Accordingly, more empirical studies are needed to investigate how the real world responds to these theories. Queries need to be addressed such as: What are the implications of the manufacturing evolution for the practitioner? Are the existing theories sufficient to describe and explain what is happening in the practice? What are the ongoing and/or further development trends of manufacturing systems (networks)? This necessity indicates that empirical explorations have become significant.

The Global Operations Networks (GONE) project provides an excellent opportunity to address the potential queries mentioned above. The case study was selected as the primary research method for the GONE project and mainly used for explorative purposes (Handfield & Melnyk, 1998; Yin, 2003). Unconstrained by the limits of questionnaires and models, the case study can lead to new and creative insights and has high validity with practitioners (Voss, Tsikiktsis, & Frohlich, 2002). The GONE project involved 17 companies from five different industries (i.e. furniture, marine, telecom, textile and shoes), where 14 companies (82% of the case companies) had internationalised or externalised their manufacturing activities, or both. To fundamentally understand the internationalisation and externalisation of manufacturing, three companies were then selected from the GONE project for in-depth analyses:

- Aalborg Industries was selected because it is one of the case companies that mainly internationalises its manufacturing activities globally to other sites within its intranetwork, but at the same time, externalises its manufacturing activities to other suppliers.
- Fritz Hansen and Trio Line were selected because they are the only case companies which can represent the whole external-

isation picture. The brand owner, that is, Fritz Hansen, outsourced its manufacturing activities to the external supplier, that is, Trio Line.

These companies are from different industries (marine and furniture) and have different characteristics. See Table 1 for key information about each case company.

Table 1: Key characteristics of the case companies
(Source: Rundberg and Olhager, 2003)

Trend	Internationalisation	Externalisation	
Company	Aalborg Industries	Fritz Hansen	Trio Line
Size in 2009	2,906 employees in 13 countries	211 employees in 11 countries	195 employees in two countries
Product	Boiler, inert gas systems, thermal fluid systems and shell and tube heat exchangers	Furniture (tables, sofas, chairs, upholstery)	Chairs
Revenue (EUR million) in 2009	370	54	10
Current mfg. footprint	China, Denmark, Brazil and Vietnam	N/A	Denmark, Poland

Aalborg Industries

Aalborg Industries is a Danish company which is highly specialised in boiler engineering and production, with headquarters in Aalborg. Established in 1912, Aalborg Industries has supplied and serviced marine and offshore industries and produced boilers, inert gas systems, thermal fluid systems, burners, control systems and other related accessories, including heat exchangers, for almost a century. Today, Aal-

borg Industries has 24 sites in 12 countries. The setup is centred on four production sites in Denmark, China, Vietnam and Brazil, while the remaining subsidiaries focus on purchasing or after-sales services.

Decades ago, Aalborg Industries' entire production was in Aalborg. However, developments in the marine industry meant that Aalborg Industries needed to move most of its production to developing countries to save costs and be close to its customers. Since the 1990s, Aalborg Industries has made a clear objective to locate its activities, that is, keeping costs at a minimum while maintaining uniform product quality and delivery accuracy. The result has been a movement of manufacturing activities from Aalborg to China. The trend seems likely to continue in the future and includes moving other functions like research and development (R&D) as well. Today, because some customers have preferences for where their products should come from, some production activities are still retained in Denmark, despite the high production costs. In addition, the majority of the R&D department is still in Aalborg. The products produced in China are most likely products that have been developed and tested in Denmark, and thereafter moved to China, for instance, with certain adaptations.

Currently, two subsidiaries are located in China. The one in Qingdao is the largest production site within the company, producing 1,500 boilers per year. Due to the rapid development in China in the last five years, the company recently planned a further enlargement of this site. So far, the site's capacity has increased by 30–40% each year. Additionally, in order to keep pace with the rapid development, the company has chosen to place a knowledge centre at this production site, which is used to support production activities and provide knowledge and thorough insights into the Chinese market and practices. Another subsidiary, in Shanghai, is a service subsidiary, which is composed of a development and purchasing centre. The development centre in Shanghai studies development and standardisation initiatives, whereas the purchasing centre initially worked with order processing, but has turned into a trade centre to evade Chinese import and export barriers. These knowledge-intensive activities were moved to Shanghai because of the shortage of available engineers in Denmark a few years

ago, as well as improved cultural understanding, the establishment of local relationships and the decomposition of language barriers.

Compared to the Chinese subsidiaries, the production sites in Vietnam and Brazil are less developed. Aalborg Industries acquired a production site in Vietnam to be the first to market. Aalborg Industries viewed the possibilities in Vietnam positively, and considered the subsidiary a strategic basis for production with very low costs. The company hopes that the marine market will evolve in Vietnam, giving the advantage of being present before its competitors. Similarly, facing quotas and high tariffs for importing goods, Aalborg Industries had to acquire a subsidiary in Brazil to provide service to the South American market. However, the Brazilian manufacturing facility is focused only on the industrial sector, because of unrealised rumours that the Brazilian ship market would develop in the last 20 years.

Fritz Hansen

Established in 1875, Fritz Hansen fits in the class of small and medium-sized enterprises (SMEs), and traditionally, the company's self-perception has been based on the fact that it is the producer behind some outstanding furniture classics. The company aims to become the preferred and successful brand within exclusive design furniture and to enhance the image of the company's customers, which are mostly businesses and public sector institutions in western Europe, Japan and the United States by supplying exclusive design furniture.

A number of years ago, Fritz Hansen fully mastered a broad line of production lines of tables and lounge, dining, meeting and stackable chairs in-house. However, at the beginning of the new millennium, the company, like many other export firms, experienced problems with efficiency in sales and marketing. An analysis clarifying the company's internal and external values suggested that it needed to build value for its brand, 'Fritz Hansen,' rather than products. In 2003, management developed a mission that stretched even further. The mission statement signalled that Fritz Hansen intended to shift from a product- and production-oriented mind set to a focus on sales and international branding; as a result, the roles of the sales, marketing, logistics

and development processes increased tremendously and emerged as new core processes, replacing the actual manufacturing competence. Then, along with the mental turnaround, Fritz Hansen started to outsource its production of tables and upholstery processes to suppliers, leaving product development, quality and prototype production, along with the fully automated production line of stacking chairs and some low-volume and 'difficult' products the only activities kept in-house. As a result, the large number of production lines and processes traditionally mastered in-house were reduced dramatically, decreasing the number of production lines managed in-house to approximately 36%. Outsourcing the table production line and upholstery processes changed and challenged the company's managerial focuses. Management related not only to the internal affairs of operations and logistics, but also to a higher degree, to interaction with the increasing number of external actors in different supply chains.

Specifically, the upholstery process outsourced to the supplier Trio Line was traditionally considered a core capability of Fritz Hansen, due to the company's strict quality demands. However, with the shifts in the corporate focus, internal control of these activities was seen as less significant to the company. Today, the supplier's (i.e. Trio Line) factory in Poland takes care of the process. The development of Trio Line's operations network will be introduced below.

Trio Line

Trio Line is a family-owned furniture company. Founded in Odense, Denmark, in 1984, Trio Line has transformed from a sofa producer into Scandinavia's biggest producer of high-quality design furniture. The firm cooperates with many of the great Danish furniture producers and functions as their supplier within upholstery. At the same time, Trio Line has its own collection of relax chairs which is mainly sold in Europe, Asia and North America. However, only 5–10% of the company's revenue comes from Trio Line's relax chair brand; the rest comes from being a supplier to the high-end industry.

Initially, the company mainly focused on producing chairs. Things started to change in 1999, however, when Trio Line became the sole

supplier for Fritz Hansen. In the following years, the company quickly grew, and in 2003, it offshored some of its production to Poland. This was done for three reasons. First, moving to Poland allowed the company to reduce the hourly cost per employee by 20 Euros. This meant that more time could be used per product, thereby increasing quality at the same time. Second, selecting Poland allowed the company to deliver the processed order to the customer within 16 hours. Third, a qualified labour force could be easily accessed in Poland, as the country has a long tradition and relatively large talent mass within upholstery. First, the Polish facility was a regular supplier for Trio Line, but with no capability to manage growth and quality levels. This led to the Polish facility being acquired by Trio Line. When Trio Line started production in Poland, training of local employees was treated as the first priority. Once the proper quality level was ensured, first, the products with the highest consumption of labour hours were transferred to Poland. Today, most production activities are in Poland. In addition, the Polish facility is responsible for handling the incremental innovation of already existing furniture, since this facility possesses the greatest knowledge about the products and processes used in daily operation. Accordingly, the Danish facility mainly focuses on (1) key accounting activities, which involve handling customer contact and negotiating prices and claims; (2) ramping up production and training Polish employees; and (3) production innovation with the brand owner, which cannot be offshored to Poland, as the Danish upholsterers know the Danish design traditions and have the tacit knowledge involved in developing new high-end furniture.

Along with the growth of Trio Line, its cooperation with Fritz Hansen has also been gradually reinforced. Initially, all materials were sent from Fritz Hansen to Trio Line, where the furniture was upholstered and assembled. As time passed, Trio Line was handed the responsibility of purchasing and invoicing material for some suppliers. This process continued and was finalised when Trio Line was able to send a finished product without interference from Fritz Hansen. Other customers began to see the advantages that could be gained from outsourcing activities to Trio Line. The customers benefited from the framework agreements that Trio Line had with its suppliers. By increasing the purchase

volume, Trio Line has been able to negotiate better material prices for its customers. The customers not only benefited from reductions in material costs, but also cost reductions due to decreased stock, which furthermore increased the customers' comfort and flexibility. By having a contribution margin on those activities, Trio Line was able to increase profitability, while ensuring a strong position in the chain as a value creator. More recently, the company has been involved in Fritz Hansen's innovation activities. Trio Line's knowledge of the materials and production processes is of great value to Fritz Hansen when developing new furniture. Furthermore, Trio Line has knowledge about the newest material through interactions with sub-suppliers. The company's involvement in innovation is a deliberate step in its strategy of making its customers more dependent.

EMPIRICAL FINDINGS

The empirical studies indeed confirm the roadmap for the manufacturing system evolution illustrated in Figure 1. Companies such as Aalborg Industries and Trio Line attempt to internationalise their geographically dispersed plants by coordinating them with a synergetic network whereas other companies (such as Fritz Hansen) try to downsize and outsource non-core manufacturing tasks and to organise interfirm collaborations. However, Figure 1 seems to be insufficient to cover/illustrate the entire picture of the ongoing phenomena.

Internationalisation

In the case studies of Aalborg Industries and Trio Line, sales/marketing and manufacturing are normally the first value chain activities internationalised in a bid for cost savings and/or market proximity. As shown in the Trio Line case, starting manufacturing in a new place is much more complicated than starting sales/marketing, and requires long-term preparations. Local employees need to be trained; their knowledge about how to operate machines needs to be developed. This start-up phase usually lasts until certain performance indicators are satisfied, which in the case Trio Line had to do with quality level. Even when allowed to take responsibility for mass production, the facility basically starts by producing simple products, but can be given more

responsibility for producing more products and performing more processes after accumulating corresponding experience. Along with the development of the overseas plants, the companies (Aalborg Industries and Trio Line) have gradually shifted their focus from the plant to the international manufacturing network.

As revealed by the Aalborg Industries case study, the internationalisation of production activities is not an end, but rather a starting point for internalising other value chain activities, such as global sourcing, global engineering and even increasingly dispersed R&D. After the manufacturing activities are internalised, more value chain activities are gradually redistributed from developed countries to developing ones. With globally distributed plants and other centres of service, sales, engineering and R&D, Aalborg Industries has to extensively look into its *global functional networks of multiple operations* and address individual manufacturing, sales, service, engineering and R&D functional networks simultaneously, as network configuration decisions that are based on traditional geographical advantages or the suboptimisation of the manufacturing network might no longer provide sufficient competitiveness.

At the same time, facilities in developed countries keep on shrinking and accordingly become more focused (e.g. on new product/process development), since many more value chain activities are moved out. However, some value chain activities are retained in developed countries for two main reasons, that is, location-related considerations and site competence. On the one hand, in Aalborg Industries, some customers do not want to see components from China or India in their products because of their political standpoints. These customers are willing to pay high prices if the products are produced in Denmark. On the other hand, in Trio Line, product innovation cannot be moved from Denmark to Poland, mainly because Danish design traditions and tacit knowledge about developing new high-end furniture are difficult to transfer to the Polish site.

Externalisation

Manufacturing was also the first value chain activity outsourced from

Fritz Hansen and redistributed to Trio Line. Fritz Hansen's primary intention was to achieve a reduction in the cost structure, to be able to handle large growth and to enhance capacity flexibility driven by market pull instead of production push. Accordingly, the actual manufacturing competence was no longer viewed as the company's core competence and was thereby outsourced to selected partners (such as Trio Line). Outsourcing the table production line and upholstery processes changed and challenged the company's managerial focuses. Management related not only to the internal affairs of operation and logistics, but also, to a higher degree, to interaction with the increasing number of external actors in different supply chains. In other words, Fritz Hansen gradually shifted its focus from plant management to supply network management.

From the very beginning, Fritz Hansen aimed to build up strategic partnership with Trio Line, but seemed to not totally trust Trio Line. Materials were sent from Fritz Hansen, and final products needed to be returned to Fritz Hansen for final quality control and distribution. Taking care of only upholstering and assembling, Trio Line at that time was a typical OEM. After manufacturing, procurement was also outsourced to Trio Line for similar reasons to those indicated in the previous section. While increasing the purchase volume and variety, Trio Line tended to have framework agreements with its material suppliers, which further made it possible for Trio Line to negotiate better material prices for its customers. Better prices, in turn, attracted more customers and encouraged them to outsource more production. In other words, Trio Line was more like a 'global procurement function' to its customers. Afterwards, on pace with the company's growth, Trio Line had increased capabilities to handle more complicated tasks, such as product/process improvement. This process continued until Trio Line was able to send a finished product without interference from its customers, such as Fritz Hansen. Thus, for reasons similar to those reasons indicated— specifically that Trio Line's knowledge of the materials and production processes is of great value to Fritz Hansen when developing new furniture – Fritz Hansen recently involved Trio Line in the company's innovation activities. Thus, Fritz Hansen can enjoy fast and frequent new product introduction, and Trio Line can make

its customers more dependent on the company. Evolving in this way, Trio Line has the potential to grow up to be an original design manufacturer (ODM).

In summary, the specialisation and collaboration trends between Fritz Hansen and Trio Line are not limited only to manufacturing tasks, but also extend to other non-core value chain activities such as procurement, product/process improvement and innovation activities. In other words, the concept needs to be broadened to include the general integration of all functions and business processes throughout the total value chain, including marketing, manufacturing, distribution, R&D, etc. (Cooper, Lambert, & Pagh, 1997). This new development goes beyond the traditional make-or-buy decision and creates another type of network, which tends to concern new value proposition and new strategic collaboration in the *supply, or more clearly, value network*.

DISCUSSIONS

The above empirical findings seem to suggest that our discussions on internationalisation and externalisation need to be extended from manufacturing activity to other value chain activities. Moreover, two development trajectories can actually be identified, that is, the internationalisation of value chain activities (taking Aalborg Industries as an example) and the externalisation of value chain activities (taking Fritz Hansen as an example). The two trajectories are actually similar to each other. In both development trajectories, manufacturing (or sales) is normally the first value chain activity to be redistributed. This is because, internally, manufacturing is normally viewed as a lower value-added and less knowledge-intensive activity, but at the same time comprises a large part of the investment and cost; externally, emerging developing countries provide good locations for companies to offshore/outsource their manufacturing activities in order to reduce their cost. Moreover, the redistribution of manufacturing further triggers the transfers of other related value-chain activities (e.g. procurement, product/process improvement and R&D/new product development, as shown in the three case companies), which thereby creates a snowball effect.

The fundamental difference between these two development trajectories is whether the redistributions of relevant value chain activities go beyond the company's boundaries. For example, Aalborg Industries redistributed its manufacturing and other value-chain activities globally, but mainly to sites that were still under the company's control. In contrast, Fritz Hansen gradually released its manufacturing, procurement, engineering and even R&D to Trio Line, making the company accordingly focus on innovation and brand management. It is certainly difficult to judge which development trajectory is better, since the selection is always case specific and might be influenced by many factors, including product characteristics, market characteristics, firm or business unit characteristics and strategies. In addition, selecting a specific development trajectory can only initiate and indicate the directions for redistributing value chain activities. During the development, it is still necessary to trace different factors for internationalisation and externalisation in order to monitor the developments and further provide relevant inputs for future decisions. For internationalisation, relevant factors, as suggested by the study of Aalborg Industries, seem to be site competencies, location conditions and flows of products, processes and knowledge between sites. For externalisation, relevant factors – as suggested by the study of Fritz Hansen and Trio Line – might involve supplier development and a mutual relationship with the supplier.

Last but not least, it should also be noticed that the case companies actually tried to internationalise and externalise their value-chain activities at the same time. Aalborg Industries intended to view its core competency as controlling the entire process in the company's global setup in order to understand and fulfil customers' needs. This, however, does not mean that the company refuses to collaborate with suppliers. Instead, Aalborg Industries, for instance, produced only 20% of an entire boiler application, and sourced the rest of the component production to suppliers. Meanwhile, Fritz Hansen outsourced all of its production to Trio Line and gradually treated Trio Line as a strategic partner. Therefore, to some extent, these two companies can be viewed as an extended company, which has also started to internationalise production activity, as Trio Line offshored most of the production operations from Denmark to Poland.

CONCLUSIONS AND FUTURE RESEARCH

Since the late 1980s, manufacturing systems have gradually evolved from factory/plant-based systems toward globally collaborative inter-firm networks. Derived with the characteristics of internalisation and externalisation of manufacturing activities, a matrix (Figure 1) was proposed by Shi (2004) to illustrate a roadmap of the evolution of manufacturing systems. Taking this matrix as a starting point, this chapter first investigated the existing literature on factory/plants, international manufacturing networks, supply networks and GMVNs to examine what has been done on the two indicated development trajectories, that is, the internationalisation and externalisation of manufacturing. Claiming that conceptual insights address only one of the two worlds (i.e. research and practice) of OM, this chapter successively explored what is actually happening in practice in order to address potential queries related to the implications of the manufacturing evolution for the practitioner, whether the existing theories are sufficient to describe and explain what is happening in practice and the ongoing and/or further developmental trends of manufacturing systems (networks). Aalborg Industries, Fritz Hansen and Trio Line were selected from the GONE project for in-depth analyses in order to fundamentally understand the internationalisation and externalisation of manufacturing.

The empirical findings derived from the three case studies suggested that the discussions on internationalisation and externalisation need to be extended from manufacturing activity to other value-chain activities at the same time. The proposed matrix (Figure 1) has to be modified accordingly: (1) For the internationalisation dimension, discussions cannot be limited to the international manufacturing network, but need to be extended to global operations or a multifunctional network; and (2) for the externalisation dimension, discussions also need to be extended from the supply chain or network to the collaborative value network. Two developmental trajectories, that is, the internationalisation and the externalisation of value-chain activities, were accordingly proposed. Their similarities and differences were further compared and discussed. Finally, this chapter indicated that the case companies actually tended to combine the two developmental trajectories at the same time, and suggested that managers must make a

tradeoff between internationalisation and externalisation, and keep a relative balance in order to face and manage the global collaborative value network.

The findings of this chapter indeed suggest that the existing literature has become less sufficient to describe and explain the ongoing empirical phenomena, since companies internationalise/externalise not only manufacturing activities, but also other value-chain activities. Several theoretical gaps therefore need to be addressed and bridged.

First, it is not difficult to find studies addressing various global functional networks and covering the globalisation/internationalisation of relevant value-chain activities, for example, those of Zuo and Cavusgil (2002) on global marketing, Zhang (2007) on global engineering and Kotabe (1998) on global sourcing. However, the existing research remains fragmented and unintegrated and exclusively focuses on the networks of specific facilities (i.e. R&D centres, engineering centres) and discusses them independently. Except for a very small number of studies, for example Wang (2009), there is limited research on global OM that offers a comprehensive and integrated framework for managing multifunctional networks of geographically dispersed operations. The interactions among different kinds of networks are generally ignored.

Second, research on the supply chain/network tends to neglect the dynamics of the intramanufacturing network and tends to treat the international manufacturing network as something of a 'black box'. Without integrating the knowledge from OM, the supply chain management curriculum usually adopts a different perspective from those on international manufacturing network and mainly focuses on inventory management, distribution and information flows. Again, few studies try to integrate the knowledge of intra- and inter-networks and analyse them in a holistic way.

Finally, this paper was mainly proposed to investigate the ongoing empirical phenomena of the operations network. Our focus was therefore on the relevant theories, empirical situations and how to adjust the former to reflect the latter. In contrast, other managerial problems

(such as how to manage the internationalisation and externalisation of value-chain activities, how to make tradeoffs between internationalisation and externalisation and which developmental trajectory should be followed) are relatively neglected in this paper. They can be taken up as a direction for future research.

REFERENCES

- Andersen, P.H., & Christensen, P.R. (2005). Bridges over troubled water: Suppliers as connective nodes in global supply networks. *Journal of Business Research*, 58(9), 1261–1273.
- Bartlett, C.A., & Ghoshal, S. (1989). *Managing across borders: The transnational solution*. Boston, MA: Harvard Business School Press.
- Bhatnagar, R., Chandra, P., & Goyal, S.K. (1993). Models for multi-plant coordination. *European Journal of Operational Research*, 67, 141–160.
- Bolisani, E., & Scarso, E. (1996). International manufacturing strategies: Experiences from the clothing industry. *International Journal of Operations and Production Management*, 16(11), 71–84.
- Bovel, D., & Martha, J. (2000). From supply chain to value net. *Journal of Business Strategy*, 21(3), 25–36.
- Camuffo, A., Furlan, A., Romano, P., & Vinelli, A. (2007). Routes towards supplier and production network internationalisation. *International Journal of Operations and Production Management*, 27(4), 371–387.
- Canel, C., & Khumawala, B.M. (1996). A mixed integer programming approach for the international facilities location problem. *International Journal of Operations and Production Management*, 16(4), 49–68.
- Cooper, M.C., Lambert, D.M., & Pagh, J.D. (1997). Supply chain management: More than a new name for logistics. *International Journal of Logistics Management*, 8(1), 1–13.
- Das, T.K., Gosavi, A., Okogbaa, O.G., & Pontrandolfo, P. (1998). The reinforcement learning approach for integrating production and distribution in multi-plant networks. In L. McGinnis & S. Reveliotis (Eds.), *Proceedings of the Industrial Engineering Research Conference*, May 9–10, Banff, Canada.

- De Meyer, A., & Vereecke, A. (1996). International operations. In M. Werner (Ed.), *International Encyclopedia of Business and Management*. London: Routledge.
- Dubois, F.L., Toyne, B., & Oliff, M.D. (1993). International manufacturing strategies of US multinationals: A conceptual framework based on a four-industry study. *Journal of International Business Studies*, 24(2), 307–333.
- Fawcett, S.E., Birou, L.M., & Taylor, B.C., (1993). Supporting global operations through logistics and purchasing. *International Journal of Physical Distribution and Logistics Management*, 23(4), 3–11.
- Ferdows, K. (1989). Mapping international factory networks. In K. Ferdows (Ed.), *Managing International Manufacturing* (pp. 3–21). Amsterdam: Elsevier Science Publishers.
- Ferdows, K. (1997a). Made in the world: The global spread of production. *Production and Operations Management*, 6(2), 102–109.
- Ferdows, K. (1997b, March–April). Making the most of foreign factories. *Harvard Business Review*, 73–88.
- Ferdows, K. (2006). Transfer of changing production know-how. *Production and Operations Management*, 15(1), 1–9.
- Ferdows, K. (2009). Shaping global operations. *Georgetown University Journal of Globalization, Competitiveness and Governability*, 3(1), 136–148.
- Fisher, M. (1997). What is the right supply chain for your product? *Harvard Business Review*, 75(2), 105–16.
- Flaherty, M.T. (1986). Coordinating international manufacturing and technology. In M.C. Porter (Ed.), *Competition in global industries* (pp. 83–109). Boston: Harvard Business School Press.

- Flaherty, M.T. (1996). *Global operations management*. New York: McGraw Hill.
- Fusco, J.P., & Spring, M. (2003). Flexibility versus robust networks: The case of the Brazilian automotive sector. *Integrated Manufacturing Systems*, 14(1), 26–35.
- Gailbraith, C.S. (1990). Transferring core manufacturing technologies in high-technology firms. *California Management Review*, 32(4), 56–70.
- Ghoshal, S., & Bartlett, C.A. (1990). The multinational corporation as an interorganizational network. *The Academy of Management Review*, 15(4), 603–625.
- Ghoshal, S., & Nohria, N. (1993). Horses for courses: Organizational forms for multinational corporations. *Sloan Management Review*, 34(2), 23–35.
- Handfield, R.B., & Melnyk, S.A. (1998). The scientific theory-building process: A primer using the case of TQM. *Journal of Operations Management*, 16(4), 321–339.
- Harland, C.M., Lamming, R.C. and Cousins, P.D. (1999). “Developing the concept of supply strategy”. *International Journal of Operations & Production Management*, 19(7), pp. 650–673.
- Hayes, R.H. (2000). Toward a “new Architecture” for POM. *Production and Operations Management*, 9(2), 105–110.
- Hayes, R., Pisano, G., Upton, D., & Wheelwright, S. (2005). *Operations, strategy, and technology—Pursuing the competitive edge*. Hoboken, NJ: Wiley.
- Katayama, H. (1999). Design of a global car production-logistics system for a future ASEAN-China region. *International Journal of Operations and Production Management*, 19(5/6), 582–601.

- Kogut, B. (1990). International sequential advantages and network flexibility. In C.A. Bartlett, Y. Doz, & G. Hedlund (Eds.), *Managing the global firm* (pp. 47–68). London: Routledge.
- Kotabe, M. (1998). Efficiency vs. effectiveness orientation of global sourcing strategy: A comparison of U.S. and Japanese multinational companies. *Academy of Management Executive*, 12(4), 107–119.
- Lambert, M.D., Cooper, M.C., & Pagh, J.D. (1998). Supply chain management: Implementation issues and research opportunities. *International Journal of Logistics Management*, 9(2), 1–19.
- Lambert, M.D., & Cooper, M.C. (2000). Issues in supply chain management. *Industry Marketing Management*, 29, 65–83.
- Lamming, R., Johnsen, T., Zheng, J., & Harland, C. (2000). An initial classification of supply networks. *International Journal of Operations and Production Management*, 20(6), 675–691.
- MacCarthy, B.L., & Atthirawong, W. (2003). Factors affecting location decisions in international operations—A Delphi study. *International Journal of Operations and Production Management*, 23(7), 794–818.
- Maritan, C.A., Brush, T.H., & Karnani, A.G. (2004). Plant roles and decision autonomy in multinational plant networks. *Journal of Operations Management*, 22, 489–503.
- Meijboom, B., & Vos, B. (1997). International manufacturing and location decisions: Balancing configuration and coordination aspects. *International Journal of Operations and Production Management*, 17(7), 790–805.
- Meijboom, B., & Voordijk, H. (2003). International operations and location decisions: A firm level approach. *Tijdschrift voor Economische en Sociale Geografie*, 94(4), 463–476.

- Meijboom, B., & Vos, B. (2004). Site competence dynamics in international manufacturing networks: Instrument development and a test in Eastern European factories. *Journal of Purchasing and Supply Management*, 10, 127–136.
- Normann, R. & Ramirez, R. (1993). From value chain to value constellation: Designing interactive strategy. *Harvard Business Review*, 71(4), 65–78.
- Parolini, C. (1999). *The value net: A tool for competitive strategy*. John Wiley Books.
- Porter, M.E. (Ed.) (1986). *Competition in global industries*. Boston: Harvard Business School Press.
- Roth, K., & Morrison, A.J. (1992). Implementing global strategy: Characteristics of global subsidiary mandates. *Journal of International Business Studies*, 23(4), 715–735.
- Rudberg, M., & Olhager, J. (2003). Manufacturing networks and supply chains: An operations strategy perspective. *Omega: International Journal of Management Science*, 31, 29–39.
- Rudberg, M., & West, B.M. (2008). Global operations strategy: Coordinating manufacturing networks. *Omega: The International Journal of Management Science*, 36, 91–106.
- Schmenner, R.W. (1979, January–February). Look beyond the obvious in plant location. *Harvard Business Review*, 126–132.
- Schmenner R.W. (1982). Multi-plant manufacturing strategies among the Fortune 500. *Journal of Operations Management*, 2(2), 77–86.
- Shi, Y. (2004). A roadmap of manufacturing system evolution—From product competitive advantage towards collaborative value creation. In Y. Chang, H. Makatsoris, & H. Richards (Eds.), *Evolution of supply chain management—Symbiosis of adaptive value networks and ICT* (pp. 341–365). Academic Publisher, USA.

- Shi Y., & Gregory, M. (1998). International manufacturing networks—To develop global competitive capabilities. *Journal of Operations Management*, 16(2), 195–214.
- Shi, Y., & Gregory, M. (2005). Emergence of global manufacturing virtual networks and establishment of new manufacturing infrastructure for faster innovation and firm growth. *Production Planning and Control*, 16(6), 621–631.
- Shi, Y., & Gregory, M.J. (1995). International manufacturing configurations: Contingency maps for manufacturing internationalization. In D. Draaijer et al. (Eds.), *Management and new production systems*. , University of Twente, Twente, The Netherlands.
- Slack, N., Lewis, M., & Bates, H. (2004). The two worlds of operations management research and practice: Can they meet, should they meet? *International Journal of Operations and Production Management*, 24(3/4), 372.
- Swamidass, P.M. (1991). Empirical science: New frontier in operations management research. *The Academy of Management Review*, 16(4), 793–814.
- Taggart, J.H. (1998). Strategy shifts in MNC subsidiaries. *Strategic Management Journal*, 19, 663–681.
- Vereecke, A., & Van Dierdonck, R. (1999). *Design and management of international plant networks*. Research report. Gent, Belgium: Academia Press.
- Vereecke, A., & Van Dierdonck, R. (2002). The strategic role of the plant: Testing Ferdows's model. *International Journal of Operations and Production Management*, 22(5), 492–514.
- Vereecke, A., Van Dierdonck, R., & De Meyer, A. (2006). A typology of plants in global manufacturing networks. *Management Science*, 52(11), 1737–1750.

- Vos, G. (1991). Production-allocation approach for international manufacturing strategy. *International Journal of Operations and Production Management*, 11(3), 125–134.
- Voss, C., Tsikiktsis, N., & Frohlich, M. (2002). Case research in operations management. *International Journal of Operations and Production Management*, 22(2), 195–219.
- Wang, D. (2009). *Global Operations Network—An integration of functional networks*. Unpublished doctoral dissertation, University of Cambridge, UK.
- Wilson, J.M. (1995). An historical perspective on operations management. *Production and Inventory Management Journal*, 36(3), 61–66.
- Yin, K.R. (2003). *Case study research*. London: Sage Publications.
- Yip, G.S. (1989). Global strategy in a world of nations? *Sloan Management Review*, 31(1), 29–41.
- Zhang, Y. (2007). *An integrating framework of global engineering networks (GEN): The context, capability and configuration*. Unpublished doctoral dissertation, Engineering Department, University of Cambridge, UK.
- Zou, S., & Cavusgil, S.T. (2002). The GMS: A broad conceptualization of global marketing strategy and its effect on firm performance. *Journal of Marketing*, 66, 40–56.

CHAPTER 4

Managing Hidden Costs of Offshoring: Learning to Achieve System Integration

Marcus M. Larsen, *Copenhagen Business School, Denmark*

Torben Pedersen, *Copenhagen Business School, Denmark*

ABSTRACT

This chapter investigates the concept of the 'hidden costs' of offshoring, i.e. unexpected offshoring costs exceeding the initially expected costs. Due to the highly undefined nature of these costs, we position our analysis towards the strategic responses of firms' realisation of hidden costs. In this regard, we argue that a major response to the hidden costs of offshoring is the identification and utilisation of strategic mechanisms in the organisational design to eventually achieving system integration in a globally dispersed and disaggregated organisation. This is heavily moderated by a learning-by-doing process, where hidden costs motivate firms and their employees to search for new and better knowledge on how to successfully manage the organisation. We illustrate this thesis based on the case of the LEGO Group.

Keywords: Offshoring, hidden costs, system integration, organisational learning, case study

INTRODUCTION

How do firms respond to situations in which unforeseen costs of offshoring are undermining anticipated benefits? Dell Inc., for instance, the multinational IT corporation, decided in 2003 after many problems

and challenges regarding cultural differences, language difficulties and time delays, to eventually close and source back the Indian service centres that it had offshored and outsourced some years earlier (Frauenheim, 2003; Graf & Mudambi, 2005). Indeed, Aron and Singh (2005) argue that many firms are caught up by the 'harsh realities of offshoring' (p. 135), as they fail to pick up the right processes, calculate the operational and structural risks and match organisational forms to live up to the initial expectations of the offshoring activities.

The surge of offshoring as a business practice is increasingly documented and investigated in the literature. Reporting the findings of a comprehensive, international research project on offshoring, the Offshoring Research Network (ORN), Lewin and Peeters (2006) argue that offshoring as a business practice on a more general level is still at an early stage but is growing rapidly. In particular, they assert that as a result of its growing significance, offshoring will fundamentally change the way in which companies compete globally. It has accordingly been suggested that the acceleration of offshoring might challenge conventional international business and strategic management theory (Doh, 2005). Although the benefits of offshoring are clear from both a theoretical and an empirical viewpoint – relating to cost reduction, market proximity and access to strategic resources, among other things (Lewin & Peeters, 2006; Mol, van Tulder, & Beije, 2005) – there are at the same time indications that these benefits are often undermined by costs that seem difficult to identify and calculate *ex ante*. This has led some scholars to begin inquiring about the idea of 'the hidden costs of offshoring', which can be defined as unexpected and difficult to measure costs of relocating and offshoring business activities abroad, and can include costs related to control, coordination, knowledge transfer and design/specification (Dibbern, Winkler, & Heinzl, 2008; Larsen, Manning, & Pedersen, 2012; Stringfellow, Teagarden, & Nie, 2008). The locus of the academic inquiry in this field has consequently been to understand the very nature of these costs. More specifically, research has attempted to understand both the antecedents and the characteristics of these hidden costs (Dibbern et al., 2008; Larsen et al., 2012; Stringfellow et al., 2008).

In this chapter, we employ a different perspective on the hidden costs

of offshoring. Rather than aligning our unit of analysis with the unforeseen nature of hidden costs, we are interested in the effect of these costs. Specifically, we argue that the 'hidden costs' of offshoring are by definition difficult to identify and measure until they are revealed for firms as realised costs of offshoring that exceed the initially expected costs. The knowledge interest of this chapter is accordingly to understand how firms respond to situations in which these unforeseen costs undermine the expected benefits of offshoring.

We suggest that firms' major response to the hidden costs of offshoring is to identify and utilise strategic mechanisms that can successfully facilitate a sophisticated systems integration of a globally dispersed and disaggregated organisation. At the same time, while systems integration may eventually overcome the hidden costs of offshoring, the process whereby firms realise the need and mechanisms to integrate the globally dispersed and disaggregated organisation can best be described as a learning-by-doing process in which it makes qualitative sense to distinguish between failure and success experiences. The ex post realisation of hidden costs of offshoring provides the company the necessary motivation for challenging existing knowledge and to search for superior alternatives. This initiates a process of reorganisation of which system integration becomes the ultimate goal.

These suggestions are illustrated through the case of the Danish-based LEGO Group, the world's fifth-largest toy manufacturer. We investigate the aftermaths of an internal financial crisis that drove the company to offshore and outsource larger parts of its production to third-party providers. During this process, the company found that the new organisational setup presented more challenges than benefits, and eventually decided to insource production once again.

This chapter is organised in three broad sections. First, we present its theoretical development by emphasising the concept of the hidden costs of offshoring and how firms respond to these. Second, we introduce the case of LEGO Group to illustrate our theory. Third, we discuss the case in the light of our theoretical background, and relate this to a broader debate on the role of the organisation in offshoring.

THEORETICAL DEVELOPMENT

The hidden costs of offshoring

Offshoring describes firms' process of sourcing internal or external business activities from abroad (Contractor, Kumar, Kundu, & Pedersen, 2010; Lewin & Peeters, 2006; Manning, Massini, & Lewin, 2008). Although labour-intensive activities such as manufacturing and processing were originally the main targets for offshoring, companies have increasingly begun to source higher-value activities such as research and development (R&D) from abroad. Lewin, Massini and Peeters (2009), for instance, studied the determinants of the small but growing tendency of firms to offshore innovation activities, arguing that this can be explained by an emerging domestic shortage of highly skilled employees, in which firms access qualified personnel around the world through offshoring innovation. Offshoring as a business practice is thus no longer only confined to restricted lower-value, labour-intensive and peripheral firm activities such as scale production and call-centre activities, but essentially encompasses the reallocation of firm tasks and activities from the entire value chain (Doh, 2005). The scope of this chapter is accordingly confined to the global reallocation of activities within an orchestrated value-generating system, regardless of the chosen ownership model.

As offshoring has been growing in scale and scope, business managers and scholars alike have begun to realise that the practice of sourcing activities from abroad might present firms with unexpected costs. For instance, practitioner-oriented literature has been aware of the potential dangers and pitfalls of offshoring in the sense that the decision might become more expensive than originally anticipated, and thus eventually challenge the very rationale of the practice by pointing to the costs of selecting a vendor, culture, ramping up, etc. (e.g. Barthélemy, 2001; Overby, 2003). This literature has stressed that offshoring might include certain 'hidden costs' that will eventually have negative financial consequences, and thus undermine the initial expectations of the decision to offshore. Likewise, the literature on international outsourcing has pointed to hidden costs of losing ownership of business tasks and activities, emphasising the potential erosion of firms' capabilities and resources, in contrast to retaining the activities and

processes in-house (Fisher & White, 2000; Hendry, 1995; Reitzig & Wagner, 2010).

As this chapter conceptualises offshoring as the relocation of business activities abroad, regardless of chosen ownership model, we argue that hidden costs should be understood from a generic value chain perspective (Porter, 1986). Accordingly, hidden costs occur when firms incur unexpected costs in relocating certain business tasks and processes within an orchestrated value-generating system abroad (Aron & Singh, 2005; Dibbern et al., 2008; Herath & Kishore, 2009; Stringfellow et al., 2008). Obviously, these costs can stem from different sources and take different shapes. What is important, however, is that firms encounter more costs than originally anticipated.

One noticeable perspective on the hidden costs of offshoring is presented by Stringfellow et al. (2008). In their conceptual work, the authors set out to identify the antecedents or underlying drivers generating hidden costs of offshoring. The authors argue that these relate, on the one side, to the content and the process of the particular activity being offshored, labelled as the interaction intensity. On the other side, they claim that the costs are associated with the offshore location, specifically with inherent differences in geography, language and culture. These drivers are aggregately labelled as interaction distance. Another important contribution to our understanding of hidden costs is Dibbern et al.'s (2008) systemic classification of the costs themselves. The authors posit that hidden costs of offshoring occur during three different stages of the offshoring process: the pre-contractual phase, the onshore transition phase and the onshore-offshore delivery phase. As the authors narrow their research to focus on costs occurring after the decision to offshore has been made, they highlight four particular costs deriving from the firm's internal environment: requirement specifications and design costs (the costs of accurately specifying and designing the business tasks to be offshored); knowledge transfer costs (the costs of transferring and communicating knowledge between the client and the vendor); coordination costs (the costs of coordinating and integrating the vendor and the client's resources to achieve the specified objectives); and control costs (the costs of controlling the

performance and coherency of the offshored activity). In sum, these contributions illuminate our understanding to what causes hidden costs – their antecedents – as well as the nature and characteristics of hidden costs.

It is in this regard important to emphasise that although many authors treat firms' primary objectives of offshoring as the reduction of production costs through the sourcing of business tasks and objectives from low-wage countries such as China and India (Dossani & Kenney, 2003), offshoring might also be driven by knowledge, technology and market seeking objectives (Lewin & Peeters, 2006). Furthermore, it may incorporate tactical, strategic and transformational goals (Kedia & Lahiri, 2007). This makes the assessment of what might drive the hidden costs of offshoring and their nature more complex. In addition, previous research suggests that firms' objectives in offshoring change over time with experience (Jensen & Pedersen, 2011; Maskell, Pedersen, Petersen, & Dick-Nielsen, 2007). For instance, it can easily be assumed that different objectives of offshoring will influence different levels of the client-vendor relationship. While interaction intensity and distance might explain how certain costs emerge in, for instance, cost-reducing offshoring strategies, these variables might become less relevant if the objective of the offshoring is to increase innovativeness or to attract highly skilled personnel, as the firm would normally expect more costs to emerge. In other words, as the drivers and the characteristics of hidden costs can vary significantly from situation to situation and might also change, we propose that understanding the hidden costs of offshoring translates into an inquiry to determine whether firms' realised costs by offshoring have exceeded the expected costs or not. Moreover, in order to advance our understanding of the nature of these hidden costs, we argue that it is important to understand what the ex post consequences of these hidden costs are (see Figure 1), as it is at this point in the assessment that their hidden nature becomes revealed. More particularly, in order to operationalise the nature of hidden costs, it becomes interesting to investigate how firms respond to situations in which their realised costs exceed the initially expected costs.

Figure 1. Conceptual understanding

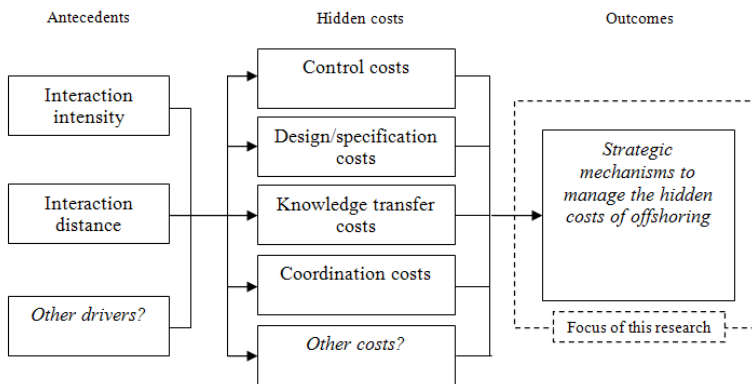

Responding to hidden costs: Achieving system integration

Firms respond to the hidden costs of offshoring in an array of different ways. For instance, firms might allocate extra resources to managing offshoring activities; they might continue as if nothing has happened; or they might decide to insource their activities again. In order to understand how firms respond to hidden costs, however, we follow a tradition of seeing firms as entities of interconnected tasks and activities that systematically contribute in fulfilling the objectives of an organisation (Grandori, 2001; Lawrence & Lorsch, 1967; Perrow, 1967; Porter, 1986; Thompson, 1967). Offshoring can therefore be conceived as an initial organisational redesign through the reallocation of firms' tasks and activities abroad, either internally in the company hierarchy (captive offshoring) or to an external partner (offshore outsourcing) (Contractoret al., 2010; Tanriverdi, Konana, & Ge, 2007; UNCTAD, 2004). In this respect, organisational decisions must be made regarding a number of issues, including the contractual ownership and relationship of the offshoring setup (Quinn & Hilmer, 1995), the geography of the host location (Graf & Mudambi, 2005), the level of disaggregation or 'fine slicing' of the overall value chain to identify the specific tasks to be offshored (Mudambi, 2008; Zenger & Hesterly, 1997), the interfaces and interdependences between the spatially differentiated organisational tasks and activities (Kumar, Van Fenema, & von Glinow, 2009;

Thompson, 1967; Ven & Delbecq, 1976) and the overall coherence and integration of the globally dispersed organisational system (Ernst & Kim, 2002).

Ultimately, as we are interested in offshoring from a value chain perspective (Porter, 1986), we propose that firms' response to the hidden costs of offshoring can be explained through the concept of systems integration (Brusoni, Prencipe, & Pavitt, 2001; Hobday, Davies, & Prencipe, 2005; Prencipe, Davies, & Hobday, 2003). According to Brusoni et al. (2001), system integrators are firms that 'lead and coordinate from a technological and organisational viewpoint the work of suppliers involved in the network' (p. 613). The authors argue that 'While markets satisfy the need for distinctiveness, and hierarchies the need for prompt responsiveness, system integration reconciles them for specific products and technologies' (2001, p. 614). Likewise, Hobday et al. (2005) characterise systems integrators as firms 'concerned with the way in which firms and other agents bring together high-technology components, subsystems, software, skills, knowledge, engineers, managers, and technicians to produce a product in competition with other suppliers. The more complex, high technology, and high costs the product, the more significant systems integration becomes to the productive activity of the firm' (p. 1110). This suggests that the system integrator finds the optimal governance and integration mechanisms for the organisational system based on internal and external factors such as complexity, component criticality and resources.

In essence, system integration becomes an important strategic mechanism in response to a growingly complex organisation (Simon, 1962). Thus, in an organisational system consisting of a number of offshored components and entities, the system integrators becomes the architect that integrates and coordinates the different capabilities and resources of the different actors into a final output. A fully systems integrated organisation would therefore understand the interactions and dynamics of the entire organisation, and would implement design mechanisms to address and avoid unexpected costs.

The moderating role of organisational learning

Having suggested how system integration is essential in managing the hidden costs of offshoring, and thus contributing to firms' successful offshoring experience, an obvious question becomes: How do firms achieve system integration? We assert that organisational learning (Argyris & Schön, 1978; Fiol & Lyles, 1985) plays an inevitable role – both conceptually and practically – in nurturing and sophisticating the system integration of a globally dispersed and disaggregated organisation.

Organisational learning is popularly defined as 'the development of insights, knowledge, and associations between past actions, the effectiveness of those actions, and future actions' (Fiol & Lyles, 1985, p. 811), and much literature elucidating the processes of offshoring has already employed an organisational learning perspective (e.g. Carmel & Agarwal, 2002; Dibbern et al., 2008; Jensen, 2009; Manning et al., 2008; Maskell et al., 2007). For instance, Maskell et al. (2007) suggest how offshoring to low-cost countries is best described as a learning-by-doing process in which, 'over a period of time the outsourcing experience lessens the cognitive limitations of decision-makers as to the advantages that can be achieved through outsourcing in low-cost countries: the insourcer/vendor may not only offer cost advantages, but also quality improvement and innovation' (Maskell et al., 2007, p. 239). Equally, based on evolving organisational learning in both home and host country firms, Jensen (2009) proposes that offshoring of advanced services should be understood as an antecedent for strategic business development and organisational change.

In contrast to these views, we suggest that from the perspective of hidden costs of offshoring, it makes qualitative sense to distinguish between 'learning by success' and 'learning by failure' (cf. Madsen & Desai, 2010). While organisational learning is the change in the organisation's knowledge derived from an aggregation of experiences (Fiol & Lyles, 1985), studies have shown that it makes theoretical and empirical sense to disaggregate between success experience and failure experience (Baum & Ingram, 1998; Haunschild & Sullivan, 2002; Madsen & Desai, 2010). Success experiences provides means for firms and their employees to confirm that existing organisational practices and

knowledge work and support the objectives of the firm – thus providing stability in the organisational knowledge. Experiences with failure, however, challenge existing wisdom and structures, and motivate firms to search for new and better knowledge. According to Madsen and Desai (2010), ‘experience with failure is more likely than experience success to produce two of the necessary conditions for experiential learning [...]: the motivation to alter knowledge, and ability to extract meaningful knowledge from experience’ (p. 454).

In sum, we propose that firms’ respond to hidden costs through incremental knowledge absorption from encounters with the hidden costs of offshoring. This determines the strategic response involving organisational change in the direction of organisational system integration. In other words, through their experience with failure, firms learn about themselves, their processes and structures, as well as learning more specifically how to offshore.

THE CASE: LEGO GROUP

In the following, we use the case of the LEGO Group to illustrate the theoretical propositions of this book chapter. The case of the LEGO Group (LEGO) has proven to be ideal when investigating the strategic responses to hidden costs of offshoring. The company is the fifth-largest toy manufacturer in the world, and is the producer of the twice-named ‘toy of the century’, the LEGO brick (Larsen, Pedersen, & Slepniov, 2010). It was founded in 1932 in Denmark as a small workshop for wooden toys, and has since grown into a large multinational company. The focus of this case study, however, is the period from the late 1990s to 2009, with particular emphasis on the latter five years. In 2004, the group entered the greatest financial crisis in its history, in which its net losses were skyrocketing and sales falling dramatically. This initiated a larger restructuring process in the company, where the ineffective and inflexible supply chain was particularly targeted. In this regard, LEGO decided to undertake a comprehensive offshoring journey: In 2004, it chose to relocate as much as 80% of its production to foreign suppliers. The company did have some captive offshored activities at the time, but the majority of the production was still conducted in Denmark

and the US Among the suppliers, particularly Flextronics, a large Asian original equipment manufacturer (OEM) was targeted. A merely four years later, offshoring was scaled up; however, LEGO decided to in-source production again while maintaining the international network of production (from offshore outsourcing to captive offshoring). The company increasingly realised that its outsourcing collaborations were too costly and challenging, and that new measures had to be taken.

The data for the case consist mainly of a set of semi-structured interviews with managers and key stakeholders from LEGO which were conducted by the authors of the present chapter. Moreover, other internal and external secondary sources like newspaper articles, managerial reports and company presentations were also used to achieve a comprehensive understanding of the case. We structure the case in three broad parts. As we are interested in the events sparked by the internal crisis, the first part describes the company immediately after the crisis, when it decided to outsource and offshore its production (i.e. pre-outsourcing). The next part describes LEGO during its outsourcing collaborations (i.e. outsourcing), and the last part deals with the firm after the decision to in-source its production again (insourcing).

Pre-offshore outsourcing (2004)

The major financial crisis in LEGO in 2003 and 2004, which drew the company close to bankruptcy, initiated a comprehensive assessment to identify problematic areas and solutions to these issues. The then newly appointed CEO, Jørgen Vig Knudstorp, indicated in 2004 that there would be a radical change in the company to bring it back on track:

“LEGO shall first and foremost drop its arrogance. We have been too sacred with our own virtues, not open enough, and not willing to listen to what other people say. We listen to customers and consumers, simply drop the sacredness. We must be aggressive in the market, work closely with retailers, and manage LEGO very tightly, also financially” (Larsen et al., 2010, p. 3).

Under the strategy labelled 'Shared Vision', LEGO initiated a broad restructuring process organised around three core principles:

- Be the best at creating value for customers and sales channels;
- Refocus on the customer value;
- Increase operational excellence.

While the first and the second principles were dominantly market oriented, the last signified a careful scrutiny of the firm's entire value chain; the inflexible and highly complex supply chain and production were particularly targeted as areas that required attention.

In 2004, the company owned and operated a network of production facilities in Denmark, the US, Switzerland, the Czech Republic and South Korea. The vast majority of the production was undertaken in Denmark and the US. The post-crisis assessment of the company, however, showed that the production network caused a number of inefficiencies. First of all, it proved to be inflexible, simply because much of the production knowledge was highly tacit. One LEGO manufacturing vice president elaborated as follows:

We have had the pleasure of being in Billund [in Denmark] for 40 years with many loyal employees. The downside to this, however, is that you become rather lazy on the documentation side as everybody knows exactly what to do, and they have done it for years so there is no need for it either.

As LEGO's international network of production facilities required communication across national borders, it became evident that the lack of explicit procedures and documentation complicated the organisational orchestration. For instance, at the time, LEGO sourced materials from roughly 11,000 suppliers, a number almost twice as large as what Boeing uses for its airplanes. The extreme complexity of maintaining such a network combined with poor and inadequate procedures hampered the creation of a sound and flexible business platform. Another

issue was the high alternative costs of dominantly carrying out the production in Denmark and the US. On the one side, management recognised that by allocating production to low-cost countries that were strategically in close proximity to key markets, labour and distribution costs could be cut considerably. On the other hand, with the production of roughly 24 billion bricks per year, the huge potential for economies of scale by targeting large subcontractors was identified. These insights led LEGO management to completely rethink its production network under the banner of achieving a 'total cost benefit'; large-scale outsourcing was the result of this. A LEGO vice president expressed this clearly:

We were basically turning the 50 year old idea that Denmark and Switzerland were good countries for automatic production upside down. The new mantra was aggressive outsourcing to low-cost countries.

Offshore outsourcing (2005–2008)

In 2005, LEGO identified a number of sub-suppliers that would carry out the bulk of the company's production. In total, LEGO management decided to relocate up to 80% of its production to external partners. The most prominent of these was Flextronics, a leading multinational electronics manufacturing services (EMS) provider based in Singapore that had much experience in servicing OEMs. Other sub-suppliers included Sonoco, Greiner, Weidenhammer and 2B Pack. However, the relative sizes of these collaborations were marginal compared to that with Flextronics.

In the period of 2004 to 2006, LEGO relocated the following activities to Flextronics: Some production facility capacity in Denmark and Switzerland was transferred to Flextronics' plants in Nyíregyháza and Sarvar, Hungary; the operating control of LEGO's Kladno site in the Czech Republic was given to Flextronics; and the LEGO Enfield plant in the US was shut down in favour of using Flextronics' newly opened facilities in Juarez, Mexico. Besides the obvious sourcing and economies of scale potentials, Flextronics had been a preferred sourcing partner due to its vast experience and expertise in transferring business ac-

tivities between different geographical units. A LEGO vice president explained:

It has been important for us to find the right partner, and Flextronics is a very professional player in the market with industry-leading plastics capabilities, the right capacity and resources in terms of molding, assembly, packaging and distribution. We know this from looking at the work Flextronics does for other global companies.

Above all, as the LEGO management targeted the 'total cost benefit' in the production, extensive assistance was required due to the high degree of tacit knowledge in LEGO's work processes. Indeed, the collaboration with Flextronics presented LEGO with a number of advantages besides the pure sourcing benefits. Particularly, from the collaboration, LEGO learned the act and value of documenting and standardising work processes. A LEGO manufacturing vice president pointed this out:

It [the collaboration with Flextronics] has had a major effect on how we think about things, what we are focusing on, and when it is important to take care of the process ourselves and when we can use the industry standards. There are issues concerning the implementation and documentation of standards, the documentation of what we are doing, that we have learned big-time from Flextronics. Documentation is not something we have had the tradition of being particularly good at. Our employees have been here [in Billund, Denmark] for 20 and 30 years at the time, so why do then you want spend time on these issues? But then it is really an advantage as a business being able to document things.

A senior LEGO production director explained how standardisation had been taken to new frontiers within the company:

We are standardizing on three levels: the upper level: that is our way of thinking, our mindset, values, attitudes; on the

mid-level: how we operate our planning processes, follow-up processes, etc.; and the lower level: that is more the hardware part, the machines, lines and the layout in the production.'

Moreover, in 2005, LEGO introduced a deliberate sales and operation planning (S&OP) process to monitor and coordinate the roles, capabilities and responsibilities of the different production facilities found around the world in relation to the supply situation. The S&OP became a central mechanism in ensuring flexibility through coordination and transparency between the different units in LEGO's fragmented and globally distributed network of production facilities. These measures were therefore taken to manage and overcome the extreme complexity of LEGO's production network.

At the same time as LEGO saw the learning potential in collaborating with Flextronics, unexpected challenges began to appear. The LEGO management increasingly found that it was not achieving the operational flexibility it had sought through large-scale outsourcing. Due to the relatively high pace of the transition from in-house production to outsourced production, a reliable and coherent transfer of production knowledge proved problematic to ensure. For instance, there was the challenge of successfully aligning the seasonal fluctuations of the LEGO production with Flextronics' business model emphasising stable and predictable operations to ensure economies of scale. The three parameters that characterised LEGO's production (i.e. about 60% of the LEGO production was carried out in the second half of the year; the average lifespan of the products was 16–18 months and demand uncertainty fluctuated with plus/minus 30%), however, rather signified a need for flexible and highly market responsive business solutions.

Eventually, in 2008, LEGO management announced that the collaboration with Flextronics would be phased out. In an official press release, the executive vice president for the global supply chain, Iqbal Padda, stated the following:

"We have had an intensive and very valuable cooperation with Flextronics on the relocation of major parts of our pro-

duction. As expected this transition has been complicated, but throughout the process we have maintained our high quality level. Jointly we have now come to the conclusion that it is more optimal for the LEGO Group to manage the global manufacturing set up ourselves. With this decision the LEGO supply chain will be developed faster through going for the best, leanest and highest quality solution at all times” (Larsen et al., 2010, p. 1).

Given the challenges that LEGO encountered through the offshoring collaborations, the long-term contracts with Flextronics were cancelled after merely three years.

Insourcing/captive offshoring (2008)

The decision to phase out the collaboration with Flextronics initiated a process of insourcing the extensive network of production facilities. First, LEGO gained ownership and control of the Kladno facilities in the Czech Republic in February 2008. In July of the same year, the factories in Sarvar and Nyíregyháza, Hungary, followed suit. Eventually, at the beginning of 2009, the production in Juárez, Mexico, was closed in favour of using a brand new, fully LEGO-owned and operated production facility in Monterrey, Mexico. The factories in Billund, Denmark, were maintained with roughly 1,100 employees. Thus, although some of the minor outsourcing collaborations were still kept after phasing out Flextronics – such as Greiner and Sonoco, primarily delivering packaging solutions – the major implications of the recent developments indicated that LEGO’s production network went from being dominantly offshore outsourced to become a largely captive offshored network. A considerable expansion of LEGO’s global footprint was therefore one of the results.

What remained remarkable after phasing out Flextronics, however, was how the so-called ‘failed’ sourcing collaboration had fundamentally altered the way in which the LEGO Group perceived its own organisation and carried out its operations. For instance, as already mentioned, this was linked to how it could standardise and document work processes. Having experienced the level of complexity and challenges

arising from dispersing the production network on an international scale, a LEGO supply chain manager rationalised that 'production in another country – even within the same company – requires ten times more documentation than in the company it is moved from'. In a similar vein, the LEGO Group had learned the value of transparency in its processes. A LEGO vice president explained:

We have reached a point where we went from a situation where we had a highly poor day-to-day transparency for our processes and where we were according to our plans, to possessing today a very high degree of transparency and control over our processes. And control is not, in my head, the same thing as never running into problems, but rather knowing when we have problems, where we are, and where to focus. Transparency is therefore just as important as having control.

Moreover, the vice president elaborated:

I won't say that we had problems in with the quality. I think it was rather the question of integration. It was the whole planning phase that we simply could not implement, and we were not ready for it either. Although some issues of understanding our level, they [Flextronics] were fully able deliver the quality we asked for.

Through its collaboration with Flextronics, LEGO also successfully reduced the total number of component portfolios from approximately 12,000 in 2004 to roughly half that number in 2008. This meant that it was to a much larger extend using the same components in different products, and as a result, a more flexible and less burdened supply chain was allowed for.

In sum, through its interactions and encounters with Flextronics, LEGO had incrementally gained knowledge concerning how to optimise its own processes and organisation in order to manage the challenges of having an international network of production facilities. Specifically, it

learned the importance of controlling and being fully acquainted with how the system works, or put differently, it had learned the potential pitfalls of not being fully acquainted with its own system. LEGO therefore incrementally learned more about itself and its own processes and structures by engaging Flextronics in its production.

DISCUSSION AND CONCLUSION

The intention of this chapter was to understand how firms respond to the hidden costs of offshoring, specifically situations in which the realised costs of offshoring exceed anticipated costs. While previous literature on the hidden costs of offshoring has concentrated on understanding the antecedents and the nature of these costs (Dibbern et al., 2008; Larsen et al., 2012; Stringfellow et al., 2008), we proposed an alternative perspective by addressing the consequences of these costs due to their ex ante unforeseen nature. Accordingly, we operationalised firms' responses as ex post redesigns in the organisational architecture based on firms' realisations of unexpected costs toward systems integration. This is facilitated through knowledge absorption gained from experiences with offshoring.

The case of LEGO and its sourcing adventure illustrates this thesis well: After having offshored a substantial portion of the production to Flextronics, LEGO realised that the sourcing collaboration did not fulfil the initial expectations, which eventually triggered an organisational redesign through the insourcing of activities. One can speculate about whether the sudden financial crisis drove LEGO to offshore its production without devoting enough resources into understanding how to design the new offshoring organisation, thus avoiding hidden costs. Important for our illustration, however, is that LEGO incurred hidden costs. The organisational redesign that was initiated to overcome these costs thus support the initial proposition of this book chapter, namely that the empirical assessment of hidden costs of offshoring only becomes fertile after the costs have revealed themselves (considering that hidden costs are defined as the deviation between realised costs and expected costs).

In response to the complex and ineffective supply chain, LEGO expanded its global dispersion by allocating much of the production control and ownership to Flextronics. By targeting low-cost countries and market proximity, the LEGO management expected that a higher degree of global dispersion would, in essence, decrease the inefficiencies and complexity of its production network. This development is in line with a definition of offshoring as the process by which a firm disaggregates the value chain into smaller components, devises appropriate interfaces between these, and then relocates selected components to another country, either internally in the company hierarchy (captive offshoring) or to an external partner (offshore outsourcing) (Contractor et al., 2010; Tanriverdi et al., 2007). While LEGO had offshored some production capacity prior to Flextronics, the scale-up in offshore outsourcing made it necessary for the company to disaggregate and identify which production tasks and activities that were going to be relocated to Flextronics. It was therefore of paramount importance that the interfaces and interdependences between the organisational offshored and in-house tasks and activities were identified and defined to create and maintain a coherent organisational system. Obviously, the interactions and interdependences between the firm's tasks and activities must be defined under all organisational settings, offshoring or not (Thompson, 1967; Ven & Delbecq, 1976). However, the exercise of offshoring presents firms with new challenges given the context-dependent differences between the spatially separated units, such as cultures, political systems and geographical distances and differences (Kumar et al., 2009).

After some years of collaborating with Flextronics, LEGO realised that the sourcing agreement was in fact more costly than originally anticipated. The high pace of transition, as well as the challenges of aligning the two business models had created an inflexible and uncondusive platform for collaboration and growth, and had thus presented LEGO with substantial hidden costs. Following Dibbern et al. (2008), LEGO's hidden costs can be related to control (LEGO could not foresee what Flextronics what doing), coordination (challenges of aligning the two significantly different business models), knowledge transfer (a too high pace of transition hindered the necessary knowledge to be transferred) and specification/design (difficulties of specifying the required output

according to market demands). LEGO's main response to these costs was to regain the ownership of the offshored activities (i.e. from offshore outsourcing to captive offshoring). Accordingly, LEGO's hidden costs can be interpreted as the failure to create an integrated organisational system which sparked a new round of organisational redesign. The failure of LEGO in controlling and coordinating the different actors and components in the organisational system – hence lack of integration – caused a number of unexpected costs and challenges that eventually forced the LEGO management to rethink the production network. The change in ownership in the globally dispersed network of production facilities can therefore be understood as a strategic response to the newly realised hidden costs with the purpose of furthering the integration of the organisational system. LEGO integrated its network of production facilities by standardising and documenting the interfaces between the value chain components. Arguably, this led to a reduction of the interdependences between the different units and tasks which could facilitate the more manageable coordination of the network of spatially differentiated activities. LEGO's approach to system integration can hence be seen as an organisational modular approach (Baldwin & Clark, 1997; Langlois & Robertson, 1992; Sanchez & Mahoney, 1996). Sturgeon (2002) argues that modular value chains or production networks consists of lead firms which concentrate higher value-adding activities such as R&D and marketing, while manufacturing and lower value-adding activities such as manufacturing are outsourced to globally operating turn-key suppliers. What further characterises the network is the 'codified inter-firm links and the generic manufacturing capacity residing in turn-key suppliers to reduce transaction costs, build large external economies of scale and reduce risk for network actors' (Sturgeon, 2002, p. 451). In this sense, organisational modularity with its emphasis on standardised and minimised interfaces and interdependences — a loosely coupled system (Orton & Weick, 1990) — becomes one measure for system integration (Brusoni et al., 2001) that seems to characterise LEGO's approach well.

Obviously, there are other ways of integrating an organisational system comprising globally dispersed and disaggregated value-chain activities. For instance, the surge of information technology has pro-

vided ground for integrating and coordinating the virtual organisation whose members and subunits are globally apart (Boudreau, Loch, Robey, & Straud, 1998; Wiesenfeld, Raghuram, & Garud, 1999). Moreover, Ernst and Kim (2002) describe the prevalence of global production networks in which 'network flagship' (lead firms) integrate the different activities through their higher network status. The essence, however, is that LEGO's key mechanism for responding to hidden costs of offshoring was to create organisational system integration. Therefore, system integration seems to be at the central to the successful management of hidden costs of offshoring. The emergence of hidden costs can be understood as the failure of firms to achieve systems integration, i.e., the less able the offshoring firm is to integrate the globally dispersed and disaggregated activities into an orchestrated organisation, the more likely it is to encounter hidden costs.

The case illustrates the moderating role of organisational learning in achieving systems integration. The case story comprises three different states or 'snapshots' of LEGO in regards to its offshoring adventure. In the first round, the company learned the value of documenting and standardising its processes and interfaces in the pursuit of system integration to achieve a flexible supply chain. However, as new hidden costs emerged as a result of globally dispersing the production network through the engagement with Flextronics, LEGO decided to alter the ownership structure of the global production network towards captive offshoring; yet, keeping and valuing the modular architectural design to achieve system integration as means for alleviating unexpected costs. Evidently, LEGO's organisational learning spurred these new rounds of reconfiguration with an ultimate goal of systems integration. Moreover, the prevalence and realisation of the hidden costs of offshoring suggest an offshoring failure; i.e. the firm encountered more costs than it expected and calculated for. This knowledge pushed LEGO to search for new and better means of managing hidden costs, and therefore spark a process of organisational redesign. This suggests that LEGO's response to the hidden costs of offshoring was grounded in an incremental absorption of knowledge from failure. The organisational redesign was driven by LEGO's failure to successfully carry out a sourcing collaboration with Flextronics.

In conclusion, this chapter has investigated how firms manage hidden costs of offshoring. Drawing on literature on organisational design, we first suggested that the inquiry into the hidden costs of offshoring should be directed at the ex post consequences of their realisation. As the definition of hidden costs itself suggests, the exercise of empirically identifying the antecedents and the very nature of these costs becomes obscured by in that these costs can include 'everything'. Accordingly, we have looked at the strategic responses to manage these costs as a proxy to operationalise this concept. In this respect, we argue that a major response to hidden costs is to identify and utilise an organisational design mechanism that can facilitate the system integration of a globally dispersed and disaggregated organisation. Next, the process whereby firms realise the need and mechanisms for this is best characterised as an organisational learning process in which it makes qualitative sense to disaggregate between learning by success and learning by failure. The realisation of hidden costs of offshoring motivates the firm and its employees to challenge existing knowledge and search for new knowledge concerning how to successfully manage the offshoring organisation.

REFERENCES

- Argyris, C., & Schön, D.A. (1978). *Organizational learning: A theory of action perspective*. Cambridge, MA: Addison-Wesley.
- Aron, R., & Singh, J.V. (2005). Getting offshoring right. *Harvard Business Review*, 83(12), 135–143.
- Baldwin, C.Y., & Clark, K.B. (1997). Managing in an age of modularity. *Harvard Business Review*, 75(5), 84–93.
- Barthélemy, J. (2001). The hidden costs of IT outsourcing. *MIT Sloan Management Review*, 42(3), 60–69.
- Baum, J.A.C., & Ingram, P. (1998). Survival-enhancing learning in the Manhattan hotel industry, 1898–1980. *Management Science*, 44(7), 996–1016.
- Boudreau, M., Loch, K.D., Robey, D., & Straud, D. (1998). Going global: Using information technology to advance the competitiveness of the virtual transnational organization. *The Academy of Management Executive*, 12(4), 120–128.
- Brusoni, S., Prencipe, A., & Pavitt, K. (2001). Knowledge specialization, organizational coupling, and the boundaries of the firm: Why do firms know more than they make? *Administrative Science Quarterly*, 46(4), 597–621.
- Carmel, E., & Agarwal, R. (2002). The maturation of offshore sourcing of information technology work. *MIS Quarterly Executive*, 1(2), 65–76.
- Contractor, F.J., Kumar, V., Kundu, S.K., & Pedersen, T. (2010). Reconceptualizing the firm in a world of outsourcing and offshoring: The organizational and geographical relocation of high-value company functions. *Journal of Management Studies*, 47(8), 1417–1433.
- Dibbern, J., Winkler, J., & Heinzl, A. (2008). Explaining variations in client extra costs between software projects offshored to India. *MIS Quarterly*, 32(2), 333–366.

- Doh, J.P. (2005). Offshore outsourcing: Implications for international business and strategic management theory and practice. *Journal of Management Studies*, 42(3), 695–704.
- Dossani, R., & Kenney, M. (2003). 'Lift and shift': Moving the back office to India. *Information Technologies and International Development*, 1(2), 21–37.
- Ernst, D., & Kim, L. (2002). Global production networks, knowledge diffusion, and local capability formation. *Research Policy*, 31(8), 1417.
- Fiol, C.M., & Lyles, M.A. (1985). Organizational learning. *Academy of Management Review*, 10(4), 803–813.
- Fisher, S.R., & White, M.A. (2000). Downsizing in a learning organization: Are there hidden costs? *Academy of Management Review*, 25(1), 244–251.
- Frauenheim, E. (2003). Dell drops some tech calls to India. Retrieved 07/23/2010 from http://news.cnet.com/Dell-drops-some-tech-calls-to-India/2100-1022_3-5110933.html
- Graf, M., & Mudambi, S.M. (2005). The outsourcing of IT-enabled business processes: A conceptual model of the location decision. *Journal of International Management*, 11(2), 253–268.
- Grandori, A. (2001). Neither hierarchy nor identity: Knowledge-governance mechanisms and the theory of the firm. *Journal of Management and Governance*, 5(3), 381–399.
- Haunschild, P.R., & Sullivan, B.N. (2002). Learning from complexity: Effects of prior accidents and incidents on airlines' learning. *Administrative Science Quarterly*, 47(4), 609–643.
- Hendry, J. (1995). Culture, community and networks: The hidden cost of outsourcing. *European Management Journal*, 13(2), 193–200.

- Herath, T., & Kishore, R. (2009). Offshore outsourcing: Risks, challenges, and potential solutions. *Information Systems Management*, 26(4), 312–326.
- Hobday, M., Davies, A., & Prencipe, A. (2005). Systems integration: A core capability of the modern corporation. *Industrial and Corporate Change*, 14(6), 1109–1143.
- Jensen, P.D.Ø. (2009). A learning perspective on the offshoring of advanced services. *Journal of International Management*, 15(2), 181–193.
- Jensen, P.D.Ø., & Pedersen, T. (2011). The globalization of high-value activities: Why do firms offshore advanced tasks? *Journal of Management Studies*, 48(2), 352–372.
- Kedia, B.L., & Lahiri, S. (2007). International outsourcing of services: A partnership model. *Journal of International Management*, 13(1), 22–37.
- Kumar, K., Van Fenema, P.C., & von Glinow, M.A. (2009). Offshoring and the global distribution of work: Implications for task interdependence theory and practice. *Journal of International Business Studies*, 40(4), 642–667.
- Langlois, R.N., & Robertson, P.L. (1992). Networks and innovation in a modular system: Lessons from the microcomputer and stereo component industries. *Research Policy*, 21(4), 297–313.
- Larsen, M.M., Manning, S., & Pedersen, T. (2012). Uncovering the hidden costs of offshoring: The interplay of complexity, organizational design, and experience. *Strategic Management Journal*, DOI:10.1002/smj.2023.
- Larsen, M.M., Pedersen, T., & Slepnirov, D. (2010). LEGO Group: An outsourcing journey. Case 9B10M094, Ivey Management Services.

- Lawrence, P.R., & Lorsch, J.W. (1967). *Organization and environment. Managing differentiation and integration*. Boston: Harvard University Press.
- Lewin, A.Y., Massini, S., & Peeters, C. (2009). Why are companies offshoring innovation? The emerging global race for talent. *Journal of International Business Studies*, 40(8), 1406–1406.
- Lewin, A.Y., & Peeters, C. (2006). Offshoring work: Business hype or the onset of fundamental transformation? *Long Range Planning*, 39(3), 221–239.
- Madsen, P.M., & Desai, V. (2010). Failing to learn? The effects of failure and success on organizational learning in the global orbital launch vehicle industry. *Academy of Management Journal*, 53(3), 451–476.
- Manning, S., Massini, S., & Lewin, A.Y. (2008). A dynamic perspective on next-generation offshoring: The global sourcing of science and engineering talent. *Academy of Management Perspectives*, 22(3), 35–54.
- Maskell, P., Pedersen, T., Petersen, B., & Dick-Nielsen, J. (2007). Learning paths to offshore outsourcing: From cost reduction to knowledge seeking. *Industry and Innovation*, 14(3), 239–257.
- Mol, M.J., van Tulder, R.J.M., & Beije, P.R. (2005). Antecedents and performance consequences of international outsourcing. *International Business Review*, 14(5), 599–617.
- Mudambi, R. (2008). Location, control and innovation in knowledge-intensive industries. *Journal of Economic Geography*, 8(5), 699–725.
- Orton, J.D., & Weick, K.E. (1990). Loosely coupled systems: A reconceptualization. *Academy of Management Review*, 15(2), 203–223.
- Overby, S. (2003). The hidden costs of offshore outsourcing. *CIO*, 16(22), 60.

- Perrow, C. (1967). A framework for the comparative analysis of organizations. *American Sociological Review*, 32(2), 194–208.
- Porter, M.E. (1986). *Competition in global industries*. Boston: Harvard Business School Press.
- Prencipe, A., Davies, A., & Hobday, M. (Eds.). (2003). *The business of systems integration*. Oxford: Oxford University Press.
- Quinn, J.B., & Hilmer, F.G. (1995). Strategic outsourcing. *McKinsey Quarterly*, 1, 48–70.
- Reitzig, M., & Wagner, S. (2010). The hidden costs of outsourcing: Evidence from patent data. *Strategic Management Journal*, 31(11), 1183–1201.
- Sanchez, R., & Mahoney, J.T. (1996). Modularity, flexibility, and knowledge management in product and organization design. *Strategic Management Journal*, 17, 63–76.
- Simon, H. (1962). The architecture of complexity. *Proceedings of the American Philosophical Society*, 106, 467–482.
- Stringfellow, A., Teagarden, M.B., & Nie, W. (2008). Invisible costs in offshoring services work. *Journal of Operations Management*, 26(2), 164–179.
- Sturgeon, T.J. (2002). Modular production networks: A new American model of industrial organization. *Industrial and Corporate Change*, 11(3), 451–496.
- Tanriverdi, H., Konana, P., & Ge, L. (2007). The choice of sourcing mechanisms for business processes. *Information Systems Research*, 18(3), 280–299.
- Thompson, J.D. (1967). *Organizations in action: Social science bases of administrative theory*. New York: McGraw-Hill.

- United Nations Conference on Trade and Development (UNCTAD). (2004). World investment report: Transnational corporation and the internationalization of R&D. Geneva: UNCTAD.
- Ven, V.D., & Delbecq, A.L. (1976). Determinants of coordination modes within organizations. *American Sociological Review*, 41(2), 322–338.
- Wiesenfeld, B.M., Raghuram, S., & Garud, R. (1999). Communication patterns as determinants of organizational identification in a virtual organization. *Organization Science*, 10(6), 777–790.
- Zenger, T.R., & Hesterly, W.S. (1997). The disaggregation of corporations: Selective intervention, high-powered incentives, and molecular units. *Organization Science*, 8(3), 209–222.

CHAPTER 5

Managing Increasing Technological Complexity: Delivering Large System Products

Mikko Mattila, Aalto University, Finland

ABSTRACT

In order to be competitive, companies that produce large system products need to find an efficient way to operate with a global supply chain. As the variety of the products increases and technology evolves, products tend to become more complex, leading to challenges in, for example, managing the deliveries, manufacturing, order handling and decision making. Companies have created ways to manage complexity using a product structure design that facilitates the process throughout the lifecycle of a product. These approaches include grouping of components into subsystems, modular product architecture and product platforms. KONE is a Finnish elevator company that produces and delivers large system products that can be considered very complex. This chapter presents ways to manage the complexity by product structure and architecture design, and explains the example of the KONE Group.

Keywords: Complexity, large system, modularity, technological complexity, case study

INTRODUCTION

Most large Nordic companies today operate in broad global markets. These markets are growing and demanding a continuous stream of new products. Furthermore, companies often try to meet the requirements of smaller and smaller customer segments to be competitive with all the global competitors. This requires products that can be produced efficiently, renewed and introduced effectively and can also be delivered to customers located anywhere in the world. Often, segmentation leads to situations where new products have volumes which are too low for mass production processes. As the technology has evolved rapidly over the past few decades, today's large system products have become more complex, implementing dozens of different functions. Products must be designed and structured in a way that they allow for a high number of product variants and simultaneously support efficient supply chain performance (Kaski & Heikkilä, 2002).

To implement a high number of functions, products include many different components which may involve very different manufacturing technologies. High-tech products can include varying elements, from complex high-tech electronic components to low-complexity metal components. The supplier base for products of this kind can be wide and vary from local small enterprises to large-scale, global enterprises. As the markets can be global, so can the supply network. The components must be supplied efficiently from all around the world to the next node in the network.

When operating globally, it has become necessary for Nordic manufacturing companies to utilise the benefits of high value adding production in their products (Eloranta, Ranta, Salmi, & Ylä-Anttila, 2010). Moreover, companies must simultaneously be competitive in terms of costs. Companies need to find a solution as to how to efficiently handle the supply chain which incorporates components manufactured in low-cost countries with components manufactured in Nordic countries into a product that gives the customer the most value and is sold at a low price. This kind of decentralised production dramatically increases the complexity of the supply chain. This complexity can be decreased or made less apparent with proper product design.

The technological complexity of a product is increased by many factors, for example, advanced technologies, global markets, a global supplier network, larger products, a wider product portfolio, a variety of products and a larger number of different components. This kind of increasing complexity, if not properly managed, involves challenges for the performance of the company; lead times, decision making, cost modelling, forecasting and global operational efficiency are areas in which challenges arise when complexity increases.

In order to manage the complexity of the product, companies have created technologies, methods and strategies to hide and manage the complexity more efficiently. One very common method is creating a modular product architecture. In order to manage the product, process and supply chain concurrently Fine (2000) suggests a three-dimensional engineering process that combines the design of these three dimensions. The product itself is designed along with the design of the processes and the supply chain. This approach drives the companies to take management of complexity into account at the product structure design phase. Product platforms, product modularisation and grouping to subsystems can be considered as tools for the efficient management of complex systems.

Figure 1. Three-dimensional concurrent engineering. Overlapping responsibilities across product, process, and supply chain development activities (Fine, 2000)

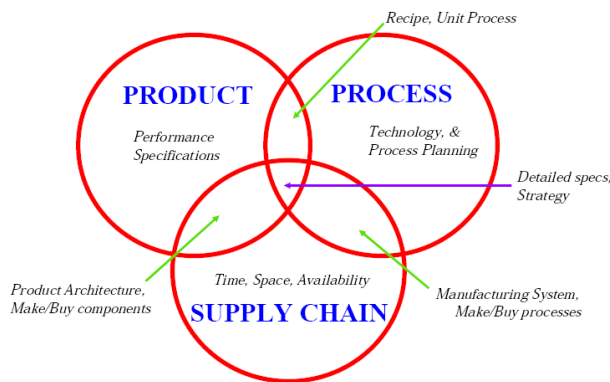

Companies supplying large system products need to operate differently from those selling normal commodity products. A large system delivery is a concept of products that consist of many systems operating somewhat separately, are large in size and typically cannot be manufactured through the normal manufacturing processes. As such, large system products cannot be fully compared with the production of, e.g. cars, mobile phones or personal computer devices. It is usually difficult or even impossible for large products to be completely manufactured in a factory because of, e.g. physical size or the benefits of decentralised production. The products are usually delivered to the customer in pieces and then installed at the customer's premises. The installation work done at the customer site can be considered relatively expensive in comparison with the work done at the factory. Thus, it is reasonable to minimise the work load at the installation site. Such a supply network needs to be optimised in order to minimise the costs at the installation site, but without increasing complexity.

This chapter presents a case study of complexity management related to customised large system products in a global supply chain at a Finnish elevator company, KONE. KONE's elevators are an example of products that need to be customised for thousands of different needs, delivered and installed in different component groups at different phases and produced globally. The complete product includes components varying from high-tech electronic components to low-complexity metal parts. KONE provides an excellent example of a successful response to the challenge.

KONE looks for the best way of operating globally, with a large variety of large system products that are delivered and installed efficiently for customers who may be located anywhere in the world. To manage complexity, KONE has created a product structure that combines operative subsystems, product platforms and modular product architecture. This improves the global operational efficiency, decreases lead times, reduces the number of different components and facilitates forecasting, cost modelling and decision making.

The present chapter gives a short introduction to the present theories on product platforms and product modularisation. It emphasises these themes in terms of their relevance to the supply chain of large system deliveries.

PRODUCT MODULARITY

Product modularity is a concept that has proven useful in dealing with complex systems. It makes complex product architectures appear simpler and easier to handle. Two subsidiary ideas comprise the general concept of a modular product structure (Baldwin & Clark, 2000):

- The idea of interdependence within and independence across the modules;
- Abstraction.

There are many definitions of the term *module*. The most commonly used is McClelland's definition, where a module is a unit whose structural elements are powerfully connected among themselves and relatively weakly connected to elements in other units (McClelland & Rumelhart, 1995). In other words, modules are structurally independent chunks in a larger system where they work together with the rest of the system through well-defined interfaces. A product consisting of functional modules has a modular product architecture. Furthermore, Ulrich (1993) defines *modular architecture* to include chunks that implement one or very few of the functional elements of the product. Modular architecture is the opposite of *integral architecture* where, in turn, the functional elements are implemented using more than one chunk. Examples of an integral and a modular trailer are presented in Figure 2 (Ulrich & Eppinger, 2008).

Figure 2. Trailers with an integral (left) and modular (right) architecture (Ulrich, 1993)

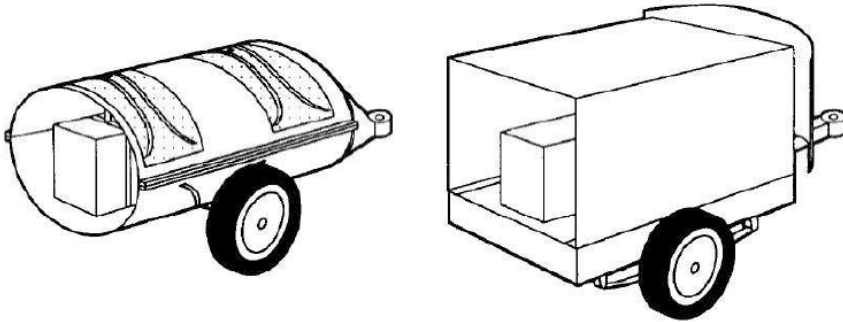

Product modularity is usually considered a product development and design approach to efficient mass customisation that enables the supply chain processes to produce products that meet the needs of almost every customer at a price close to the traditional mass-produced product. The mass customisation process aims to combine economies of scale and economies of scope by efficient product differentiation (Pine, 1999). Products with a well-designed modular architecture can allow several differentiating products based on a few differentiating components with a relatively flexible and efficient production process (Kaski & Heikkilä, 2002).

Feitzinger and Lee (1997) describe three basic building blocks of an effective mass-customisation program. The first of these are highly related to the product modularisation and the latter to modularity and supply network design (Feitzinger & Lee, 1997):

- A product should be designed so that it consists of independent modules that can be assembled into different forms of the product easily and inexpensively;
- Manufacturing processes should be designed so that they, too, consist of independent modules that can be moved or rearranged easily to support different distribution network designs.

- The supply chain network – the positioning of inventory and the location, number and architecture of manufacturing and distribution facilities – should be designed to provide two capabilities. First, it should be able to supply the basic product to the facilities performing the customisation in a cost-effective manner. Second, it must have flexibility and responsiveness to take an individual customer's orders and deliver the finished, customised goods quickly.

Ulrich and Eppinger (2008) and Feitzinger and Lee (1997) both list delayed differentiation as one of the advantages of a supply chain which is enabled by an effective mass customisation program involving a modular product structure. When a firm offers several variants of a product, the product architecture is a key determinant of the performance of the supply chain. Postponing the differentiation of a product until late in the supply chain is called delayed differentiation. Delayed differentiation can be seen as moving the order penetration point

Figure 3. Mass production combined with the independent modules at the order penetration point (Adapted from Feitzinger & Lee, 1997; Olhager, 2003; Sako & Murray, 1999; Ulrich & Eppinger, 2008)

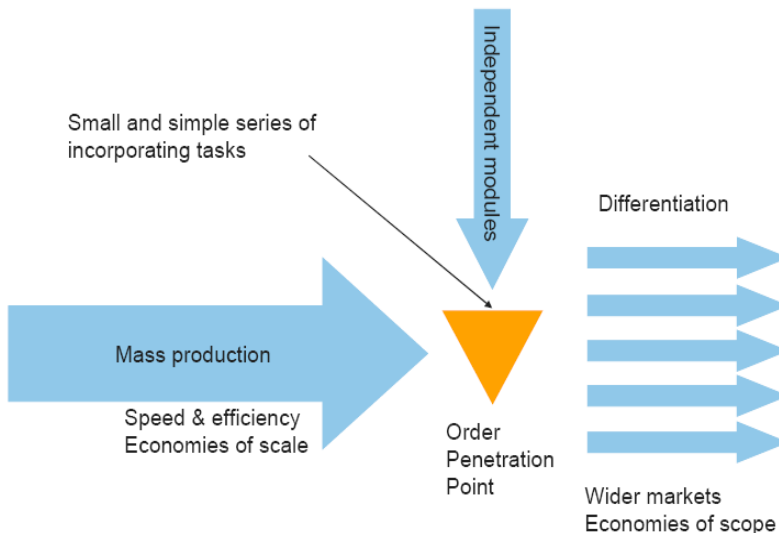

(OPP) to a latter phase. The ideas of mass customisation and the OPP are introduced in Figure 3. Standard parts of the product are produced efficiently with a mass production process, and then the independent modules are produced by separate production lines. The modules should be combined with small and simple series of incorporating tasks at the OPP in the supply network (Olhager, 2003; Sako & Murray, 1999). This can be done only if the product and its architecture are designed for efficient mass customisation (Feitzinger & Lee, 1997; Ulrich & Eppinger, 2008).

The disadvantage of modularity can be poor performance characteristics in the product. A product with a modular architecture is usually larger in size and does not perform the same functions as the integral product (Ulrich & Eppinger, 2008). From the operations and supply chain perspective, however, modularity hides the technological complexity of the product. It can offer global operations advantages like reduced lead times, a reduced number of different components and better production planning and control.

There are established methods for the creation of a modular product architecture. One of these methods, modular function deployment (MFD) is applicable to already existing product structures. The MFD method is created to reinforce the design for excellence (DfX) methods, which aim for a product design optimisation over a complete product lifecycle (Erixon, 1999).

PRODUCT PLATFORM

A platform-based product is another model of business operation that can be associated with modularity. A well-functioning platform enables the assembly of product instances via the means of systematic product variation from the ready-made modules on the platform, following an existing product architecture (Lehtonen, 2007). Product platforms are widely discussed in product development literature as well as product strategy literature. There are dozens of definitions for the product platform, ranging from a narrow to broad. Some of the widely adopted definitions are as follows (adapted from Huang, Simpson, & Pine, 2005):

- A set of subsystems and interfaces that form a common structure from which a stream of derivative products can be efficiently developed and produced (Meyer & Lehnerd, 1997);
- A collection of the common elements, especially the underlying core technology, implemented across a range of products (McGrath, 2001);
- The collection of assets (i.e. components, processes, knowledge, people and relationships) that are shared by a set of products (Robertson & Ulrich, 1998).

Product platforms simplify the product variability for a company. This facilitates supply chain processes as well as product design and development processes. Figure 4 illustrates the product releases of products based on the same technological platforms. A product platform approach dramatically reduces manufacturing costs and provides significant economies in the procurement of components and materials, because so many of these are shared among individual products (Meyer & Lehnerd, 1997).

Figure 4. Product releases from the same technological platform elements (adapted from McGrath, 2001; Meyer & Lehnerd, 1997; Ulrich & Eppinger, 2008,)

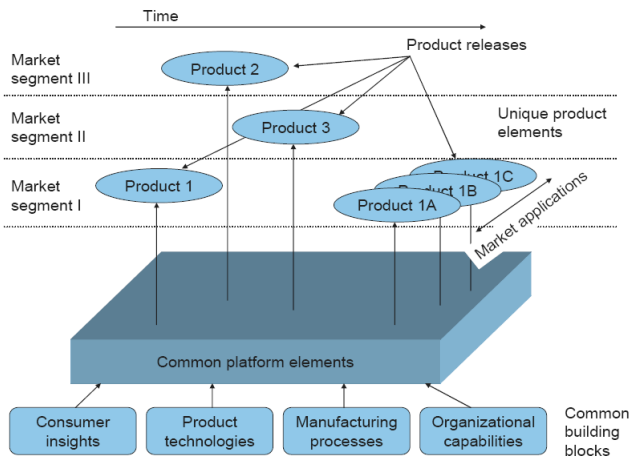

A product platform is primarily a definition for planning, decision making and strategic thinking. McGrath has listed some benefits of a product platform strategy. The benefits which McGrath (2001) mentions are as follows:

- A platform strategy focuses management on key decisions at the right time;
- It enables products to be deployed rapidly and consistently;
- A platform approach encourages a longer-term view of product strategy;
- A platform strategy can leverage significant operational efficiencies;
- Product platform principles help management to anticipate replacement of a major product platform.

Heikkilä, Karjalainen, Martio and Niininen (2002) have summarised the benefits of product platforms in automobile industry from various sources. These are as follows (Brylawski, 1999; Muffato, 1999; Wilhelm, 1997, adapted from Heikkilä et al., 2002):

- Decreased costs via higher production/purchase volumes of shared components;
- Decreased costs via concentration of development work to unique parts on a new model;
- Potential to offer greater product variety with increased speed and lower costs and risks;
- Reduced number of separate components, which simplifies inventory and tracking and encourages supplier consolidation;
- Higher quality through already tested and hardened compo-

nents or applications, and focus on innovation in selected technologies.

According to Muffato (1999), in general terms, the potential benefits of the platform approach are reduced development and manufacturing costs, reduced development time, reduced systemic complexity, better learning across projects and improved ability to update products. Muffato has studied the product platform strategies of the automobile industry. According to him, the platform also offers advantages in global operations. A platform permits (Muffato, 1999):

- Greater flexibility between plants (the possibility of transferring production from one plant to another due to standardisation);
- Cost reduction achieved through using resources on a global scale;
- Increased use of plants (higher productivity due to reduction in the number of differences);
- Reduction of the number of platforms as a result of their localisation on a world-wide basis.

MANAGING COMPLEXITY AT THE CASE COMPANY

Large system deliveries at KONE

KONE has found that for cost efficiency reasons, manufacturing of the elevators should as much as possible be done at subsystem factories, reducing the amount of work at the installation site. At KONE, this is carried out by dividing the product into subsystems that are manufactured at KONE's own factories or purchased as a complete subsystem from a supplier. A typical subsystem fulfils these requirements, i.e. it can be supplied by one supplier and delivered efficiently to the installation site, where it can be efficiently installed.

The subsystems are managed at the case company by cross-functional

organisations that optimise the subsystems to comply with the supply chain from end to end. The interfaces of the subsystems need to be managed, since the subsystems must function seamlessly with each other. The idea of dividing the product into subsystems is presented in Figure 5. Requirements from case company's delivery operations to the product structure are presented on the left.

The introduced example is not only applicable to elevators, but also to many large system products, for instance telecom network stations, earthmovers, cranes or air ventilation systems.

Figure 5. Delivery operations-based inputs divide the product into subsystems. The larger box represents the product and the smaller boxes represent the subsystems

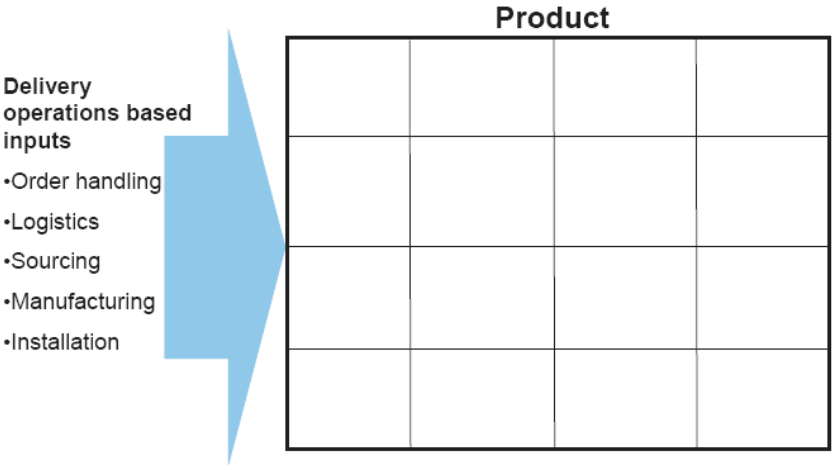

These subsystems are basically a medium for communication and management. In a global supply chain, effective communication is essential. The supplier needs to know what to deliver within one subsystem, and the installation functions need to know what they are getting when ordering a subsystem. It is necessary to limit the impact of product customisation to subsystems and maintain standard proce-

dures to deliver the product accurately for the expensive installation phase. The complexity of the product is easier to manage with a limited number of subsystems, where organisations can focus only on their subsystems.

Modularity and product platforms at KONE

KONE's elevators have thousands of different requirements from the customer. These can be categorised into visual requirements, dimensional requirements, drive properties, safety requirements and variability of regulations. The variety can be effectively managed only through a modular product architecture.

The benefits of modularity are usually sought, besides through product design and development, from the supply operations. The manufacturing process can be considered to end at the termination of the installation phase of the product. Thus, the modularity on a large system product is very challenging to create. The product cannot be customised with the selection of subsystems, but a modular architecture needs to be established within each subsystem. The subsystems are manufactured at a factory and are capable of providing the benefits that modular architectures usually do in, for example, the automobile industry or consumer electronics industry.

In the creation of modularity, the natures of the project business and the large system products have to be considered. The MFD method needs to be adapted to projects where the product is not manufactured at the factory. The installation phase and the potential for delayed differentiation must be emphasised in the creation of the modular product architecture in large system product deliveries. The installation phase and the delivery are the most expensive phases of the manufacturing and delivery process.

Both of these processes are also almost unique, since they take place at construction sites across the globe. The delivered subsystems have modular structures to make the customisation process more efficient. More efficient customisation aims at improved variation, production

control, product development, quality, after sales, delivery and installation. The aims differ in different groups. The common aim for all the groups is decreasing lead times and making the delivery more accurate through better production control. The concept of forming KONE's modular product structure with subsystems and modularity within them is presented in Figure 6.

Figure 6. Thousands of requirements for products' properties from the customer (left above, presented with colours) combined with subsystems (left below, presented with lines) form a product structure that is modular and serves the delivery of the large system product

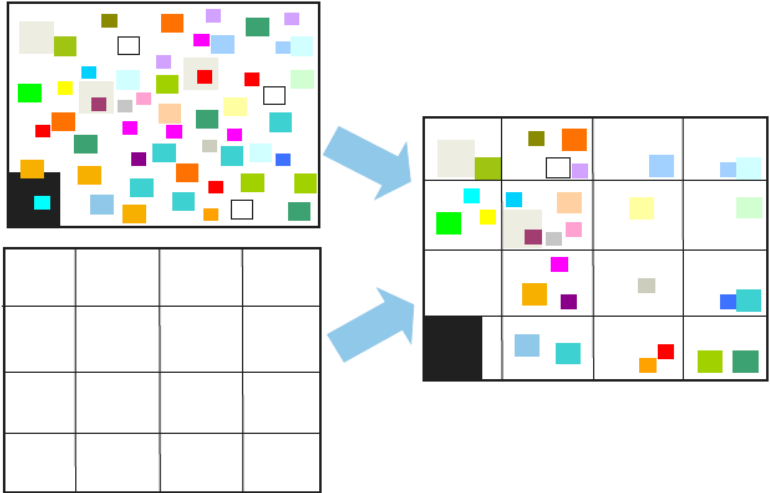

The modules consist of parts that are usually customised to the customer or need to be separated from the other systems for supply chain efficiency reasons. The handrail in the elevator car, for example, is usually customised for the customer (based on visual and dimensional characteristics and regulations), and can be efficiently produced as a separate module and then incorporated easily with the rest of the product. This can only be done if the handrail and its interface to the elevator are designed for such operations.

This kind of division of the product structure hides the complexity of the product for efficient delivery, making order handling, logistics, sourcing, manufacturing and installation clearer. It decreases the lead times and number of different components and makes the delivery of each subsystem more accurate.

As the subsystems can be considered products that are manufactured in factories, the product platforms can be designed for each subsystem. The platforms serve as the base for the modular product structure within the subsystems. The platforms, including the core technology, leverage the global operations. At the case company, there is a need for two kinds of platforms:

- Platforms which are compatible with all the products. The products throughout the product portfolio use the same technological solutions;
- Platforms which form the product families. Products throughout the product family use the same technological solutions.

Both platform types are presented in Figure 7.

Figure 7. Core technology platforms and shared component platforms form the product families that share common technology and address related market applications

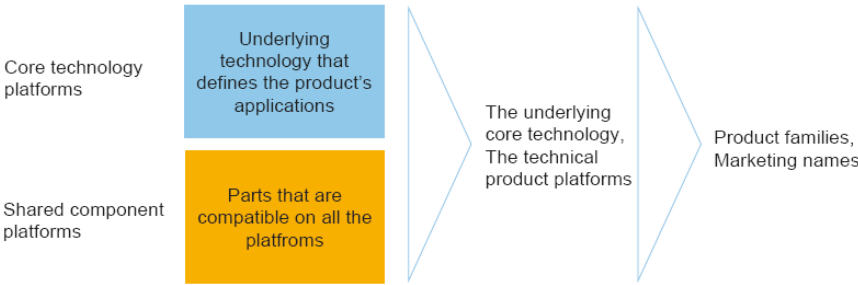

Product technologies are the most important assets of the product platform, components and subassemblies in particular. Product platforms reduce the technological complexity, as there is a reduced number of different components and a clear strategy for product platforms that are globally harmonised. Furthermore, there are no overlapping local products. In other words, the product structures are global even though there are some local product variations.

The creation of product platforms is done according to the subsystem division. The platforms can be the base for a whole subsystem or just for a part of it. These platforms are then the base for a modular product structure. In the creation of platforms and modularity, all instances that the product structure has an impact on should be involved. The creation of modularity for large system products can be done as with products generally, for example, according to the MFD method. With elevators, the differences from this model are as follows:

- The base of modularity creation is a subsystem, not the whole product;
- In identifying the potential modules, the nature of large system deliveries is emphasised.

CONCLUSIONS

At KONE, decreasing the complexity of the product with product platforms, modularity and standardisation enable the postponement of the OPP, which in turn enables an efficient supply chain incorporating low-cost and high value adding production.

The modularity-based separation and decentralisation of manufacturing can create a good overall result. It can save costs if the company can utilise both the low-cost and high value adding production properly. This can be done only if the complexity of the product is properly managed through design, where modularity and platforms hide the technological complexity. Through concurrent product architecture, process, and supply chain design, the benefits of a global operations

network can be utilised. Platforms must be managed, modules and their interfaces must be managed and in large system products, grouping to subsystems must be carried out in order to serve the full chain profitability.

Product variants and mass customisation can be handled with modularity and product platforms in such a way that they do not increase the complexity of the supply chain. Modularity, when properly managed, enables the postponement of the OPP.

The manufacturing companies in Finland cannot focus on products that involve low cost manufacturing, as could be done in low-cost countries. Instead, the production in a high-cost country like Finland or other Nordic countries should focus on products that bring customers the most value (Eloranta et al., 2010).

Tentatively, in the case of large system products, production can also focus on system components that bring the most value to the customer. Thus, the separation of large system product manufacturing into separate module or subsystem manufacturing could ultimately lead to a process where the mass-produced standard subsystems are manufactured in the lower-cost countries, and are combined at some part of the supply network through simple and small incorporating tasks with the independent, high added value modules which involve complex manufacturing processes or the need of proximity to the customers or engineering.

Nordic companies can utilise the concepts of first product, best product and agile production (Eloranta et al. 2010) with large system products by decentralising the production of high value adding subsystems and low-cost, mass-produced subsystems. Modularity enables postponement of the OPP, which in turn enables the efficiency of the supply chain, incorporating components made in low-cost countries with those made in Nordic countries. By manufacturing low-cost components, the company can utilise the mass production mode as well.

REFERENCES

- Baldwin C. & Clark K., (2000). *Design rules: The power of modularity*. MIT Press, Cambridge, Massachusetts
- Brylawski, M. (1999). Uncommon knowledge: Automotive platform sharing's potential impact on advanced technologies. Conference preprint for the 1st International Society for the Advancement of Material and Process Engineering (SAMPE) Automotive Conference, 27–29 September, Detroit, Michigan.
- Eloranta, E., Ranta, J., Salmi, P., & Ylä-Anttila, P. (2010). *Teollinen Suomi* [Industrial Finland], Edita, Helsinki
- Ericsson, A. & Erixon, G., 2000. *Controlling design variants: modular product platforms*, Society of Manufacturing Engineers, Dearborn, Michigan
- Feitzinger, E., & Lee, H.L. (1997, January–February). Mass customization at Hewlett-Packard: The power of postponement. *Harvard Business Review*, pp. 116–123 .
- Fine, C.H. (2000). Clockspeed-based strategies for supply chain design. *Production and Operations Management*, 9(3), pp. 213–221 .
- Heikkilä, J. Karjalainen T., Martio A. & Niininen P., (2002). *Products and modularity: Managing competitive product portfolios through holistic platform thinking*. Helsinki University Press, Espoo
- Huang, G.Q., Simpson, T.W., & Pine, B.J. (2005). The power of product platforms in mass customization. *International Journal of Mass Customization*, 1(1), 1–13.
- Kaski T. & Heikkilä J., (2002). Measuring product structures to improve demand-supply chain performance. *International Journal of Technology Management*, 23(23), 578–598.

- Lehtonen, T. (2007). *Designing modular product architecture in the new product development*. Unpublished PhD dissertation, Tampere University of Technology, Tampere Finland.
- McClelland, J.L., & Rumelhart, D.E. (1995). *Parallel distributed processing*. Cambridge, MA: MIT Press.
- McGrath, M.E. (2001). *Product strategy for high technology companies*. McGraw-Hill Companies Inc., New York
- Meyer, M.C., & Lehnerd, A.P. (1997). *The power of product platforms*. The Free Press, New York
- Muffato, M. (1999). Introducing a platform strategy in product development. *International Journal of Production Economics*, 60–61, 145–153.
- Pine, B.J. (1999). *Mass customization: The new frontier in business competition*. Harvard Business School Press, Boston
- Olhager, J. (2003). Strategic positioning of the order penetration point. *International Journal of Production Economics*, 85(3), 319–329.
- Robertson, D., & Ulrich, K. (1998, Summer). Planning for product platforms. *Sloan Management Review*, pp.19-32.
- Sako M. & Murray E.. (1999). Modules in design, production and use: Implications for the global automotive industry. Paper prepared for the International Motor Vehicle Program (IMVP) Annual Sponsors Meeting, 5–7 October 1999, Cambridge, MA, USA.
- Ulrich, K. (1993). The role of product architecture in the manufacturing firm. *Research Policy*, 24, 419–440.
- Ulrich, K., & Eppinger, S. (2008). *Product design and development*. McGraw-Hill Companies, Inc., New York

Wilhelm, B. (1997). Platform and modular concepts at Volkswagen - their effect on the assembly process. In K. Shimokawa, U. Jürgens, & T. Fujimoto (Eds.), *Transforming auto assembly*. pp. 146–156, Berlin: Springer.

CHAPTER 6

Managing Sustainability: Capabilities For Sustainable Operations

Johanna K. Jaskari, *Aalto University, Finland*

ABSTRACT

This paper explores how two emerging sustainability issues – carbon neutrality and low-energy use for operations networks – may transform industrial firms' processes in different industrial contexts. Based on interviews with individuals from global Finnish manufacturing firms, the following issues are analysed: the effects of carbon neutrality and low-energy use on operations, firms and industries; the relationships of changes, uncertainties, competition and value and costs to carbon neutral and low-energy requirements; and the planning and control of carbon neutral and low-energy-use operations networks. These issues are analysed in terms of dynamic and ordinary capabilities; scope and pace of change; effects and contents of processes; uncertainties and competition; and causal logic of firms' actions in different industries. These results provide insights into how managers can create and maintain sustainable carbon neutral and low-energy-use operations in future industrial contexts.

Keywords: Sustainability, sustainable operations, dynamic and ordinary capabilities, case studies

INTRODUCTION

Today, knowledge of operations management is well known and widely diffused (Teece, 2007). Firms may make a living by their global operations (Helfat et al., 2007; Winter, 2003), but few firms earn superior rents from their operations (Teece, 2007). Sustainability issues, in turn, might be considered to provide 'something new' for global operations. Yet, how are global operations and sustainability related? This chapter examines how carbon neutrality and low energy use influence firms' operations. A firm's manufacturing processes are ordinary and dynamic capabilities that adapt or change industrial contexts in order for the firm to achieve competitive advantages (e.g. Eisenhardt & Martin, 2000; Nadkarni & Barr, 2008; Teece, 2007). Potential regulations, especially on carbon neutrality and low energy use, may change industry structures and manufacturing processes. However, new forms of global operations or manufacturing processes are a result of what managers think about how their firms should act in their industrial contexts.

The purpose of this chapter is to provide a perspective on how two emerging sustainability issues – carbon neutrality and low energy use for operations networks – may transform industrial firms' processes in different industrial contexts. Specifically, this study explores how ordinary and dynamic capabilities are needed to change manufacturing processes; how the scope and pace of industrial contexts are affected; how the effects and contents of processes are value driven or cost driven; how uncertainties and competition affect future networks; and how the causal logic of managerial cognition affects their firms' action in different industries. As a result, this chapter provides insights into how managers can create and maintain sustainable manufacturing processes in future industrial contexts.

The context in this study is Finnish manufacturing firms' global operations. The study is based on surveys and interviews administered in the fall of 2010. The participating firms in this study are Efore Oyj, Fiskars Oyj, Halton Oy, Helkama Bica Oy, Kone Oyj, Marimekko Oyj, Note Hyvinkää Oy, Teleste Oyj and Vaisala Oyj.

MANAGING SUSTAINABILITY: CAPABILITIES FOR SUSTAINABLE OPERATIONS

A firm's strategy, including its manufacturing processes, is a consequence industry's influence on how managers make sense of and act within their environments (Nadkarni & Barr, 2008). Yet, external economic characteristics of industries do exist independently of managers' beliefs about them (Johnson & Hoopes, 2003). Given that a firm's operations network is required to be carbon neutral and highly energy efficient, how should firms' processes be transformed in different industrial contexts?

Operations networks are networks whose members are strategically, operationally and technologically integrated (Hult, Ketchen, & Nichols, 2002). In operations networks, separate, but interdependent firms transform raw materials into finished products (e.g. Hult et al., 2002; Hult, Ketchen, & Slater, 2004). Although firms' operations have improved significantly in the last decades, operations management is today well known and widely diffused. Many manufacturing processes can be implemented relatively easily within any firm and many manufacturing processes can be outsourced (Teece, 2007).

A dynamic capability is a firm's ability to integrate, build and reconfigure internal and external competencies to address rapidly changing environments (Teece, Pisano, & Shuen, 1997). Thus, dynamic capabilities aim at effecting change by helping the firm to adapt or change its environment (e.g. Eisenhardt & Martin, 2000; Teece, 2007; Teece et al., 1997; Zott, 2003). A firm develops dynamic capabilities to create, extend or modify its ordinary capabilities (Teece, 2007). A firm's ordinary capabilities (such as routine manufacturing processes) are repetitive, patterned and learned actions performed to achieve specific objectives (Winter, 2003). Dynamic capabilities concern the firm's evolutionary fitness (Teece, 2007), that is, how well the firm's ordinary capabilities enable the firm to make a living (Helfat et al., 2007). Ordinary capabilities are defined by technical fitness in terms of how well functions are performed. A firm's ordinary capabilities permit the firm to make a living in the short term (Helfat et al. 2007; Winter, 2003). If a firm lacks dynamic capabilities, it cannot earn rents in the long term. However,

there is a balance between the costs of a capability and its actual use (Teece, 2007).

Dynamic capabilities are firm specific. Specifically, a firm's dynamic capabilities reside with its management, as dynamic capabilities require knowledge both of the firm and the firm's competitive context (Teece, 2007). Hence, dynamic capabilities cannot be outsourced. Further, it matters when firms change. Intra-industry firm-performance differences arise between firms due to both the costs and timing of dynamic capabilities (Zott, 2003). Specifically, future rent appropriation is often shaped when new capabilities are developed, well before any value is actually created (Coff, 2010). In a dynamic context, ordinary capabilities negatively affect rent creation and dynamic capabilities positively affect rent creation (Drnevich & Kriauciunas, 2010).

Change is characterised by (continuous or episodic) pace and by (convergent or radical) scope. First, when pace is continuous and scope is convergent, change is emergent and local. The firm encounters minor instabilities, improves or learns and makes small adaptations that occur within existing frames. External positive feedback encourages deviations and adaptations. Second, when pace is episodic and scope is convergent, change is intended and local. Change is driven by minor inertia within existing frames. Negative feedback from the system highlights the need for minor local replacements. Third, when pace is continuous and scope is radical, change is emergent and system wide. The firm and its environment encounter a major instability and make frame-bending adaptations. Positive and negative feedback pulls the system into two directions, that is, towards instability. Fourth, when pace is episodic and scope is radical, change is intended and system wide. Change is driven by major inertia. Negative feedback highlights the need for major radical, system-wide and frame-bending replacements (e.g. Plowman et al., 2007).

The process effects of change (e.g. costs associated with reconfiguring resources within operations, learning new routines and building new relations with exchange partners) are expected to be negative. The content effect of change (e.g. the impact of adjusting to fit environmental

demands) may be positive or negative depending on the luck and skill of the firms' managers (Haveman, Russo, & Meyer, 2001). Given the contents and process of change, the creation of new ordinary and dynamic manufacturing capabilities may lead to failure or success.

Industry structures define the degree to which firms' environments are predictable or uncertain. In high-velocity industries, rapid and unpredictable changes in product and process technologies and competitors' actions make it difficult for managers to develop clear understandings of their environments. In contrast, the stability of low velocity industries allows managers to gradually build and improve their understanding of the environment (Eisenhardt & Martin, 2000; Nadkarni & Barr, 2008). In high-velocity industries, firms respond more quickly to changes concerning competitors, suppliers and customers, which directly affect the firm in their task sectors; in contrast, firms in low-velocity industries respond more quickly to social, demographic, economic and political events in their general sector (Nadkarni & Barr, 2008). Hence, the natures of distinct industries pose different cognitive challenges for managers.

The creation of new operations strategies for the future requires a firm's management to develop (operations) strategies in response to an external environment or to proactively construct their environments (Nadkarni & Barr, 2008; Wiltbank, Dew, Read, & Sarasvathy, 2006). If an external environment is predictable, managers can plan for the future. If the external environment is unpredictable, managers can shorten their planning horizons and invest in flexible strategies that respond to environmental changes. In a controllable constructed environment, managers can assume that the environment is predictable and shape the environment to achieve desired outcomes. For nonpredictive control in a constructed environment, managers can transform the environment by constructing with others largely yet non-existent environments (Wiltbank et al., 2006).

Recognising opportunities (such as the creation of new manufacturing processes) involves both the objective reality and subjective interpretations of one's context (Grégoire, Barr, & Shepherd, 2010). Managers'

subjective cognitive interpretations of their contexts, rather than the objective nature of the contexts themselves, determine which external events, as well as which causal logics between the external environment and the firm, are noticed and responded to. Managers focus their attention on those issues that they deem to be most relevant, while selectively ignoring others (Daft & Weick, 1984; Nadkarni & Barr, 2008).

Structural alignment explains how people make sense of new information. Structural relationships are either one-to-one functional relationships between superficial features or relationships-between-relationships (such as causal chains, goal statements, and conditional rules). Whereas superficial features align initial reasoning about new information, structural relationships affect the recognition of opportunities. For example, opportunities might be overvalued because strong perceived superficial similarities may not prove to be important or less obvious opportunities might be undervalued because strong relationships are not perceived. In contrast, persons with advanced knowledge recognise opportunities with strong structural relationships in the absence of superficial similarities (Grégoire et al., 2010).

Regulations affect firms' strategies by creating new competitive contexts (Delmas, Russo, & Montes-Sancho, 2007). For example, attending to environmental aspects does improve firms' processes and reduce firms' risks (e.g. Sharfman & Fernando, 2008). However, regulatory regimes vary greatly, and a general theory of the consequences of regulations cannot be developed. Regulatory changes can trigger novel selection pressures that alter rewards and sanctions for firms' actions. In terms of regulatory contents, firms must identify how the regulations affect the firms' processes and make appropriate actions in regard to new competitive contexts. The actions must also be properly timed and sequenced (Haveman et al., 2001). However, this implies that firms can develop and maintain new context-specific rent-creating capabilities in their industries.

CARBON NEUTRALITY AND LOW ENERGY USE IN OPERATIONS NETWORKS

In this section, the issues of how carbon neutrality and low energy usage might transform operation networks are analysed. In the first part of this section, I will analyse how carbon neutrality and low energy use affect operations, firms and industries; how changes, uncertainties and competition are related to carbon neutral and low-energy requirements; how carbon neutral and low-energy-use operations networks are planned and controlled and whether changes caused by requirements related to carbon neutrality and low energy use are value driven and cost driven. In discussing each issue, I first present replies from the interviews on carbon neutrality and low energy usage.

In the second part of this section, I analyse the interviewees' responses in terms of capabilities, scope and pace of change, effects and contents of processes, uncertainties and competition and the causal logic of firms' actions in different industries. These issues will affect the transformation of future operations networks.

Issues

Carbon neutrality and low-energy-use effects on operations. The requirements concerning carbon neutrality affect the firms' operations. During the interviews, questions arose on the origin of emissions and firms can produce goods without energy. The sources of energy need to be considered. Although it is impossible to reach carbon neutrality in terms of heating, electricity use, transports and the use of raw materials, emissions can still be reduced. Production processes and products need to be improved. However, for some firms, the investments are too large to be profitable because the price of products would become too high. An alternative to buying products would cause even higher carbon emissions due to transports. For some firms, the daily routines would be changed, whereas for other firms, the daily routines would not be greatly affected, but plant locations would have to be reconsidered. Some firms with few direct emissions are affected by indirect emissions due to product lifecycles and emissions from transports.

The requirements for low energy use in operations affect the firms' operations. The same conditions for low energy use and carbon neutrality overlap to a high degree. New technologies for products and production would need to be developed. Firms are bound to current, available production equipment. Huge investments would be needed for energy technologies that transform materials in production. Significant quality improvements would reduce energy use. Yet, many firms already implement energy-efficient practices. For firms and industries that use less energy, the changes would not be that great; the choice of electricity type for equipment and plant heating would mainly be affected. Yet, as one firm asked, how is low energy defined?

At the operations level, carbon neutrality and low energy use affect – although in varying degrees – the firms' ordinary and dynamic capabilities. Firms can make minor changes to reduce carbon emissions and to improve energy use, but major changes would need to be industry wide. Specifically, the firms agree that for radical changes, new technologies are needed. Although the firms in general agree on the issues, they also question the definitions of carbon neutrality and low energy use.

The effects of carbon neutrality and low energy use on firms. For some firms, the requirement of carbon neutrality has a large impact, as production in compliance with the requirements would not be profitable. Plants would need to be relocated or several smaller carbon-neutral plants would need to be constructed. The use of electricity, heating and transports would need to be reconsidered. Known issues would have to be considered even sooner and implemented in practice, starting with measurements. For some firms, production processes would have to be renewed, but the investments would be too great to be profitable as the prices of products would become too high. Further, if products were bought and transported, the carbon emissions would be even higher, as the same production technologies would be used by others. For one firm, some conflicts of interests exist in the choice between manufacturing in low-cost countries and emissions generated through transports. One firm would need to find new competitive advantages, as its industry in Europe would be affected, but its non-European

competitors would not be. Yet, one firm might be affected positively in comparison to its competitors due to its location.

The same conditions for the requirements of carbon neutrality and low energy use largely overlap. Such requirements would significantly affect a firm's operations. For some firms, huge investments would be needed for new technologies or significant quality improvements to reduce energy usage. Today, many firms are improving their energy efficiency. However, for one firm, the change would have to be radical enough to have a global effect.

At the firm level, carbon neutrality and low energy use mainly affect profitability. New dynamic capabilities and new system wide changes are called for. Yet, firms can specify what future actions – such as new production technologies – would have large positive impacts on their operations.

The effects of carbon neutrality and low energy use on industries. Regarding the requirement of carbon neutrality for operations, many firms reported that all firms in their respective industries are in the same situation. Today, the same production technologies are used in the same industries and significant technological development of products and processes would be required. One firm would need to find new competitive advantages, as its industry in Europe would be affected, but its non-European competitors would not be. For one value-driven firm, the firm's business model and different types of competitors would be affected. If required by customers, one firm considered that all firms would need to be able to implement the necessary changes. In one firm, the issue has not been thought of.

Respecting the requirement of low energy use for operations, many of the firms reported that all firms in their respective industries would be affected in the same way. New technologies would need to be developed and some industries would become more near-localised. Those firms that could continue to be energy efficient would not be greatly affected.

At the industry level, the firms seem to be in the same situation as the others in their respective industries. Again, production technologies can make frame-breaking, industry-wide changes. The responses differed more in terms of carbon neutrality, where new dynamic capabilities are called for in terms of competition and business models.

Changes related to carbon neutrality and low energy requirements. For most of the firms, the changes related to carbon neutral requirements would be radical in nature. Production would have to be stopped due to emissions from transports, zero-energy plants would need to be constructed and electricity would have to be changed from fossil fuels to renewable energy. Those firms whose own production was not greatly affected would be indirectly influenced by their suppliers' supply and the prices of raw materials. Yet, for one firm, these developments were already occurring due to continuous improvements for energy efficiency. In general, the firms considered energy to be the source of carbon dioxide.

For most of the firms, the changes related to low energy requirements were less radical than those related to carbon neutrality. Today, the firms are committed to continuous improvements in energy efficiency. Moreover, for many firms, the same technologies are used by all firms in the industry. Many firms related the changes more to the industry level. Specifically, the changes must be radical if they are to have an effect. New product and production methods would radically affect both industries and firms, but significant investments would also be needed.

Changes related to carbon neutrality would affect both dynamic and ordinary capabilities. They would be both local and industry wide. The changes caused by low-energy requirements would more continuous and local; the more radical changes would be system wide. Curiously, the firms consider changes caused by low energy use to be less radical than changes caused by carbon neutrality, even though the firms perceive energy to be as the source of carbon dioxide.

Uncertainties related to carbon neutrality and low-energy-use operations. In terms of the requirement of managing carbon-neutral op-

erations networks, the main uncertainties related to operations were concerned with energy sources and transports. The firms recognised that carbon dioxide stems from energy, but the availability of energy and the real costs of carbon dioxide raised questions. The respondents asked how the firms would get raw materials and energy to the zero level. Yet, one firm would become surprisingly energy neutral by changing energy sources. Another firm might not itself be affected, but its suppliers might be affected, which in turn might affect the availability and prices of raw materials. For one firm, new production technologies would need to be developed.

One firm stated that the question was too difficult, as products would have to be thought of anew. In terms of the requirement of managing low-energy operations networks, the main uncertainties related to operations were concerned with the development of new technologies and transports. The growth of costs, specifically for raw materials and transports, required new solutions for new materials, efficiency and quality. Yet, for some firms whose energy costs are proportionally low, the effect on operations would be small. One firm considered that improvements are possible to a certain point, but then something new would probably be required. For one firm, the management of a low-energy supply chain was considered to be even more challenging.

Uncertainties related to carbon neutrality and low energy use are directly affected by energy sources and transports and indirectly affected by production technologies. The changes are both local and system wide. The system-wide changes required new dynamic capabilities. Yet, some of the firms related the uncertainties to costs, that is, to process rather than content changes. The firms' future operations were rather related to the construction of new environments of predictable and unpredictable control than to changes that could be planned in given contexts.

Effects of carbon neutral and low energy on competition between networks. In relation to how carbon-neutral operations affect competition between networks; for many firms, the same situation applies to all firms in their respective industries. Yet, the causes differ between

the firms. For example, for one firm, if all firms were affected in the same way, there would be no changes to that specific firm; one firm would need to develop new business models; one firm's industry would collapse; one firm's competitors in India, China and the US would not be affected; the effect might be positive for one specific firm; the dependency on suppliers would be uncertain; some firms near large markets would have advantages; competition would be affected through customer requirements; and investments would be needed to reduce carbon emissions.

In terms of how low-energy operations would affect competition between networks, for many of the firms, the same situation applied to all firms in their respective industries. For example, if changes related to energy use were value driven, some firms would need new ways to manage operations, but if changes related to energy use were cost driven, there would not be extensive changes for the firms; if large competitors were able to invest in new production technology development, others would follow; one firm's competition would be affected, but this might provide the firm with a competitive advantage; the management of the supply chain and information from the supply chain (specifically about suppliers' suppliers) would become even more challenging for one firm; one firm's customers may make low energy usage a requirement; location would matter for some firms; and for one firm, low energy use had already been put in place to reduce energy costs.

Hence, although the firms agreed that the same situation applies in their respective industries, the causes differed in terms of the effect of carbon neutrality and low energy use on the firms. Yet, the contents of change might be positive. The changes discussed were mainly system wide, and new ordinary and dynamic capabilities were needed.

Planning and control of carbon neutral and low-energy-use operations networks. For carbon-neutral networks, some firms would very likely continue their operations as of today with minor changes, whereas others would have to find new ways to control their operations. Yet, both types of firms are location dependent on different energy types, and new solutions to transports would need to be developed. Inter-

estingly, the firms considered that the same situation applies for their entire industries.

For low-energy operations networks, for some firms, it would be possible to continue production as of today, whereas for some firms, production could not be continued as of today. Energy would have to be renewable and new production technologies would need to be found. For one firm, this also implied technological leadership. Some firms considered that the changes would affect entire industries and societies. The changes would have different impacts on different levels; for one firm (only), the heating of the plant would require reconsideration, whereas all of Finland would be affected if radical changes were put in place. For one firm, the requirement of a low-energy operations network would provide it with a competitive advantage.

In terms of planning and controlling, the pace of change is episodic in carbon-neutral operations. The energy used in production or in transports affects the scope of change for carbon neutrality. A low-energy operation network would have more impacts on the firms. The changes would, or should, be system wide, although the firms might not be affected that greatly. In general, new ordinary and dynamic capabilities would be needed. Due to the contents of change (that is, the use of energy), one currently low-energy firm would gain a competitive advantage.

Value-driven and cost-driven changes caused by requirements for carbon neutrality and low energy use. Changes caused by the requirement for carbon neutrality were mainly regarded as value driven. Over time, however, changes would become cost-driven. Some of the reasons for value-driven changes could be customer requirements, that energy would be used more efficiently in the industry and issues related to the firm's image.

Changes caused by low-energy-use requirements were regarded as value driven and cost driven. Some of the firms consider the value-driven changes to be changes that would need to affect whole societies or industries. Other value-driven reasons concerned customer re-

quirements and the whole supply chain. Cost-driven reasons related to firm-specific changes or those changes that would be international in nature. Interestingly, for radically new production technologies, one firm considered significant investments in production technologies to be value driven, but another firm considered significantly reduced production costs due to new production technologies to be cost driven.

For value-driven changes, the scope of change was radical, with system-wide, frame-bending changes. Cost-driven changes were perceived to be more related to the firm level. Yet, the reasons for changes caused by requirements for carbon neutrality and low energy use differ. Further, the reasons sometimes contradicted one another. The firms did not consider the implementation of the issues to be impossible.

Recommendations

In this second part of this section, I analyse the interviewees' replies in terms of the capabilities, scope and pace of change, effects and contents of processes, uncertainties and competition, and the causal logic of firms' actions in different industries. These issues will affect future operations networks.

Dynamic capabilities are used in regard to carbon neutrality and low energy use at the operation, firm and industry level. At the operations level, the firms can make local, minor changes to reduce carbon emissions and to improve energy use with their ordinary capabilities. At the firm level, new dynamic capabilities and new system wide changes concerning carbon neutrality and low energy use would affect the firms' profitability. At the industry level, the same situation applies in general to all firms in the respective industries, but new dynamic capabilities could be used for competition and new business models. New radical technologies are needed to generate novel ordinary capabilities at the operations level, to improve firm profitability and to make frame-breaking, industry-wide changes.

In general, even though the firms identified energy as the source of carbon dioxide, they considered changes caused by low energy usage to be less radical than changes caused by carbon neutrality. Changes

related to carbon neutrality affect both dynamic and ordinary capabilities, and would be both local and industry wide. Changes related to low-energy use are more continuous and local; the more radical changes should be industry wide. However, the firms had different explanations for how carbon neutrality and low-energy use affect their firms at the industry level.

Most interestingly, uncertainties related to carbon neutrality and low energy use are affected by energy sources and production technologies. For these uncertainties, the firms' future operations are rather related to the construction of new environments of predictable and unpredictable control than to changes that can be planned in given contexts. Both industry wide and local changes require new dynamic and ordinary capabilities, yet the firms did not consider the implementation of carbon neutrality and low-energy-use operations networks to be impossible.

The firms' reasons for changes caused by requirements related to carbon neutrality and low energy use differed from and even contradicted one another. Although some of the firms relate the uncertainties to costs, that is, to process changes, the industry-wide contents of change might be positive for some other firms. Energy efficient operations are implemented today as ordinary capabilities, and are thus less radical. Carbon-neutral operations are considered to be more value driven, as industry-wide changes would need to take place first.

The pace and scope of change differs between firms and industries and between carbon neutrality and low energy use. In carbon neutral operations, the pace of change is episodic and the scope of change is radical due to the energy used in production or in transports. In low-energy operations, frame-breaking changes should be industry wide, as many firms have already implemented energy efficiency.

From the above considerations, it is clear that carbon-neutral operations are less familiar than low-energy-use ones. Thus, carbon-neutral operations are more uncertain. The understanding of uncertainty itself will probably be the differentiating factor for firm performance in

the future. Specifically, what are the causes that explain the firms' performance in carbon-neutral and low-energy-use operation networks? Firms need to understand what carbon-neutral and low-energy operations networks really are; what the new dynamic and ordinary capabilities are; whether causes actually differ between operations networks and between industries; and how the causes explain competition. It is noteworthy that many of the firms did consider themselves to have the managerial capabilities to handle new, and in part unknown, dynamic and ordinary capabilities in new, radical, frame-breaking industries.

FUTURE RESEARCH DIRECTIONS

This explorative article studied only two aspects of sustainability: carbon neutrality and low energy use in operation networks. Future research may use different research methods to analyse how carbon-neutrality and low-energy requirements affect firms' operations networks.

A limitation of this study is that it used a small sample of only nine firms. Yet, in practice, some of the firms have very advanced data on carbon measurements and energy usage. This study fulfils its cause as an explorative study by providing insights into further research on future sustainable operations networks.

CONCLUSION

This chapter explored how two emerging sustainability issues, carbon neutrality and low energy usage for operations networks, may transform industrial firms' processes in different industrial contexts. The main insight was that when uncertainties can be found, firms may create rent-creating opportunities with dynamic and ordinary capabilities. The uncertainties are mainly due to what is really (the yet unknown) underlying logic between a firm's actions and performance in carbon-neutral and low-energy-use operations networks. Further, the firms do have different opinions on whether some issues are value driven or cost driven. Surprisingly, the firms consider that carbon neutral operations are more radical and uncertain than low-energy

use operations, although energy is classified as the source of carbons. For firms to develop new capabilities, especially for low-energy-use operations, the changes would need to be industry wide (that is, radically new technologies would have to be developed). Carbon-neutral operations will probably initiate new episodes within the firms and industries, whereas low energy usage will be more continuous in nature (that is, until radically new technologies have been developed). Further, the definitions of carbon neutrality and low energy use for operations raise concerns, and yet the managers do not doubt their managerial abilities to handle (un)predictable, but controllable operations networks.

The results of this study provide insights into how and why managers can create and maintain sustainable carbon-neutral and low-energy-use operations in future industrial contexts.

ACKNOWLEDGEMENTS

I thank the following Finnish firms for participating in this research: Efore Oyj, Fiskars Oyj, Halton Oy, Helkama Bica Oy, Kone Oyj, Marimekko Oyj, Note Hyvinkää Oy, Teleste Oyj and Vaisala Oyj. Due to privacy reasons, the names of the interviewees are not mentioned in this text. This study was funded by Tekes in Finland.

REFERENCES

- Coff, R.W. (2010). The coevolution of rent appropriation and capability development. *Strategic Management Journal*, 31(7), 711–733.
- Daft, R.L., & Weick, K.E. (1984). Toward a model of organizations as interpretive systems. *Academy of Management Review*, 9(2), 284–295.
- Delmas, M., Russo, M.V., & Montes-Sancho, M.J. (2007). Deregulation and environmental differentiation in the electric utility industry. *Strategic Management Journal*, 28(2), 189–209.
- Drnevich, P.L., & Kriauciunas, A.P. (2010). Clarifying the conditions and limits of the contributions of ordinary and dynamic capabilities to relative firm performance. *Strategic Management Journal*, 32(3), 254–279.
- Eisenhardt, K.M., & Martin, J.A. (2000). Dynamic capabilities: What are they? *Strategic Management Journal*, 21(10–11), 1105–1121.
- Grégoire, D.A., Barr, P.S., & Shepherd, D.A. (2010). Cognitive processes of opportunity recognition: The role of structural alignment. *Organization Science*, 21(2), 413–431.
- Haveman, H.A., Russo, M.V., & Meyer, A.D. (2001). Organizational environments in flux: The impact of regulatory punctuations on organizational domains, CEO succession, and performance. *Organization Science*, 12(3), 253–273.
- Helfat, C.E., Finkelstein, S., Mitchell, W., Peteraf, M.A., Singh, H., Teece, D.J., & Winter, S.G. (2007). *Dynamic capabilities. Understanding strategic change in organizations*. Malden, MA: Blackwell Publishing.
- Hult, G.M., Ketchen, D.J. Jr, & Nichols, E.L. Jr. (2002). An examination of cultural competitiveness and order fulfillment cycle time within supply chains. *Academy of Management Journal*, 45(3), 577–586.

- Hult, G.M., Ketchen, D.J. Jr, & Slater, S.S. (2004). Information processing, knowledge development, and strategic supply chain performance. *Academy of Management Journal*, 47(2), 241–253.
- Johnson, D.R., & Hoopes, D.G. (2003). Managerial cognition, sunk costs, and the evolution of industry structure. *Strategic Management Journal*, 24(10), 1057–1068.
- Nadkarni, S., & Barr, P.A. (2008). Environmental context, managerial cognition, and strategic action: An integrated view. *Strategic Management Journal*, 29(13), 1395–1427.
- Plowman, D.A., Baker, L.T., Beck, T.E, Kulkarni, M., Solansky, S.T, & Travis, D.V. (2007). Radical change accidentally: The emergence and amplification of small change. *Academy of Management Journal*, 50(3), 515–543.
- Sharfman, M.P., & Fernando, C.S. (2008). Environmental risk management and the cost of capital. *Strategic Management Journal*, 29(6), 569–592.
- Teece, D.J. (2007). Explicating dynamic capabilities: The nature and microfoundations of (sustainable) enterprise performance. *Strategic Management Journal*, 28(13), 1319–1350.
- Teece, D.J, Pisano, G., & Shuen, A. (1997). Dynamic capabilities and strategic management. *Strategic Management Journal*, 18(7), 509–533.
- Wiltbank, R., Dew, N., Read, S., & Sarasvathy, S.D. (2006). What to do next? The case for nonpredictive strategy. *Strategic Management Journal*, 27(10), 981–998.
- Winter, S.G. (2003). Understanding dynamic capabilities. *Strategic Management Journal*, 24(10), 991–996.
- Zott, C. (2003). Dynamic capabilities and the emergence of intraindustry differential firm performance: Insights from a simulation study. *Strategic Management Journal*, 24(2), 97–125.

CHAPTER 7

Servitisation in Danish Manufacturing Firms: A Strategy for Survival?

Dmitrij Slepnirov, *Aalborg University, Denmark*

Brian Vejrum Waehrens, *Aalborg University, Denmark*

John Johansen, *Aalborg University, Denmark*

ABSTRACT

This paper focuses on servitisation, i.e. the refocusing of firms from running fabrication and assembly processes to developing integrated product solutions with a large service component. The phenomenon has been recognised in the literature (e.g. Baines, Lightfoot, Benedettini, & Kay, 2009; Neely, 2008; Schmenner, 2009), and is perceived by many traditional manufacturers as a strategy for survival. Based on multiple cases of Danish companies, this paper discusses the main reasons and strategic implications of servitisation. Furthermore, it outlines the strategies for how traditional manufacturers can recoup the desired level of return from the developments associated with servitisation.

Keywords: Servitisation, global operations networks, manufacturing firms, case studies

INTRODUCTION

Manufacturing companies from the traditional industrial 'triad' of North America, Western Europe and Japan are increasingly participating in highly elaborate cross-border and interorganisational arrangements. In other words, they organise their operations in global operations networks replacing traditional vertically integrated value chain.

This shift represents one of the most identifiable trends in the manufacturing industry (Hayes, Pisano, Upton, & Wheelwright, 2005; Shi & Gregory, 2005). There is evidence to suggest that with this trend, production activities are transferred to low-cost locations and manufacturing capabilities are gradually degrading in focal companies from developed economies (Kotabe, Mol, & Ketkar, 2008; Slepnirov, Waehrens, & Jørgensen, 2010). As a result of this, these companies have been forced to search for new activities and ways to reassert themselves.

To replace degrading production competencies, many manufacturing companies in developed economies choose to refocus their attention from running fabrication and assembly processes to developing integrated product solutions with a large service component. The extent of the phenomenon varies; while some traditional manufacturers still cling to production, others redefine their business in such a way that the physical products simply become the vehicle for the revenues generating service provision. In academic literature, this trend of blurring the boundaries between traditional manufacturing and service is broadly defined as servitisation (Baines, Lightfoot, Benedettini, & Kay, 2009; Neely, 2008; Schmenner, 2009; Vandermerwe & Rada, 1988).

The idea of combining products and services is not new. According to Davies, Brady and Hobday (2006), the introduction of 'systems selling' strategies can be traced back to the 1960s. What makes the current wave of servitisation rather unique is its magnitude and that in the current climate of intensifying global competition, it is perceived by many traditional manufacturers as a strategy for survival. For example, Peter Loscher, CEO of Siemens, argues that 'Europe's future edge will depend on industrial companies pushing into services' (*Financial Times*, 2010). Accepting this premise means that in today's business environment, in addition to being producers, traditional manufacturers have to become innovators, supply chain managers and service providers, or in other words, they must become global servi-manufacturers.

Although management literature is almost unanimous in recognising the importance of servitisation for product manufacturers (e.g. Baines et al., 2009; Neely, 2008; Oliva & Kallenberg, 2003), it offers little or no an-

swers regarding the drivers and strategic implications of servitisation at the firm level. Therefore, this paper aims to explore these drivers and implications and derive propositions relating servitisation with the longer-term business sustainability of the firm.

The paper is based on multiple cases of Danish manufacturing companies. It may be argued that the reasons for servitisation, as well as its implications at the firm level, may depend on the respective company's product, manufacturing strategy or industry, to mention just a few factors. Therefore, in order to find a more consolidated view of servitisation practices used by manufacturing companies in developed economies, for this study, we choose five cases representing four different industries. The cases are investigated from the perspective of focal companies in Denmark. All five face a dilemma related to how to find a strategically viable balance between in-house production and in-house service activities.

The paper has three parts. The following section introduces the theoretical background of the study. We then proceed with the methods and the case studies used in the paper. The third section presents the analysis and discussion, before we conclude with major findings and limitations of the study.

THEORETICAL BACKGROUND

In defining *servitisation*, we adopt the definition by Baines et al. (2009), who describe it as 'the innovation of an organisation's capabilities and processes to shift from selling products to selling integrated products and services that deliver value in use'. This definition shares basic principles with the work on product-service systems (PSS) (e.g. Pawar, Beltagui, & Riedel, 2009) and is broadly in agreement with how the term was first used by Vandermerwe and Rada (1988).

Drawing on a broad array of examples, Pawar et al. (2009) find that actual manufacturing operations now account for a smaller share of profits in many traditional manufacturing firms. The provision of services is increasingly taking over fabrication processes. In discussing

the origins and rationale for servitisation, the literature commonly puts forward three sets of factors: financial/economic (services provide new stable source of revenues), competitive advantage (services are more difficult to imitate, thus providing a strategic source of competitive advantage), and marketing/demand (customers are demanding more services) (e.g. Baines et al., 2009; Gebauer & Friedli, 2005; Oliva & Kallenberg, 2003; Schmenner, 2009).

The phenomenon of servitisation has recently received a new impetus. Currently, many manufacturing companies from developed economies are actively pursuing the transition from offering products to offering combined product-service offerings, and this is not necessarily driven by only one of the factors mentioned above. Rather, they are actively pursuing the transition from products to services in the attempt to develop new higher-value activities that would substitute their manufacturing operations, which are increasingly being offshored or outsourced. To the best of our knowledge, this 'supply' driven servitisation is largely overlooked in the existing literature, and thus constitutes the focus point of the current paper.

In the face of increased competition, manufacturers from developed economies are turning their attention to high value added activities (Davis, 2004; Mudambi, 2008). Discussing the global disaggregation of the value chain, Mudambi (2008) positions three functional areas, specifically research and development (R&D; input), manufacturing (processing) and marketing (output), along the curved value chain, as illustrated in Figure 1. The curved shape of the chain is determined by differences in the value-added potential of various functional areas. According to Mudambi (2008), processing is the least value added, while the input and output ends of the chain are intensive in their application of knowledge and creativity, and thus offer a higher potential for added value. Increasing fragmentation in the value chain allows the focal company to amplify its focus on activities associated with the highest value added, while outsourcing or offshoring the processing part.

Figure 1. Globalisation and disaggregation of the value chain

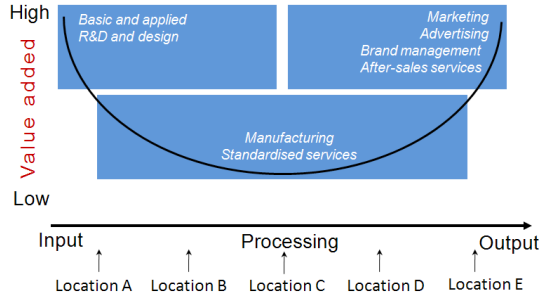

In the context of global manufacturing, a very broad spectrum of dynamic and quite distinct offshoring and outsourcing strategies can be divided into two broad categories: 1) captive offshoring and 2) offshore outsourcing (e.g., Aron & Singh, 2005; Hayes et al., 2005; McIvor, 2005; Mudambi, 2008). The category of captive offshoring refers to the process of relocating a company's activities overseas without giving up ownership and direct control. In other words, captive offshoring occurs on an in-house or 'intrafirm' basis. Offshore outsourcing, on the other hand, can be viewed as a complete or partial discontinuation of in-house domestic or in-house international activities, and thus refers to externally supplied or 'outsourced' activities. However, regardless of which of the two basic offshoring strategies is chosen, the implications for the focal lead firm are likely to be similar and include focal companies moving downstream in the supply chain (Slepnirov et al., 2010). The implications of this transition are illustrated in Figure 2.

Figure 2. Transition from traditional manufacturer to servi-manufacturer

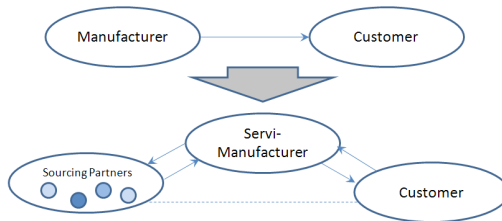

This transition should not be seen as a straightforward, linear process. Davis (2004) argues that it is important not to confuse this move downstream with simply moving into services. Rather, the transition involves the development and provision of innovative combinations of products and services based on combined manufacturing, sourcing and service capabilities that allow global servi-manufacturers to occupy a new base centred on 'systems integration'. As Figure 2 illustrates, the transition from traditional manufacturer to servi-manufacturer leads to changing relationships and the emergence of new actors. Due to the use of internal and external sources of supply by servi-manufacturer, transactions which previously involved two parties, i.e. the customer and manufacturer, now also involve sourcing partners. According to Baines et al. (2009), one of key features of servitisation is strong customer centricity; therefore, the role and involvement of customers also changing and the links with them intensify.

The transition process presented in Figure 2 is an abstraction based on the literature study and observations from practice. However, it is important to stress that it by no means represents the full complexity and practical challenges of managing servitisation. The existing literature on the subject comes short in developing a more refined understanding of position servi-manufacturers find themselves in and what enables them to remain competitive in their new role.

Another important aspect of servitisation is its degree. The literature measures it along the so-called 'product-service continuum' (Oliva & Kallenberg, 2003). The continuum is illustrated in Figure 3.

Figure 3. The product-service continuum

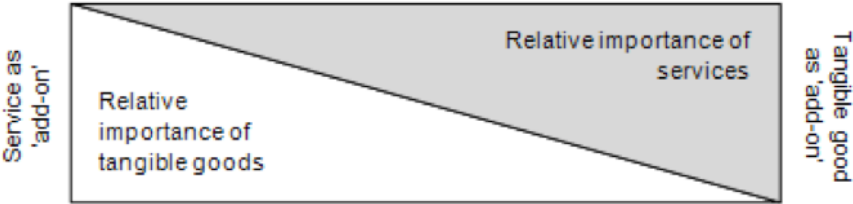

Baines et al. (2009) envision the continuum to be a dynamic area, 'with companies redefining their position over time and moving towards increasing service dominance'. However, the questions of how far companies should go and why remain unanswered.

Drawing on multiple cases of international Danish companies, in the rest of the paper we address the questions outlined in the previous sections.

METHODOLOGY AND CASE STUDIES

The empirical part of the study is based on five case studies of Danish industrial companies from four industries, including maritime, telecommunications, textile and furniture. They are currently engaged in a number of initiatives which stretch their operations on a global scale. To remain competitive, the companies are also forced to reconsider their product offerings, which are increasingly based on the integration of products and services.

The multiple-case study strategy, one of several strategies of qualitative enquiry, has been chosen for this investigation for several reasons. First, case studies can describe, enlighten and explain real-life phenomena which are too complex for other approaches requiring tightly structured designs or prespecified datasets (Voss, 2009; Yin, 2009). Second, the case study strategy is well equipped instrumentally for furthering understanding of particular issues or concepts which have not been deeply investigated so far (Eisenhardt 1989; Yin, 2009). Third, the choice of the case study strategy is based on the fit between case research and operations management (OM) (Voss, 2009), which is acknowledged but underexplored in the literature. Last but not least, multiple cases have been used in order to avoid vulnerability of single-case designs to misjudging the representativeness of a single event. In addition to enhancing external validity, the analytical benefits of having multiple cases are significant (Voss, 2009).

Despite exhibiting many advantages, case study research also has several pitfalls and poses significant challenges (e.g. Meredith, 1998). First,

there is the problem of the observer's perceptual and cognitive limitation. Second, a high probability of overlooking some key events also constitutes a threat to the quality of case studies research. Third, case studies are exposed to the challenge of generalisability. Fourth, the accuracy of some inferences can be undermined by the reliance on intuition and subjective interpretation of an investigator.

To address these challenges and formulate a research design of high validity and reliability, we followed practical guidelines and steps discussed in qualitative methodology literature (e.g. Voss, 2009; Yin, 2009). The current research relied on extensive use of triangulation and research protocol. Multiple sources of evidence (semistructured interviews, documents and on-site observations), as well as the triangulation of multiple data points within each source of evidence (e.g. multiple respondents at the top and middle management levels), were used. These data, combined with secondary material (annual reports, media material, presentation material to customers and stakeholders), were used to build the cases database presented below in Table 1. All the cases were followed intensely by the authors in December 2009–May 2010. Some events relevant to the study also were captured in retrospect.

The number of cases deemed sufficient for the study was decided through a discretionary judgmental process. According to Yin (2009), because sampling logic is irrelevant to the multiple-case study design, the typical criteria regarding sample size do not apply either. Instead, this matter was approached as a reflection of the number of case replications that would satisfy the desired level of theoretical saturation of the study. Achieving a higher degree of certainty about the propositions of the study also played a role in deciding the number of cases. The cases overview is provided in Table 1.

Table 1. Overview of case companies used in the study

Company	Boilers	Engines	Satellite	Proftex	Chairs
Industry	Maritime	Maritime	Telecom	Textile	Furniture
Core product	Marine boilers	Development and licensing of diesel engines production	Equipment for mobile communication	Furniture fabrics and related textile products	Designer furniture
Ownership	Private Equity Fund	Group Owned	Public company	Public company	Holding owned
Established	1987	1980	1981	1850 (1986)	1872
Employees, 2008	2763	8000	700	117	279
Turnover (DKK m)	3371	19000	1253	280	657
Oper. profit (DKK m)	476	2900	188	23	102
Operations set-up attributes	75% of operations are offshored to key markets	95% of operations at external licensees abroad	60% of operations outsourced domestically and abroad	100% offshore outsourcing Minority stake in offshore production sites	65% of operations outsourced overseas
Risks, Threats and Challenges related to operations set-up	<ul style="list-style-type: none"> Risks of vertically integrated firm 'Too many eggs in the Chinese basket' 	<ul style="list-style-type: none"> IPR protection in the licensing model Knowledge sharing with licensees 	<ul style="list-style-type: none"> Brand vulnerability in the outsourced network Avoiding over-standardization of products and processes Search of new strategic partners 	<ul style="list-style-type: none"> Maintaining knowledge about production Management of multiple dynamic relationships Org. identity split between service and manufacturing 	<ul style="list-style-type: none"> Brand vulnerability High fragmentation High requirements for communication, coordination, information flows
Main role of lead site	R&D, coordination of global operations, sourcing	R&D, licensees support, network coordination	R&D and operations network coordination	Operations network coordination, R&D and innovation	Operations network coordination, design and distribution development
Service element of product offering	Product related services, collaborative development and after sales support	Collaborative development projects and service network	After sales support and product related services	Collaborative development, match-making services for main customers	After sale support, collaborative development and innovation

DISCUSSION AND IMPLICATIONS

There are several servitisation-related drivers we can distil from the cases presented above. First of all, as the price competition increased, companies faced the challenge of how to reorient the domestic in-house resource and competencies base to higher value adding activities. Some reorientation happened as a result of offshoring and offshore outsourcing of manufacturing operations activities. Resources that could be utilised for high-value activities were freed up. Referring to the smiley of the value chain introduced in Figure 1, these higher-val-

ue activities are likely to be found in the input and output parts of the chain, where the service element of the business is also more likely to occur. Therefore, the manufacturing offshoring and outsourcing trend encapsulates one important servitisation driver we observed in all the cases. Its origins are illustrated in Figure 4, where the thickness of the line and dark areas represent focus areas of focal organisations in the cases and how they change over time.

Figure 4. Offshoring and offshore outsourcing trend in the cases

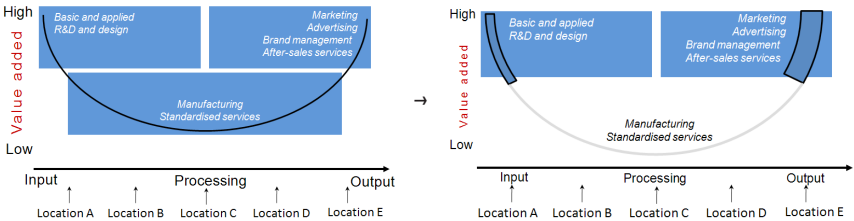

Although there is also some evidence to suggest that the offshoring and outsourcing trend affected higher value added activities, the propensity to offshore these activities remained lower than the propensity to offshore manufacturing activities.

One significant challenge faced by the case companies was related to the manufacturing operations, which remained at the home base. These activities left in-house domestically were commonly related to the core business processes; nevertheless, over time, they were increasingly marginalised, and therefore received less management attention, fewer investments and less development effort. This marginalisation was partly driven by the loss of operations-based significance within the internal manufacturing network, and partly by the loss of significance vis-à-vis emerging strategic agendas within the company. In this situation, the companies found themselves in a position where they became more oriented towards context knowledge (facilitating processes, identifying and managing sourcing partners) and less oriented towards production content knowledge (knowledge about what actu-

ally goes on in production). This was particularly prominent in organisations where the fitness of the operations function had traditionally been placed in the hands of corporate functions (e.g. the Satellite case) or where top management represents a nontechnical perspective on the business (e.g. the Chairs case), both of which had little regard for the strategic impact of manufacturing operations.

The cross-case analysis also showed that servi-manufacturers can have very different approaches to developing and managing service component of their business. All case companies found themselves on a journey from the pure manufacturing-oriented company to a company: 1) with services to support the product (service as a cost centre); 2) with services to extend the product (service as a strategic focus area); and 3) with full-service operations where service outweighed the product and the product role was reduced to its order qualifying properties (Figure 5).

Figure 5. Servi-manufacturers' profile continuum

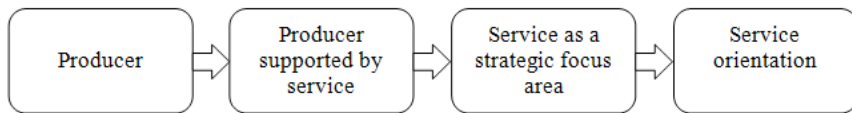

Although the case companies can be positioned at different points along this continuum, there is strong support to suggest that all of the cases have gravitated towards the service orientation. This finding supports Olivia and Kallenberg (2003) findings that moving along the product-process continuum is a dynamic process, 'with companies redefining their position over time and moving towards increasing service dominance'. Our study also shows that the companies which retained a strong manufacturing base in-house or sought competitive advantages through operations, and thus maintain strong operations capabilities, generally found it more difficult to integrate products and services beyond seeing services as an extension to the product.

The roles of management profile and mind set were also found to be strong factors determining the position of the company, as well as its developmental trajectory. Management resources are scarce in most organisations, and the engagement with a running operations system consumes attention and focuses it on the efficiency of the existing apparatus. On this basis, we find strong support for the argument that the effective management of servi-manufacturers demands attention to the interlinked issues of mind set and organisational identity (Pratt & Foreman, 2000; van Rekom et al., 2008; Voss et al., 2006). The profiles of global servi-manufacturing cases seemed to include multiple organisational identities, which were associated with both the mind set of a traditional manufacturer as well as the mind set of a service organisation. However, while the service mind set was continuously strengthened at the home base, the manufacturing mind set – along with manufacturing capabilities – was pushed offshore, generating a number of conceptual and operational conflicts between these different foci.

For companies which had retracted themselves from upholding a strong manufacturing capability in-house (e.g. the Proftex and Engines cases), the service provision and 'systems selling' strategy became a natural choice. In other words, for them, servitisation emerged as the new strategic agenda, and with this, management attention naturally drifted towards seeing the product as one of many components in the total offering. Providing additional services to accompany the sale of products was increasingly central to the strategies of the companies, and this was reflected in a growth in importance of services and a general trend away from a 'pure product' orientation towards an integrated offering.

According to Schmenner (2009), the bundling of manufactured goods to downstream-available services is led by companies with relatively new products but with no great manufacturing capabilities. Servitisation provides them with an opportunity to develop unique offerings without committing to an extensive in-house operations base; on the other hand, companies with significant manufacturing capabilities are quite slow and defensive, and struggle to achieve a complete in-

tegration of manufacturing and service. Our study shows that this compensation strategy is also at work within companies with a strong manufacturing base, which have relocated manufacturing activities to offshore destinations due to competitive pressures. This happens as managerial resources and attention are freed-up and can be reasserted in relation to new activities. Here it is obvious that companies turn to marketing the capability that their products bring. Thus, for example, the engine manufacturer markets a stable and reliable supply of power to denote its ability to sell propulsion capability rather than an engine itself. However, this transformation requires a capability set which is not that distant from the historical manufacturing capabilities. Slack, Lewis and Bates (2004) argue that 'the ability to do this requires the co-ordination of manufacturing systems, maintenance systems, spare parts supply systems, logistics systems, and so on. These individual operations processes need to be integrated in the same way as the physical systems that make up its products have been integrated. Again, the underlying technical knowledge on which products themselves have been developed over the years has become significantly relevant in the development of the operations processes that enable them to be delivered into the market. But, this depends on the application of these ideas into a practical business context'. Now the companies were left with the challenge of sourcing these capabilities and knowledge from a network of globally dispersed activities, some of which remained in-house while others were externalised. This adds another relational layer to traditional supply chain thinking which has evolved around the flow of goods and services.

In spite of clear strategic intents supporting this transition, the approach tends to be incremental, and to a large extent building, companies are the operational bridge as they walk on it. While a whole series of incremental decisions, may make economic sense taken individually, they may collectively represent the surrender of the company's capability to compete in new markets, as they largely compete based on historical operations-based capabilities. This can, for example, be observed in the case companies through their capability to contract and manage relationships with suppliers to meet order qualifying standards, but also in their capability to meet specific order winning market

demands. In spite of the emerging service orientations, it remains true that all case companies relied on the companies' capability to supply world-class product solutions as a condition for the service provision itself, as well as a source of strategic legitimacy in the market.

The position of the company on the continuum in Figure 4 can also be linked with the nature of services being offered. In cases where services just support the product, we could see trends to offer products accompanied with a one-off service (e.g. design and configuring products to customer demands), while in the cases seeing services as a strategic focus area or having a strong service orientation service 'through-life' was offered (e.g. in some contracts in maritime boilers and engines).

To illustrate, in the Boilers case, the company developed a strong service orientation in the boiler segment. Being able to service their customers in any major harbour around the world is an order winner for Boilers, which has been difficult to match by competitors:

We have concentrated a lot of our resources on developing our after-sales business – we are very pleased with this today, since we all know that the demand for new boilers will decrease and the demand for after-sale service will go up. We have a strong position on the after-sale business.

In the pursuit of growth, Boilers has increasingly focused its resources on the after-sale service division. This is not only due to the market conditions, where very few orders are received from shipping operators, but also to exert more direct control over the end customers. As a manager at Boilers noted:

We base our delivery of new boilers on a good service package. We can do this on a large proportion of our deliveries, but there are parts of the service, e.g. exchange of a boiler tube, that are not unique enough for us to withhold a strong position. Or at least historically it has not been that way. We need to earn money on both things and look at them independently. But of course we try to sell a service contract with

each of our deliveries, and with that a spare-part package and things like that.

For Sattelite services was also a predominant factor on the demand side of the company's business:

If the sufficient service is not provided, sales tumble. This element is build into the product and the way they are produced. The service department monitors and supports all service partners to ensure quality of services to customers.

This example also demonstrates that in addition to the perspective on servitisation as 'new manufacturing', the cases also tended to use services for differentiation purposes in competitive marketplaces and as a potential lead to additional demand for products.

The Engines case operated primarily in two interrelated business areas: 1) sale of licenses and 2) services, including sales of repair parts and technical services. The firm has turned its focus from production of engines to servicing the customers:

Due to shifting conditions in the ship market, we are producing fewer engines, and therefore expect that the service part will become more influential and that this business will count for 50% of total income.

One of the reasons for Engine's high market share was its large service network. The competitors had difficulties in offering the ship owners the same global service agreement. The company had around 70 engineers travelling the world and following up on new constructions, a capacity which competitors could not match. Furthermore, they provided the engineers in Denmark and the licensees with feedback on the issues at hand, thereby enabling optimisation of the product. This case illustrates the importance of new emerging relationships in the service-based environment, where in addition to the traditional manufacturer and customer, the system also included licensees.

CONCLUSIONS

The purpose of this paper was to provide empirical insights into the trend of servitisation and discuss the drivers and strategic implications of servitisation at the firm level. Based on multiple cases of Danish international companies exposed to servitisation, the paper addressed issues related to the conceptual move from product-driven operations to service-driven operations, which has so far received limited attention in the OM literature.

We specifically focused on 'supply'-driven servitisation, the type of servitisation which is largely overlooked in the existing literature. This is concerned with traditional manufacturing companies from developed economies actively pursuing a transition from products to services in the attempt to develop new higher-value activities that would substitute for their manufacturing operations, which are increasingly being offshored or outsourced.

The paper provided conceptual and practical insights into how servitisation is used by manufacturing firms and what the main drivers and impediments of this practice are. It also demonstrated how managerial attention to servitisation can help to resolve some of the pressing challenges and dilemmas of contemporary manufacturing firms, namely, how a focus on integrated product-service solutions helps global servi-manufacturers to remain in tune with fabrication processes, even though these processes may be outside the boundaries of the company. The study also showed that the profile of a global servi-manufacturing firm is associated with multiple organisational identities. These include both the mind set of a traditional manufacturer and the mind set of a service organisation. Such complexity and dynamism of the organisational identity of global servi-manufacturers have to be recognised and effectively managed if the potential synergies of this type of firms are to be realised.

The study covered the broad contours of the role of servitisation, as well as its strategic implications. While the results are highly suggestive, the significant limitations of the analysis should be noted. First, there are several methodological imperfections in this study. It is ex-

posed to the usual limitations associated with the use of one method rather than a multi-method approach. The second obvious limitation of the study is in its geographic delineations. Because Denmark was chosen as the main empirical base of the investigation, not all results may be transferable to other countries. Although some generalisable parallels may exist, the best way to find out which findings are country specific is to replicate the study elsewhere. The same limitation applies to the industrial base of this study. Although the cases were drawn from several industries (i.e. maritime, textile, telecommunication, furniture), future research should include studies from other industrial sectors.

REFERENCES

- Aron, R., & Singh, J.V. (2005). Getting offshoring right. *Harvard Business Review*, 83(12), 135–143.
- Baines, T.S, Lightfoot, H.W., Benedettini, O., & Kay, J.M. (2009). The servitization of manufacturing: A review of literature and reflection of future challenges. *Journal of Manufacturing Technology Management*, 20(5), 547–567.
- Davies, S. (2004). Moving base into high-value integrated solutions: A value stream approach. *Industrial and Corporate Change*, 13(5), 727–756.
- Davies, A., Brady, T., & Hobday, M. (2006). Charting a path towards integrated solutions. *MIT Sloan Management Review*, 43(7), 39–48.
- Eisenhardt, K.M. (1989). Building theories from case study research. *Academy of Management Review*, 14(4), 532–550.
- Ferdows, K. (2008). Managing the evolving global production network. In R. Galavan, J. Murray, & C. Markides (Eds.), *Strategy, innovation, and change: Challenges for management* (pp. 149–162). Oxford: Oxford University Press.
- Gebauer, H., & Friedli, T. (2005). Behavioural implications of the transition process from products to services. *Journal of Business and Industrial Marketing*, 20(2), 70–80.
- Hayes, R., Pisano, G., Upton, D., & Wheelwright, S. (2005). *Operations, strategy and technology: Pursuing the competitive edge*. Danvers: Wiley.
- Jahns, C., Hartmann, E., & Bals, L. (2006). Offshoring: Dimensions and diffusion of a new business concept. *Journal of Purchasing and Supply Management*, 12(4), 218–231.
- Kotabe, M., Mol, M.J., & Ketkar, S. (2008). An evolutionary stage model

- of outsourcing and competence destruction: A triad comparison of the consumer electronics industry. *Management International Review*, 48(1), 65–93.
- Meredith, J. (1998). Building operations management Theory through case and field research. *Journal of Operation Management*, 16(4), 441–454.
- Mudambi, R. (2008). Location, control and innovation in knowledge-intensive industries. *Journal of Economic Geography*, 8(2), 699–725.
- Neely, A. (2008). Exploring the financial consequences of the servitization of manufacturing. *Operations Management Research*, 1(2), 103–118.
- Oliva, R., & Kallenberg, R. (2003). Managing the transition from products to services. *International Journal of Service Industry Management*, 14(2), 160–172.
- Pawar, K.S., Beltagui, A., & Riedel, C.K.H. (2009). The PSO triangle: Designing product, service and organisation to create value. *International Journal of Operations and Production Management*, 29(5), 468–493.
- Relocated labels. (2010, 1 September). *Financial Times*, 7.
- Schmenner, R.W. (2009). Manufacturing, service, and their integration: Some history and theory. *International Journal of Operations and Production Management*, 29(5), 431–443.
- Shi, Y., & Gregory, M. (2005). Emergence of global manufacturing virtual networks and establishment of new manufacturing infrastructure for faster innovation and firm growth. *Production Planning and Control*, 16(6), 621–631.
- Siemens seeks to stay ahead of Asian competition. (2010, 25 March). *Financial Times*, 17.

- Slack, N., Lewis, M., & Bates, H. (2004). The two worlds of operations management research and practice: Can they meet, should they meet? *International Journal of Operations and Production Management*, 24(3-4), 372-387.
- Slepniov, D., Waehrens, B.V., & Jørgensen, C. (2010). Global operations networks in motion: Managing configurations and capabilities. *Operations Management Research*, 3(3-4), 107-116.
- Vandermerwe, S., & Rada, J. (1988). Servitization of business: Adding value by adding service. *European Management Journal*, 6(4), 314-324.
- Voss, C. (2009). Case research in operations management. In C. Karlsson (Ed.), *Researching operations management* (pp. 162-196). New York: Routledge.
- Warburton, D.H.R., & Stratton, R. (2002). Questioning the relentless shift to offshore manufacturing. *Supply Chain Management: An International Journal*, 7(2), 101-108.
- Yin, R.K. (2009), *Case study research—Design and Methods*. Thousand Oaks, CA: Sage.

CHAPTER 8

Designing an Operations Network

Aki Laiho, *Aalto University, Finland*

Marja Blomqvist, *Aalto University, Finland*

ABSTRACT

This chapter discusses the challenge of operations network design in a global operating environment. The design process is often related to a substantial change in business, specifically strategy change, restructuring or expansion. Proper identification of the factors that need to be taken into account is critical for a successful process. The research is built around case research with five Finnish small and medium-sized enterprises (SMEs) and a parallel literature review. We identify a set of factors through literature study and empirical case research, and introduce a design framework with two categories of design factors: direct design factors and mediating design factors.

INTRODUCTION

Globalising companies cannot avoid facing a situation where the operations network (manufacturing, distribution, sourcing) needs to be restructured or expanded in order to fit with new, global business environment and a related strategy. The need to (re)design an operations network is often related to substantial changes in business or in the operating environment. Typical examples of such changes are the following:

- A change in company strategy, organisation or leadership which sets a company in a new direction;
- Rapid expansion of business, entry into new businesses or new market areas;
- Need for rationalisation, e.g. after a merger or an acquisition;
- Change in the business environment causing external pressure for a company, for example, the emergence of new competitors or a recession.

Design questions are typically discussed within the domain of manufacturing strategy (e.g. Voss, 2005), international manufacturing networks (Ferdows, 1997) or as a question of supply chain design (Childerhouse & Towill, 2000). The design process includes several long-term strategic decisions, e.g. location decisions, make or buy analysis and decisions, plant focus and plant role decisions and technology, as well as planning and control system definitions.

In general, the network design process targets a good fit between the business requirements and the capabilities of the operations. In order to achieve the fit, it is mandatory to identify and articulate the business requirements, i.e. input factors for the network design, in an explicit and consistent way. However, companies struggle with finding a structured approach for the design of their operations networks. The critical question is what factors to include in the decision process. Identification of the factors and capturing of consistent input data is thus a crucial early step in the design process.

This chapter is built on recent case research with five Finnish small and medium-sized enterprises (SMEs) which are all facing a need to restructure their operations networks. The design situations of the case companies can be categorised into three logical categories: 1) improvement of competitiveness through improved utilisation of the global network and global resources; 2) improved competitiveness through more focused, differentiated resource combinations (improved fit); and

3) international expansion to reach new markets, customer groups or geographical areas.

In the results, we identify the main drivers to consider and mediating factors in the design process. Furthermore, we present a model for operations network design. It assumes that operations network design is conducted as a stepwise conscious action, and consists of a set of design criteria as well as a set of moderating factors for the design. As a conclusion, we introduce a framework which can be used to capture the design drivers for operations networks.

BACKGROUND: PERSPECTIVES ON OPERATIONS NETWORK DESIGN

In this section, we will look into three different domains: manufacturing and operations strategy, plant roles in factory networks and supply chain management. We will discuss each domain in relation to key decisions of the operations network and the main factors affecting the operations network design.

The significance of manufacturing and operations within the overall context of corporate strategy was recognised and brought to wide attention by Skinner (1969, 1974; Riis et al., 2007). It was clearly recognised that within manufacturing, some key decisions and tradeoffs such as plant location and make-or-buy decisions impact the company's overall success, and these should be aligned with the corporate strategy (Hill, 1993; Skinner 1969, 1974). It was argued further that not only should the operations strategy support the corporate strategy, but competitive advantage could also be achieved through manufacturing (Hayes & Wheelwright, 1984). Voss (2005) discussed different paradigms within operations strategy, concluding that there are three such paradigms, which are complimentary: competing through manufacturing, strategic choices in manufacturing and best practices in manufacturing.

Several manufacturing decision areas with individual decisions that are strategic in nature were already recognised in the early work of Skinner (1969): plant and equipment (decisions like make or buy, plant

size, plant location); production planning and control (inventory size and control, quality control and use of standards); labour and staffing (job specialisation, supervision and wage system); and product design/engineering (size of product line and design stability). Hill (1985) further grouped the decisions into process and infrastructure choices and added aspects such as organisational structure and capacity timing. These decisions can yield indefinitely different combinations of factory setups. A more 'overall' decision thus becomes a decision about factory focus. The underlying idea presented by Skinner (1974) is that a factory which focuses on a narrow product mix for a particular market niche will outperform the conventional plant, which attempts a broader mission. Focused factories can thus be seen as a link between the manufacturing facilities and the competitive approach, enabling companies to gain greater control of their competitive position (Hill 1985). Skinner recognises five key characteristics of focused factories: process technologies, market demands, product volumes, quality levels and manufacturing tools. Moreover, Hill (1985) identifies three different focus possibilities: based on products/markets (marketing view), based on processes and based on different order winners. The focus of a factory may change during the lifecycle of a product, and the factories may also have lifecycles themselves (Hill, 1985; Schmenner, 1983).

In Skinner's work (1969), the starting points for the strategic decisions in manufacturing were corporate strategy and competitive situation in the market, as well as the available skills, resources, etc. in the company. Hill (1985) adds a strong emphasis on the customer by introducing the concepts of order qualifiers (aspects of the product or service that need to be at an acceptable level in order to qualify for purchase) and order winners (the aspects of the product that 'win' the purchase). Several order qualifier or winner criteria, such as delivery time and quality, can be influenced by the operations. The customer view has also been discussed through the different methods of competing; for example, Treacy and Wiersema (1993) classified three value disciplines, i.e. ways to compete, which all require a different operational setup: customer intimacy, product leadership and operational excellence.

Manufacturing decisions are also driven by the relationship between a product and a process. The framework of Hayes and Wheelwright (1979) combined the volume and variance of the products produced into a matrix classifying different production process types. Although this model has been criticised to be more of a descriptive model than a strategy (Schmenner & Swink, 1998), it has been widely recognised to represent the process choice relevant to operations strategy. Schmenner and Swink (1998) further enhance the matrix by adapting the axes to more generally incorporate demand variability (timing, quantities or customisation requirements) and speed of flow, which as variables would affect the choice of production process.

PLANT ROLES IN FACTORY NETWORKS

The background for different factory roles in a network is the increasing globalisation of production, which is driven by both new markets and new lucrative opportunities for production and sourcing (Ferdows 1989, 1997; Riis et al. 2007). A starting point for the discussion of factory roles is Ferdows' work (1989) on international factory networks and factory roles. Ferdows (1989) recognised three major reasons for setting up a factory at a specific location: proximity to the market, access to low cost production input factors and use of local technological resources. Combining the reasons for the existence of a factory with the activities and competences of a site, he suggested six different roles for international factories. Later, Johansen and Riis (Johansen & Riis, 2005; Riis et al., 2007) contributed to the discussion by both identifying further different roles of manufacturing units and also recognising different approaches to networking by a company. The communication aspect within the factory network has been emphasised by Vereecke et al. (2006), whose role typology is based on the knowledge transfer between factories and headquarters.

The different sets of factory roles in the models can also be seen as descriptive models. However, implicit decisions are also involved, especially if the roles are a result of conscious actions rather than natural evolution. Ferdows (1997) emphasises the development of roles with a tendency of the roles with less significance to develop towards a lead

factory role. Riis et al. (2005, 2007) also discuss the structure of the network as a set of different role combinations, yielding to the different roles the whole company with its operations network can take in the supply chain. Vereecke et al. (2006) note that in order to form a balanced network, different roles are needed, and that the feasible location of a plant is influenced by the role it plays: Plants with lower information exchange intensity are usually sustainable only in low-cost countries whereas the high-intensity roles typically are located in proximity of corporate headquarters.

ALTERNATIVE SUPPLY CHAIN TYPES

Supply chain management as a concept captures a broad range of activities: planning and management of all activities involved in sourcing and procurement, conversion, demand creation and fulfilment and all logistics activities. Discussion of the differences between different supply chains and their fit to the requirements was initiated by Fisher (1997), who identified the problem of how to build the right supply chain for a particular business situation. Often, changes in supply chains are substantial in terms of time and money spent. Supply chain design is defined as choosing what capabilities along the value chain to invest in and develop internally, and which to allocate for development by suppliers, can be seen as an ultimate core competency of an organisation (Fine, 2000).

Fisher (1997) classified products according to the nature of their demand into two different categories: primarily functional and primarily innovative. Fisher further argued that the supply chain should be matched with the characteristics of the product: functional products require efficient supply chains, and innovative products responsive supply chains (Fisher, 1997). Lee, Padmanabhan and Whang (1997) added supply uncertainty as a factor for differentiated supply chains. Childerhouse, Aitken and Towill (2002) discuss the concept of focused factories applied on a supply chain level and propose five criteria for differentiation: demand variability, responsiveness of the order cycle, product variety, product annual demand volume and length of lifecycle. Christopher et al (2006) instead proposed that three dimensions

are sufficient for pipeline selection: products (standard or specific), demand (stable or volatile) and replenishment lead times (short or long). Further attributes appearing in the literature are, for example, product lifecycle, its expected duration and the phase the product is currently in (Aitken et al., 2005; Christopher & Towill, 2000); technology included in the product (Lee, 2004); characteristics of demand information, i.e. visibility, predictability and variability (Aitken et al., 2005; De Treville, Shapiro, & Hameri, 2004; Lee, 2004); and the company's own strategy on the customisation of its offering (Lampel & Minzberg, 1996).

The design decisions leading to different supply chain configurations relate to the structure and control practises of the chain: number of echelons in the supply chain and their location, management practices of the material flow (Christopher et al., 2006), location of order penetration point and value offering point (Holmström, Hoover, Louhiluoto, & Vasara, 1999; Olhager, 2003), approach to flexibility, lead time and postponement (De Treville et al., 2004; Lee, 2004; Naylor et al., 1999) and supplier selection and relationship management (Gelderman & van Weele, 2005; Lee, 2004). Furthermore, many of the decisions already recognised in operations strategy such as make or buy and facility location are also relevant to the intended supply chain type.

Table 1 summarises the input factors for comprehensive operations network design that can be identified in the literature. The grouping of the factors emerged during the empirical study and has been developed iteratively based on the approaches used in the case companies.

The concept of strategic fit has served for a long time in the strategic literature. Fit, however, has several definitions. Venkatraman (1989), for instance, identifies six distinct perspectives of fit as a function of specificity as well as whether the specification is criterion specific or criterion free. Following the definitions, we consider fit to potentially take place between multiple antecedent and consequent variables (design factors, factors of competitiveness) and the overall setting being potentially affected by significant intervening mechanisms.

Table 1: Literature review: Factors for design of an operations network

Group	Detail	Source
Strategic factors	Corporate strategy: how company competes	Skinner 1974, Treacy & Wiersema 1993
	Decision about markets company decides to compete in	Skinner 1974, Hill 1985
Competitive situation	Expected growth	Hill 1985
	Competitors (number and location of the plants)	Skinner 1969, 1974
Product	Speed of change in the market	Hill 1985
	Differentiation of market requirements	Skinner 1974, Hill 1985
	Industry related factors (such as barriers to entry, rate of technological change, location of know-how etc.)	Hill 1985, Ferdows 1989
	Product uniqueness / variability (standard or customized)	Hayes & Wheelwright 1979
	Way to create variance (postponement/modularity approach; level of standardization)	Naylor et al 1999, de Treville et al 2004
	Duration of product life cycle	Fisher 1997, Aitken et al 2005
	Stage of product life cycle	Jüttner et al 2006, Christopher et al 2000
	Speed of NPI / new product ramp-up	Fine 2000
	Quality	Skinner 1974, Hill 1985
	Demand	Demand volume
Demand variability		Schmenner & Swink 1998
Demand timing		Schmenner & Swink 1998
Need for flexibility in volumes		Hill 1985
Predictability of demand		De Treville et al 2004
Markets requirements for delivery	Visibility to demand	De Treville et al 2004
	Delivery speed	Hill 1985
	Reliability of delivery	Hill 1985
	Flexibility (of volumes, lead times etc.)	Christopher et al 2006
Supply	Quality	Hayes & Wheelwright 1979
	Location of the market	Ferdows 1989, 1997
	Other special logistics requirements	Christopher et al 2006
	Location of suppliers	Christopher et al 2006
Current capabilities of the company	Supply lead times	Christopher et al 2006
	Supply uncertainty	Lee et al 1997
	Current core competences	Skinner 1974
Current resources (setup of the network / supply chain)	Competence gap to capabilities required by strategy	Skinner 1974, Treacy & Wiersema 1993
	Number of plants	Skinner 1969, 1974, Hill 1985
	Number of echelons in the supply chain	Christopher et al 2006
Financial aspects	Locations	Skinner 1969, 1974, Hill 1985
	Roles of the plants in the network	Ferdows 1989, Riis et al 2007
	Combination of the roles in the network	Riis et al 2007, Vereecke 2006
	Integration & communication between the plants	Vereecke 2006
Financial aspects	Market price	Hill 1985
	Manufacturing cost	Ferdows 1989
	Total supply chain cost (other than manufacturing)	Christopher et al 2006
	Expected margin	Hill 1985
	Investment requirements	Hill 1985

How to design an operations network: Lessons from five Finnish manufacturing companies

For Scandinavian companies, the ability to design global operations networks, including both own and outsourced operations, is in most cases a mandatory precondition for growth. The domestic markets are small; growth, access to larger customer bases and access to the resources and competencies of global supply market often require expansion of operations across different regions. We conducted an in-depth analysis of five recent industrial cases where companies, facing

such situations, were designing their global operations networks. The companies (all pseudonyms) and industries included are CommTech Inc. (electronics), Design Inc. (branded consumer goods), Wired Inc. (components for the marine industry), Measure Inc. (electronics) and FreshAir Inc. (components for buildings).

Common to all five case companies is the need to systematically design their global operations network. All the case companies are mid-sized, globally operating manufacturing companies with their own products.

CommTech Inc.

The overall motivation for CommTech Inc. to reconsider its operations network is improvement of global competitiveness. The company operates at several locations, mainly in Europe and Asia, and during its 50 years of history it has grown and expanded to a globally operating manufacturer and a technology leader within its own niche segment. The globalising business environment affects CommTech in two ways: Its main competitors are global, and are typically significantly larger. At CommTech, the design centres on a balance between maximising agility and customer service, which are considered strategic advantages, and cost efficiency through the utilisation of global resources. Proximity and integration can be identified as central themes in design from the following perspectives:

- Proximity to customers to maintain agility and short lead times;
- Proximity between research and development (R&D) and manufacturing to speed up product tailoring and new product introduction;
- Proximity with supplier base (in China);
- Integration of the overall supply chain to improve effectiveness and minimise end-to-end lead times.

Design Inc.

The Design Inc. operations network design initiative is driven by the growth and internationalisation targets which the new ownership of the company has set. The company has operated on a rather domestic basis, with three own factories supported by rather extensive international sourcing activity. The international growth prospects affect the company in several ways:

- The distribution network of the company is challenged with requirements from new markets and customer segments;
- The new product segments generated need to review sourcing approaches and supplier network structure and management;
- The rapidly increasing complexity of product and customer portfolios drive towards rationalisation and streamlining both internally as well in the operations network structure and management.

Wired Inc.

Wired Inc. faces a very typical question for an internationalising company: How can a new plant be properly accommodated into the operations network? Originally, the new plant was established to serve the marine industry in Asia. However, as a natural question, Wired Inc. is also reconsidering its overall network, looking for ways to utilise the new manufacturing capability for global purposes. The identified drivers affecting the network design are as follows:

- Location of both the customer and supplier base. The heavy products and raw materials make transportation cost and time a significant factor;
- The competitive strategy includes high flexibility and high level of service – this emphasises the proximity to customers as a key criterion;
- The share of labour cost is relatively low, but transportation

cost and equipment investments are important cost factors, leading directly to consideration between globally centralised and decentralised manufacturing capacity as a design driver.

Measure Inc.

With Measure Inc., the driver for reconsideration is very strategic. The way in which the company is structured business-wise has recently changed, and consequently, it has started to differentiate its operations network according to customer-oriented business segments. Structurally, the company is moving from a monolithic operations network to multiple, segmented and differentiated subnetworks. Consequently, the main factors affecting the design are customer and demand oriented, as follows:

- Nature of the business, whether the product business, project or solution business form the main logic;
- A broad range of customer values requirements, ranging from exact requirements like delivery lead time to added-value services like VMI and overall characteristics of a relationship;
- Volume, nature and predictability of demand, affecting the opportunities to utilise e.g. offshoring locations.

FreshAir Inc.

The business driver for FreshAir Inc. for an operations network design comes from the need to enter a new market area. Consequently, the main factors affecting the design are relatively close to the other cases, oriented around customer and market requirements and preferences. However, with FreshAir Inc., the importance of competences and risk management set the limits for possible solutions in a visible way, as follows:

- Strategy and common customer requirements are the main factor affecting the design;
- Demand characteristics are not too well known – this fact, to-

gether with the emerging market and market-making activities, drives towards solutions where the demand must be considered as unpredictable and strongly fluctuating;

- The limited in-house competences of global operations together with unknown competitiveness in the new market are guiding towards operations network structures where risk is limited, scalability can be achieved and external (supplier) competences can be utilised.

The case companies' characteristics are summarised in Table 2 below.

Table 2: Summary of the cases

Case company	Basic data	Operating model	Design Situation
CommTech Inc.	European-centric international electronics manufacturing, installation and service company. Publicly listed, three manufacturing locations, revenue approximately 100MEUR (2009), 1200 employees.	The case company is operating in three different business segments: 1) electronics component manufacturing, supplying self-developed high technology components to different installations of telecommunications infrastructure 2) system/project deliveries, consisting of demanding infrastructure solutions 3) supplementary 3rd party products used in particular as components in installation projects and spare parts in maintenance	In order to improve the competitiveness globally, the case company is revisiting its strategy for global operations networks, including also locations, make/buy questions and network design. The company has two manufacturing locations (Europe, China), distribution centers and EMS partners. The key question is division of work between the operations network nodes.
Design Inc.	European-centric, internationally operating design & branded consumer goods company. Publicly listed, three own manufacturing locations, global sourcing & contract manufacturing for major part of the company product portfolio (branded). Revenue approximately 73MEUR (2009), 370 employees.	The case company is a company with well-known consumer brand. The traditional core production takes place at three own factories. A large part of the product portfolio is sourced from suppliers and contract manufacturers across the globe, all however is branded with the company brand.	The company has set itself aggressive targets for profitable growth internationalization targets. This requires reconsideration and restructuring of operations, in particular enhancements of efficiency, effectiveness and coordination.
Wired Inc.	Internationally operating manufacturing company, producing construction equipments of ships and other marine segment solutions. A part of a family-owned group. Revenue approximately 30MEUR (2009), 200 employees.	The case company operations take place at three own factories, two in Europe and one in China. The products are manufactured starting from raw materials (like copper), directly delivered to all major shipyards in Europe and Asia, and additionally distributed through professional distribution companies.	The subsidiary in China is relatively new. In order to utilize the new global network fully, and to accommodate the changes resulting from concentration of shipbuilding industry to Asia, the company is redesigning its operations network including location of its manufacturing capacity.
Measure Inc.	A global leader in a high technology instruments and measurement devices. Publicly listed company with revenue approximately 240MEUR (2009), 1400 employees	The company is operating in multiple business segments, and is delivering a large range of products ranging from low value, high volume standard measurement devices to multi-million EUR project deliveries of full measurement solutions. The company is having a global operations network, where the main manufacturing takes place in an own factory in Europe. Additionally, the company has production for high volume standard products in Asia.	The company has recently restructured its business operations to customer segments as a response to cope with the high complexity caused by different products/services, customer segments and market areas. The complexity of the business situation drives the need to move from one monolithic operations and Supply Chain model to a modular network of differentiated operations/supply chains.
FreshAir Inc.	A globally operating, family owned group which is specialized in indoor climate and indoor environment products, services and solutions for buildings and ships. Revenue approximately 170MEUR, 1200 employees	The company is organized around five business lines, and the group overall has operations in 23 countries across the globe. The system components are produced in own factories as well as by license manufacturers. The actual solution engineering and sales is based on own knowledge-intensive R&D activities concentrated on three main operations locations in Europe and US.	The company has set itself a target to expand its sales to new geographical areas, in particular developing countries in Asia and eastern Europe. The operations network needs to be designed to support the new business competitively. The main challenge is to meet the market condition (like cost/price level, service and delivery expectations)

The design situations of the case companies can be divided into three broad categories. The first category, utilisation of global resources, is represented by CommTech Inc. and Wired Inc. The second category, improved competitiveness through more focused, differentiated resource combinations (improved fit) is best illustrated with Measure Inc., even if a similar perspective is also valid in the case of CommTech

Inc. The third category, international expansion to reach new markets/customer groups or new geographical areas, is the central topic for Design Inc. and FreshAir Inc. The operations design initiative comes from the growth and internationalisation targets which the ownership of the companies has set.

In the following table, we present the main factors considered in the operations network design of the case companies. The factors are grouped using the same logical as criteria found in the literature in Table 1, including a group of emerging factors such as risk management and sustainability, which are not recognised in the traditional literature of operations network design. We suggest that these new emerging factors should also be considered in the design process.

Table 3: Factors affecting the design of and operations network

Group	CommTech Inc.	Design Inc.	Wired Inc.	Measure Inc.	FreshAir Inc.
Strategic factors	<ul style="list-style-type: none"> - Conscious decision to be faster and more agile to achieve customer intimacy supported by technology leadership - Decision about focus countries based on prevailing technology 	<ul style="list-style-type: none"> - Differentiation through brand & design; strive for more global reach - Striving for new market areas, increasingly international customer base - Revenue and growth expectation 	<ul style="list-style-type: none"> - Competing through customer intimacy 	<ul style="list-style-type: none"> - Competing through technology leadership 	<ul style="list-style-type: none"> - Competing through technology leadership - Striving for a specific new market area - Revenue and growth expectation
Competitive situation	<ul style="list-style-type: none"> - Main competitors significantly larger 	<ul style="list-style-type: none"> - In some product segments competitors with significantly shorter lead times - New requirements from new sales channels and/or new geographical areas 	<ul style="list-style-type: none"> - Increasing competition from low-cost providers 	<ul style="list-style-type: none"> - Strong differences in product business vs solution business 	<ul style="list-style-type: none"> - Increasing competition from low-cost providers - Strong differences in product business vs solution business - Accepted price level significantly lower in the intended new market area
Product	<ul style="list-style-type: none"> - Ability to customer/order-specific customization - Modularity - Fast new product introduction and ramp-up - Quality, technical stability 	<ul style="list-style-type: none"> - Requirements from new product groups - High and increasing number of product segments and individual items - Combination of long and short product life cycles - Quality, durability, appearance 	<ul style="list-style-type: none"> - Broad product portfolio due to different customer requirements, national standards etc. - High-end quality in the respective industry 	<ul style="list-style-type: none"> - Ability to customer/order-specific customization - Modularity - High-end quality in the respective industry 	<ul style="list-style-type: none"> - Combination of standard products and customized projects - Modularity - Visual quality, quality of the system
Demand	<ul style="list-style-type: none"> - In project business demand lumpy but with good visibility - In other businesses short demand visibility combined to high number of variants 	<ul style="list-style-type: none"> - In some categories unpredictable demand due to trends and consumer preferences - In some categories fairly predictable demand but very high availability requirements 	<ul style="list-style-type: none"> - Long visibility to overall market demand combined with unpredictable specification and schedule changes 	<ul style="list-style-type: none"> - In some businesses fairly stable and predictable demand - In project business long visibility to overall market demand combined with unpredictable specification and schedule changes 	<ul style="list-style-type: none"> - In project business long visibility to overall market demand combined with unpredictable specification and schedule changes
Markets requirements for delivery	<ul style="list-style-type: none"> - Short lead time - Flexibility for demand changes - Continuous availability - Consolidation of system deliveries 	<ul style="list-style-type: none"> - Continuous availability of some products; accurate launch and delivery of seasonal products - Increasing special logistics requirements from new channels 	<ul style="list-style-type: none"> - Responsiveness to specification and schedule changes - Consolidation of project deliveries 	<ul style="list-style-type: none"> - Short lead time for some products - Delivery accuracy - Flexibility for demand changes for some products 	<ul style="list-style-type: none"> - Responsiveness to specification and schedule changes - Delivery accuracy - Consolidation of project deliveries
Supply	<ul style="list-style-type: none"> - Major part of the supplier base concentrated geographically to certain region of Asia - Need to be close to the supplier base in order to achieve supply certainty 	<ul style="list-style-type: none"> - Product category-specific concentrations of know-how (geographically) - Increasing requirements for direct deliveries from suppliers to channel 	<ul style="list-style-type: none"> - Availability of raw materials 		<ul style="list-style-type: none"> - Availability of standard component suppliers in the new market
Current capabilities of the company	<ul style="list-style-type: none"> - Clearly identified competences needed in-house for the chosen strategy 	<ul style="list-style-type: none"> - Need to support the in-house design capability through operations 			<ul style="list-style-type: none"> - Shift of core capability from manufacturing to solution engineering - Recognized competence gap for the new market
Current resources (setup of the network)	<ul style="list-style-type: none"> - Legacy of current network 	<ul style="list-style-type: none"> - Legacy of current network - Location related to brand image 	<ul style="list-style-type: none"> - Legacy of current network 	<ul style="list-style-type: none"> - Legacy of current network 	<ul style="list-style-type: none"> - Legacy of current network - No current manufacturing locations close to the new market
Financial aspects	<ul style="list-style-type: none"> - Labor cost - Logistics cost - Profit margin 	<ul style="list-style-type: none"> - Labor cost - Logistics cost - Profit margin 	<ul style="list-style-type: none"> - Labor cost, material cost - Logistics cost - Investment requirements 	<ul style="list-style-type: none"> - Labor cost - Profit margin - Investment requirements 	<ul style="list-style-type: none"> - Labor cost - Profit margin - Investment requirements
Emerging issues	<ul style="list-style-type: none"> - Availability risk - Protection of IPR - Co-location of manufacturing & R&D - Co-location of manufacturing and sourcing - Value-added product-related service (testing, tailoring) 	<ul style="list-style-type: none"> - Availability risk - Protection of IPR - Sustainability and transparency of product sources - Co-location of design & manufacturing of certain products 	<ul style="list-style-type: none"> - Investment risk - Co-location of manufacturing & R&D - Value-added product-related service (testing, tailoring) and supply chain related services 	<ul style="list-style-type: none"> - Protection of IPR - Co-location of manufacturing & R&D - Value-added product-related service (testing, tailoring) and supply chain related services 	<ul style="list-style-type: none"> - Investment risk - Co-location of system engineering with consolidation and delivery

From the cases, we can identify a relatively consistent pattern of data collection and analysis activities, scenario building and modelling and related decision making. However, we can also recognise that not all influencing factors are considered equally. Some aspects, like customer lead-time expectations, are clear drivers which lead straightforwardly to a limited range of possible solutions. On the other hand, risk considerations and product modularity, for example, heavily affect the result, but are seen rather as enabling or limiting factors. This consideration is consistent with the definition of fit as mediation (Venkatraman, 1989), where the mediating factors may change the effects of the actual drivers, and enable or disable possible conclusions.

Direct drivers in operations networks design

In the cases investigated here, out of the influencing factors, operating environment including both customer base and supplier base, market requirements, demand profile, product architecture and financial aspects, in particular total cost comparison, are the direct drivers which together can lead to a range of alternative designs of operations networks.

Operating environment in the design of an operations network. Operating environment includes all the elements that surround the company operations. The most important perspectives are the markets and customers of the company, as well as the overall supply base of the company.

Markets and customers appear as the main drivers to be taken into account. The perspectives include, e.g. location, size and growth of the market the company wants to serve. Proximity to market can be considered many ways: It is not only both physical closeness to paying customers, but also cultural proximity, and ability to develop relationships through personal contacts and meetings.

These findings related to the importance of the market in operations network design are consistent with those of several recent studies analysing the plant location decisions and reasons for offshoring/near shoring (sources): proximity to an existing market, access to new mar-

kets and access to new customers often appear as the main reasons explaining investments in manufacturing footprint expansion, as well as in distribution centre networks. In certain cases, presence at a market is value as such: In the case of FreshAir Inc., the expansion to the new market is partly driven by need to show credible commitment towards a customer base by being visibly present with a factory in the same area; in the case of Design Inc., the manufacturing country (Finland) is a core part of brand image.

Location of supplier base is also recognised as an important driver. Integration with the supplier base as such and ability to access the latest technologies and best suppliers needs to be considered in operations network design. In certain industries, the latest technological knowledge and supplier infrastructure are strongly clustered, and consequently, especially smaller firms need to co-locate to access the resources. This is highlighted especially in the case of CommTech: They recognise that a major part of their suppliers is concentrated to a region in Asia, leaving them no choice but to co-locate key purchasing activities, and consequently certain manufacturing activities, to the same region in order to be able to cooperate with the supplier base effectively.

Recognition of market requirements and demand characteristics. In addition to straightforward presence or proximity, questions involving other types of market-driven requirements matter in the design considerations. The most common of these relate to the availability of the products and services, lead-time considerations and responsiveness and flexibility of supply to cope with demand uncertainty.

All of the case companies are operating in market segments which value short lead times and high availability of products at the market. Short lead times may, however, have different meanings: For CommTech Inc., it is a requirement of being able to engineer, configure and deliver product variations within a few days to European customers. For Design Inc., it means continuous availability of certain products on the shop shelves, while for FreshAir Inc., it represents both delivery accuracy and responsiveness to schedule changes in large projects. These

perspectives, however, form a major part of the competitive approach for all the companies, and are typical key competitive factors for, e.g. Finnish companies overall (see, e.g. chapter 10 in this volume by Eloranta, Blomqvist and Laiho).

The requirement for short lead times drives the design towards emphasis on agility in manufacturing and logistics capacity, a network of distributed activities located close to market or at the market, and an emphasis on internal process integration to support fast cycle time, e.g. in the order fulfilment process.

Product characteristics. Product modularity, standardisation and platformisation significantly affect operations network design work. There is a strong linkage between product architecture and operations network architecture.

From structural perspective, product characteristics, in particular level of modularisation and standardisation, determine, e.g. the possibility of using shared capacity, specifically whether a centralised manufacturing capacity can serve several product lines, regions or market. In the same way, product architecture also significantly affects design from the point of view of postponement and use of, e.g. a mass customisation approach and configuration centres close to market, followed by related steering principles.

Financial considerations. Financial considerations, especially labour costs, indirect costs like the cost of facilities and energy and logistics costs are among the most visible drivers in operations network design. From the Scandinavian perspective, there often exists a tradeoff between maintaining the current operations in Scandinavia, and alternatively, establishing new activities in lower-cost countries. However, from the globalisation perspective, it is also worthwhile to understand the real cost impact, specifically the total landed cost to a marketplace. In addition, as discussed elsewhere in this book, activities currently located in low-cost countries may at the same time be in the middle of most lucrative emerging markets.

A different perspective from financial considerations is the optimisation of operations networks, particularly certain aspects like transfer pricing according to taxes, customs fees and other financial factors.

Mediating factors: Mediating factors are factors which limit the number of possible solutions, e.g. making some solutions unrealistic or guiding the understanding and decisions, but not leading to a solution on their own.

Through our cases, we can identify the following mediating factors which affect the operations network design:

- Competition strategy, e.g. selection between customer intimacy, operating excellence and technological leadership;
- Current resources and capabilities, e.g. availability of experienced leaders for offshore operations or high change costs limiting the ability to change existing operations;
- Risk management, e.g. risk of copying and loss of intellectual property, as well as risks related to the difficulty of establishing operations in certain countries;
- Emerging factors like sustainability (corporate social responsibility and environmental aspects), which increasingly affect supplier chains and operations.

The actual design factors and mediating factors are summarised in the framework below.

Figure 1: A framework for systematic operations network design

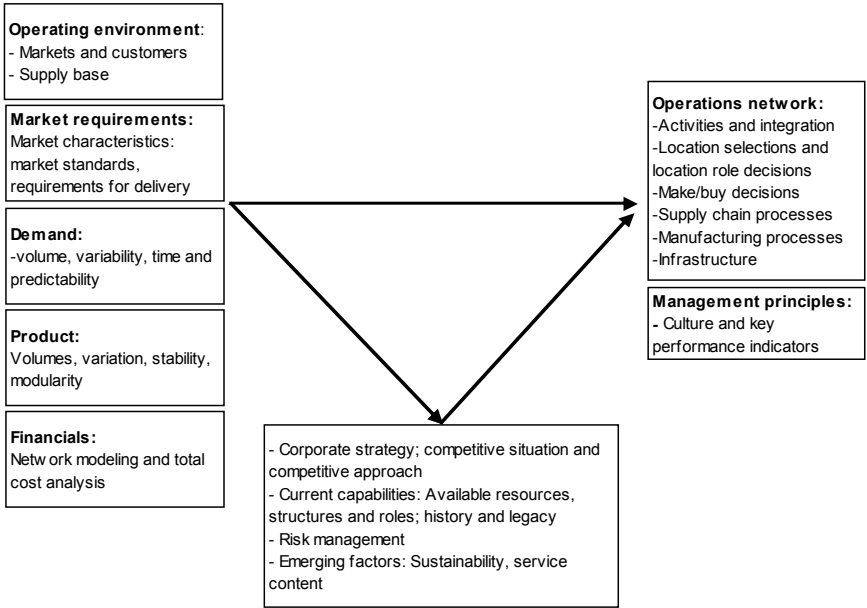

CONCLUSIONS

The operations network design is particularly important for Scandinavian companies. The home market is small and well matured, and as has been discussed elsewhere in this book, for many companies, successful globalisation is a matter of survival. Utilisation of global resources through a global network is a key success factor for numerous companies of Scandinavian origin. The same is true when it comes to the ability to competitively access the global market. At the same time, rational decisions regarding core competences and activities which can still be performed in Scandinavian factories are necessary. Put together, the operations network design process is constantly ongoing. This chapter has contributed to the challenge by deriving usable network design criteria from case research and the literature into a model which can be used for more informed, balanced design decisions.

From the perspective of theory, our results are consistent with the body of knowledge in the field. Forty years ago, Skinner (1969) identified most of the critical decisions valid today, and over 10 years ago, in his seminal work, Fisher (1997) added the supply chain perspective. Through the categorisation of design factors as direct and mediating factors, influential mechanisms and the relative importance of the different perspectives become clearer. This is particularly important when considering the role of, e.g. strategy and best practices in operations network design. In addition, proper consideration of mediating factors like available competencies and risk are of significance. The globalising business environment also adds new, emerging perspectives to the decision-making process, including risk management, sustainability aspects and the importance of proximity between functions. Scandinavian companies are often well aware of their importance, but at present, they are still mainly discussed as separate issues. We argue that they are an important part of operations network design, and propose that they should be a part of further research.

REFERENCES

- Aitken, J. (2005). Designing and managing multiple pipelines. *Journal of Business Logistics*, 26(2), 73–95.
- Childerhouse, P., Aitken, J., & Towill, D.R. (2002). Analysis and design of focused demand chains. *Journal of Operations Management*, 20(6), 675–689.
- Childerhouse, P., & Towill, D. (2000). Engineering supply chains to match customer requirements. *Logistics Information Management*, 13(6), 337–345.
- Christopher, M., Peck, H., & Towill, D. (2006). A taxonomy for selecting global supply chain strategies. *International Journal of Logistics Management*, 17(2), 277–287.
- de Treville, S., Shapiro, R.D., & Hameri, A.-P. (2004). From supply chain to demand chain: The role of lead time reduction in improving demand chain performance. *Journal of Operations Management*, 21, 613–627.
- Dubois, A., & Gadde, L. (2002). Systematic combining: An abductive approach to case research. *Journal of Business Research*, 55(7), 553–560.
- Eisenhardt, K. (1989). Building theories from case study research. *Academy of Management Review*, 14(4), 532–550.
- Eskola, J., & Suoranta, J. (2008). *Johdatus laadulliseen tutkimukseen*. Vastapaino, Jyväskylä.
- Ferdows, K. (1997). Making the most of foreign factories. *Harvard Business Review*, 75(2), 73–88.
- Fine, C.H. (2000). Clockspeed-based strategies for supply chain design. *Production and Operations Management*, 9(3), 213–221.

- Fisher, M.L. (1997). What is the right supply chain for your product? *Harvard Business Review*, 75(2), 105–116.
- Gelderman, C.J., & van Weele, A.J. (2005). Purchasing portfolio models: A critique and update. *Journal of Supply Chain Management*, 41(3), 19–28.
- Hayes, R.H., & Wheelwright, S.C. (1984). *Restoring our competitive edge: Competing through manufacturing*. Wiley.
- Hill, T. (1993). *Manufacturing strategy: The strategic management of the manufacturing function*. Macmillan.
- Holmström, J., Hoover, W.E. Jr, Louhiluoto, P., & Vasara, A. (2000). The other end of the supply chain. *McKinsey Quarterly*, 1, 62–71.
- Johansen, J., & Riis, J.O. (2005). The interactive firm—Towards a new paradigm. *International Journal of Operations and Production Management*, 25(2), 202–216.
- Jüttner, U., Godsell, J., & Christopher, M. (2006). Demand chain alignment competence—Delivering value through product life cycle management.
- Lampel, J., & Mintzberg, H. (1996). Customizing customization. *Sloan Management Review*, 38(1), 21.
- Lee, H.L. (2004). The triple-A supply chain. *Harvard Business Review*, 82(10), 102–112.
- Lee, H.L., Padmanabhan, V., & Whang, S. (1997). Information distortion in a supply chain: The bullwhip effect. *Management Science*, 43(4), 546–558.
- Naylor, J., Naim, M.M., & Berry, D. (1999). Leagality: Integrating the lean and agile paradigms in the total supply chain. *International Journal of Production Economics*, 62, 107–118.

- Olhager, J. (2003). Strategic positioning of the order penetration point. *International Journal of Production Economics*, 85, 319–329.
- Riis, J.O., Johansen, J., Sørensen, B.V., Englyst, L. (2007). Strategic roles of manufacturing. *Journal of Manufacturing Technology Management*, 18(8), 933–948.
- Schmenner, R.W. (1983). Every factory has a life cycle. *Harvard Business Review*, 61(2), 121–129.
- Skinner, W. (1969). Manufacturing-missing link in corporate strategy. *Harvard Business Review*.
- Skinner, W. (1974). The focused factory. *Harvard Business Review*, 52(3), 113–121.
- Treacy, M., & Wiersema, F. (1993). Customer intimacy and other value disciplines. *Harvard Business Review*, 71, 84–84.
- Venkatraman, N. (1989). The concept of fit in strategy research: Toward verbal and statistical correspondence. *Academy of Management Review*, 14(3), 423–444.
- Voss, C.A. (2005). Alternative paradigms for manufacturing strategy. *International Journal of Operations and Production Management*, 25(12), 1211.
- Yin, R.K. (1994). Case study research. Thousand Oaks, CA: Sage Publications.

CHAPTER 9

Integration of Manufacturing and Development in Emerging Markets

Peder Veng Søberg, *Aalborg University, Denmark*

Brian Vejrum Wæhrens, *Aalborg University, Denmark*

ABSTRACT

The chapter investigates the problems related to the functional integration between manufacturing activities and research and development (R&D) activities in emerging markets within multinational companies. A framework to this end is developed and illustrated through four case studies from multinational companies, which have established R&D and manufacturing in China or India. The findings point to the importance of adopting cross-function co-location drivers and contingencies, such as clockspeed and technological complexity, as well as the extent to which local adaptation is needed as an integral part of corporate re-location decisions.

INTRODUCTION

There are many reasons for multinational companies (MNCs) to internationalise their research and development (R&D). One of these reasons is to locate R&D alongside manufacturing activities which have already been offshored to emerging markets. As a result, R&D internationalisation may decrease the negative impact which physical distance is known to have on knowledge flows (Allen, 1977). Internationalisation of R&D thus makes it possible to take advantage of the proximity to well-established manufacturing units in order to reduce

administrative overhead, as well as to draw on existing links to the external environment in terms of access to labour, supply and technical and legislative conditions. However, these benefits are likely to differ across companies. Different implications for innovation performance are likely to exist across companies in relation to whether or not foreign-invested R&D is co-located with manufacturing activities in emerging markets.

Co-location is a well-recognised strategy for coordinating a complex task environment (Galbraith, 1994), and it is particularly beneficial as a means for coordinating activities, which should result in productivity growth and innovation (Porter, 2000). Previous research has primarily focused on the interface between R&D and marketing (e.g. Lu & Yang, 2004), rather than R&D and manufacturing (Song et al., 1997). This chapter, therefore, sets out to explore differences in the innovation performance of foreign-invested R&D subsidiary locations in emerging markets as a factor of core technology – and more specifically, interdependencies related to whether or not R&D and manufacturing is co-located. We are therefore pursuing the following research question: What determines the need for co-location of R&D and manufacturing in emerging markets?

In the following, this chapter will provide a framework relevant to understanding the dynamics related to functional interdependencies and resulting co-location needs of foreign-invested R&D and manufacturing activities in emerging markets. Subsequently, this framework will be illustrated in the empirical findings and analysis sections, which also provide evidence of the specific advantages experienced by multinational companies co-locating R&D and manufacturing activities in emerging markets, before relevant conclusions are outlined.

THEORETICAL FRAMEWORK

The need to align choices about process, product and structural arrangements is by no means new (Galbraith, 1994) and co-location is one key mechanism for this alignment. When manufacturing and R&D are located closely together and structurally tightly coupled, R&D person-

nel may direct more attention to problems experienced by manufacturing personnel. Thus, a risk may exist that R&D personnel will be excessively exposed to existing short-term problems of the company rather than the unknown future problems of the company. In addition, one can speculate that when R&D activities are closely integrated with manufacturing activities, R&D personnel have a tendency to disturb manufacturing somewhat, e.g. by conducting frequent test runs on manufacturing equipment. In other words, close integration and co-location of R&D activities and manufacturing activities may not always be beneficial. However, in the following, we will outline a couple of conditions under which it may indeed be advantageous.

Local industrial resources

Nobel and Birkinshaw (1998) outline a typology of roles for foreign-invested R&D units comprising 'local adaptors', 'international adaptors' and 'international creators'. Their findings indicate that for local adaptors and international adaptors alike, manufacturing units constitute the main communication partners within the company. However, whereas local adaptors primarily interact with local manufacturing, international adaptors primarily interact with an international network of manufacturing units, with which they are most likely not able to be co-located. However, the interaction between local adaptor R&D units and the local manufacturing units they support is likely to benefit from co-location.

In emerging markets, locally available industrial resources are likely to differ from the industrial resources available in more mature and developed markets. As illustrated in Figure 1, this is liable to have implications for the interface between local R&D and manufacturing, and whether this interface is needed. The market environment may differ, e.g. in terms of customer needs. Through adaptation to local needs, the competitive position of a product can be strengthened (Hill & Still, 1984); however, the extent to which local adaptation is needed may differ substantially. Local manufacturing may need more R&D support than otherwise if much local adaptation is needed. It may be possible to source such R&D support from the local market. On the other hand, in emerging markets, this may be more difficult for the MNC to

do than in developed markets, e.g. it may be difficult to find knowledge suppliers who have the necessary level of competence or specific experience. In addition, the risk of negative knowledge spillover in the often weak intellectual property regimes present in emerging markets may make captive R&D offshoring the preferred solution to mitigate such risks in relation to knowledge-intensive activities such as R&D. Hence, different companies may find it more or less relevant to co-locate R&D and manufacturing in a certain location, depending on the local industrial resources. In particular, the need for local adaptation of products may be important.

Clockspeed

Fast-paced clockspeed industrial settings are described as the fruit flies of competitive strategy. This is due to their fast pace of change with regards to underlying technologies, business models and supply chain relations, which are believed to illustrate a likely future for slow-

Figure 1: The interface between local manufacturing and local R&D in emerging markets.

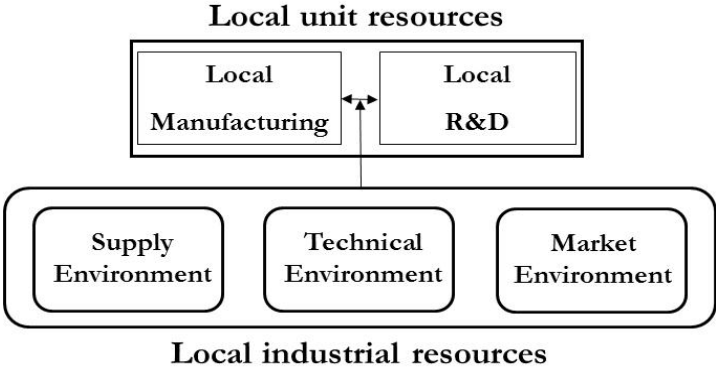

er paced industries (Fine, 2000). Fast technological development and the frequent introduction of new products in the market indicate high clockspeed. In industries characterized by high clockspeed , competitive advantages are found in the capability related to designing and re-designing value chain interfaces, and thus call for dynamic capabilities

(Teece, Pisano, & Shuen, 1997). Demand volatility is higher upstream than downstream in the value chain; however, clockspeed is most often lower upstream than downstream (Fine, 2000). This indicates that position in the value chain matters for the design of functional interdependencies, and potentially also for the need of functional co-location.

Codification is 'the process of conversion of knowledge into messages that can be processed as information' (Cowan & Foray, 1997, p. 596). The cost of codification, and thereby implicitly the anticipated benefits related to codification of knowledge, may often depict whether knowledge gets codified or not. When clockspeed is high, little time is available to benefit from investments made in the codification of innovation-related knowledge. Thus, such investments will most likely be more risky than they would be when clockspeed is low. Hence, innovation-related knowledge may often be less codified than otherwise when clockspeed is high, i.e. because less time is available to benefit from codification investments. From previous studies, it has been well established that codified knowledge is more easily transferred than noncodified or tacit knowledge, and that weak ties between units in distributed organisations assist knowledge search, while it takes strong ties to transfer and absorb complex knowledge (Hansen, 1999). Socialisation and face-to-face interaction nurture the transfer and creation of tacit knowledge (Nonaka & Konno, 1998), e.g. in the interface between R&D and manufacturing activities in emerging markets. This interaction is thereby particularly likely to benefit from co-location when clockspeed is high. The opposite may be the case where clockspeed is low and mature technologies may dominate. Mature technologies tend to be easier to transfer, since they are often more codified than emerging technologies (Kogut & Zander, 1993). Needed knowledge transfer between R&D and manufacturing is in that case likely to be possible from a distance, and the need for co-location may be smaller.

Technological complexity

Complex technologies make use of components, which are highly complementary or co-specialised (Teece, 1986). Technological complexity characterises 'applied systems whose components have multiple interactions and constitute a non-decomposable whole' (Singh, 1997, p. 340).

In relation to technological complexity, it can be beneficial to distinguish between product complexity and process complexity. According to Elmaraghy and Urbanic (2003), 'Product complexity is a function of the material, design and special specification for each component within the product. Process complexity is a function of the product, the volume requirements, and the work environment' (p. 363).

Modularity and the general decomposability of the product architecture affect boundary decisions within the firm, but also as we look beyond the firm and include the whole supply chain. It has been argued that a product's architecture oscillates between modular and integral, while firms simultaneously contract and expand their boundaries, i.e. outsource and insource work (Fine, 1998). Modularisation is one way to control technological complexity. However, this is only feasible in decomposable systems where complexity can be confined to modules.

As outlined above, multiple interactions, or multiple interfaces, are an indication of technological complexity. As component suppliers most often deal with one single interface, their technological complexity may often be lower than it is for system integrators. Integration is required for the successful development of high-complexity technologies (Singh, 1997). Co-location is a relevant way to nurture and facilitate such integration.

In summary, the co-location of R&D and manufacturing activities is likely to be especially beneficial for companies manufacturing products which require a high degree of local adaptation. It is also likely to be especially beneficial for companies experiencing high clockspeed and high technological complexity, as illustrated in Figure 2.

METHODOLOGY

Extensive qualitative empirical material has been collected from four Scandinavian high-tech companies and reported in four exploratory case studies (Yin, 2003). It is believed that rich contextual information is pertinent to facilitating a deep understanding of the phenomenon, as we have quite extensive knowledge of drivers of global R&D, but

Figure 2: Characteristics affecting the importance of co-location of R&D and manufacturing in emerging markets.

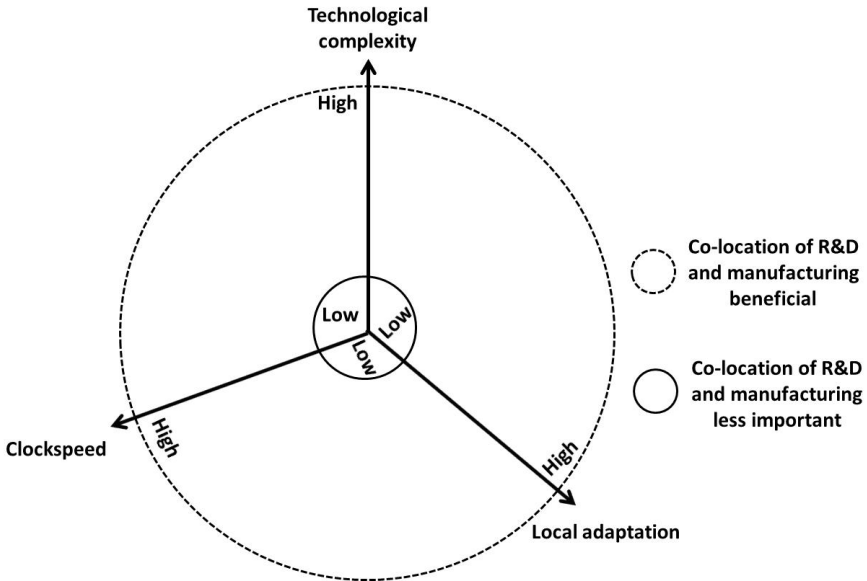

do not fully understand the process related to how it is operationalised. The abductive approach (Alvesson & Sköldbberg, 1994; Dubois & Gadde, 2002) forms the methodological strategy for this inquiry, where more than 50 in-depth interviews were conducted. These interviews lasted between 40 minutes and two hours, and they have been fully transcribed. The empirical findings triggered a search for theory and theory development through continuous interchange and pattern matching (Yin, 2003) between the empirical data and theory in order to find support for the theoretical framework. The interviewees were mainly employees within the R&D organisations of the case companies. Interviews were carried out in person and by telephone, both in Scandinavia and Asia, with employees at different management levels. Employees without management responsibility were also interviewed.

EMPIRICAL FINDINGS

Med Tech

This company develops and manufactures pharmaceutical products. It primarily provides medicine which makes it possible to live with conditions that most often cannot be fully cured. The company has R&D activities located in Beijing and manufacturing activities located in Tianjin, outside of Beijing. There is very little interaction within the company between these two business functions in China. The motivation behind the establishment of R&D in China was, on the one hand, to ease the further growth of the company in China by showing commitment to the overall society in the country, i.e. in conducting R&D rather than merely selling products in China. Another reason was to get better access to the developing talent in China.

Local adaptation. So far, the company has not needed to adapt its products much to local markets around the world. For instance, the company does not make much use of pulmonary technologies. Since lung sizes, etc. can differ a bit in different parts of the world, the use of pulmonary technologies would probably instigate the need for higher local adaptation than is currently the case. The strict regulations and norms stipulated by institutions such as the US Food and Drug Administration (FDA) make it expensive to make product modifications. This is one reason why the products are similar across the globe.

Clockspeed. It takes a very long time to develop new products for the company, even as long as 12–13 years. This seems to slow down clockspeed. In terms of technologies, the company has always focused on protein drugs and related technologies.

Technological complexity. Once the right recipes for a medicine developed by Med Tech has been found, the actual contents are simple compounds. Hence, there are not many different product components and interfaces to handle. Complexity is mainly found in the extreme demand for a stable and reliable manufacturing process, which entails high establishment and maintenance costs. The R&D centre in China carries out drug discovery, but so far not much large-scale manufacturing process maturation. This, however, may change in the future.

Wind Tech

This company is active within the wind turbine industry. Wind Tech has established an R&D unit in India in relative proximity to manufacturing activities the company already had established there beforehand. However, due to the poor infrastructure, it can take two hours to drive between the R&D unit and the manufacturing unit in India. In spite of this, the engineers in the Indian R&D unit meet regularly with employees who work in the local manufacturing unit of the company. By meeting with people from the manufacturing unit, the R&D engineers can better understand what challenges exist, when manufacturing the products of the company. In this way, they get inspiration concerning how to improve manufacturing processes of the company, such that new products can be manufactured faster and simpler. This has so far resulted in improved accuracy and quality in the manufacturing of the products of the company. The Indian engineers have also come up with a way to decrease emissions from the manufacturing process. Another benefit of having manufacturing activities nearby, experienced within the R&D unit, is that newly recruited engineers can obtain hands-on experience with the company products, in the manufacturing unit. Thus, the interaction between R&D and manufacturing in India is not intense, but it has still created some benefits for the company.

Local adaptation. There is not much need for local adaptation of the products of the company. Within the wind turbine industry, whether a wind turbine functions under onshore or offshore conditions is of course important, as well as whether it needs to work in the Arctic or other types of weather conditions. However, these differences normally do not lead to big, market-specific adaptations of products, and the case is no different in India. However, since the company's products are large, it is relevant to carry out manufacturing near the market.

Clockspeed. The clockspeed is relatively high, i.e., it normally takes no more than two or three years to develop a new product. Many customers also manufacture their own blades, so supply chain relations can change rapidly.

Technological complexity. The company manufactures blades for wind turbines. Hence, it can be considered a component supplier. Different skills are used; for instance, structural and aerodynamic calculations are very important, but there are not many different components and interfaces which the company needs to orchestrate in the development and manufacturing of products.

Pack Tech

This company is active within the packaging industry. In China, the R&D centre is co-located with supply chain management organisation, which is responsible for procurement in relation to equipment and machines. Concerning these things, the company does not carry out manufacturing in-house. Much is sourced in China, but certain things can only be found outside of China. Pack Tech manufactures packaging material in four different places in China, which is exclusively manufactured in house. The nearest of these facilities is located 100 km away from the R&D centre. However, the packaging material plant, with which most interaction takes place in relation to test runs, etc., is located more than 1,000 km away. R&D employees developing equipment are a bit annoyed with the supply chain management organisation, since they seem to favour lead time and cost rather than performance. In addition, supply chain organisation management requires a lot of technical support, and this disrupts R&D employees' focus on their own work. Moreover, according to R&D personnel, employees in the packaging material manufacturing plants are sometimes annoyed when they are disturbed by R&D employees who want to carry out test runs. Packaging material manufacturing employees are incentivised to minimise production stops, and test runs do not benefit their bonus. Otherwise, the interaction seems to run smoothly.

Local adaptation. In China, there are special requirements for downstream distribution equipment, which are not as evident elsewhere. This is largely related to the local need for secondary packaging, which comprises packaging that facilitates the easier and safer transport of smaller packages.

Clockspeed. There is relatively low clockspeed and slow technological

development in this company. It can take many years to develop new products. The technologies underlying the company's products have largely been the same for many years. The focus on in-house manufacturing of packaging material is very stable.

Technological complexity. As a full system supplier, the company provides packaging material, as well as the full range of filling and packaging machines needed. Complexity is found in solutions engineering, which draws on standardised manufacturing services.

Mechanic Tech

This company is a leader in the manufacture of automation equipment, and has established R&D activities in China near the manufacturing activities of the company. An important reason for the establishment of R&D is this it makes it possible to better support local manufacturing, e.g. when adapting existing products to the Asian market. The R&D establishment is part of the overall strategy of the company to increase its global footprint, which makes it easier to, e.g. carry out sourcing in low-cost countries. However, it was also a motivating factor to make use of Chinese engineers to develop new products. There is quite a bit of interaction with local manufacturing. All parts for the company's products are manufactured by global suppliers. However, it can be difficult to find suppliers of the right quality in China. In order to secure on-time deliveries and lowest cost, the company strives for dual sourcing, thereby including local suppliers.

Local adaptation. Customer requirements in China are less demanding in general than they are in Europe. Therefore, local customers demand cheaper solutions, and this brings about the need to adapt the products of the company to local needs.

Clockspeed. The technological development of this company can be considered fast. New products can typically be developed in less than two years, but when introducing new technologies, it takes longer. Technologies utilised in the products of the company evolve rapidly.

Technological complexity. The company assembles the different com-

ponents, which are manufactured by suppliers. Hence, there are many interfaces for the company to manage.

ANALYSIS

The interrelationships between R&D and manufacturing are clearly influenced by proximity; cognitive and physical distance matters to knowledge transfer and inter-unit communication. However, as seen within Med Tech, co-location and proximity does not always mean that intense interaction takes place. Wind Tech seems to benefit more from its relative co-location of R&D and manufacturing activities in India than Med Tech does. One benefit for Wind Tech is that R&D personnel receive input from manufacturing people in terms of how to improve the manufacturing processes of the company. To some extent, this points to the iterative nature of innovation, which may not always follow strict sequential stages. However, this also points to the need to differentiate between different forms of R&D and that, as a minimum, we need to distinguish between R&D activities, as they clearly exhibit different colocation needs with the manufacturing function. For example, the interaction between Med Tech R&D China and the manufacturing activities of the company in China seems to be less apparent than that between R&D Scandinavia and manufacturing activities in China. A reason for this is that Med Tech R&D China works with early drug discovery, which is, most often, subsequently further matured in Scandinavia by Med Tech R&D Scandinavia. Ensuring good interaction between Med Tech R&D Scandinavia and the manufacturing activities of the company may therefore be more important than ensuring good interaction between Med Tech R&D China and the company's manufacturing activities. Hence, one should not neglect the particular role of different units when optimising R&D, or the manufacturing footprints of companies, so that the two may be interlinked in beneficial ways. Different kinds of manufacturing may also have different kinds of needs in terms of facilitating good interaction between R&D and manufacturing, as illustrated in particular by the Pack Tech case. The supply chain management organisation focusing on outsourced manufacturing of equipment and machines on the one side, and the packaging material manufacturing plants on the other, seem to have

different needs for co-location. In the Pack Tech case, outsourcing also seems to necessitate closer interaction among R&D and the supply chain organisation than between R&D and packaging material manufacturing. The supply chain organisation in charge of procurement in relation to machinery, equipment, etc. depends to a large extent on the technical competence available in the R&D organisation.

In Figure 3, the four case companies are plotted into a polar diagram similar to that in Figure 2, which was initially presented as the theoretical framework underlying the chapter.

Figure 3: Characteristics affecting co-location of R&D and manufacturing in the case companies

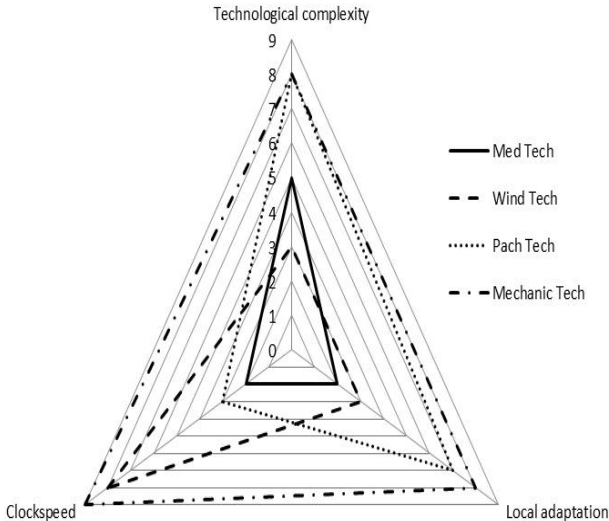

The analysis below motivates the evaluation illustrated in Figure 3. The guiding principle for understanding Figure 6 is that, the larger an area of the figure a company occupies, the more important co-location of R&D and manufacturing becomes, and vice versa. Hence, according to Figure 6, Med Tech has the lowest need for co-location, whereas Mechanic Tech has the highest. However, rather than simply using the mere intensity with which companies experience the three dimensions outlined in the framework (local adaptation, clockspeed and technological complexity) as a guideline for what to do, the specific combination of challenges faced by the individual companies is likely to have implications for location decisions within the company. For instance, it seems that Pack Tech, due to lower clockspeed in the industry, finds it less difficult to handle technological complexity than Mechanic Tech. Pack Tech essentially has more time to adapt to new technologies and faces less technological ambiguity as market standards are established early in the technology lifecycle. This may be one reason why we see less interaction between R&D and manufacturing within Pack Tech than within Mechanic Tech. Low clockspeed allows for more time to deal with the unanticipated events, which tend to take up most of the time related to knowledge transfer (Szulanski, 2000), and might make it more viable, e.g. to make use of traveling expert teams, rather than relying exclusively on the continuous local presence of R&D personnel.

In Table 1 brief descriptions of the situations the companies face in relation to the three dimensions are outlined and the case companies are evaluated accordingly with numbers ranging from 0 to 9, where a score of 0 means low levels of the dimension in focus and a score of 9 means high levels of the dimension in focus.

Table 1: Brief description of the case companies

Med Tech	Wind Tech	Pack Tech	Mechanic Tech
Local adaptation			
Identical products are sold around the world.	Very similar products are sold around the world, but the size of products calls for local manufacturing.	The need for secondary packaging is higher than in other, more mature markets.	Simpler and cheaper solutions are demanded in the local market whereby product adaptations are needed.
Score: 2	Score: 3	Score: 7	Score: 8
Clockspeed			
New product development can take 13 years. Focus only on protein research since the company was established. Stable supply chain relationships.	New product development takes at least 10 months (very rare), but normally two or three years. Many customers also manufacture their own blades, hence the supply chain relations can change fast.	New product development takes a minimum of four years, but more likely 6–7 or 10 years. Similar technological base for many years. Stable focus on in-house manufacturing of packaging material.	New product development normally takes less than two years. Technologies utilised in the products of the company evolve rapidly.
Score: 2	Score: 8	Score: 3	Score: 9
Technological complexity			
Simple compound products, but also extreme demands on a stable and reliable manufacturing process, which entails high establishment and high maintenance costs.	The company is a component supplier. It does not deliver a complete wind turbine to its customers.	The company supplies a full packaging system of packaging material, filling machines, downstream equipment, etc. There are many interfaces to handle.	The company enables automation processes in different sectors. This means the company has to integrate many different components and interactions among these.
Score: 5	Score: 3	Score: 8	Score: 8

Local adaptation. Wind Tech, and especially Med Tech, experience a lower need for local adaptation than Mechanic Tech and Pack Tech. When R&D and manufacturing is co-located, it is easier for R&D to carry out and support local adaptation. Such adaptation is more important for Pack Tech and especially Mechanic Tech than the other case companies. Both these industries rely on proprietary technologies and materials. Global market standards have not been established due to a multifaceted industrial scope and local demands.

Clockspeed. The task characteristics have a strong bearing on the interface between R&D and manufacturing. Tight relations are necessary for tasks with reciprocal interdependencies, due to the need for ongoing adjustments and mutual adaptation. Weaker relations are better suited for sequential interdependencies, where the relationship is formalised and arm's length. As we have seen across the cases, this is strongly related to the stability of the process, which may often be lower when the clockspeed is high. Where the technological clockspeed is fast, the need for tight relations is stronger due to the demand for continuous adaptations. This, however, is influenced by the level of standardisation of the process technology.

Med Tech and Pack Tech experience slower technical development and slower clockspeed than Wind Tech and Mechanic Tech do, e.g. the documentation and test requirements related to pharmaceutical research and development further slow down clockspeed. In a sense, it also nurtures codification of innovation-related knowledge, which can make it easier to transfer in the interface between R&D and manufacturing, using weak ties as a channel. Hence, there is less need for co-location. Med Tech and Pack Tech are also companies in more mature industries than the other case companies. It may be that as product structures change over time, as industries oscillate between integration and disintegration, opportunities for disintegration have increasingly evolved. This may thereby have decreased the need for co-location, especially for Med Tech. Pack Tech and Med Tech seem to have more stable supply chain relationships and they seem to experience higher stability in terms of the technologies utilised in the company products, than Wind Tech and Mechanic Tech.

Technological complexity. With regards to technological complexity, it is clear from the cases that the development of new process technology matters more to the relationship than product technology. We have to distinguish between process and product complexity, because although they are naturally related, product complexity is often decomposable, whereas process complexity most often is not. Product complexity is thereby more prone to complexity-decreasing initiatives such as modularisation. Automation equipment inherently deals with processes, and it is clear that the need for integration between R&D and manufacturing is much higher within Mechanic Tech than, for instance, within Med Tech. Whereas the complexity for Mechanic Tech largely concerns complexity in relation to the creation of new processes, the complexity for Med Tech comes from the high demands for stability and reliability of the manufacturing processes of the company. The high costs of establishing and maintaining the manufacturing processes can also increase complexity, as these things make it more important to forecast demanded volumes, which may be difficult.

A well-functioning interaction between R&D and manufacturing also facilitates a company's abilities to access, assess and engage with external resources, which the company aims to appropriate. Mechanic Tech experiences problems with their suppliers in China. It is difficult to obtain the necessary integration with the suppliers, which may be needed in light of the technological complexity the company experiences. The local R&D presence seems to mitigate these problems somewhat.

Wind Tech and Med Tech experience lower levels of technological complexity than Pack Tech and Mechanic Tech. Unlike Pack Tech and Mechanic Tech, Wind Tech is a component supplier. A component supplier may often experience less technological complexity than companies like Pack Tech and Mechanic Tech, which assemble different components to a full system. A mix of skills is necessary for successful development of the products of Wind Tech. However, there are few interactions for the company to deal with. Hence the technological complexity can be considered somewhat low for Wind Tech, unlike Pack Tech and Mechanic Tech, as illustrated in Figure 3.

FUTURE RESEARCH DIRECTIONS

The investigated cases of R&D establishments in China and India can be described as captive R&D offshoring. One can speculate that in other types of business models, such as offshore R&D outsourcing to emerging markets, it is likely that alliance types with local companies may have important implications for whether R&D and manufacturing need to be co-located. Further research may elucidate this topic.

As our theoretical framework contains three dichotomous dimensions, the framework sketches eight different scenarios, half of which have been explored and illustrated through the four cases in the chapter. We have illustrated two quite extreme scenarios (Med Tech and Mechanic Tech). Even though these cases can be considered somewhat extreme, it may be possible to find even more extreme cases. The chapter has also illustrated two different relevant midrange scenarios (Pack Tech and Wind Tech). The four most relevant scenarios for the purpose of this chapter have thus been illustrated. However, it would be interesting for further research to investigate different cases from the ones investigated in this chapter in order to see whether similar conceptual relationships can be found in such cases.

CONCLUSION

Co-location of R&D activities and manufacturing activities in emerging markets is likely to be more important for companies whose products require a high degree of local adaptation, rather than a low degree of local adaptation. The upgrading of foreign sites from exploiting home base knowledge and technologies through standards set at headquarters, to augmenting these global inputs to serve local market or resource needs increases demands on co-location, as the coordination required cannot be covered by occasional exchanges. This is further intensified when clockspeed is high as innovation-related knowledge is likely to be tacit, and its transfer between R&D and manufacturing activities thereby depends upon socialisation, which is nurtured by co-location, as this may facilitate the kind of learning that occurs from repeated interaction between particular groups or functions. This type of learning is most important in situations where the critical knowledge is locat-

ed in the interface between groups or functions, and where interfaces have not been standardised. Under such conditions of high technological complexity – particularly process-related complexity – integration is necessary and co-location of R&D and manufacturing is beneficial. On the other hand, when there is a low need for local adaptation, and when clockspeed and technological complexity are low, co-location of R&D and manufacturing in emerging markets may be less necessary, although it is likely to have some benefits in any case.

ACKNOWLEDGMENTS

We are grateful for the incredible help, open attitude and support from the case companies. The empirical data collection was supported by the Danish Strategic Research Council, Sino Danish Center for Education and Research, Jan Wallanders och Tom Hedelius Stiftelse and Tore Browaldhs Stiftelse, for which we are grateful. This chapter has also benefitted from comments received from colleagues, e.g. at the Global Manufacturing in China (GMC) conference, where an earlier version of this chapter obtained a special mention as a runner-up for the best paper award.

REFERENCES

- Allen, T.J. (1977). *Managing the flow of technology*. Cambridge, MA: MIT Press.
- Alvesson, M., & Sköldbörg, K. (1994). *Tolkning och Reflektion*. Lund: Studentlitteratur.
- Cowan, R., & Foray, D. (1997). The economics of codification and the diffusion of knowledge. *Industrial and Corporate Change*, 6(3), 595.
- Dubois, A., & Gadde, L.-E. (2002). Systematic combining: An abductive approach to case research. *Journal of Business Research*, 55(7), 553–560.
- Elmaraghy, W.H., & Urbanic, R.J. (2003). Modelling of manufacturing systems complexity. *CIRP Annals—Manufacturing Technology*, 52(1), 363–366.
- Fine, C.H. (1998). *Clockspeed: Winning industry control in the age of temporary advantage*. New York: Perseus Books.
- Fine, C.H. (2000). Clockspeed based strategies for supply chain design. *Production and Operations Management*, 9(3), 213–221.
- Galbraith, J.R. (1994). *Competing with flexible lateral organizations*. Reading, MA: Addison-Wesley.
- Hansen, M.T. (1999). The search-transfer problem: The role of weak ties in sharing knowledge across organization subunits. *Administrative Science Quarterly*, 44(1), 82–111.
- Jain, S.C. (2006). BRICs: Geopolitical and economic challenges for the US. In S.C. Jain (Ed.) *Emerging economies and the transformation of international business: Brazil, Russia, India and China (BRICs)* (pp. 478–513). Cheltenham: Edward Elgar Publishing.

- Kogut, B., & Zander, U. (1993). Knowledge of the firm and the evolutionary theory of the multinational enterprise. *Journal of International Business Studies*, 24(4), 625–645.
- Lu, L.Y.Y., & Yang, C. (2004). The R&D and marketing cooperation across new product development stages: An empirical study of Taiwan's IT industry. *Industrial Marketing Management*, 33(7), 593–605.
- Nobel, R., & Birkinshaw, J. (1998). Innovation in multinational corporations: Control and communication patterns in international R&D operations. *Strategic Management Journal*, 19(5), 479–496.
- Nonaka, I., & Konno, N. (1998). The concept of 'ba': Building a foundation for knowledge creation. *California Management Review*, 40(3), 40–54.
- Porter, M.E. (2000). Location, competition, and economic development: Local clusters in a global economy. *Economic Development Quarterly*, 14(1), 15.
- Singh, K. (1997). The impact of technological complexity and interfirm cooperation on business survival. *Academy of Management Journal*, 40(2), 339–367.
- Song, X.M., Montoya Weiss, M.M., & Schmidt, J.B. (1997). Antecedents and consequences of cross functional cooperation: A comparison of R&D, manufacturing, and marketing perspectives. *Journal of Product Innovation Management*, 14(1), 35–47.
- Szulanski, G. (2000). The process of knowledge transfer: A diachronic analysis of stickiness. *Organizational Behavior and Human Decision Processes*, 82(1), 9–27.
- Teece, D., Pisano, G., & Shuen, A. (1997). Dynamic capabilities and strategic management. *Strategic Management Journal*, 18(7), 509–533.

Teece, D.J. (1986). Profiting from technological innovation: Implications for integration, collaboration, licensing and public policy. *Research Policy*, 15(6), 285–305.

Yin, R.K. (2003). *Case study research: Design and methods*. Thousand Oaks, CA: Sage Publications.

CHAPTER 10

The Future of Manufacturing in High-Cost Countries – A Finnish Perspective

Eero Eloranta, *Aalto University, Finland*

Marja Blomqvist, *Aalto University, Finland*

Aki Laiho, *Aalto University, Finland*

ABSTRACT

We introduce a model for designing and locating factories to support the primary corporate competitive strategy and the related production imperatives. These imperatives are linked with the overall business strategies by Treacy and Wiersema (1995). Our model has four layers, each of which focuses on a particular production imperative and the associated core capabilities: (1) the production of the first product, (2) the production of the best product, (3) agile production and (4) mass production. The perspective of this paper is that of a manufacturing company with production facilities in high-cost countries (HCCs), such as Finland and other Nordic countries. In this spirit, we have demonstrated that the production of factories located in HCCs should focus on the imperatives (1) and (2) above, and partly also on (3). Mass production in HCCs seldom seems justified. Our empirical sample supports this reasoning.

THE GLOBALIZATION OF PRODUCTION

Some long- and short-term trends

Global production is changing the traditional regime of manufacturing. Manufacturing and related competences are flowing from the postwar manufacturing centre of the world, the US, to the developing

countries, indicating an alarming loss of knowledge, skilled people and supplier infrastructure. Accelerating outsourcing of manufacturing into low-cost countries (LCCs) in search of competitive advantage has reached the point where manufacturing industries have declined in the US – possibly irreversibly. Access to low-cost production resources, mainly labour, has been emphasised as a rationale for producing abroad (Lewin & Peeters, 2006; Pisano & Shih, 2009).

Europe is not immune to this trend. The Western world has already lost the crown of world’s manufacturing centre to Asia, mainly China (see Figure 1). Overall, all high-cost countries (HCCs) seem to follow the same pattern, where manufacturing operations tend to be offshored to low-cost ones.

Figure 1. Distribution of industrial production 1750–2100 (Source: Bairoch, 1982)

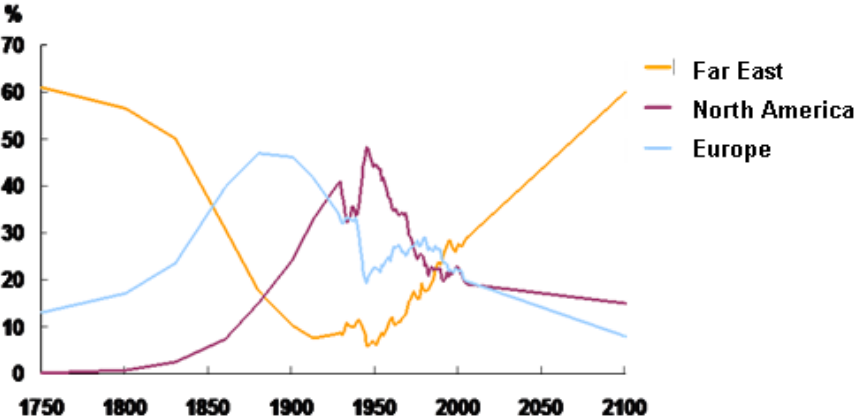

Finnish manufacturing companies have also been in turbulence. In recent years, the development has been alarming. The order intake in the technology industries has dropped dramatically (see, e.g. Figure 2) and the recovery has been slow. The value of the export has decreased, most dramatically in the electronics industry.

Figure 2: Value of order books in technology industries in Finland (Source: Federation of Finnish Technology Industries, 2010)

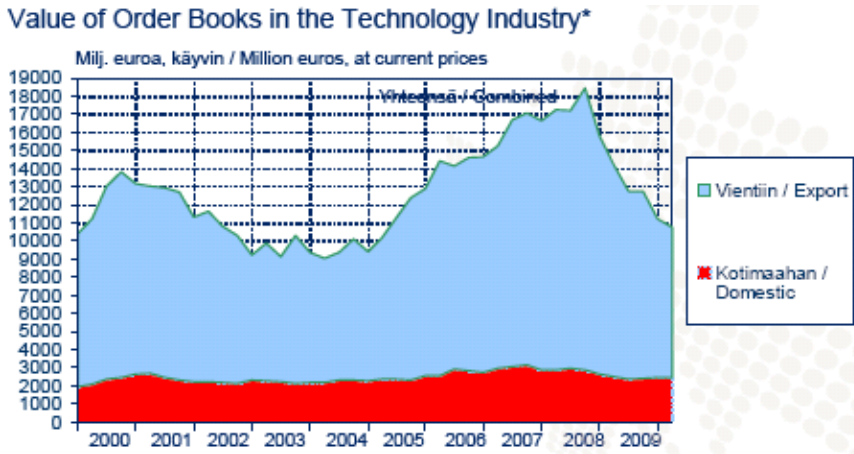

The sharp decrease in order books was primarily caused by the global financial crisis. However, the future recovery will presumably not accelerate the order intake to the level that existed prior to the recession. Globally operating companies have relocated their assembly factories and other core operations in close proximity to the growing markets, primarily in Asia. Accordingly, the supply base of raw materials, components and subassemblies will also be relocated. This phenomenon explains the starvation of order flow for the prerecession suppliers located in HCCs distant from the growing markets (Figure 2).

Such a trend can especially be observed in the consumer electronics industry, where the cost pressure has increased once the industry has become into mature state. As the original equipment manufacturers (OEMs) have located their assembly factories in the Far East, there is not much room for international subcontracting companies in high-cost areas.

The underlying cost drivers of globalisation

Comparing the labour cost internationally in the current state, the future does not seem promising for Western Europe's manufacturing

(Table 1). In terms of the differences in labour costs, ratios of 1:20 are customary if we compare the hourly labour cost level in LCCs to that in HCCs. Ratios over 1:30 also appear (Germany and Sweden compared to India and Ukraine).

Table 1. Comparison of global hourly labour cost in the steel industry (Source: Steelonthenet, 2009)

US \$/hour	2000	2001	2002	2003	2004	2005
Australia	14,4	13,3	15,4	19,8	23,1	24,6
Brazil	3,5	3,0	2,6	2,7	3,0	3,2
Canada	16,5	16,2	16,7	19,4	21,4	23,7
China	0,6	0,7	0,8	0,9	1,0	1,1
Czech Republic	2,8	3,1	3,8	4,7	5,4	6,1
France	15,5	15,7	17,1	21,1	23,9	25,3
Germany	22,7	22,5	24,2	29,6	32,5	34,1
India	0,6	0,6	0,7	0,7	0,8	0,9
Italy	13,8	13,6	14,8	18,1	20,5	21,7
Japan	22,0	19,4	18,7	20,3	21,9	21,4
Kazakhstan	0,5	0,7	0,7	0,9	0,9	1,0
Korea	8,2	7,7	8,8	10,0	11,5	14,1
Mexico	2,2	2,5	2,6	2,5	2,5	2,5
Spain	10,7	10,8	11,9	15,0	17,1	17,6
Sweden	20,2	18,4	20,2	25,2	28,4	29,7
Taiwan	6,2	6,1	5,6	5,7	6,0	6,4
Ukraine	0,3	0,4	0,5	0,7	0,7	0,8
United Kingdom	16,7	16,8	18,3	21,2	24,7	26,0
United States	19,7	20,6	21,4	22,3	23,2	23,8

However, labour cost is only one explanation. First, hourly labour cost does not tell the whole truth about total cost. Energy and material prices contribute to the costs of goods sold. Distances from suppliers and markets with corresponding logistics costs add up to the total landed cost.

Besides cost, the operations management literature recognises multiple criteria for plant location. The fast-growing markets in the Far East, together with the low factor costs, amplify the basic trend to relocate and grow manufacturing in LCCs. Currently, 50% of the economic growth on a global scale is explained by growth in China (Federation of Finnish Technology Industries, 2011).

Access to skills and knowledge may play a central role, especially in industries with demanding production tasks. Proximity of research and development (R&D) competence is essential with complicated products, in particular in their early phases of the lifecycle.

In some industries, the geographical concentration of manufacturing locations regarding the sources of supply is almost a norm (Cluster Competitiveness Group, 2002; Reichart & Holweg, 2008). Proximity to markets and the sources of supply affect not only transportation costs, but also reaction and delivery time to the customer. Distance to markets and the sources of supply also affect inventory levels. The location of competition may play a role when deciding on location.

The impact of trade politics in the forms of subsidies, tax barriers and local content requirements must not be underestimated. Besides these external and intrafunctional drivers, cross-functional dependencies within an organisation, such as the need for manufacturing to be located close to R&D influence the location decision (see for example Ketokivi, 2006), are also important.

Offshoring manufacturing to the Far East is a European and US phenomenon, and both are struggling with the same issue: the outflow of manufacturing. A study initiated by the state of California compared the costs between Chinese and Californian manufacturing of products aimed for the US market. In a low-tech industry like apparel, the bare manufacturing cost difference was 50% in favour of China. Instead, the total landed cost level, covering not only the manufacturing and purchasing cost, but also logistics and quality costs plus the hidden cost related to for example product availability issues, reduced the cost difference drastically. In the apparel industry, the 50% cost difference

shrinks roughly by half, to 31%, as the total landed cost is calculated. For high-tech products, on the other hand, the cost difference is not that clear. The difference in the manufacturing cost is smaller (3% in favour of China) and logistics costs are negligible due to the high value per weight ratio. The 'hidden costs' reduce the gap into 1.8% (Bay Area Economic Forum, 2005; Eloranta, Ranta, Salmi, & Ylä-Anttila, 2010).

Similar results have also been obtained elsewhere. A comparative study looked at the consequences of locating the production of a small car in India rather than in Japan, for the Japanese target markets (Agrawal, Farrell, & Remes, 2003). The study showed that there is a remarkable cost reduction potential of more than 20% if the vehicle is manufactured in India rather in Japan (Figure 3). It is noteworthy that the biggest saving potential is related to the relocation of the supply sources of purchased items. This is understandable, because the major share of manufacturing value added is based on the external resources of the manufacturing company. For example, in Finland, the value of purchased materials and services make up 65% of the revenue (Heikkilä, 2009).

Figure 3. The cost difference between producing a car in India vs. Japan for the Japanese market (Agrawal et al., 2003)

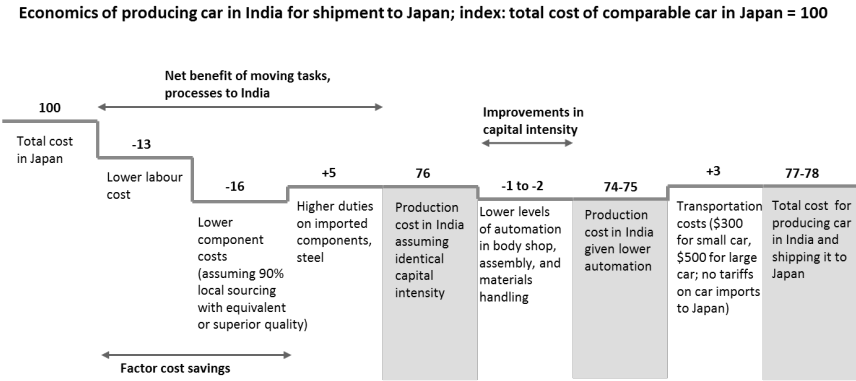

All in all, costwise, the LCC manufacturing/sourcing cost advantage does have an impact on the location of manufacturing operations. The higher the relative labour content in the product costs, the more economical is the use LCC manufacturing/sourcing (Bay Area Forum, 2005). This is counterintuitive in the thought models of many Western policymakers, who frequently emphasise that high value adding production, often meaning at the same time high labour content, should be located at the home base, i.e. in a HCC.

The rationale for offshoring versus onshoring

Most of the recently documented analysis (e.g. Agrawal et al. 2003; Bay Area Forum, 2005; Farrell, 2006) supports the current mega trend to relocate manufacturing in Far East, such as in India or China. However, there are also studies that question this imperative. The Bay Area Economic Forum report used the concept of 'hidden costs', which under certain circumstances would outweigh the mere production and logistics costs. The report launched the concept of 'customer service capability' to incorporate factors that should be considered in addition to the manufacturing and transportation costs, when the ultimate production location decisions are to be made. 'Customer service capability' stands for capabilities such as short lead times, flexibility for demand changes and catering for short product lifecycle (Figure 4).

Figure 4 provides a decision-making model to locate production in a high cost vs. low cost area. The two criteria applied in production location decision making in the Bay Area Forum (2005) report were customer service capability (see above) and factor costs. If the factor costs are the dominating criteria in the customers' purchasing decisions, it is reasonable to locate production where the factor costs are low (high offshore potential). In contrast, if the customer service factors dominate as the purchasing criteria, production locations in the proximity of the customers are preferred (high onshore potential).

Figure 4. The rationale of production in high-cost countries
 (Source: Bay Area Forum, 2005)

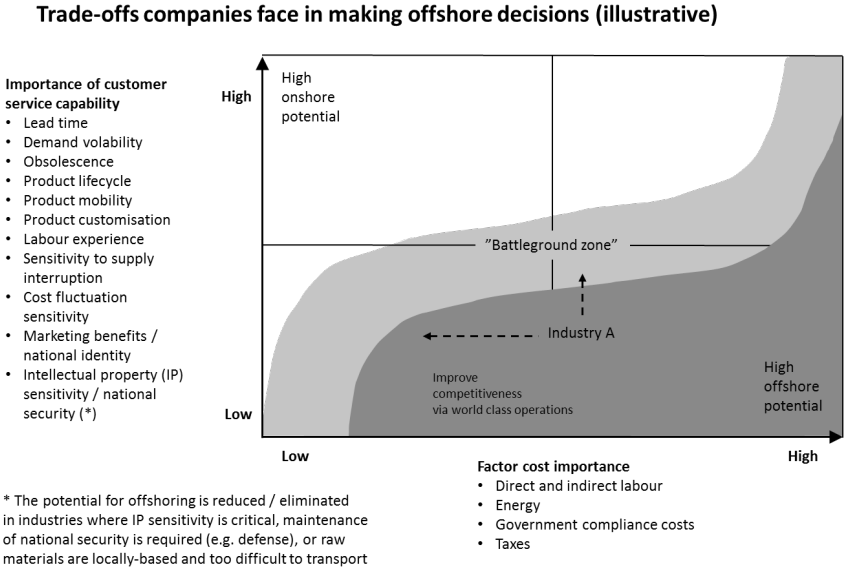

The logic of Figure 4 holds when the geographical centre of gravity of the customer base is disjoint from the supply base, e.g. when the customer base of an EU company is located in Europe (onshore) while the factor costs are the lowest in Asia (offshore). As mentioned above, most of the growth in the global economy is currently located Asia, exactly where the factor costs are the lowest. This implies that there is a huge global imbalance between high offshore potential and high onshore potential. In 2010, the economic output grew by 10.3% in China, while the growth in the Euro area was merely 1.8% (International Monetary Fund, 2011). This imbalance expected to continue in the future, which implies that a high percentage of jobs is at risk in high-cost areas, such as the Nordic countries.

The approach depicted in Figure 4 can be assumed to apply to other high-cost, high-competence geographical areas, such as Finland. A study by Heikkilä and Ketokivi (2005) compared Finnish, Japanese,

Swedish, German and US factories, and provided at least some evidence that the prerecession situation in industry supports the model of the Bay Area Forum (2005) report. With the US (68%), the share of the innovative products was the highest in the Finnish factories (64%), followed by Germany and Sweden (59%) and finally Japan (48%). The required volume flexibility was the highest in the Japanese (36%) and the Finnish factories (32%), compared to US (27%), Sweden (21%) and Germany (17%). The repetitiveness of production was the lowest in Germany (3.7), Finland (3.8) and Sweden (3.9), compared to US (4.4) and Germany (4.6). Even though there are many sources of variance and error in the data by Heikkilä and Ketokivi (2005), there is at least some weak evidence that small HCCs such as Finland have built their manufacturing competences on customer service factors. The study by Ketokivi and Heikkilä (2005) also provides some explicit evidence that the cost factors are not dominating in the operations strategy of the Finnish factories.

Scandinavia will most likely keep on generating products for local and global markets, where cost is a secondary factor in the customers' purchasing decision (e.g. high-value niche products like Genelec loudspeakers and B&O consumer electronics), or where the total cost is equally low or even lower when the products are produced in Scandinavia. Similarly, products where the customer service capability requirements are high will be most likely produced for the local markets (e.g. fresh food).

In a recent study about Finnish factories (Turkulainen & Blomqvist, 2010; see also chapter 2 of this book), it was discovered that Finnish factories typically have a high competence level and correspondingly versatile responsibilities. For location, proximity to the market turned out to be an important factor. However, the Finnish factories typically do not deliver products in high volumes to the global markets, but rather serve the local, domestic markets. This means that the Finnish factories are well prepared to serve customers located in Finland, a market that, unfortunately, is small and growing only slowly. Moreover, for most of the global markets, factory location in Finland is a logistical disadvantage.

In the following sections, we will discuss the required factory capabilities in the course of the product lifecycle within a manufacturing network in order to better understand what kind of factories would have a successful future in Finland, or more generally, in some other, similar HCCs.

THE EVOLUTION OF MANUFACTURING IN FINLAND IN THE LAST DECADES

Manufacturing industries have declined in HCCs. The root causes of this are connected to the uneven distribution of resource costs and economic growth in the world economy. However, it would be too simplistic to state that product manufacturing will vanish in HCCs.

In this chapter, we shall introduce a model to describe and explain the transitions of the locations of manufacturing plants. The perspective adopted relates to the company and value chain levels. The model will provide not only a description, but also a prescription for the characteristics of manufacturing that will be viable in HCCs in the years to come. The model is constructed based on research work carried out in the Finnish context (Eloranta et al., 2010).

In a nutshell, the evolution of the Finnish manufacturing industries for the last 50 years has applied different recipes for success: After World War II, there was a long period of high fixed investments in heavy industries, in particular for pulp, board and paper machinery, but also for heavy mechanical engineering. The period ended with the collapse of one crucial customer, namely Soviet Union, towards the end of the 1980s. In these turbulent connections, the long-lasting vicious circle of overinvestment, inflation and devaluation was broken down and replaced by the connection of the Finnish economy with the European monetary system. The economy was opened to favour industries dependent on imported raw materials, such as electronics (Eloranta et al., 2010). In terms of manufacturing capabilities, the dominance of investment in fixed assets such as machinery came to end.

The period from mid-1990s to 2008 was one of fast growth. Informa-

tion and communication technology (ICT) industries, in particular telecommunications, reached the level of global excellence. Strong investments in soft assets, such as R&D, manufacturing engineering and supply chain capabilities turned out to be extremely profitable. The growth declined with the stagnation of telecommunications business and crashed with the global financial crises that hit the country during the second half of 2008.

What the recipe for the coming years will be remains to be seen. We advocate that the success of the Finnish industry after the financial crisis lies in an innovation-based strategy. High-cost and high-competence countries like Finland will likely not be successful providers of 'unintelligent' mass products, where the competition is easily lost to LCCs. Mass products should be replaced by 'intelligent products', where the customers' purchasing criteria are based on perceived value. In order to achieve this, the key capability will be the ability to create and deliver new, value-based innovations. It should be noted that this innovation ability does not relate to technical innovations only, but rather emphasises the customers and markets as a starting point, creating value-adding solutions (Eloranta et al., 2010).

COMPETITION STRATEGIES AS A BASIS FOR DIFFERENTIATION IN MANUFACTURING INDUSTRIES

There are three different competitive strategies as described by Treacy and Wiersema (1995):

- Product leadership;
- Customer intimacy; and
- Operational excellence.

Let us elaborate separately on these three competitive strategies from the perspective of manufacturing capabilities.

Product leadership strategy

Product leadership strategy is built on the capability to serve the markets with the most advanced – or customers' best preferred – products. This strategy relates not only to products, but also to services. For brevity, we shall use here the term 'product' to mean both products and services.

This strategy is most appropriate when there is enough room to compete with product attributes, whether tangible or intangible. This is most natural in the early phases of the lifecycle of a value domain. These are the stages of early adopters and enthusiasts, expressed in the lifecycle model by Moore (1991). The production capabilities associated with the product leadership strategy can be explored in terms of the production capability roles discussed by Johansen and Riis (2005):

- Laboratory factory;
- Prototype factory;
- Ramp-up factory;
- Benchmarking factory; and
- Full-Scale factory.

A *laboratory factory* develops new manufacturing processes and new production configurations. A *prototype factory* assists the product development function in developing and testing products. A *ramp-up factory* sets up the delivery of a new product or a customer-adapted version of an existing one. It may also serve as an integrator with product development. A *benchmarking factory* provides knowledge about production possibilities and the costs associated with carrying out effective, small-scale production. The main volumes can be produced elsewhere. Finally, a *full-scale factory* provides fast, reliable delivery to customers at competitive prices. Such a facility may serve as the main source of supply for all the markets.

Product leadership strategy can be divided into two stages according to the maturity of the value domain: first, the stage of the first product, and later, the stage of the best product. In the very early phases of value creation for a new value domain, the key challenge is to bring the very first products to the market for the use of a potential customer community composed of early adopters, such as technology enthusiasts and visionaries. In the later stages, the potential customer base grows as the first pragmatists discover new offerings that could add value to their life. This segment is not inspired by newness as such, but by potential tangible value over costs. At this stage, the competition also starts, and the supplier with the best product will possess a competitive advantage.

The first product strategy and related production capabilities

In the first stage, the challenge is to bring the first product to the potential customers. Competition is negligible because the markets have not yet been established. The driver that leads to market behaviour is technological push. The factory roles needed in this phase, in terms of the model by Johansen and Riis (2005), are laboratories, prototype workshops and ramp-up factories. Costs are relatively less important provided that the sales price is affordable to the early adopters.

The core competences required in the company are customer driven R&D and capabilities to realise the visions, blueprints, mock-ups and prototypes, and ultimately functional products. Knowledge exchange capabilities between the company and its value chain partners, customers and suppliers, are a must, so that the mutual understanding of needs and requirements could be materialised in the form of a tangible product. The related production capability is the ability to create the first ever fully functional products for the markets. The production mode requires capabilities for producing pilots, prototypes and ready products as one-off productions or in small batches. A subcontractor network with corresponding prototyping capabilities is needed, and this network should be located close to R&D in order to enable the fast realisation of the new product ideas.

We refer to this as the 'innovation reactor' stage, and postulate that the innovation reactor is the most important entity that a manufacturing company located in an HCC would need for its long-term survival. If the innovation reactor of a large corporation fades away, the corporation will face serious trouble in the long run.

In order to nurture innovations towards larger-scale business, a thorough understanding of the market and end users is needed. The innovation reactor is the heart of an innovator company, but the products and services will need to move from the reactor level to other levels in order to create business.

The first product strategy and related production capabilities

After the first products have successfully been launched to the markets, it is more appropriate to talk about the best product strategy. If the customer experiences of the first products have been positive and the demand starts to grow, the other players also become interested in entering the market in terms of launching competing products. What comes to the production related capabilities, the customers, in particular the pragmatists, are less forgiving than the early adopters. Thereby the role of quality as the purchasing criterion grows. Moreover, costs are relevant as a purchasing criterion, because pragmatists tend to weight customer perceived value against costs.

With the best product strategy, the rules of the game are different from the first product strategy due to the larger scale. At this stage of the product or industry lifecycle, it is no longer enough to produce single products or services for enthusiastic techies; rather, the products need to provide significant customer value for the target customers, and this has to make sense economically. From an R&D point of view, this means adding features and improving the quality and reliability of the product. From a production point of view, this means stabilising product structures and production processes and creating the capability to increase production volumes with marginal cost.

The production role model by Johansen and Riis (2005) does not provide a perfectly applicable role for production when the competitive

corporate strategy is built on the best product approach. Nevertheless, the concept of a 'full-scale factory' can be considered fairly applicable for the best product-based corporate strategy, if a 'full-scale factory' is considered as scaling up a 'ramp-up factory' to a full-fledged factory for volume production. A high level of quality management processes and principles is an absolute must for the product leadership strategy. The suppliers should be hooked into the interorganisational business processes for quality and dependability.

The product leadership strategy is not sustainable unless the company is able to bring to the markets new products and services as a continuous flow. This is why production should be located in the proximity of R&D. However, even though there is widespread understanding of the need to locate production close to R&D, when the intensity of new product development is high, there is not much research to support this intuitively obvious reasoning (Ketokivi, 2006).

Customer intimacy strategy

According to Brown and Hagel (2005), very few companies create significant shareholder value through breakthrough product innovations. Most economic wealth comes from more modest advances that accumulate over time. This counterintuitive observation is based on the idea that product leadership strategy is normally connected to the early stages of the lifecycle of a value domain, where sales volumes are still relatively low.

With the product leadership strategy, the location of production has little significance: The most important location factor is the proximity to R&D, the availability of a favourable business and supply infrastructure and access to competent resources. These preconditions change when the business moves towards a customer intimacy strategy. At this stage, similar products and services are offered by several actors, so managing the customer interface becomes the most important capability. The products still have small differences, but they are no longer significant. The winner is most likely the supplier whose products and customer services create the best combination for the customer: Customisation of the offering, fast and reliable delivery and

important value-adding services such as vendor-managed inventories and after-market services. Thus, the proximity to customers – both geographically and mentally – becomes highly relevant. Fast and flexible production and delivery processes are essential.

As a value domain matures, there are fewer and fewer opportunities for major differentiation through product characteristics. This is where the product-based competitive advantage is replaced by customer intimacy-based advantage through process innovations (Hammer, 2004). Process innovations are crucial for building competitive advantage and generating wealth. Wealth generation is justified, here, because the scale of the markets is high towards the end of the growth phase of the product lifecycle.

In her PhD thesis about the production capabilities over the lifecycle of a value domain, Vehtari (2006) discovered that operational innovation plays biggest role when transferring from introduction to growth, or as Moore (1998) defines it, 'entering the tornado', and then in the maturity phase when seeking for new growth opportunities in mature markets. Vehtari (2006) also observed the importance of the second transition phase from high growth to maturity. According to her, operational innovation, when entering the growth phase, can be labelled as shaping the future, while readiness for change could be labelled as adapting to the future through flexibility.

Tushman and Nadler (1986) also support the idea that, first, there is a substantial amount of product innovations, which could even lead to a dominant design. In the next stage, product variation gives way to competition based on price, quality and segmentation, i.e. customer-centric process innovations. This often requires distribution channels and suppliers which are different from those that serviced older product generations. An organisation may find at least some help in coping with the high uncertainties imposed by the environment by increasing manufacturing flexibility (Swamidass & Newell, 1987) and strengthening distribution channels. The customers would experience such efforts as increased agility and extraordinary value added by the supplier (see, e.g. Collin, Eloranta & Holmström, 2009).

The preconditions for agile customer service are based on collaborative business models (such as vendor managed inventory (VMI), sharing of demand visibility and flexible technologies (Collin, Eloranta & Holmström, 2009). The location of the factories is not very critical, provided that the requested delivery times can be met. Proximity to the markets is preferred. In a global business, this means that there are supply sources, own or outsourced, in each market region – or at least distribution centres – for sufficiently fast deliveries. European markets may be supplied from European factories. This means that in the agility stage, some factories may also be located in HCCs such as Finland.

In terms of the factory taxonomy by Ferdows (1997), the category of the factories required in the agility phase is the contributor factory. The contributor factory serves a specific national or regional market. Due to the requirements for extensive customer service, capabilities for product and process development and supplier management are required. Obviously, the lead factories (Ferdows, 1997) can also serve the purpose in the agility stage, as the lead factories have the capabilities to create new processes, products and technologies, not only for a specific market region but also for the entire company.

Operational excellence strategy

According to Vehtari (2006) manufacturing has big impact from the competitive advantage point of view during the transition from growth to maturity (ready for sudden changes, leanness and control) when it is essential to slow down and control the whole supply chain and to adapt to the change (Courtney, Kirkland, & Vigurie, 1997; Hammer, 2004).

At the end of the growth stage, a company has to be prepared for changes in its competitive situation. To prepare for decline when there still is growth in the market requires a strategy for lean growth with a lean organisation. Fixed costs should be minimised. The target should be the next lower price point (Moore, 1998). Cost efficiency is the dominating competitive asset. Therefore, production operations should be located to take the advantage of low factor costs. If own factories cannot provide sufficient scale, it is sensible to outsource production

to mass production contract manufacturers. The hunt for scale advantage leads to centralised production facilities in offshore locations, if the head office is located in an HCC such as Finland. Manufacturing in LCCs should be supported by global sourcing, which takes advantage of the benefits of cost-efficient sources of supply without sacrificing high-quality specifications.

On the mass product level, the markets are global and saturating. The products have become the mainstream. The primary, and often the only competitive advantage is price. Production will most likely take place in mass production factories, owned either by contract manufacturers or the company itself, and positioned globally in locations where the production cost and the total landed cost is optimised, also taking into consideration the requirements for quality and delivery capability. The key supporting capability is sourcing. Raw materials, components, services and especially manufacturing services have to be sourced at competitive cost.

There are a few exceptions where competitive cost efficiency can be achieved in the mass production mode, yet maintaining most of the production in HCCs. According to Vehtari (2006), Nokia and Dell were able to expose the best cost efficiency in the market and yet have factories in HCCs. Both of the companies enjoyed market leadership, granting the highest market volumes in production and purchasing. As the share of manufacturing costs and overheads are negligible in the costs of goods sold in PC and mobile phone manufacturing, Nokia and Dell enjoyed the competitive advantage of the lowest cost producer although they have factories on each continent. Conceptually, this is a situation where the imperatives for agility and mass production are temporarily coincident. Such a situation, unfortunately, is not sustainable.

THE INNOVATION ENTERPRISE MODEL

As described in the previous section, a full portfolio of production characteristics that covers all the phases of the product and service lifecycle meets the challenges of four production capability imperatives:

- Produce the first product;
- Produce the best product;
- Produce products in agile production, sourcing and distribution modes; and
- Produce products in the mass production mode to compete in cost efficiency.

The four imperatives are disjointed in the sense that the capabilities required for each of them are different. Producing the first product is based on experimentation, close proximity with product development and deep technological collaboration with innovative suppliers. The production of the best product relies on systematic, quality-oriented processes and a highly skilled and disciplined labour force. There is not much room for experimentation with the inherent risk taking. Agility in production counts on strong operative collaboration with suppliers and customers, flexible manufacturing and assembly technologies, demand visibility and expeditious operations. In mass production, continuous improvement in production and product engineering to save the last cent from the production and supply chain costs is a must.

It is possible for a small company to stick on one or two layers by focusing on the capabilities for the first product and/or the best product. However, a small company cannot compete in scale against large, global players at the agility and mass production layers. Naturally, if a small company is capable of growth, e.g. due to being leveraged by its excellence in the product leadership strategy, the natural direction for growth is to proceed to the agility and mass production layers.

Although the most of the money is made in the mass production and agility layers, the survival of a large corporation is dependent on the vitality of its innovation reactor. Therefore, to become and stay vital, large companies should incorporate capabilities in every layer. Figure 5 illustrates the four-layered model of an innovation company, originally published in Eloranta et al. (2010).

Figure 5: The innovation furnace model

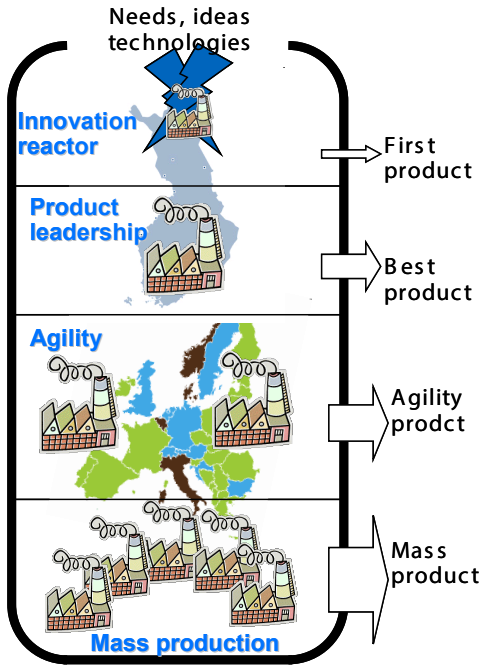

It is impossible to prove that a conceptual model of companies, such as the innovation furnace model above, is right or wrong. However, it should be possible to demonstrate the existence of such a model through narratives or case studies. In this spirit, we shall describe briefly four case studies. Each of them has operations on at least one layer of the innovation furnace model.

The Dynaset case

One example of a small innovator company is Dynaset Ltd., a leading manufacturer of hydraulic generators, power washers and compressors (for more details, see e.g. www.dynaset.com). The business idea of Dynaset Ltd. is to use hydraulics from the carrier machines to provide power to other equipment, too. Basically, everything Dynaset does is based on one of the three product lines – electricity, high pressure water and pressured air, all under the descriptive company slogan ‘Pow-

ered by hydraulics'. Dynaset's innovation is derived from the daily work of the customers. An example is a small-scale excavator entrepreneur customer, working on a construction site as a subcontractor. There is seldom electricity available from the country-wide electrical networks at the early stages of the construction site project. However, hydraulics from the carrier machine, an excavator in this case, can be used as a source of power, e.g. for pumping water out of the pit, welding, or doing something else where the mainstream solution is based on the use of electricity, generated by an aggregator. The advantage of the hydraulic machinery is the small size in relation to the power, which enables the entrepreneur to keep the most important tools on board his carrier machine (excavator) and make use of the tools with the energy provided by the hydraulics.

This is where Dynaset differs from the mainstream companies on the market, which apply the electrical energy available 'from the socket'. Dynaset's solutions are most appropriate for the nonmainstream customer segments, i.e. the customers provided with hydraulics power of their carrier machinery in an environment where electricity 'from the socket' is unavailable. For such a segment, the solutions by Dynaset are superior to any other technologies. This segment is globally too small to attract big global players but big enough to justify the required investments for a niche company such as Dynaset.

Dynaset has grown from a modest one-man company to the market leader of the world in its dedicated branch of hydraulics applications. Thanks to high quality and innovativeness, the company has been able to successfully expand its business worldwide. The products are sold directly to more than 40 countries. About 90% of Dynaset's products are exported, 70% directly and 20% through Finnish producers using Dynaset equipment as a component in their own export products.

From the furnace model point of view, Dynaset occupies the innovation reactor and the best product levels. The vitality of Dynaset is based on the capability for continuous, innovative engineering work towards new applications of hydraulic machinery. In this area, the imperative of the 'first product' is followed. As the product starts to sell,

the prototype stage is bypassed by progressing to the level of small series, full-scale production. Product designs are not tuned for technological details, but to fulfil particular customer needs.

The founder of the company, Mr Karppinen, has received many awards for his accomplishments as an entrepreneur and innovator. As part of the company's 20-year festivities in June 2006, Mr Karppinen received 'The Golden Entrepreneur Cross' medal from the Finnish Entrepreneurs' Association.

The Teleste case

Teleste is a Finnish company with almost 50 years of history in innovation, currently providing broadband video technology solutions and services for operators, as well as digital transmission systems for surveillance, monitoring and security. In 2009, the international US cable operator Liberty Global awarded Teleste with its Best Vendor award for Best Transport HFC. Liberty Global emphasised the award winners' (Teleste and other laureates, including Cisco, Sun Microsystems, Amdocs and Accenture) ability to create innovative solutions that fulfil the consumers' needs.

Teleste was founded in 1954. In the early stages, the company developed and manufactured radio and aerial components. It soon expanded, in modern terms, from a component manufacturer into a systems provider, when it started delivering common antenna systems for apartment buildings. The R&D capabilities have been used actively to conquer new product segments such as language-teaching studios. More recently, the company business has evolved into technologies for cable television and video surveillance.

Throughout its history, Teleste has reinvented its business, occupying the three topmost levels of the furnace model. The innovation reactor of Teleste has been the iconic landmark of the company. Teleste was the pioneer in cable television antenna systems. Teleste was a pioneer with the language laboratory systems, but divested the business before the market saturated. Currently, Teleste is active in two business areas: video and broadband solutions and network services. The video

and broadband solutions business segment emphasises product solutions for broadband access networks, video head end platforms and video surveillance applications. Moreover, Teleste seeks expanding business opportunities in service business by providing comprehensive network service solutions, mainly for cable networks. The service portfolio consists of network planning, network installation and upgrade projects, as well as field services.

Teleste has systematically divested businesses when the products have evolved into commodities, at the mass product level of the furnace model. Today, Teleste’s manufacturing network contains factories in Finland and China. The Finnish factory is clearly a lead factory, but it also has a strong flavour of prototype and ramp-up factories. The Chinese factory could be classified as a source factory, and it has many more mass production characteristics than the Finnish one.

Figure 6. The role of the Dynaset factory and the Teleste factories in the innovation furnace model

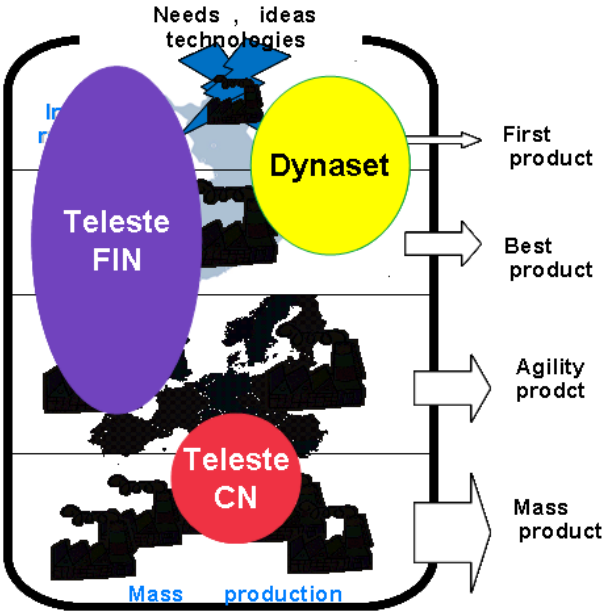

Figure 6 illustrates the roles of the Teleste factories (China and Littoinen, Finland) and Dynaset Ylöjärvi factory in relation to the innovation furnace model.

The NOTE case

For any company, the location of production is dependent on many factors, such as market proximity, labour costs, access to competent labour force, and raw material cost and availability (e.g. Schmenner, 1982). One of the factors is related to the business ecosystem (Moore, 1996). From the perspective of innovation companies, the bottleneck is sometimes related to the suppliers capable of accomplishing tasks to realise ideas into tangible products. In the case of production, the business ecosystem should include manufacturing facilities – in-house or contracted – that are capable of producing prototypes, 0-series and ramp ups of products composed of new technologies.

This case will present that of NOTE Hyvinkää Oy, a part of NOTE AB, a Swedish electronics contract manufacturer with manufacturing units in several European countries and China. NOTE is an example of manufacturing companies which are part of a business ecosystem capable of launching new, innovative products. In its business ecosystem, the role of NOTE is to help the product companies by providing contract manufacturing services, from prototypes up to full-scale production series.

NOTE Hyvinkää Oy, the Finnish daughter of NOTE AB, has its roots in a company called Point Product Oy. During the fast rise of the electronics industry in Finland in the 1990s, Point Product specialised in professional electronics, which at that stage of the industry, typically had short product lifecycles and small production series. The first production facility of Point Product was located in Hyvinkää, Finland. Later, with increasing cost pressures, the company founded a factory in Pärnu, Estonia, close to the factory of an important customer, in order to benefit from cost potential of the near-shore location. In 2004, the company was sold to NOTE AB.

Today, NOTE Hyvinkää Oy can offer three levels of manufacturing

services, first, prototypes and new products produced in Hyvinkää, Finland. The site is close to the R&D premises of a key Scandinavian customer, and especially close to the customer's new product development unit. This site is a prototype and ramp-up factory: 'when the customer's product development engineer visits us less than once in a month, it is time to move the product away from Finland' (a comment of the managing director of NOTE Hyvinkää Oy). Products in the next stage of the lifecycle are produced in Pärnu, Estonia. Pärnu's role as a production site is a source or even a regional lead factory. The third level, mass production for customers in Asia, can be offered through NOTE's own factories or their partners' factories in Far East. The roles of NOTE factories in relation to the customers' production imperatives are illustrated in Figure 7.

Figure 7. The factories of NOTE in their roles to support the customers' production imperatives

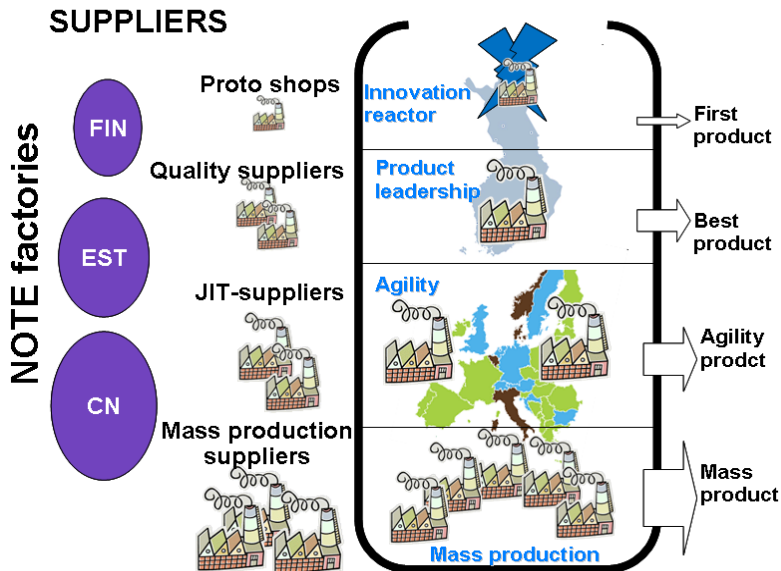

It is interesting that NOTE is not an innovator company as described in the furnace model, even though it provides the necessary manufacturing infrastructure services for the innovative companies in the business ecosystem at all the levels of the furnace model. It is noteworthy that the 'first product' and 'best product' imperatives are served by a factory located in a high-cost location (Hyvinkää, Finland), while 'agile production' is provided by the factory in Pärnu, Estonia (a fairly low-cost location). The most cost-competitive production facilities are located in China, in both own and outsourced factories. In practice, the portfolio is not that black and white due to the transportation costs and delays. This implies that the Chinese factory is not necessarily the optimal location, even cost wise, for the European customers.

The KONE case

KONE is a large European-based company operating globally on three main continents. The company designs, produces, delivers and maintains elevators and escalators, i.e. investment goods used in construction projects. Both of the two major product groups are subject to tight legislative requirements. Both products are customised either through a modular structure or customer-specific engineering. In this case study, we shall focus on one of the two product lines. The corporation has four factories to manufacture this particular product line. Two of them are located in Europe, one in Asia and one in Latin America. The term 'factory' is here used to refer to a production site, which may consist of several subfactories producing different products or modules. This implies that a production site may have multiple modes of operations, e.g. from the perspective of the innovation furnace models. The different modes of operations are typically applied in different subfactories.

KONE has a long history and has been growing strongly, mainly through acquisitions but also organically. Although the growth through acquisitions has brought the company a wide portfolio of manufacturing sites, in recent years, the company has been concentrating on building a truly global operations network with clear roles and responsibilities of the production sites. The current stance of the factory portfolio in respect to the innovation furnace model is illustrated in Figure 8.

Figure 8. The roles of the factories of one product group of KONE with respect to the innovation furnace model

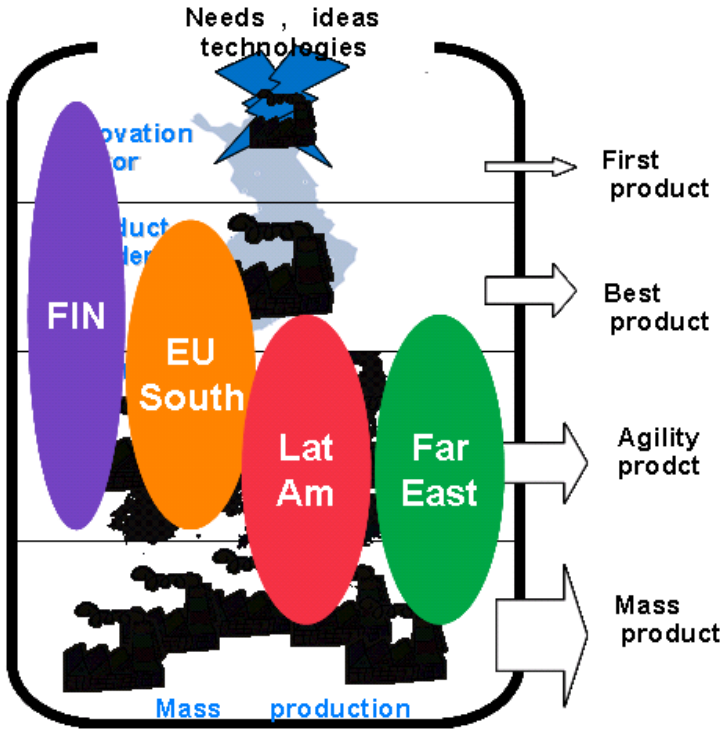

The position of the whole portfolio of factories indicates that the corporation is strongly prepared for the imperative of agile delivery. All four factories can serve the markets flexibly with relatively short notice from the customers. It is interesting that in spite of its competition in the global marketplace, the ‘territory’ of the mass production is fairly weakly populated by the in-house factories of the corporation. This is a conscious choice in the production strategy. The commodity items are outsourced to contract manufacturers. Accordingly, the company leverages the benefits of the lowest cost production capabilities in the supply markets without in-house investments in assets subjected to fierce competition.

The factory site in Finland has the manufacturing role of the innovation reactor in the corporation. Even though the R&D capabilities are dispersed worldwide, the Finnish factory has the most favourable location in terms of the R&D capabilities and facilities. Overall, the Finnish factory has the strongest grip on the Treacy and Wiersema (1995) 'product leadership' strategy in the corporation covering both the imperatives of the 'first product' and the 'best product'.

The other European factory is positioned somewhat similarly to the factory in Finland, but with less orientation towards the 'first product' imperative. The factories in Asia and Latin America are primarily configured to fulfil the agility and mass production based competitive advantage over the global competitors.

CROSS-CASE ANALYSIS

The empirical data to validate our model are not rich, and in nature more anecdotal than rigorous. We have positioned the production facilities of four companies in the spectrum spanned by our innovation furnace model. Three of these cases are product companies, designing, manufacturing and distributing products under their own brand. The role of the fourth case company is to serve as a contract manufacturer for product companies in their value chains. All four case companies are operating in international, partly global markets. Only a minor share of revenue is generated in the domestic markets. Three out of the four case companies have more than one factory, located in high-cost and low-cost countries.

What is common to all the case companies is that the factory located in an HCC (Finland in all the four cases) is focusing on the product leadership strategy to support new product development (the first product) and to satisfy the demand of high-quality market segments (the best product). The empirical case sample of this research at least demonstrates the hypothesis that factories in HCCs should focus on innovation and product leadership-based business ideas. At the company level, the demonstrative evidence is equally clear. Irrespective of the size of the company, each of the four cases exhibits the importance

of the role of the innovation reactor in the economic sustainability of the company. Three of the companies are building their future on own product development and the supporting new product production capabilities in the proximity of R&D resource centres. The fourth case company serves a similar purpose, but by providing contract manufacturing capabilities to support the customers' innovation processes in the proximity of the customer's R&D resources.

Three of the four companies have at least one factory to fulfil the agile production imperative. The fourth one is small, with all the odds on the product leadership strategy. Each of the factories is located in the proximity of the particular markets, either in Europe, Asia or the Americas. However, there are also cross-continental material flows.

All the four case companies are relatively weakly prepared for the mass production imperative. The smallest of the cases (Dynaset) excludes mass markets completely. All the others leverage the mass production capabilities of their suppliers. Even the largest and the most global of the case companies relies on the strategy to focus on high value adding, in-house production.

CONCLUSIONS

This paper has discussed the challenges that manufacturing companies have encountered in the global economy. It has approached these challenges from the viewpoint of companies with their home base in the European HCCs. Specifically, the empirical research material focused on companies with their home bases in Finland and Sweden.

We introduced a model for designing factories to support their primary competitive imperative. These imperatives were linked with the overall business strategies by Treacy and Wiersema (1995), i.e. product leadership, customer intimacy and operational excellence. The product leadership value discipline was further divided into two production imperatives, 'produce the first product' and 'produce the best product'. The former emphasises the capability of production to collaborate with new product development and realise the ideas of R&D

as tangible products at affordable costs and tolerable delivery times. The latter reflects the capability of manufacturing to produce goods and services in full-scale volumes, without sacrificing the quality specifications and expectations of the customers. In our model, the value discipline of customer intimacy was reflected as an agile production imperative, while the operational excellence discipline called for the mass production imperative.

Our model has four layers, each of which focuses on a particular production imperative and the associated core capabilities: (1) the production of the first product, (2) the production of the best product, (3) agile production and (4) mass production. The perspective of this paper is that of a manufacturing company with production facilities in HCCs such as Finland and other Nordic countries. In this spirit, we advocated and demonstrated that the production of factories located in HCCs should focus on the imperatives (1) and (2) above, and partly on (3). Mass production in HCCs seems seldom justified. Our empirical sample supports this reasoning.

What kinds of manufacturing capabilities are needed in different layers of an innovation company? The factories in the innovation reactor are by nature laboratories and prototype factories up to the point where first products are out in the market. If the goal is rapid growth, it is advantageous if the manufacturability and the suitability of the new products for larger-scale production has been considered. After prototyping, production needs to be ramped up for commercial deliveries. There are no general rules if the production capabilities at this stage require intermittent or continuous production processes. Sometimes, for investment goods, even a one-off production process will do, although generally at least some sort of repetitive, small lot size production is required to meet the quality and cost norms. At the best product layers, the production processes must be optimised, usually by tuning the production into small-series manufacturing. Thus, manufacturing engineering capabilities are a must. In the agility layers, the factories should be designed for short lead times and flexibility. In HCCs, this requires flexible manufacturing and assembly technologies. In LCCs, there are more degrees of freedom to achieve flexibility tar-

gets by low-cost manual work. In the mass production layer, the cost targets dominate over all the other objectives. Due to high volumes, flexibility is not that critical. However, mass production does not mean tradeoffs when it comes to quality norms. It is interesting that none of our case companies possessed strong capabilities in low-cost mass production. The required cost efficiency of the commodity items was achieved through outsourcing the production of commodity items from low-cost contract manufacturers.

It is also worthwhile to recognise the global operations' skill and competence requirements in the agility and mass production layers. As we have demonstrated, factories in the agility layer and especially in the mass production layer are located outside Finland and other HCCs, and are typically distributed to LCC countries in Asia or other emerging markets. Consequently, skills related to global operations management, global sourcing and procurement, as well as technology transfer, become crucially important.

When it comes to the future of production facilities in Finland, it is likely that manufacturing industries will employ fewer people in HCCs. Before the most recent financial sector-triggered economic turmoil, the manufacturing industries employed roughly half a million workers in Finland. Perhaps 350,000–400,000 will be employed in future. The share of production-related jobs would exhibit a deeper decline, while the number of product development, product management, exports, sourcing, and other knowledge-intensive job positions would grow, at least relatively. We have suggested that at least the following capabilities will be of use for the future factories located in HCCs such as Finland (Eloranta et al., 2010):

- Building and testing of new technologies;
- Building of prototypes and first series of new products;
- Building the first products in the market;
- Ramping up the volume of production;

- Just-in-time and agile production;
- Production of customised products and product variants;
- Manufacturing of core components (even in the mass production phase if feasible cost wise); and
- Integration of products (for example, assembly and testing).

Based on our case research, we believe that the tasks outlined above contain the essence of future manufacturing in HCCs.

FURTHER RESEARCH

This book chapter proposed a model to support the decision making to locate factories in relation to the business lifecycle of the value offering of the company under study. We suggest that factories to be located in HCCs should support and enhance the innovation processes of the company. The evidence supporting our ideas is somewhat anecdotal. Therefore, it would be natural to continue our research with rigorous validation of our ideas using more in-depth case studies and statistically relevant observations with larger samples.

REFERENCES

- Agrawal, W.D., Farrell, D., & Remes, J.K. (2003). Offshoring and beyond, cheap labor is the beginning, not the end. *McKinsey Quarterly*, 4, special edition, 24–35.
- Bay Area Forum. (2005). *One million jobs at risk. The future of manufacturing in California*. San Francisco: Bay Area Economic Forum, A Partnership of the Bay Area Council and the Association of Bay Area Governments.
- Brown, J.S., & Hagel, J. III (2005). Innovation blowback: Disruptive management practices from Asia. *McKinsey Quarterly*, 1, 34–45.
- Collin, J., Eloranta, E., & Holmström, J., (2009). How to design the right supply chain for your customers. *Supply Chain Management: An International Journal*, 14(6), 411–417.
- Courtney, H., Kirkland, J., & Vigurie, P. (1997). Strategy under uncertainty. *Harvard Business Review*, 75(6), 67–79.
- Eloranta, E., Ranta, J., Salmi, P., & Ylä-Anttila, P. (2010). *Teollinen Suomi* [Industrial Finland]. Helsinki: SITRA.
- Farrell, D. (2006). Smarter offshoring. *Harvard Business Review*, 84(6), 84–92.
- Ferdows, K. (1997). Making the most of foreign factories. *Harvard Business Review*, 75(2), 73–88.
- Hammer, M. (2004). Deep change. How operational innovation Can Transform Your Company. *Harvard Business Review*, 82(4), 84–93.
- Heikkilä, J., & Ketokivi, M. (2005). *Tuotanto murroksessa* [Production in a turning point]. Helsinki: Talentum.

- Heikkilä, J. (2009). *Tutkimus hankintojen osuudesta liikevaihdosta vuodesta 1999 vuoteen 2009*. [A study of the share of purchased goods and services of revenue]. Espoo, Finland: Helsinki University of Technology.
- International Monetary Fund (2011). World Economic Outlook, 2011; <http://www.imf.org/external/pubs/ft/weo/2011/update/01/index.htm>
- Johansen, J., & Riis, J.O. (2005). The interactive firm—Towards a new paradigm. *International Journal of Operations and Production Management*, 25(2), 202–216.
- Ketokivi, M. (2006). *When does co-location of manufacturing and R&D matter?* Discussion paper nr 1051. Helsinki: ETLA (The Research Institute of the Finnish Economy).
- Lewin, A.Y., & Peeters, C. (2006). The top-line allure of offshoring. *Harvard Business Review*, 84(3), 22–24.
- Moore, G. (1991). *Crossing the chasm: Marketing and selling high-tech products to mainstream customers*. New York: HarperCollins.
- Moore, G. (1998). *Inside the tornado*. New York, HarperBusiness.
- Moore, J. (1996). *The death of competition: Leadership and strategy in the age of business ecosystems*. New York: HarperBusiness.
- Pisano, G., & Shih, W.C. (2009). Restoring American competitiveness. *Harvard Business Review*, 87(7–8), 114–125.
- Reichart, A., & Holweg, M. (2008). Co-located supplier clusters: Forms, functions and theoretical perspectives. *International Journal of Operations and Production Management*, 28(1), 53–78.

- Riis, J.O., Johansen, J., Vejrum Waehrens, B., & Englyst, L. (2007). Strategic roles of manufacturing. *Journal of Manufacturing Technology Management*, 18(8), 933–948.
- Schmenner, R. (1982). *Making business location decisions*. Englewood Hills, NJ: Prentice-Hall.
- Steelonthenet.com (2009). http://www.steelonthenet.com/labour_cost.html, 9 September 2009
- Swamidass, P.M., & Newell, W.T. (1987). Manufacturing strategy, environmental uncertainty and performance. A path analytic model. *Management Science*, 33(4), 509–524.
- Treacy, M., & Wiersema, F. (1995). *The discipline of market leaders: Choose your customers, narrow your focus, dominate your market*. New York: Addison Wesley.
- Turkulainen, V., & Blomqvist, M. (2010). What is the future of manufacturing in Western countries? Analysis of plant roles. Paper presented at the 15th International Manufacturing Symposium: Innovation in global manufacturing—new Models for sustainable capture. Cambridge, UK, 23–24 September.
- Tushman, M., & Nadler, D. (1986). Organizing for innovation. *California Management Review*, 27(3), 74–92.
- Vehtari, S. (2006). The dynamics involved with manufacturing capabilities towards a competitive advantage. Doctoral dissertation series 2006/1, Espoo, Helsinki University of Technology.

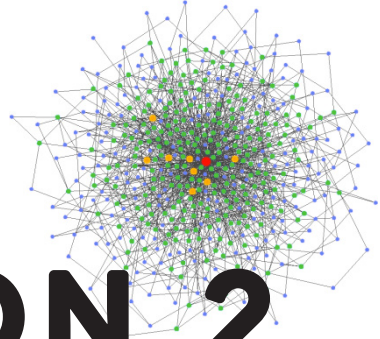

SECTION 2

CASE 1

Consequences and Opportunities of a Global Two-Factory Production Network

Anna Fredriksson, *Linköping University, Sweden*

Patrik Jonsson, *Chalmers University of Technology, Sweden*

INTRODUCTION

This is a case concerning the design and utilisation of a network of two factories (here called a two-factory production network). The two-factory production network consists of one factory in Sweden and one in China. It is a Swedish company that has outsourced part of its casting processes to Chinese suppliers. In connection with the outsourcing of the casting processes, a Chinese company was established with the purpose of manufacturing similar final products as the Swedish company for the Chinese and South-East Asian market. This Chinese company machines and quality controls the outsourced casting goods before shipping them to Sweden. Casting goods are quite standardised and mature items, physically nonsensitive to transport and with a low value. However, casting goods put some very specific requirements on the supply chain depending on their physical characteristics and how they are produced. Casting goods are in most cases voluminous items and are normally transported by sea. Quality defects are sometimes only discovered after processing, and the scrap rates are often quite high compared to other items.

During the past decades, the conditions for the production industry have changed considerably; the external business environment has become more global as international trade has increased massively

(Kleinert, 2003, Feenstra, 1998; Kleinert, 2003). Globalisation has opened up new markets for companies to sell their products in and from which to identify new suppliers. Developments in information and communication technologies have facilitated the ability of organisations to globalise production and access new markets (McIvor, 2006). The globalisation of markets and improved communication technologies together increasingly bring about a redesign of the value adding chain (Feldmann et al., 1996). It has become increasingly important to establish and manage one's position within global production networks (Karlsson, 2003). Many Western companies today try to understand how best to combine global low-cost country sourcing with local sourcing and in-house manufacturing to get the benefits from all of these practices. The question these companies need to answer is how to catch the opportunities of global production networks, including factories with very different conditions. This is also true for the Swedish company presented here.

The case is presented below, and the question for the Swedish company is how it can make the best of the situation and take advantage of its global production network.

THE GLOBAL TWO-FACTORY NETWORK

This section presents the case study of a global two-factory production network in a supply chain of casting goods. The casting goods are a main component in the final product produced both in the Swedish and the Chinese factory, although at present, the factories are serving different markets with their final products.

The supply chain

The Swedish manufacturer (EM) was founded in 1901, and since 1968, has belonged to an American corporation. EM has about 4,000 employees and produces between 100,000 and 110,000 final products in 20,000 to 30,000 variants annually, with main markets in the US and Europe. The products are used in wet environments and are relatively heavy and large in size. Product lifecycles are long and the spare part commitment is 15 years after the end of production. The head office, including

product development, is in Stockholm, Sweden, with the production in the south of Sweden and two central warehouses: one in France and one at the production site. EM's production includes a foundry and five workshops where machining, assembly and tests are performed. The Chinese manufacturer (CM) is also a subsidiary within the American corporation, has about 200 employees and is situated in Shenyang. CM was established in the mid-1990s and makes a similar but smaller assortment of products to EM. The sales of finished products on the Asia-Pacific market comprise 84% of its turnover and 16% are supply of items, mainly to three European original equipment manufacturer (OEMs) in the American corporation. EM is its largest OEM customer.

Figure 1: Organisation structure of the American corporation (AC)

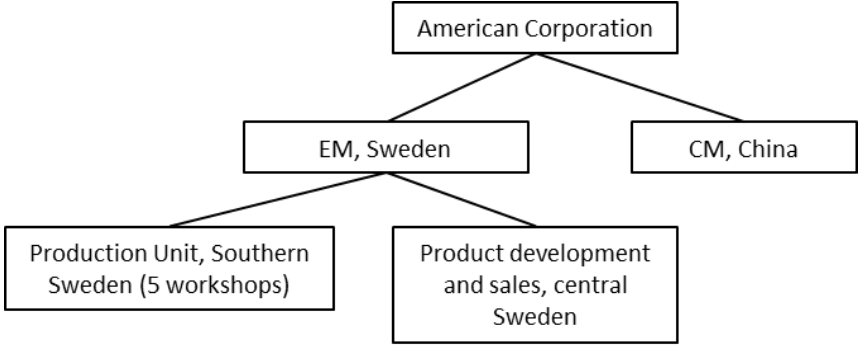

EM has the capability and capacity to manufacture all parts of the final product within its own facilities. The EM production includes a foundry and five workshops, with machining, assembly and testing. The five workshops focus on different sizes and materials of the final product. Three are supplied with castings from China. EM purchases about 300 casting items and produces about 1,000 items in its own foundry. At present, about 50 casting items are sourced from China. EM manufactures about 240 tons per week and receives about 10–11 tons of castings from the CM per week. The EM demand has historically been even,

with only minor variation each year, although a few years ago there was a sudden increase in demand. This resulted in an increased supply from China in order to handle capacity problems in the EM production. However, last year, there was a downturn in demand, and since then, EM has had problems filling its own capacity.

One or two containers are sent each week from CM to EM by ship. The shipping time by sea from the Chinese port in Dalian to the Swedish port in Åhus is about seven weeks. The transport between the factories and the ports are carried out by trailers. The shipping delivery precision is considered good by EM. EM has experienced some problems with the supply from China; for example, deliveries are sometimes delayed and contain too small quantities or unacceptable quality. One specific problem for EM is to know what will be delivered, since EM does not receive a list showing exactly what items and volumes are included in the shipment until the ship leaves port in China.

What is sent from CM to EM is dependent on weekly updated orders based on forecasts. The forecast is a 15-week rolling forecast based on historical sales and moving average calculation. Orders are placed eight weeks in advance of estimated arrival at EM. In order to not miss deliveries to EM, CM produces casting items to a finished goods inventory and delivers to EM from this inventory. The Swedish CEO of CM finds it frustrating that tied-up capital of CM is increased by the necessity of having large inventories to meet EM demand on service level. One problem connected to CM being a distant supplier is the order cycle time. This depends on the shipping time of about seven weeks. The long lead times also create long ramp-up times for increases in demand. It takes about two to three weeks before changed volumes are shipped from CM. The quality problems and the long lead times and order cycle times make it necessary to keep quite high safety stocks at EM for items sourced from China. This is frustrating for EM, as it increases the cost of sourcing from China, and the idea behind sourcing from China is to decrease costs by utilising the low labour costs there. The estimated average lead times and inventory levels of EM are shown in Table 1.

Table 1: Transport and EM production characteristics

Factor	Case data
Transport from China	6–8 weeks
Lead time for foundry, machining and administration, EM	1–3 weeks
Inventory safety stock, EM	2–7 days' consumption
Inventory cycle stock, EM	2 weeks' consumption

Casting items arriving from China to EM are preprocessed in China, and after goods reception and quality control at EM, delivered into the inventory of the workshop where it is to be used. Several items from China are used in more than one workshop, although each workshop at EM has a separate inventory.

The CM plant has similar production resources to EM, except for the foundry and engine production processes. CM buys casting goods from Chinese suppliers. These are either used as incoming material in the production of CM's own products or delivered to its OEM customers. The main operations carried out by the suppliers are casting (foundry) and machining. Most foundries and machining subcontractors are located geographically close to the CM plant, often within one day of transportation. There are about 10 active suppliers of casting goods, but 80% of the volume is purchased from four major suppliers, located about four hours from CM. The roads from Shenyang to the coast are well-kept asphalted roads; however, some of the roads from Shenyang and inland to the suppliers are gravel roads, which can be very demanding to use.

It is difficult for CM to find suppliers that can perform multiple operations – as yet, it has been unable to identify any supplier able to

carry out all operations required. Although there are some suppliers with both foundry and machining capabilities, CM must use special foundry suppliers and special machining subcontractors. The machining subcontractors are in general underutilised, and therefore often accept orders with short notice. At present, washing, quality control and packaging are always carried out by CM in its own plant in order to catch defective goods. The different capabilities of the suppliers and the number of operations a supplier can perform create very different supply chains within China for CM. Figure 2 describes two typical supply chains of casting goods for CM. Supply chain (a) represents the characteristics of the 'short' chain, where one supplier conducts both casting and machining. Supply chain (b) illustrates the 'long' chain, where casting and machining are carried out by different suppliers and casting goods fail quality control and must be returned to machinery for rework and sometimes also to the foundry.

Figure 2. Short (a) and long (b) supply chains of casting goods to CM. F=foundry, M=machining, W=washing and Q=quality control. A triangle illustrates an inventory, a circle illustrates an operation and an arrow illustrates a material flow

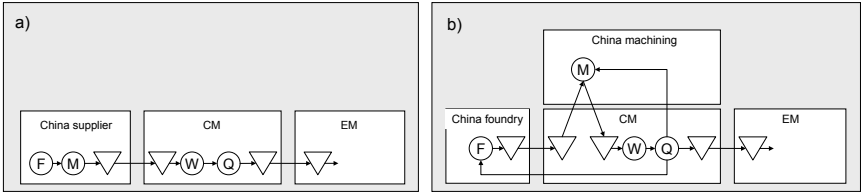

The uncertainty in lengths of lead times and quality levels differs between the best- and worst-case supply chains in China (Figure 2; see also Table 2), although low product quality is a general problem among the suppliers, especially among foundries. Therefore, as the supply of castings from China began, there were major quality problems with the goods received by EM. However, over the years, the product quality of the items arriving from China has improved from poor to generally

good; today, the quality is about the same as items from European casting suppliers or from the local foundry. This is because CM has become better at stopping defective goods in China, not because the quality has improved among the Chinese suppliers. At present, quality control is carried out both before leaving China and on arrival at EM. The improved quality level has made it possible for EM to consider decreasing the quantity of quality controls on the goods arriving from China.

Table 2. Characteristics of supply from CM

Factor	Short supply chain	Long supply chain
Delivery times, Chinese foundry suppliers	N/A	2–7 weeks
Delivery times, Chinese machining	3–5 weeks (including foundry)	2–4 weeks
Inventory throughput time, CM	2–3 weeks	2–3 weeks
Washing and quality control lead time, CM	1–2 weeks	1–2 weeks
Total lead time, China	6–10 weeks	7–16 weeks
Product quality level	93%	90–97%

Note: Figures in Table 3 are estimates given by the CM CEO, purchasing manager, quality manager and logistics manager. Monitored actual figures are used when available.

The existing strategy of combining supply of castings from EM and CM are based on different criteria. EM prefers to source items with large volumes from China. However, the decision is also based on price and transportation costs. A desire to order full packages of an item affects the volumes of what is sourced from China. Some products are also sourced from China to increase purchasing volumes of items also

needed by CM. Another reason for sourcing in China on the EM side is when the EM foundry needs capacity support. The American corporation also has a percentage goal of sourcing a minimum proportion of the total purchase volume from China. To reach this goal, EM also needs to source nonvolume products from China. This is not popular within EM, as it increases inventories of low-volume goods. What products, and how large volumes, are sourced from China are dependent on all of the above criteria, which makes the decisions a bit random.

Consequences of low cost sourcing

Consequences of low-cost sourcing on the supply chain can be described via three categories of characteristics: the supply network structure, the supply network relationships and characteristics of low-cost countries (Fredriksson & Jonsson, 2009). The main dimensions of the characteristics are outlined in Table 3. These are used below to describe the consequences of the two factory network used for supply chain of cast iron goods.

Table 3. Summary of sourcing characteristics (Fredriksson & Jonsson, 2009)

Category of sourcing characteristics	Sourcing characteristics dimension
Supply network structures	Layering and tiering Plant roles
Supply network relationships	Business relationships Operative dependencies and transaction costs
Sourcing country characteristics	Infrastructure Culture Human capital Policies and regulations

Layering and tiering. The supply chain is a network of long distances, covering several time zones. The supplier structure in China also var-

ies due to a lack of suppliers that can offer multiple operations (see Figure 2). This creates considerable differences in lead times and product quality between the short and long supply chain in China (see Table 2). The long supply chain requires several suppliers to complete an item, and increasing lead times as a result. Due to the increased unreliability of the supply chain and product quality, it is also then necessary to increase inventory levels at CM to ensure the agreed service level to EM. In the short supply chain, these problems are reduced, as there are fewer echelons in the supply chain and the product quality is generally better. The long lead times in China and the shipping time to Europe of seven weeks increase the planning horizon for EM and make it necessary to base Chinese purchase orders on forecasts. EM must also manage all short-term demand changes through its internal capacity. This is not popular among EM production planners, as it leads to replanning. Because of the long delivery times by ship, it is also sometimes necessary to use more costly air freight, increasing the total price of the goods sourced from China. The long lead times in China also create long ramp-up times when demand increases. It takes about two to three weeks before changed volumes are shipped from CM, making it difficult to plan and make changes in items and orders. The quality problems and long lead times make it necessary to maintain safety stocks at EM for items sourced from China.

The role of plants. CM was originally established to serve the Chinese and Asian markets and to open up sourcing from China for EM. To ensure product quality and to ensure or reduce lead times to EM from China, i.e. to increase overall delivery dependability, it is necessary for CM to act as intermediary and handle quality control, communication and holding inventories. Using CM as an intermediary makes it possible for EM to obtain a low-cost supply of castings from China. It would have been very burdensome for EM to handle the product quality problems and communication from Europe with the Chinese suppliers. This would require a lot of travelling forth and back by the EM purchasers. In the early days of CM, CM needed EM's demand to fully utilise its capacity; today, however, the deliveries to EM oblige CM to carry out operations when they lack space and time, creating order backlogs and increasing delivery times for other customers. According

to the Swedish CEO of CM, CM would like to use its resources to focus on its own market supply, the Chinese and South-East Asian market. Such a focus would enable growth in this area. One positive effect of CM's presence in China is that it opened up the Chinese and Asian markets and supply market for the whole AC, including EM.

Business relationships. Low product quality is a general problem among the current suppliers in China, especially the foundries, and there is a lack of knowledge transfer and communication about delivery and product quality requirements from CM to its suppliers. CM is also a relatively small customer to most suppliers, and this is one reason why it cannot convince suppliers to adjust to its requirements. Another effect of its weak position towards suppliers is that suppliers often prioritise deliveries to other customers when there are delivery problems, in spite of delivery agreements with CM. Since it is difficult to find trustworthy and reliable suppliers in China, CM has spent considerable effort finding new suppliers or developing relationships with the best active suppliers to further improve the best supply chains.

The EM–CM relationship is not trouble free. Within EM, there is some resistance to sourcing from China, which makes employees less cooperative. Several employees within EM question the point of sourcing from China when EM does not fully utilise its own resources, especially as the reason for sourcing from China stems from a decision made by the board of the AC, and therefore the practice was forced upon EM. The lack of cooperativeness is evident in communications, in among other things, a lack of explanation of drawings and instructions provided to CM. Some of the sourced items have also been too complex to produce at the right quality, which has further increased problems for CM. In addition, drawings and prototypes are not interpreted in exactly the same way, leading to extra administration, which also negatively affect the planning processes. The resistance to CM at EM is sometimes shown by employees almost looking for errors in the items arriving from China. However, some of the problems experienced by EM with the supply from China, such as communication and cooperation, product quality and supplier reliability, have been improved during the years. To further integrate the two organisations, the respon-

sible purchaser at EM visits CM in China five to six times a year for about two to three weeks, and a Swedish CEO has been hired for CM.

Operative dependencies and transaction costs. What is sent from CM to EM depends on weekly updated orders based on forecasts. The forecast is a 15-week rolling forecast, based on historical sales and a moving average calculation. Orders are placed eight weeks in advance of delivery. The unreliability of Chinese casting suppliers in terms of product quality, lead-time length and variability has in the past created shortages at CM, resulting in delivery problems to EM. To be able to deliver to EM at the appropriate level, CM has been forced to make a larger proportion of its assortment to stock and maintain high safety stocks in the finished goods inventory. CM must also quality control all items received from Chinese suppliers. Thus, quality problems, long lead times and deficiencies in delivery precision – as well as the need to maintain the appropriate delivery quantities and qualities for EM – decrease CM's ability to reduce tied-up capital and production costs and free resources to produce for its own markets.

The low reliability of the Chinese item manufacturers further increases the need to manage the volume and product mix flexibility in-house, not only at CM but also at EM. EM feels that it cannot trust the supply chain from China, and does not know when and what will be delivered until the ship leaves port. Because of the overall lack of reliability of supply, EM must manage flexibility in-house, which increases inventories at EM, too. It also compels EM to keep its in-house production planning open for short-term changes in priorities, depending on what is sent from China. This relates to earlier studies showing that business processes such as demand forecasting and material planning are dependent on effective communication; however, effective communication is obstructed by different cultures, languages, practices and time zones (Brannemo, 2006; Levy, 1995; Mattsson, 2002; Meixell and Gargeya, 2005; Mol et al., 2005). Some items sourced in China have been too complicated for CM to produce, and this has resulted in product quality issues. Product quality has recently improved, however, with the result that EM is considering reducing the quality control of goods delivered from China.

Culture. The Chinese workforce is very mobile – the majority of current factory workers are what are called the floating population, coming from rural areas to the cities to look for work (Handfield & McCormack, 2005), and Chinese workers have a tendency to change jobs frequently. At CM, employee turnover was about 10% per year, which is considered high. Cultural differences can also result in innovation barriers and different understandings of tolerances and specifications of products (Nellore et al., 2001; Smith, 1999). There have been a number of culture-related problems between CM and EM resulting from language difficulties and differences in thinking, especially between departments of the two companies that do not regularly meet. As a result of lack of common mind set, both sides consider the quality of communicated information to be low, leading to extra administration and a negative effect on planning processes.

Human capital. There is high employee turnover in China, which can be a problem for manufacturers that rely on trained and skilled workers, and in more developed regions of China there is a shortage of available labour (Handfield & McCormack, 2005). In CM's experience, it has been difficult to find skilled personnel in China and difficult to keep them. The Swedish CEO expresses frustration over the fact that well-functioning employees have a tendency to move on to new jobs, especially as there are several Western companies established in the neighbourhood of the factory and these are looking for Chinese workers experienced in working in Western companies. Knowledge of supply chain management among CM personnel and CM's suppliers is not considered sufficiently high to optimise the supply chain as a whole rather than specific parts in isolation. CM argues that Chinese suppliers lack understanding about the consequences for other parts of the supply chain of defects in product quality and low delivery reliability. This creates problems of late deliveries and low product quality, and results in an environment already in China where deliveries and product quality cannot be trusted. Therefore, a great deal of effort has been spent on trying to identify new and further develop relationships with the best-performing current suppliers. For EM, one of the positive aspects of sourcing from China is the low-cost workforce, which is reflected in product prices.

Policies and regulations. Intellectual property rights protection and legal systems in some low-cost countries, including China, are less mature than in Western countries (Song et al., 2007). Countries with rapid social change increase the risk of participants nullifying or changing contracts (Schniederjans & Zuckweiler, 2004). There is also a risk of copying or suppliers using the companies' products or drawings when supplying another customer with goods, which decreases sourcing companies' willingness to share information (Handfield & McCormack, 2005; Song et al., 2007). CM must deal with Chinese suppliers who do not adhere to what has been agreed upon. However, CM has little power over its suppliers, and suppliers sometimes prioritise other customers rather than the agreements made with CM. The result has been that Chinese suppliers cannot always be trusted, and dependability and service are considered low. One example of this is that if CM pushes deliveries, some suppliers still deliver even if they do not have the necessary material, and even if they know the quality is substandard. The suppliers sometimes do not accept that they are responsible for a product quality problem; instead, they claim that the problem occurred during transportation, handling or in the CM process during washing.

Infrastructure. The transportation structure in China is at present below European levels: There are bottlenecks and congestion not only due to capacity constraints and equipment performance, but also politics and a low level of logistics planning (Handfield & McCormack, 2005). The telecommunications and transportation infrastructure in China differs between regions, and the more developed regions with functioning infrastructures also have higher labour costs (Song et al., 2007). These more developed regions of China also have other problems: worsening pollution, overheated infrastructure and power bottlenecks (Handfield & McCormack, 2005). Most foundries and machining subcontractors are located close to the CM plant, often within one day of transportation. Making infrastructure an issue not considered to result in any significant consequences. However, some suppliers are located in more rural areas, where poor road quality can sometimes be a problem.

CONCLUDING MARKS AND DISCUSSION

This section summarises the case and discusses the opportunities of how the companies can utilise the two-factory production network.

Above, a two-factory production network, and how it is utilised today, has been introduced. It can be seen that there are several positive and negative consequences of having a global production network with two factories in very different settings and with very different prerequisites. Western companies sourcing from low-cost countries are usually driven by a wish to increase competitive advantage by decreasing the labour costs through utilising the low wages in these areas (Markides & Berg, 1988). However, it is important not to assume that low cost country sourcing is simply low labour cost country sourcing, since all associated costs and risks of sourcing should be taken into account (Nelson & Sisk, 2005). How the production network is designed affects how the flow and storage of goods and information exchange should be managed. A production network including several organisations increases the amount of uncertainty that needs to be managed while at the same time decreasing management control over the flows in the network (Fawcett, 1992), because coordination becomes harder as it requires efforts and resources from more than one organisation. The company becomes more dependent on the performance of others; for example, manufacturers suffering from disturbances in inbound flows from suppliers may also have disturbances in outbound flows to customers (Svensson, 2001). It is necessary, when making design decisions, to weigh possible cost reductions against changes in the ability to deliver on time and the flexibility to respond to changes in customer demands (Bengtsson & Dabhilkar, 2009). Therefore, it is not obvious what the effects of using both low-cost country and local supply are.

It can be seen that both EM and CM are ambivalent regarding how the production network is organised today and how the production resources are utilised. It is not obvious for either of the companies how the production network should be utilised in the future. It can be seen that multinational companies organise themselves to best address the tradeoff of global integration and in-house responsiveness (Colotla et al., 2003). Sourcing from low-cost countries may be seen as a balancing

act between lower production costs in low-cost countries and lower transaction costs in-house (Mol et al., 2005). Outsourcing of production leaves two options for the structuring of the supply network: either complete outsourcing of an item or process, or combining external sourcing and in-house manufacturing. According to Ferdows (2008), a mix between a footloose and rooted production network is preferred by many companies, but the companies have to be careful and organise the production network in an appropriate way. Otherwise, there is a great risk that companies slide into footloose manufacturing which is almost impossible to turn around once discovered. Ferdows (2008) takes the example of Zara as a company which is able to combine a rooted production network for time sensitive and complicated products and a footloose production network for simple conventional products. About half of its demand is characterised as predictable and stable and is made to stock, and half is uncertain and made locally with very short lead times. Several other companies, especially in the fashion industry, use similar strategies (Christopher & Towill, 2001).

Choosing strategy for how to combine global sourcing and in-house manufacturing, i.e. accomplish the right mix between footloose and rooted production networks, includes selection of what items to source where and in what volumes. Item selection for sourcing in low-cost countries should be made on the basis of what gives the most benefit, while restricting oneself to in-house manufacturing of those items or part volumes of the item demand which are most likely to manifest great obstacles (Smith, 1999). Complete outsourcing of an item can be a variant of the focused factory concept presented by Skinner (1974), although then, the question is raised of what items should be produced in which factory. Further, depending on the reason for outsourcing and if it is to come closer to a market, one strategy is to divide the markets between the factories and let one factory supply one market. However, these strategies can be further developed into variants and there are perhaps other possible strategies. Consequently, there are several ways in which the factories in a two-factory network can be utilised to gain the most positive performance effects. Coming back to Ferdows' (2008) warning – that companies has to be aware of how to combine a footloose and rooted strategy – The danger is when a company slowly slips

into a footloose strategy when their products and demand are better suited for a rooted strategy. However, above it can be seen that there are several possibilities in terms of how to develop the combined strategy; thus, what is important is that it is an aware strategy. EM and CM have not yet so far had an aware strategy of how to utilise their production network, though by drawing the attention to the possibilities and the risks, they can develop a strategy that fits their prerequisites.

By the means of simulation, two different strategies of how to utilise the production network of EM and CM were tested (Fredriksson et al., 2010). A new combination strategy (strategy 2, base-surge strategy) of sourcing items with predictable and stable demand in China was compared to the present strategy (strategy 1, random strategy), where items were selected on a random basis.

1. Random strategy: The first strategy is as similar as possible to EM's present strategy of combining in-house production of castings and sourcing from China. The present strategy is to source a percentage of the total needed casting volumes from China. What items and what volumes are sourced from China are randomly distributed within the total volume.
2. Base-surge strategy: The second strategy is to source specific proportions of each item in China, a so-called base volume. The volumes produced in China should have predictable and stable demand, while the volumes made in-house in Europe could have uncertain demand. The predictable and stable demand will be modelled with a fixed percentage of the average demand in the simulation model. The fixed quantities will be ordered from CM, and EM will handle the balance.

The new combination strategy would allow CM to decrease its inventories, since demand from EM would be more predictable and improve forecasting accuracy. To handle the uncertain demand in-house at EM would not be a change for EM, since they already handle flexibility in-house due to the long lead times from China. However, EM would probably receive improved customer service from CM, which

would decrease the uncertainty and make it possible to decrease safety stocks at EM. The results of the simulations showed that sourcing predictable and stable demand in China while handling uncertain demand in-house decreased inventory levels both in China and in-house at EM; the results were significant at the $p < 0.01$ level (Fredriksson et al., 2010). The inventory at CM decreased by 23%, while the inventory level at EM decreased by 6%. This shows that the strategies of combining in-house manufacturing and global low-cost supply chains by separating predictable and stable demand and uncertain demand used by, for example, fashion industry companies (Ferdows et al., 2004) are also applicable for other industries.

REFERENCES

- Bengtsson, L. & Dabhilkar, M. 2009. Manufacturing outsourcing and its effect on plant performance - lessons for KIBS outsourcing. *Journal of Evolutionary Economy*, 19, 231-257.
- Brannemo, A. 2006. How does the industry work with sourcing decisions? Case study at two Swedish companies. *Journal of Manufacturing Technology Management*, 17, 547-560.
- Byrne, P. M. 2005. Global sourcing: Opportunities and Approaches For the 21st Century. *Logistics Management*, January, 27-28.
- Carter, J. R. & Narasimhan, R. 1990. Purchasing in the International Marketplace: Implications for Operations. *Journal of Purchasing and Materials Management*, 26, 2-11.
- Christopher, M. & Towill, D. 2001. An integrated model for the design of agile supply chains. *International Journal of Physical Distribution and Logistics Management*, 31, 235-246.
- Colotla, I., Shi, Y. & Gregory, M. J. 2003. Operation and performance of international manufacturing networks. *International Journal of Operations and Production Management*, 23, 1184-1206.
- Fawcett, S. 1992. Strategic logistics in co-ordinated global manufacturing success. *International Journal of Production Research*, 30, 1081-1099.
- Feenstra, R. C. 1998. Integration of trade and disintegration of production in the global economy. *The Journal of Economic Perspectives*, 12, 31-50.
- Feldmann, A., Olhager, J. & Persson, F. 2009. Designing and managing manufacturing networks - a survey of Swedish plants. *Production Planning and Control*, 20, 101-112.

- Feldmann, K., Rottbauer, H. & Roth, N. 1996. Relevance of assembly in global manufacturing. *Annals of the CIRP*, 45, 545-552.
- Ferdows, K., Lewis, M. & Machuca, J. 2004. Rapid-fire fulfilment. *Harvard Business Review*, 82, 1-6.
- Fredriksson, A. & Jonsson, P. 2009. Assessing consequences of low cost sourcing in China. *International Journal of Physical Distribution and Logistics Management*, 39, 227-249.
- Fredriksson, A., Jonsson, P. & Medbo, P. 2010. Utilizing the potential of combining local and global supply chains. *International Journal of Logistics - Research and Application*, 13, 313-326.
- Handfield, R. B. & McCormack, K. 2005. What you need to know about sourcing from China. *Supply Chain Management Review*, 9, 28-36.
- Jin, B. 2004. Achieving an optimal global versus domestic sourcing balance under demand uncertainty. *International Journal of Operations & Production Management*, 24, 1292-1305.
- Karlsson, C. 2003. The development of industrial networks - Challenges to operations management in an extraprise. *International Journal of Operations and Production Management*, 23, 44-61.
- Kleinert, J. 2003. Growing trade in intermediate goods: outsourcing, global sourcing, or increasing importance of MNE networks? *Review of International Economics*, 11, 464-482.
- Lamming, R., Johnson, T., Zheng, J. & Harland, C. 2000. An Initial Classification of Supply Networks. *International Journal of Operations & Production Management*, 20, 675-691.
- Lee, K. & Carter, S. 2005. *Global Marketing Management: Changes, Challenges and New Strategies*, Oxford, Oxford University Press.

- Levy, D. L. 1995. International sourcing and supply chain stability. *Journal of International Business Studies*, 26, 343-360.
- Markides, C. C. & Berg, N. 1988. Manufacturing Offshore is Bad Business. *Harvard Business Review*, 66, 113-120.
- Mattsson, S. A. 2002. Även logistikeffekter bör beaktas vid outsourcing. *Bättre Produktivitet*, 7, 14-15.
- Mcivor, R. 2006. *The outsourcing process - strategies for evaluation and management*, Cambridge, Cambridge University Press.
- Meixell, M. J. & Gargeya, V. B. 2005. Global supply chain design: A literature review and critique. *Transportation Research Part E*, 41, 531-550.
- Mol, M. J., Van Tulder, R. J. M. & Beije, P. R. 2005. Antecedents and performance consequences of international outsourcing. *International Business Review* 14, 599-617.
- Nellore, R., Chanaron, J.-J. & Söderquist, K. E. 2001. Lean supply and price-based global sourcing - the interconnection. *European Journal of Purchasing and Supply Management*, 7, 101-110.
- Nelson, D. R. & Sisk, L. A. 2005. Low Cost Country Strategic Sourcing. *90th Annual International Supply Management Conference*.
- Schniederjans, M. J. & Zuckweiler, K. M. 2004. A quantitative approach to the outsourcing-insourcing decision in an international context. *Management Decision*, 42, 974-986.
- Skinner, W. 1974. The focused factory. *Harvard Business Review*, 52, 113-121.
- Smith, J. M. 1999. Item selection for global purchasing. *European Journal of Purchasing and Supply Management*, 5, 117-127.

Song, N., Platts, K. & Bance, D. 2007. Total acquisition cost of overseas outsourcing/sourcing: a framework and a case study. *Journal of Manufacturing Technology Management*, 18, 858-875.

Svensson, G. 2001. The Impact of Outsourcing on Inbound Logistics Flows. *The International Journal of Logistics Management*, 12, 21-35.

CASE 2

The Dynamics of Make vs. Buy Decisions in a Global Economy – A Firm Study¹⁴

Kari Jussila , Aalto University, Finland

Michael Gylling¹⁵, Accenture, Finland

Markku Saarinen, Helkama Velox Oy, Finland

ABSTRACT

This paper is based on a firm study of a Finnish bicycle manufacturer, which operates in a severe business environment. The firm has its own factory in Finland, but since 2005, it has also sourced end products from the Far East. In autumn 2008, the firm's management decided to out-source its production of one bicycle model to the Far East, and in spring 2010, the firm made the decision of backshoring the production of these bicycles back to the firm's own factory in Finland. As a research strategy, the authors used a single case study method, which was related to operations management and carried out in two phases, in 2007–2008 and in 2010; the research included both qualitative and quantitative analyses. The required make-or-buy product costs were analysed by comparing the total manufacturing costs at the firm's factory with the total landed costs of the sourced bicycles in the firm's factory warehouse. In order to make this cost analysis, the authors constructed an accounting model by which the firm has continuously been reviewing its competitive situation and simulated the financial outcomes of different management decisions. Hence, this paper describes a firm's need for responsiveness

14 Received June 6, 2011, First draft August 31, 2010

15 Researcher at Aalto University during the first phase of the study

for immediate actions when operating in dynamic and global competition. The authors want to contribute to the research by presenting a practical firm study which explores how outsourcing and backshoring decisions were made in a severe business environment.

INTRODUCTION

Over the last 25 years of globalisation, a major part of production has moved to developing countries. Initially, the main driver was not to respond to the growing demand of these markets; rather, the transfer of production was mainly driven by the lower cost basis of these countries. The economics of offshoring have been quite straightforward, where manufacturers have looked for lower cost alternatives in manufacturing products, and hence to fulfil the price demands of their customers, as well as to respond to the even fiercer price competition from offshore competitors (Ferreira & Prokopets, 2009).

In addition to this economic rationale, the offshoring trend has also been reinforced by companies' desire to focus their activities on their core competences and outsource various organisational noncore functions. By offshoring their production activities to low-cost countries, large multinational enterprises (MNEs) have been able to take competitive advantage of the emerging division of global labour markets.

The importance of accurate costs estimates for offshoring decisions are paramount, as one of the two main drivers behind offshoring decisions is purely economic. Many of the economic comparisons have relied too much on comparing the labour and other manufacturing costs between developed and developing countries, with the result that many of the offshoring and outsourcing decisions have not given the promised savings.

Previously, it was claimed that 'backshoring activities of once offshored capacities from foreign locations back to the domestic location are quite common phenomena, which have only made public in the rarest cases and not captured statistically' (Kinkel & Maloca, 2007; Kinkel et al., 2009). Hence, the authors of this paper want to contribute to

this research topic by presenting a practical firm study which explores how the firm made outsourcing and backshoring decisions in its severe business environment.

The case company and its recent production location decisions

This article is based on a case study of a Finnish bicycle company, BikesCo (the name of the case was changed), which started its business operations as a wholesaler and assembler in the early 1900s. The firm has been manufacturing bicycles in Finland since the 1950s. Today, its main business is designing, manufacturing and marketing bicycles. BikesCo has its own factory in Finland, but recently the firm has also started end-product sourcing from the Far East.

Manufacturing bicycles in Finland has become very challenging. The business environment is severe. The domestic demand is saturated and seasonal, and there is a fierce price competition from foreign competitors. Bicycle manufacturers are also quite dependent on a few key component suppliers, which have long delivery times and inflexible supply chains.

At present, BikesCo is the only bicycle manufacturer at an industrial scale remaining in Finland. The firm's competitors have a price advantage over BikesCo due to their remarkably larger production capabilities and lower labour and other manufacturing costs. Since mid-2005, BikesCo, on the lookout for cost competitiveness, has outsourced its production to the Far East as the result of a chain of consecutive decisions.

In autumn 2008, BikesCo decided to outsource all its production of the 'JOPO' bicycles to the Far East. JOPO is a well-known Finnish bicycle brand, which was launched in the market in 1965. As a bicycle brand, JOPO can be best described as a classic and basic bicycle model. The production of JOPOs ceased in 1975, but was returned to production as a retro bicycle model in 2000. Over the last few years, the demand for JOPOs has been increasing, and owning a JOPO has become a new trend.

The decision to outsource the production of JOPOs in 2008 was strongly favoured by the prevailing euro-against-dollar exchange ratio of 1.5, which furthered the cost advantage of imported bicycles. In addition, the firm's supply chain for the sourced bicycles seemed to be more flexible than that of the firm's own production. When considering outsourcing from a financial perspective, the inventories were lower, the capital turnover was faster and the capital was used more efficiently (Gylling, 2008, p.111). The firm's own production was, in turn, dependent on some critical components whose delivery times were so long that these components had to be ordered on sales forecasts months before their delivery.

As a back-up, however, BikesCo's operations management decided to maintain a minimum production capacity for JOPOs and keep a component safety stock available in the factory.

The operations strategy behind the decision was to outsource common, JOPO-type bikes and produce complicated value-added products, like electrically assisted bikes, in the firm's own factory. This decision fits well with Fisher's (1997) article, where he categorises products' demand characteristics as innovative or functional and states that functional products should have an efficient supply chain, whereas innovative products should have a responsive one.

When the economic turmoil began in 2008, the business environment became more stringent for BikesCo. The demand for bicycles fell below expectations in the 2009 season, which worsened the firm's profitability. The factory's cost structure was too heavy to cope with the decreased market demand, and hence the firm's management decided to downsize the factory's production capacity.

The downsizing of the firm's production capacity meant that 27 factory-level workers were laid off, i.e. almost 50% of the factory employees. The decision was based on simulations, where the minimum profitable production capacity was analysed bearing in mind the production level under which the factory should be closed.

The downsized production capacity meant improved cost competitiveness for the firm's factory. Further, the strengthening of the euro exchange rate against the US dollar, in the period of summer 2008 to summer 2010, weakened the profitability of the sourced bicycles in relation to those manufactured in the firm's own factory. At the same time, the demand for bicycles was recovering from the wave trough of the economic turmoil and the firm's profitability began to improve.

By spring 2010, it had become clear to the firm's management that the balance between the firm's own manufacturing and sourcing should be considered anew. It had also become evident that the delivery chain of the sourced JOPO bicycles from the Far East to Finland was not operating as well as had been anticipated at the time when the outsourcing decision was made. Due to the firm's customer requirements and fluctuations in demand in Finland and Europe, the operational flexibility in production and logistics seemed to need improvement. In short, the management of operations as to delivery reliability and quality control suffered from the long, stiff delivery chain.

In 2008–2010, the firm continuously reviewed its competitive situation and simulated the financial outcomes of different management decisions, with the accounting model being developed as a by-product of our case study (as described in the next section).

During spring 2010, the firm's management was considering revising its operation strategy towards enhanced market proximity. From a financial point of view, the profitability of the firm's sourcing had started to become more unfavourable since the strengthening of the euro-against-dollar ratio had increased the prices of the sourced bicycles and components.

The results of the financial modelling showed that at the prevailing euro-against-dollar ratio, the total landed costs of the sourced JOPO bicycles exceeded the production costs of JOPOs at the firm's own factory in Finland. At the same time, the production of JOPOs in the firm's own factory could carry the requirements to maintain minimum production capacity in the factory. Hence, in May 2010, the firm's man-

agement made the decision to repatriate the production of JOPOs from contract manufacturing in the Far East back to the firm's own factory. Kinkel and Maloca point out that 'empirical studies often fail to take into account that manufacturing offshoring does not have to be an irrevocable process' (Kinkel & Maloca, 2009, p. 154), and claim that 'backshoring activities of once offshored capacities from foreign locations back to the domestic location are quite common phenomena, which have only made public in the rarest cases and not captured systematically' (Ibid., p. 155).

In our article, we want to contribute to this research topic by presenting a practical firm study which explores how outsourcing and backshoring decisions were made and implemented in a business environment. Our research includes qualitative and quantitative analyses related to operations management. This has been carried out in two phases, in 2007–2008 and in 2010. Moreover, we will later include a third phase in our research, when we analyse how the backshoring decision affected the firm's operations, i.e. the ramping up of JOPO production. Hence, our research phases are well scheduled with the firm's decisions to respond to changes in its market environment.

As a research strategy, we use the single case study method and follow the guidelines of Yin (2009) and Eisenhardt (1989). In her article on 'Building Theories from Case Study Research', Eisenhardt writes (Ibid. p. 534) that 'the case study is a research strategy which focuses on understanding the dynamics within single settings', and further 'case studies typically combine data collection methods such as archives, interviews, questionnaires and observations. The evidence may be qualitative (e.g. words), quantitative (e.g. numbers), or both'.

The research framework suits our BikesCo case well, because backshoring phenomena cannot be studied without considering the preceding manufacturing relocation decisions either, as 'Backshoring activities consist of an interlinking of two sequentially following relocation decisions and can only be discussed in connection with the previously made offshoring decision' (Kinkel & Maloca, 2009, p. 156).

Eisenhardt writes that ‘case studies can be used to accomplish various aims: to provide description, test theory or generate theory’ (Eisenhardt, 1989, p. 535). We believe that our article provides its readers with increased managerial utility by giving, as mentioned above, a description of a practical firm study which explores how outsourcing and backshoring decisions were made and implemented in a business environment.

The scope of the research

At the beginning of the action research in 2007, the firm’s profitability had been unsatisfactory for several years, and hence the firm’s management had raised the make-or-buy issue, i.e. whether contract manufacturing is more profitable than the firm’s own production, as an issue of long-term survival. The management then decided to answer this issue by analysing the total manufacturing costs in the firm’s factory and comparing these with the total landed costs of the sourced bicycles at the firm’s factory warehouse. The scope of the analysis is shown in the figure below. The costs of the component supply and the profitability of deliveries to final customers were left out of the scope of the analysis.

Figure 1. Total manufacturing costs compared to the costs of sourced bicycles

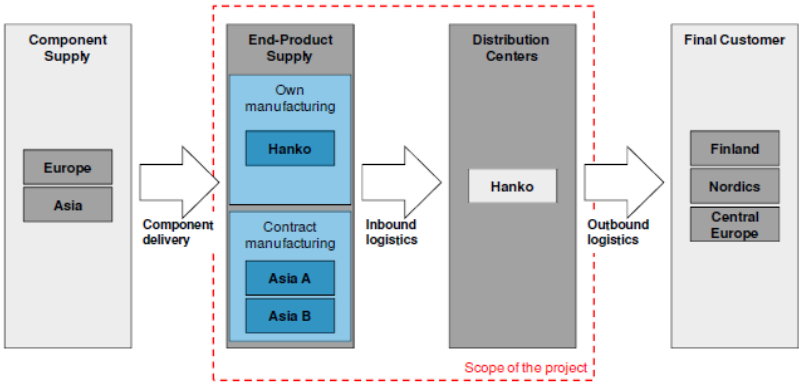

The analysis was implemented as a joint effort between the firm's management and our project team at the Aalto University (Eloranta et al., 2009, p. 6). We constructed a model to support the required cost analyses, performing our analyses in two steps:

- Analysis of the firm's own production costs by using time-driven activity-based costing (TDABC); and
- Analysis of the product costs of the sourced bicycles, using the concept of fully loaded total landed costs (TLCs).

As a result of our efforts, our model was adopted as an operative management tool, replacing the old management accounting system.

BACKGROUND

The concept of fully loaded total landed costs (TLCs)

To determine the financial implications of a specific supply chain structure, the total supply chain costs should be measured. Especially when comparing sourcing decisions, the TLC analysis proves useful. Our experience as business practitioners has often shown, however, that a too simplistic TLC approach to analysing sourcing opportunities may result in too low estimations of supply chain costs. A study from Aberdeen (Enslow, 2006) also confirms this statement. From the companies that were studied, 91% said that their supply chain costs were unexpectedly high.

Many companies calculate TLC as follows:

TLC = Unit price + average transportation cost + average handling cost + duties and taxes

This metric clearly gives too optimistic a picture of the total costs. Aberdeen suggests that a comprehensive analysis of total landed cost should include many more cost factors than the traditional calculation. The fully loaded TLC is the sum of the following components (Enslow, 2006):

Unit price (manufacturing costs + price of materials)

+ Average fully loaded transportation costs (incl. accessorial and fuel surcharges)

+ Expediting costs

+ Average handling costs

+ Duties and taxes

+ Documentation and broker fees

+ Financial transaction costs (e.g. letter of credit charges and currency exchange)

+ Inventory carrying costs

+ Inventory obsolescence costs

+ Product rework or damage costs

+ Customer service penalties (e.g. chargebacks)

The concept of time-driven activity-based costing (TDABC)

Cooper and Kaplan introduced activity-based cost (ABC) accounting at the Harvard Business School in the mid-1980s. ABC is a costing method based on 'activities'. With ABC, overhead costs are assigned to activities, and then to products, orders and customers according to the consumption of the different activities. ABC accounting has widely been implemented in various organisations. However, the real applicability of these ABC tools has been largely criticised by business managers and other practitioners (Everaert et al., 2008), since it has often proved difficult to describe the firm's actual processes without adding more and more nuanced new activities in the model, thereby increasing its complexity. As a result, the requirements for the maintainability and computational and memory capacity of the model are progressively

increased. Moreover, even the relevance of the ABC methodology has often been criticised by business practitioners, since the reliability of the information concerning activities included in a traditional ABC model is dependent on the data, which are based for the most part on interviews and surveys, and hence, are sensitive to the behaviour of the interviewed employees.

In 2004, to overcome these practical difficulties related to the usability of ABC, Kaplan and Anderson (2004) developed time-driven ABC as a revised version of ABC analysis, introducing 'time estimations' as drivers for each specific activity. Hence, the TDABC approach of Kaplan and Anderson does not assign resources and costs to the specific activities, but rather identifies the different departments, their costs and their practical capacity. By dividing the total cost by the practical capacity, the cost per time unit is calculated. Costs then are assigned to the order (or product or customer) by multiplying the cost per time unit by the time needed to perform the activity (Everaert et al., 2008).

When creating the TDABC methodology, Kaplan and Anderson (2004, 2007) designed the concept of 'time equations', which is used to model how time drivers drive the time spent on an activity. As described by Kaplan and Anderson, by using multiple time drivers, complex activities can be modelled without expanding the number of activities. Hence, TDABC seems to support the design of cost models in environments with complex activities.

DESCRIPTION OF THE CASE STUDY

The BIT Research Team has been working together with the senior management of BikesCo on an action research basis since 2006. The research has included a mixture of qualitative and quantitative issues related to operations management, and was carried out in two phases, in 2007–2008 and in 2010.

Our action research started in August 2007 as part of the RESPONSE project (2006–2008), and thereafter continued in the GlobeNet Project (2009–2011). Both projects were funded by TEKES (the Finnish Funding

In 2008–2010, the firm continuously reviewed its competitive situation and simulated the financial outcomes of different management decisions with the developed accounting model. In summer-autumn 2010, during the second phase of our study, we interviewed the firm's senior management and collected the financial data produced by the model. The validity of the model was challenged by questions posed to the firm's senior management without thoroughly evaluating the changes made in the accounting model. However, based on our accumulated experience as business practitioners, we concluded that the model seemed to produce relevant financial outcomes and the interviews gave no indications to the contrary.

In the third phase of this firm study, our aim is also to re-evaluate the validity of the model.

Description of the model construction

Modelling manufacturing costs

As described above, we used the TDABC methodology to analyse the manufacturing costs. We evaluated all allocations of working hours and wages paid to workers by identifying the work activities/tasks that were performed in the production process. This information was used to calculate how wages should be allocated to each bicycle model in the production.

Our results for the products' manufacturing costs differed from those taken out of the firm's management accounting. The old cost accounting model used by the firm did not match well enough with the data taken from the external accounting, which indicated that the production costs were underestimated in the management accounting. The difference was on average more than +10% (see that of an example product in Figure 3 below), but there were also a few bicycle models whose manufacturing costs were lower than the firm had previously assumed.

One of the main improvements in the new model was that it took into account all production-related costs, such as indirect materials, work-related costs and support activities. Previously, these had been

taken into account with a multiplier that was directly related to the direct manufacturing costs and was of the same value for all different bicycle models. With a more detailed decomposition of the costs, the model became more reliable, took into account all related costs and was more accurate of a product level, as well as with the aggregated firm level.

We increased the reliability of our analysis by matching our calculations with the firm’s audited balance of accounts. As a result of the model building, we were able to improve the accuracy of the production cost calculations, and hence our model replaced the old management accounting system and was adopted as an operative management tool.

Figure 3. Comparison between the old and new product cost model showing a 17% cost difference for an example product.

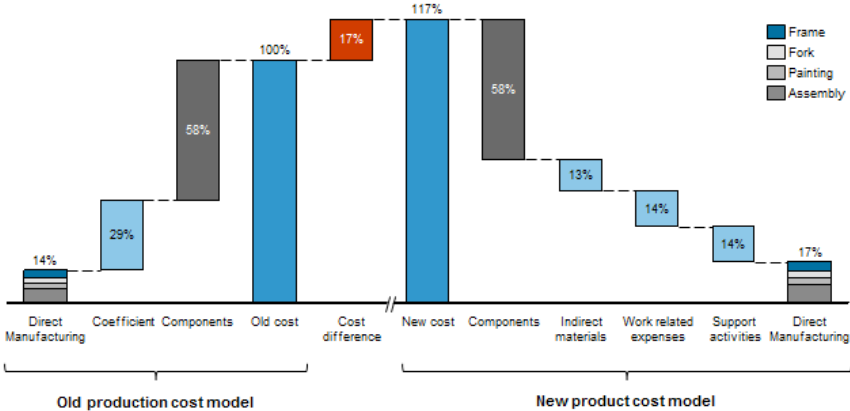

Modelling fully loaded total landed costs of the sourced bicycles.

The concept of fully-loaded total landed costs at the door of the factory warehouse was used in the analysis of the sourced bicycles. The sourced bicycles were purchased in USD and transported to the warehouse in Finland by sea. Therefore, the total landed costs were very

sensitive to changes, particularly in exchange rates and transportation costs. The model incorporated the sourcing costs to the firm's profit and loss statement; hence, it was possible to carry out sensitivity analyses on the effects of exchange rate fluctuations and transport costs on the firm's profitability. Our simulations clearly helped the firm to understand the implications of these fluctuations on the product and corporate profitability, and proved the importance of hedging the exchange rate risks (see below). Actually, regarding the tight profit margins of the bicycles, fluctuations in exchange rates and transportation costs could even swing the financial performance of the firm from profits to losses.

Our cost model gave the firm's management an operative tool for simulating how exchange rate fluctuations and changes in freight costs affect the purchase price of the sourced bicycles, and we demonstrate below how this information was used to analyse and estimate the sensitivity of the purchase price to the above-mentioned changes. The tool was also used to understand the realised total purchase costs of the sourced products in retrospect, as shown below (Figure 4).

Figure 4. The effect of EUR-USD exchange rate and freight costs on the total landed cost of the sourced bicycle; costs shown as indexed, real costs disguised for confidentiality.

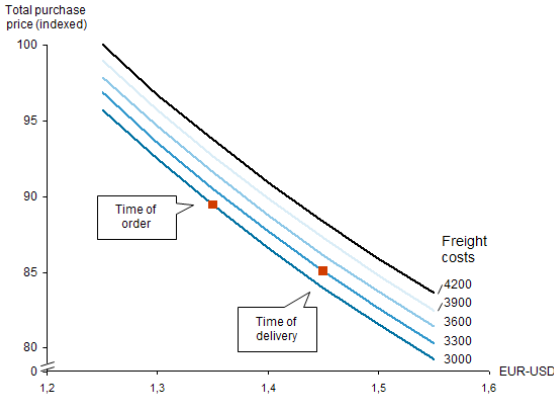

Results of the constructed model.

The model constructed in 2008 made it possible for the firm's management to get better information for making business decisions concerning the product portfolio and production structure, and the product allocations between the firm's own manufacturing and contract manufacturing.

As described at that time by BikesCo (Saarinen, 2008):

The new stimulated costing method, aided by the process descriptions, showed that the (old) product cost pricing used in the firm was inaccurate and did not give a realistic picture of the production costs. Compared with the costs of the firm's own manufacturing, it was found that it was more profitable to use contract manufacturing as far as common bicycles were concerned.

With the help of the supply chain process descriptions, the costing of the products will be changed over to TDABC. To settle all the costs of the supply chain, the descriptions of all other departments must also be done in greater detail. By using TDABC, the costs of the products and the customers will be determined more accurately.

The model was extensively used in the daily operative use and the analyses stimulated the management decision to outsource the whole JOPO production to the Far East for the 2009 season. At the time of this decision, financially, contract manufacturing was clearly favoured against the firm's own manufacturing.

Model improvements in the period 2008–2010.

The firm has continued to develop and update the model according to changes taking place both internally and in terms of external factors such as material and component prices, exchange rates, etc. The model was improved and refined according to the management decisions, which were stimulated by the analyses made with the model.

Concerning the firm's external and internal factors influencing the refinements of the model, the economic turmoil caused by the world financial crisis made the firm's market situation far more stringent; the factory was downscaled, resulting in a new structure and accumulation of costs. In addition, the currencies fluctuated to favour Euro-based operations over dollars.

With the above changes, the results of the models changed: The production costs in the own factory decreased significantly, and at the same time, the costs of contract manufacturing had gone up, with the result that contract manufacturing became more expensive than own production. In particular, the exchange rate variations and transportation and other logistics cost were shown to have a major influence on the balance of profitability between the firm's own manufacturing and contract manufacturing, hence giving a strong motivation for the management to follow them actively.

The following figure 5 describes the EUR-USD exchange rate variation in the period of 2007–2011. The firm's management's challenge to manage the business risks can easily be recognised if the volatility of the exchange rate changes shown in the figure is compared with the information given in the family of curves in Figure 4.

Figure 5. The EUR-USD exchange rate fluctuation during the analysis period. (Source: ECB⁶)



At the time of the backshoring decision in spring 2010, the updated production and contract manufacturing cost comparison indicated that the balance between the make-or-buy alternatives was almost equal, subject to the assumptions used. This analysis was used as background information in the firm's backshoring decision.

Decision 1, offshoring

The transition to offshore JOPO's production was gradual: In 2007, for the 2008 season, BikesCo management made the decision to start contract manufacturing of JOPOs and ordered a test lot of 2,000 bicycles from the Far East. The idea of contract manufacturing JOPOs was to order these bicycles according to the buyer's model design and specifications, which are mainly based on the use of European components. This design principle is based on the firm's desire to maintain the Finnish/European image of the JOPO brand.

The process of learning contract manufacturing on both sides, supplier and buyer, took time and aroused difficulties with ramping up all the processes which were needed for implementing the contract manufacturing decision, and at the same time establishing processes which were required by logistics and quality control. Within two years, however, the learning process was completed, and the supply chain management and quality control seemed to have reached satisfactory standards.

In our research, one of our goals was to answer the question of whether contract manufacturing is more profitable than the firm's own production. By using improved production cost allocations and sourcing cost analyses of the constructed accounting model, we were able to answer this, and hence give support to management's make-or-buy decision.

In our analysis, we picked a set of comparable pairs of bicycles, some manufactured at the firm's factory in Finland and others sourced at the same time from the Far East. Depending on the product, we noticed that the more common the bicycle was, the more profitable the contract manufacturing seemed to be.

In Figure 6, JOPOs' manufacturing costs at the firm's own factory are compared with the total landed costs of the sourced ones. In the prevailing Euro-to-USD foreign exchange rate, the difference was +32% in favour of contract manufacturing. Obviously, labour costs were the main factor making contract manufacturing more profitable, but also, the contract manufacturers, with their larger production volumes, seemed able to purchase materials and components at a lower cost than BikesCo.

Figure 6. Make-or-buy comparison of JOPO bicycles in 2008.

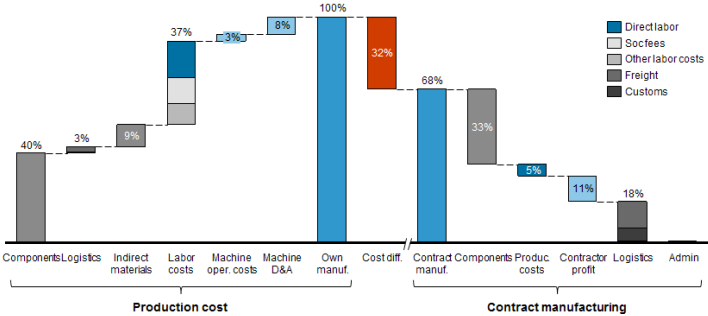

Based also on this analysis, BikesCo management decided to outsource the production of JOPOs to the Far East. Moreover, as a back-up for this contract manufacturing decision, BikesCo decided to maintain both its manufacturing know-how in Finland and its contacts with European component suppliers. The management has followed this precautionary strategy until the present, maintaining component safety stock and producing small production lots at the firm's own factory to satisfy unforeseeable demand.

Decision 2: Repatriation and arguments to manufacture all JOPOs in Finland

Background: Make-or-buy alternatives modelled with new cost evaluations.

When the economic turmoil began in 2008, the business environment became more stringent for BikesCo. The demand for bicycles fell below

expectations in the 2009 season, which worsened the firm's profitability by making the factory's cost structure too heavy to cope with the decreased market demand.

The firm had continuously reviewed its competitive situation and simulated the financial outcomes of different management decisions with the developed accounting model. The external factors affecting the firm's competitive environment were analysed with the model, and especially the influence of exchange rate variations, and transportation and other logistics cost were actively followed on a detailed level. The TDABC tool was also developed in such a way that it was possible to analyse how the production capacity of the factory would change the product cost of one specific model. Figure 7 shows how the annual production capacity affected the production cost. This analysis helped the management in determining what the minimum amount of own production should be in order to still maintain local production. Based on this information, the firm's management decided to downsize the factory's production capacity, which meant that 27 factory-level workers were laid off, so that the factory was reduced from 57 to 30 employees.

Figure 7. TDABC simulation indicates how the annual production capacity affects the production cost.

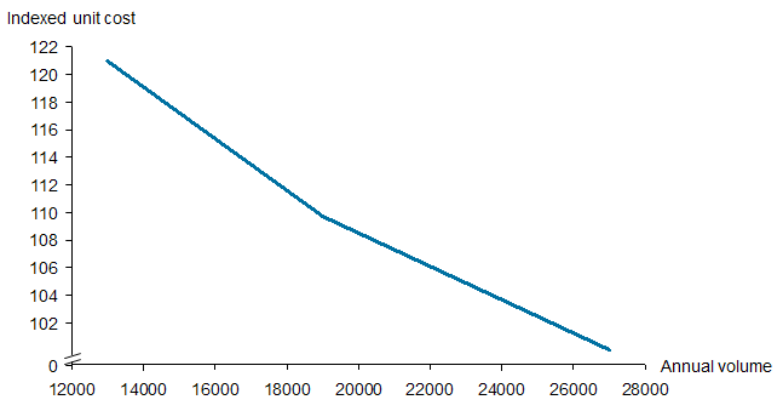

When most of the manufacturing of the JOPO bicycle was taken care of by the contract manufacturer in Asia, the factory in Finland still continued to produce small batches of JOPO bicycles. The management wanted to retain the knowledge of the production, and the local production was also vital for fulfilling unforeseen demand; hence, the production of JOPOs continued in the firm's own factory with small production lots.

The downsized production capacity meant improved cost competitiveness for the firm's own factory. Further, the strengthening of the euro exchange rate against the US dollar, in the period of summer 2008 to summer 2010, weakened the profitability of the sourced bicycles in relation to those manufactured in the firm's own factory. At the same time, the demand for bicycles was recovering from the wave trough of the economic turmoil, and the firm's profitability began to improve.

With the above changes, the results of the models also changed: The production costs in the own factory had decreased significantly during the period, and at the same time, the costs of contract manufacturing had gone up (see Figure 8 below). At the time of the backshoring decision in spring 2010, the updated production and contract manufacturing cost comparison indicated that the balance between the make-or-buy alternatives was almost equal, subject to the assumptions used (4% in favour of own manufacturing).

By spring 2010, it had become clear that the financial balance between the firm's own manufacturing and sourcing had changed. The demand for bicycles was gradually recovering from the economic turmoil in 2008–2010, which had worsened the firm's profitability. Demand for bicycles had fallen below expectations in the 2009 season, but thereafter, the demand had started to grow, and buying a JOPO became a trend.

It had also become evident to the management that the delivery supply chain of the bicycles should be as flexible as possible. Improved flexibility in the deliveries of the component suppliers and the production in the firm's own factory had made the supply from the factory more flexible than before.

Figure 8. The updated comparative analysis of production and contract manufacturing costs of JOPO bicycles in 2010.

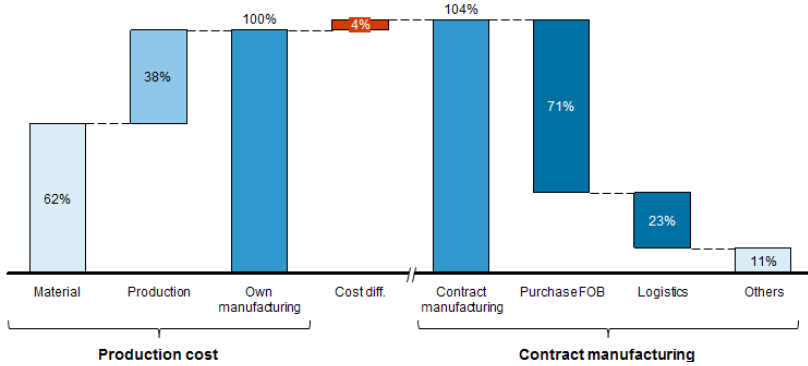

The repatriation decision and arguments to manufacture all JOPOs in Finland.

On the other hand, the supply chain of the sourced bicycles from the Far East to Finland had proved to be too long and inflexible. Regarding the requirements of the firm's customers, and fluctuations in demand in Finland and Europe, the operational flexibility in production and logistics seemed to need improvement. In short, the management of operations suffered from the long and inflexible delivery chain in terms of delivery reliability and quality control.

As described above, the firm had continuously reviewed its competitive situation and simulated the financial outcomes of different management decisions with the developed accounting model. During the spring of 2010, the firm's management was willing to revise its allocation of operations locations towards enhanced market proximity.

From the financial point of view, the profitability of sourcing had also started to become more unfavourable since the weakened exchange ratio had increased the prices of the sourced bicycles and components. The results of the financial modelling showed that at the prevailing exchange ratio, the total landed costs of the sourced JOPO bicycles ex-

ceeded the production costs of JOPOs at the firm's own factory, and at the same time the production of JOPOs in Finland could, for its part, carry requirements to maintain minimum production capacity at the factory. Therefore, in May 2010, the firm's management decided to repatriate the production of JOPOs from contract manufacturing back to the firm's own factory.

In short, the drivers behind the make-or-buy decision can be described as follows:

- JOPOs are produced/sourced against the forecast, well before spring, the sales peak season;
- Quality has to be the same for both options;
- JOPO is a well-known Finnish brand, and hence the domestic production is an important argument for marketing;
- The firm's own, small-scale factory can provide the firm's customers with flexibility in the supply of JOPOs, but compared with the total sales volumes of the firm, the flexibility of volumes in the firm's total production is practically unaffected.

The formal arguments for the backshoring decision were that it would give BikesCo:

- More flexibility and agility to respond to customer requirements and demand fluctuations in Finland and Europe;
- Increased operational efficiency in production and logistics;
- Better delivery reliability; and
- Improved quality control and management of operations in general.

This decision was supported by the financial analysis, which indicated that the production of all JOPO bicycles at the firm's own factory was financially more profitable at the prevailing Euro-to-dollar exchange rate than importing them from the contract manufacturer.

The figure 9 below illustrates how the exchange rates change the balance of profitability in the make-or-buy question with the updated cost models for own production and contract manufacturing.

Figure 9 Make-or-buy comparison: The effect of the EUR-USD exchange rate changes in the cost of JOPO bicycle at the factory warehouse

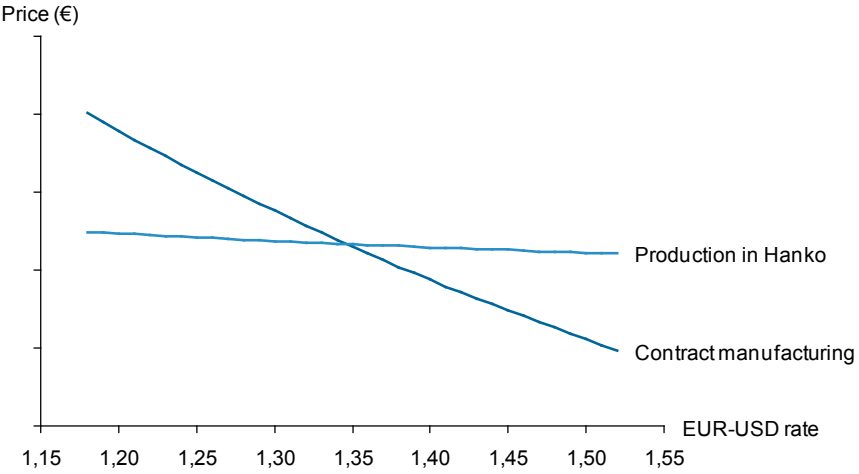

FUTURE RESEARCH DIRECTIONS

Third phase

The third phase of the firm study will take place later in 2011 when the repatriation decision has come into effect and own production has been rescaled to fulfil the higher production need. In this phase, we will focus on how well the firm has been able to ramp up the production and what the commercial implications of the backshoring decision have been.

Other case studies

Future research should investigate other cases where companies have first decided to outsource their production, and later have decided for some reason to repatriate production. This should analyse what the decision process has been and the main reasons for it in these cases.

CONCLUSIONS

This article gave a description of a firm's operational responsiveness for immediate actions aroused by continuous changes in its business environment. It described how the management's decisions needed to be continuously re-evaluated as the business environment evolved.

Both financially and operationally, there were many reasons to support the offshoring decision: The suppliers to whom production was outsourced had a price advantage over the case company, with lower labour and other manufacturing costs. The outsourcing decision was strongly favoured by at that time prevailing euro-against-dollar exchange ratio of 1.5, which furthered cost advantage to imported bicycles. In addition, the firm's supply chain for the sourced bicycles seemed to be operationally and financially more flexible than the firm's own production.

Because of the supplier's larger production capacity, the production time was shorter and could be adjusted to the seasonal demand, which lead to lower overall inventories, faster capital turnover and a more efficient use of capital. An efficient supply chain, as described by Fisher (1997), would be the right alternative for this typical functional product. However, after the outsourcing decision, there were many changes taking place in the firm's business environment that prove that operations location decisions are not one-off decisions, but are rather dynamic in nature. When the economic turmoil began in 2008, the demand for bicycles fell below expectations in the 2009 season, and thus the firm's profitability worsened. The cost structure of the factory had become too heavy to cope with the decreased market demand. Consequently, to improve the cost competitiveness, the production capacity of the firm's own factory was downsized and the production processes made more efficient.

With these actions, the production costs decreased and hence the profitability of the firm's own factory improved. At the same time, the offshore manufacturing became less attractive, mainly because the exchange rate development increased the costs of imported bicycles by over 20%. In addition, the offshore supplier had increased pricing after having locked in the new customer and the firm was not fully satisfied with the manufacturing quality.

All these changes in the business environment worked in favour of the firm's own factory, and soon the management took the decision to repatriate production, which had financially and operationally become a sound option. Moreover, after the outsourcing decision, the customers' perceptions of the traditional JOPO bicycle were changing. The fact that the JOPO bicycle was a Finnish product had become paramount, and the end-customer was willing to pay a premium if it was produced in Finland. In addition, the characteristics of the product had changed. Initially, the firm had seen the JOPO bicycle as a functional product with predictable demand and a limited number of variants, but as the product became a trend, it gained more characteristics of an innovative product.

The unforeseen demand for different colours and other product variants made demand forecasting harder and increased the number of these variants, which further led to stock-outs and long lead times for many of the various product variants of JOPOs.

Strategically, the JOPO product had been transformed from a low value adding product that was essential to support the growth strategy of new and technically more advanced products, into a product with high sales figures and improved profitability. The management could not predict this change in the customers' tastes before the outsourcing decision, and did not fully understand the increasing strategic importance of the JOPO product for the whole firm. Hence, this firm study shows that in addition to the need to re-evaluate the operation location decisions from a financial and operational perspective, these decisions should also reflect the changes in customer perceptions, competitiveness and market position, and the overall business strategy of the firm.

At BikesCo, despite an outsourcing decision of the JOPO model, the firm carried on with production of other models and decided to maintain a minimum production capacity for JOPOs. This flexibility, built in the production, eventually enabled the backshoring decision. In other cases, where production capacity is entirely or to a large extent run down, backshoring might no longer be possible due to the significant reinvestments that would be required. Therefore, in a global economy where markets are continuously changing, it is more important than ever to have a dynamic supply chain.

REFERENCES

- Eisenhardt, K. (1989). Building Theories from Case Study Research. *The Academy of Management Review*, 14 (4), 532-550.
- Eloranta, E., Blomqvist, M., Gylling, M., Jussila, K., & Lipponen, M. (2009). Responding to globalization: Operations locations decisions. *Aalto University BIT Research Centre Report Series 2009/2*.
- Enslow, B. (2006). Rethinking China Sourcing: From Total Landed Cost to Total Delivered Profit. *Aberdeen Group*. [online] Available from www.aberdeen.com [Accessed 19.10.2007]
- Everaert, P., Bruggeman, W., Sarens, G., Anderson, S.R., & Levant, Y (2008). Cost modeling in logistics using time-driven ABC. Experiences from a wholesaler. *International Journal of Physical Distribution and Logistics Management*, 38(3), 172-191.
- Ferreira, J., & Prokopets, L. (2009, January-February). Does offshoring still make sense? *Supply Chain Management Review*, 20-27.
- Fisher, M. (1997, March-April). What is the right supply chain for your product? *Harvard Business Review*, 105-116.
- Gylling M. (2008). Designing a Global Supply Chain for a Consumer Product Manufacturer, *Master's Thesis Aalto University School of Science*.
- Jussila, K., Anttila, J. & Gylling, M. (2012). Enhancing Financial Performance in Global Operations. *GlobeNet Project Workbook, Aalto University School of Science, Department of Industrial Engineering and Management, BIT Research Centre*. [online] Available from http://www.valuenetworks.fi/fileadmin/Tiedostot/Globenet/GlobeNet_WB_Enhancing_Financial_Performance.pdf.
- Kaplan, R., & Anderson, S. (2004, November). Time-driven activity-based costing. *Harvard Business Review*, 131-138.

- Kaplan, R., & Anderson, S. (2007). Time-driven activity-based costing: A simpler and more powerful path to higher profits. *Boston: Harvard Business School Press.*
- Kaplan, R., & Cooper, R. (1998). Cost and effect: Using integrated cost systems to drive profitability and performance. *Boston: Harvard Business School Press.*
- Kinkel, S., Lay, G., & Maloca, S. (2007). Development, motives and employment effects of manufacturing offshoring of German SMEs. *International Journal of Entrepreneurship and Small Business*, 4(3), 256-276.
- Kinkel, S., & Maloca, S. (2009). Drivers and antecedents of manufacturing offshoring and backshoring—A German perspective. *Journal of Purchasing and Supply Management*, 15, 154–165.
- Saarinen, M. (2008). *Helkama Velox Prosessit ja TDABC-laskenta* (in Finnish), Bachelor's Thesis at Helsinki Metropolia University
- Yin, R. K. (2009). *Case study research: design and methods*, 4th ed. London, Sage Publications.

CORRESPONDING AUTHORS:

Chapter 1: Bram Timmermans, bram@business.aau.dk

Chapter 2: Marja Blomqvist, marja.blomqvist@qdc.fi

Chapter 3: Yang Cheng, cy@business.aau.dk

Chapter 4: Marcus M. Larsen, mml.smg@cbs.dk

Chapter 5: Mikko Mattila, mikkov.mattila@tkk.fi

Chapter 6: Johanna K. Jaskari, johanna.jaskari@tkk.fi

Chapter 7: Dmitrij Slepnirov, ds@business.aau.dk

Chapter 8: Aki Laiho, laiho.aki@gmail.com

Chapter 9: Peder Veng Sjøberg, pvs@business.aau.dk

Chapter 10: Eero Eloranta, eero.eloranta@aalto.fi

Case 1: Anna Fredriksson, anna.fredriksson@liu.se

Case 2: Kari Jussila, kari.jussila@aalto.fi

