



AALBORG UNIVERSITY
DENMARK

Aalborg Universitet

The overview of damping methods for three-phase grid-tied inverter with LLCL-filter

Min, Huang; Blaabjerg, Frede; Loh, Poh Chiang

Published in:

Proceedings of the 16th European Conference on Power Electronics and Applications (EPE'14-ECCE Europe)

DOI (link to publication from Publisher):

[10.1109/EPE.2014.6911055](https://doi.org/10.1109/EPE.2014.6911055)

Publication date:

2014

Document Version

Early version, also known as pre-print

[Link to publication from Aalborg University](#)

Citation for published version (APA):

Huang, M., Blaabjerg, F., & Loh, P. C. (2014). The overview of damping methods for three-phase grid-tied inverter with LLCL-filter. In Proceedings of the 16th European Conference on Power Electronics and Applications (EPE'14-ECCE Europe) Lappeenranta: IEEE Press. DOI: 10.1109/EPE.2014.6911055

General rights

Copyright and moral rights for the publications made accessible in the public portal are retained by the authors and/or other copyright owners and it is a condition of accessing publications that users recognise and abide by the legal requirements associated with these rights.

- ? Users may download and print one copy of any publication from the public portal for the purpose of private study or research.
- ? You may not further distribute the material or use it for any profit-making activity or commercial gain
- ? You may freely distribute the URL identifying the publication in the public portal ?

Take down policy

If you believe that this document breaches copyright please contact us at vbn@aub.aau.dk providing details, and we will remove access to the work immediately and investigate your claim.

The Overview of Damping Methods for Three-phase Grid-tied Inverter with LLCL-filter

Min Huang, Frede Blaabjerg, Poh Chiang Loh
Department of Energy Technology
Aalborg University
Aalborg, Denmark
Tel.: +45 23 82 04 10
E-mail: hmi@et.aau.dk, fbl@et.aau.dk, pcl@et.aau.dk
URL: <http://www.en.aau.dk/>

Keywords

« Active damping », « Passive damping », « LLCL-filter », « Grid-tied inverter », « Resonance », « Power converter ».

Abstract

Compared with LCL filter, an LLCL-filter is characterized with smaller size and lower cost for grid-connected inverters. But this high order filter may also have resonant problem which will affect the system stability. Many methods can be used to alleviate the resonant problem including active damping, passive damping or even without damping if it is designed conservative. In this paper, an overview of damping methods for three-phase voltage-source grid-tied with LLCL-filter is given. This paper also analyzes damping principle of each method including passive damping and active damping and shows the advantages as well as disadvantages of these methods.

Introduction

In the last decade, due to the energy crisis, the Distributed Generation (DG) power electronic interfaced systems using clean renewable energy such as solar energy, wind energy, etc., have become an important issue in technical research. A low-pass passive power filter, typically LCL, is often inserted between a voltage source inverter (VSI) and the grid to attenuate the high-frequency PWM harmonics to a desirable limit. In order to further reduce the total inductance even more, an LLCL-filter was proposed [1]. Comparing with the conventional LCL-filter topology, the LLCL-filter topology provides successful harmonic attenuation capability, reducing the overall size cost of the passive components as well as faster dynamic response may be obtained [2]-[4].

These two high-order filters have stability problems by undesired resonance effects [1], [5]. Passive and active resonance damping solutions are adopted for damping LCL-filter resonance. Passive damping is realized by adding circuit components in the system and this method causes a decrease of the overall system efficiency [5]-[11]. A direct way to damp the resonance of the LLCL-filter is introducing a physical resistor to be in series or parallel with the filter inductors or filter capacitor. Active damping consists in modifying the controller in the converter. Active damping methods are more selective in their action, they do not produce losses but they typically need extra sensors and they are also more sensitive to parameter uncertainties [12]-[18]. Therefore, both active and passive damping becomes necessary to be developed in order to achieve a stable operation.

In this paper an overview of damping methods for LLCL-filter based three-phase grid-tied inverter is introduced. In the second section model of the LLCL-filter based three-phase grid-tied inverter is developed. The third section and fourth section describe and analyze some passive damping and active damping methods, respectively. Last, the fifth section gives a conclusion to these damping methods for the LLCL-filter based three-phase grid-tied inverter.

Modeling of three-phase grid-tied inverter with LLCL-filter

Fig. 1 shows the typical circuit diagram of a three-phase voltage source inverter connected to the grid through an LLCL-filter. Fig. 2 shows the single-phase equivalent circuit, which is composed of the inverter-side inductor L_1 , filter capacitor C_f , resonant inductor L_f and grid-side inductor L_2 . The equivalent series resistors of L_1 , L_f , and L_2 are relatively small and ignored here.

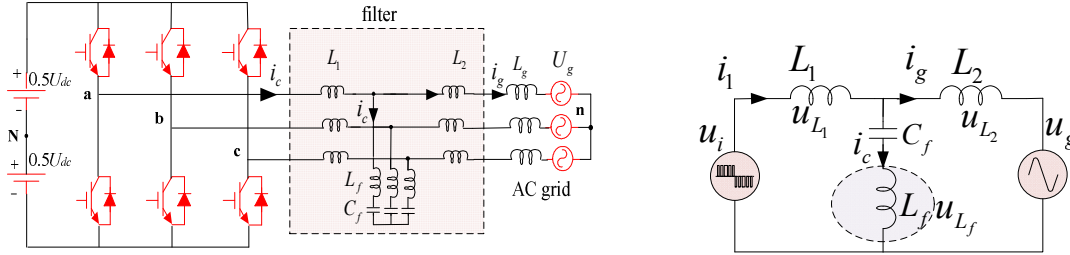

Fig. 1. LLCL-filter based three-phase converter. Fig. 2. Single phase equivalent circuit of the converter.

When the grid-side current is controlled, the transfer function $i_g(s) / u_i(s)$ of the LLCL-filter based grid-tied inverter can be derived as shown in equation (1):

$$G_{u_i \rightarrow i_g}(s) = \frac{L_f C_f s^2 + 1}{C_f [L_1 L_2 + (L_2 + L_2) L_f] s (s^2 + \omega_r^2)} \quad (1)$$

$$\omega_r = \frac{1}{\sqrt{\left(\frac{L_1 L_2}{L_1 + L_2} + L_f \right) C_f}} \quad (2)$$

The expression of resonant frequency is shown in (2). Fig. 3 shows the transfer functions $i_g(s) / u_i(s)$ of both the LLCL-filter and the LCL-filter while all the other parameters are the same except for the L_f . It can be seen that the magnitude response and phase response of the LCL-filter and the LLCL-filter in the half of the switching frequency range are similar, so there are no obvious differences during the design of the controller for the LCL-filter and LLCL-filter based systems. The resonant peak of the LLCL-filter can be attenuated by active and passive damping methods [19].

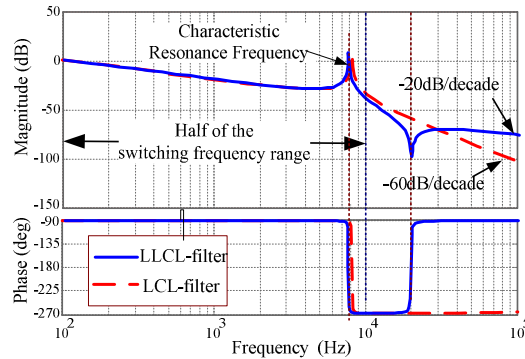

Fig. 3. Bode plots of transfer functions $i_g(s) / u_i(s)$ in the case of LCL- and LLCL-filters.

Filter-based passive damping

Passive options

If only one resistor is used, there are six possible locations for the resistor in an LLCL/LCL filter circuit, as shown in Fig. 4: in parallel/series with the converter-side inductor, in parallel/series with the capacitor and in parallel/series with the grid-side inductor.

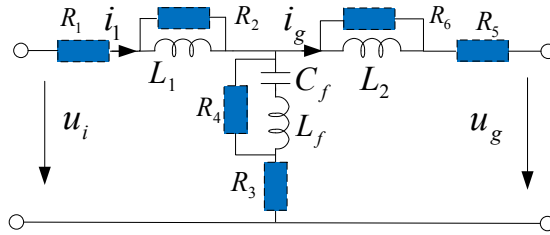

Fig. 4. Several simple passive damping methods.

As shown in the Bode Plots in Fig. 5, when the resistor is in series with the converter-side inductor and grid-side inductor, the damping effect of the resonance increases with the larger resistor. But, the gain at the low frequency will be reduced. At the same time, the fundamental current will pass through resistors R_1 and R_5 and it costs a lot of losses.

When the resistor R_3 is in series with capacitor, it is the most used method for LCL-filter. But the resistor influences the harmonic attenuation at the switching frequency for LLCL-filter and brings high frequency loss [5]. When the resistor R_4 is in parallel with resonant circuit $L_f - C_f$, the high frequency harmonics attenuation effect of the filter will be reduced and R_4 brings fundamental frequency losses. When the resistor is in paralleled with the converter-side inductor and grid-side inductor, as shown in Fig. 5, the damping effect of the resonant will increase with the smaller resistor, but the high frequency attenuation effects will be decreased. Hence, some advanced passive damping methods are developed with additional components to get a better effect.

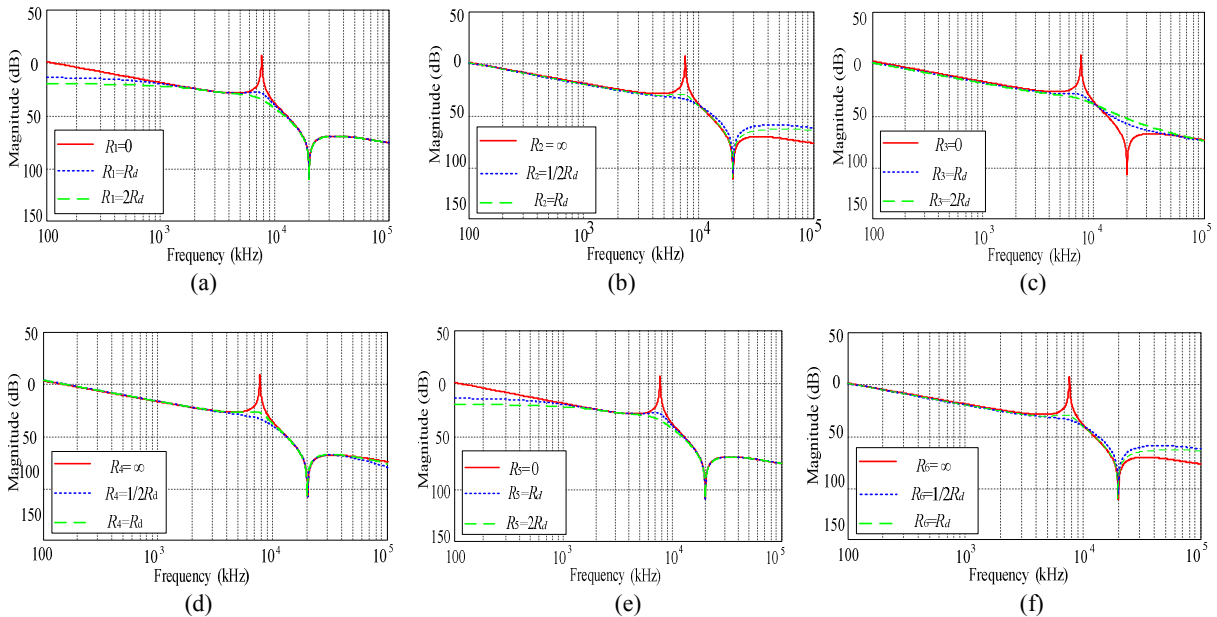

Fig. 5. Bode plots in different damping situations (a) inductance L_1 in series with resistor (b) inductance L_1 in parallel with resistor (c) capacitance C_f in series with resistor (d) capacitance C_f in parallel with resistor (e) inductance L_2 in series with resistor (f) inductance L_2 in parallel with resistor.

Advanced passive damping methods

In order to reduce the damping power loss and to maintain high-frequency harmonics attenuation, one effective solution is to insert an additional $R_d - C_d$ circuit branch in parallel with the capacitor of an LCL-filter [5], [10], as shown in Fig. 6(a). Fig. 6(b) shows the $R_d - C_d$ circuit passive damping for LLCL-filter. The damping power loss can be cut down since the harmonic currents around the switching frequency have been bypassed mostly by the $L_f - C_f$ series resonant circuit. This type passive damping is also equal to the capacitor current with high pass feedback. To ensure the grid-tied inverter system to be stable for the grid with a wide variation range of inductance, a composite robust passive damping method for the LLCL-filter is proposed [6], as shown in Fig. 6(c).

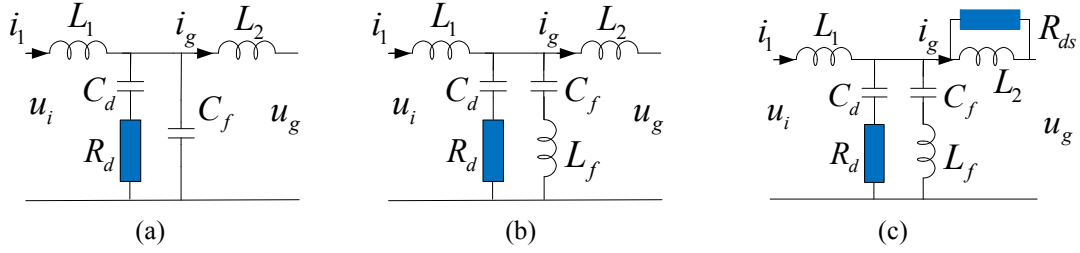

Fig. 6. Advanced passive damping methods (a) R_d - C_d paralleled passive damping of LCL-filter (b) R_d - C_d paralleled passive damping of LLCL-filter (c) composite passive damping of LLCL-filter.

When the R_d - C_d circuit branch is in parallel with the capacitor of an LLCL-filter, the total capacitance of (C_d+C_f) should also be limited by the reactive power at rated load. The selection of the R_d in the paralleled circuit is shown in (3).

$$\frac{\sqrt{\alpha+1}}{\alpha} \sqrt{\frac{L+L_f}{C_f}} \leq R_{d(LLCL)} \leq \frac{\alpha+1}{\alpha} \sqrt{\frac{L+L_f}{C_f}} \quad (3)$$

Where $L = L_1 L_2 / (L_1 + L_2)$, $C_d / C_f = \alpha$.

For the composite passive damping in Fig. 6(b), The RC parallel part can be designed under the weakest grid condition and the RL part can be designed under the stiffest grid condition. Table I shows the comparison of three passive damping cases.

Table I: Comparison of three passive damping cases

Topology	Effectiveness	Robustness	Losses	Size
LCL-filter with R_d - C_d paralleled passive damping	++	+	-	-
LLCL-filter with R_d - C_d paralleled passive damping	+	++	++	++
LLCL-filter with composite passive damping	++	+++	-	+

Other passive damping methods for LCL-filter

There are several advanced passive damping methods for the LCL-filter [8], [9]. The inductor L_d provides low impedance, which will reduce the resistive loss in Fig. 7(a). The most fundamental and low-frequency components will flow through the inductor. Also an additional capacitor and inductor are both in parallel with the damping resistor to improve the harmonic attenuation in Fig. 7(b) and (c). The principle is similar to the LLCL-filter.

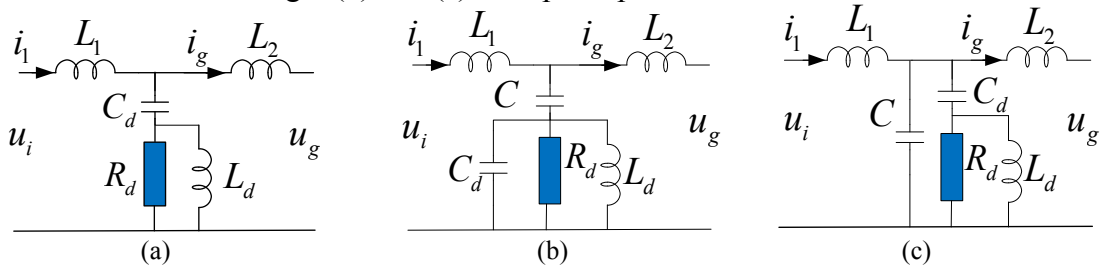

Fig. 7. Other passive damping configurations (a) An inductor in parallel with the damping resistance (b) An inductor and a capacitor in parallel with the damping resistance (c) An inductor in parallel with the damping resistance and extra capacitor

Filter-based active damping

Active damping methods can be classified into two main classes: multiloop and filter-based active damping [8]. In the first case, the stability is guaranteed using the control of more system state variables that are measured or estimated. For example, the voltage or current feedback of the capacitor is commonly used. In the second case, suitable filter parameters, delay and control algorithm can be used. In the first case, the stability is guaranteed using the control of more system state variables that are measured or estimated. For example, the voltage or current feedback of the capacitor are commonly used. In the second case, suitable filter parameters, delay and control algorithm can be used.

Virtual resistor Active Damping

As mentioned before, the resonance frequency of an LCL-filter can be damped by connecting a resistor to the filter. The virtual resistance without reducing the efficiency was introduced; the same as the passive damping resistor of LCL-filter that is using resonance damping techniques. Capacitor current feedback is a typical virtual damping, which is equal to a resistance in parallel or series of the capacitor.

The control structure of inner current loop with the notch concept is shown in Fig. 8. $G_c(s)$ is the controller and $G_d(s)$ is delay. The simplified function of the block in the dotted line can be illustrated in (4) to form damping. ξ is the damping efficient. ω_r is the resonant radian frequency. $K(s)$ is the feedback coefficient. There are different variables which can be chosen as control objects for LLCL-filter, as shown in Fig. 2, like filter capacitor voltage u_{cf} , filter capacitor current i_c , inductor voltage in grid side u_{L2} , inductor voltage in resonant circuit u_{Lf} .

$$B(s) = \frac{k_{PWM}}{1 + k_{PWM}K(s)N(s)} = \frac{s^2 + \omega_r^2}{s^2 + 2\xi\omega_r s + \omega_r^2} \quad (4)$$

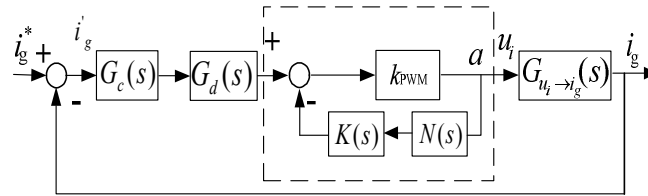

Fig. 8. Active damping based on notch filter concept.

Table II describes the needed feedback functions for different feedback variables based on notch concept. Considering the effect of delay, more feedback functions $K(s)$ can be used to dampen the resonance.

Table II: Different variables feedback based on notch concept

	u_{C_f}	$i_c(s)$	$u_{L_f}(s)$	u_{L_2}
$N(s)$	$\frac{\omega_r^2 L_2}{(s^2 + \omega_r^2)(L_1 + L_2)}$	$\frac{\omega_r^2 L_2 C_f s}{(s^2 + \omega_r^2)(L_1 + L_2)}$	$\frac{\omega_r^2 L_2 L_f C_f s^2}{(s^2 + \omega_r^2)(L_1 + L_2)}$	$\frac{\omega_r^2 L_2 (L_f C_f s^2 + 1)}{(s^2 + \omega_r^2)(L_1 + L_2)}$
$K(s)$	$sK_{u_{C_f}}$	K_{i_c}	$K_{u_{L_f}} / s$	$K \frac{C_f s}{L_f C_f s^2 + 1}$

When the capacitor voltage is sensed, derivative filter capacitor voltage feedback is required for resonance damping. Some papers have illustrated this method for LCL-filter [20]. Three common virtual resistor active damping can be used for the LLCL-filter. When a capacitor voltage is sensed, $K(s)$ can easily be configured as a proportion link, and it is isolated with the system parameters. When the resonant inductor voltage is sensed, integral feedback can be expected to keep the system stable.

This is a new active damping method for LLCL-filter which can reduce the cost of sensor. Normally, filter capacitor current is sensed for LLCL-filter but a voltage sensor might be cheaper than current sensor. Table III shows comparison of different feedbacks [14]. f_r is the resonant frequency and f_d is the sample frequency.

Table III: Comparison of different feedback based on notch concept

	I_c feedback	U_{cf} feedback	U_{Lf} feedback
Required feedback	proportional	derivative	Integrated feedback
Higher ratios f_r/f_d	++	-	-
Medium ratios f_r/f_d	+	+	+
Lower ratios f_r/f_d	-	0	0

Lead-lag active damping

The differentiator might bring noise problems as it amplifies high-frequency signals. It can be compensated with a lead-lag compensator [21]-[24]. The lead compensator has the equation (5).

$$L(s) = k_d \frac{T_d s + 1}{\alpha T_d s + 1} \quad (5)$$

k_d is the proportional gain, T_d is the sampling period. The control block is shown in Fig. 9.

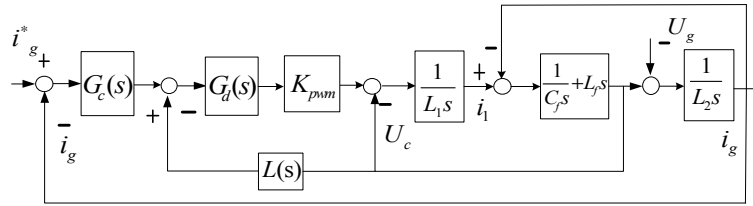

Fig. 9. Control block with lead-lag compensator.

In [21], another active damping method with a lead-lag compensator is proposed, in which the only sensors used are for the output currents and the dc bus voltage. The capacitor voltage is estimated with the virtual flux approach. The signal outputted by the virtual flux block is compensated using a lead-lag element, and then added to the output of the current controller.

Active damping without additional sensors

There are some methods which can stabilize the system resonance without additional sensors: additional delay control, notch filter, choosing appropriate filter parameters and resonance frequency as well as genetic algorithm.

Ref [16] analyzed the stability of a single inverter-side current loop controlled inverter by ignoring delay effect in digital controlled system with inherent damping. But delay is inevitable in digital-controlled system and the delay will change the system phase-frequency characteristic, thus it will affect system stability. Paper [12] shows regions of active damping control for LCL-filter that a single loop is sufficient to achieve stable above the critical frequency and an active damping is necessary below the critical frequency. The value of the delay also influences the stability and robustness of the system. Paper [25] investigates it in detail.

For the LLCL-filter, when the grid-side current is sensed, if an additional delay is considered, there is one pole more in the root locus that attracts the unstable pole versus the unity circle and the delay in the current loop plays a positive role. The filter resonance has no influence on the system stability when the resonant frequency is high, since the phase is already well below -180° due to the sampling and transport delay. But the delay cannot be too large because it will decrease the phase margin. When the converter-side current is sensed, the presence of delays in the current loop plays a negative

role. Fig. 10 shows the bode diagram of open-loop system when grid-side and inverter-side current are used for feedback and T is the delay, respectively. The stability can be achieved choosing appropriate filter parameters and resonance frequency. But this method is sensitive to the variation of the grid impedance and filter parameters.

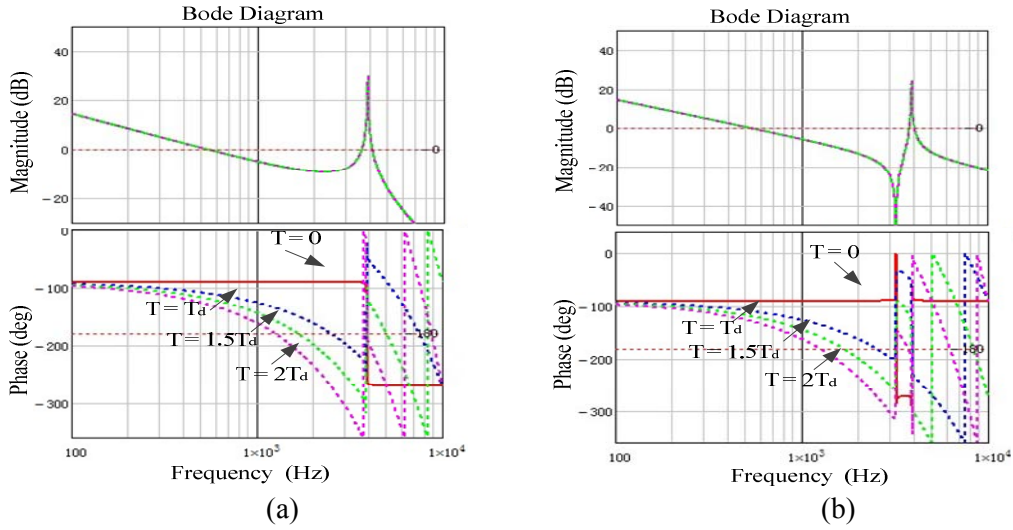

Fig. 10. Bode diagram of (a) open-loop system when grid-side current is used for feedback (a) open-loop system when inverter-side current is used for feedback

A notch filter is another method to damp the resonance. The basic idea can be explained in the frequency domain by introducing a negative peak (notch) in the system that compensates for the resonant peak due to the resonance. The notch filter functions are shown in (6) and (7).

$$H_{notch}(s) = \frac{s^2 + 2\xi_1\omega_r s + \omega_r^2}{s^2 + 2\xi_2\omega_r s + \omega_r^2} \quad (6) \quad \xi_1 \ll \xi_2 \quad (7)$$

ξ_1 and ξ_2 are the zero pole factors of the notch filter and ξ_1 should be equal or less than ξ_2 to make the gain of the notch filter small. Fig. 11 shows the bode plot of notch filter. It can be seen from Fig. 11 that the bandwidth of the notch filter increases with ξ_2 increasing. But the large ξ_2 will lead to big phase lag which will influence the phase margin and stability of the system.

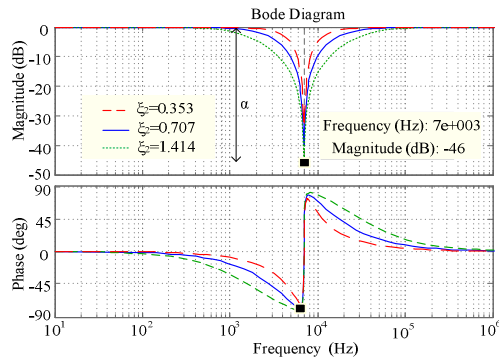

Fig. 11. Bode plot of notch filter

Fig. 12 shows the bode plot of control transfer function. It can be seen that the resonance peak of the LLCL-filter can be cancelled by notch filter. But in the real system there are Paper [26] analyzed a notch filter control method considering the variations in the grid impedance to improve the robustness which also is an important issue for the grid connection.

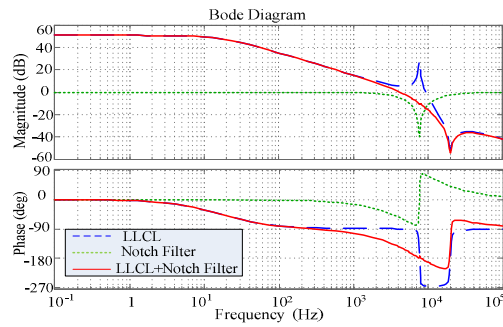

Fig. 12. Bode plot of control transfer function

Another active damping is the Genetic Algorithm (GA) which is based on the use of a filter on the reference voltage for the converter's modulator. This method is used only for the optimum choice of the parameters of the filter and no extra sensors are needed [18].

Based on the active damping methods introduced above, for weak grid it is better to use the virtual resistance method as it is less sensitive to the variation in the grid impedance. Notch filter method needs a grid detection algorithm, as the resonance frequency of the system varies a lot with the impedance of the grid and filter parameters. For stiff grid, active damping without additional sensor is easier and economic.

Conclusion

In this paper, the resonance damping methods for three-phase grid-tied inverter with LLCL-filter are introduced and analyzed including active damping and passive damping. Comparing with LCL-filter, LLCL-filter does not bring complicated control problems and has the similar damping methods.

Passive damping is the most adopted method to guarantee the stability of the high-order filter-based grid converters. Passive damping with only one resistor is simple but it will bring much loss or reduce the high frequency harmonics attenuation. Several advanced passive damping methods with other inductors or capacitors are introduced to reach a better attenuation effect, or reduce loss, or to get a better robust system.

Active damping is a more attractive option to stabilize the system without additional power losses in the system and more flexibility, especially in high power situations. But it requires more sensors and increases the algorithm complexity. This paper introduced also the virtual resistor in a notch concept, which is easier to understand the essence. Some other methods without additional sensors are also effective, but it should be designed carefully in specific system in order to accommodate with robustness.

References

- [1] W. Wu, Y. He, and F. Blaabjerg, "An LLCL power filter for single-phase grid-tied inverter," *IEEE Trans. Power Electron.*, vol. 27, no. 2, pp. 782-789, Feb. 2012.
- [2] J. M. Bloemink, T. C. Green, "Reducing Passive Filter Sizes with Tuned Traps for Distribution Level Power Electronics," in *Proc. IEEE EPE 2011*, Aug. 2011, pp. 1-9.
- [3] K. Dai, K. Duan, X. Wang, "Yong Kang Application of an LLCL Filter on Three-Phase Three-Wire Shunt Active Power Filter," in *Proc. IEEE INTELEC2012*, Sep. 2012, pp. 1-5.
- [4] A.M. Cantarellas, E. Rakhshani, D. Remon, P. Rodriguez, "Design of the LCL+Trap Filter for the Two-Level VSC Installed in a Large-Scale Wave Power Plant," in *Proc. of ECCE 2013*, Denver, Sep. 2012, pp. 707-712.
- [5] W. Wu, Y. He, and F. Blaabjerg, "A New Design Method for the Passive Damped LCL- and LLCL-Filter Based Single-Phase Grid-tied Inverter," *IEEE Trans. Ind. Electron.*, vol. 60, no. 10, pp. 4339-4350, Oct. 2013.

- [6] W. Wu, M. Huang, Y. Sun, X. Wang, F. Blaabjerg, "A composite passive damping method of the LLCL-filter based grid-tied inverter," In Proc. of PEDG 2012, Aalborg, Denmark, 25-28 June 2012, pp: 759 – 766.
- [7] T.C.Y Wang, Z. Ye, G. Sinha, and X. Yuan, "Output Filter Design for a Grid-interconnected Three-phase Inverter", in Proc. of PESC' 03, Acapulco, NM, United States, June 15-19, 2003, pp. 779-784.
- [8] Z. Wenqiang, C. Guozhu, "Comparison of active and passive damping methods for application in high power active power filter with LCL-filter", SUPERGEN, Nanjing, China, 2009, pp.1-6.
- [9] R. Peña-Alzola, M. Liserre, F. Blaabjerg, R. Sebastián, J. Dannehl, F.W. Fuchs, "Analysis of the Passive Damping Losses in LCL-Filter-Based Grid Converters," IEEE Trans. Power Electron., vol.28, no.6, pp. 2642-2646, June 2013.
- [10] P. Channegowda and V. John, "Filter Optimization for Grid Interactive Voltage Source Inverters", IEEE Trans. on Ind. Electron., vol. 57, no. 12, pp. 4106–4114, Dec. 2010.
- [11] M. Liserre, F. Blaabjerg, and S. Hansen, "Design and control of an LCL filter-based three-phase active rectifier," IEEE Trans. Ind. Appl., vol. 41, no. 5, pp. 1281–1291, Sep./Oct. 2005.
- [12] S. Parker, B. McGrath, D.G. Holmes. "Regions of Active Damping Control for LCL Filters," in Proc. IEEE Energy Conversion Congress and Exposition (ECCE), Raleigh, NC, 2012, pp. 53-60.
- [13] M. Liserre, R. Teodorescu, and F. Blaabjerg, "Stability of photovoltaic and wind turbine grid-connected inverters for a large set of grid impedance values", IEEE Trans. Power Electron., vol. 21, no. 1, pp. 263–272, Jan. 2006.
- [14] J. Dannehl, F. Fuchs, S. Hansen, "Investigation of active damping approaches for PI-based current control of grid-connected pulse width modulation converters with LCL filters," IEEE Trans. Ind. Appl., vol.46, no. 4, pp.1509-1517, 2010.
- [15] M. Malinowski and S. Bernet, "A simple voltage sensorless active damping scheme for three-phase PWM converters with an LCL-filter," IEEE Trans. Ind. Electron., vol. 55, no. 4, pp. 1876–1880, Apr. 2008.
- [16] Y. Tang, P. C. Loh, P. Wang, F. H. Choo and F. Gao, "Exploring inherent damping characteristics of LCL-filters for three-phase grid connected voltage source inverters," IEEE Trans. Power Electron., vol. 27, no. 3, pp. 1433-1443, Mar. 2012.
- [17] J. Dannehl, M. Liserre, and F. W. Fuchs, "Filter-Based Active Damping of Voltage Source Converters with LCL Filter" IEEE Trans. Ind. Electron., vol. 58, no. 8, pp. 3623-3633, Aug. 2011.
- [18] M. Liserre, A. D. Aquila, and F. Blaabjerg, "Genetic algorithm-based design of the active damping for an LCL-filter three-phase active rectifier," IEEE Trans. Power Electron., vol. 19, no. 1, pp. 76–86, Jan. 2004.
- [19] M. Huang, Y. Yang, F. Blaabjerg, and W. Wu, "Step by Step Design of a High Order Power Filter for Three-Phase Three-Wire Grid-connected Inverter in Renewable Energy System" In Proc. of PEDG 2013, pp.1-8, Rogers, Arkansas, July 08-11, 2013.
- [20] V. Blasko and V. Kaura, "A novel control to actively damp resonance in input LC filter of a three-phase voltage source converter," IEEE Trans. Ind. Appl., vol. 33, no. 2, pp. 542–550, Mar./Apr. 1997.
- [21] W. Gullvik, L. Norum, and R. Nilsen, "Active damping of resonance oscillations in LCL-filters based on virtual flux and virtual resistor," 2007 European Conference on, Power Electronics and Applications, pages 1–10, 2-5 Sept. 2007.
- [22] R. Peña-Alzola, M. Liserre, F. Blaabjerg, R. Sebastián, J. Dannehl, F.W. Fuchs, "Systematic Design of the Lead-Lag Network Method for Active Damping in LCL-Filter Based Three Phase Converters," IEEE Transactions on, Power Electronics, vol.10, no.1, pp. 43-52, Feb. 2014.
- [23] D. Ricchiuto, M. Liserre, T. Kerekes, R. Teodorescu, F. Blaabjerg, "Robustness analysis of active damping methods for an inverter connected to the grid with an LCL-filter," proc. of Energy Conversion Congress and Exposition (ECCE), 2011 IEEE, on page(s): 2028 – 2035.
- [24] R. Teodorescu, F. Blaabjerg, M. Liserre, and A. Dell'Aquila, "A stable three-phase LCL-filter based active rectifier without damping," in Proc. of 2003 IEEE Ind. Appl. Soc. Annu. Meeting, pp. 1552–1557.
- [25] C. Zou, B. Liu, S. Duan, and R. Li, "Influence of Delay on System Stability and Delay Optimization of Grid-Connected Inverters with LCL Filter," IEEE Trans. Ind. Info., vol. pp, no. 4, pp.1, 2014.
- [26] R. Pena-Alzola, M. Liserre, F. Blaabjerg, M. Ordonez, T. Kerekes, "Self-commissioning Notch Filter for Active Damping in Three Phase LCL-filter Based Grid-tie Converter," IEEE Trans. Power Electron., vol. pp, no. 99, pp. 1, 2014.