



Aalborg Universitet

AALBORG UNIVERSITY  
DENMARK

## Overview of catastrophic failures of freewheeling diodes in power electronic circuits

Wu, Rui; Blaabjerg, Frede; Wang, Huai; Liserre, Marco

*Published in:*  
Microelectronics Reliability

*DOI (link to publication from Publisher):*  
[10.1016/j.microrel.2013.07.126](https://doi.org/10.1016/j.microrel.2013.07.126)

*Publication date:*  
2013

*Document Version*  
Accepted author manuscript, peer reviewed version

[Link to publication from Aalborg University](#)

*Citation for published version (APA):*  
Wu, R., Blaabjerg, F., Wang, H., & Liserre, M. (2013). Overview of catastrophic failures of freewheeling diodes in power electronic circuits. *Microelectronics Reliability*, 53(9-11), 1788–1792.  
<https://doi.org/10.1016/j.microrel.2013.07.126>

### General rights

Copyright and moral rights for the publications made accessible in the public portal are retained by the authors and/or other copyright owners and it is a condition of accessing publications that users recognise and abide by the legal requirements associated with these rights.

- ? Users may download and print one copy of any publication from the public portal for the purpose of private study or research.
- ? You may not further distribute the material or use it for any profit-making activity or commercial gain
- ? You may freely distribute the URL identifying the publication in the public portal ?

### Take down policy

If you believe that this document breaches copyright please contact us at [vbn@aub.aau.dk](mailto:vbn@aub.aau.dk) providing details, and we will remove access to the work immediately and investigate your claim.



Contents lists available at ScienceDirect

## Microelectronics Reliability

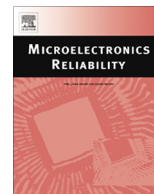
journal homepage: [www.elsevier.com/locate/microrel](http://www.elsevier.com/locate/microrel)

## Overview of catastrophic failures of freewheeling diodes in power electronic circuits

R. Wu<sup>\*</sup>, F. Blaabjerg, H. Wang, M. Liserre

Centre of Reliable Power Electronics (CORPE), Department of Energy Technology, Aalborg University, Pontoppidanstraede 101, 9220 Aalborg, Denmark

### ARTICLE INFO

#### Article history:

Received 24 May 2013

Received in revised form 14 July 2013

Accepted 20 July 2013

Available online xxx

### ABSTRACT

Emerging applications (e.g. electric vehicles, renewable energy systems, more electric aircrafts, etc.) have brought more stringent reliability constraints into power electronic products because of safety requirements and maintenance cost issues. To improve the reliability of power electronics, better understanding of failure modes and failure mechanisms of reliability-critical components in power electronic circuits are needed. Many efforts have been devoted to the reduction of IGBT failures, while the study on the failures of freewheeling diodes is less impressive. It is of importance to investigate the catastrophic failures of freewheeling diodes as they could induce the malfunction of other components and eventually the whole power electronic circuits. This paper presents an overview of those catastrophic failures and gives examples of the corresponding consequences to the circuits.

© 2013 Elsevier Ltd. All rights reserved.

### 1. Introduction

Power electronics plays an important role in energy conversion applications, such as motor drives, utility interfaces with renewable energy sources, power transmission (e.g. high voltage direct current systems, and flexible alternating current transmission systems), electric or hybrid electric vehicles. Therefore, the reliability of power electronics becomes more and more vital, and should draw more attention [1]. According to a survey, semiconductor failures and soldering joints failures in power devices take up 34% of power electronic system failures [2]. Another survey shows that around 38% of faults in variable speed ac drives are due to failures of power semiconductor devices [3]. A recent questionnaire on industrial power electronic systems also shows that the responders regard power electronic reliability as an important issue, and 31% of responders selected power semiconductor devices as the most fragile component in their applications [4]. Therefore, it demands a better understanding of failure mechanisms of power semiconductor devices so as to reduce their failure rates.

Diodes and Insulated Gate Bipolar Transistors (IGBTs) are two kinds of reliability-critical power semiconductor devices widely used in power electronic circuits [1]. Power diodes are usually assumed to have outstanding ruggedness performance. However, freewheeling diodes fail under various circumstances, especially during the turn-on transition of IGBTs in high switching frequency applications. The freewheeling diodes slow down the switching speed of the IGBTs due to severe stresses induced by the reverse recovery process. Therefore, it is worth to investigate the failures

of freewheeling diodes and exploring the solutions to improve the reliability of both freewheeling diodes and IGBTs.

Diode failures can generally be classified as catastrophic failures and wear out failures. Diode wear out failures are mainly induced by accumulated degradation with time, while catastrophic failures are triggered by single-event overstress, such as overvoltage, overcurrent, overheat. Prognostics and Health Management (PHM) method can monitor the degradation of diodes and estimate wear out failures [5]. However, PHM is not applicable for catastrophic failures, which are more difficult to be predicted.

Several overview papers cover the topic on diode failures. In [6], Rahimo et al. discuss the major reverse recovery failure modes of freewheeling diode in IGBT applications. While it only focuses on snappy recovery and dynamic avalanching, no static failure is mentioned. In [7], Ciappa gives a comprehensive overview on the wear out failure mechanisms of power semiconductor devices, such as bond wire fatigue, aluminum reconstruction, substrate cracking, interconnections corrosion, and solder fatigue and voids. However it mainly focuses on IGBT, and freewheeling diodes catastrophic failures are not discussed. Therefore, a detailed and comprehensive review on diode catastrophic failures is still lack in the prior-art literatures. Moreover, it is also worth to investigate the influence of freewheeling diode failures to IGBT operations in power electronic converters.

The aim of this paper is to provide a review of the key behaviors of diode catastrophic failure due to overstresses and the corresponding influence to IGBTs in power electronic circuits. Section 2 classifies the types of freewheeling diode catastrophic failures. Section 3 summarizes the catastrophic failures of diode in terms of failure mode and failure mechanism. Section 4 investigates the influence of freewheeling diode failures to IGBT operations in

<sup>\*</sup> Corresponding author. Tel.: +45 2963 2067; fax: +45 9815 1411.

E-mail address: [rwu@et.aau.dk](mailto:rwu@et.aau.dk) (R. Wu).

power electronic converters, followed by the conclusion in Section 5.

## 2. Classification of failure modes of freewheeling diodes

The catastrophic failure modes of freewheeling diodes can be classified into open-circuit failures and short-circuit failures. Normally open-circuit failures are considered not fatal to converters, since the converter can operate with lower quality of output [8]. On the contrary, short-circuit failures are more fatal to converters, as the uncontrolled short-circuit current may destroy the active switching devices (e.g. IGBTs) or other components in the circuit. Fig. 1 shows the typical open-circuit failures and short-circuit failures of freewheeling diodes.

### 2.1. Open-circuit failures

Freewheeling diode open-circuit failures are generally due to mechanical causes. Open-circuit failure mode can happen because of external disconnections due to vibration, or internally by bond wire lift-off or rupture after temperature swings or high short-circuit current.

### 2.2. Short-circuit failures

Short-circuit is also a common failure mode of freewheeling diodes in power electronic circuits. Failures can happen during reverse blocking state as well as the reverse recovery transition. Fig. 2 shows the definition of reverse and forward voltage for diodes [9]. There are five major failure mechanisms as shown in Fig. 1, which will be discussed in next section.

## 3. Major failure mechanisms of freewheeling diodes

### 3.1. Open-circuit mechanisms

Similar to IGBTs, diode open-circuit will not be initially fatal to the converter, but may result in secondary failures of other devices in a power electronic circuit due to interaction among them.

The mechanism is similar to that of IGBTs. Bond wire lift-off failure can happen after short-circuit, caused by high temperature fatigue and the mismatch of Coefficients of Thermal Expansion (CTEs) between Silicon and Aluminum. Crack may also be initiated at the periphery of the bonding interface, and the bond wire finally lifts-off when crack propagates to the weaker central bonding area. Central bond wires normally fail at first, and then the survivor bond wires follow [10]. Bond wire rupture is usually slower than lift-off mechanism and usually observed after long power cycling tests or long time operation.

### 3.2. Short-circuit mechanisms

The short-circuit failures of freewheeling diode could lead to potential destruction to the relevant IGBTs, and other components, as it induces uncontrolled high current to the circuit. The failure

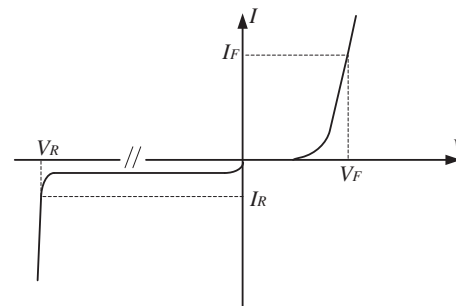

Fig. 2. Definition of reverse and forward voltage of diodes.

mechanisms can be static high voltage breakdown, leakage current rising, snappy recovery, dynamic avalanche during reverse recovery, as well as high temperature due to the power dissipation and so on.

#### 3.2.1. Static high voltage breakdown

High reverse voltage can cause diodes static avalanche. With reverse voltage reaching first static avalanche point, the current rises with positive slope, while no permanent failure happens. If the voltage reaches the second avalanche point, there will be a Negative Differential Resistance (NDR), which will lead to the current filament and a quick short-circuit. Detailed numerical simulations are carried for a rated 3.3 kV/1 kA diode, and the results are shown in Fig. 3 [11]. Another research reveals metallization between copper and silicon can also lead to diode electrical breakdown [12]. It is also revealed that the avalanche capability is strongly dependent on the initial breakdown location and the edge termination design by numerical simulation and experiments, and the common failure locations are near the chip's edge and the bond wires [13]. Since operating voltage of freewheeling diodes is normally much lower than rated voltage, static high voltage breakdown is not common in nowadays applications.

#### 3.2.2. Rising of leakage current

The leakage current of power diodes is usually very low, but it increases with voltage and temperature. The value is roughly doubled for every 10 °C raise of temperature. This effect is more obvious for gold-diffusion diodes, which may be thermally destroyed at high temperature [9].

With operating voltage and temperature above the rating parameters, leakage current increases dramatically and the diodes fall into short circuit at the chip's peripheral surface [14,15]. Experiments show that the diodes operation temperature can be increased without risks of failure by improving the junction edge current control, like a junction passivation process [16,17]. A further research reveals the mechanism is junction carrier avalanche multiplication, and the weak spots are near the chips' edge [18]. The leakage current rising can also be due to repetitive electrostatic discharge [19]. Since short-circuit failures during freewheeling diode reverse status can damage IGBT and circuit quickly, it is critical to prevent this event.

#### 3.2.3. Snappy recovery

Freewheeling diodes are prone to fail easily during reverse recovery process because of snappy recovery. The behavior of snappy recovery is shown in Fig. 4, in which a steep decline in the current is observed after the reverse recovery current reaches the peak value. The main reason is the sudden disappearance of the remaining carriers at the end of the recovery process. Due to high  $di/dt$  and stray inductance in the circuit, high voltage spikes can appear and damage the diode.

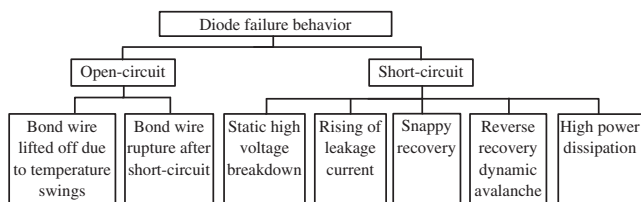

Fig. 1. Overview of freewheeling diodes catastrophic failures.

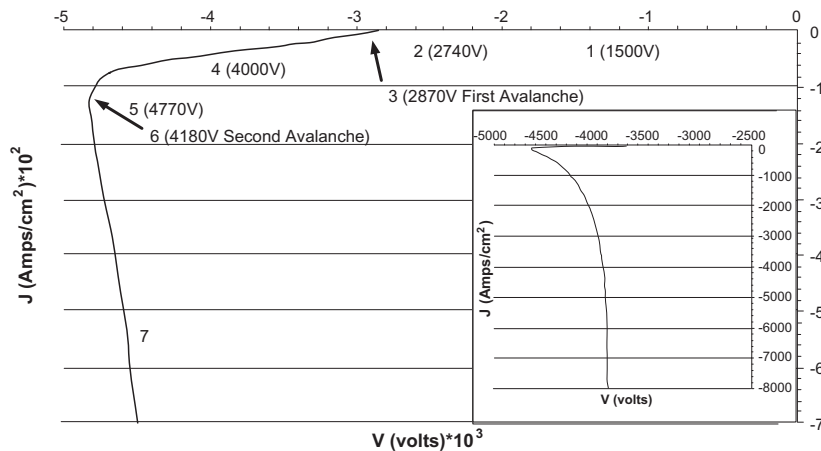

Fig. 3. First and second static avalanche breakdown of a 1700 V rated power diode [11].

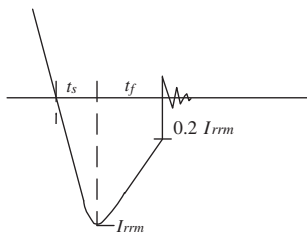

Fig. 4. Current characteristics of snappy reverse recovery behavior [9].

It has been validated that both reverse recovery charge and time increase with diode effective contact area, and snappy recovery is clearly observed for larger area in numerical simulation and experiments [20]. Thus special attention should be paid to choose the diode size for avoiding diode failures. H<sup>+</sup> irradiation has been proposed to obtain trade-off between diodes switching speed and softness, which can avoid snappy recovery, validated by comprehensive experiments and numerical investigations [21–23]. A new design procedure of freewheeling diodes based on measurement and simulation is also proposed to improve the reverse recovery softness [24]. Controlled Injection of Backside Holes (CIBH) diodes are also proposed to increase the soft reverse recovery behavior [25]. However, it is still a critical point to avoid snappy recovery when designing freewheeling diodes.

### 3.2.4. Reverse recovery dynamic avalanche

Dynamic avalanching occurs at high  $di/dt$  switching speeds, as shown in Fig. 5. Dynamic avalanching can result in the generation of a hot spot in the silicon die itself due to non-uniform current crowding which leads to the destruction of the device. The causes of these hot spots can range from process to material variations in a single diode silicon chip [26].

Impact ionization near N-N<sup>+</sup> junction is considered as the main reason for the failure. It leads to the negative differential resistance and current filament, finally a thermal runaway [27–30]. This process called Egawa effect [26] is very similar to the second breakdown in bipolar transistors. Local heating and explosion at the corner of anode is observed even the reverse voltage is lower than static breakdown voltage [31]. A detailed study of dynamical behavior of the plasma layer also explains this reverse recovery failure [32,33]. To avoid the second current bump observed during reverse recovery failure, a merged P-i-N Schottky diode is proposed to replace conventional P-i-N freewheeling diode [34]. It shows

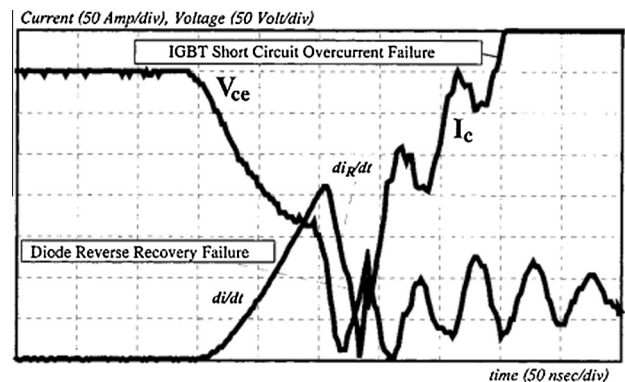

Fig. 5. Freewheeling diode reverse-recovery failure with IGBT short circuit failure [6].

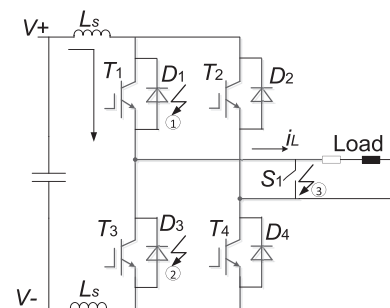

Fig. 6. Operation of a single phase inverter under different failure conditions – ① reverse recovery transition, ② reverse state, ③ load short-circuit.

deep N<sup>+</sup> emitter and wide n-base can improve the dynamic avalanche characteristic in 2D simulations [35,36]. It is also proved CIBH diode can prevent the filaments in N-N<sup>+</sup> junction by 2D numerical simulations [33]. An improved impact-ionization model is proposed to simulate high electrical fields in diodes [37]. Electro thermal simulations show that thermal-induced filament can lead to destructive thermal runaway and it is sensitive to contacts thermal resistance [38]. There could be further work to improve both die structure and thermal performance.

### 3.2.5. High power dissipation

When the diode forward current is high and temperature is rising, the forward voltage will increase. If the forward voltage

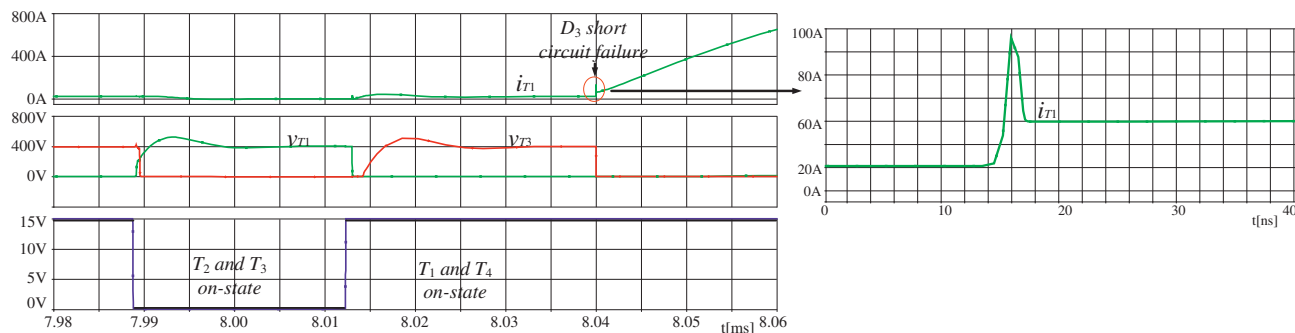

Fig. 7. PSpice simulation waveforms of IGBTs after  $D_3$  short circuit in reverse state.

exceeds a specified limit value, the overload high power dissipation may fatally damage the silicon die [9].

#### 4. Influence of freewheeling diode failures on the operations of IGBTs in power electronic circuits

Fig. 6 shows a single phase inverter consisting of IGBTs ( $T_1$ – $T_4$ ) diodes ( $D_1$ – $D_4$ ), and stray inductance  $L_s$  (which may lead vital stress to device).

The operation of the inverter is as follows: initially,  $T_2$  and  $T_3$  are on, the current  $i_L$  flows through the load, then  $T_2$  and  $T_3$  are turned-off and  $T_1$  and  $T_4$  are switched on after a certain period of dead time. Because the load determines the direction of the current flow, the current will flow through the diodes  $D_1$  and  $D_4$  back to the voltage source. After  $i_L$  decreases to zero and to the negative, the current will flow through  $T_1$  and  $T_4$ .

There are three typical failure behaviors:

- When the current is commutating from diode to IGBT, the freewheeling diode reverse recovery failure may lead to an IGBT short-circuit failure, as shown by ① in Fig. 6.
- When IGBTs  $T_1$  and  $T_4$  are on, and the current  $i_L$  flows through the load, reverse diode  $D_3$  fails into the short-circuit, the short-circuit current between  $V+$  and  $V-$  may damage  $T_1$  fast, as shown ② in Fig. 6.
- When current is flowing through  $D_1$  and  $D_4$ , a load short circuit will cause overstress of the diodes and IGBTs (symbolized as ③ – closing the switch  $S_1$  in Fig. 6). As the current flowing through  $D_1$  and  $D_4$  will be commutated to  $T_1$  and  $T_4$  rapidly, short-circuit current on IGBTs will be larger. During the transient, both the high reverse recovery current and the voltage may produce large energy dissipation and damage the diode. However, the IGBT may also fail first if the peak voltage is over the rated voltage [39].

As an example, Fig. 7 shows the simulation results of the scenario ② in which  $D_3$  is short during the conduction of  $T_1$ . It could subsequently induce the failure of  $T_1$  due to its increased current stress as shown in Fig. 7.

#### 5. Conclusions

The typical failure modes and failure mechanisms of freewheeling diodes due to over stresses are overviewed in this paper. Initial short-circuit failures may lead to open-circuit finally. Short-circuit failures can happen at five typical occasions.

The influence of the freewheeling diode failures to IGBT failures is also investigated on the circuit level. The associated behaviors of the IGBTs are also briefly described.

The overview in this paper could be useful for further work in the following areas: correlations between IGBT and diode failures;

improvements of diode performance due to failure mechanisms; effective protection circuits dealing with different catastrophic failures; fault tolerant design coping with freewheeling diode catastrophic failures; better models of failure mechanisms; better models and tests of devices beyond the specific rating.

#### References

- Wang H, Liserre M, Blaabjerg F. Toward reliable power electronics—challenges, design tools and opportunities. In: IEEE Industrial Electronics Magazine, vol. 7, June 2013. p. 17–26.
- Wolfgang E. Examples for failures in power electronics systems. In: Presented at ECPE tutorial on reliability power electronic system, Nuremberg, Germany; April 2007.
- Fuchs FW. Some diagnosis methods for voltage source inverters in variable speed drives with induction machines—A survey. In: Proceedings of IEEE industrial electronics society annual conference; 2003. p. 1378–1385.
- Yang S, Bryant AT, Mawby PA, Xiang D, Ran L, Tavner P. An industry-based survey of reliability in power electronic converters. IEEE Trans Ind Appl 2011;47(3):1441–51.
- Vichare NM, Pecht MG. Prognostics and health management of electronics. IEEE Trans Compon Packag Technol 2006;29(1):222–9.
- Rahimo MT, Shammam NYA. Freewheeling diode reverse-recovery failure modes in IGBT applications. IEEE Trans Ind Appl 2001;37(2):661–70.
- Ciappa M. Selected failure mechanisms of modern power modules. Microelectron Reliab 2002;42(4–5):653–67.
- Swamy M, Rossiter S. Typical problems encountered with variable frequency drives in the industry. In: Proc Ind Appl Soc Ann Meet; October 1993. p. 503–10.
- Wintrich A, Nicolai U, Tursky W, Reimann T. Application manual power semiconductor. ISLE Verlag, ISBN: 978-3-938843-66-6; 2011. p. 30–6.
- Ciappa M., Wolfgang F. Lifetime prediction of IGBT modules for traction applications. In: Proceedings of 38th annual 2000 IEEE international reliability physics, symposium; 2000. p. 210–6.
- Huang AQ, Temple V, Liu Y, Li Y. Analysis of the turn-off failure mechanism of silicon power diode. Solid-State Electron 2003;47(4):727–39.
- Baumann J, Kaufmann Ch, Rennau M, Werner Th, Gessner T. Investigation of copper metallization induced failure of diode structures with and without a barrier layer. Microelectron. Eng. 1997;33(1–4):283–91.
- Kim SS, Oh KH, et al. Degradation of avalanche ruggedness of power diodes by thermally induced local breakdown. In: Proceedings of 37th IEEE annual power electronics specialists conference; June 2006. p. 1–5.
- Obreja VVN, Codreanu C, Nuttall KI, Buiu O. Reverse current instability of power silicon diodes (thyristors) at high temperature and the junction surface leakage current. In: Proceedings of the IEEE international symposium on industrial electronics; June 2005. p. 417–22.
- Obreja VVN, Podaru C, Manea E, Obreja A, Svasta P. Failure analysis of diode (thyristor) dice from power semiconductor modules after operation above the maximum specified temperature. In: Proceedings of 1st electronics system integration technology conference; 2007. p. 1230–5.
- Obreja VVN. On the reliability of power silicon rectifier diodes above the maximum permissible operation junction temperature. In: Proceedings of IEEE international symposium on industrial electronics; July 2006. p. 835–40.
- Obreja VVN. On the maximum permissible working voltage of commercial power silicon diodes and thyristors. In: Proceeding of IEEE international symposium on industrial, electronics; June 2007. p. 401–6.
- Obreja VVN, Codreanu C, Poenar D, Buiu O. Edge current induced failure of semiconductor PN junction during operation in the breakdown region of electrical characteristic. Microelectron. Reliab. 2011;51(3):536–42.
- Diatta M, Tremouilles D, Bouysson E, Perdreau R, Anceau C, Baffeur M. Understanding the failure mechanisms of protection diodes during system level ESD: toward repetitive stresses robustness. IEEE Trans Electron Devices 2012;59(1):108–13.
- Rahimo MT, Shammam NYA. Design considerations of the diode effective area with regard to the reverse recovery performance. Microelectron J 1999;30(6): 499–503.



- [21] Cova P, Menozzi R, Portesine M. Experimental and numerical study of the recovery softness and overvoltage dependence on p-i-n diode design. *Microelectron J* 2006;37(5):409–16.
- [22] Cova P, Menozzi R, Portesine M. Power p-i-n diodes for snubberless application: H<sup>+</sup> irradiation for soft and reliable reverse recovery. *Microelectron Reliab* 2003;43(1):81–7.
- [23] Cova P, Menozzi R, Portesine M, Bianconi M, Gombia E, Mosca R. Experimental and numerical study of H<sup>+</sup> irradiated p-i-n diodes for snubberless applications. *Solid-State Electron* 2005;49(2):183–91.
- [24] Bertoluzza F, Cova P, Delmonte N, et al. Coupled measurement-simulation procedure for very high power fast recovery – soft behavior diode design and testing. *Microelectron Reliab* 2010;50(9–11):1720–4.
- [25] Felsl HP, Pfaffenlehner M, et al. The CIBH diode – great improvement for ruggedness and softness of high voltage diodes. In: Proceedings of 20th international symposium on power semiconductor devices and IC's; May 2008. p. 173–6.
- [26] Egawa H. Avalanche characteristics and failure mechanism of high voltage diodes. *IEEE Trans Electron Devices* 1966;13(11):754–8.
- [27] Domeij M, Breitholtz B, Hillkirk LM, Linnros J, Ostling M. Dynamic avalanche in 3.3-kV Si power diodes. *IEEE Trans Electron Devices* 1999;46(4):781–6.
- [28] Oetjen J, Jungblut R, Kuhlmann U, Arkenau J, Sittig R. Current filamentation in bipolar power devices during dynamic avalanche breakdown. *Solid-State Electron* 2000;44(1):117–23.
- [29] Lutz J, Scheuermann U, Schlangenotto H, de Doncker R. Semiconductor power devices. Springer Verlag; 2011. ISBN: 3642111246.
- [30] Domeij M, Breitholtz B, et al. Avalanche injection in high voltage Si P-i-N diodes measurements and device simulations. In: Proceedings of 1997 IEEE international symposium on power semiconductor devices and IC's; May 1997. p. 125–8.
- [31] Tomomatsu Y, Suekawa E, Enjoji T, et al. An analysis and improvement of destruction immunity during reverse recovery for high voltage planar diodes under high  $dI_{rr}/dt$  condition. In: Proceedings of 8th international symposium on power semiconductor devices and IC's; May 1996. p. 353–6.
- [32] Baburske R, Heinze B, Lutz J, Niedernostheide F. Charge-carrier plasma dynamics during the reverse-recovery period in p<sup>+</sup>-n-n<sup>+</sup> diodes. *IEEE Trans Electron Devices* 2008;55(8):2164–72.
- [33] Baburske R, Heinze B, Niedernostheide F, et al. On the formation of stationary destructive cathode-side filaments in p<sup>+</sup>-n-n<sup>+</sup> diodes. In: Proceedings of 21st international symposium on power semiconductor devices & IC's; June 2009. p. 41–4.
- [34] Mulay A, Trivedi M, Shenai K. Dynamic avalanching considerations in optimization of reverse conducting diode in IGBT modules. In: Proceedings of the 1998 bipolar/BiCMOS circuits and technology meeting; September 1998. p. 195–8.
- [35] Domeij M, Breitholtz B, et al. Stable dynamic avalanche in Si power diodes. *Appl Phys Lett* 1999;74(21):3170–2.
- [36] Domeij M, Lutz J, Silber D. On the destruction limit of Si power diodes during reverse recovery with dynamic avalanche. *IEEE Trans Electron Devices* 2003;50(2):486–93.
- [37] Pan Z, Holland S, et al. Improved impact-ionization modelling and validation with pn-junction diodes. In: Proceedings of 2010 international conference on simulation of semiconductor processes and devices; September 2010. p. 287–90.
- [38] Milady S, Silber D, Niedernostheide F-J, Felsl HP. Different types of avalanche-induced moving current filaments under the influence of doping inhomogeneities. *Microelectron J* 2008;39(6):857–67.
- [39] Lutz J, Dobler R, Mari J, Menzel M. Short circuit III in high power IGBTs. In: Proceedings of 13th European conference on power electronics and applications; September 2009. p. 1–8.