



Aalborg Universitet

AALBORG UNIVERSITY  
DENMARK

## Emulating Spatial Characteristics of MIMO Channels for OTA Testing

Fan, Wei; Carreño, Xavier; Sun, Fan; Nielsen, Jesper Ødum; Knudsen, Mikael B.; Pedersen, Gert Frølund

*Published in:*  
I E E E Transactions on Antennas and Propagation

*DOI (link to publication from Publisher):*  
[10.1109/TAP.2013.2261974](https://doi.org/10.1109/TAP.2013.2261974)

*Publication date:*  
2013

*Document Version*  
Early version, also known as pre-print

[Link to publication from Aalborg University](#)

*Citation for published version (APA):*  
Fan, W., Carreño, X., Sun, F., Nielsen, J. Ø., Knudsen, M. B., & Pedersen, G. F. (2013). Emulating Spatial Characteristics of MIMO Channels for OTA Testing. *I E E E Transactions on Antennas and Propagation*, 61(8), 4306 - 4314. <https://doi.org/10.1109/TAP.2013.2261974>

### General rights

Copyright and moral rights for the publications made accessible in the public portal are retained by the authors and/or other copyright owners and it is a condition of accessing publications that users recognise and abide by the legal requirements associated with these rights.

- ? Users may download and print one copy of any publication from the public portal for the purpose of private study or research.
- ? You may not further distribute the material or use it for any profit-making activity or commercial gain
- ? You may freely distribute the URL identifying the publication in the public portal ?

### Take down policy

If you believe that this document breaches copyright please contact us at [vbn@aub.aau.dk](mailto:vbn@aub.aau.dk) providing details, and we will remove access to the work immediately and investigate your claim.

# Emulating Spatial Characteristics of MIMO Channels for OTA Testing

Wei Fan, Xavier Carreño, Fan Sun, Jesper Ø. Nielsen, Mikael B. Knudsen and Gert F. Pedersen

**Abstract**—This paper discusses over the air (OTA) testing for multiple input multiple output (MIMO) capable terminals with emphasis on channel spatial characteristics emulation. A novel technique to obtain optimum power weights for the OTA probes based on convex optimization is proposed. The proposed technique emulates spatial correlation as well as introduces constraints on the maximum deviation between the target power azimuth spectrum (PAS) and the emulated PAS in terms of mean angle of arrival (AoA) and azimuth spread (AS). Simulation results show that the proposed emulation technique present better performance compared with existing techniques in the literature. This improvement is further demonstrated by measurement results in a practical MIMO OTA setup.

**Index Terms**—Channel emulation, MIMO OTA, anechoic chamber, power azimuth spectrum, spatial correlation, convex optimization.

## I. INTRODUCTION

The Multiple Input Multiple Output (MIMO) technique is an attractive and promising technology to improve performance of wireless communication systems. With MIMO technology being adopted by new wireless technologies such as LTE, LTE-Advanced and WIMAX, mobile network operators and manufactures urgently require standard test methods which are suitable to test the MIMO device performance. MIMO Over The Air (OTA) testing, which is considered a promising solution to evaluate devices in realistic situations, has attracted huge interest from both industry and academia. Many different MIMO test methods have been proposed which vary widely in how they emulate the propagation channel. An overview was presented in [1].

One promising approach is a multi-probe anechoic chamber based method. With this method, multipath environments in which the performance of the device is evaluated can be physically emulated in a controllable manner. The focus is on reproducing spatial aspects of the channel, which is new and critical as we extend Single Input Single Output (SISO) OTA to MIMO OTA testing.

The concept of clusters has been widely adopted to model the multipath phenomenon based on extensive measurements. A cluster has a specific Power Azimuth Spectrum (PAS) shape. For MIMO OTA testing, it is desirable that with a limited number of probes we should generate an arbitrary number of clusters, each associated with an arbitrary mean

Angle of Arrival (AoA) and Azimuth Spread (AS) impinging the test zone. It has been shown that the essence is to find proper power weightings for each probe such that channel spatial characteristics can be recreated [2]–[5]. This idea was named prefaded signal synthesis technique and was detailed in [4]. Several optimization techniques are proposed to obtain optimum probe power weightings. However, most techniques, which are based on numerical optimization, can be very computationally inefficient.

The PAS is of great importance for multiple antenna techniques with spatial treatment of the incoming signals. The spatial correlation between the waves impinging on two antenna elements depends on the PAS and on the radiation pattern of the antenna elements. Spatial correlation has been selected as the main figure of merit to characterize the channel spatial information, while cluster PAS shape parameters including AS and mean AoA are often ignored [2], [3], [5]. Channel profiles with the same spatial correlation may present very different PAS shapes when the spatial sampling points for spatial correlation calculation are limited, e.g. on a line [3], [4] or on a circle [6]. To solve the problem, a new way to select spatial samples for optimization is proposed in this paper. Also, to obtain an accurate resulting PAS shape in terms of AoA and AS, constraints are introduced for spatial correlation emulation. Note that emulation accuracy in this paper denotes the difference between emulated spatial correlation resulting from the discrete PAS composed by the probe power weights and target spatial correlation resulting from the continuous PAS. To the best of our knowledge, the proposed spatial sample selection method and the spatial correlation emulation with constraints on the resulting discrete PAS have not been achieved in the literature so far. In [3]–[6], spatial correlation was selected as the objective function without constraints on the resulting discrete PAS shape, although the possibility of joint optimizing cluster mean AoA and spatial correlation was briefly mentioned in [3].

In this paper, we first form the channel emulation problem with constraints on the resulting discrete PAS shape such as AS and mean AoA, when angular locations of OTA probes are fixed. We further illustrate the problem can be expressed as a convex optimization problem [7], which can be solved efficiently. The main contributions of this work are two-fold: the proposed emulation problem with constraints on the resulting discrete PAS shape gives a more realistic characterization; employing convex optimization framework into channel emulation can greatly reduce the computational complexity compared to known results based on numerical optimizations. Furthermore, the relationship between the required number of

Wei Fan, Fan Sun, Jesper Ø. Nielsen, and Gert F. Pedersen are with the Antennas, Propagation and Radio Networking section at the Department of Electronic Systems, Faculty of Engineering and Science, Aalborg University, Denmark (email: {wfa, fs, jni, gfp}@es.aau.dk).

Xavier Carreño and Mikael B. Knudsen are with Intel Mobile Communications, Denmark (email: {xavier.carreno, mikael.knudsen}@intel.com).

probes and test area size is derived based on the proposed optimization technique. Also, the impact of channel models on the emulation accuracy has been investigated. In the end the proposed optimization algorithm is compared with the algorithm implemented in a commercial channel emulator in a practical MIMO OTA setup and better emulation accuracy is demonstrated by the measurement results.

*Notations:*  $\|\cdot\|_1$  and  $\|\cdot\|_2$  denote the first order norm and the second order norm, respectively.

## II. METHOD

### A. Configuration of MIMO OTA setup and problem statement

Figure 1 illustrates a general setup for the multi-probe anechoic chamber based method. Probes are located on a horizontally oriented ring and a Device Under Test (DUT) is placed at the center of the anechoic chamber. To alleviate the complexity and cost of 3D multi-probe setup, the simpler 2D configurations are considered in this work.

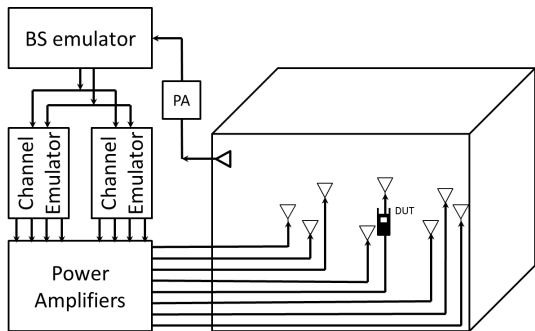

Fig. 1. An illustration of the MIMO OTA setup. The measurement system consists of a Base Station (BS) emulator, one or several channel emulators, an anechoic chamber, probes, a DUT, a turntable, cables and power amplifiers. Test area defines the maximum dimension of the DUT and is an area where target channel characteristics are reproduced with certain accuracy requirement.

The idea of prefaded signal synthesis technique is to radiate independent fading signals from multiple probes on the basis of power weights determined by the emulated channel [2], [4], [5]. In order to reconstruct the PAS of each cluster, a single cluster should be mapped to several OTA probes depending on the PAS shape and OTA probe angular locations. For each cluster, receiver side spatial characteristics are reconstructed by allocating appropriate average power weights to the associated OTA probes. The focus of this paper is to obtain optimum power weightings to recreate the target channel spatial characteristics.

### B. Channel PAS model

PAS shape of clusters have been widely studied in the literature. Several PAS models, namely wrapped Gaussian [8], uniform, truncated Laplacian [9] and Von Mises distribution [10] have been proposed based on extensive measurements in various scenarios. For the sake of simplicity, we assume each cluster is defined with an interval of  $[\phi_p - \pi, \phi_p + \pi]$  centered at AoA  $\phi_p$ . Figure 2 illustrates several different PAS distributions.

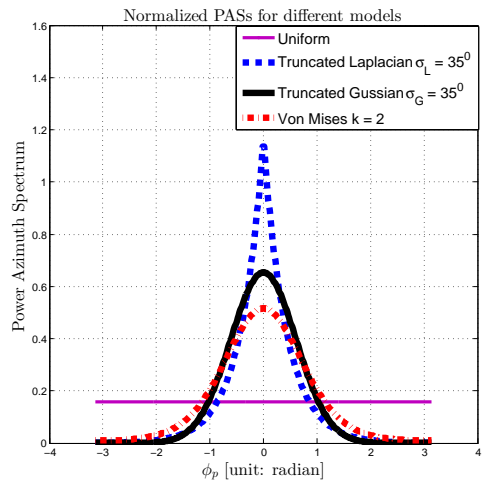

Fig. 2. Normalized PASs. For the 4 different PASs, the clusters have the same mean angle of incidence  $\overline{\phi_p} = 0^\circ$ .  $\sigma_G$  and  $\sigma_L$  are standard deviations of wrapped Gaussian and truncated Laplacian distribution respectively.  $k$  in Von Mises distribution controls the angle spread.

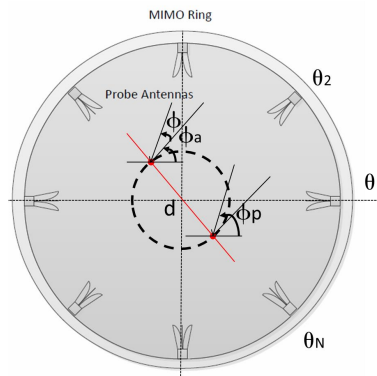

Fig. 3. An illustration of the OTA probe setup.  $\theta_i$  is angular location of the  $i$ th probe.

### C. Criterion to model channel spatial characteristics

The spatial correlation has been selected as a main criterion to model spatial characteristics of the channel [2], [4], [5]. Spatial correlation is a statistical measure of the similarity of the received signals. The angle notations are illustrated in Figure 3. A plane wave with AoA  $\phi_p$  impinges on an array with two antenna elements separated by a distance  $d$ , the direction of the array boresight is  $\phi_a$ .  $\phi$  is the angle of the plane wave with respect to the boresight of the antenna elements. As detailed in [11], the spatial correlation can be written as:

$$\rho = \frac{\int_{-\pi}^{\pi} G_1(\phi)G_2^*(\phi)p(\phi)d\phi}{\sqrt{\int_{-\pi}^{\pi} p(\phi)|G_1(\phi)|^2d\phi}\sqrt{\int_{-\pi}^{\pi} p(\phi)|G_2(\phi)|^2d\phi}} \quad (1)$$

where  $G_1$  and  $G_2$  are the complex radiation patterns of antenna element 1 and 2, respectively, with a common phase center.  $p(\phi)$  is the PAS. In order to be used as an angular power density function, the  $p(\phi)$  needs to satisfy  $\int_{-\pi}^{\pi} p(\phi)d\phi = 1$ .

As stated in [4], the antenna pattern is usually assumed omnidirectional for channel emulation purpose since the DUT

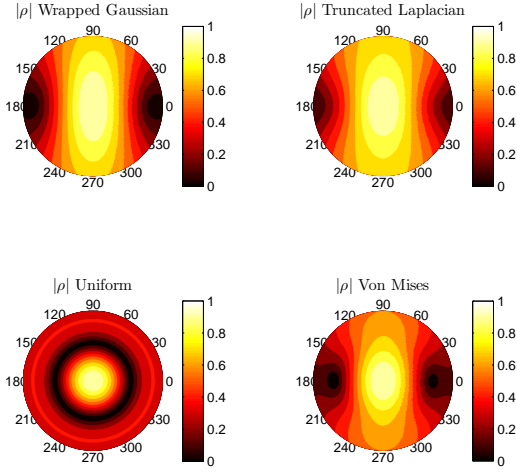

Fig. 4. Theoretical spatial correlation  $|\rho|$  for the PASs shown in Figure 2. Test area size:  $0.7\lambda$ .

antenna pattern is typically unknown. Using this property, we can rewrite (1) as

$$\rho(d, \phi_a) = \int_{-\pi}^{\pi} \exp(-j2\pi \frac{d}{\lambda} \sin(\phi_p - \phi_a)) p(\phi_p) d\phi_p. \quad (2)$$

A specific PAS can be formed by introducing a number of plane waves each with an appropriate AoA and power value. Two different methods to discretize the PAS were discussed in the literature. One method allocates the same power to each ray while arranging the plane wave angles in a non-uniform manner. In the other method, the power of the rays follows the PAS distribution with their angles uniformly distributed.

The mean AoA  $\overline{\phi_p}$  and AS  $\sigma_p$  are also used to model the PAS, which are defined according to the definition in the Annex A of [12]. Note that circular AS is introduced to solve the ambiguity problem for the AS of the PAS.

As illustrated in Figure 4, spatial correlation is a function of the normalized antenna distance  $d$  and antenna orientation  $\phi_a$ . Each sub-figure corresponds to one PAS shown in Figure 2. The radius and polar angle of each point on the plots correspond to the value at distance  $d$  and antenna orientation  $\phi_a$ . Maximum radius of the circle corresponds to the test area size. The correlation globally decreases with increasing distance for all PASs, as expected.

#### D. Optimal Probe Power Weights

As detailed below, the goal is to obtain the optimum OTA probe power weights so as to:

- Minimize the deviation between the theoretical spatial correlations resulting from a target PAS and the correlation resulting from a discrete PAS characterized by power weights of the probes.
- Constrain the maximum deviation between the target PAS and a discrete PAS characterized by power weights of the probes in terms of AS and mean AoA.

Several contributions in literature have addressed this issue. In [5], several exhaustive search techniques are used to obtain optimum angular location and power weight for each of the probes. In [2], the angular location of probe is considered as a factor to be optimized in order to build the optimum test system. However, such flexible setup might not be practical in an actual setup. It is desirable that the probes are fixed on the OTA ring where frequent probe location adjustment may pose a huge challenge on system calibration. Given this practical issue, OTA setups with flexible probe locations are not considered in this paper.

1) *Emulated spatial correlation:* The probe angular locations are depicted in Figure 3.  $\boldsymbol{\theta} = [\theta_1, \dots, \theta_N]^T$  is the vector containing the fixed angular locations of the probes with  $\theta_n \in [0, 2\pi]$  and  $N$  is the number of OTA probes.  $\boldsymbol{w} = [w_1, \dots, w_N]^T$  is the vector containing the power allocated for probes. A location pair  $(d, \phi_a)$  is used to represent the locations of two spatial samples with distance  $d$  and orientation  $\phi_a$ , and there are in total  $M$  location pairs. The spatial correlation for an antenna pair with antenna separation  $d$  and array orientation  $\phi_a$  can be calculated based on the discrete PAS characterized by  $N$  probes as:

$$\hat{\rho}(d, \phi_a) = \boldsymbol{w}^T \cdot \boldsymbol{a}(d, \phi_a) \quad (3)$$

where  $\boldsymbol{a}(d, \phi_a) = [a_1(d, \phi_a), \dots, a_N(d, \phi_a)]^T$  with  $a_n(d, \phi_a) = \exp(-j2\pi \frac{d}{\lambda} \sin(\theta_n - \phi_a))$ .

2) *Practical constraints:* An important contribution of this paper is to introduce constraints on the PAS shape for the optimization. Two completely different PASs may result in similar spatial correlations if limited spatial samples are selected for the spatial correlation calculation. Thus, we need to consider the PAS shape as constraints for optimization. It is desirable that the mean AoA  $\overline{\phi}^{OTA}$  and AS  $\sigma^{OTA}$  resulting from a discrete PAS should be close to those from the target PAS. In addition, from a realistic point of view, probes with smaller angular distance to the PAS cluster mean AoA  $\overline{\phi_p}$  should be allocated with more power, which can be mathematically expressed as  $w_i \geq w_j$  for  $|\theta_i - \overline{\phi_p}| \leq |\theta_j - \overline{\phi_p}|$  ( $i \neq j$ ). One more constraint with the practical system is that probe weights are limited, as the output gain of typical channel emulators is limited to 0 dB.

3) *Objective function:* Let us denote  $\hat{\boldsymbol{\rho}}$  and  $\boldsymbol{\rho}$  to be the emulated spatial correlation and target spatial correlation vectors with each element corresponding to the spatial correlation between two isotropic antennas at a certain location pair. The objective function is evaluated over  $M$  location pairs, and hence  $\boldsymbol{\rho}$  and  $\hat{\boldsymbol{\rho}}$  are  $M \times 1$  vectors:

$$\min_{\boldsymbol{w}} \|\hat{\boldsymbol{\rho}}(\boldsymbol{w}) - \boldsymbol{\rho}\|_2^2 \quad (4)$$

$$\text{s. t. } \|\boldsymbol{w}\|_1 = 1, \quad 0 \leq w_i \leq 1 \quad (\forall i \in [1, N])$$

$$|\boldsymbol{b}^T \boldsymbol{w} - \overline{\phi_p}| \leq \epsilon_{AoA}$$

$$\boldsymbol{c}^T \boldsymbol{w} \leq (\epsilon_{AS} + \sigma_p)^2, \quad \boldsymbol{c}^T \boldsymbol{w} \geq (\epsilon_{AS} - \sigma_p)^2$$

$$w_i \geq w_j, \quad \text{if } |\theta_i - \overline{\phi_p}| \leq |\theta_j - \overline{\phi_p}| \quad (i \neq j)$$

where the mean AoA and AS of the resulting discrete PAS is

$$\bar{\phi}^{OTA} = \sum_{i=1}^N \chi_i w_i = \mathbf{b}^T \mathbf{w} \quad (5)$$

$$\sigma^{OTA} = \sqrt{\sum_{i=1}^N (\chi_i - \bar{\phi}_p)^2 w_i} = \sqrt{\mathbf{c}^T \mathbf{w}} \quad (6)$$

with

$$\chi_i = \begin{cases} \theta_i - 2\pi & \text{if } \theta_i - \bar{\phi}_p > \pi \\ \theta_i & \text{if } -\pi < \theta_i - \bar{\phi}_p < \pi \\ \theta_i + 2\pi & \text{if } \theta_i - \bar{\phi}_p < -\pi \end{cases}$$

$\epsilon_{AoA}$  and  $\epsilon_{AS}$  are the error tolerance for the emulated PAS in terms of mean AoA and AS respectively.  $\mathbf{b}$  and  $\mathbf{c}$  being two known  $N \times 1$  vectors defined in (5) and (6), respectively.  $\mathbf{w}$  can be obtained by solving the objective function, which is a quadratic programming problem with linear constraints when the probe positions are fixed. Therefore, we can easily solve the problem in (4) via a popular convex problem solver CVX in [7].

### E. Selecting spatial samples inside the test area

1) *State of the art*: In the following, we first summarize two existing ways to select spatial samples inside the test area in the literature:

- One option is that we can fix  $\phi_a$  while varying  $d$  to obtain spatial samples. That is, the spatial samples are selected on a line.  $d$  linearly steps from 0 to the test area size  $D$ . In [3], the objective function used minimize deviations for a fixed orientation. Also, it is mentioned that cluster AoA can be considered for the joint optimization, but it is not specified further.
- The other option is that we can fix  $d$  while varying  $\phi_a$  for optimization. That is, spatial samples are selected on a circle.  $\phi_a$  linearly steps from 0 to  $2\pi$ . In [5], the optimization was done for a fixed distance.

2) *Proposed spatial sample point selection*: The above-mentioned two ways to obtain spatial samples will give optimum results at a certain fixed orientation  $\phi_a$  or a certain fixed separation  $d$ . However, they might not give optimum emulation results for all orientations and separations within the test area and emulation accuracy might be critically bad at some orientations or separations. As for the new proposal, samples are covering the whole test area.  $d$  is swept linearly from 0 to the test area size  $D$  and  $\phi_a$  is swept linearly from 0 to  $2\pi$  for the optimization.

Note that for limited spatial sample points cases, e.g. spatial samples are selected on a line or on a circle, constraints on discrete resulting PAS shape have to be added for spatial correlation optimization. Otherwise the resulting discrete PAS might be very different from the target PAS. Similarly, if other objective functions, e.g.  $||\rho| - |\hat{\rho}||$  in [6] is selected, adding the constraint on the resulting PAS shape will also be beneficial to obtain accurate resulting PAS shape. With the proposed technique to select spatial samples, the resulting discrete PAS will be close to the target continuous PAS shape and the constraints

on the PAS shape are not critical. Usually the constraints on resulting PAS shape will be automatically satisfied. An accurate resulting PAS shape can be obtained by adding the constraints in the optimization, with a slight degradation for spatial correlation optimization if the constraints on resulting discrete PAS are necessary. Below in the simulation the error tolerance  $\epsilon_{AS}$  and  $\epsilon_{AoA}$  are selected to be  $1^\circ$  to obtain accurate AoA and AS of the resulting PAS.

### F. Emulation for multi-cluster PAS

The radio waves could gather in several clusters distributed over the space domain. In standard channel models, i.e. SCME [9], clusters are with different delays. Techniques to emulate the multi-cluster PAS are discussed in [6]. In order to preserve the delay information, each cluster is emulated individually with the probes. The SCME Urban macro (UMA) TDL model (six Laplacian shaped clusters) from [9] has been selected as the target channel model for emulation in this paper. The normalized power weights for each cluster in the SCME UMA TDL model are shown in Figure 5 (left), and the target normalized PAS for SCME UMA TDL model (right) is shown in Figure 5 (right). Note that the power weights need to be scaled according to the power per cluster as specified in the SCME UMA TDL model. Extensive measurements on the channel emulator uncertainty level have been performed previously, e.g. [13]. Measurement results have shown that the power weight information can be accurately generated in the channel emulator. Spatial correlation  $|\rho|$  for the SCME UMA TDL model are shown in Figure 6.

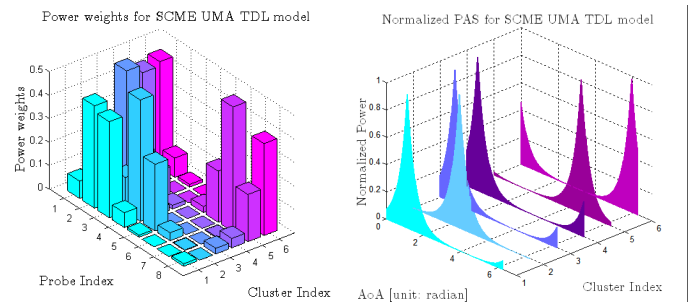

Fig. 5. Normalized power weights for each cluster in the SCME UMA TDL model obtained with the proposed technique (left) and target normalized PAS for SCME UMA TDL model (right).

## III. SIMULATION RESULTS

The emulation results for different PASs are firstly shown in this part. After that, several algorithms in the literature are compared with the proposed solution in terms of spatial correlation error. Furthermore, the impact of cluster PAS on the correlation error has been investigated. In the end of this part, the relationship between the required number of probes and test area size is shown for the proposed optimization technique. For the possibility to recreate any spatial channel model without relocation of the probes, the configuration where all the probes are equally spaced on an OTA ring is

considered in the simulation. The number of probes  $N$  is selected to be 8 unless otherwise stated.

### A. Spatial correlation for different PASs

As we can see in Figure 7, correlation error depends on the the channel model and generally gets worse as the normalized distance increases. Wrapped Gaussian and truncated Laplacian distributions shown in Figure 2 present similar correlation error.

The correlation error  $|\hat{\rho} - \rho|$  for SCME UMA TDL model with the proposed algorithm is shown in Figure 6. Maximum deviation of 0.03 is achieved over the test area size  $0.5\lambda$ .

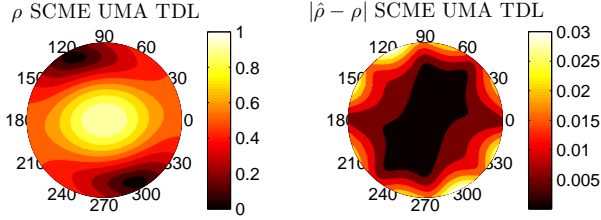

Fig. 6.  $|\rho|$  and correlation error  $|\hat{\rho} - \rho|$  for SCME UMA TDL model. Test area size:  $0.5\lambda$ .

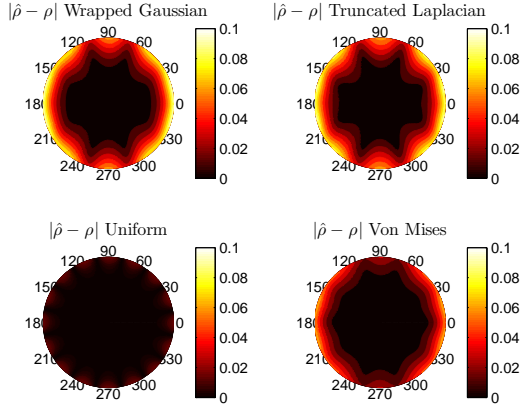

Fig. 7. Correlation error  $|\hat{\rho} - \rho|$  for PASs shown in Figure 2. Test area size:  $0.7\lambda$ .

### B. Comparison of correlation error for different algorithms in literature

In this section, the proposed optimization algorithm is compared with the results published in [6] and the algorithm implemented in a commercial channel emulator from Elektorbit (EB). The SCME UMA TDL model is chosen for illustration and the test area size is selected to be  $0.5\lambda$ . In [6] and [5], the probe power weights are optimized for a fixed antenna separation without considering the PAS shape such as AoA and AS. The objective function is to minimize the absolute spatial correlation error  $||\rho| - |\hat{\rho}||$ . The optimization algorithm used in the EB channel emulator is briefly discussed in [3]. The probe power weights are obtained by optimizing for one or several fixed antenna orientations. The Least Square Error

(LSE) technique was used to obtain the power weightings. It is mentioned in [3] that cluster mean AoA could be jointly considered when optimizing the power weightings, but the detailed algorithm is not given. For the sake of simplicity, the algorithm implemented in the EB channel emulator is named here after as the reference method [3], [4]. Here we will show the main advantages of our proposed algorithm through simulation results.

One advantage with the proposed algorithm is that by employing convex optimization framework into channel emulation, computational complexity is reduced dramatically compared to other numerical optimization techniques [5].

The correlation error for the multi-cluster SCME UMA TDL model is improved. The proposed algorithm presents maximum deviation of 0.03 over the test area, as shown in Figure 6. The correlation error for the SCME UMA TDL model based on power weights from [6] and the reference method is shown in Figure 8. Maximum deviation over the test area is 0.07 and 0.06, respectively.

The correlation error for each individual cluster of the SCME UMA TDL model is also improved. The correlation error  $||\rho| - |\hat{\rho}||$  for the 6th cluster of the SCME UMA TDL model based on [6] is shown in Figure 9. At the antenna distance  $d = 0.5\lambda$  selected for optimization, maximum deviation  $||\rho| - |\hat{\rho}||$  is 0.01. However, correlation error at other antenna distances can be much worse. Maximum deviation  $||\rho| - |\hat{\rho}||$  at antenna distance  $d = 0.25\lambda$  is around 0.12. For the reference method, correlation error at some antenna orientations are worse (i.e.  $\phi_a = 120^\circ$ ) than the other orientations. This is expected from the description in [3]. The proposed algorithm gives better correlation results for all antenna orientation and antenna separation within the test area.

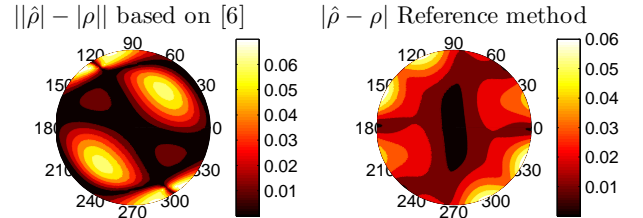

Fig. 8. Correlation error for SCME UMA TDL model based on [6] and the reference method.

The maximum correlation error  $|\rho - \hat{\rho}|$  for each cluster in SCME UMA TDL model based on power weights from the reference method and the proposed algorithm is shown in Table I. The proposed algorithm generally present better correlation error.

TABLE I  
MAXIMUM CORRELATION ERROR  $|\rho - \hat{\rho}|$  FOR SCME UMA TDL MODEL

Cluster index	1	2	3	4	5	6	SCME
Reference method	0.12	0.08	0.04	0.10	0.05	0.14	0.06
Proposed algorithm	0.06	0.04	0.02	0.05	0.03	0.06	0.03

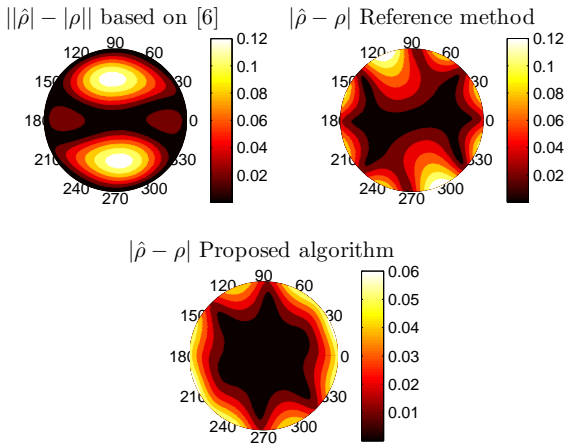

Fig. 9. Correlation error for the 6th cluster of the SCME UMA TDL model for the three algorithms.

Another advantage coming from the proposed algorithm is that the error tolerance for the emulated PAS in terms of mean AoA and AS can be predefined in the optimization. Comparison results for the 1st cluster is shown in Table II. As we can see, compared with the algorithm implemented in the channel emulator, better correlation results in terms of mean AoA and AS can be obtained with the proposed optimization algorithm. The emulated PAS matches quite well with the target PAS in terms of AoA and AS.

TABLE II  
COMPARISON RESULTS FOR CLUSTER ONE (TARGET AS = 35 AND AoA = 65.7489)

Cluster 1	AS (degree)	AoA (degree)
Reference method	36.4	64.1
Results from [6]	52.7	71.5
Proposed algorithm	35.0	66.0

### C. Impact of channel model on correlation error

It is known that correlation error is dependent on the target channel. As shown in Figure 7, a uniform PAS generally gives better correlation error compared to the other PASs. Even for clusters with same PASs distribution but various ASs and AoAs, the correlation error is expected to be different. As shown in Table I, the correlation error for the 6 clusters with the same Laplacian PAS shape but diverse AoAs is different.

Emulation accuracy for a single Laplacian shaped cluster with different ASs will also be different. One critical scenario is that the convex optimization problem might be unsolvable when AS is too small for an arbitrary AoA since the optimization constraints on  $\epsilon_{AoA}$  and  $\epsilon_{AS}$  will never be satisfied. As discussed in [4], prefaded signal synthesis technique does not support for creating the LOS paths between OTA antennas.

### D. Required number of probes

One important issue that needs to be addressed in anechoic chamber based multi-probe systems is the relationship between

number of required probes and test area size. A comparison of the results for the required number of probes as a function of test area size obtained by different methods is given in [14]. It is not practical to have a large number of probe antennas since the output ports of the channel emulator are limited. Furthermore, due to possible additional reflections introduced by the multiple probes, the characteristics of the anechoic chamber can be degraded. Figure 10 illustrates the test area size as a function of the number of OTA probes for a truncated Laplacian cluster with AS = 35°. Here the emulation accuracy threshold  $|\rho - \hat{\rho}| < 0.1$  is defined to determine the size of the test area. For a given emulation accuracy level, as explained in Section III-C, the test area size will depend on the channel models. Simulation results show that if the cluster is arriving to the test area from the direction where one of the OTA antennas are located the test area performance is better than from other directions. The worst case is the cluster impinging from an angle exactly in the middle of two adjacent OTA probes. The test area size for the best scenario will be larger than that for the worst scenario. One criterion we should follow is that inside the test area, emulation accuracy should be sufficiently good even for the worst channel case. A similar trend can be observed when compared with the results reported in [14]. However, it is difficult to directly compare the results, as the acceptable error levels and methods are different. Note that the probes are assumed uniformly distributed on a circle and the error tolerance is 1 degree on AoA and AS of the cluster in the simulation.

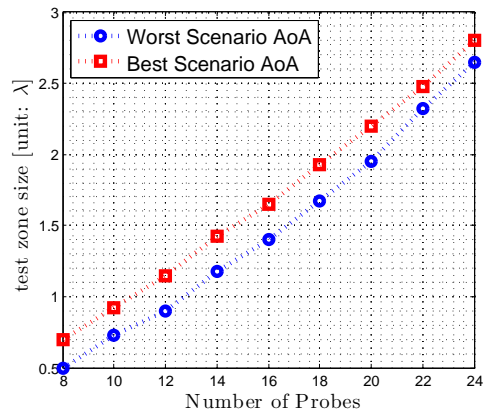

Fig. 10. The test area size as a function of number of OTA probes for a target truncated Laplacian cluster with AS = 35°.

## IV. MEASUREMENT VERIFICATION

In this section, the proposed optimization algorithm is compared with the reference algorithm implemented in the EB channel emulator in a practical MIMO OTA setup. First, the measurement system is briefly presented. After that, the settings and specifications of each of the component in the system are shown. The measurement procedure and results are given in the end.

### A. Measurement setup

The measurement system is illustrated in Figure 1. Figure

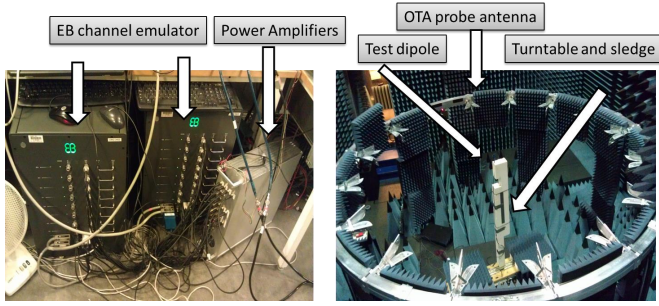

Fig. 11. EB channel emulator used in the measurement (left) and anechoic chamber setup in the measurement system (right).

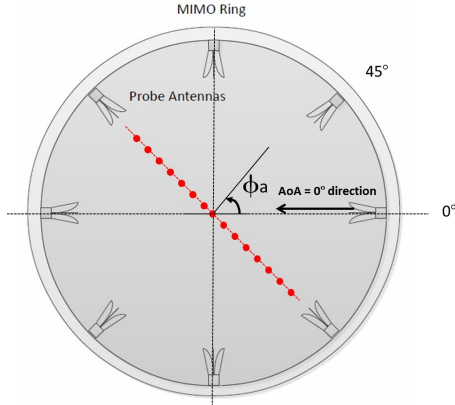

Fig. 12. Test antenna positions.

11 shows the practical measurement system. 16 dual polarized horn antennas are equally spaced and fixed on a metallic OTA ring. The OTA ring is covered by absorbers to avoid reflections during the test. Two EB channel emulators are connected through power amplifiers to feed the probes. The measurement setup is summarized in Table III. Although the presented algorithm presents better accuracy for a test area size of  $0.5\lambda$  with 8 probes, both the proposed technique and the technique implemented in the channel emulator present good emulation accuracy. To better demonstrate the accuracy improvement in the measurement, a test area of  $0.8\lambda$  is selected. Note that the emulation accuracy threshold  $|\rho - \hat{\rho}|$  for a test area of  $0.8\lambda$  could be larger than 0.1.

### B. Measurement procedure

Phase and amplitude calibrations are performed for each probe before the measurements. The goal of the calibration is to compensate errors caused by the non-idealities of the measurement setup, i.e. probe placement and orientation error, etc. The target is that equal field response at the center is obtained for all the probes. The measurement procedure is detailed in [16]. As a summary, the channel emulator is stopped every 10 CIRs and the field is measured with the network analyzer and saved for post-processing. The test antenna is then moved to next antenna position, and the sweep of the same 1000 CIR values is repeated for this new position. This procedure is repeated 15 times until all the test antenna positions are covered for the specified antenna orientation  $\phi_a$ .

TABLE III  
SETUP AND SPECIFICATIONS OF EACH COMPONENT IN THE OTA SYSTEM

Component	Setup and specifications
Network Analyzer	Center frequency at 2450MHz with a span of 10MHz
EB emulator	A radio channel (implementation method detailed in [4]) with following parameters set: <ul style="list-style-type: none"> <li>Carrier frequency: 2450MHz</li> <li>Mobile speed: 30km/h</li> <li>Direction of travel: <math>0^\circ</math></li> <li>Cluster PAS shape: one Laplacian PAS with mean AoA <math>22.5^\circ</math> and AS <math>35^\circ</math></li> <li>4 samples per wavelength is selected to sample the channel and 10000 channel impulse responses (CIRs) are stored.</li> <li>The CIRs are mapped to the OTA probes with the proposed optimization algorithm or the algorithm implemented in the EB channel emulator.</li> <li>Test area size is selected to be <math>0.8\lambda</math>.</li> </ul>
Test antenna	Satimo electric sleeve dipole at 2450MHz.
Turntable	<ul style="list-style-type: none"> <li>The sledge and turntable support radial and rotational movement of the test antenna with respect to the ring center.</li> <li>As shown in Figure 12, 15 test antenna positions sample a segment of line of length 15cm (around <math>1.15\lambda</math>) with sampling interval of 1cm are selected for each antenna orientation <math>\phi_a</math>.</li> </ul>
Power Amplifiers	16 power amplifiers were used to improve the dynamic range.
OTA probes	<ul style="list-style-type: none"> <li>Horn antennas are designed by Aalborg University [15].</li> <li>Only 8 uniformly equally spaced with <math>45^\circ</math> angular separation on an OTA ring with radius 2m.</li> <li>Only vertical polarization is considered</li> </ul>

The measured spatial correlation between antenna test position  $m$  and  $n$  is calculated according to definition:

$$\rho_{meas}(m, n) = \frac{\sum_i (s_m(i) - \bar{s}_m)(s_n(i) - \bar{s}_n)}{\sqrt{\sum_i (s_m(i) - \bar{s}_m)^2 \cdot \sum_i (s_n(i) - \bar{s}_n)^2}} \quad (7)$$

where  $s_m(i)$  and  $s_n(i)$  are the complex signals received at antenna test position  $m$  and  $n$  at the  $i$ th CIR value, respectively, and  $i = 1, \dots, 1000$ .  $\bar{s}_m$  and  $\bar{s}_n$  are the mean received signal over time at test position  $m$  and  $n$ , respectively.

### C. Measurement results

The CIRs measured at each antenna position generally follow a Rayleigh distribution. The measured spatial correlation for antenna orientation  $\phi_a = 30^\circ$ ,  $60^\circ$ , and  $150^\circ$  are shown in Figure 13, Figure 14 and Figure 15, respectively. In (1), (2) and (3), the waves impinging the test area are assumed plane for the spatial correlation calculation. The impact of physical



limitation of the OTA ring on errors caused by a difference between the plane and spherical waves is considered negligible in this paper, according to the results in [17]. This is also supported by the fact that the measured spatial correlations generally match very well with the emulation results.

The deviations between emulated and target spatial correlation are due to the limited number of OTA probes we used for a test area size of  $0.8\lambda$ . The proposed algorithm and the reference algorithm present similar performance at  $\phi_a = 150^\circ$ . However, at  $\phi_a = 30^\circ$  and  $\phi_a = 60^\circ$ , the proposed algorithm shows better emulation accuracy. As found previously, the emulation error increases as the test size gets larger in the proposed algorithm, which is not always the case in the reference algorithm.

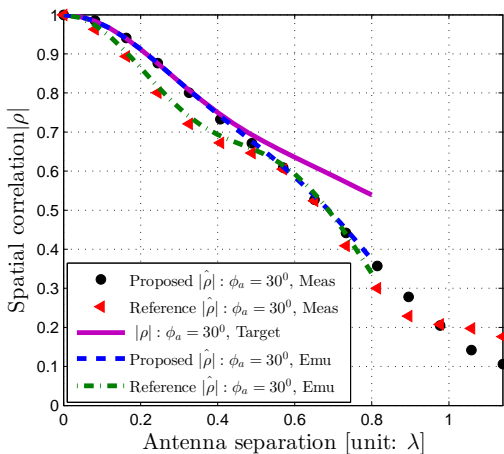

Fig. 13. Comparison between target, emulated and measured spatial correlation for antenna orientation  $\phi_a = 30^\circ$ .

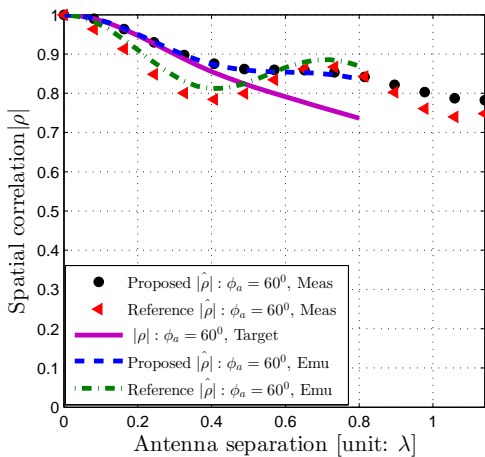

Fig. 14. Comparison between target, emulated and measured spatial correlation for antenna orientation  $\phi_a = 60^\circ$ .

## V. CONCLUSIONS

We have introduced an improved algorithm to determine probe power weights for a MIMO OTA setup utilizing the prefaded synthesis method. Spatial correlation is selected as the emulation target and we further introduce constraints

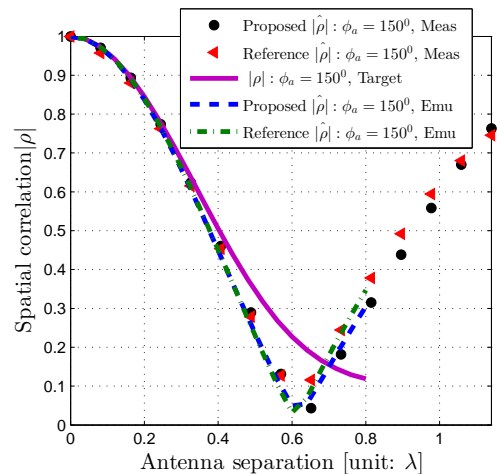

Fig. 15. Comparison between target, emulated and measured spatial correlation for antenna orientation  $\phi_a = 150^\circ$ .

on PAS shape in terms of AS and AoA. The problem is expressed as a convex optimization problem, which can be solved efficiently. Simulation results show that with 8 OTA probes and a test area size of  $0.5\lambda$ , the emulation error is 0.03 for the SCME UMA TDL model with the proposed algorithm with error tolerance of 1 degree on AoA and AS of each cluster, compared with emulation error 0.07 and no constraint on PAS shape found in the literature. The proposed algorithm is compared with the algorithm implemented in a commercial channel emulator in a practical MIMO OTA setup, measurement results are consistent with the simulation results and better emulation accuracy of the proposed algorithm is demonstrated in practice.

## REFERENCES

- [1] M. Rumney, R. Pirkl, M. H. Landmann, and D. A. Sanchez-Hernandez, "MIMO over-the-air research, development, and testing," *International Journal of Antennas and Propagation*, vol. 2012, 2012.
- [2] M. A. Mow, B. Niu, R. W. Schlub, and R. Caballero, "Tools for design and analysis of over-the-air test systems with channel model emulation capabilities," Patent US 20 110 270 567, Nov. 3, 2011.
- [3] P. Kyösti and J. Nuutinen, "Over the air test," Patent US 20 110 189 962, Aug. 4, 2011.
- [4] P. Kyösti, T. Jämsä, and J. Nuutinen, "Channel modelling for multiprobe over-the-air MIMO testing," *International Journal of Antennas and Propagation*, 2012.
- [5] J. D. Reed, "Emulation and controlled testing of mimo ota channels," Patent US 20 110 299 570, Dec. 8, 2011.
- [6] D. Reed, "Experiments with spatial correlation for evaluating ota techniques," no. TD (09)856. COST2100, May 2009, pp. 1–4. [Online]. Available: <http://www.COST2100.org/>.
- [7] S. Boyd and L. Vandenberghe, *Convex Optimization*. Cambridge University Press, 2004.
- [8] L. Hentilä, P. Kyösti, M. Käske, M. Narandzic, and M. Alatossava, "Matlab implementation of the winner phase ii channel model ver1.1," *Online*: [https://www.ist-winner.org/phase\\_2\\_model.html](https://www.ist-winner.org/phase_2_model.html), 2007.
- [9] D. Baum, J. Hansen, and J. Salo, "An interim channel model for beyond-3G systems: extending the 3GPP spatial channel model (SCM)," in  *Vehicular Technology Conference, 2005. VTC 2005-Spring. 2005 IEEE 61st*, vol. 5, 2005, pp. 3132–3136 Vol. 5.
- [10] J. Guillet, "Measurement-based statistical model and simulation of mobile station anisotropic power angular spectrum," *Electronics Letters*, vol. 42, no. 12, pp. 671–673, 2006.
- [11] R. Vaughan, J. Bach-Anderson, and J. B. Andersen, "Channels, propagation and antennas for mobile communications." Institution of Electrical Engineers, 2003.

- [12] "Spatial channel model for Multiple Input Multiple Output (MIMO) simulations (Release 11)," 3GPP/3GPP2, TR 25.996 V11.0.0, Sep. 2012.
- [13] Fan, Wei and Carreño, Xavier and Nielsen, Jesper O and Knudsen, Mikael B and Pedersen, Gert F, "Verification of Emulated Channels in Multi-Probe Based MIMO OTA Testing Setup," in *Antennas and Propagation (EUCAP), Proceedings of the 7th European Conference on*. IEEE, 2013.
- [14] A. Khatun, T. Laitinen, V.-M. Kolmonen, and P. Vainikainen, "Dependence of error level on the number of probes in over-the-air multiprobe test systems," *International Journal of Antennas and Propagation*, vol. 2012, 2012.
- [15] O. Franek and G. F. Pedersen, "Spherical horn array for wideband propagation measurements," *Antennas and Propagation, IEEE Transactions on*, vol. 59, no. 7, pp. 2654–2660, 2011.
- [16] "Verification of radiated multi-antenna reception performance of User Equipment," 3GPP, TR 37.977 V0.2.0, May. 2012.
- [17] P. Kyosti and L. Hentila, "Criteria for physical dimensions of mimo ota multi-probe test setup," in *Antennas and Propagation (EUCAP), 2012 6th European Conference on*. IEEE, 2012, pp. 2055–2059.



**Wei Fan** received his Bachelor of Engineering degree in electrical engineering from Harbin Institute of technology, China, in 2009 and Master's double-degree with highest honors from Politecnico di Torino, Italy, and Grenoble Institute of Technology, France, in electronic engineering in 2011. From February 2011 to August 2011, he was with Intel Mobile Communications, Denmark. He is currently a Ph.D. candidate at Department of Electronic Systems at Aalborg University, Denmark. His main areas of research are over the air testing of MIMO

terminals and radio channel modeling.



**Xavier Carreo Bautista de Lisbona** received his Master's degree from Escola Tcnica Superior de Enginyeria de Telecomunicacions de Barcelona UPC in 2011. At UPC he was deeply involved in baseband signal processing algorithms and MIMO OTA research topics within Intel Mobile Communications, where he currently has a leading role in the MIMO OTA development team as system engineer. He is involved in the standardization of MIMO OTA methods and has coauthored several 3GPP, CTIA and IC1004 contributions and several conference and

journal papers on the subject. His primary interests are within the area of MIMO OTA testing techniques, MIMO channel modeling and LTE platform testing.



**Fan Sun** received the B.Eng. degree in telecommunication engineering with highest honors from Beijing University of Aeronautics and Astronautics (now renamed as Beihang University), China, in 2007, and the M.S. degree in wireless systems from Royal Institute of Technology (KTH), Sweden, in 2009, respectively. From November 2008 to September 2009, he was with Ericsson Research, Sweden. From September 2009 to September 2010, he was with Nokia Siemens Network Research, Denmark. He is now pursuing his Ph.D. degree in wireless

communications at Aalborg University, Denmark. His research interests include multiple antenna techniques, cooperative communication, cross-layer design, and signal processing for communication systems.



**Jesper Odum Nielsen** received his master's degree in electronics engineering in 1994 and a PhD degree in 1997, both from Aalborg University, Denmark. He is currently employed at Department of Electronic Systems at Aalborg University where main areas of interests are experimental investigation of the mobile radio channel and the influence mobile device users have on the channel. He has been involved in MIMO channel sounding and modeling, as well as measurements using live GSM and LTE networks. In addition he has been working with

radio performance evaluation, including over the air testing of active wireless devices.



**Mikael Bergholz Knudsen** (S99M01) was born in 1964. He received the B.S. degree in electrical engineering from Aarhus Teknikum, Denmark, in 1989, and the M.S. and Ph.D. degrees from Aalborg University, Denmark, in 1992 and 2001, respectively. In 1993, he joined Maxon Telecom A/S, Aalborg, Denmark, where he designed RF circuitry for both analog and digital mobile phones. From 1998 to 2001, he worked as an industrial Ph.D. student for Siemens Mobile Phones A/S, Denmark, while he at the same time studied at Aalborg University, CPK.

He is now with Intel Mobile Communications Denmark, where he is the project manager for the 4th Generation Mobile Communication and Test platform (4GMCT) and also the chairman of the steering committee for the Smart Antenna Front End (SAFE) projects; both sponsored by the Danish National Advanced Technology Foundation. His areas of interest include RF system design and handset antenna performance including more than one antenna. In the recent years one of his focus areas has been how to utilize the unique possibilities in the cooperation between university researchers and private companies. To support this effort he pursued and obtained an Executive-MBA in 2012 with focus on inter-organizational research strategies.



**Gert Frølund Pedersen** was born in 1965 and married to Henriette and have 7 children. He received the B.Sc. E. E. degree, with honour, in electrical engineering from College of Technology in Dublin, Ireland in 1991, and the M.Sc. E. E. degree and Ph. D. from Aalborg University in 1993 and 2003. He has been with Aalborg University since 1993 where he is a full Professor heading the Antenna, Propagation and Networking LAB with 36 researcher. Further he is also the head of the doctoral school on wireless communication with some 100 phd students

enrolled. His research has focused on radio communication for mobile terminals especially small Antennas, Diversity systems, Propagation and Biological effects and he has published more than 175 peer reviewed papers and holds 28 patents. He has also worked as consultant for developments of more than 100 antennas for mobile terminals including the first internal antenna for mobile phones in 1994 with lowest SAR, first internal triple-band antenna in 1998 with low SAR and high TRP and TIS, and lately various multi antenna systems rated as the most efficient on the market. He has worked most of the time with joint university and industry projects and have received more than 12 M\$ in direct research funding. Latest he is the project leader of the SAFE project with a total budget of 8 M\$ investigating tunable front end including tunable antennas for the future multiband mobile phones. He has been one of the pioneers in establishing Over-The-Air (OTA) measurement systems. The measurement technique is now well established for mobile terminals with single antennas and he was chairing the various COST groups (swg2.2 of COST 259, 273, 2100 and now ICT1004) with liaison to 3GPP for over-the-air test of MIMO terminals. Presently he is deeply involved in MIMO OTA measurement.