



Aalborg Universitet

AALBORG UNIVERSITY
DENMARK

A supervisory control approach in economic MPC design for refrigeration systems

Shafiei, Seyed Ehsan; Stoustrup, Jakob; Rasmussen, Henrik

Published in:
Proceedings of the European Control Conference

Publication date:
2013

Document Version
Early version, also known as pre-print

[Link to publication from Aalborg University](#)

Citation for published version (APA):
Shafiei, S. E., Stoustrup, J., & Rasmussen, H. (2013). A supervisory control approach in economic MPC design for refrigeration systems. In *Proceedings of the European Control Conference* (pp. 1565-1570). IEEE Press.
<http://ieeexplore.ieee.org/xpl/articleDetails.jsp?tp=&arnumber=6669413&queryText%3DA+supervisory+control+approach+in+economic+MPC+design+for+refrigeration+systems>

General rights

Copyright and moral rights for the publications made accessible in the public portal are retained by the authors and/or other copyright owners and it is a condition of accessing publications that users recognise and abide by the legal requirements associated with these rights.

- ? Users may download and print one copy of any publication from the public portal for the purpose of private study or research.
- ? You may not further distribute the material or use it for any profit-making activity or commercial gain
- ? You may freely distribute the URL identifying the publication in the public portal ?

Take down policy

If you believe that this document breaches copyright please contact us at vbn@aub.aau.dk providing details, and we will remove access to the work immediately and investigate your claim.

A supervisory control approach in economic MPC design for refrigeration systems*

Seyed Ehsan Shafiei, Jakob Stoustrup and Henrik Rasmussen

Abstract—A model predictive control at supervisory level is proposed for refrigeration systems including distributed local controllers. Prediction of the electricity price and outdoor temperature are assumed available. The control objective is to minimize the overall energy cost within the prediction horizon. The method is mainly developed for demand-side management in the future smart grid, but a simpler version can be applied in the current electricity market. Due to the system nonlinearity, the minimization is in general a complicated nonconvex optimization problem. A new supervisory control structure as well as an algorithmic pressure control scheme is presented to rearrange the problem to facilitate convex programming. A nonlinear continuous time model validated by real data is employed to simulate the system operation. The results show a considerable economic saving as well as a trade-off between the saving level and the design complexity.

I. INTRODUCTION

The structure of power systems, especially in Europe, is changing from a centralized one to a decentralized one due to distributed generation with high penetration of renewable sources. This change leads to several new challenges that can be handled in a smart grid, where both production and consumption of electricity are managed efficiently. To achieve such efficient demand-side management, consumers should be equipped with control systems that can actively respond to grid requirements.

Supermarket refrigeration systems are one of the consumers that have significant potential to take part in demand-side management by shifting their energy consumption. The large potential for demand-side management can be illustrated by Denmark alone with 5 mio. inhabitants having approx. 4.500 supermarkets, using annually approx. 540.000 MWh for refrigeration. This can be achieved by storing energy as coldness in foodstuffs. The authors believe that this storage capability can be utilized effectively by developing appropriate control methods. However, existing nonlinearities and constraints in refrigeration systems challenges the control design.

One of the best control schemes that can take into account the required predictions and can handle such a multivariable system as well as respecting the state and input constraints is model predictive control (MPC), [1]. Various MPC formulations have successfully been applied for different improvements in refrigeration systems. With hybrid system formulation, MPC was employed in [2], [3] and [4] to solve

the synchronization problem in display cases that causes wearing of the compressors. Fallahsohi, *et al* in [5] applied predictive functional control to minimize the superheat in an evaporator. For multi-evaporator systems, a decentralized MPC was proposed to control the cooling capacity of each evaporator [6]. A nonlinear predictive control scheme was designed in [7] to reduce the total power consumption of the compressor in a vapor compression cycle.

An optimal demand-side management can be realized in a real-time electricity pricing market by taking price predictions into account [8]. Optimizing economic objectives in MPC formulation for process systems was presented in [9]. A thorough study has been performed by Hovgaard, *et al*, [10], where an economic MPC was designed to reduce operating costs of refrigeration systems by utilizing the thermal storage capabilities. Predictions of the electricity price and the outdoor temperature were considered and a nonlinear optimization tool was used to handle the nonconvex cost function. They also showed that their proposed method can successfully contribute with ancillary services to balance power markets in the smart grid.

In this paper, we propose a new supervisory control structure for commercial refrigeration systems. In order to minimize the energy consumption, the optimizing value for cooling capacity of each unit as well as the optimal set-point for suction pressure (common evaporation temperature) should be calculated. This will however lead to solve a nonlinear and nonconvex optimization problem. To avoid this nonconvexity, we propose a simple heuristic algorithm to regulate the suction pressure in the local control level. The energy consumption is reduced significantly as a result of this algorithmic pressure control. Finally, a model predictive control in the supervisory level is proposed that can further reduce the total energy costs using predictions of the price and the outdoor temperature. The supervisory MPC controls the cooling capacity of each unit by providing an optimal temperature set-point for each distributed PI controller.

II. REFRIGERATION SYSTEM

A basic layout of a typical refrigeration system including several fridge and freezer display cases with two compressor banks in a booster configuration is shown in Fig. 1. Starting from the receiver (REC), two-phase refrigerant (mix of liquid and vapor) at point '8' is split out into saturated liquid ('1') and saturated gas ('1b'). The latter is bypassed by a bypass valve (BPV), and the former flows into expansion valves where the refrigerant pressure drops to medium ('2') and low ('2'') pressures. The expansion valves EV_MT and

*This work is supported by the Southern Denmark Growth Forum and the European Regional Development Fund under the Project Smart & Cool.

Authors are with Section for Automation and Control, Department of Electronic Systems, Aalborg University, Aalborg, Denmark {ses, jakob, hr} at es.aau.dk

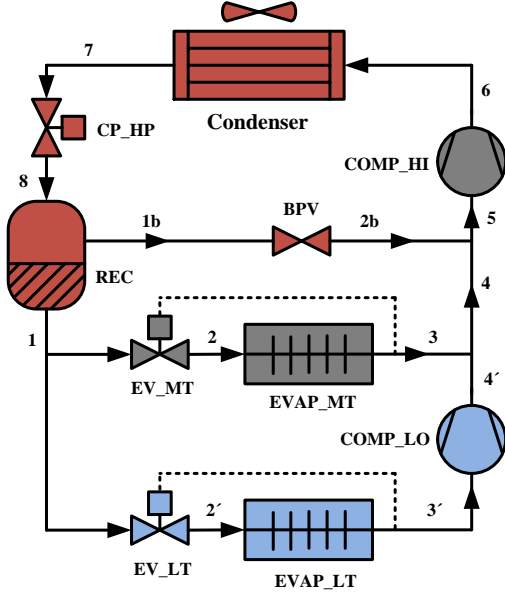

Fig. 1. Basic layout of a typical supermarket refrigeration system with booster configuration.

EV_LT are driven by thermostatic ON/OFF controllers to regulate the air temperature inside the fridge and freezer display cases, respectively. Flowing through medium and low temperature evaporators (EVAP_MT and EVAP_LT), the refrigerant absorbs heat from the cold reservoir. The pressure of low temperature units (LT) is increased by the low stage compressor rack (COMP_LO). All mass flows from COMP_LO, EVAP_MT and BPV outlets are collected by a suction manifold at point '5' where the pressure is increased again by high stage compressors (COMP_HI). Afterward, the gas phase refrigerant enters the condenser to deliver the absorbed heat from cold reservoirs to the surroundings. The detailed thermodynamic analysis of such systems is described in [11].

A. Dynamical Model

In the cold reservoirs (display cases and cold rooms), heat is transferred from the foodstuffs to the cooled air, $\dot{Q}_{foods/cr}$, and then from the cooled air to the circulated refrigerant, \dot{Q}_e , which the latter is also known as cooling capacity. There is however heat load from supermarket indoor, \dot{Q}_{load} , formulated as a variable disturbance. Here, we consider the measured air temperature at the evaporator outlet as the cold reservoir temperature, T_{cr} . Assuming a lumped temperature model, the following dynamical equations are derived based on energy balances for the mentioned heat transfers.

$$MCp_{foods} \frac{dT_{foods}}{dt} = -\dot{Q}_{foods/cr} \quad (1)$$

$$MCp_{cr} \frac{dT_{cr}}{dt} = \dot{Q}_{load} + \dot{Q}_{foods/cr} - \dot{Q}_e \quad (2)$$

where MCp denotes the corresponding mass multiplied by the heat capacity. The energy flows are

$$\dot{Q}_{foods/cr} = UA_{foods/cr}(T_{foods} - T_{cr}), \quad (3)$$

$$\dot{Q}_{load} = UA_{load}(T_{indoor} - T_{cr}), \quad (4)$$

and

$$\dot{Q}_e = \dot{m}_r \Delta h_{lg}, \quad (5)$$

where UA is the overall heat transfer coefficient, Δh_{lg} is the specific latent heat of the refrigerant in the evaporator, which is a nonlinear functions of the evaporation temperature (or equivalently the suction pressure), and T_{indoor} is the supermarket indoor temperature. The term \dot{m}_r denotes the mass flow of refrigerant into the evaporator which is determined by the opening degree of the expansion valve and described by the following equation:

$$\dot{m}_r = OD K v A \sqrt{2\rho_{suc}(P_{rec} - P_{suc})10^5} \quad (6)$$

in which OD stands for the opening degree of the valve with a value ranging from 0 (closed) to 1 (fully opened), P_{rec} and P_{suc} are the receiver and the suction pressures in [bar], ρ_{suc} is density of the circulating refrigerant, and KvA denotes a constant characterizing the valve [12].

B. Compressor Power and System COP

The electrical power consumption of each compressor bank is calculated by

$$\dot{W}_c = \frac{1}{\eta_{me}} \dot{m}_{ref}(h_{o,c} - h_{i,c}), \quad (7)$$

where \dot{m}_{ref} is the total mass flows into the compressors, and $h_{o,c}$ and $h_{i,c}$ are the enthalpies at the outlet and inlet of the compressor bank and are nonlinear functions of the refrigerant pressure and temperature at the calculation points. The constant η_{me} indicates overall mechanical/electrical efficiency considering mechanical friction losses and electrical motor inefficiencies [13]. The outlet enthalpy is computed by

$$h_{o,c} = h_{i,c} + \frac{1}{\eta_{is}}(h_{is} - h_{i,c}), \quad (8)$$

in which h_{is} is the outlet enthalpy when the compression process is isentropic, and η_{is} is the related isentropic efficiency given by [14] (neglecting higher order terms).

$$\eta_{is} = c_0 + c_1(f_c/100) + c_2(P_{c,o}/P_{suc}) \quad (9)$$

Where f_c is the virtual compressor frequency (total capacity) of the compressor rack in percentage, $P_{c,o}$ is pressure at the compressor outlet, and c_i are constant coefficients.

The total coefficient of performance (COP) is defined as ratio of the total cooling capacity over the total power consumption of the compressors.

$$COP = \frac{\dot{Q}_{e,tot}}{\dot{W}_{c,tot}} \quad (10)$$

The COP is calculated by

$$COP = \frac{x_{MT} \Delta h_{lg,MT} + x_{LT} \Delta h_{lg,LT}}{\frac{1}{\eta_{MT}}(h_{oc,MT} - h_{ic,MT}) + \frac{x_{LT}}{\eta_{LT}}(h_{oc,LT} - h_{ic,LT})}, \quad (11)$$

where indices MT and LT relate the calculated values to the medium and low temperature sections, respectively. Parameters x_{MT} and x_{LT} are ratio of the refrigerant mass flow of MT and LT evaporators to the total flow rate, and $\eta_{MT} = \eta_{me,MT} \eta_{is,MT}$ and $\eta_{LT} = \eta_{me,LT} \eta_{is,LT}$.

III. SUPERVISORY CONTROL

Fig. 2 shows the control system structure including local inner loop control and supervisory outer loop one. The local controllers are responsible for regulating the pressures and the temperatures to the required set-points, and the supervisory control, here, has to sent the temperature set-points to the cold reservoirs such that the total energy cost is minimized.

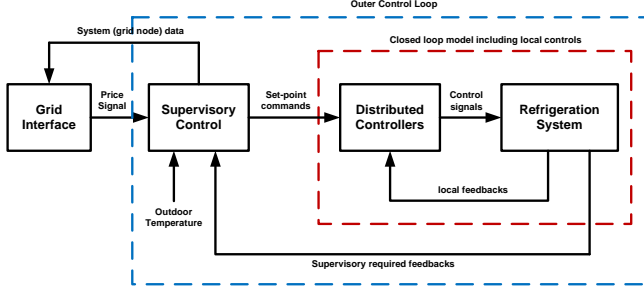

Fig. 2. A supervisory control structure for refrigeration systems.

A. Distributed/local Controllers

In the most available set-ups of refrigeration systems, air temperature inside a display case is governed by a thermostatic expansion valve between an upper and a lower temperature limit. The new technologies of the expansion valves allows the pulse with modulation techniques in the control signals. Consequently, air temperature inside the displace cases can be regulated by local PI controllers instead of the thermostatic ON/OFF operations.

The compressors are responsible for regulating the suction pressure to a usually fixed set-point. Due to the different timescales between the dynamics of the compressors and the display case, a static model for the compressors are considered [15].

We propose the following algorithm that keeps the suction pressure as high as possible while ensuring the system functionality in presence of varying loads. A sampling time equal to one minute ensures that the compressor speed is regulated to its steady-state value. Moreover, an upper limit $P_{suc,max}$ is put to keep a safety margin for pressure difference required for circulating the refrigerant. The lower limit $P_{suc,min}$ is due to the limitations of compressor total capacities, and also the safety issues regarding the high pressure difference.

Algorithm 1 Calculate set-point value for the suction pressure

```

if  $P_{suc} < P_{suc,max}$  and  $\max(OD_i) < \delta_{max}$  then
  Increase the pressure set-point
else if  $P_{suc} > P_{suc,min}$  and  $\max(OD_i) > \delta_{min}$  then
  Decrease the pressure set-point
else
  Keep the previous set-point
  
```

The above algorithm is based on an optimality hypothesis, where the pressure should be increased until one of the

expansion valves is kept almost fully open. It increases and decreases the pressure set-point with a constant ramp and within the pressure limits.

Now, we have a system with higher energy efficiency. Still, there exists a potential to further reduce the energy cost by shifting the power consumption using a predictive control algorithm.

B. Economic MPC

The control objective of economic MPC is to minimize the operating cost while respecting the operation and imposed constraints. The economic objective function is simply formulated by the instantaneous energy cost as multiplication of the real-time electricity price $e_p(t)$ by the power consumption at given time t . So, the energy cost, J_{ec} is computed over the specified time interval $[T_0 \ T_N]$ as

$$J_{ec} = \int_{T_0}^{T_N} e_p \dot{W}_{c,tot} dt. \quad (12)$$

1) *Linear Model and Constraints:* Considering \dot{Q}_e in (2) as an input manipulated variable, we will have a linear system with the standard form. But we cannot directly apply \dot{Q}_e as an input signal to the system. Considering (5) and (6), \dot{Q}_e is a function of OD , P_{rec} , and P_{suc} . P_{rec} is regulated to a fixed set-point and is taken constant. At each time step we can measure P_{suc} and assumed it constant all over the horizon. Bearing in mind that Algorithm 1 tries to keep the pressure at its maximum possible level, it would not be a highly restrictive assumption for our predictive model. So at time step k we will have

$$\dot{Q}_e = \beta_k OD \quad (13)$$

where

$$\beta_k = \Delta h_{lg} K v A \sqrt{2 \rho_{suc} (P_{rec} - P_{suc})} 10^5 \quad (14)$$

is assumed constant for the next N samples of prediction (*i.e.* $\beta_{k|k} = \beta_{k|k+i}$ for $i = 1 \dots N$).

Now the following linear model is derived for each cooling unit.

$$\begin{cases} \dot{x}_p = A_p x_p + B_{1,p} u + B_{2,p} d \\ y_p = C_p x_p \end{cases} \quad (15)$$

with the states $x_p = [T_{foods} \ T_{cr}]^T$, the input $u = OD$, and the disturbance $d = T_{indoor}$. The parameters are

$$A_p = \begin{bmatrix} -\frac{UA_{foods/cr}}{MC P_{foods}} & \frac{UA_{foods/cr}}{MC P_{foods}} \\ \frac{UA_{foods/cr}}{MC P_{cr}} & -\frac{UA_{foods/cr} + UA_{load}}{MC P_{cr}} \end{bmatrix}, \quad (16)$$

$$B_{1,p} = \beta_k \begin{bmatrix} 0 \\ -1 \\ \frac{1}{MC P_{cr}} \end{bmatrix}, \quad B_{2,p} = \begin{bmatrix} 0 \\ \frac{UA_{load}}{MC P_{cr}} \end{bmatrix}, \quad (17)$$

and

$$C = [1 \ 1]. \quad (18)$$

The output $y_{p1} = x_{p1}$ is the measured variable and subjected to constraint, and $y_{p2} = x_{p2}$ is the output to be controlled.

System (15) is subjected to the constraints

$$T_{foods,min} \leq y_{p1} \leq T_{foods,max}, \quad (19)$$

and

$$0 \leq u \leq 1, \quad (20)$$

where $T_{foods,min}$ and $T_{foods,max}$ are defined based on the types of foods are placed in the display cases.

2) *MPC Formulation*: We use a discrete-time receding horizon approach, in which at each time step, an optimization problem is solved over a prediction N step horizon. The result consists of the N moves of manipulated variables where the first one is applied as the MPC control law. So, for the MPC formulation we should discretize the plant model (15) with sampling time T_s which results in

$$\begin{cases} x_p[k+1] = A_d x_p[k] + B_{d,1} u[k] + B_{d,2} d[k] \\ y_p[k] = C_d x_p[k] \end{cases} \quad (21)$$

with the discrete-time system matrices A_d , $B_{d,1}$, $B_{d,2}$ and C_d . To keep the optimization problem feasible in case of uncertain loads, the state constraint (19) is changed to the set of soft constraints

$$T_{foods,min} - \varepsilon \Delta T_{foods} \leq y_{p1} \leq T_{foods,max} + \varepsilon \Delta T_{foods} \quad \varepsilon \geq 0 \quad (22)$$

where the violations from temperature limits are penalized by adding the term $\rho_\varepsilon \varepsilon$ to the objective function. ΔT_{foods} and ρ_ε should be defined such that the violation occurrence is very rare and its amount is also negligible.

In order to implement the MPC scheme in a cascade configuration shown in Fig. 1, the predictive model should also include the local controller dynamics [16],

$$\begin{cases} x_c[k+1] = A_c x_c[k] + B_c e[k] \\ u[k] = C_c x_c[k] + D_c e[k] \end{cases} \quad (23)$$

The error signal is defined as $e[k] = r[k] - y_{p2}[k]$, where $r[k]$ is the temperature set-point. The combined predictive model for the cascade structure is derived as follow:

$$\begin{cases} X[k+1] = AX[k] + B_1 r[k] + B_2 d[k] \\ Y[k] = CX[k] + Dr[k] \end{cases} \quad (24)$$

where $X = [x_p \ x_c]^T$, and $Y = [y_p \ u]^T$. The corresponding state space matrices for this formulation can be found in [16]. Using the state-space model (24) the control signal applying to the system will be the temperature reference r .

The cost function (12) is rewritten using (10) as

$$J_{ec} = \sum_{k=0}^{N-1} \left\| e_p \frac{\dot{Q}_{e,tot}}{COP} \right\|_2^2, \quad (25)$$

where COP is given by (11), and $\dot{Q}_{e,tot} = \sum_{i=1}^m \dot{Q}_e^i$ with m indicating the number of cooling units. In the next section we will show how we can predict the COP by estimating it as a linear function depending on the outdoor temperature. Now, the optimization problem is defined as

$$\begin{aligned} & \underset{r, \varepsilon}{\text{minimize}} && J_{ec} + J_{\Delta u} + \rho_\varepsilon \varepsilon \\ & \text{subject to} && \text{system dynamics (24)} \\ & && \text{state constraints (22)} \\ & && \text{input constraints (20)} \end{aligned}, \quad (26)$$

with

$$J_{\Delta u} = \sum_{k=1}^{N-1} \|R_{\Delta u} (r[k] - r[k-1])\|_2^2. \quad (27)$$

where $R_{\Delta u}$ is a diagonal matrix of tuning weights. The above objective function penalizes the rate of change of the set-point to avoid the oscillatory behavior in control commands. The tuning parameters are defined by considering two opposing objectives: cost and stability. From the cost point of view, the units (e.g. display cases) with larger costs of storing energy should be more penalized, and from the stability point of view, the units with faster dynamics should be assigned larger values for their corresponding weights in $R_{\Delta u}$.

IV. SIMULATION RESULTS

In this section, the proposed methods are applied to a high-fidelity simulation benchmark developed based on the model explained in [15]. The model is validated against real data obtained from a supermarket including 7 MT and 4 LT fridge and freezer display cases and a cold room, and the two-stage compressor racks. A two-step simulation is provided to show the gradually improvement from a simple PI replacements together with Algorithm 1 to the complicated supervisory MPC. For each case, the simulation results for a 24-hour operation are presented.

The outdoor temperature is obtained from an hourly measurement with linear interpolation between the hours. The temperature prediction can for example be provided by the national meteorological institute, sometimes on a commercial basis. One week period of hourly el-spot price was downloaded from NordPool spot market [17]. Fig. 3 shows the $T_{outdoor}$ and e_p for 24 hours related to the next results. In the simulations, we used a normalized version of the electricity prices and compare the methods based on the percentage in reduction of the operating cost.

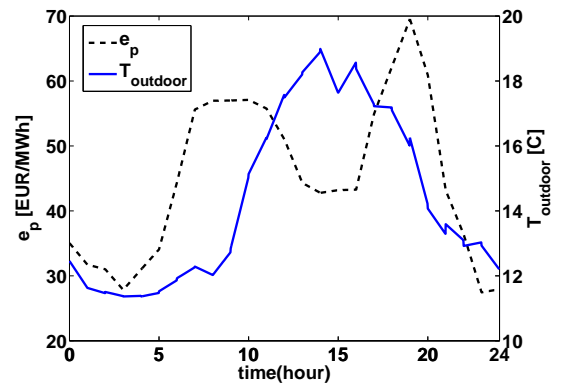

Fig. 3. Outdoor temperature and electricity price.

A. Distributed PI Temperature Control together with Algorithmic Pressure Control

At this step, the thermostatic controllers are replaced by PI ones and the Algorithm 1 is applied for the pressure set-point control. The temperature set-points for each PI is set to the middle of the range of the display case temperature the same

as the thermostatic control case. The power consumption for 24 hours with thermostatic control is shown in Fig. 4. Fluctuations in power consumption is mainly because of the mass flow change due to thermostat actions. The total energy consumption and electricity cost are $E_{tot} = 95.1$ [kWh] and $e_c = 47.6$.

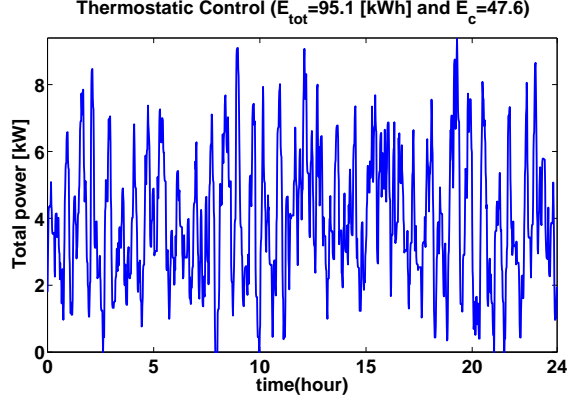

Fig. 4. Power consumption in case of the thermostatic control valves. The total energy consumption and the corresponding electricity cost are $E_{tot} = 95.1$ [kWh] and $e_c = 47.6$.

The energy consumption and the corresponding electricity cost in case of using the PI control valves as well as applying the Algorithm 1 are reduced to $E_{tot} = 76$ [kWh] (20% reduction) and $e_c = 38.4$ (19% reduction). The suction pressures of two LT and MT sections are illustrated in Fig. 5. The design parameters are $\delta_{max,MT} = 0.95$, $\delta_{min,MT} = 0.9$, $\delta_{max,LT} = 0.95$, $\delta_{min,LT} = 0.85$, $P_{max,MT} = 34$ and $P_{max,LT} = 15$. The suction pressures vary between δ_{min} and δ_{max} with a constant ramp.

Further improvement can be achieved by running the system in an energy-efficient scenario, where the temperature set-points are fixed to highest levels (only 0.5 °C below the maximum limits). The result is shown in the same plot with the MPC case in Fig. 7. Using this simple scenario E_{tot} and e_c are reduced to $E_{tot} = 67.8$ [kWh] (29% reduction) and $e_c = 34.3$ (28% reduction) which is a considerable reduction.

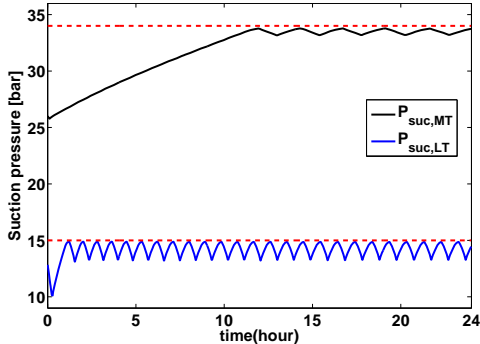

Fig. 5. Suction pressures of two LT and MT sections after applying Algorithm 1.

B. Economic MPC

Considering the slow dynamics of the display cases, and different time constant for the food temperatures ranging

from 1 hour to more than 10 hours, a 15 minute sampling period and a 24 h prediction horizon ($N = 96$) is chosen for implementation. The tuning parameters are $\rho_{\epsilon,MT} = 10^6$, $\rho_{\epsilon,LT} = 100$, and $R_{\Delta u} = 0.01I_{m \times m}$, where $m = 7$ for MT and $m = 4$ for LT units. To solve the optimization problem (26) we have used CVX, a package for specifying and solving convex programs [18], [19].

Considering (11), the COP is a nonlinear function of the both suction and the condensation pressures. So its relation cannot be placed directly in the convex programming. Since we have already assumed the pressure set-point unchanged for the prediction horizon (note that it is updated at each sample), the COP would mainly depend on the condensation pressure which is highly correlated with the outdoor temperature. So it is rational to calculate it from (11) based on the measurements and then use it as the historical data for prediction. As shown in Fig. 6 (top), the COP is linearly estimated from the outdoor temperature. Fig. 6 (bottom) shows the COP prediction for the next horizon based on the linear fit estimation obtained from the previous 24 hours of the historical data, and the prediction of the outdoor temperature for the next 24 hours. Since the pressure may change during the operation and also the outdoor temperature varies during the day, the linear fit is updated in each time step to avoid the significant bias in predictions.

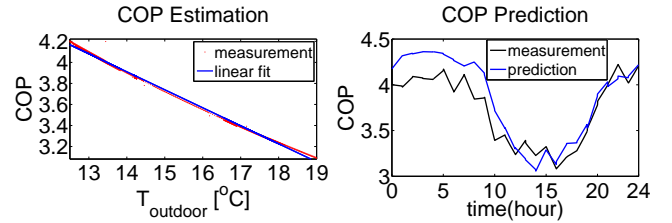

Fig. 6. COP estimation and prediction. (top): Estimation of the system COP as a linear function of the outdoor temperature. (bottom): Prediction of the system COP using the obtained linear estimation and prediction of the outdoor temperature.

The power consumption resulted from applying the economic MPC scheme in the supervisory level is depicted in Fig. 7. The food temperatures of the fridge display cases are represented in Fig. 8. The trends for the freezer units are almost similar. Using the economic MPC, the energy consumption is reduced to $E_{tot} = 64.6$ [kWh] (32% reduction) that justifies the COP prediction method. The electricity cost become $e_c = 30.3$ (36% reduction) which indicates the effectiveness of the proposed scheme. As can be seen from Fig. 3, around 3 h both e_p and $T_{outdoor}$ are low (the COP is high), so the supervisory control starts storing energy by lowering the temperatures while respecting the imposed constraints. Around 15 h, e_p is low but $T_{outdoor}$ is high (the COP is low), but the proposed control can handle this trade-off very well by storing some amount of energy in an optimal way.

V. DISCUSSIONS

From the results provided in the previous section, one can recognize a big gap between a very simple traditional

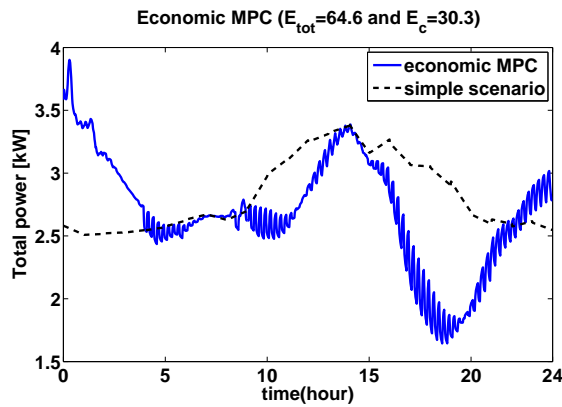

Fig. 7. Power consumption after applying economic MPC (solid) and the energy-efficient scenario (dash).

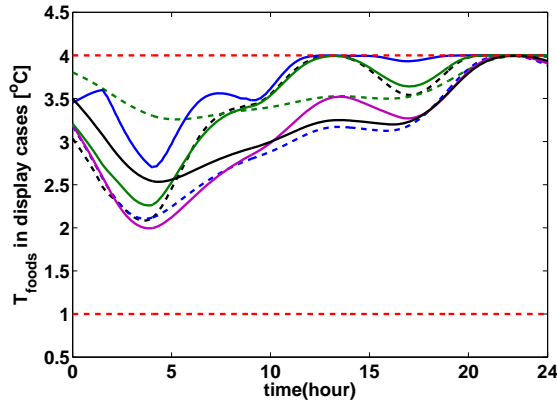

Fig. 8. Food temperatures in the fridge display cases. The temperature limits are [1, 4].

thermostatic control in a commercial refrigeration system and a complicated economic MPC regarding the operating cost (36% reduction was reported). In order to avoid jumping from a primary design to an advanced one, we explained how we can increase the efficiency of the system, regarding its energy consumption, by simple practically applicable methods. For this purpose, we proposed a predictive control in a supervisory level to minimize the cost of operation. The following steps were investigated concerning the economic saving they can offer with respect to the simple non-efficient thermostatic control.

- 1) Using PI control together with Algorithm 1, (19%)
- 2) Using the energy-efficient scenario, (28%)
- 3) Using the economic MPC scheme, (36%)

The largest saving is realized by using the economic MPC, but the method is complicated and needs advanced numerical methods to solve an optimization problem. On the other hand, the proposed energy-efficient scenario can be easily applied, but the operating cost is not minimized by this method. So, there is a visible trade-off between the performance and the design complexity.

VI. CONCLUSIONS

In general, the economic cost function in refrigeration systems including the cooling capacity of each cold reservoir as well as the suction pressure as manipulated variables is a

nonconvex function which makes the optimization problem more troublesome. To avoid this nonconvexity, we have proposed a supervisory control structure with a simple algorithm for set-point control of the suction pressure that facilitates a reformulation of the problem to a more numerically efficient convex programming. Incorporating the PI controller dynamic into the predictive model enables the MPC to apply the temperature set-point as the manipulated variable. The results showed the superiority of the proposed economic MPC with 36% reduction of the operating cost over an energy-efficient scenario offering 28% reduction.

REFERENCES

- [1] J. Maciejowski, *Predictive Control: With Constraints*, ser. Pearson Education. Prentice Hall, 2002.
- [2] N. Ricker, "Predictive hybrid control of the supermarket process," *Control Engineering Practice*, vol. 18, pp. 608–617, 2010.
- [3] D. Sarabia, F. Capraro, L. Larsen, and C. Prada, "Hybrid nmmpc of supermarket display cases," *Control Engineering Practice*, vol. 17, pp. 428–441, 2009.
- [4] C. Sonntag, A. Devanathan, S. Engell, and O. Stursberg, "Hybrid nonlinear model-predictive control of a supermarket refrigeration system," in *Proceedings of the 16th IEEE International Conference on Control Applications*, Singapore, Oct. 2007, pp. 1432–1437.
- [5] H. Fallahsohi, C. Changenet, and S. Placé, "Predictive functional control of an expansion valve for minimizing the superheat of an evaporator," *International journal of Refrigeration*, vol. 33, pp. 409–418, 2010.
- [6] M. Elliott and B. Rasmussen, "Model-based predictive control of a multi-evaporator vapor compression cooling cycle," in *proceeding of the 2008 American Control Conference*, Seattle, Washington, USA, Jun. 2008.
- [7] D. Leducq, J. Guilpart, and G. Trystram, "Non-linear predictive control of a vapor compression cycle," *International journal of Refrigeration*, vol. 29, pp. 761–772, 2006.
- [8] A. Mohsenian-Rad and A. Leon-Garcia, "Optimal residential load control with price prediction in real-time electricity pricing environments," *IEEE Transactions on Smart Grid*, vol. 1, no. 2, pp. 120–133, 2010.
- [9] J. Rawlings and R. Amrit, *Optimizing Process Economic Performance using Model Predictive Control*, ser. Nonlinear Model Predictive Control: Towards New Challenging Applications, ISBN: 978-1-4614-1832-0. Springer, 2009, pp. 119–138.
- [10] T. Hovgaard, L. Larsen, K. Edlund, and J. Jørgensen, "Model predictive control, technologies for efficient and flexible power consumption in refrigeration systems," *Energy*, vol. 44, pp. 105–116, 2012.
- [11] Y. T. Ge and S. A. Tassou, "Thermodynamic analysis of transcritical CO₂ booster refrigeration systems in supermarket," *Energy Conversion and Management*, vol. 52, pp. 1868–1875, 2011.
- [12] L. N. Petersen, H. Madsen, and C. Heerup, "Eso2 optimization of supermarket refrigeration systems," Technical University of Denmark, Department of Informatics and Mathematical Modeling, Tech. Rep., 2012.
- [13] C. Pérez-Segarra, J. Rigola, M. Sòria, and A. Oliva, "Detailed thermodynamic characterization of hermetic reciprocating compressors," *International Journal of Refrigeration*, vol. 28, pp. 579–593, 2005.
- [14] R. Zhou and *et al.*, "The steady-state modeling and optimization of a refrigeration system for high heat flux removal," *Applied Thermal Engineering*, vol. 30, pp. 2347–2356, 2010.
- [15] S. E. Shafiei, H. Rasmussen, and J. Stoustrup, "Modeling supermarket refrigeration systems for supervisory control in smart grid," in *American Control Conference*, Washington DC, USA, Jun. 2013.
- [16] L. Balbis, R. Katebi, and A. Ordys, "Modeling predictive control design for industrial applications," in *International Control Conference (ICC2006)*, Glasgow, Scotland, Aug. 2006.
- [17] "Nord pool spot," <http://www.nordpoolspot.com>.
- [18] I. CVX Research, "CVX: Matlab software for disciplined convex programming, version 2.0 beta," <http://cvxr.com/cvx>, Sep. 2012.
- [19] M. Grant and S. Boyd, "Graph implementations for nonsmooth convex programs," in *Recent Advances in Learning and Control*, ser. Lecture Notes in Control and Information Sciences, V. Blondel, S. Boyd, and H. Kimura, Eds. Springer-Verlag Limited, 2008, pp. 95–110, http://stanford.edu/~boyd/graph_dcp.html.